



PHASE**ONE**

NOTICE:

After taking pictures using the Exposure Compensation feature, be sure to return the exposure compensation dial to the 0 position.

The exposure compensation feature is available during AE locked operation.

The width of the exposure compensation step can be changed.

The maximum amount of the compensation can be set either at ± 3 or ± 5 .

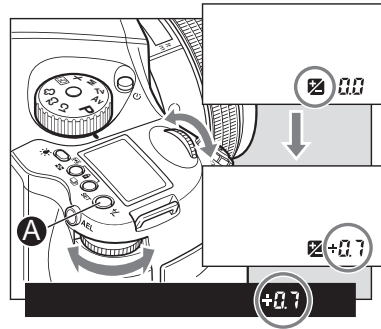

9.0 Advanced 645DF+ Camera Functions

9.1 Exposure Compensation

In situations providing extreme high contrast, the resulting photograph may be under or overexposed. When this occurs, use the Exposure Compensation function. Exposure Compensation can also be used when you want to intentionally create overexposed or underexposed pictures.

N.B. Creating an under or overexposed image can also be effectively achieved with the High Dynamic Range Tool and Exposure Tool in Capture One.

The exposure compensation dial icon: 

1. Press the Exposure Compensation button [A] so that icon appears on the camera's top LCD. When the front or rear dial is turned counter-clockwise, the exposure is increased and when it is turned clockwise, it is decreased. The exposure compensation value can be checked on the external LCD or LCD inside the viewfinder.

2. After taking the pictures, press the Exposure Compensation button [A] again to return the exposure compensation value to 0. The exposure compensation value mark on the external LCD is cleared and the exposure compensation function is released.

Exposure mode	Exposure compensation display	
P	Program AE	The set value is displayed
Av	Aperture Value Priority	
Tv	Time Value Priority	
M	Manual Mode	The difference between the metered value and the set Exposure value is displayed
X	Sync Mode	Not displayed

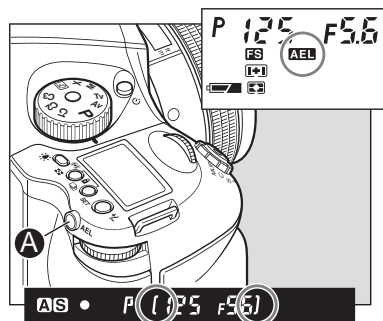

NOTICE:

[] in the viewfinder LCD blinks to indicate the exposure is locked, when you continue to take the next picture in the AE lock mode.

If you turn the shutter release mode selector lever to the L (power OFF) position, or after elapse of one hour, the AE lock mode will automatically be cancelled.

In the Manual M exposure mode, you cannot use the AE lock function.

When the difference between the metered value and the set value is displayed, press the AEL button [A] for approximately one second, and one-push shift function will be activated and the camera will automatically adjust the shutter speed.

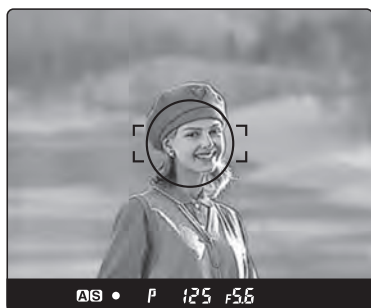

9.2 AE Lock

AE lock function is useful in a number of shooting scenarios but is particularly useful when capturing panoramic images where a consistent exposure is needed to seamlessly stick images together in post production.

The AEL button will lock the Auto-exposure value as the photo is being recomposed.

1. Turn the shutter release mode selector lever to S or C.
2. Turn the exposure mode setting dial and select P, Av or Tv.
3. Focus on the subject for metering exposure, and press the AEL button on the rear of the grip. [] Will appear on the viewfinder LCD, indicating that the exposure value is locked.
4. Slide the camera to recompose the shot, and take the picture.

When you press and hold AEL button the over/under exposure value will be shown to the far right in the viewfinder LCD.

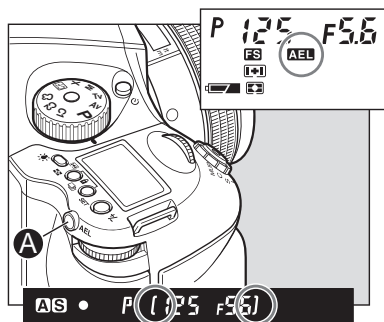

9.3 Metered-Value Difference Indicator

Keep pressing the AEL button [A] and the difference between the metered exposure value and the exposure of the new composition will be displayed on the viewfinder LCD. This function can be used to see if an object of very different brightness levels can be properly photographed.

If the difference between the set value and the metered value exceeds 6EV, the viewfinder LCD blinks “- u -” for underexposure and “- o -” for overexposure.

By turning the front or rear dial in the AE lock mode, you can change the aperture and shutter speed value without changing the exposure value that is set when entered into AE lock mode.

In the P mode (Program AE) mode, turning either the front or rear dial shifts the program to PH and PL. When in Av (Aperture priority AE) or Tv Shutter priority AE), turning one of the dials changes both the aperture and shutter speed values.

NOTICE:

The way to cancel the AE lock can be changed. [C-11 AEL function lock/unlock mode \[AEL\]](#)

Half-pressing of the shutter release button can activate the AE lock mode. [C-10 Release button \[HALF\]](#)

The assignment of the AEL button and AFL button can be swapped by using [C-09 AEL & AFL button \[AEFL\]](#)

Exposure compensation and auto-bracketing function can be used when the camera is in the AE lock mode in normal operation or with the mirror locked up.

NOTICE:

When you want to cancel the auto-bracketing mode, turn the rear dial to change "On" to "OF"

NOTICE:

After multiple turns, the mark [RP] will appear in the main LCD.

Repeat turning will lead to a countdown being displayed on the main LCD and after taking a photo the camera will return to Auto Bracketing mode.

The setting for the Auto Bracketing will be stored by pressing any other button or leaving the camera for 5 seconds.

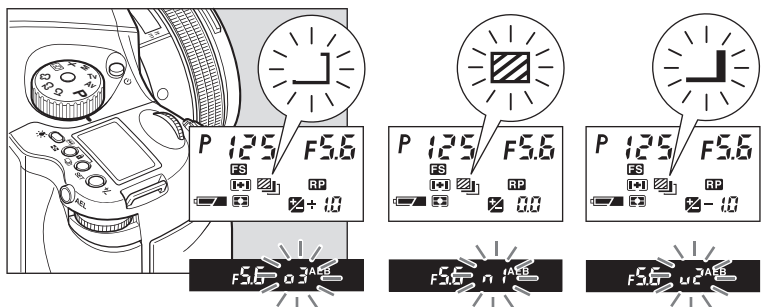
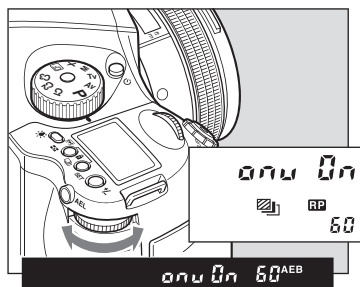
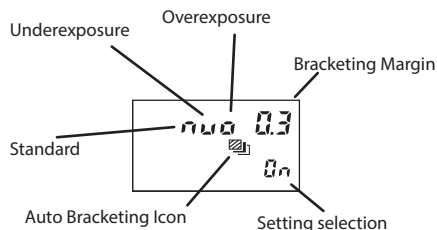
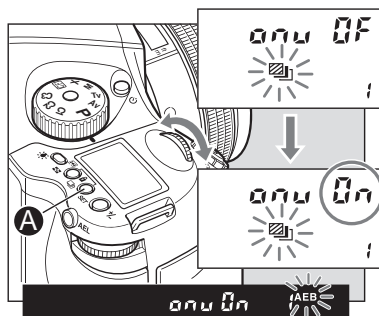

9.4 Auto Bracketing

Auto Bracketing can be used when it is difficult to determine your exposure compensation value. This function automatically captures different exposure variations in succession. The bracketing margin can be selected as desired for shooting in Auto Bracketing mode.

1. Turn the Shutter Release Mode Lever to the S or C position. When set at the S position, you can shoot a single frame with each full press of the Shutter Release button. In the C mode, the camera takes a series of three frames successively with one press of the shutter release button.
2. Turn on Auto Bracketing by pressing the Auto Bracketing button[A] for approximately one second. The Auto Bracketing icon will blink on the top LCD panel. Turn the front dial (before this indicator times out) and change OF on the display to On.
3. When the shutter button is pressed in Auto Bracketing mode, the auto bracketing mark will blink on the LCD inside the viewfinder. The bracket step width is displayed and the Auto Bracketing icon will also blink.
4. To deactivate the bracketing function, press the Auto Bracketing set button[A], turn the rear dial, set auto bracketing mode to OF, and release. Then press the Auto Bracketing set button [A] or half-press the shutter button to return to the normal display mode.

AE Settings Under Auto-bracketing Mode

	Exposure Mode	Setting
P	Program AE	Shutter speed varies
Av	Aperture Priority AE	Shutter speed varies
Tv	Shutter Priority AE	Aperture varies
M	Manual Mode	Shutter speed varies
X	X-sync mode	No setting

Single-Frame Mode (S)

Press the shutter release button for each shot. The camera meters adequate exposure value for each shot and performs Auto Bracketing. The camera stays in the Auto Bracketing mode until you cancel the Auto Bracketing mode manually.

Continuous Mode (C)

By pressing the shutter release button once, the camera takes 3 shots in series. With each full press of the shutter release button, the camera repeats auto-bracketing. The standard (normal) exposure value will be fixed when you take the first frame.

Cancelling Auto Bracketing

When you want to cancel the auto-bracketing mode, turn the rear dial to change "On" to "OF".

NOTICE:

When exposure compensation is initiated by pressing the exposure compensation button, shooting in Auto Bracketing mode is possible using the exposure value to which the exposure compensation value has been added.

NOTICE:

Auto bracketing exposures can be made when the auto bracketing mode is set before taking photos with mirror up.

After 10 seconds, mirror up photography will be cancelled

The mirror will return to the original position if the lens is removed from the camera body

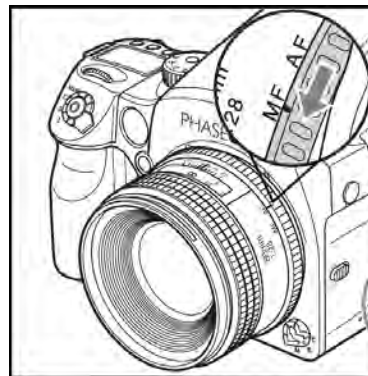
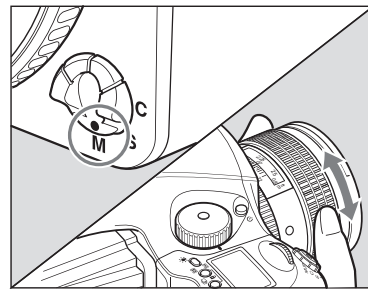
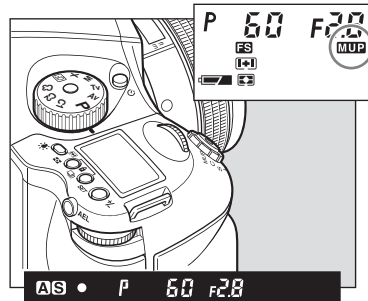
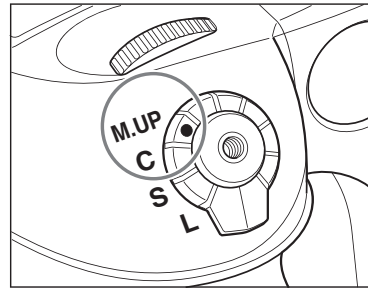

WARNING:

DO NOT point the lens at the sun during the Mirror Up mode. The sun's intense light can scorch and damage the shutter curtain.

9.5 Taking Photos with the Mirror Up

This function prevents mirror-caused vibrations which may blur an image when shutter speed is slow. A electromagnetic Cable Release RE401 (optional) is recommended to use with the mirror-up function.

1. Set the drive dial to M.UP.
2. Select S (single focus mode) by turning the focus mode selector lever.
3. Turn the exposure dial to P, Av or Tv exposure mode.
4. Ensure the subject is in focus and that composition and exposure have been determined.
5. The mirror moves up when the shutter release button is fully pressed.
6. Press the shutter release button again to take pictures.

In the Manual Mode

Follow steps 1 through 3 of the above auto focusing steps and continue with the steps below.

- 1-3 (reference steps 1-3 in the Mirror Up Autofocus method)
4. Set the focus mode selector lever to M (manual focus mode). Turn the lens-focusing ring to focus.
5. Determine the exposure, focusing and frame structure by pressing the shutter release button halfway while looking into the viewfinder.
6. Lock the mirror up by pressing the shutter release button.
7. Press the shutter release button again to take pictures.

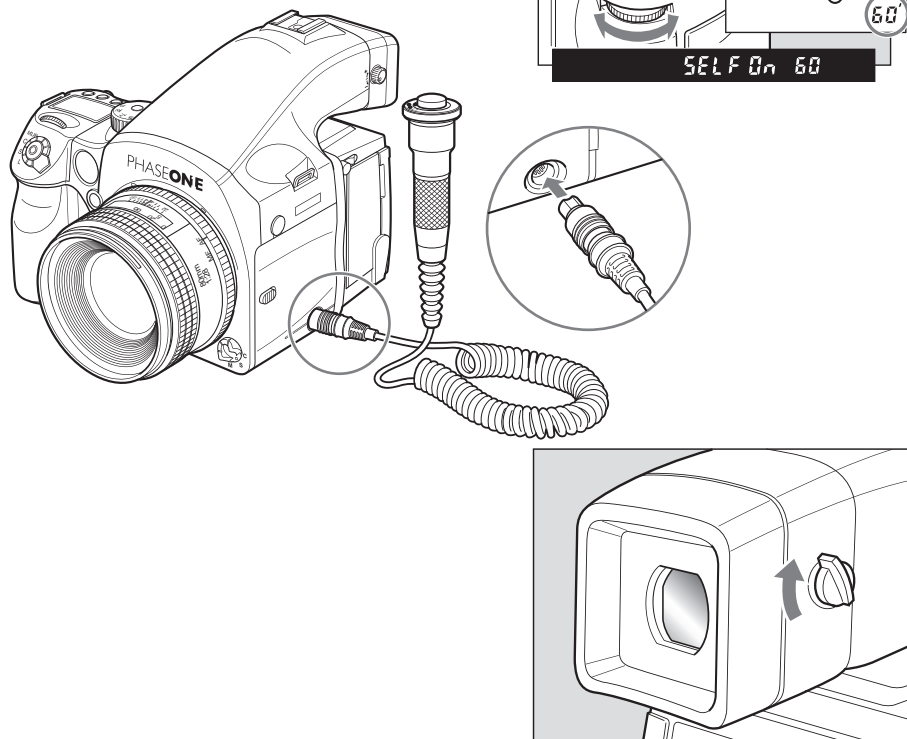

9.6 Mirror Up Delay

To change from the Self-timer to the Mirror Up setting, press the shutter button so the mirror goes into the upright position. Once the set time has expired the shutter will release, and the mirror will return to the lower position. Separately purchased electronic cable release RE401 can be used to eliminate camera shake.

When using autofocus the operational method is the same as 1 to 3 when using M.UP and autofocus.

1-3 (reference steps 1-3 in the Mirror Up Autofocus method).

4. Press the Self-timer button and turn the front dial to ON.

5. Turn the rear dial to select the time needed. 0.5/1 seconds to 10 seconds allows for increases by the second, 10 to 90 seconds increases by 10 seconds per turn. For 2 to 10 minutes the value by the minute and 10 to 60 minutes increases by 10 minutes per turn.

6. Line up the photograph through the viewfinder and half press the shutter button to ensure the focus and framing is correct.

7. Full-press the shutter button and the mirror will go to the upper position, then after the set time the shutter will release and the mirror will return to the lower position.

Electronic Shutter Release Contact

For Mirror Up, long exposure, or slow shutter shooting, use the magnetic cable release RE401 or the remote control RS402. The assisting release contact is to insert the cable.

Eyepiece Shutter

Close the eyepiece shutter when there is a strong light source behind the camera.

NOTICE:

As the camera is electronically controlled even during exposures, it is recommended to replace batteries before bulb exposure.

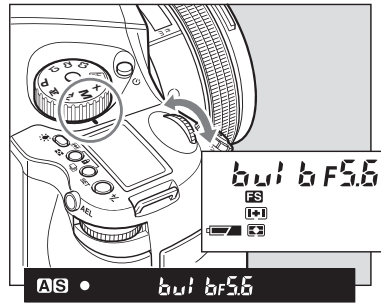

NOTICE:

Using "tIME" (Time) setting, the shutter will open and close according to the number of times you press it.

"tIME" (Time) photography is electronically controlled so it is possible that the batteries will drain quickly. In the case, please replace the batteries with new ones.

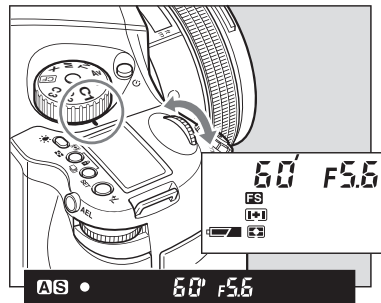

NOTICE:

When releasing the shutter, or pressing the backlight button [A] while the backlight is on, the backlight will go OFF.

Choose the time of display light. [C-03 Sleptimer \[HOLD\]](#)

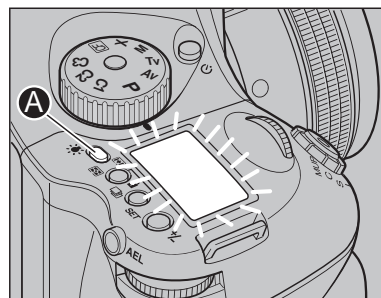

9.7 Bulb Mode & Long Exposure

To make an exposure longer than 30 seconds, adjust the shutter speed to "B" (bulb). In order to prevent camera shake, use the RE401 or RS402 electromagnetic shutter release and tripod.

1. Turn the exposure mode dial to M (manual mode).
2. Turn the front dial to select 'bulb', then turn the rear dial to set the aperture.
3. Determine the composition, focus and then take the picture. The shutter remains open as long as the shutter release button is pressed.

Setting Long Exposures

When photographing under normal conditions, the shutter speed can be adjusted for longer exposures.

Turn the front dial for shooting time settings. New time settings include 1, bulb, time(Time), 2, 4, 8, 15, 30, 60.

9.8 Camera Display Light

Press the backlight button [A]  to illuminate the top display to see it at night or in dark places.

The backlight will go on for approximately 20 seconds and turn off unless it is pressed again.

The backlight will be lit for approximately another 10 seconds when operating the camera.

NOTICE:

The setting will be stored after one second.

Dial lock can not be set when the exposure mode is P (program AE).

Even while dial lock is set, the front dial or rear dial can still be used to perform the various settings. (Dial lock is temporarily released.)

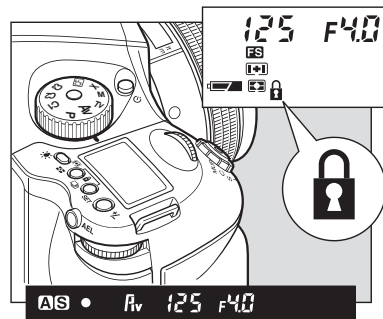
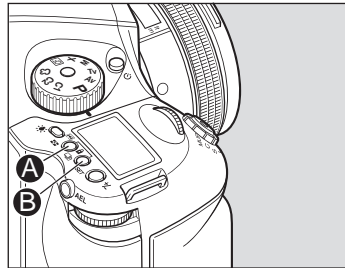
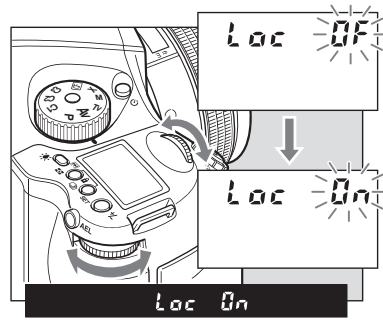

9.9 Front/Rear Dial Lock Mechanisms

When the Electronic Dial Lock is On, all currently set values in Av (Aperture Priority AE), Tv (Shutter Priority AE) and M (Manual mode) cannot be adjusted with the front or rear dials. This prevents accidental change of shutter speed or aperture values.

Press down the two lock buttons [A] and [B] at the same time for approximately one second, until the On indicator blinks.

To release the mode, hold down the same buttons until OF blinks.

 is displayed on the main LCD to indicate that operation of the front and rear dials is locked.

When the dial lock is ON, the shutter speed and aperture will not change even if you turn the front or rear dial.

When you activate the electronic dial lock, and then operate the electronic dial, the dial lock indicator on the main panel blinks for three seconds to show that the electronic dial lock is functioning.

Notice:
To release the self timer while it is operating, turn off the power (by setting the drive dial to L)

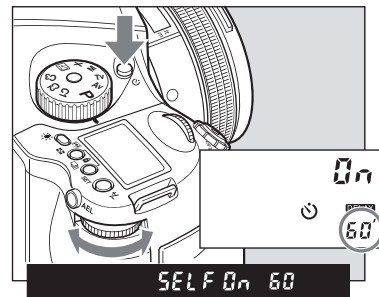
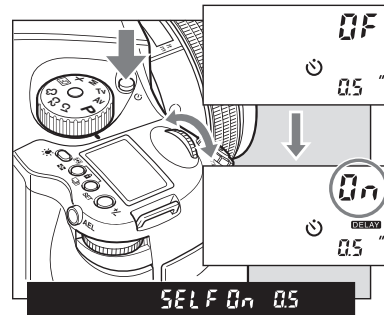

Notice:
In the Self-timer setting, put the drive dial to M.UP (mirror up) mode. Should you wish to operate with mirror up and delay, simply switch the drive dial to M.UP(mirror up) mode in the Self-timer setting.

9.10 Self-Timer Mode

The default setting for the Self-Timer mode to release the shutter is 10 seconds after the shutter release button is pressed. The self timer lamp flashes slowly for the first 7 seconds, and then flashes quickly for the last 3 seconds before the shutter is released. This function can be used to avoid camera shake, to take group photos or for self-portraiture.

1. Mount the camera on a tripod.
2. Switch the shutter release mode selector to the  (self timer mode).
3. Turn the front dial, and set the self-timer mode to ON.
4. Check the view by looking through the viewfinder. Make sure that the focus is correct, press the shutter release button and the shutter will be released after 10 seconds.

Changing the Self-Timer Duration

1. Press the Self-Timer button to activate this function.
2. Turn the rear dial to change the duration of the Self-Timer. 0.5/1 seconds to 10 seconds allows for increases by the second, while 10 to 90 seconds increases by 10 seconds per turn. For 2 to 60 minutes increases by 10 minutes per turn.

Releasing Self-Timer mode

1. Press the Self-Timer button to activate this function.
2. Turn the front dial to "OF"

Notice:

Repeat turning (according to the number of times) will lead to a countdown appearing in the display.

After setting the interval photography, turn the drive dial to "M.UP" (mirror up mode) and you can operate in mirror up delay mode. While photographing in this setting the "AEL" will be displayed on the main LCD.

When using auto bracketing, the interval function cannot be used at the same time.

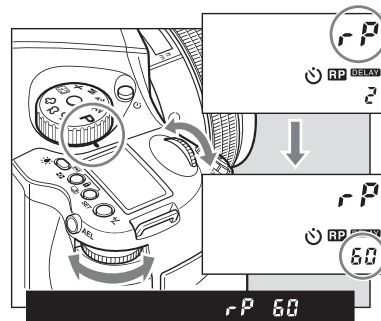
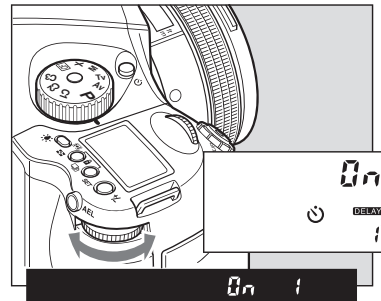
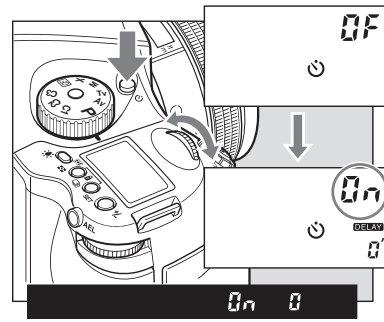

9.11 Interval Photography

Interval photography can be used for a variety of shooting scenarios such as to capture cloud movement or a flower coming into bloom.

1. Ensure the camera is firmly secured on a tripod.
2. Press and Self-Timer button twice.
3. Turn the front dial to display interval mode as On.
4. Turn the rear dial to set the interval time. Settings include 0 seconds (no interval time), 1 to 10 seconds (increased by the second), 10 to 90 seconds (increased in units of 10 seconds), 2 to 10 minutes (increased by the minute) or 10 to 60 minutes (increased in units of 10 minutes per turn).
5. Turn the front dial to the repeat mode to select how many shots you want in your interval session, 1-10, or up to 60 in intervals of 10. If you want to make a motion film of your session and need more images, try shooting tethered to a computer and set the interval to ON. The camera will do a shot until you stop the session. Remember to leave enough free hard disk space on your computer.
7. Check the focus and framing in the viewfinder then press the shutter.

Cancelling Interval Mode

1. Press the interval mode button for interval mode.
2. Turn the front dial to "OF"

9.12 Depth of Field

Depth of field (D.O.F.) is defined as the zone of sharpness before and behind the plane of focus. It depends on distance to subject, focal length of lens, aperture setting and distance the lens is focused at.

In addition to visual observation via the depth of field preview button, the D.O.F. can be determined by using the depth of field scale on each lens. The $f/$ stop numbers appear on both the right and left side of the white index mark in the center of the scale. Simply read the figures which appear above the $f/$ stop numbers on the distance scale of the lens.

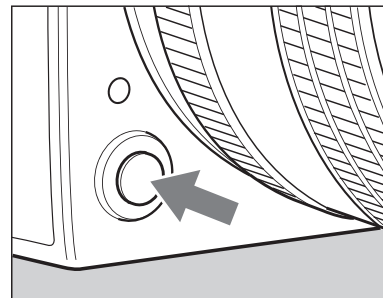
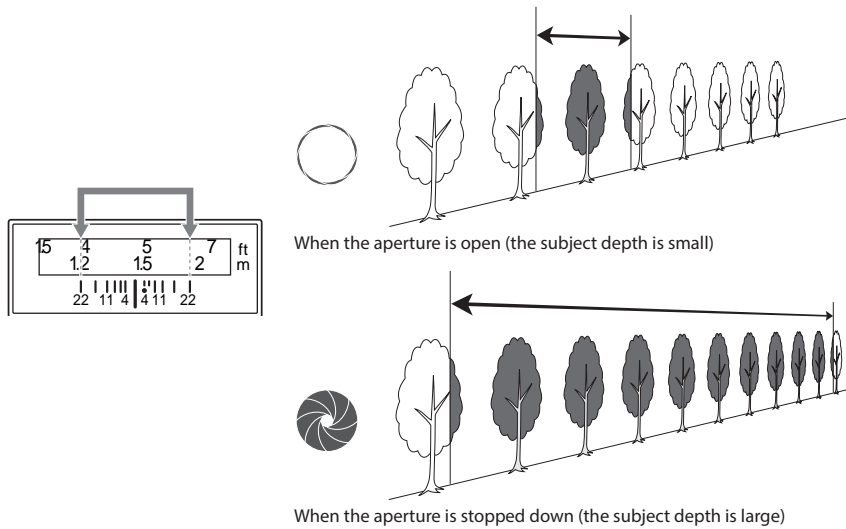

NOTICE:
While operating the preview button, you cannot release the shutter

Depth of Field Preview Button

When the preview button is pressed in, the depth of field for the aperture set on the camera can be checked by looking through the viewfinder.

After focusing, press the preview button. The diaphragm will be stopped down to the set aperture.

Web Resources

<http://www.cambridgeincolour.com/tutorials/depth-of-field.htm>
http://en.wikipedia.org/wiki/Depth_of_field

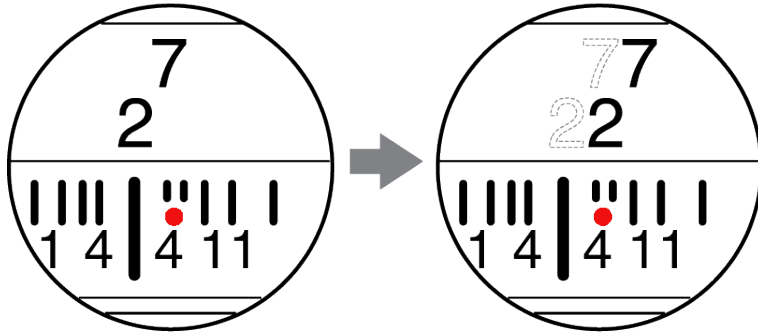
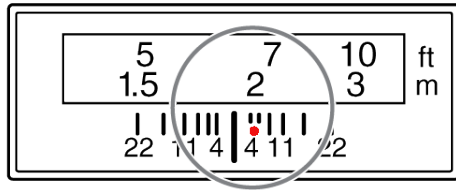

9.13 Infrared Photography

Infrared Photography is complicated when using digital backs, as the digital back is adjusted to match the viewable light perfectly.

Use a dedicated digital back for infrared photography. The IQ back needs to be adjusted to work properly for infrared photography. **DO NOT TRY THIS AT HOME!**

– All corrections in this area must be done by Phase One to ensure precision. If you remove the protective glass or make other physical adjustments on the back the warranty will immediately be void.

If you are considering Infrared Photography, please contact your local Phase One dealer for technical advice and pricing.

Infrared light has a slightly different area of sharpness compared to the viewable light so when the distance is set on the lens, you should always manually correct sharpness, to be in front of the red dot.

Do not use your camera's light meter when photographing infrared, as the light meter is aimed towards reading the visible light.

NOTICE:

You cannot take photos in AE modes when using an infrared film as the AE is based on visible light.

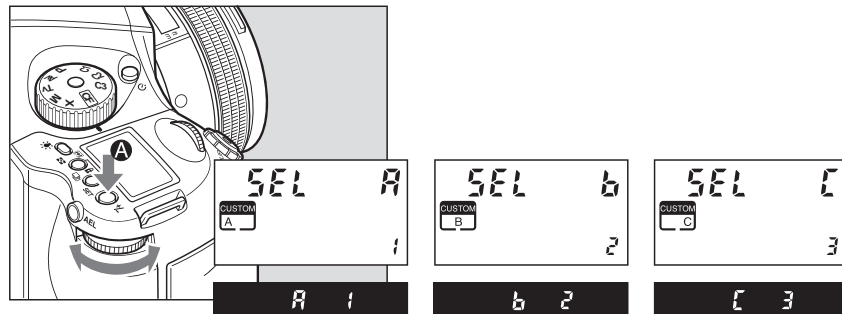
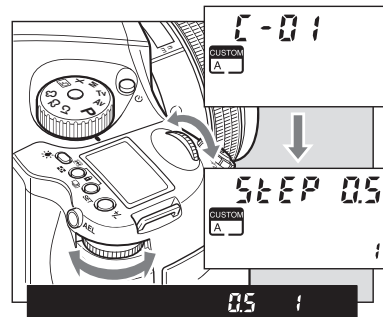
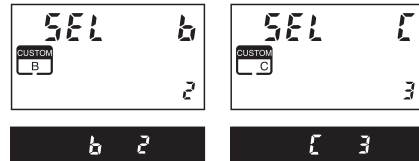
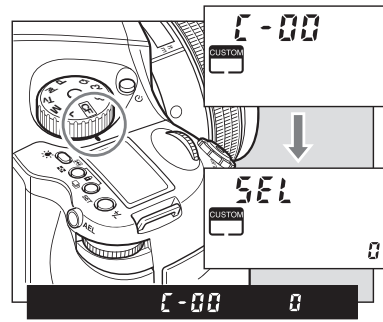
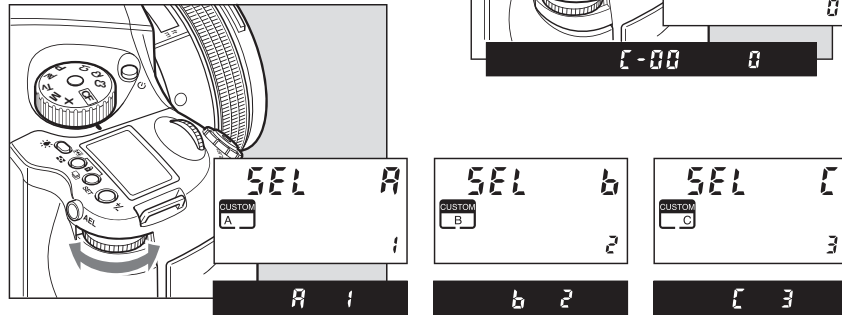

9.14 Custom Function

The custom functions can store separate three different camera set-ups. When at C-00, chose 1 (A), 2 (B), or 3 (C) to store a specific set of user function selections for the group of custom settings from C-01 to C-19.

The C-00 is set to 0 which is the settings used for the default set.

Setting Custom Functions

1. Turn on the power.
Turn the shutter release mode lever to the S or C position.
2. Turn the exposure mode dial to select CF (Custom Function mode).
3. Turn the rear dial to select the settings for user A, B, or C.
4. Turn the front dial to select the item you want to set.

Clear all Custom Functions

Set mode dial button to CF, then press +/- button for 5 seconds, this will reset ALL Custom Functions to the factory default.

Setting Custom Functions to Default

1. By turning the exposure mode dial, CF (custom function mode) can be selected.
2. By turning the rear dial, user A, B or C can be selected.
3. Press and hold down set button (for longer than 1 second) and settings for A,B,C can be initialized, or the settings can be returned to "default".

9.15 Types of Custom Functions

C-00 Custom functions profile [SEL]

0: None (default=0)

1: A

2: B

3: C

When "0" has been selected and set, none of the custom items can be set.

C-01 EV-Steps [StEP]

This function is used to set the size of increments concerning the shutter speed, f-number and exposure compensation value.

0: 0.3 (1/3EV step: default setting)

1: 0.5 (1/2EV step)

2: 1.0 (1EV step)

C-02 Lens change [IrIS]

This function is used to set the f-number display method for the previously used lens when the lenses have been interchanged. The default setting is "0" in which case the f-number of the lens prior to the changeover is displayed.

0: Previous f-number

1: Maximum aperture setting

2: Minimum aperture setting

C-03 Sleptimer [HOLd]

This function is used to set the time for sleep mode to be established after the camera's power is turned on. The default setting is 15 seconds.

0: 15 seconds

1: 30 seconds

2: 60 seconds

3: Disabled

The batteries will continuously lose power when "On" (no sleep mode) has been set.

C-04 Battery Type [batt]

This function is used to set the batteries used in the camera so that the remaining battery charge will be displayed correctly on the external LCD panel.

0: Alkaline

1: NiCd, NiMH, Li-ion

2: Li-ION (Only for use with Li-Ion battery Kit or Vertical Grip)

C-05 Bracketing [Stno]

Setting bracket's width for auto bracketing setting

0: 3 Exposures

1: 5 Exposures

2: 7 Exposures

C-06 Front/Rear dial [dF]

This function is used to interchange the functions of the front and rear dials in the M (manual mode).

0: Front dial: TV, rear dial: Av [OF]

1: Front dial: AV rear dial: Tv [On]

C-07 Rear dial in P mode [d_AC]

Initializing the P mode on the rear dial then changing the function to the front dial will cancel out P mode function on the rear dial.

0: Enable

1: Disable

C-08 Dial Direction [d_dI]

This function is used to determine the direction in which the electronic dial is to be rotated to increase and decrease shutter speed, the f-number, and exposure compensation.

0: CW: Decrease [OF]

1: CW: Increase [On]

C-09 AEL & AFL button [AEFL]

This function is used to set whether to interchange the operations of the front and rear AEL and AFL buttons.

0: Default setting (front: AFL, rear: AEL) [OF]

1: Switched (front AEL, rear: AFL) [On]

C-10 Release button [HALF]

This function is used to set the AE lock and AF operations when the shutter release button is half-pressed.

0: AF operation (default setting)

1: AF & AE operation

2: Only shutter release

C-11 AEL function lock/unlock mode [AEL]

This function is used to set the method of operating the AEL button to lock AE. At the default setting, when the AEL button is pressed, AE is locked; pressing the button again releases the AE lock. At the "1" setting (released after one shot), after AE lock is set, it is released when the shutter is triggered. At the "2" setting, AE lock is only kept while the AE lock button is being pressed.

- 0: One shot
- 1: Continuous
- 2: While pressed

C-12 AFL [AFL]

This function is used to set the AF lock method when the AFL button is operated. AF >> Lock is activated with one press of the auto-lock button then deactivated with a second press.

- 0: While pressed (default setting)
- 1: AF operation
- 2: Continuous

C-13 M-mode AEL [OnEP]

When using M (manual mode) one push function, the shutter speed or aperture value can be set automatically by pressing AEL button.

- 0: Shutter speed shift [tv]
- 1: Aperture value shift [Av]
- 2: No [no]

C-14 AF assist setting [AF_L]

The AF auxiliary light fires automatically when the subject is too dark to perform AF, but this function can be used to prevent the AF auxiliary light from firing.

- 0: On [On]
- 1: Off [OF]

C-15 Flash sync. [FLSY]

When shooting moving subjects with flash you can set the synchronization timing. This allows you to have the flash fire at the beginning of the exposure or at the end of the exposure.

- 0: First (default setting)
- 1: Second

C-16 Beep [bu]

When the SET button is pressed a beep sounds

- 0: ON (AF) (Default setting)
- 1: ON
- 2: OFF

C-17 Shutter TV, AV & P [Sh_P]

When using P, Av or Tv mode and the leaf shutter lens is attached but you prefer to use the focal plane shutter.

- 0: Mixed. Default (Focal Plane shutter operation at < 1S)
- 1: Leaf shutter
- 2: Focal plane shutter

C-18 Shutter in M & X [Sh]

When initializing the setting, use of the lens shutter (and its respective ranges) or the focal plane shutter can be chosen when the leaf shutter lens is attached.

- 0: Mixed. Default (Focal Plane shutter operation at < 1S)
- 1: Leaf shutter
- 2: Focal plane shutter

C-19 AF Priority [AF_2]

Accuracy of auto-focusing priority (default setting) or speed priority can be decided. Use the front dial to scroll to Custom function 19 and the rear dial to set AF Priority to one of the following:

- 00: Speed
- 01: Accuracy

Please note: On IQ, P 65+ or P 40+ digital backs, this CF function can also be set from within the digital back menu system: Menu > 645DF > Setup Custom A > AF priority

C-20 AF Fine Tune

Use the front dial to scroll to Custom function 20. Use the rear dial to fine-tune the focus point on a subject that is closer or further away from the camera.

- 50: Neutral factory calibration
- Minus: Move AF point closer
- Plus: Move AF point further away

C-97 Support for Mamiya ZD backs

This function should ONLY be activated when shooting on a Mamiya ZD back.

0: Default setting NO Mamiya ZD back on the camera body

1: Mamiya ZD back on camera body

C-98 Lens firmware version

The current firmware version can be checked.

C-99 Body firmware version

The current firmware version of the body can be checked.

Liquid Crystal Display

Due to the limitations of the space and letters, words and letters on the LCD are abbreviated.

Display examples of the main LCD

<i>On</i>	→	ON
<i>Off</i>	→	OFF
<i>Err</i>	→	Error
<i>+</i>	→	+ (Plus)
<i>u</i>	→	Under
<i>o</i>	→	Over
<i>n</i>	→	Normal
<i>Loc</i>	→	Lock
<i>SELF</i>	→	Self Timer
<i>bulb</i>	→	bulb
<i>busy</i>	→	Busy
<i>db</i>	→	Digital Back
<i>LS</i>	→	Lens Shutter
<i>CAP</i>	→	Capture
<i>RP</i>	→	Repeat
<i>TIME</i>	→	Time
<i>batt</i>	→	battery

Display examples in the custom function mode

<i>SEL</i>	→	Selection
<i>STEP</i>	→	Step
<i>IRIS</i>	→	Iris
<i>HOLD</i>	→	Hold
<i>batt</i>	→	battery
<i>Shot No.</i>	→	Shot No.
<i>dF</i>	→	Dial function
<i>d.AC</i>	→	Dial action
<i>d.d!</i>	→	Dial direction
<i>REFL</i>	→	AE, AF lock
<i>HALF</i>	→	Half press
<i>REL</i>	→	AE lock
<i>RFL</i>	→	AF lock
<i>OnEP</i>	→	One-push exposure
<i>RF.L</i>	→	AF assist light
<i>FLSY</i>	→	Flash sync
<i>bu</i>	→	Buzzer
<i>Sh.P</i>	→	Shutter in Program
<i>Sh</i>	→	Shutter in Manual
<i>RF.2</i>	→	AF second mode

Custom Functions overview

No.	Item	Initial setting (0)	1	2	3
C-00	Custom Function User	Last used	User A	User B	User C
C-01	Steps of aperture, shutter speed, Exposure compensation	0.3 1/3 EV step	0.5 1/2EV step	1.0 1 EV step	
C-02	Aperture setting after lens change	Previous aperture value	Maximum aperture setting	Minimum aperture setting	
C-03	Time to sleep	15 sec	30 sec.	60 sec.	ON
C-04	Battery type	Alkaline	NiMH or NiCD	Future feature	
C-05	Auto Bracketing steps	3	5	7	
C-06	Front/Rear dial function exchange in manual mode	Front: TV Rear : AV	Front:Av Rear :Tv		
C-07	Disable Rear dial in P mode	Yes	No		
C-08	Dial Function direction	No switching	Switched CCW : Increase CW : Decrease		
C-09	AEL & AFL button exchange	Front: AFL Rear : AEL	Front: AEL Rear : AFL		
C-10	Shutter half-press function	AF operation	AF operation & AE Lock	OFF (no function)	
C-11	AEL function lock/unlock mode	Continuous	One shot	While the shutter button is pressed	
C-12	AFL lock mode setting	Set with AF lock only	AF operation	Continuous	
C-13	One push function M-Mode	Shutter speed shift	Aperture value shift	Off	
C-14	AF assist beam	Fires	Does not fire		
C-15	Flash sync. timing	Front Curtain	Rear Curtain		
C-16	Beep	ON (AF)	ON	OFF	
C-17	Choose shutter function (P, Av or Tv mode)	Mixed. (When inside the range of the leaf shutter lens)	Only Leaf shutter	Only Focal plane shutter	
C-18	Shutter function in Manual mode	Mixed. (When inside the range of the leaf shutter lens)	Only Leaf shutter	Only Focal plane shutter	
C-19	AF Speed	High Speed mode	High accuracy mode		
C-97	Mamiya ZD digital back support	NO Mamiya ZD back	Mamiya ZD back		
C-98	Lens Firmware version				
C-99	Body Firmware version				

9.16 Custom Dial Modes C1, C2 or C3

Mode dial options C1, C2 and C3 can be used to store preferred settings.

These settings can be changed instantly to suit the photographer's needs. Users can change the settings on the camera body or via an IQ back.

Programmable settings are exposure mode, P (program AE), Av (aperture priority AE), Tv (shutter speed priority AE), X (synchro mode), M (manual mode), focus area and spot metering.

Programming the Custom Dial Modes C1, C2 or C3 via the camera body

1. Go to the setting you wish to assign to C1, C2 or C3.
2. After arriving at the setting you wish to assign, hold the SET button down while turning the mode dial to C1, C2 or C3. When you release the SET button, the chosen setting will be programmed to your selection of C1, C2 or C3.

C1, C2 or C3 modes can be changed while photographing. However after taking a photo in a mode other than the modes selected in C1, C2 or C3, when you turn the dial back to a C mode setting the change will not be saved.

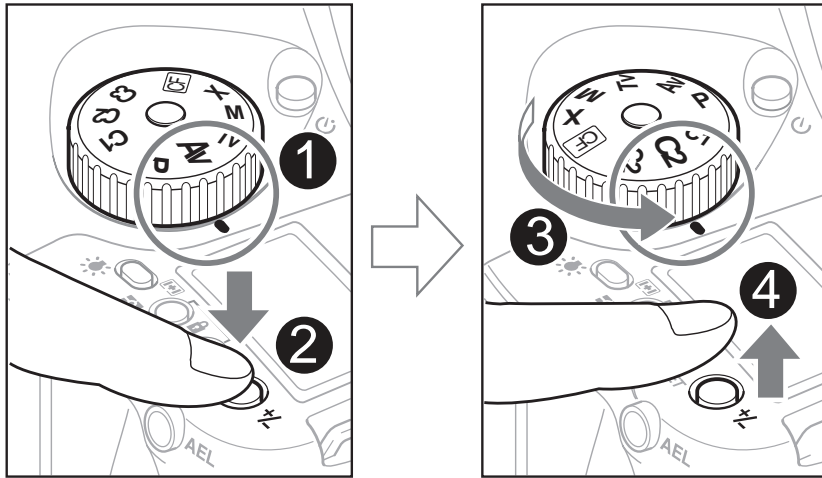

* The illustration shows the exposure mode Av (aperture priority AE) being recorded to C2.

NOTICE:

Even when the power is switched off, the mode recorded will still be saved to C mode.



9.17 Lenses and Multi Mount

When it comes to lenses, Phase One provides the widest range of possibilities to ensure photographers get the most creative freedom from their Phase One camera.

This chapter looks at some possible lens systems. However, it is worth noting that there are even more applicable lenses available than presented in the upcoming pages. User can find more information from dedicated Phase One dealers on items such as mount-adaptors for example the Phase One Multi-Mount.

N.B. Errors or damage caused by third party products are not covered by the warranty. Please test new products with caution.



9.18 Functions of the Phase One Lens

The Phase One 80mm f/2.8 is a sharp and well tested digital lens. The lens is mounted by aligning the white dot on the lens with the white dot on the camera body. Carefully mount the lens by turning it clockwise, until a click is heard. If you feel resistance or if you hear a scratching-like sound stop and retry – NEVER use force when mounting the lens as it should always slide into place without resistance.



9.19 Function of the Phase One Lens Adaptor

To mount the Phase One Multi-Mount, match the white dot on the camera up with the white dot on the Multi-Mount and turn slowly clockwise. NEVER use force to mount the ring. When the Phase One Multi-Mount is mounted you can fit Carl Zeiss/Hasselblad V and Hasselblad 200series lenses on the camera.



9.20 List of Alternative Lenses

Recommended Digital lenses

Producer	Specs	Limitations	Adaptor/Mount	notice
Mamiya	28 f.4,5 AFD		Mamiya 645AFD	Sekor
Mamiya	75-150 f.4,5		Mamiya 645AFD	Sekor
Mamiya	35 f.3,5		Mamiya 645AFD	
Mamiya	45 f.2,8		Mamiya 645AFD	
Mamiya	55 f.2,8		Mamiya 645AFD	
Mamiya	150 f.3,5		Mamiya 645AFD	
Mamiya	210 f.4,0		Mamiya 645AFD	ULD
Mamiya	300 f.4,5		Mamiya 645AFD	APO
Mamiya	55-110 f.4,5		Mamiya 645AFD	
Mamiya	105-210 f.4,5		Mamiya 645AFD	ULD
Schneider Kreuznach	55 f.2,8		Mamiya 645AFD	Leafshutter
Schneider Kreuznach	80 f.2,8		Mamiya 645AFD	Leafshutter
Schneider Kreuznach	110 f.2,8		Mamiya 645AFD	Leafshutter

Producer	Specs	Limitations	Adaptor/Mount	Notice
Recommended MF lenses				
Mamiya	A 500 f.4,5	1+2	Mamiya 645	MF
Mamiya	A 300 f.2,8	1+2	Mamiya 645	MF+APO
Mamiya	A 200 f.2,8	1+2	Mamiya 645	MF+APO
Mamiya	55	1+2	Mamiya 645	leafshutter
Mamiya	80 f.2,8 N/L	1+2	Mamiya 645	leafshutter
Mamiya	150 f.3,8 N/L	1+2	Mamiya 645	leafshutter
Mamiya	105-210 f.4,5	1+2	Mamiya 645	
Mamiya	500 f.5,6	1+2	Mamiya 645	
Mamiya	55-110 f.4,5 N	1+2	Mamiya 645	
Mamiya	150 f.2,8	1+2	Mamiya 645	
Mamiya	300	1+2	Mamiya 645	
Mamiya	24 f.4,0	1+2	Mamiya 645	
Mamiya	35	1+2	Mamiya 645	
Mamiya	150 f.3,5 N	1+2	Mamiya 645	
Mamiya	45	1+2	Mamiya 645	
Mamiya	210 N	1+2	Mamiya 645	
Mamiya	80 f.1,9	1+2	Mamiya 645	
Mamiya	55	1+2	Mamiya 645	
Mamiya	80 f. 2,8 N	1+2	Mamiya 645	

Hartblei	MCTS-PC 45 f. 3,5		mamiya/Pentacon six	super-rotator tilt/shift
Hartblei	MC Hartblei 2x converter		pentacon six	

Producer	Specs	Limitations	Adaptor/Mount	Notice
Arsat	MC Arsat 30 f.3,5 fisheye		Pentacon six	
Arsat	MC Arsat 45 f.3,5 Wide Angle		Pentacon six	
Arsat	MC PCS Arsat 45 f.3,5		Pentacon six	shift
Arsat	MC PCS Arsat 55 f.4,5		Pentacon six	shift
Arsat	MC PCS Arsat 65 f.3,5		Pentacon six	shift
Arsat	MC Arsat 80 f.2,8		Pentacon six	
Arsat	MC Arsat 600 f.8,0		Pentacon six	Mirror

Lenses usable in combination with Phase One Multi-Mount

Carl Zeiss	CFi 30 f.3,5	3	hasselblad V	
Carl Zeiss	CFE 40 f.4,0	3	hasselblad V	
Carl Zeiss	CFi 50 f.4,0	3	hasselblad V	
Carl Zeiss	CFi 60 f.3,5	3	hasselblad V	
Carl Zeiss	CFE 80 f.2,8	3	hasselblad V	
Carl Zeiss	CFi 100 f.3,5	3	hasselblad V	
Carl Zeiss	CFE 120 f. 4,0	3	hasselblad V	
Carl Zeiss	CFi 150 f.4,0	3	hasselblad V	
Carl Zeiss	CFE 180 f.4,0	3	hasselblad V	
Carl Zeiss	CFi 250 f.5,6	3	hasselblad V	
Carl Zeiss	CFE 350 f.5,6	3	hasselblad V	SA

Special purpose lenses

Mamiya	120 f.4,0 MACRO		Mamiya 645MF	
Mamiya	50 SHIFT	1	Mamiya 645MF	
Mamiya	645 Auto bellows unit	1	Mamiya 645	
Mamiya	80 MACRO	1	Mamiya 645	

Other lenses usable in combination with adapter

Hasselblad	30			fisheye
Hasselblad	40			
Hasselblad	50			

Pentacon	flektogon 50			
Arsat	55mm Shift			
Biometar	80mm			
Biometer	120mm			
Sonnar	180mm			

Limitation codes:

- 1: Stopped down metering not possible
- 2: Discontinued
- 3: Leaf shutter disables, only aperture priority

NOTICE

Since the Focusing Screen's surfaces are soft and easily damaged, handle them carefully.

Never touch the surface with bare fingers. Should dust settle on it, merely blow away by using a blower.

If the Focusing Screen needs cleaning, send it to the nearest authorized Phase One service center.

Do not attempt to clean the surface of the Focusing Screen, as it is very delicate.

Do not touch and damage the mirror in any way.

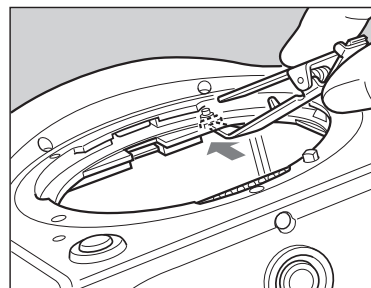
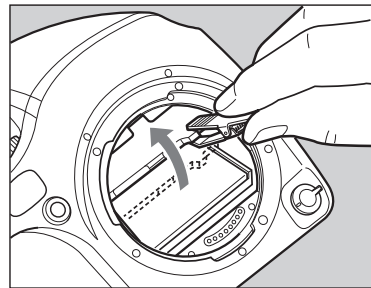
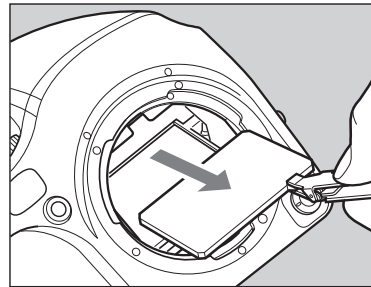
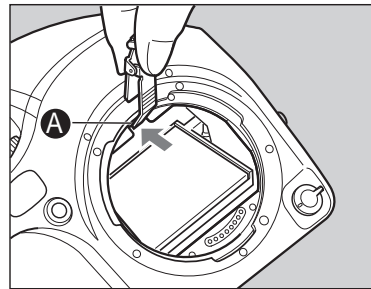

10.0 Maintenance

The Phase One 645DF+ generally needs very little maintenance. But this is a professional tool and should be treated with care and caution. Always do test shots before a photographic session if the camera for any reason has not been used for a long period of time.

A frequently used product should be inspected periodically at the nearest official Phase One repair center. Do NOT try to repair any camera, lens or back errors or malfunctions – Please consult your local dealer.

10.1 Changing the Focusing Screen

1. Remove the lens.

2. Pull the Focusing Screen Release lever A forward, as illustrated, with tweezers to ease the Focusing Screen down.

3. Remove the Focusing Screen from the Focusing Screen Frame by grasping the tab on the edge of the screen with tweezers as illustrated.

4. When installing the screen, pinch the tab of the screen with tweezers, and place the screen on the screen frame.

5. Push the screen frame up using the tweezers until hearing a clicking sound. The screen is now properly installed. Never press down on other parts as this will affect the focus function.

Notice:
Make sure to re-install the empty battery case into the body.

The empty battery cassette must be inserted into the body.

The batteries may generate heat if the external battery case is connected to the body while the batteries are loaded on the body.

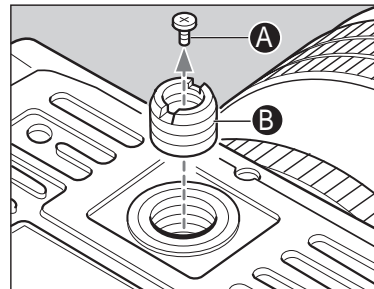
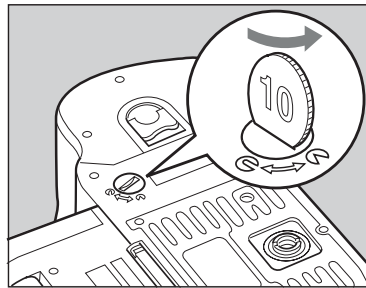
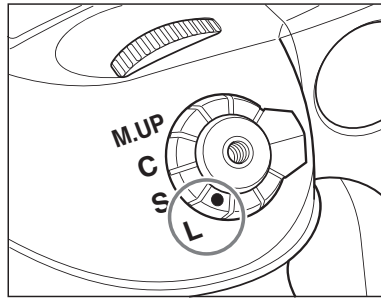

10.2 Battery Socket

Never leave batteries in the socket if the camera or back is not planned to be used for longer periods.

Keep contacts clean and dry at all times.

External Battery Socket

Use an external battery case PE401 when using the camera in cold temperatures where the battery capacity may drop.

1. Turn the shutter release mode selector lever to the L position (power off).
2. Use a coin or similar object to turn and remove the external battery socket cap.
3. Remove the battery case from the camera body
4. Connect the external battery case to the body. Connect the plug of the external battery case in which the batteries are installed, to the external battery socket.
5. Reinstall the original battery case, from which the batteries were removed, in the body. Turn the battery case lock to lock it in the body.

10.3 Tripod/Electronic Shutter Release Contact













Keep all contacts clean and dry at all time.

When using a tripod with 3/8" screw (instead of 1/4" screw) remove the small screw[A] from the tripod screw hole on the bottom of the body using a plus screwdriver, then use a coin to remove the tripod screw adapter bushing[B].

You will find Electronic Shutter Release both on the camera body and on the back. When used, it is recommended to use the shutter release on the back. Keep both contacts dry and clean.

10.4 Camera Display Error-Notification

When Any of These Displays Appear...

LCD display			Causes and remedies	
Main LCD panel	Viewfinder LCD read-outs	Magazine LCD	Problems	Remedies
	▶ ◀		* If the camera cannot focus in the AF "S" (Single) mode, you cannot release the shutter. * When an M645 lens is installed and the aperture is less than f/5.6, this indicator appears.	- Try to adjust focus again, or change to the focus lock mode or manual focus mode. - Make the lens aperture faster than f/5.6.
batt	 batt		* This indicator appears when the battery capacity is low.	- Replace with new batteries.
-no-db	 -no-db		* The shutter will not operated when the digital back is not installed onto the camera body. If you try to press the shutter, this indicator appears.	- Install the digital back onto the camera body.
			* This symbol appears when setting the custom functions but you have not selected user A, B, or C.	- Select a user before changing the custom function settings.
	- U - - D -		* While in manual exposure mode, and when the difference between the set value and metered value exceeds 6EV, this indicator will appear.	- Change aperture or shutter speed.
F- -	 - -		* This will appear when a lens is not installed. * When an M645 lens is installed.	- Install a lens on the camera body.
Err-01 Err-02 Err-03 Err-04 Err-05 Err-06 Err-07	       		When "Err" appears, some abnormality has been detected in the course of taking photos.	- Replace with new batteries and press the shutter release button. If the "End" indicator still does not disappear, then contact our sales office or service center.

★ The camera caution mark  will blink if the camera body detects an abnormality.



10.5 Lens Maintenance

Never touch the inner optics of the lens with your fingers. Keep the inner optics perfectly clean with air, a lens brush or the dry cloth delivered with the lens.

Do not touch the contacts. Keep the contacts clean with either a dry cloth or by using a fibreglass brush. Do not use any other tools on the lens.

The lens is not waterproof. It should be immediately dried with a cloth if it becomes wet. If it is exposed to salt, moisten a cloth, wring it and carefully clean.



10.6 Back Maintenance

Cleaning the CCD

The Phase One IQ back must have the protection plate fitted when it is not attached to a camera. Dust may accumulate on the IR filter, which will degrade the image quality if not removed. Please follow the directions included in the CCD cleaning kit that came with the IQ back.

10.7 IR Filter on the CCD

The IR filter (Infrared reduction filter) is permanently mounted on top of the CCD. The filter may not be removed for several reasons:

- The focusing of the IQ back camera back will be damaged
- It is only possible to remount the filter without dust getting in between the filter and the CCD if you have access to special clean room facilities
- The Phase One Product Warranty is terminated



- Open platform for maximum choice and compatibility
- Durable, proven platform for secure operation
- Ergonomic handling and ease of use
- Use Phase One digital lenses, Mamiya AF/AFD lenses or Hasselblad V lenses
- Exposures from 1/4000s to 60 minutes
- Flash synchronization up to 1/1600 sec.

Shutter speed from 1/4000s to 60 minutes, extremely high flash synchronisation up to 1/1600 second to stop action with fast shutter speed or flash.

The mirror and viewfinder of the Phase One 645DF+ camera are almost three times larger than those of 35mm cameras, providing much greater control of focus and composition.

While hosting a complete list of features and custom functions, the Phase One 645DF+ camera is extremely easy to use. All settings important to the exposure are easily controlled by manual dials and soft buttons.

Camera type	Modular 645 AF SLR body
Lenses	Phase One Digital focal plane lenses, Schneider Kreuznach leaf shutter lenses and Mamiya 645 AFD lenses Compatible with Hasselblad V lenses
Backs	Open platform back mount
Auto focus	TTL phase-difference AF with 3 focus points Focus confirmation in manual mode Infrared AF assists for unfailing focus Auto focus lock for swift AF/ M shift
Shutter	1/4000s to 60 minutes Up to 120 frames per minute Shutter speed bracketing
Flash	Focal plane shutter: Up to 1/125s Leaf shutter lenses: Up to 1/1600s' 1 st and 2 nd curtain flash synchronization X sync terminal and support for TTL flash
Light Metering	TTL metering (average, spot and auto) Programmable AEL button Exposure compensation: +/- 5EV
Mirror-Up	Electronically-activated by switch on grip

Viewfinder	Fixed prism viewfinder Exchangeable diopter from -5 to +3 LCD panel with full exposure information
Focusing Screen	Interchangeable focus screens Laser engraved mask for digital back Matte, Grid, Checker, Microprism
Selftimer	Self-timer from 2 to 60 sec
Remote	Screw-in cable release on shutter button Terminal for electronic triggering devices
Stop Down Preview	Stop down button on front of camera
Tripod Socket	1/4 inch and 3/8 inch included
Power Requirements	Rechargeable Li-ion battery or 6 AA batteries (standard or rechargeable) External battery pack – 6 AA batteries External AC adapter
User configuration	3 Custom dial modes for capture settings 36 custom settings Customizable dials and buttons
Size	W, H, D // 6, 5, 7.2" // 153, 128, 184mm
Weight	35 oz. / 1030g. w/o batteries

Content is subject to change without notice

10.9 Phase One 645DF+ Housing Specification

Camera type : 6x4.5cm format, electronically controlled focal-plane shutter, TTL multiple mode AE, AF single lens reflex

Actual Image size: 56x41.5 mm

Lens mount : Mamiya 645 AF Mount, compatible with M645 Mount (manual focus confirmation, focus aid, stopped-down exposure metering)

Viewfinder : Fixed prism viewfinder magnification x0.71; built-in diopter adjustment (-2.5 to +0.5, optional diopter correction lenses provide adjustment ranges of -5 to -2 diopter and 0 to +3 diopter); built-in eye-piece shutter

Focusing screen : Interchangeable, Matte (standard), Checker, and Microprism Type C for Non-AF M645 lenses.

Field of view : 94%* of actual image

Viewfinder info : Focus mark, defocus mark, warning mark, aperture value, shutter speed, metering mode (A, S, A/S), exposure compensation value (difference between set value and metered value) and flash ready/ OK lamp with TTL Metz connection.

AF method : TTL phase difference detection method; sensor: CCD line sensor (I+I type); operating range: EV0 to EV18 (ISO 100)

Focus area : Displays the focus area in the viewfinder screen

AF assist beam : Activates automatically under low light, low contrast.

Range: 9m (when using AF80mm f/2.8 D lens)

AF lock : By pressing the shutter release button halfway down in the AF-S mode, or by pressing the AFL button.

Exposure modes : Aperture-priority AE, shutter-priority AE, programmed AE (PH, PL setting possible), and manual

AE metering mode : TTL metering, center-weighted average (AV), spot (S), and variable ratio (A-S auto)

Increments of shutter : Both the shutter speed and the aperture level can be set to 1/3 or speed and aperture 1/2 using the electronic dial lock function

Metering range : EV 2 to EV 19 (with ISO100 and AF80mm f/2.8 D lens)

Exposure compensation : Expandable to ± 5 EV

AE lock : With AEL button; canceled by pressing the button again. When AEL button is pressed, exposure compensation and metering difference is displayed in the viewfinder. (+6EV, 1/3 steps in M mode).

Shutter : Electronically controlled vertical metal focal-plane shutter. (vertical travel)

Shutter speed : AE 30 to 1/4000 sec. (1/8 step), manual 30 to 1/4000 sec. (1/2 or 1/3 steps), 1 min-60 sec. (1 step), X, bulb (Bulb, electronically controlled), tIME, shutter curtain protection mechanism

Auto bracket shot: Enable with auto bracket button (3 frame shots, 5 frame or 7 frame shot with auto bracketing). Specify 1/3, 1/2, 2/3 or 1EV steps.

Flash synch : X contact point, 1/125 seconds. Synchro speed can be changed away from terminal.

Flash control : TTL direct flash control, supports Metz SCA3002 system (SCA3952 Adapter)

Mirror up shot : Select by pressing the mirror up button.

LCD displays : Program AE mode icon, synchro mode icon, shutter speed, aperture, custom function icon, user function icon, focal plane mode icon, lens shutter mode icon, AE lock icon, auto focus lock icon, mirror up icon, focus area icon, auto bracketing icon, self timer icon, repeat mode icon, delay mode icon, remaining battery power icon, spot metering icon, dial lock icon, flash compensation icon, exposure compensation icon, exposure compensation, delay time.

Sync terminal : X contact (sync speed 1/125 sec.)

Cable release socket : On shutter button

Remote-control terminal : On side of body; electromagnetic cable release RE401 and RS402

Self timer : Self timer intervals can be set from 0.5 to 90 sec.: 0.5-10 sec. by the second, 10 to 90 sec. in 10 sec. units, 2 to 10 mins by the minute and 10 to 6 mins in units of 10 minutes.

Depth-of-field confirmation : Preview Button on body

Custom settings : 19 items

Tripod socket : U 1/4 inch and U 3/8 included

Power requirements : Rechargeable Li-ion battery or 6 AA batteries (alkaline or rechargeable)

External power socket : An external battery case can be connected.

Size & weight : 6 "(W)X5 "(H)X6 "(D) / 153(W)X128(H)X152(D)mm
2.3 pounds / 1,030 g (body only)

* This information is based on a linear (horizontal/vertical) measurement.

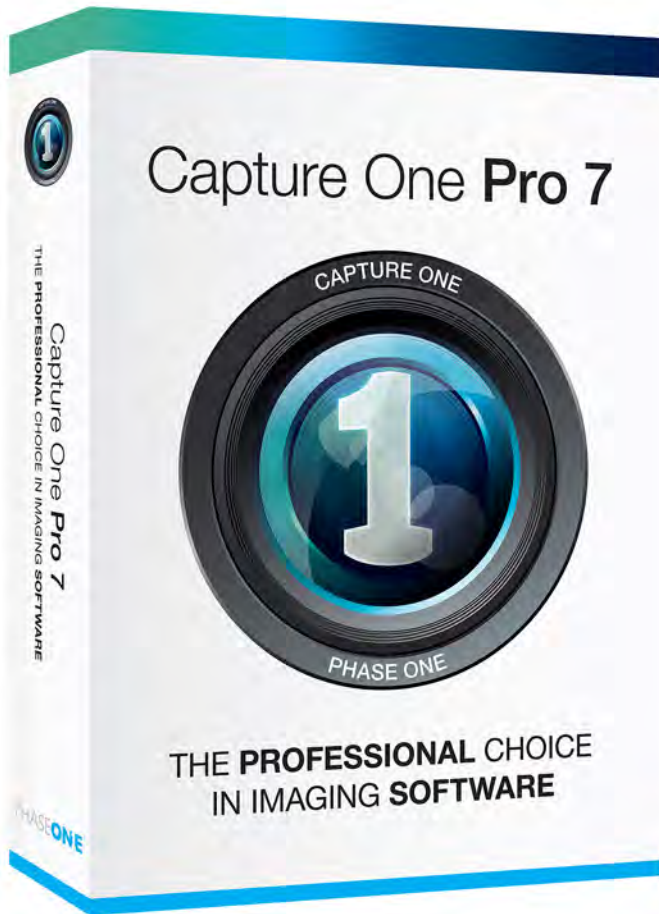

11.0 Software

Capture One Pro is a professional RAW converter and image editing software. It contains all the essential tools and high-end performance in one package to enable you to capture, organize, edit, share and print images in a fast, flexible and efficient workflow.

Please go to <http://help.phaseone.com/en> for further information regarding Capture One. (This online Users Guide can also be found under the Help menu on Windows and Mac). A PDF of the Capture One User Guide can also be found on the USB memory stick that came with you IQ back.

11.1 To Import Images...

1. Go to File and select "Import Images..." The dialog box will open to browse files.
2. Navigate to the applicable folder, card or disk in the Locations tool.
3. Select Capture folder (import location) and type in the job name and Metadata (copyright, caption) if desired.
4. If you want to select a naming format for the imported files, press "Format" in the Naming tool.
5. You can select all or specific images to import.
6. Press "Import All". You can continue working while images are imported in the background.

Inserting a memory card into a card reader will automatically bring up the Import Images dialog window.

Shooting Tethered

Capture One Pro is also used to shoot tethered from an IQ back. Find out more on page 53 or for more information please consult the online User Guide available in the Capture One Help menu or go direct to <http://help.phaseone.com/CO7/Capture/Tethered-Shooting.aspx>

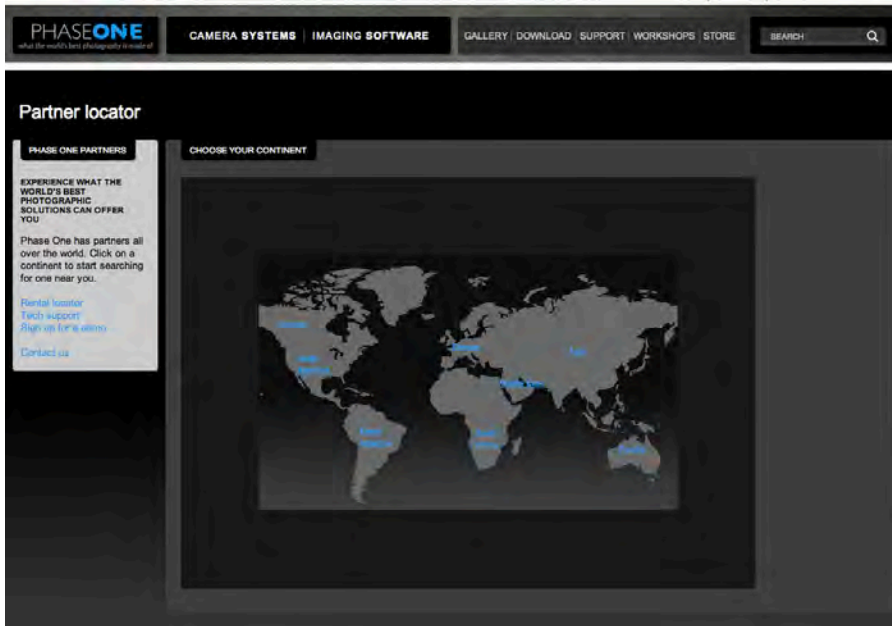

12.0 End User Support Policy

Phase One guarantee World Class Support and Service with every purchased product. Please check www.phaseone.com for the latest updated support policy.

Worldwide Dealer Network

At Phase One we think globally but act locally. Phase One's products are sold through a worldwide network of dedicated and competent local partners to make after-sales support convenient for you.

Phase One's local partners offer first line support to their customers. Many provide additional services such as training, extended warranty agreements, upgrade programs, and many other services that will add value to your Phase One investment. Contact your local Phase One partner to discuss your options. Digital camera back pricing and repairs are also handled locally.

If there is no local partner in your area, then please contact Phase One directly, and we will assist you directly or through one of our partners. Find your local Phase One partner or take advantage of Phase One's wide range of on-line support tools at <http://support.phaseone.com>

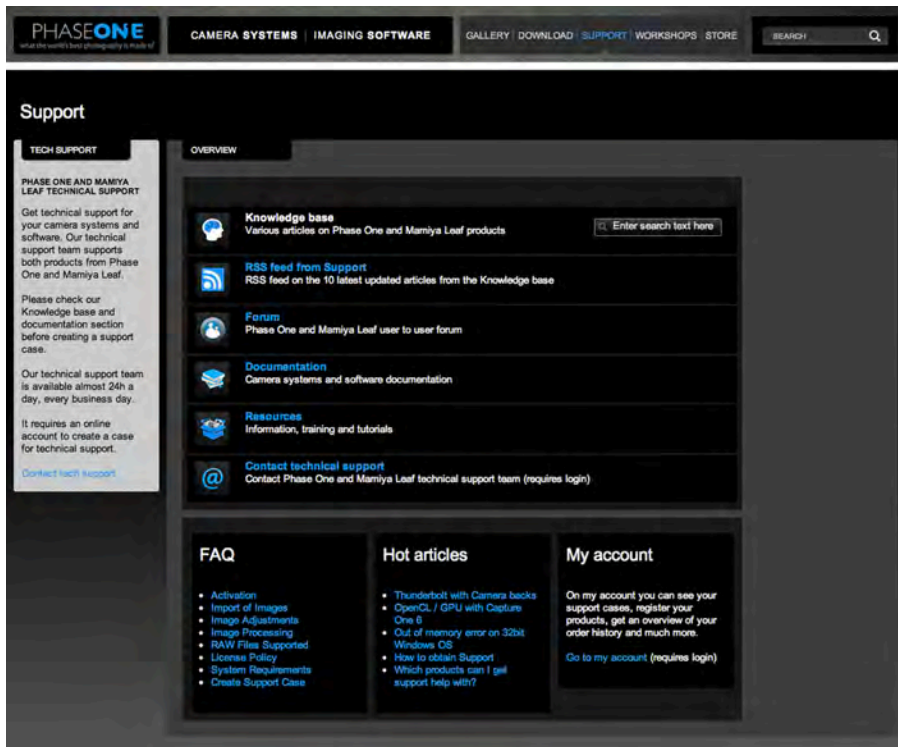

12.1 Web Resources

Phase One offer users a host of online resources including inspire, enthuse and inform. Find detailed information including User Guides and manuals about Capture One or our Digital Backs from www.phaseone.com

Knowledge Base

Phase One's searchable Knowledge Base at <http://support.phaseone.com> provides detailed answers to many users questions. This 'self-service' site is free of charge and available to all Phase One owners.

Capture One On-line Support Forums

Go to Phase One's official support forum to share your experiences and get assistance from other Phase One owners as well as from Phase One's Technical Support team at <http://support.phaseone.com>
Some Phase One partners offer on-line support forums, hosted from their own web pages. Please note that these forums are governed by separate rules. Phase One offers no guarantees and assumes no responsibility or liability with respect to the support provided by our local partners.

Many resources and tutorials are created on voluntary basis, and Phase One is always interested in seeing your videos, reviews, blogs or websites concerning Phase One.

PhaseOneDK Official YouTube Channel

Check out our Youtube channel that provides access to tutorials, showcases, technical videos and more at <http://www.youtube.com/PhaseOneDK>

Twitter, Facebook and Google+

There are plenty of ways to get in touch with Phase One across all the main social media platforms. Finds us on facebook follows us on Twitter and connect with us on Google+ for the latest product news, promotions and much more.

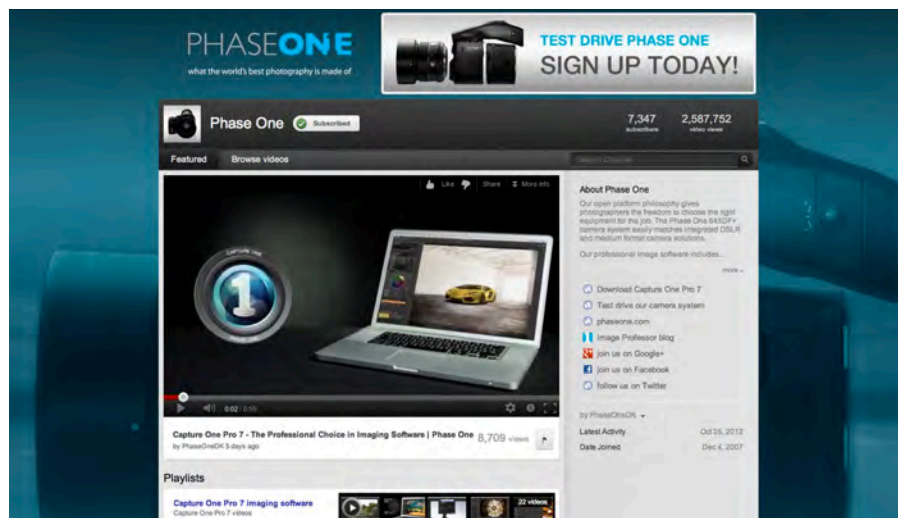



User Guide: Appendix

13.0 Open Platform – Freedom of Choice

Phase One's Open Platform policy delivers maximum choice and compatibility with a wide range of different camera platforms.

This section covers the IQ back's compatibility with the Hasselblad V and H series, Mamiya RZ67, Phase One 645, Mamiya 645, Contax 645 and View Camera solutions.

Double Exposure Protection

It is not possible to accidentally double expose an image by capturing one shot quickly after another when an IQ back is used on cameras such as the Phase One 645DF+/DF/AF, Mamiya 645DF/AFDIII or Hasselblad 555 ELD (DIG mode). The electronic communication with the body ensures that the IQ back is ready before allowing release of the next shot. However, users of other camera bodies that do not use the electronic interface from the IQ will have to wait for the ready beep signal before releasing the next shot.

Viewfinder Masks

Cameras including the Mamiya RZ67 and Hasselblad V-series need a viewfinder mask as the image area of these models is different to the image sensor size of the three IQ models. Go to page 92 to find out more about the IQ sensors and go to page 155 for the full list of focusing Screens and viewfinder masks.





13.1 IQ Back and Phase One 645AF/DF/DF+ and Mamiya 645 AFD

The IQ back is fully integrated with the Phase One and Mamiya 645 camera series and functions as a part of the whole camera system. The IQ back communicates with the cameras through a fast internal electrical computer interface.

Find out more about the Phase One DF+ camera and IQ back from page 12.

13.2 Mounting IQ back on the Phase One 645 AF & Mamiya 645 AFD Series

Ensure that the camera mirror is up and the shutter is open when no digital back is attached. When attaching the IQ back to the camera body the shutter will close and the mirror will come down.

1. Place the bottom of the IQ back in the locking mechanism.
2. Press the button (circled above left) with your thumb and lever the back into place.
3. Release the button to lock into position.

Failure to perform this procedure properly can cause an error with the camera body where the shutter will continuously open and close. If this occurs, remove the IQ back and follow steps 1 to 3 again.

13.3 More Details: Phase One and Mamiya 645 Series Cameras

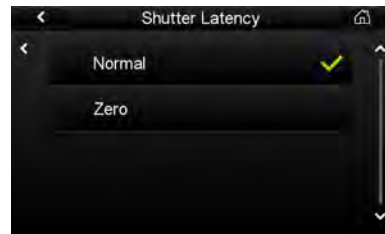
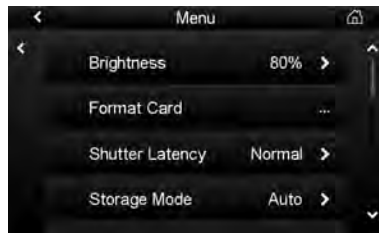

Power Management and Shutter Latency

The IQ CCD is put to sleep to reduce power consumption when it is not in use. The IQ needs to wake up before shooting and the timing of this wake up signal is referred to as the Latency.

The Phase One and Mamiya 645 camera body response time is independent of the shutter latency setting so it is therefore recommended to keep the latency on the Normal (default) setting, as this will ensure a longer battery life.

Studio Flash Sync on the Camera Body

A flash sync lead should be connected to the camera body when using the IQ back on Phase One 645AF or 645DF/DF+, Mamiya AFD or AFDII models.

Always use a flash cable and/or equipment that provides grounding for the flash.



Image Orientation

The CCD in the IQ back is positioned in a landscape orientation. However, the IQ back has an internal sensor that detects when it has been rotated. Thus, when the camera is rotated and an image is captured in portrait position the image will appear correctly oriented on the LCD and in the Capture One application.

Image (left) features the V-Grip Air. Phase One Part # 71507



Mirror Up

When using mirror up with the Drive Dial in the M.UP position ensure that the Exposure Mode Dial and the focus mode are both in Manual mode (M).

It is not possible for the camera to measure light or focus when the mirror is up. Please consult the Mamiya 645 Instruction manual to learn how to use Mirror Up.

Viewfinder Masking

The image area of the Phase One and Mamiya 645 cameras is approximately 56x42 mm. Viewfinder masking is not necessary for IQ280 and IQ260 models as their light sensitive CCD measures 53.9x40.4 mm.



14.0 IQ Back for Mamiya RZ67

The IQ backs are compatible with the Mamiya RZ PRO II and PRO IID with the use of an adaptor plate.

The 645DF+ version of an IQ back can be used on a Mamiya RZ PRO IID with a Mamiya RZ PRO IID adaptor plate. (Phase One Part # 70994)

The Hasselblad V version of an IQ back can be used on the older version Mamiya RZ PRO II with a Mamiya RZ Pro II adaptor. (Phase One Part# 70964)

N.B. It is possible to use a Hasselblad V version of an IQ back on the new Mamiya RZ67 PRO IID by getting the back mount plate modified with the following Mamiya service part number: Y22995-RZ.

14.1 Mounting IQ Back on the Mamiya RZ67

1. Place the bottom of the IQ back in the locking mechanism.
2. Press the button at the top of the back with your thumb and lever the back into place.
3. Release the button to lock into position.

N.B. It is important to ensure that the bottom part of the IQ back is attached correctly before the upper locking mechanism is pressed together.

Mounting the IQ Back Vertically

The CCD in the IQ back is positioned in a landscape orientation. However, it is possible to mount the IQ back in an upright orientation to capture images in a portrait format without having to rotate the camera. The IQ back has an internal sensor that detects when it has been rotated so images will appear correctly oriented on the LCD and in the Capture One application.

Mount the IQ back in the portrait position by lining up the adapter mount to the corresponding indentations on the left side of the back. Press the button (circled left) and lever the back into place. Release the button to lock into position.

14.2 Viewfinder Masking

The image area of Mamiya RZ67 at 56x69.5 mm is larger than the size of the three IQ model's sensors so it is necessary to insert a viewfinder mask.

There are two different masks available for the Mamiya RZ67 according to which IQ is being used. (The size IQ280 and IQ260 models CCD is 53.9x40.4 mm while the IQ140's CCD measures 43.9x32.9mm). Please check page 155 for the relevant viewfinder mask.



Insert a Viewfinder Mask

1. Remove the protection tape from the mask.
2. Dismount the prism/waist-level finder and remove the focus screen.
3. Place the viewfinder mask in the bracket that holds the focusing screen.
4. Re-mount the viewfinder focus screen.
5. Re-attach the prism/waist-level finder.

N.B. Please check the relevant Mamiya RZ67 manual regarding how to dismount the viewfinder and remove the focus screen.



14.3 More Details: Mamiya RZ67

Mode Selector

The mode selector on the trigger button should be turned to the white dot when used with the IQ back. The selector should be set to the orange dot to avoid draining the small battery when the IQ back is attached to the body and not in use.

Warning: Even if the IQ back is turned off, the battery will drain slowly if the orange dot is not selected

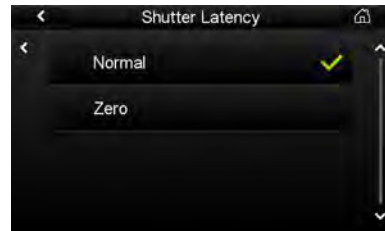
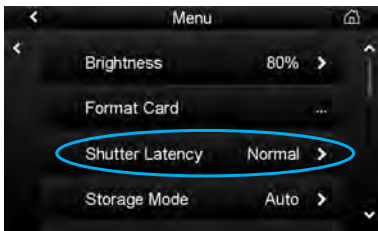

Shutter Latency Setting Mamiya RZ PRO II

An IQ back should be set to Normal Latency when it is used with a Mamiya RZ PRO II.

Shutter Latency Setting Mamiya RZ PRO IID

Select the special Mamiya RZPRO IID camera mode, which is available in the Camera mode menu to ensure that the correct latency setting is used.



Studio Flash Sync on the RZ lens

A flash sync lead should be connected to the port on a lens when an IQ back is used on a Mamiya RZ67 PRO IID. On the older PRO II, use the flash sync connector on the Adapter plate. (The flash sync port on the IQ back is for use with Large format cameras where no digital interface is available).

Mirror Up

Mirror up operation is only recommended if using Mamiya's own double cable release.

Double Exposure

It is only possible to get a double exposure when a Hasselblad V mount plate is being used. Avoid a double exposure by waiting for a ready-beep from the IQ back before capturing another image.

15.0 IQ Back for Hasselblad V Series

The Phase One IQ back can be mounted on a wide range of Hasselblad cameras including Hasselblad 555 ELD, 553 ELX, 501 CM and 503 CW.

15.1 Mounting the IQ Back on a Hasselblad V Series Camera

1. Place the bottom of the IQ back in the locking mechanism.
2. Press the button at the top of the back with your thumb and lever the back into place.
3. Release the button to lock into position.

N.B. It is important to ensure that the bottom part of the IQ back is attached correctly before the upper locking mechanism is pressed together.

Mounting the IQ Back Vertically

The CCD in the IQ back is positioned in a landscape orientation. However, it is possible to mount the IQ back in an upright orientation to capture images in a portrait format without having to rotate the camera. The IQ back has an internal sensor that detects when it has been rotated so images will appear correctly oriented on the LCD and in the Capture One application.

Mount the IQ back in the portrait position by lining up the adapter mount to the corresponding indentations on the left side of the back. Press the lock button (circled left) and lever the back into place. Release the button to lock into position.

Warning! DO NOT MOUNT WHILE IN S OR RS MODE

N.B. The Phase One IQ back should not be mounted while the camera is set to mirror up (S or RS modes). The camera should be set to AS, A or 0 mode. Also ensure that the lens is not jammed when connecting the flash sync cable to the Phase One IQ back.



15.2 Mounting a Viewfinder Mask on a Hasselblad V Series Camera
The image area of a Hasselblad V camera body at approx. 6x6cm is a different size to the three IQ model's sensors so it is necessary to insert a viewfinder mask.

There are two different masks available for Hasselblad V series cameras according to which IQ is being used. The size IQ280 and IQ260 models CCD is 53.9x40.4 mm while the IQ140's CCD measures 43.9x32.9mm. Please check page 155 for the relevant viewfinder mask.



Insert a Viewfinder Mask

1. Remove the protection tape from the mask.
2. Dismount the waist-level finder and remove the focus screen.
3. Place the viewfinder mask in the bracket that holds the focusing screen.
4. Re-mount the viewfinder focus screen.
5. Slide the waist-level finder back into place.

N.B. Please check the relevant Hasselblad camera manual instructions before removing the focus screen.

15.3 More Details: Hasselblad V Series

Sync Cable

A sync cable is always connected from the lens to the small connector in the front plate on either the left or right side of the IQ back regardless of which Hasselblad V type camera used.

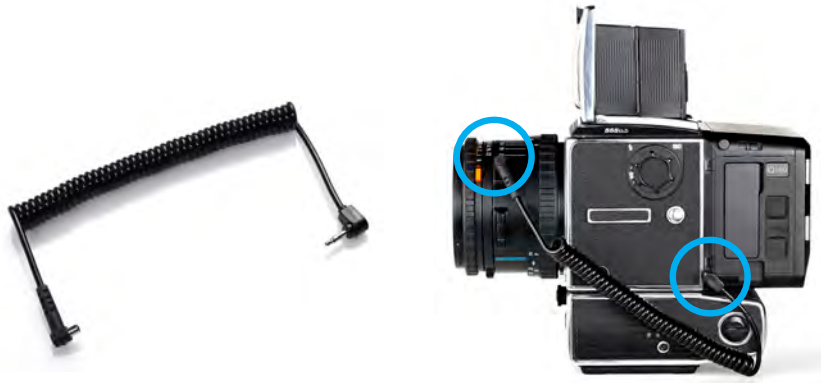

Flash Lead Connection

A flash cable is always connected to the F-connector on the IQ back with all Hasselblad V series cameras.



Mirror Up and Shutter Latency Setting

Set the Latency to Zero when shooting with a Hasselblad V, 903 CW and 905 CW.

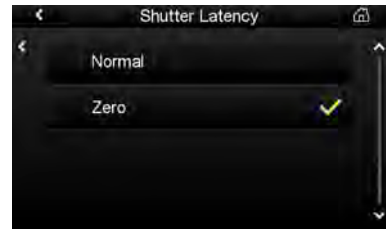

Tethered Capture

Plug a FireWire 800 cable into the IQ back for tethered capture to a computer using Capture One Pro.



15.4 Hasselblad 555 ELD

Ensure that the shutter release on the front of the Hasselblad 555 ELD is in the DIG position when using a Phase One IQ back.

If for any reason you have to use the 555ELD in Film position (E.g. If the DIG is not working) then set the IQ to Zero Latency.

Shutter Latency Setting

The IQ back can be used with both Normal and Zero latency with the Hasselblad 555 ELD.

An IQ back has a default Normal latency setting that helps to save battery life. But users may experience unwanted double exposures when using a two-shot release cable.

Motor Cable on Hasselblad 555 ELD

A motor cable is not required when using an IQ back on a Hasselblad 555 ELD body.



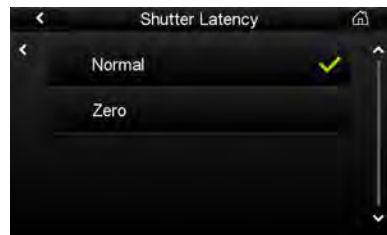

15.5 Hasselblad 553 ELX

When using the IQ back on some Hasselblad motorized bodies (i.e. Hasselblad ELX or Hasselblad ELM series), a motor cable is supplied to enable users to fire the camera shutter from a computer using the Capture One Pro Capture button. (See circled button left).

Cable Connections

The cable is connected between the multi-connector on the IQ back and the DIN connector on the Hasselblad. Ensure that A or AS mode are not used.

WARNING! Please note that the Phase One IQ back should not be mounted while the camera is set to mirror up (S or RS modes). Make sure that the lens is not jammed or locked open on the "B" setting when connecting the flash sync cable to the Phase One IQ back.

Shutter Latency Setting

Set the latency setting to Normal on the IQ back while using a Hasselblad 553 ELX.

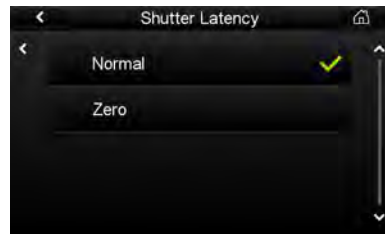
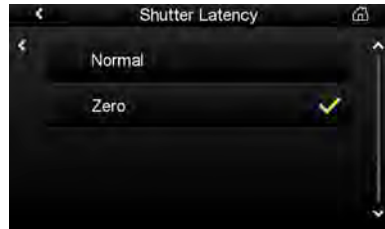
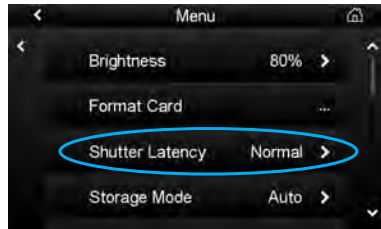

15.6 Hasselblad 501 CM and 503 CW without Winder

The Phase One IQ back can also be used with mechanical Hasselblad cameras such as the 501 CM and 503 CW. These cameras are operated in single shot mode via the shutter release button or a standard cable release.

WARNING! Please note that the Phase One IQ back should not be mounted while the camera is set to mirror up. Also ensure that the lens is not jammed or locked open on the "B" setting when connecting the flash sync cable to the Phase One IQ back.

Shutter Latency Setting

Set the latency setting to Normal on the IQ back while using a mechanical Hasselblad. Set the latency setting to Zero whilst using the Mirror Up function or if you need to rapidly press the shutter button. Precautions must be taken not to trigger the shutter too fast when using Normal latency. If any problems arise, it is recommended that users look at the green LED on the back while slowly pressing the mechanical trigger on the camera body. Users can safely press the button all the way in the moment the LED flashes.

15.7 Hasselblad 503 CW with Winder CW

WARNING! Please note that the Phase One IQ back should not be mounted while the camera is set to mirror up. Make sure that the lens is not jammed or locked open on the "B" setting when connecting the flash sync cable to the Phase One IQ back.

Set the Shutter Latency to Zero when using a 503 CW winder with an IQ back.

15.8 Cables shipped with IQ back for Hasselblad V
Classic and Value Added backs come with all the cables needed for the specific camera platform. A Value Added back also comes with an additional 50300143 cable for use with large format and technical cameras.

Part# 50300145 Motor cable for Hasselblad ELX. (Used for host capture when the IQ back is used on a Hasselblad ELX body).

Part# 50300148 Sync cable short (For use with all Hasselblad medium format bodies)

Part# 50300143 Multi connector to Lens sync (for use with Large format - in two shot mode)

Part# 50300144 This cable is available as a separate purchase only. From multi connector to mini jack female (for use to adapt older Large format walk-up cables or older Kapture Group one shot adaptor cables to connect to the multiport).



16.0 IQ Back for Hasselblad H Series

The Phase One IQ (H-mount) digital back is designed specifically for Hasselblad H1 and H2 cameras.



16.1 Mounting the IQ back on the Hasselblad H1/H2

1. Ensure that the mirror is up and the shutter is open. (This is the default position when no cassette is attached to camera body).
2. Place the bottom of the IQ back in the locking mechanism.
3. Lever the back into place.
4. Do not let go of the back until you hear a clicking noise that signals the back is locked into position. The mirror will come down and shutter will close when IQ back is attached to the camera.

N.B. It is important to ensure that the bottom part of the IQ back is attached correctly before the upper locking mechanism is pressed together.

Removing the IQ back from the Hasselblad H1/H2

1. Rotate and press the silver button (illustrated left) to unlock the back. (Ensure that the back is supported in your hand before pressing this button).
2. Gently lever away the top of the back first. Be careful with the contacts and protective glass on the back.

N.B. Your IQ back should always be protected by its plate when it is not attached to the camera.





16.2 Viewfinder Masking

The image area of the Hasselblad H1/H2 cameras is 56x41.5 mm. A viewfinder mask is only needed for the smaller size of the IQ140 CCD that measures 44x33mm. Viewfinder masking is not necessary for IQ280 and IQ260 models as their light sensitive CCD measures 53.9x40.4 mm.

Please check page 155 for the relevant viewfinder mask.

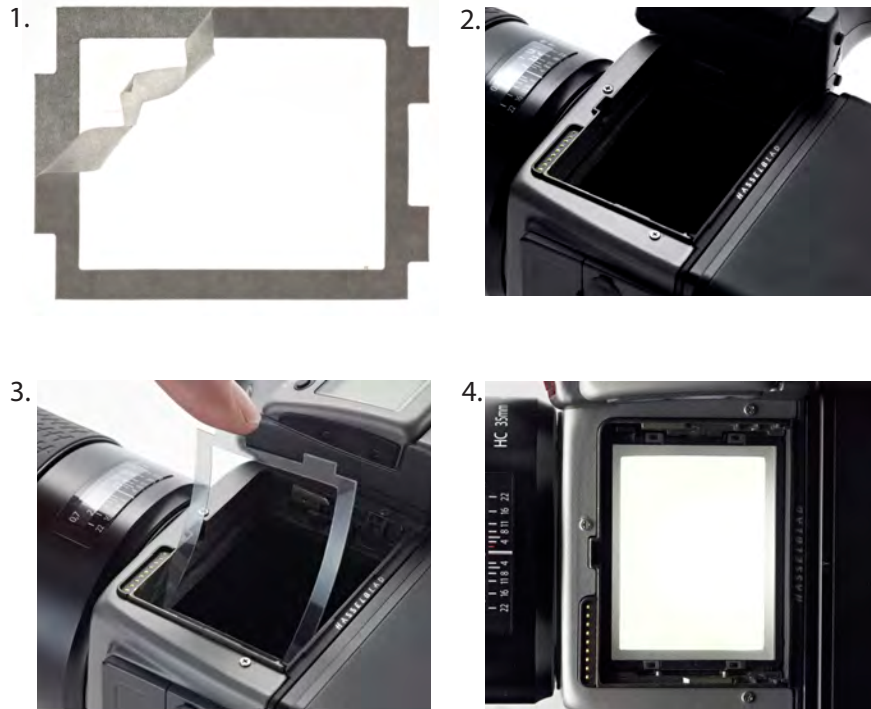

Insert a Viewfinder Mask

1. Remove the protection tape from the mask.
2. Dismount the prism/waist-level finder and remove the focus screen.
3. Place the viewfinder mask in the bracket that holds the focusing screen.
4. Re-mount the viewfinder focus screen.
5. Re-attach the prism/waist-level finder.

N.B. Please check the relevant Hasselblad H-series manual regarding how to dismount the viewfinder and remove the focus screen.

16.3 More Details: Hasselblad H Series

Camera Display

The Hasselblad H1/H2 incorporates a screen that displays information about the camera set-up. It shows the aperture value, AF mode, shutter speed etc.

The Hasselblad H1/H2 will also display some IQ back information on this screen. For example, error messages including "Digital back storage media is full" will be displayed on the screen if the CompactFlash in the IQ back is full to capacity.

ISO Settings

The ISO value is also displayed on the H1/H2 camera screen. The ISO setting can be adjusted from the camera back or in Capture One software when shooting tethered.

Please consult page 61 of this manual for details on setting the ISO. Go to page 53 for more information about tethered shooting.

Auto Exposure

All the Hasselblad H1/H2 auto exposure modes are fully supported by the IQ back.

Please check the relevant Hasselblad H-series manual for more information on exposure modes.

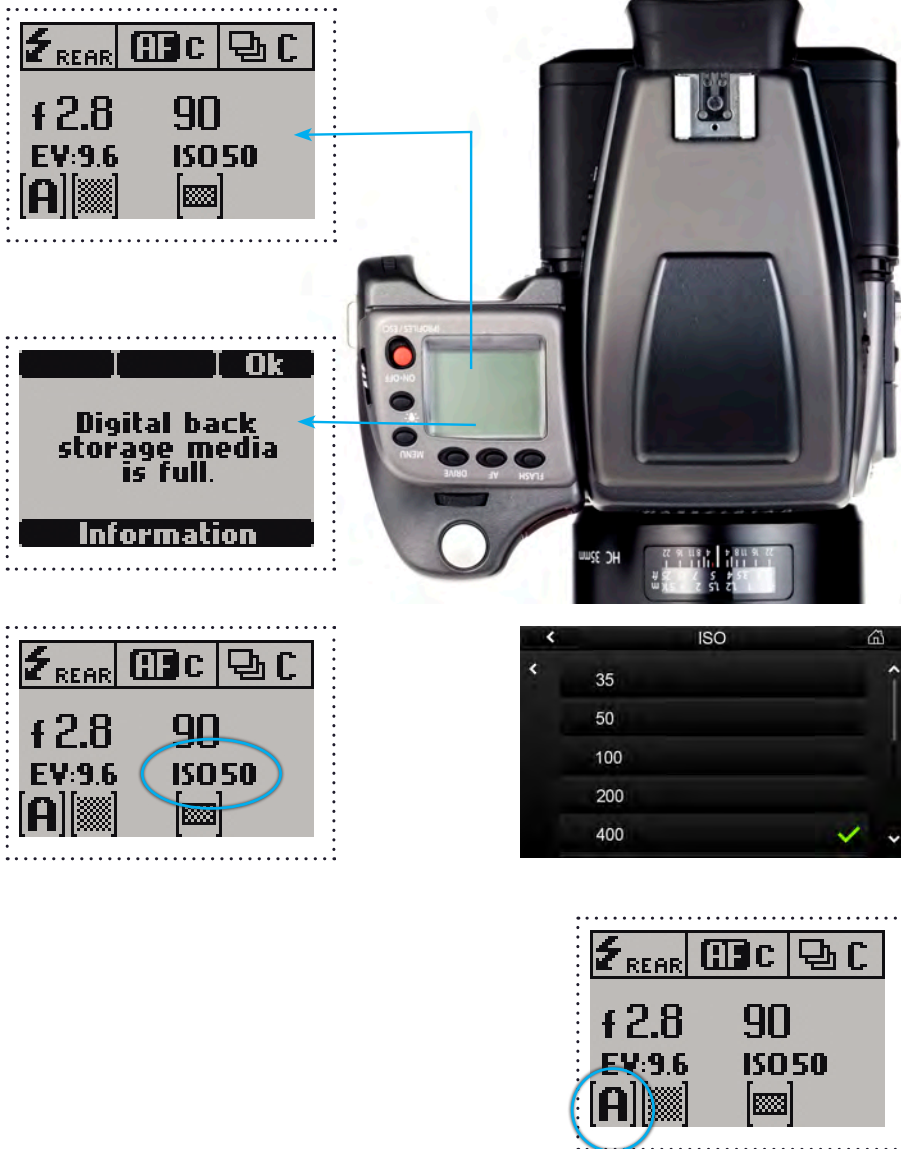



Viewfinder Information

The viewfinder information bar is located below the image area within the viewfinder display. It displays the camera's exposure mode and values etc. It also includes a counter with the number of captures remaining on the storage media. (See top bar circled left). '99' is the maximum number displayed. '99' will continue to be displayed if there are more than that remaining on a CompactFlash card. An 'E' indicates that the storage media is full. Users will have to delete some captures or replace the CompactFlash card before continuing. (See bottom bar circled left).



Double Exposure Protection

It is not possible to accidentally double expose an image by capturing one image quickly after another when an IQ back is used on a Hasselblad H1/H2.

N.B. At the end of an exposure, image information has to be moved from the CCD to the processing system. During this short period of time the CCD must be protected from light exposure. The IQ back ensures that the CCD is safely cleared of information by disabling the Hasselblad camera's shutter release during this procedure.



Image Orientation

The CCD in the IQ back is positioned in a landscape orientation. However, the IQ back has an internal sensor that detects when it has been rotated. Thus, when the camera is rotated and an image is captured in portrait position the image will appear correctly oriented on the LCD and in the Capture One application.



Flash Lead Connection

A flash cable is always connected to the Hasselblad H1/H2 camera body.



The flash sync cable must not be connected to the camera back when used on a Hasselblad H1/H2. The flash sync connector on the IQ back is only intended for use with a Phase One FlexAdaptor or other large format adaptors.



16.4 Cables Shipped with IQ back for Hasselblad H

No cables are required to use the IQ back with a Hasselblad H1/H2.

A Value Added IQ back comes with an additional multi-connector to Lens sync cable (part# 50300143) for use with large format cameras in two shot mode.



Part# 50300144 This cable is available as a separate purchase only. From multi-connector to mini jack female (for use to adapt older Large format wake-up cables or older Kapture Group one shot adaptor cables to connect to the multiport).



17.0 IQ Back for Contax 645

The Phase One IQ (Contax mount) digital back is designed specifically for the Contax 645 camera. The IQ back communicates with the Contax 645 through a fast internal electrical computer interface and utilizes TTL phase difference detection type auto focus system.



17.1 Mounting IQ Back on a Contax 645

1. Place the bottom of the IQ back in the locking mechanism.
2. Press the button at the top of the back with your thumb and lever the back into place.
3. Release the button to secure it into position.
4. Lock the IQ back into place by sliding the switch left towards the release button. (See switch circled below left).

N.B. It is important to ensure that the bottom part of the IQ back is attached correctly before the upper locking mechanism is pressed together.

Removing the IQ back from the Contax 645

1. Slide the locking switch to the right position.
2. Press the button (circled left) to unlock the back. (Ensure that the back is supported in your hand before pressing this button).
3. Gently lever away the top of the back first. Be careful with the contacts and protective glass on the back.

N.B. Your IQ back should always be protected by its plate when it is not attached to the camera.

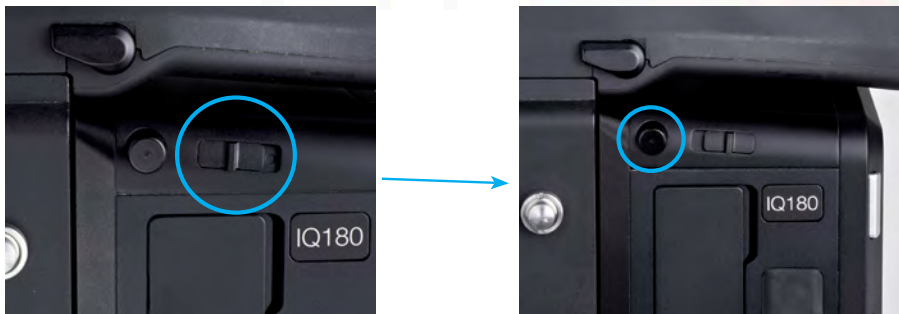



17.2 Viewfinder Masking

The image area of the Contax 645 camera is 56x41.5 mm. A viewfinder mask is only needed for the smaller size of the IQ140 CCD that measures 44x33mm. Viewfinder masking is not necessary for IQ280 and IQ260 models as their light sensitive CCD measures 53.9x40.4 mm.

Please check page 155 for the relevant viewfinder mask.

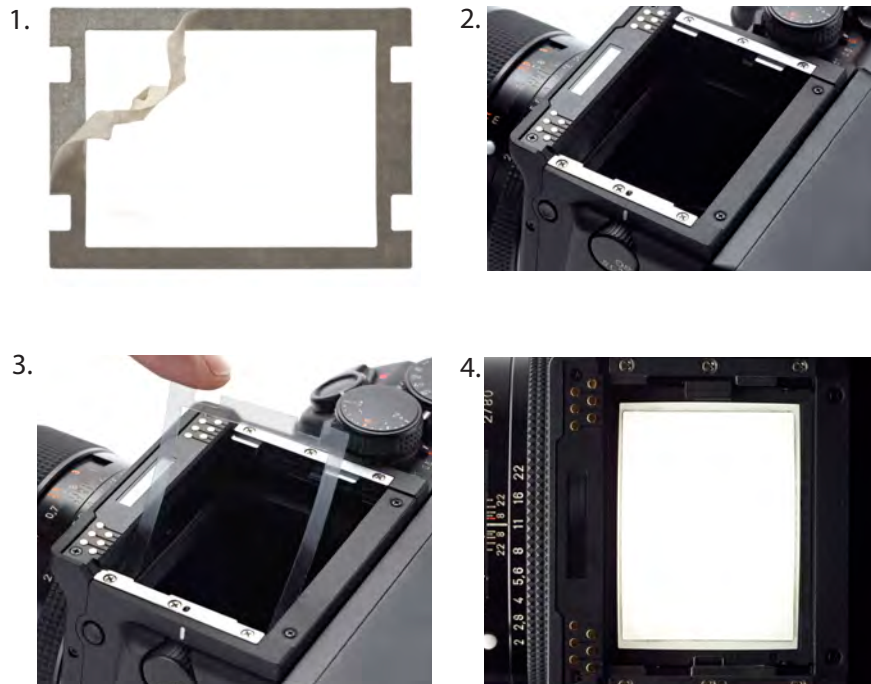

Insert a Viewfinder Mask

1. Remove the protection tape from the mask.
2. Dismount the prism/waist-level finder and remove the focus screen.
3. Place the viewfinder mask in the bracket that holds the focusing screen.
4. Re-mount the viewfinder focus screen.
5. Re-attach the prism/waist-level finder.

N.B. Please check the relevant Contax 645 manual regarding how to dismount the viewfinder and remove the focus screen.

17.3 More Details: Contax 645



Exposure Modes

The Contax 645 manual (M) and semi-auto exposure modes (Av, Tv) are fully supported by the IQ back. Please note that Bulb is only supported on Contax/IQ back when used in conjunction with the Live View function. Go to Chapter 20 (from page 156) for more information about Live View.

Please check the relevant Contax 645 manual for more information on exposure modes.

Ensure that exposure times are limited between 1/4000 second and approx. 1 second to obtain the highest possible quality with an IQ back and Contax 645. Please note that it is not possible to expose images longer than 60 seconds with an IQ back.

ISO Settings

The Contax 645 exposure modes use the ISO value set in the IQ back. The ISO setting can be adjusted from the camera back or in Capture One software when shooting tethered.

Please consult page 61 of this manual for details on setting the ISO. Go to page 53 for more information about tethered shooting.

Double Exposure Protection

It is not possible to accidentally double expose an image by capturing one image quickly after another when an IQ back is used on a Contax 645 e.g. when using the continuous drive mode.

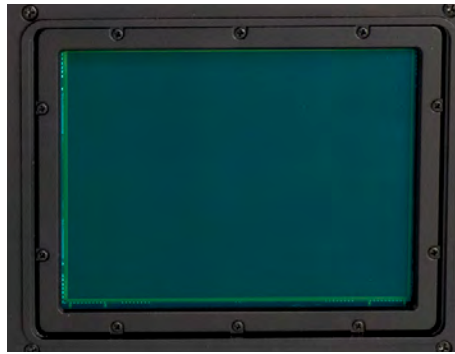

TTL flash

Using TTL flash with the Contax 645 camera and IQ back will result in a 2 f-stop overexposure. When using TTL flash, the exposure compensation on the flash unit must therefore be set to -2 f-stops.

This overexposure happens because the CCD element reflects light differently than film and this cannot be communicated to the Contax.

Image Orientation

The CCD in the IQ back is positioned in a landscape orientation. However, the IQ back has an internal sensor that detects when it has been rotated. Thus, when the camera is rotated and an image is captured in portrait position the image will appear correctly oriented on the LCD and in the Capture One application.



17.4 Flash Lead Connection

A flash cable is always connected to the Contax 645 camera body.

The flash sync cable must not be connected to the camera back when used on a Contax 645. The flash sync connector on the IQ back is only intended for use with a Phase One FlexAdaptor or other large format adaptors.





17.5 Cables Shipped with IQ back for the Contax 645
(Value added only)

Part# 50300143 Multi-connector to Lens sync (for use with Large format - in two shot mode)



Part# 50300144 This cable is available as a separate purchase only.
From multi-connector to mini jack female (for use to adapt older Large format wake-up cables or older Kapture Group one shot adaptor cables to connect to the multiport).



Part# 50300154 From multi-connector to mini jack on the Contax handgrip
(used to enable Host Capture from Computer)

N.B. Operating the camera from the host computer
The supplied release cable must be connected between the multiple-pin connector on the IQ back and the mini-jack connector placed at the bottom of the handgrip on the Contax camera house.



18.0 IQ Back for View Cameras

The Phase One IQ back is compatible with most technical view cameras and large format cameras via camera interface adaptors. The IQ back supports most mechanical shutters and some electronic shutters from Horseman, Schneider and other manufacturers.



Phase One Sleeping Architecture

The Phase One Sleeping Architecture has been developed to help produce noise free exposures without the use of active cooling of the CCD. The sleeping architecture ensures minimum heat build up inside the back by putting all the unused circuits to sleep, and only powering the circuits that are actually needed at any given time.



18.1 Using the 2-shot Release

The IQ back can be used with mechanical shutters that can be fired twice within four seconds. The first release of the shutter activates the digital back; the second release is for the exposure. If the time limit of four seconds is exceeded, the camera gives a warning 'beep' followed by a 'two shoot error' warning that will be displayed on the LCD screen.

There are several automatic or semi-automatic two shoot solutions available from third parties manufacturers to use with a mechanical shutter. Please ask your dealer for more information.



18.2 Using the 1-shot Release

The 1-shot release cable is created to simplify your studio workflow.

1. Connect the flash exit (circled left) on the shutter and plug the opposite end to the multi-pin port on the IQ back. (Via Part# 50300144 From multi-connector to mini jack female)

2. Connect a flash sync lead to the port on the IQ back.

3. Close the shutter if necessary.

4. Push the button on the 1-shot release lead to 'wake up' the camera back . (circled left) and take the shot within a few seconds.



N.B. It is not possible to control the exposure or trigger the shutter from Capture One when using a fully manual camera. Only limited EXIF data is recorded when shooting with manual cameras. The IQ back will add a calculated approximate shutter speed but the aperture value will not be recorded.



18.3 Phase One FlexAdaptor

The Phase One FlexAdaptor is available for use with most large format cameras.

The Phase One FlexAdaptor can automatically stitch two or three images together using the Stitch function in Photoshop.

Please see the reference manual that comes with the FlexAdaptor for more details.

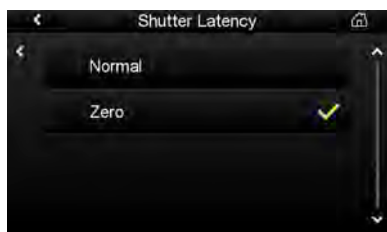
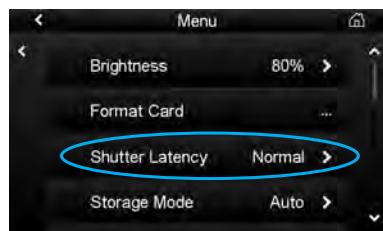

18.4 Shutter Latency Settings for the FlexAdaptor and Other Technical Camera Adaptors

The Phase One FlexAdaptor and other technical camera adaptors for the IQ back can be used with both normal and zero shutter latency.

Select the Normal latency setting if the IQ back is used on a camera with a 2-shot release. (See 18.1)

Please note: The Zero shutter latency setting will increase the power consumption of the IQ back, as it will be constantly prepared for exposure.

19.0 List of Focusing Screens and Viewfinder Masks

19.1 Full Frame Focusing Screens or with Engraved Masking

Part #

- 70756 Focusing Screen for Phase One 645 Camera (Standard Full Frame IQ280/IQ260)
- 70754 Focusing Screen IQ140 for Phase One 645 Camera
- 70757 Focusing Screen for Phase One 645 Camera SD402 (Checker Grid)
- 70758 Focusing Screen for Phase One 645 Camera SA402 (Microprism for non AF lenses)



19.2 Viewfinder Masks

Part #

- 40101906 Viewfinder Mask for Phase One IQ140 for Hasselblad H1/H2
- 40101903 Viewfinder Mask for Phase One IQ140 for Phase One/Mamiya 645 AFD
- 40101905 Viewfinder Mask for Phase One IQ140 for Contax 645
- 40101901 Viewfinder Mask for Phase One IQ140 for Hasselblad V
- 40101929 Viewfinder Mask for Phase One IQ140 for Mamiya RZ
- 40102056 Viewfinder Mask for Phase One IQ260/IQ280 for Mamiya RZ
- 0102044 Viewfinder Mask for Phase One IQ260/IQ280 for Hasselblad V

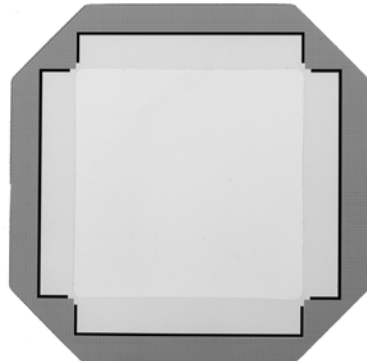
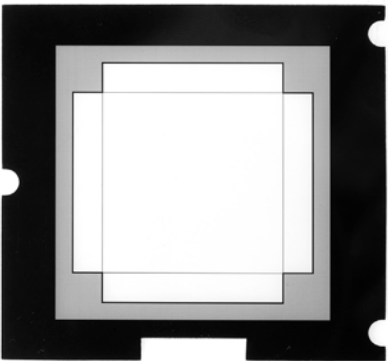



20.0 Live View

The Live View function is intended for use when a camera is mounted on a tripod and the subject is stationary.

Live View is ideal for use with technical view cameras in a studio environment or for architectural photography, where photographers would ordinarily have to rely on an external viewfinder or a separate focusing glass / sliding adaptor.

The Live View function enables photographers to compose an image directly on the high resolution display of the IQ digital back. Focus can be checked by zooming into a subject on the screen by up to 400%.

20.1 Starting Live View

1. Live View is accessed from the Context Menu (circled left) in the lower right corner.

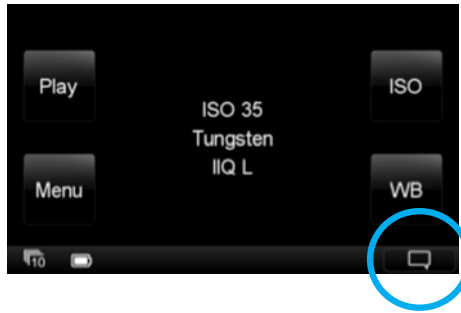

The Context menu is always visible on the Home screen. Tap the lower right corner of the screen to reveal the icon if it is hidden in some of the Play mode displays.

2. Select the Live View (movie camera) icon from the context menu. (Circled left).



3. When Live View is activated ensure that a Live View white balance is applied. Tap the lower right corner of the screen to bring up the context menu and select the White Balance Picker (Circled left).

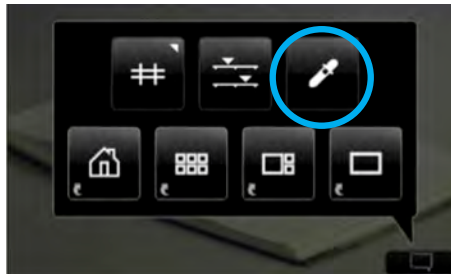

Go to page 158 for more information about Live View white balance.

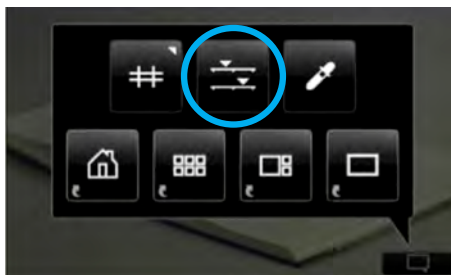

20.2 White Balance

1. After selecting the White Balance Picker, tap the screen to select a neutral area to calibrate the Live View.

2. If a precise white point is difficult to achieve in full screen view, slide a finger on the left side of the screen to zoom into to a part of the image that you want to use as white reference.
Exit the White Balance mode by deselecting the picker in the context menu. Alternatively, press and hold the upper left physical button on the IQ back to return to the Home screen.

Go to page 159 to find out more about the zoom function.

20.3 Quality and Brightness

1. Go to the context menu and select the Live View exposure controls icon (circled left).

2. Two sliders will appear at the bottom of the screen to help users adjust the live view to suit the ambient lighting conditions being used. The top slider is a speed vs. quality slider. Increase the quality by moving slide to the right or achieve a faster frame rate on the left. The lower slider controls the brightness of the Live View.

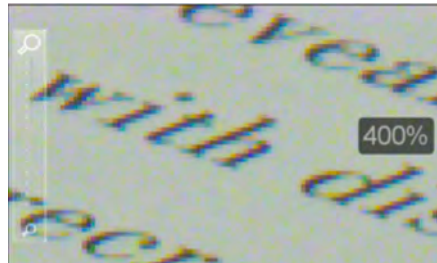

20.4 Zoom

Zoom into the live view by sliding a finger up in the left side of the screen. Double tap on the image to bring up a 100% view. If a zoom is already applied, double tap the screen to return to a full image view.

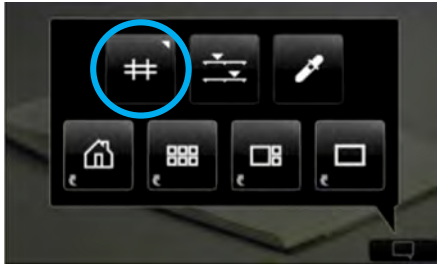

20.5 Grid

1. Go to the context menu and select the Grid icon (circled left) to apply a default grid. Press and hold the Grid icon to select one of a selection of other grid options to apply to the live view.

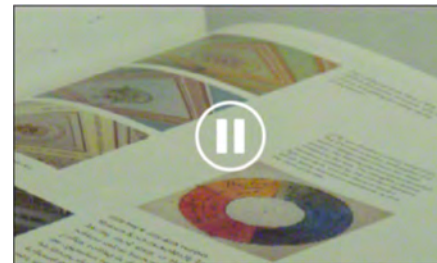

20.6 Auto Stop and Start

Live View will be paused if the screen is not touched for one minute. Touch the screen again to restart Live View.

20.8 Live View Camera Support

The Phase One IQ back Live View function is supported on both medium and large format view cameras. Find out how to operate Live View from the following list of cameras:



View Cameras

1. Open the lens and select the desired aperture value.
2. Activate Live View on the IQ back.



Phase One 645AF/645DF/645DF+

1. Activate Live View on the IQ back.
2. Adjust the exposure time dial until the camera display states 'time'.
3. Press the camera shutter button.



Hasselblad H1/ H2

1. Activate Live View on the IQ back.
2. Select the M (Manual) mode.
3. Select the desired aperture value.
4. Set the shutter to 'T mode'.

N.B. It is only possible to change the aperture when the camera body is idle/not exposing. Please exit the T-mode to change aperture.



Hasselblad V

1. Activate Live View on the IQ back.
2. Select B (Bulb) mode.



Mamiya RZ67 Pro II/Pro IID

1. Activate Live View on the IQ back.
2. Select B (Bulb) mode.

N.B. It is only possible to change the aperture when the camera body is idle/not exposing. Please exit the Bulb mode to change aperture.



Contax 645

1. Activate Live View on the IQ back.
2. Select B (Bulb) mode.
3. Select the desired aperture value.

N.B. It is only possible to change the aperture when the camera body is idle/not exposing. Please exit the Bulb mode to change aperture.