

User Manual

EVS4343W / EVS4343WG / EVS 4343WP
EVS3643W / EVS3643G / EVS 3643WP



DRTECH

Digital Radiography Technologies

Rx Only

Manual Information

Copyright

Information contained in this manual is confidential and the property of DRTECH Co, Ltd., which is only provided to the authorized customers of DRTECH Co, Ltd. The purpose of the manual is to assist the users to comprehensively utilize the product of DRTECH Co, Ltd. All information contained in the manual may not be altered or distributed without prior written consent of DRTECH Co, Ltd., and may not be disclosed to unauthorized personnel. Information contained in the manual may be subject to change without prior notice.

Copyright © 2019 DRTECH Co, Ltd. All rights reserved.

To Customers

Thank you for purchasing the DRTECH Radiography EVS4343W / EVS4343WG / EVS3643W / EVS3643G / EVS 4343WP / EVS 3643WP(hereinafter this Product). This User's Manual explains how to use the detector, x-ray interface unit, and other peripheral equipment. Before using this product, be sure to read this manual thoroughly in order to utilize it more effectively. Also, read the Operation Manual for EVS Calibration and configuration Software (hereinafter ECal1).

Important information on usage and management of equipment

- Only a physician or legally certified operator should use this product.
- The equipment should be maintained in a safe and operable condition by maintenance personal.
- Use only computers and image display monitors complying with IEC 60601-1 or IEC 60950-1 and under a system configuration complying with IEC 60601-1. For details, consult your sales representative or local DRTECH dealer.
- Use only the dedicated cables. Do not use any cables other than those supplied with this product.

Disclaimer

- In no event shall DRTECH be liable for any damage or loss arising from fire, earthquake, any action or accident by a third party, any intentional negligent action by users, any trial usage, or other usage under abnormal conditions.
- Roentgenography, image processing, image reading, and image data storage must be performed in accordance with the laws of the country or region in which the product is being used. The user is responsible for maintaining privacy of image data.
- In no event shall DRTECH be liable for personal physical harm or property damage that is sustained, under any conditions when the instructions are not followed or the product is misused.
- It is the responsibility of attending physicians to provide medical care services. DRTECH will not be liable for fault diagnosis.

- In no event shall DRTECH be liable for direct or indirect consequential damages arising from the use or unavailability of this product. DRTECH shall not be liable for loss of image data for any reason.
- In no event shall DRTECH be liable for any damage arising from moving, alteration, inspection or repair by a person other than authorized service engineers.
- Specifications, compositions, and appearance of this product may change without prior notice.

Please contact us if there are any problems while using the product.

DRTECH Co, Ltd.

Customer Support Team

Website: <http://www.drtech.co.kr>

E-mail: drtech@drtech.co.kr

Tel: +82-31-779-7448

Fax: +82-31-779-7490

Definition of Symbols

















Symbols	Description
	Non-ionized radiation
	The Waste Electrical and Electronic Equipment Regulations indicate separate collection for electrical and electronic equipment.
	Protective Earth (Ground)
	Direct Current
	Alternating Current
	Equipotentiality
	Power Off
	Power On
	Read and understand all instructions and warning labels in the product documentation before using the equipment. Keep this manual for future reference.
	Product contains specific materials that are suitable for recycling.
	Should be treated with care because if mistreated it might explode.
	Keep away from fire and flames.
	Heavy loading is prohibited.
	Authorized representative in the European Community
	Serial Number
	Date of manufacture
	Manufacturer
Rx Only	For U.S.A standards Federal law restricts this device to sale by or on the order of a licensed practitioner
CE 0120	For European Union (EEC Countries) This mark shows that product is in compliance with the essential requirements and other relevant provisions of Directive 93/42/EEC and "0120" shows the notified body number for MDD.

Table of Contents

MANUAL INFORMATION	2
1. SAFETY AND REGULATORY INFORMATION	7
1.1 MEDICAL EQUIPMENT SAFETY STANDARDS.....	18
1.1.1 Medical Equipment Classification.....	18
1.1.2 Product Safety Standards.....	18
1.2 DECLARATION OF CONFORMITY	20
1.2.1 Declaration of Conformity for EU Area.....	20
1.2.2 FCC Compliance Statement.....	22
1.3 LABELS AND MARKINGS ON THE EQUIPMENT	23
1.3.1 Detector.....	23
1.3.2 Other components	25
1.3.2.1 Battery Charger	25
1.3.2.2 Battery pack	25
1.3.2.3 EVS-WPCS	25
1.4 PRECAUTIONS REGARDING ELECTROMAGNETIC WAVES.....	26
2. DETECTOR SPECIFICATIONS	28
2.1 MAIN SPECIFICATIONS	29
2.1.1 Detector.....	29
2.1.2 Battery Charger.....	34
2.1.3 Battery Package	35
2.1.4 EVS-WPCS.....	36
2.2 CHARACTERISTICS.....	37
2.3 INTENDED USE.....	38
3. OPERATING PROCEDURE.....	40
3.1 NOTES FOR USING THE EQUIPMENT.....	40
3.1 SYSTEM CONFIGURATION.....	42
3.2 PARTS NAME AND FUNCTIONS.....	43
3.1.1 Product Components	43
3.1.1.1 Detector Components.....	44
3.1.1.2 EVS-CPDG Components.....	45
3.1.1.3 USB C to Lan Gender	46
3.1.1.4 Battery Charger Components.....	47
3.1.1.5 Battery Pack Components.....	47
3.1.1.6 Charging Battery Pack.....	47
3.1.1.7 EVS-WPCS Components.....	50
3.1.4 Additional Function.....	51

3.1.4.1 AED Mode.....	51
3.1.4.2 Recommendation of setting AED Sensing Area.....	53
3.3 ENVIRONMENTAL REQUIREMENTS	54
3.3.1 Specifications of Workstation (Minimum and Recommended PC Requirements).....	54
3.3.2 Recommended Specifications of Grid.....	55
3.3.3 Recommended Exposure Condition.....	55
3.4 BEFORE USING THE DETECTOR.....	56
3.5 OPERATING THE DETECTOR.....	57
3.5.1 Genral Workflow.....	57
3.5.2 Operating the detector	58
3.5.2.1 Powering on the detector	58
3.5.2.2 Register the detector and make connection to the EVS control system	58
3.5.2.3 Conduct examination	59
3.6 POWERING OFF THE DETECTOR.....	61
3.7 DETECTOR STATUS LIST	61
3.7.1 Detector Status List.....	61
3.7.2 Power Mode Indicator.....	62
3.7.3 Signal Strength Indicator.....	62
3.7.4 Battery Remains Indicator.....	63
3.8 ADDITIONAL FUNCTION.....	63
3.8.1 Lossless AED/AWC Mode.....	64
3.8.1.1 Recommendation of setting AED Sensing Area.....	66
3.9 PRODUCT INSTALLATION	67
3.9.1 Connecting Device	67
3.9.1.1 Operating AP	67
4. TROUBLE SHOOTING.....	69
5. MAINTENANCE.....	70
5.1 DAILY INSPECTION AND MAINTENANCE	70
5.2 REGULAR INSPECTION AND MAINTENANCE	70
5.3 IRREGULAR INSPECTION AND MAINTENANCE	70
6. PACKAGING.....	71
7. REVISION HISTORY.....	72

1. Safety and Regulatory Information







Intended Use

The EVS 4343W / EVS 4343WG / EVS 3643W / EVS 3643WG / EVS 4343WP / EVS 3643WP Digital X-ray detector is designed as a digital imaging solution, for providing radiographic diagnosis of the human anatomy. This device is intended to replace film or screen based radiographic systems in all general purpose diagnostic procedures. This device is not intended for mammography applications.

Safety Notices

Follow the safety instructions in this manual along with the following warning and cautions signs. Ignoring instructions, warnings, or cautions while handling the product may result in serious injury, accident, or product damage. To avoid any accident causing personal injury or product damage, be sure to read this manual carefully before using the product.

Safety Symbols

 WARNING AVERTISSEMENT	This indicates a potentially hazardous situation which may cause serious personal injury, death or substantial product damage if misused. Cette notice est utilisée pour désigner les conditions dans lesquelles une utilisation incorrecte du produit peut causer la mort ou des blessures graves.
 CAUTION MISE EN GARDE	This indicates a potentially hazardous situation which may cause minor personal injury if misused. Cette notice est utilisée pour désigner les conditions dans lesquelles une utilisation incorrecte du produit peut causer des blessures mineures.
CAUTION MISE EN GARDE	This indicates a potentially hazardous condition which may cause product damage. Cette notice est utilisée pour désigner les conditions dans lesquelles une utilisation incorrecte du produit peut causer des dommages matériels.
 PROHIBITED INTERDICTION	This indicates a prohibited operation.
 IMPORTANT	This indicates an action that must be performed.
 IMPORTANT	This indicates important operations and restrictions. Be sure to check this sign to prevent product damage or malfunction.
	This indicates the information about the basic operations of the detector for its user's reference. Users are recommended to read this notice.

Installation and Environment of Use Installation et environnement d'utilisation



WARNING

AVERTISSEMENT



**PROHIBITED
INTERDICTION**

- **Do not operate or store the X-ray detector in or around flammable chemicals or substances such as alcohol, thinner, benzene, etc.**
N'utilisez pas et n'entrez pas l'appareil à proximité de produits chimiques inflammables tels que de l'alcool, des diluants, de la benzène, etc.
- **If chemicals are spilled or evaporated, it may result in fire or electric shock, caused by their contacts with electric parts inside the detector. Some disinfectants are also flammable. Be cautious when using them.**
Si des produits chimiques sont renversés ou s'évaporent, cela peut provoquer un incendie ou une électrocution par contact avec des pièces électriques à l'intérieur de l'appareil. En outre, certains désinfectants sont inflammables. Assurez-vous de faire attention lorsque vous les utilisez.
- **Do not connect the detector to any component, other than DRTECH's specified components. Doing so may result in fire or electric shock.**
Ne connectez pas l'appareil à une source d'alimentation autre que celle fournie avec cet appareil. Cela risque de provoquer un incendie ou un choc électrique.
- **Do not install the equipment in any of the locations listed below. Doing so may result in fire, personal injury, or malfunction of the equipment.**
N'installez pas l'appareil dans l'un des emplacements énumérés ci-dessous. Cela pourrait entraîner une défaillance ou un dysfonctionnement de l'appareil, un incendie ou des blessures.
 - Close to fluid or places where fluids is used
Près des installations où l'eau est utilisée
 - Where it may be exposed to direct sunlight
à la lumière directe du soleil
 - Close to the air outlet of an air-conditioner or ventilation equipment
Près de la sortie d'air d'un climatiseur ou d'un appareil de ventilation
 - Close to heat sources such as a heater
Près d'une source de chaleur telle qu'un radiateur
 - Where the power supply is unstable
Là où l'alimentation est instable
 - In a saline or sulfurous environment
En milieu salin ou sulfureux
 - Where temperature or humidity is high
Là où la température ou l'humidité est élevée
 - High condensation or extreme cold environment
en cas de gel ou de condensation
 - In area prone to vibration
Dans les zones sujettes aux vibrations
 - On an incline or in an unstable area
Sur une pente ou dans une zone instable

- **Because the equipment cable is long, take care that cables do not become tangled during use. Also, be careful not to get your feet caught in the cable.**

Otherwise, it may cause a malfunction of the equipment or the injury of the user due to tripping over the cable.

En raison de la longueur du câble de l'appareil, veillez à ce que les câbles ne s'emmêlent pas pendant l'utilisation. Veillez également à ne pas vous coincer les pieds dans le câble.

Sinon, cela risque de provoquer un dysfonctionnement de l'appareil ou des blessures de l'utilisateur s'il trébuche sur un câble.

- **Non-medical equipment such as the battery charger, and access point unit cannot be used in patient's vicinity.**

Les appareils non médicaux tels que le chargeur de batterie et l'unité de point d'accès ne peuvent pas être utilisés à proximité du patient.

<Patient Vicinity>
<Proximité avec le patient>

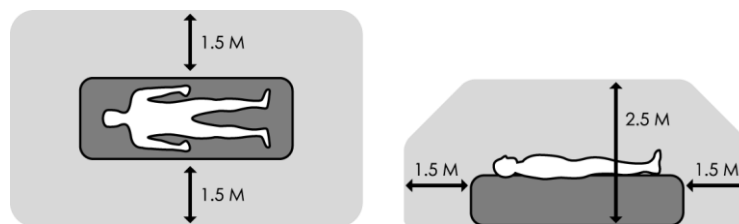

Power Supply Alimentation électrique



WARNING

AVERTISSEMENT



PROHIBITED
INTERDICTION

- **Do not operate the detector using any type of power supply other than the one indicated on the rating label. Otherwise, it may result in fire or electric shock.**
N'utilisez pas l'appareil avec un type d'alimentation autre que celui indiqué sur l'étiquette. Sinon, cela risque de provoquer un incendie ou un choc électrique
- **Do not handle the detector with wet hands. You may experience an electric shock that could result in serious physical injury or death.**
Ne manipulez pas l'appareil avec les mains mouillées.
Vous pourriez subir un choc électrique pouvant entraîner la mort ou des blessures graves.
- **Do not place heavy objects such as medical equipments on cables and cords. Do not pull, bend, bundle, or step on them. These precautions are required to be followed to prevent cable and cord sheaths from being peeled. Do not alter the cables and cords. Otherwise, it may damage the cords which could result in fire or electric shock.**
Ne placez pas d'objets lourds tels que des appareils médicaux sur les câbles d'alimentation, ne tirez pas dessus, ne les pliez pas, ne les regroupez pas et ne marchez pas dessus pour éviter d'endommager la gaine. Ne les modifiez pas non plus. Cela risque d'endommager les câbles et provoquer un incendie ou un choc électrique
- **Do not supply power to more than one device simultaneously by using the same AC outlet. Otherwise, it may result in fire or electric shock.**
N'alimentez pas plus d'un appareil utilisant la même prise secteur. Cela risque de provoquer un incendie ou un choc électrique.
- **Do not turn on the system power when condensation has formed on the detector. Otherwise, it may result in fire or electric shock.**
Ne branchez pas l'alimentation du système lorsque de la condensation s'est formée sur l'appareil. Cela risque de provoquer un incendie ou un choc électrique
- **Do not connect multiple portable socket-outlets or extension cords to the system. Otherwise, it may result in fire or electric shock.**
Ne connectez pas plusieurs prises secteur portables ou rallonges au système. Cela risque de provoquer un incendie ou un choc électrique.



- **Securely plug the power cord into the AC outlet.**
Branchez fermement le cordon d'alimentation dans la prise secteur.
- **If contact failure occurs, or if dust or metal objects come into contact with the exposed metal prong of the plug, fire or electric shock may result.**
En cas de défaillance du contact, ou si de la poussière ou des objets métalliques entrent en contact avec la broche métallique exposée de la fiche, il y a risque d'incendie ou de choc électrique.
- **Be sure to turn OFF the power before connecting or disconnecting the cords. Otherwise, you may get an electric shock that could result in death or serious injury.**
Assurez-vous que tous les appareils sont hors tension avant de connecter ou de déconnecter les câbles d'alimentation. Sinon, il y a risque de choc électrique pouvant entraîner la mort ou des blessures graves.
- **Be sure to hold the plug or connector when disconnecting the cord. If you pull the cord, the core wire may be damaged, resulting in fire or electric shock.**
Assurez-vous de tenir la fiche ou le connecteur pour débrancher le câble d'alimentation. Si vous tirez sur le câble d'alimentation, vous risquez d'endommager le fil central et provoquer un incendie ou un choc électrique.
- **To avoid the risk of electric shock, this equipment must only be connected to supply mains with protective earth.**
Pour éviter tout risque de choc électrique, cet appareil ne doit être branché qu'à une prise secteur avec terre de protection ».
- **To make it easy to disconnect the plug at any time, avoid putting any obstacles near the outlet. Otherwise, it may not be possible to disconnect the plug in an emergency.**
Pour faciliter le débranchement de la fiche à tout moment, évitez de placer des objets à proximité de la prise secteur. Sinon, il pourrait ne pas être possible de débrancher la fiche en cas d'urgence.
- **Be sure to ground the equipment to an indoor grounded connector. Also, be sure to connect all the earth connections for the system to a common ground.**
Assurez-vous de relier l'appareil à la terre avec un connecteur mis à la masse à l'intérieur. Assurez-vous également que toutes les mises à la masse du système sont connectées à une masse commune.
- **The product has lower breaking capacity type. So do not install at the building power system prospective short-circuit current exceeding 16 A.**
Les produits ont une capacité de coupure plus faible. Donc, ne pas installer dans le système électrique du bâtiment un courant de court-circuit présumé supérieur à 16 A
- To make it easy to disconnect the plug at any time, avoid putting any obstacles.

Battery Pack and Charger



WARNING

AVERTISSEMENT



- Do not use the battery pack as a power source for equipment other than EVS 4343W / EVS 4343WG / EVS 3643W / EVS 3643WG detector. Be sure to use the battery pack dedicated to the EVS 4343W / EVS 4343WG / EVS 3643W / EVS 3643WG detector.
- The battery charger is designed for the dedicated battery pack. Do not use the battery charger other than the dedicated one. Ignoring this may result in a battery explosion or a battery leak causing fire or electrical shock.
- Do not operate the battery charger using any type of power supply, other than the one indicated on the rating label.
- Do not handle the product with wet hands.
- Do not use the battery if battery connector is wet or moist.
- Do not attempt to disassemble, alter, or apply heat to the product.
- Avoid dropping or subjecting the product to severe impacts. To avoid the risk of injury, do not touch the internal parts of the battery if it has been cracked.
- Stop using the battery pack immediately if it emits smoke, a strange smell, or otherwise behaves abnormally.
- Do not let the battery pack and battery charger come into contact with water or other liquids and do not allow them to get wet.
- Do not clean with substances containing organic solvents such as alcohol, benzene, thinner, or other chemicals. Otherwise, fire or electrical shock may occur.
- Do not allow dirt or metal objects (such as hair pins, clips, staples or keys) to contact the terminals. Otherwise, battery explosion or leakage of electrolyte may occur, resulting in fire, injury or pollution of surrounding area. If the battery leaks and the electrolytes come into contact with your eyes, mouth, skin or clothing, immediately wash it away with running water and seek medical attention.
- Do not leave, store, or place the product in a location near heat sources, or in a place subject to direct sunlight, high temperature, high humidity, excessive dust, or mechanical shock. Otherwise, battery leakage, overheating or damage to the product may occur, resulting in electrical shock, burns, injury or fire.
- Do not attempt to use a battery pack that has deteriorated. Using a battery pack that has exceeded its life cycle may lead to overheating, fire or explosion.
- The Lithium ion/polymer battery is recyclable.
- Battery slowly discharges even if not in use.
- The useful battery life will be expired if it discharges immediately after being fully charged. You can purchase an optional battery pack to replace an exhausted one.
- The battery pack is a consumable item. If a fully charged battery is consumed quickly, use a new and fully charged battery pack.
- Be sure to charge the battery periodically (once a year) if it is not used for an extended period of time. The battery pack cannot be charged if it has been over discharged.

- Before discarding the battery pack, cover the terminals with adhesive tape or other insulators. Contact with other metal materials may cause fire or explosion.
- Remove battery pack from equipment which is unused for a few minutes to prevent discharge.

Handling Manutention



WARNING



**PROHIBITED
INTERDICTION**

- **The system, partially or in whole, cannot be modified in any ways without any written approval from DRTECH.**
Le système, partiellement ou intégralement, ne peut être modifié de quelque manière que ce soit sans l'accord écrit de DRTECH.
- **No modification of this equipment is allowed.**
Aucune modification de cet appareil n'est autorisée
- **Never disassemble or modify the equipment.**
Ignoring this warning may cause fire or electric shock, which may result in severe personal injury or death by touching the components that cause electric shock.
Ne jamais démonter ou modifier l'appareil.
Cela risque de provoquer un incendie ou un choc électrique. De plus, étant donné que l'appareil comprend des pièces susceptibles de provoquer une décharge électrique ainsi que d'autres pièces dangereuses, leur contact peut provoquer des blessures graves, voire mortelles.
- **Do not place any object on top of the equipment.**
The object may fall and cause an injury. If metal objects such as needles or clips fall into the detector or if liquid spills, it may result in fire or electric shock.
Ne placez rien sur l'appareil.
into the equipment, or if liquid is spilled, it may result in fire or electric shock.
L'objet peut tomber et causer des blessures. Également si des objets métalliques tels que des aiguilles ou des pinces tombent dans l'appareil, ou si un liquide y est renversé, cela risque de provoquer un incendie ou un choc électrique.
- **Do not hit or drop the equipment.**
The product may be damaged if it receives a strong jolt. Using a damaged detector without repair may result in fire or electric shock.
Ne cognez ni ne laissez tomber l'appareil.
L'appareil peut être endommagé s'il subit une forte secousse, ce qui peut provoquer un incendie ou un choc électrique si l'appareil est utilisé sans avoir été réparé.



- **Have the patient take a fixed posture and do not let patient touch the parts unnecessarily.**

If a patient touches connectors or switches, it may result in electric shock or malfunction of the detector.

Demandez au patient de prendre une position figée et ne le laissez pas toucher des composants.

Si le patient a touché des connecteurs ou des commutateurs, cela risque de provoquer un choc électrique ou un dysfonctionnement de l'appareil.

- **Do not spill liquid or chemicals onto the equipment. Especially in cases that the patient is injured, which requires the equipment to come in contact with blood or body fluids, protect the equipment with a disposable cover as necessary.**

Ne renversez pas de liquides ni de produits chimiques sur l'appareil ou, dans le cas où le patient serait blessé, évitez que l'appareil ne soit en contact avec du sang ou d'autres liquides organiques. Cela risque de provoquer un incendie ou un choc électrique

Dans une telle situation, protégez l'appareil avec un revêtement jetable, si nécessaire.

- **Turn OFF the power to each piece of equipment for safety when not being used.**

Débranchez chaque appareil pour des raisons de sécurité lorsqu'il n'est pas utilisé.

- **Handle the equipment carefully.**

Manipuler l'appareil avec soin.

- **Do not submerge the equipment in water.**

Ne pas plonger l'appareil dans de l'eau

- **The internal image sensor may be damaged if something hits against it, or if it is dropped, or receives a strong jolt.**

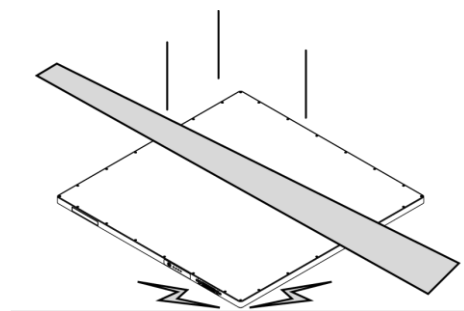

Le capteur d'image interne peut être endommagé si quelque chose le heurte ou si il tombe ou subit une forte secousse.



- **Be sure to use the detector on a flat surface to ensure that the detector is not bended. Otherwise, the internal image sensor may be damaged. Be sure to securely hold the detector while using it in upright position. Otherwise, the detector may fall over, resulting in personal injury, or may**

	<p>flip over, resulting in damage to the inner components.</p> <p>Veillez à utiliser le détecteur sur une surface plane pour ne pas le plier. Sinon, le capteur d'image interne risque être endommagé. Assurez-vous de tenir fermement le détecteur lorsque vous l'utilisez en position verticale. Sinon, le détecteur risque tomber et causer des blessures à l'utilisateur ou au patient, ou pourrait basculer et endommager le dispositif interne.</p> <ul style="list-style-type: none"> • Do not place excessive weight on the detector. Otherwise, the internal image sensor may be damaged. <p>Ne placez pas un objet lourd sur le détecteur. Sinon, le capteur d'image interne risque être endommagé.</p>
--	--

When a problem occurs
Lorsqu'un problème survient

 <p>WARNING AVERTISSEMENT</p>	
	<ul style="list-style-type: none"> • If any of the following problems occur, immediately turn OFF the power, unplug the power cord from the AC outlet, and contact your sales representative or local DRTECH dealer: Dans les cas suivants, mettez immédiatement chaque appareil hors tension, débranchez le câble d'alimentation de la prise secteur et contactez votre représentant commercial ou votre revendeur DRTECH: - When smoke, an odd smell or abnormal sound occurs. Quand il y a de la fumée, une odeur étrange ou un son anormal - When liquid has been spilled into the detector or foreign metal object has entered inside the detector. Lorsque du liquide a été renversé sur l'appareil ou qu'un objet métallique est entré par une ouverture. - When the equipment was dropped and damaged. Lorsque l'appareil est en panne et endommagé.

Maintenance and Inspection

Entretien et révision



WARNING

AVERTISSEMENT



**PROHIBITED
INTERDICTION**

- **When cleaning the detector, be sure to turn OFF the power and unplug the power cord from the AC outlet. Do not use alcohol, benzene, thinner or any other flammable cleaning agents. Otherwise, it may result in fire or electric shock.**

Lorsque l'appareil va être nettoyé, assurez-vous de le mettre hors tension et de débrancher le câble d'alimentation de la prise secteur. N'utilisez jamais d'alcool, de benzine, de diluant ou tout autre agent de nettoyage inflammable. Sinon, cela risque de provoquer un incendie ou un choc électrique.



- **Clean the plug of the power cord periodically by unplugging it from the AC outlet and removing dust or dirt from the plug. Clean the peripherals and AC outlet with a dry cloth.**

If the cord is kept plugged in for a long time in a dusty, humid or a sooty place, objects around the plug will attract moisture, and this could cause insulation failure that may result in a fire.

Nettoyez régulièrement la fiche du câble d'alimentation en la débranchant de la prise secteur et en retirant la poussière ou les saletés de la fiche, de sa périphérie et de la prise secteur à l'aide d'un chiffon sec. Si le câble reste longtemps branché dans un endroit poussiéreux, humide ou couvert de suie, la poussière autour de la fiche attirera l'humidité, ce qui risque de provoquer une défaillance de l'isolation pouvant causer un incendie.

- **For safety reasons, be sure to turn OFF the power when performing the inspections indicated in this manual. Otherwise, electric shock may occur.**

Pour des raisons de sécurité, assurez-vous que tous les appareils sont hors tension lorsque vous effectuez les révisions indiquées dans ce manuel. Sinon, cela risque de provoquer des chocs électriques.

Pediatric Patients



WARNING

AVERTISSEMENT

- Health care professionals and hospital administrators take special care in reducing radiation exposure to pediatric patients by following these steps:
- Discuss the rationale for the examination with the patient and/or parent to ensure a clear understanding of benefits and risks.
- Reduce the number of inappropriate referrals (i.e., justify X-ray imaging exams) by:
 - determining if the examination is needed to answer a clinical question,
 - considering alternate exams that use less or no radiation exposure, such as ultrasound or MRI, if appropriate, and
 - checking the patient's medical imaging history to avoid duplicate exams.
- Use the pediatric protocols or technique charts included as following table:

Table 1. Age categories

NAME	DEFINITION	FDA CODE
NEONATES	NEWBORNS UP TO ONE MONTH	NEO
INFANTS	ONE MONTH TO TWO YEARS	INF
CHILDREN	TWO YEARS TO TWELVE YEARS	CHI
ADOLESCENTS	TWELVE YEARS TO SIXTEEN YEARS	ADO
OTHER	OTHER AGE GROUP STUDIED	OTH



Table 2. Pediatric protocols

Age categories	NEONATES		INFANTS		CHILDREN		ADOLESCENTS		OTHER		Collimation size	Protection
	kVp	mAs	kVp	mAs	kVp	mAs	kVp	mAs	kVp	mAs		
Skull AP	60	10	70	10	75	12	70	16	70	20	8 x 10 or 10 x 12	chest, abdomen
Skull LAT	60	10	65	10	70	10	70	16	70	20	8 x 10 or 10 x 12	chest, abdomen
Chest PA	70	1	90	2	90	2	90	4	90	4	10 x 12 or 14 x 14	abdomen, gonadal
Chest LAT	80	2	90	2.5	95	2.5	100	4	100	4	10 x 12 or 14 x 14	abdomen, gonadal
Abdomen	50	4	60	6.3	70	6.3	75	20	75	25	10 x 12 or 14 x 14	thyroid, gonadal
Pelvis	50	4	60	6.3	70	6.3	75	20	75	25	10 x 12 or 14 x 14	gonadal

Please refer to the FDA website for details on pediatric information.
<http://www.fda.gov/Radiation-EmittingProducts/RadiationEmittingProductsandProcedures/MedicalImaging/ucm298899.htm>

1.1 Medical Equipment Safety Standards

1.1.1 Medical Equipment Classification

Type of protection against electrical shock	Class I ME Equipment
Degree of protection against electrical shock	Type B Applied Parts (Applied Part: Detector panel)
Degree of protection against ingress of water	IP54
Mode of operation	Continuous Operation
Flammable anesthetics	Not suitable for use in the presence of a flammable anesthetic mixture with air or with oxygen or nitrous oxide

1.1.2 Product Safety Standards

USA and Canada

ANSI/AAMI ES60601-1:2005/(R)2012 CAN/CSA-C22.2 No. 60601-1:14	Medical electrical equipment - Part 1: General requirements for basic safety and essential performance
IEC 60601-1-2 Ed.4: 2014	Medical electrical equipment-Part 1-2:Collateral standard: Electromagnetic compatibility-Requirements and tests

European Union

IEC 60601-1:2005 + C1:2006 + C2:2007 + A1:2012	Medical electrical equipment – Part1 : General requirements for Safety
EN 60601-1-2:2015	Medical electrical equipment–Part 1-2 : Collateral standard: Electromagnetic compatibility-Requirements and tests
IEC 60601-1-6 : 2010 + A1:2013	Medical electrical equipment –Part 1-6: General requirements for basic safety and essential performance – Collateral standard: Usability
IEC 62304:2006 + A1:2015	Medical device software–Software life cycle processes

IEC 62366:2007 + A1:2014	Medical device – Application of usability engineering to medical devices
EN ISO 14971:2012	Medical device – Application of risk management to medical devices

1.2 Declaration of Conformity

1.2.1 Declaration of Conformity for EU Area

DRTECH CORPORATION
 Suite No. 1, 1 Floor / Suite No. 2, 3 Floor, 29, Dunchon-Daero541beon-Gil,
 Jungwon-Gu, Seongnam-Si, Gyeonggi-do, Republic of Korea



Declaration of Conformity

<i>Product Name</i>	<i>Flat Panel Digital X-ray Detector</i>
<i>Model No.</i>	<i>EVS 4343W, EVS 4343WG, EVS 4343WP, EVS 3643W, EVS 3643WG, EVS 3643WP</i>
<i>Manufacturer</i>	<i>DRTECH CORPORATION : Suite No.1, 1 Floor / Suite No.2, 3 Floor, 29, Dunchon-Daero541beon-Gil, Jungwon-Gu, Seongnam-Si, Gyeonggi-do, Republic of Korea</i>
<i>Serial Numbers covered by this DoC</i>	<i>X¹X²X³X⁴X⁵X⁶X⁷X⁸X⁹X¹⁰X¹¹</i> <small>X¹ - Information of Model X² - Information of TFT panel X³ - Information of Function X⁴ - Information of MICOM</small>
<i>Accessories</i>	<i>Battery Pack (Model name: EVS-MBP-Y) Battery charger (Model name: EVS-BCS) Wireless Charging System (Model name: EVS-WPCS) Power adaptor (Model name: MANGO60S-USB-PDA) Power adaptor (Model name: AHM85PS12-XA) AC power cable</i>
<i>Hardware Version</i>	<i>EVS_GEN1.5_W POWER VER 0.5</i>
<i>Software Version</i>	<i>EVS_4343W_GEN_HW1.00.04_V1_SW0.0.01_1906271 EVS_4343WG_GEN_HW1.00.04_V1_SW0.0.01_1906271 EVS_4343WP_GEN_HW1.00.00_V1_SW0.0.01_1909271 EVS_3643W_GEN_HW1.00.04_V1_SW0.0.01_1906271 EVS_3643WG_GEN_HW1.00.04_V1_SW0.0.01_1906271 EVS_3643WP_GEN_HW1.00.00_V1_SW0.0.01_1909271</i>

We, DRTECH CORPORATION, declare under our responsibility that the above named products conform to the essential requirements of the following European Union Directives:

The object of the declaration described above is in conformity with the following requirement:

Radio Equipment Directive(RED) 2014/53/EU

The conformity assessment procedure referred to Article 10 detailed in Annex II of the Radio Equipment Directive 2014/53/EU has been followed. The following standards are those to which the product's conformance is declared, and by specific reference to the essential requirements of the referenced directives.:

<i>Health & Safety</i> <i>Article 3.1(a) of 2014/53/EU</i>	<i>EN 60601-1:2006 + A1:2013 + A12:2014 EN 62311:2008</i>
<i>EMC</i> <i>Article 3.1(b) of 2014/53/EU</i>	<i>EN 301 489-1 2.1.1 EN 301 489-17 3.1.1 EN 60601-1-2:2015</i>
<i>Spectrum</i> <i>Article 3.2 of 2014/53/EU</i>	<i>EN 300 328 2.1.1 EN 301 893 2.1.1 EN 300 440 2.1.1</i>

Signed for and on the behalf of DRTECH CORPORATION

<i>Name & Responsibility</i>	<i>Signature</i>	<i>Date</i>
<u>AN, SEONGHYUN</u> CEO	<u></u>	<u>15. 10. 2019</u> (oct)



Rev.00

The EVS 4343W / EVS 4343WG / EVS 4343WP / EVS 3643W / EVS 3643WG / EVS 3643WP may be operated in:

	BE	BG	CZ	DK	DE	EE	IE	EL
	ES	FR	HR	IT	CY	LV	LT	LU
	HU	MT	NL	AT	PL	PT	RO	SI
	SK	FI	SE	UK				

Abbreviations

Belgium (BE), Bulgaria (BG), Czech Republic (CZ), Denmark (DK), Germany (DE), Estonia (EE), Ireland (IE), Greece (EL), Spain (ES), France (FR), Croatia (HR), Italy (IT), Cyprus (CY), Latvia (LV), Lithuania (LT), Luxembourg (LU), Hungary (HU), Malta (MT), Netherland (NL), Austria (AT), Poland (PL), Portugal (PT), Romania (RO), Slovenia (SI), Slovakia (SK), Finland (FI), Sweden (SE) and United Kingdom (UK)

 WARNING	This device is restricted to indoor use in the 5150-5350MHz band.
---	---

1.2.2 FCC Compliance Statement

This device complies with Part 15 of the FCC Rules. Operation is subject to the following two conditions:

- (1) This device may not cause harmful interference, and
- (2) this device must accept any interference received, including interference that may cause undesired operation.

This equipment has been tested and found to comply with the limits for a Class A digital device, pursuant to Part 15 of the FCC Rules. These limits are designed to provide reasonable protection against harmful interference when the equipment is operated in a commercial environment. This equipment generates, uses, and can radiate radio frequency energy and, if not installed and used in accordance with the instruction manual, may cause harmful interference to radio communications. Operation of this equipment in a residential area is likely to cause harmful interference in which case the user will be required to correct the interference at his own expense.

FCC ID

FCC ID	Model	Remark
RYK-WUBR508N (Contains FCC ID)	EVS 4343W / EVS 4343WG / EVS 4343WP EVS 3643W / EVS 3643WG / EVS 3643WP	Component Modular Information Manufacturer: Sparklan Model Name: WUBR-508N
RNH-EVSWPCS	EVS WPCS	

WARNING

Changes or modifications not expressly approved by the party responsible for compliance could void the user's authority to operate the equipment. This transmitter must not be co-located or operating in conjunction with any other antenna or transmitter.

Specific absorption rate (SAR)

This device meets FCC limits for exposure to radio waves. It is designed not to exceed the limits for exposure to radio waves (radio frequency electromagnetic field) adopted by the Federal Communications Commission. This equipment should be installed and operated with minimum distance 0mm between the radiator & your body. The radio wave exposure guidelines use a unit of measurement known as the Specific absorption rate, or SAR. The SAR limits for mobile devices is 1.6W/kg. Tests for SAR are conducted using standard operation position with the device transmitting at its highest certified power level in all tested frequency bands. The highest SAR value under the FCC guidelines for this device model is listed below :

BODY SAR	0.210 W/kg
----------	------------

1.3 Labels and Markings on the Equipment

The EVS EVS 4343W / EVS 4343WG / EVS 3643W / EVS 3643WG detector and other components have labels and markings on them. Their contents and locations are indicated in the following chapters.



Any label removal or evidence of attempting to remove the label will void the warranty of the product.

1.3.1 Detector

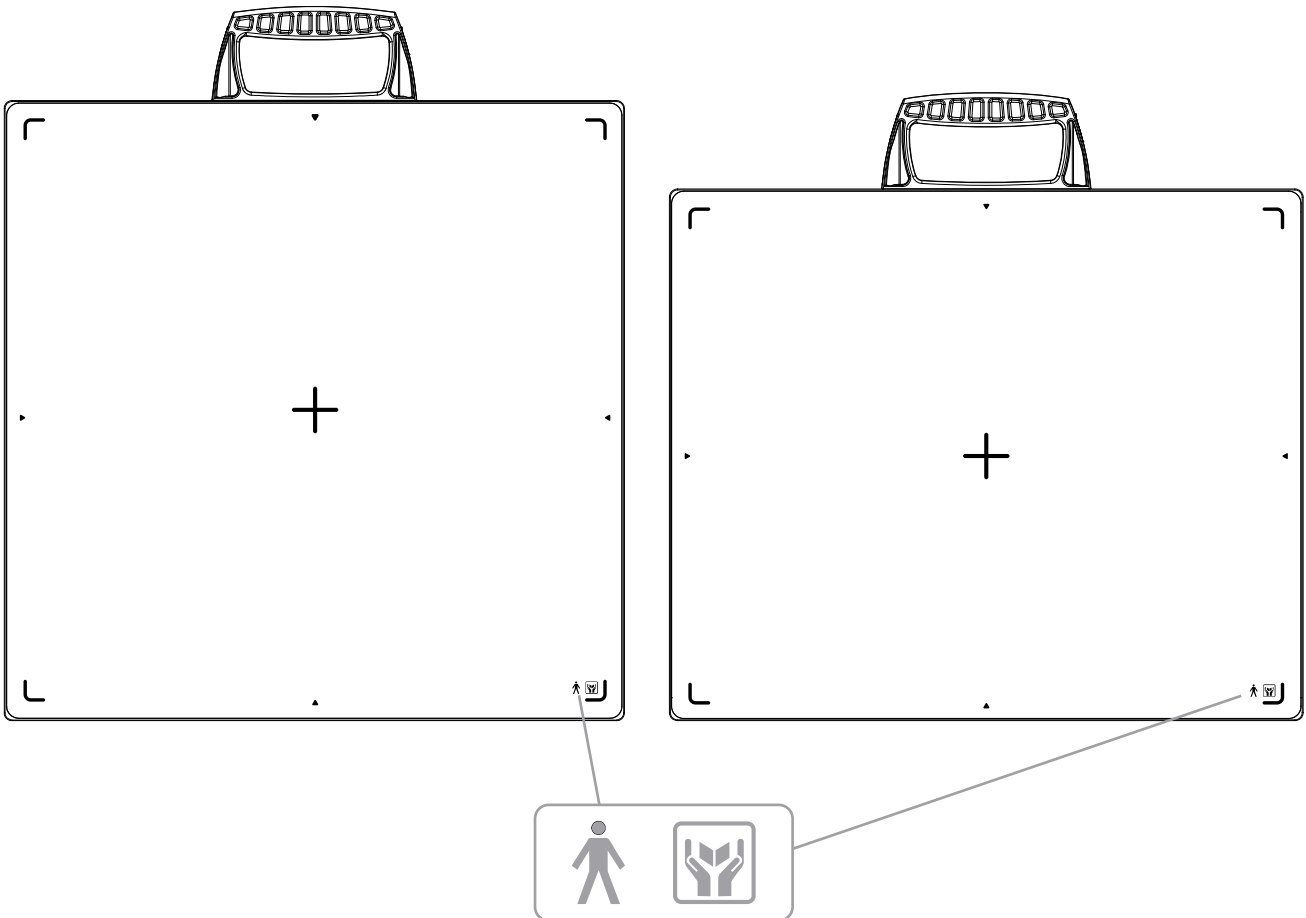

Figure 1. EVS 4343W & EVS 3643W Markings

	<p>This mark indicates that this is Type B Applied Part according to ANSI/AAMI ES60601-1 (2005) + AMD 1 (2012), CAN/CSA-C22.2 No. 60601-1 (2014) and EN 60601-1</p>
	<p>This Mark indicates that this equipment must be handled with care.</p>

DRTECH DRTECH Corporation
 Suite No. 1, 1 Floor / Suite No. 2, 3 Floor,
 29, Dunsan-dae-ro 54 Beon-gil,
 Jungwon-gu, Seongnam-si, Gyeonggi-do, Republic of Korea
 Tel : 82-31-739-8800 FAX: 82-31-739-8899
<http://www.drtech.co.kr>

Product Name : Flat Panel Digital X-ray Detector
 Model : EVS 4343W

Weight : 3.45kg (incl. battery)
 Dimension(WxLxH) : 460.0 x 460.0 x 15.0mm
 Power : Use only with MEGMEET (MANGOGOS-USB-PDA)

EC REP : DRTECH Europe GmbH
 Am Kronberger Hang 2, 65824 Schwalbach am Taunus, Germany

No field serviceable component inside. – Do not attempt to open the case.

Rx only

DRTECH DRTECH Corporation
 Suite No. 1, 1 Floor / Suite No. 2, 3 Floor,
 29, Dunsan-dae-ro 54 Beon-gil,
 Jungwon-gu, Seongnam-si, Gyeonggi-do, Republic of Korea
 Tel : 82-31-739-8800 FAX: 82-31-739-8899
<http://www.drtech.co.kr>

Product Name : Flat Panel Digital X-ray Detector
 Model : EVS 4343WG

Weight : 3.45kg (incl. battery)
 Dimension(WxLxH) : 460.0 x 460.0 x 15.0mm
 Power : Use only with MEGMEET (MANGOGOS-USB-PDA)

EC REP : DRTECH Europe GmbH
 Am Kronberger Hang 2, 65824 Schwalbach am Taunus, Germany

No field serviceable component inside. – Do not attempt to open the case.

Rx only

DRTECH DRTECH Corporation
 Suite No. 1, 1 Floor / Suite No. 2, 3 Floor,
 29, Dunsan-dae-ro 54 Beon-gil,
 Jungwon-gu, Seongnam-si, Gyeonggi-do, Republic of Korea
 Tel : 82-31-739-8800 FAX: 82-31-739-8899
<http://www.drtech.co.kr>

Product Name : Flat Panel Digital X-ray Detector
 Model : EVS 4343WP

Weight : 3.45kg (incl. battery)
 Dimension(WxLxH) : 460.0 x 460.0 x 15.0mm
 Power : Use only with MEGMEET (MANGOGOS-USB-PDA)

EC REP : DRTECH Europe GmbH
 Am Kronberger Hang 2, 65824 Schwalbach am Taunus, Germany

No field serviceable component inside. – Do not attempt to open the case.

Rx only

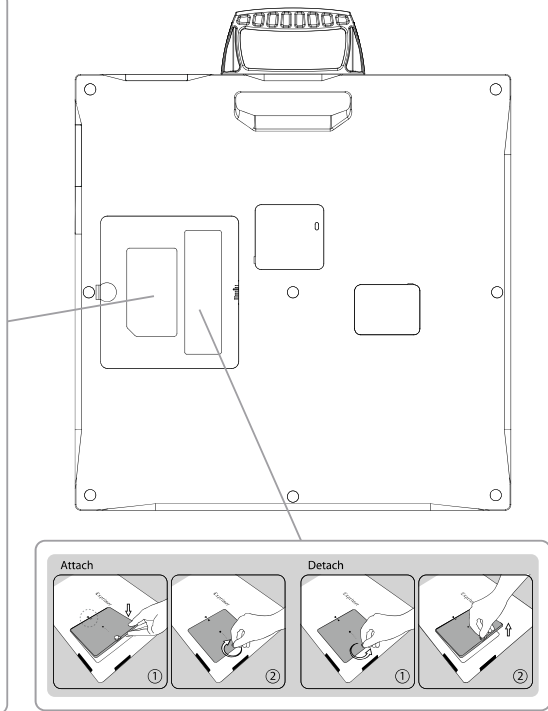

Figure 2. EVS 4343W Standard & Gadox Label

DRTECH DRTECH Corporation
 Suite No. 1, 1 Floor / Suite No. 2, 3 Floor,
 29, Dunsan-dae-ro 54 Beon-gil,
 Jungwon-gu, Seongnam-si, Gyeonggi-do, Republic of Korea
 Tel : 82-31-739-8800 FAX: 82-31-739-8899
<http://www.drtech.co.kr>

Product Name : Flat Panel Digital X-ray Detector
 Model : EVS 3643W

Weight : 2.98kg (incl. battery)
 Dimension(WxLxH) : 386.0 x 460.0 x 15.0mm
 Power : Use only with MEGMEET (MANGOGOS-USB-PDA)

EC REP : DRTECH Europe GmbH
 Am Kronberger Hang 2, 65824 Schwalbach am Taunus, Germany

No field serviceable component inside. – Do not attempt to open the case.

Rx only

DRTECH DRTECH Corporation
 Suite No. 1, 1 Floor / Suite No. 2, 3 Floor,
 29, Dunsan-dae-ro 54 Beon-gil,
 Jungwon-gu, Seongnam-si, Gyeonggi-do, Republic of Korea
 Tel : 82-31-739-8800 FAX: 82-31-739-8899
<http://www.drtech.co.kr>

Product Name : Flat Panel Digital X-ray Detector
 Model : EVS 3643WG

Weight : 2.98kg (incl. battery)
 Dimension(WxLxH) : 386.0 x 460.0 x 15.0mm
 Power : Use only with MEGMEET (MANGOGOS-USB-PDA)

EC REP : DRTECH Europe GmbH
 Am Kronberger Hang 2, 65824 Schwalbach am Taunus, Germany

No field serviceable component inside. – Do not attempt to open the case.

Rx only

DRTECH DRTECH Corporation
 Suite No. 1, 1 Floor / Suite No. 2, 3 Floor,
 29, Dunsan-dae-ro 54 Beon-gil,
 Jungwon-gu, Seongnam-si, Gyeonggi-do, Republic of Korea
 Tel : 82-31-739-8800 FAX: 82-31-739-8899
<http://www.drtech.co.kr>

Product Name : Flat Panel Digital X-ray Detector
 Model : EVS 3643WP

Weight : 2.98kg (incl. battery)
 Dimension(WxLxH) : 386.0 x 460.0 x 15.0mm
 Power : Use only with MEGMEET (MANGOGOS-USB-PDA)

EC REP : DRTECH Europe GmbH
 Am Kronberger Hang 2, 65824 Schwalbach am Taunus, Germany

No field serviceable component inside. – Do not attempt to open the case.

Rx only

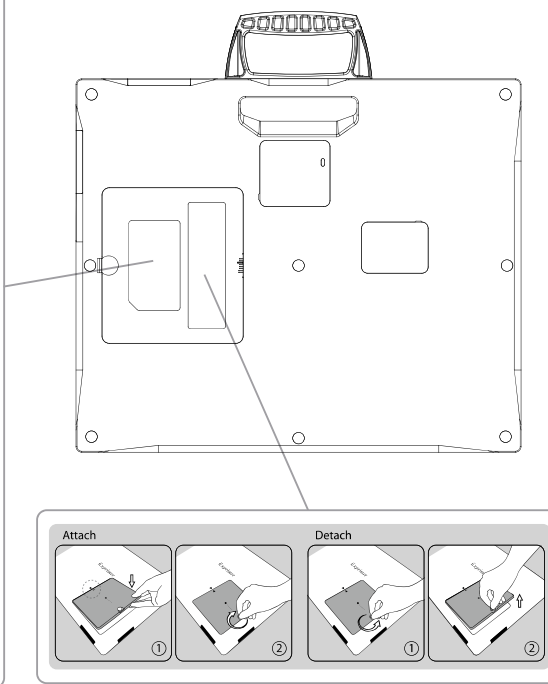

Figure 3. EVS 3643W Standard & Gadox Label



Caution: Do not jolt or apply excessive load.

1.3.2 Other components

1.3.2.1 Battery Charger

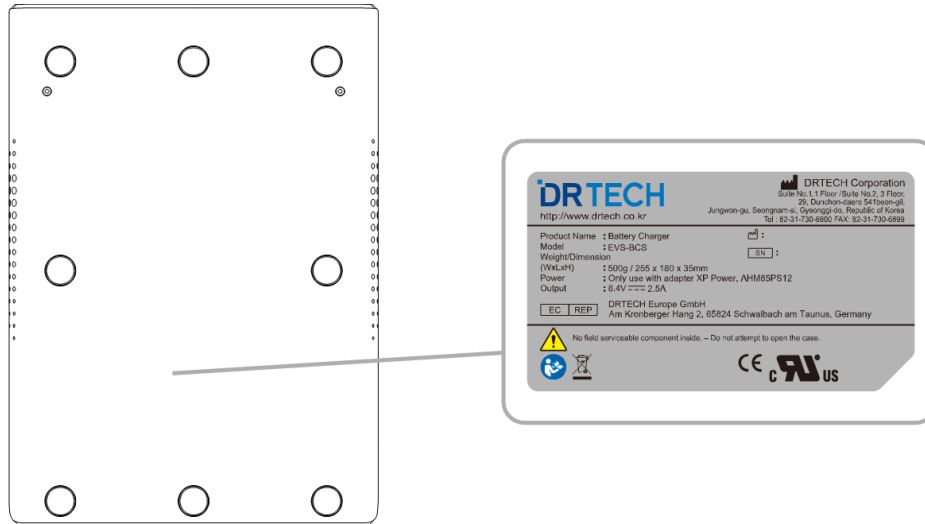

1.3.2.2 Battery pack

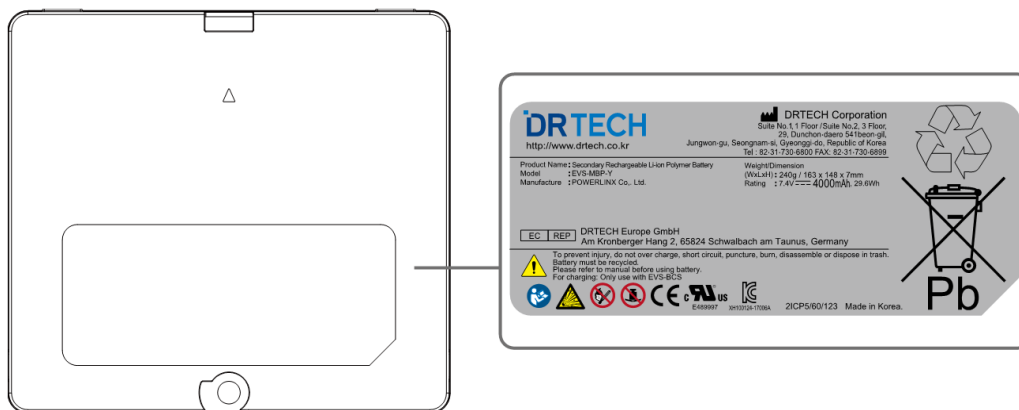

1.3.2.3 EVS-WPCS

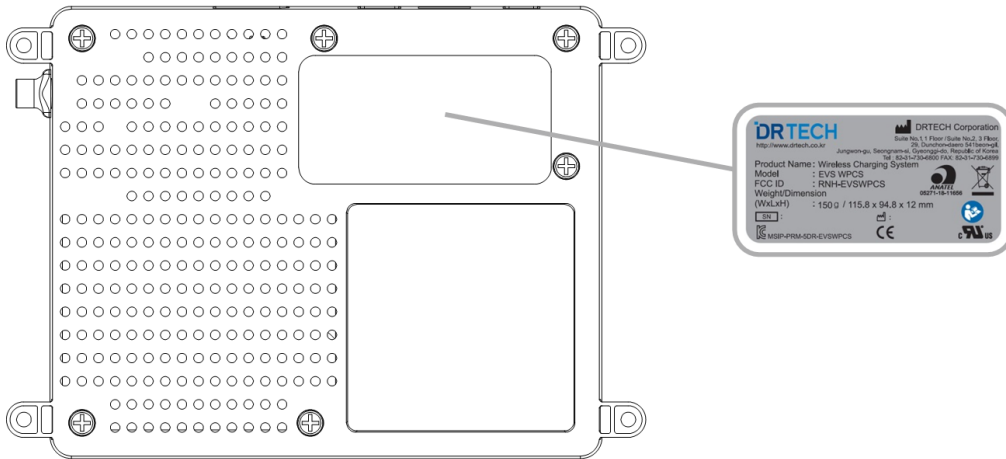

CAUTION
MISE EN GARDE

No field serviceable component inside - Do not attempt to open the case.
Mise en garde: Aucune composante réparable sur le terrain à l'intérieur -
N'essayez pas d'ouvrir le boîtier.

1.4 Precautions regarding electromagnetic waves

The Product is intended for use in the electromagnetic environment specified below. The user of the Product should assure that it is used in such an environment.

Emission Test	Compliance	Electromagnetic Environment - Guidance
RF emissions CISPR11	GROUP 1	The Product is suitable for use in all establishments other than domestic and those directly connected to the public low-voltage power supply network that supplies buildings used for domestic purposes.
RF emissions CISPR11	Class A	
Harmonic emissions IEC 61000-3-2	Class A	
Voltage fluctuations/ flicker emissions IEC 61000-3-3	Compliance	

Electromagnetic immunity

The Product is intended for use in the electromagnetic environment specified below. The user of the Product should assure that it is used in such an environment.

Immunity Test	IEC 60601 Test Level	Compliance Level	Electromagnetic Environment – Guidance
Electrostatic discharge(ESD) IEC 61000-4-2	±(2, 4, 8) kV contact ±(2, 4, 8, 15) kV air	±(2, 4, 8) kV contact ±(2, 4, 8, 15) kV air	Floors should be wood, concrete or ceramic tile. If floors are covered with synthetic material, the relative humidity should be at least 30%
Electrical fast transient/burst IEC 61000-4-4	±2 kV for power supply lines (100kHz PRF) ±1 kV for input/output lines(100kHz PRF)	±2 kV for power supply lines (100kHz PRF) ±1kV for input/output lines(100kHz PRF)	Mains power quality should be that of a typical commercial or hospital environment.
Surge IEC 61000-4-5	±1 kV line to line ±2 kV line to ground	±1 kV line to line ±2 kV line to ground	Mains power quality should be that of a typical commercial or hospital environment
Voltage dips, short interruptions and voltage variations on power supply input lines IEC 61000-4-11	0% U_T for 0.5 cycles at 0°, 45°, 90°, 135°, 180°, 225°, 270°, 315° 0% U_T for 1 cycles 40 % U_T for 5 cycles 70% U_T for 25/30 cycles 0% U_T for 250/300 cycles	0% U_T for 0.5 cycles at 0°, 45°, 90°, 135°, 180°, 225°, 270°, 315° 0% U_T for 1 cycles 40 % U_T for 5 cycles 70% U_T for 25/30 cycles 0% U_T for 250/300 cycles	Mains power quality should be that of a typical commercial or hospital environment. If the user of the EVS 4343W / EVS 4343WG / EVS 4343WP / EVS 3643W / EVS 3643WG / EVS 3643 WP requires continued operation during power mains interruptions, it is recommended that the EVS 4343W / EVS 4343WG / EVS 4343WP / EVS 3643W / EVS 3643WG / EVS 3643WPbe powered from an uninterruptible power supply

NOTE: U_T is the a.c. mains voltage prior to application of the test level.

Immunity Test	IEC 60601 Test Level	Compliance Level	Electromagnetic Environment – Guidance
Power frequency (50/60Hz) magnetic field IEC 61000-4-8	30 A/m	30 A/m	Power frequency magnetic fields should be at levels characteristic of atypical location in a typical commercial or hospital environment.
Conducted RF IEC 61000-4-6	3Vrms 150kHz-80MHz 6Vrms in ISM bands between 0.15 MHz and 80 MHz Amateur 80% AM at 1 kHz	3Vrms 150kHz-80MHz 6Vrms in ISM bands between 0.15 MHz and 80 MHz Amateur 80% AM at 1 kHz	The RF communications equipment should be used no closer to any part of the Product including cables, than the recommended separation distance calculated from the equation applicable to the frequency of the transmitter. Recommended separations distance
Radiated RF IEC 61000-4-3	10 V/m 80 MHz to 2700 MHz 80% AM AT 1 kHz	10 V/m 80 MHz to 2700 MHz 80% AM AT 1 kHz	$d=2.0\sqrt{P}$ 80 MHz to 2.7 GHz where P is the maximum output power rating of the transmitter in

			<p>watts (W) according to the transmitter manufacturer and d is the recommended separation distance in meters (m).</p> <p>Field strengths from fixed RF transmitters, as determined by an electromagnetic site survey^a, should be less than the compliance level in each frequency range^b.</p>
--	--	--	--

Note 1: At 80MHz and 800MHz, higher frequency range applies

Note 2: These guidelines may not apply in all situations. Electromagnetic propagation is affected by absorption and reflection from structures, objects and people.

	<p>WARNING AVERTISSEMENT</p>	<p>Use of Product adjacent to or stacked with other device should be avoided as it could result in improper operation. If such use is necessary, this product and the other device shall be observed to verify that they are operating normally.</p> <p>Il convient d'éviter l'utilisation des EVS 4343W / EVS 4343WG / EVS 4343WP / EVS 3643W / EVS 3643WG / EVS 3643WP à proximité d'un autre appareil ni posés sur ou sous un autre appareil, au risque de provoquer un dysfonctionnement. Si une telle utilisation est nécessaire, ce produit et l'autre appareil doivent être observés pour vérifier qu'ils fonctionnent normalement.</p> <p>Use of accessories, transducers and/or cables that are not specified or provided by the DRTECH of Product could result in increased electromagnetic emissions or decreased electromagnetic immunity of product and result in improper operation.</p> <p>L'utilisation d'accessoires, de transducteurs et/ou de câbles non spécifiés ou non fournis par le DRTECH de l'EVS 4343W /EVS 4343WG / EVS 4343WP / EVS 3643W / EVS 3643WG / EVS 3643WP peut entraîner une augmentation des émissions électromagnétiques ou une diminution de l'immunité électromagnétique du produit et un dysfonctionnement.</p> <p>Portable RF communications equipment(including peripherals such as antenna cables and external antennas) shall be used no closer than 30 cm(12 inches) to any part of the Product including cables specified by DRTECH.</p> <p>Les périphériques de communication RF portables (y compris les périphériques tels que les câbles d'antenne et les antennes externes) ne doivent pas être utilisés à moins de 30 cm (12 pouces) de toute partie de l'EVS 4343W / EVS 4343WG / EVS 4343WP / EVS 3643W / EVS 3643WG / EVS 3643WP, y compris les câbles fournis par DRTECH.</p>
---	----------------------------------	---

2. Detector Specifications

2.1 Main specifications

2.1.1 Detector



[Dimensional Diagram]

(Unit: mm)

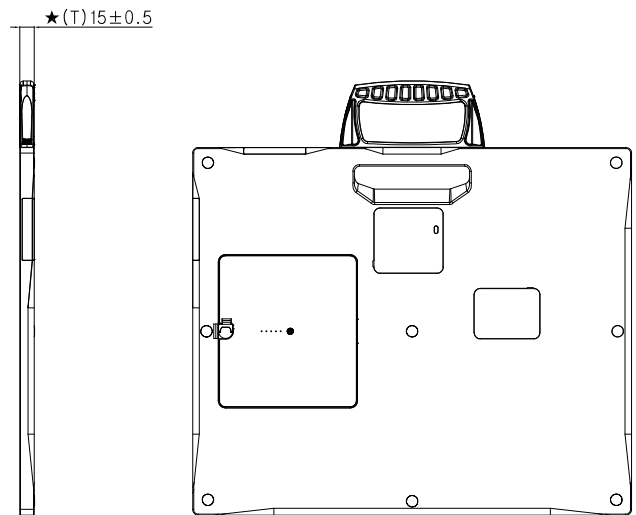
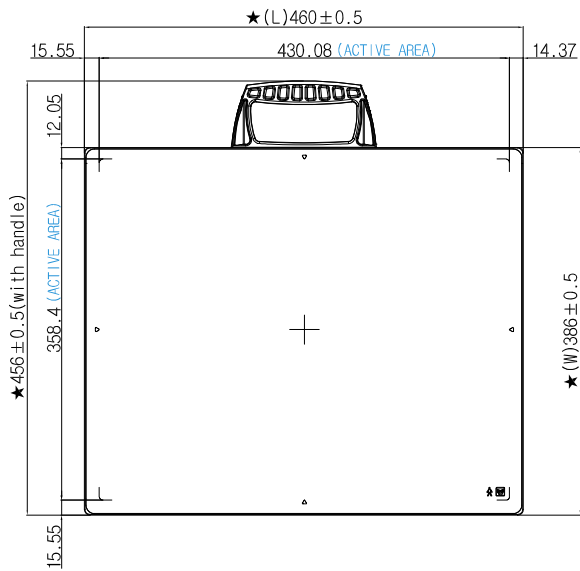
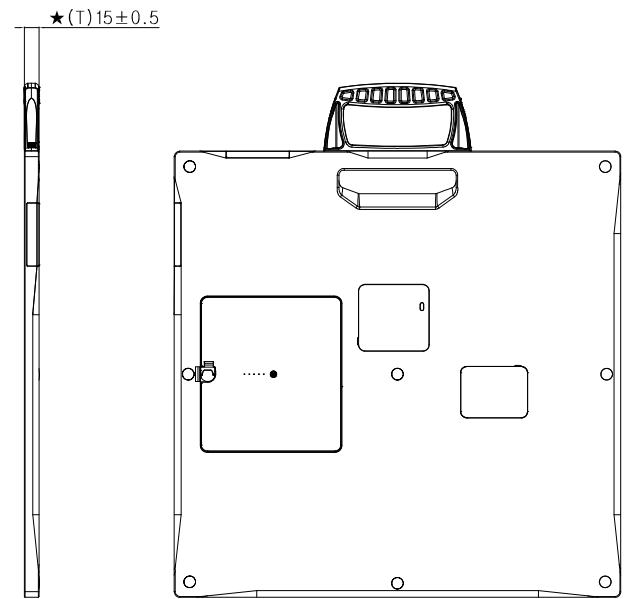
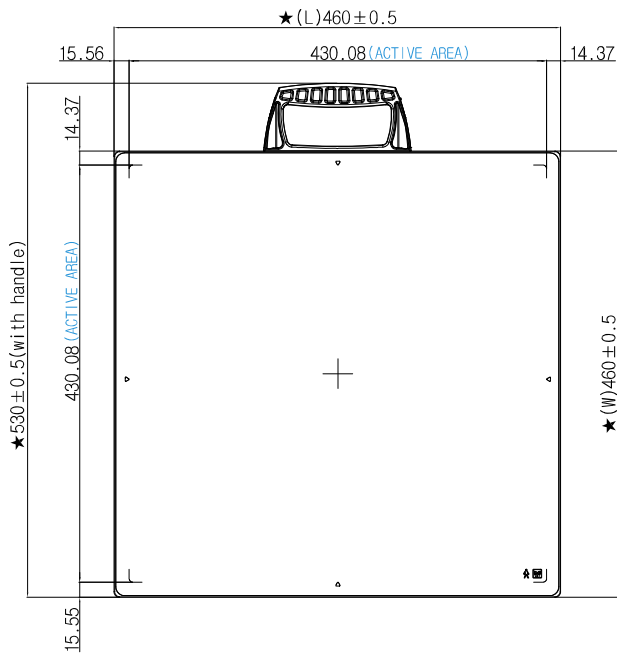

Figure 4. Detector Dimension

Detector Specifications

- Panel & Electronic

Item	Unit	Detail
Model	-	EVS 4343W / EVS 4343WG / EVS 4343WP EVS 3643W / EVS 3643WG / EVS 3643WP
Purpose	-	General Radiography
2D Matrix Array	-	EVS 4343W / EVS 4343WG / EVS 3643W / EVS 3643WG: a-Si TFT array EVS 4343WP / EVS 3643WP: IGZO TFT array
Scintillator	-	EVS 4343W / EVS 4343WP / EVS 3643W / EVS 3643WP: CsI (Cesium Iodide) EVS 4343WG / EVS 3643WG: Gadox (Gadolinium Oxysulfide)
Interface	-	Wireless: Gigabit Ethernet Wired: Lan Cable
Energy Range	kVp	40 – 150
Typical Dynamic Range	μGy	50
Active Area	mm	EVS 3643W(G): 358 x 430 EVS 4343W(G): 430 x 430
Pixel Pitch	μm	140
Resolution	pixel	EVS 3643W(G): 2,560 x 3,072 EVS 4343W(G): 3,072 x 3,072
Spatial Resolution	lp/mm	Min. 3.5
Image Acquisition Time	Sec.	< 5
A/D Conversion	Bits	16
Input Voltage	Volt	DC +15V, 3A MAX
Power Consumption	Watt	15 (Max)
Network Interface	-	WiFi / IEEE 802.11b,a,g,n
Power Supply	-	DC +15V, 3A MAX.

- **Performance**

Item	Unit	Detail	
Typical DQE	%	EVS 4343W	52.8 (@1.0lp/mm / @RQA5, 3.5μGy)
		EVS 4343WG	25.1 (@1.0lp/mm / @RQA5, 3.5μGy)
		EVS 4343WP	50.0 (@1.0lp/mm / @RQA5, 3.5μGy)
		EVS 3643W	53.3 (@1.0lp/mm / @RQA5, 3.5μGy)
		EVS 3643WG	25.9 (@1.0lp/mm / @RQA5, 3.5μGy)
		EVS 3643WP	53.1 (@1.0lp/mm / @RQA5, 3.5μGy)
Typical MTF	%	EVS 4343W	50.0 (@2.0lp/mm)
		EVS 4343WG	50.1 (@2.0lp/mm)
		EVS 4343WP	48.4 (@2.0lp/mm)
		EVS 3643W	42.5 (@2.0lp/mm)
		EVS 3643WG	47.8 (@2.0lp/mm)
		EVS 3643WP	42.9 (@2.0lp/mm)
Cycle time	Sec	8.5 ≤ sec. (※ EWT (X-ray window time) at 0.5sec.)	
X-ray Window	Sec	≤ 60 sec.	
Preview Time	Sec	≤ 1 sec.	
Frame Rate	-	1frame (Static mode)	
Data Output/Interface	-	Wireless: Gigabit Ethernet	
Antenna Gain (peak)	-	2.4GHz : 3.0dBi 5GHz : 5.0dBi	

- **Mechanical**

Item	Unit	Detail
Overall Dimension [±0.5 mm]	mm	EVS 4343W / EVS 4343WG / EVS 4343WP: 460 (H) × 483 (V) × 15.5 (D) EVS 3643W / EVS 3643WG / EVS 3643WP: 460 (W) × 409 (H) × 15.5 (D)
Weight	kg	EVS 4343W / EVS 4343WG / EVS 4343WP: 3.5 EVS 3643W / EVS 3643WG / EVS 3643WP: 2.98

- **X-ray System Requirements**

Contents		Requirements	
Generator	Power frequency	30 ~ 240 kHz	
	KV	40 ~ 150 kVp	
	mA Range	10 ~ 1000 mA	
	Exposure Time	0.001~10 sec	
	mAs Range	0.1~1000 mAs	
	Accuracy	± 5 %	
Bucky	Operating Type	Moving	Stepping Motor
			Spring
			CAM Motor type
			Static(Fixed)
Trey size (mm)	460 mm × 460 mm × 15.5 mm or higher		
Grid	Ratio	5:1, 6:1, 8:1, 10:1, 12:1, 15:1	
	Line	85 ~ 215 Line	
	SID	100 ~ 180 cm	

- **Reliability (Lifetime Dose)**

More than 120Gy (206.9uGy/1 shot x200 shot/1day x 25days/Month x 12month/year x 10years = 124.14Gy)

2.1.2 Battery Charger

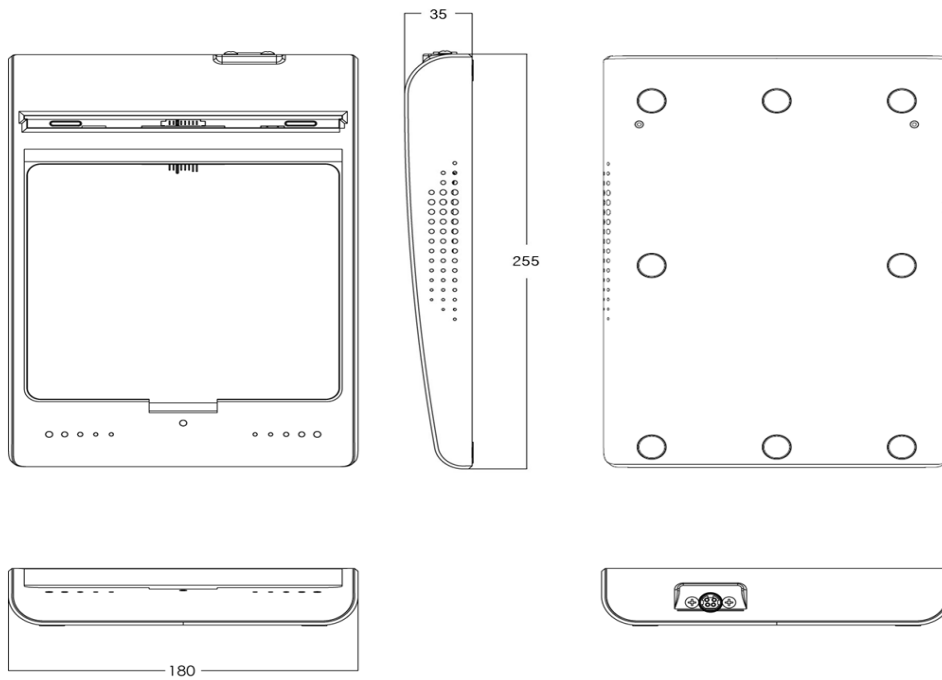

Item	Description
Model	EVS-BCS
Simultaneous Charging	Battery Pack 2 EA
Charging Time	3 hours
Rated Power Supply	DC +12 V, 6 A Max.
Dimensions (W x H x D)	180 mm x 255 mm x 35 mm
Weight	0.5 kg

2.1.3 Battery Package

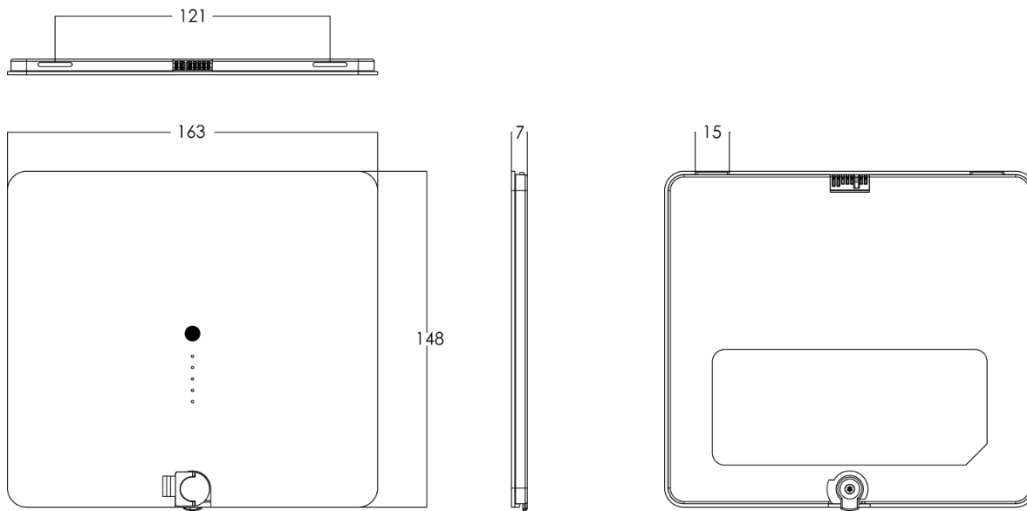

Item	Description
Model	EVS-MBP-Y
Cell Type	Lithium Polymer
Number of Cells	2S1P (2series 1 Parallel)
Rated Power Supply	Output : DC +7.4 V
Lifetime	Approx. 500 cycles of use (complete charge/discharges 1 cycle)
Dimensions (W x H x D)	163 mm x 148 mm x 7 mm
Weight	0.24 kg

2.1.4 EVS-WPCS

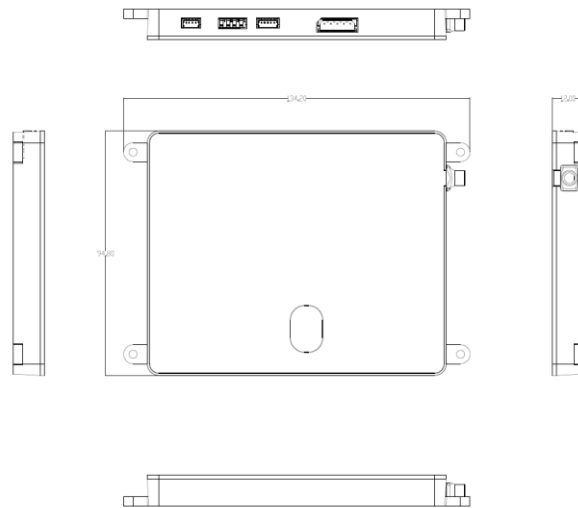

Item		Description	Note
Model		EVS-WPCS	
Dimensions (W x H x D)		115.8 mm x 94.8 mm x 12 mm	
Weight		0.15 kg	
Charging Transceiver IC		Freescale MWTC1012	Medium Power
Charging Receiver IC		Freescale MWPR1516	Medium Power
WPC Qi Specification		WPC MP-A2 Standard.	
Rx, Tx Distance	Coil to Coil	Typ. 4mm(±1mm)	Max. 8mm
	Center to Center	Typ. 4mm	Max. 8mm
Input Voltage		DC 12V (±10%) / over 3A or Adaptor(XP Power / AHM85PS12 / DC 12V, 7.08A)	Tx Module Input
Output Power		DC 10V /1.4A (14W)	Rx Module Output
Standby Current/Power		Typ. 27.22mA / 326.6mW	
Max Power Efficiency		83%	
Ambient Temperature	Storage Temperature	-20℃ ~ 85℃	
	Operating Temperature	0℃ ~ 35℃	

2.2 Characteristics

- **Typical Patient Doses**
 - Typical patient doses are equivalent to 500-1000 speed film/screen systems.
- **Sensitometric Characteristics and Dynamic Range**
 - EVS 4343W / EVS 4343WG EVS 4343WP / EVS 3643W / EVS 3643WG / EVS 3643WP wireless responds linearly against the exposure range for 500-1000 speed film/screen where it can depict the clinical information. It means that products fully cover a dynamic range of 0.2-20 μGy at least.
- **User Friendly OLED Display**
 - With its clear status indication, EVS 4343W / EVS 4343WG / EVS 4343WP / EVS 3643W / EVS 3643WG / EVS 3643WP's OLED Display provides various information at a glance. This function enables users to see the current status of the detector and the number of images stored in it to provide them better and more differentiated customer experience.

2.3 Intended Use

- Intended Patient Population**

Considerations		Requirement Description
Age		Paediatric to Geriatric
Health		Not relevant
Nationality		Multiple
Sex		Not relevant
Patient state	Patient is user	Patient is not user
	Patient is not user	Not relevant, unless patient is agitated

- Intended Part of the Body or Type of Tissue Applied to or Interacted with**

Measuring site: body

Condition: Intact or wound skin

- Intended User Profile (Operator Profile)**

Considerations		Requirement Description
Education	Minimum	<ul style="list-style-type: none"> At least a bachelor's degree in radiology
Knowledge	Minimum	<ul style="list-style-type: none"> Read and understand Western "Arabic numerals" written in Arial font Can distinguish human body Understands hygiene
Language understanding	Minimum	<ul style="list-style-type: none"> Understand the manual in English
Experience	Minimum	<ul style="list-style-type: none"> Licensed physician or other qualified medical professional
Permissible impairments	Minimum	<ul style="list-style-type: none"> Mild reading vision impairment or corrected vision to log MAR 0.2 Average degree of age-related short term memory impairment Impaired by 40 % resulting in 60 % of normal hearing at 500 Hz to 2 kHz



CAUTION
MISE EN GARDE

U.S. Federal Law restricts this device to the sale by or on the order of a licensed physician or other qualified medical professional

- **Intended Conditions of Use**

Considerations	Condition
Environment including hygienic requirements	<p><u>Operating conditions</u></p> <ul style="list-style-type: none"> - Temperature: +10 °C to +35 °C - Barometric Pressure: 700 hPa to 1060 hPa - Humidity: 20 % R.H. to 85 % R.H. <p><u>Storage and delivery conditions</u></p> <ul style="list-style-type: none"> - Temperature: -15 °C to +55 °C - Barometric Pressure: 500 hPa to 1060 hPa - Humidity: 10 % R.H. to 90 % R.H. <p>Non-sterile Multiple patient use Less than ten minute contact Indoor use only Ambient luminance range: 100 lx to 1500 lx Viewing angle: normal to the display ± 20°</p>
Frequency of use	1 day: 200 shot
Location	In hospital environment
Mobility	Portable ME equipment to be used on a patient

3. Operating Procedure

3.1 Notes for using the equipment

When using the equipment, take the following precautions. Otherwise, problems may occur and the equipment may not function properly.

EVS 4343WP /

System Diagnostic

The Ecali1 software generates a system diagnostic. Run Ecali1 software after installing the system and execute the program at least once a year. If an error occurs, report the detailed error information to DRTECH local dealer or distributor.



CAUTION
MISE EN GARDE

The owner is responsible for ensuring that the system diagnostic is performed at least once a year. Do not try to use the system if an error is detected.

Il incombe au propriétaire de s'assurer que la vérification du système est effectuée chaque année.

N'essayez pas d'utiliser le système si la vérification du système est négative.

Calibration

To ensure optimal performance of the system, it is important to verify that the system is calibrated.



CAUTION
MISE EN GARDE

The owner is responsible for ensuring that the system calibration is performed after the system installation is completed or the system is repaired. Do not try to use the system if system calibration is not performed.

Il incombe au propriétaire de s'assurer que l'étalonnage du système est effectué une fois l'installation du système terminée ou la réparation du système. N'essayez pas d'utiliser le système si l'étalonnage du système n'est pas effectué.

Before exposure

- Make sure to check the equipment daily and confirm that it works properly.
- When moisture-laden air comes into contact with a cold surface, it will cause condensation to form on the equipment. In this case, wait until the condensation evaporates before performing an exposure.
- If the equipment is used while the condensation formed on it, problems may occur in the quality of the captured image.
- When an air-conditioner is used, be sure to raise/lower the temperature gradually so that temperature changes will not affect the product and prevent condensation.

During exposure

- Do not use the detector nearby devices generating a strong magnetic field. Doing so may produce image noise or artifacts.

Electric Shock Hazards

- To reduce the risk of electric shock, the system must be connected to an electrical ground.
- A three-phase AC power cable is supplied with this system to provide the proper electrical grounding. The power cable must be plugged into an UL-approved three-contact electrical outlet.
- Do not disassemble or modify the product as it may result in fire or an electric shock. There are no operator serviceable parts or adjustments inside the system. Only a trained and qualified person should be permitted access to the internal parts of the system.
- If an APPLIANCE COUPLER or Mains Plug or other separable plug is used, functional isolation device should be used for safety.

Disinfection and cleaning

- Wipe it with a dry cloth slightly dampened with a neutral detergent.
- Do not use solvents such as alcohol, thinner or benzene. Doing so may damage the surface of the equipment.
- The power should be switched off and equipment should be unplugged before cleaning.
- The exterior of the array can be cleaned with common hospital decontamination solutions including 5% of ButylCellosolve. A 0.55% Benzalkonium Chloride, 0.63% Sodium Hypochlorite, or 70% alcohol solution can also be used. To apply the cleaning solution, power down the system and disconnect from the power source, moisten cloth with the solution, and wipe the panel.

Operating/storage environment

- Be sure to use and store the equipment under the conditions described below.

	Operation	Storage	Transit
Temperature	10 to 35°C	-15 to 55°C	-15 to 55°C
Humidity	20 to 85% RH (Without Condensing)	10 to 90% RH (Without Condensing)	10 to 90% RH (Without Condensing)
Atmospheric pressure	700 to 1060 hPa	500 to 1060 hPa	500 to 1060 hPa

- Do not expose the equipment to high temperatures and/or high humidity. This may cause the product to malfunction.
- When not in use, keep the detector, handle unit, and grid in a designated location or in a location where they are safe and cannot fall down.

Notes on disposal

- Disposal of this product in an unlawful manner may have a negative impact on health and on the environment. When disposing of this product, therefore, be absolutely sure to follow the procedure which is in conformity with the laws and regulations applicable in your area.
- Refer to lifetime dose at "2.1 Reliability (Lifetime Dose)".

Handling the equipment

- The equipment must be handled with care to avoid personal injury or damage to the internal image sensor.

3.1 System Configuration

The Product is used in system configuration as illustrated below.

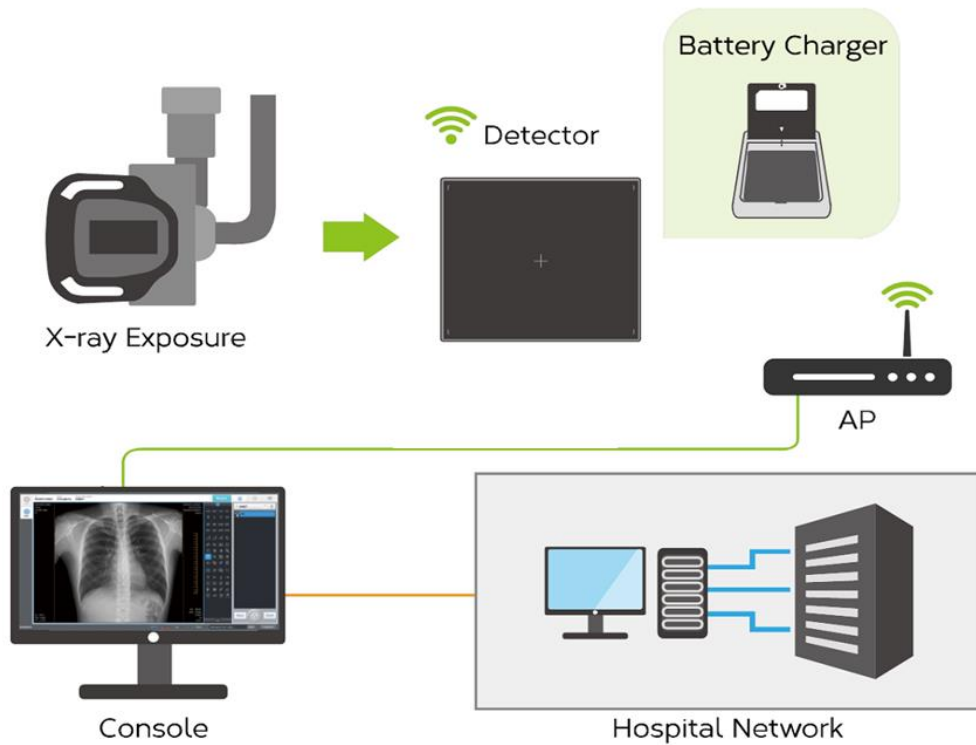

Figure 5. EVS W Series Single Detector Configuration



- **Do not connect other products to the remaining Lan port on the Ethernet Switching Hub. It may affect the image transmission of the detector.**
- **The following technical specifications represent recommended for the Ethernet Switching Hub.**
 - Supports 1000BASE-T or 1000BASE-TX
 - Supports full-duplex
 - Supports IEEE 802.3ab
 - More than 4 LAN Port Ethernet Hub

3.2 Parts Name and Functions

3.1.1 Product Components

Components	Model No.	Functions	Note
Flat Panel X-ray Detector	EVS 4343W EVS 4343WG EVS 4343WP EVS 3643W EVS 3643WG EVS 3643WP	Imaging device with Gigabit Ethernet signal interface to the operating PC	
Battery Charger (Incl. AC Power Adaptor, Power Cable)	EVS-BCS (Power Adaptor: AHM85PS12)	A device to charge a battery pack. Possible to charge two batteries packs simultaneously.	Power Cable: 2m
Battery Pack	EVS-MBP-Y	A device to supply power to the detector in Wireless Mode	2 EA
Wireless Charging System	EVS-WPCS	A device to wirelessly charge a battery pack that is attached to the detector	Optional Component
USB-C to Lan Gender with PD (Incl. Lan Cable)	EVS-CPDG	USB Type-C to LAN With USB power delivery or USB PD for a wired Internet connection.	Optional Component Lan Cable: 15m
Power Adaptor (Incl. AC Power Cable)	MANGO60S- USB-PDA	A device to supply power to a Battery Charger	Optional Component Power Cable: 2m
CD	Ecali1	Viewer software supports image acquisition, pre-view, calibration, and image correction. It can also support interface communications.	Document : User Manual (PDF) Calibration Data : MAP, PMP, GMP

Table 1 EVS W Series Components Information



WARNING

The use of accessories and cables other than those specified, with the exception of **EVS W Series** accessories and cables sold by DRTECH Co., LTD. as replacement parts for internal components, may result in increased emissions or decreased immunity of the equipment. Accessory equipment connected to the analog and digital interfaces must be certified according to the respective IEC standards. All combinations of equipment must be in compliance with IEC 60601-1 system requirements. Any person who connects additional equipment to the signal input or signal output ports configures a medical system, and is therefore responsible for ensuring that the system complies with the requirements of the system standard IEC 60601-1. If in doubt, consult DRTECH technical support representative.

L'utilisation d'accessoires et de câbles autres que ceux stipulés, à l'exception des accessoires et des câbles de la série EVS A vendus par DRTECH Co., LTD. en tant que pièces de rechange pour les composants internes, peut entraîner une augmentation des émissions ou une diminution de l'immunité de l'appareil. Les équipements accessoires connectés aux interfaces analogiques et numériques doivent être certifiés conformément aux normes CEI respectives. Toutes les combinaisons de l'appareil doivent être conformes aux exigences du système CEI 60601-1. Toute personne qui connecte un équipement supplémentaire aux ports d'entrée ou de sortie du signal configure un système médical et doit par conséquent s'assurer que le système est conforme aux exigences de la norme système CEI 60601-1. En cas de doute, consultez le représentant du support technique DRTECH.

3.1.1.1 Detector Components

The detector is designed to capture radiographic images. Captured images are transmitted to the image-capture computing using the wired data transfer.

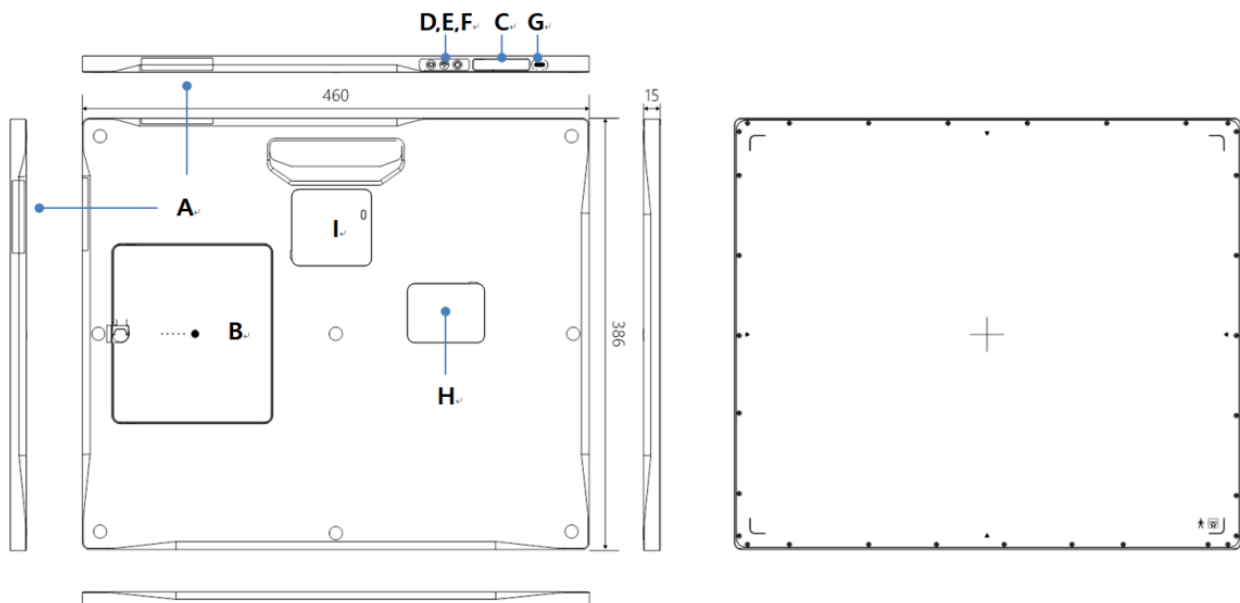

Figure 7. Detector Components

A. Wireless Antenna: Transmit image data with wireless communication (IEEE802.11n).

- B. Battery Pack: Supply electrical power to the detector while using wireless communication
- C. Status Indicators
 - Power: Show power on/off status of the detector.
 - Ready: Show data communication status and ready status of the detector
 - Light ON: Detector is ready
 - Light OFF: Detector is busy
 - Link: Show detector's registration and connection status.
 - AP: Lamp indicating Wired/ Wireless mode (5 GHz)
- D. Display Button : Use to change OLED screen
- E. AP Button: Can select different wireless connection options for the detector.
(Connection options: Wireless using AP/ Wireless using detector's internal AP/ Portable mode)
- F. Power Button: Turn Detector on/off
- G. Connector: power supply through a USB Type-C cable or Power adaptor
- H. Debugging Cover
- I. WPCS Window: Wireless Charging Rx Window

 Simultaneous blinking of LED lamps indicate a system error



WARNING
AVERTISS-EMENT

- Don't remove the item G and H. If the metal objects come into the case, it can lead to product malfunction. The operator should not make the patient contact inside of the access cover (G and H).

3.1.1.2 EVS-CPDG Components

3.1.1.3 USB C to Lan Gender

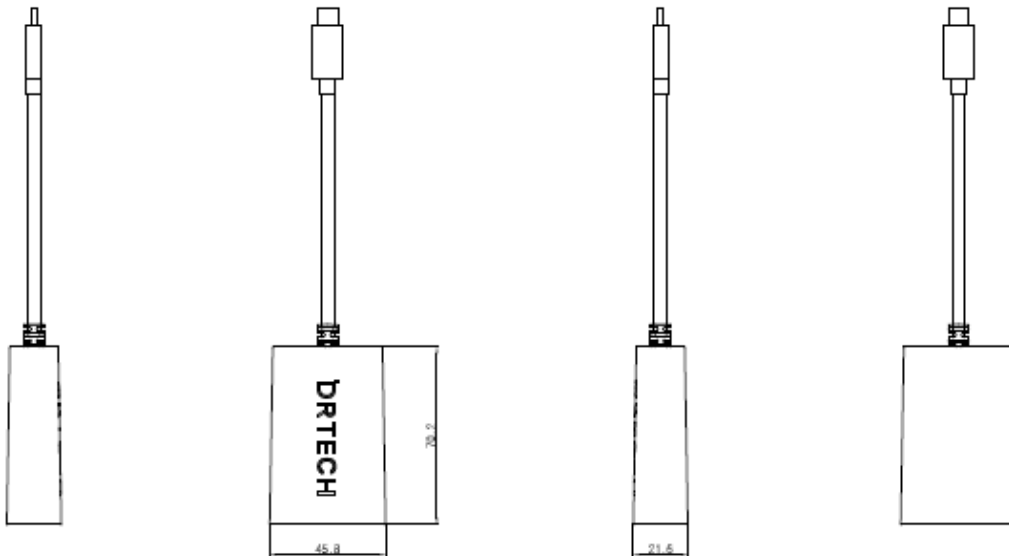

Item	Description
Model	EVS-CPDG
USB PD Specification	Support PD Ver3.0
USB Version	USB 2.0
Ethernet	Support 100/1000BASE-T
Dimensions (W x H x D)	45.8 mm x 70.2 mm x 21.6 mm
Weight	0.1 kg

3.1.1.4 Battery Charger Components

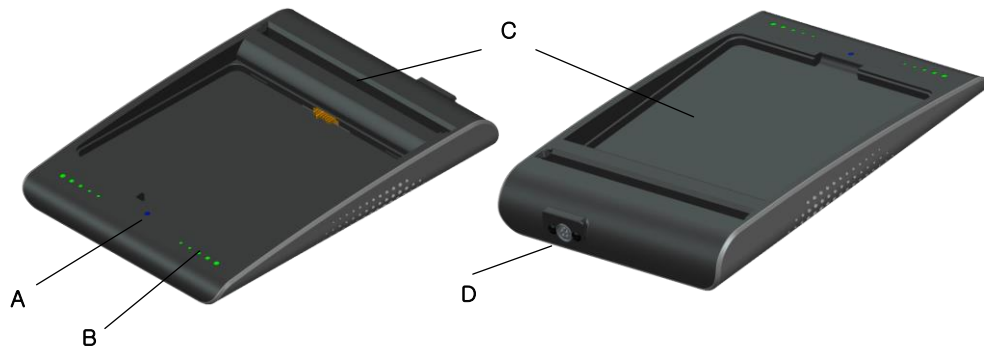

- A. Power Indicator : Indicate the power on/off status..
- B. Charging Indicator : Indicate the charging status.
- C. Battery Compartment : Insert the battery pack to charge.
- D. DC Input : Connect the DC Adaptor to supply electrical power to the battery charger

3.1.1.5 Battery Pack Components

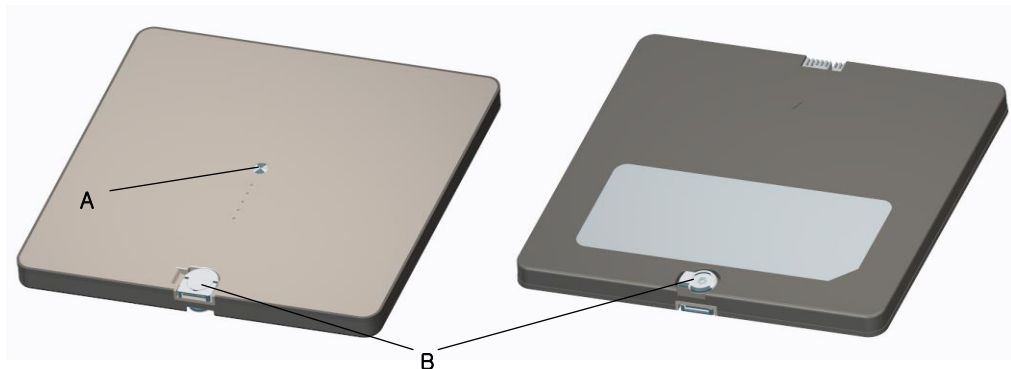





- A. Charging Indicator : Indicate the charging status
- B. Knob Latch : Rotate between on/off for battery swap

3.1.1.6 Charging Battery Pack

The battery pack supplies power to the detector. Be sure to use only the dedicated battery pack, and fully charge it before use.

- Connect the power adaptor to the DC Input port of the battery charger. The power LED light in blue indicates the direct current (DC) power is ON.
- Insert the battery pack into the battery charger. Charging starts automatically. The charge LED lights appear green when the battery pack is being charged. When the battery pack is completely charged, all levels of charge LEDs will illuminate.
- Gently pull the charged battery pack to remove it from the battery charger.

 WARNING AVERTISS-EMENT	<p>Securely plug the power cord into the power source. If contact failure occurs, or if dust or metal objects come into contact with the exposed metal prongs of the plug, fire or electrical shock may occur.</p>
 CAUTION MISE EN GARDE	<p>Be sure to stop charging the battery pack when the charge LED lights appear in green longer than the specified charging time. Not doing so may result in battery pack overheating, smoke emission, battery explosion, or fire. You must use the power adaptor that is certified with IEC 60950 or IEC 60601-1.</p>
 CAUTION MISE EN GARDE	<p>Do not insert the battery pack into the charger in the opposite direction. If battery pack insertion failure occurs, the connector of battery pack is broken and the battery pack may not be charged or it may be damaged by electrical shock.</p>
	<p>Two batteries can be charged at the same time. It takes approximately two hours to fully charge a battery pack. The required charging time may vary depending on the temperature and remaining battery level.</p>

How to Attach a Battery Pack

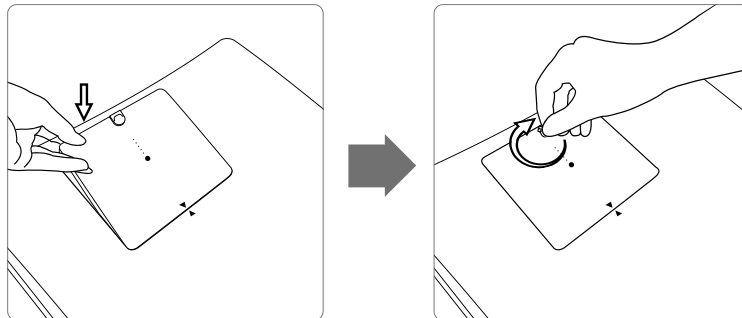

- 1) Align the arrows on the detector and battery pack.
- 2) Push down the battery pack.
- 3) Turn the battery lock knob 90 degrees clockwise.

How to Detach a Battery Pack

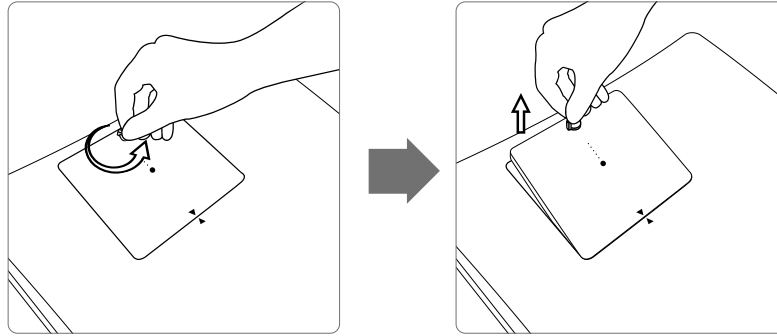

- 1) Turn the battery lock knob 90 degrees counter-clockwise.
- 2) Pull up the battery pack grabbing the knob.

 WARNING AVERTISS-EMENT	<ul style="list-style-type: none"> • Make sure to turn off the detector before detaching a battery pack. Press and hold the power button for about 2 seconds. All status LED lamps will be turned off when the detector is turned off. • Securely attach the battery into the detector or charger. If contact failure occurs, or if dust or metal objects come into contact with the exposed connector pins of the detector or charger, fire or electrical shock may occur.
--	---

How to Charge Battery Packs

Horizontal Direction (Attachment)

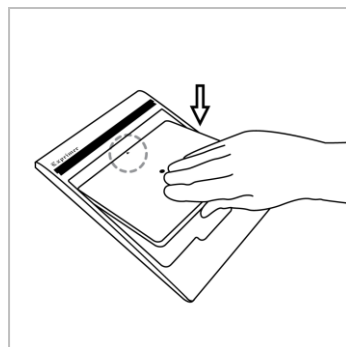

- Align the arrows on the charger and battery pack.
- Push down the battery pack.

Horizontal Direction (Detachment)

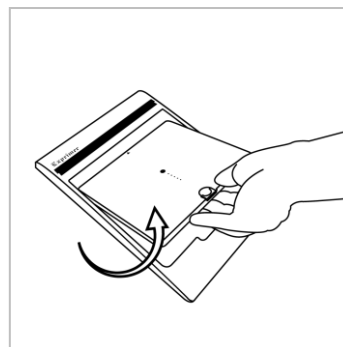

- Put the finger into the groove on the charger and grab the battery pack.
- Pull out the battery pack.

Vertical Direction (Attachment)

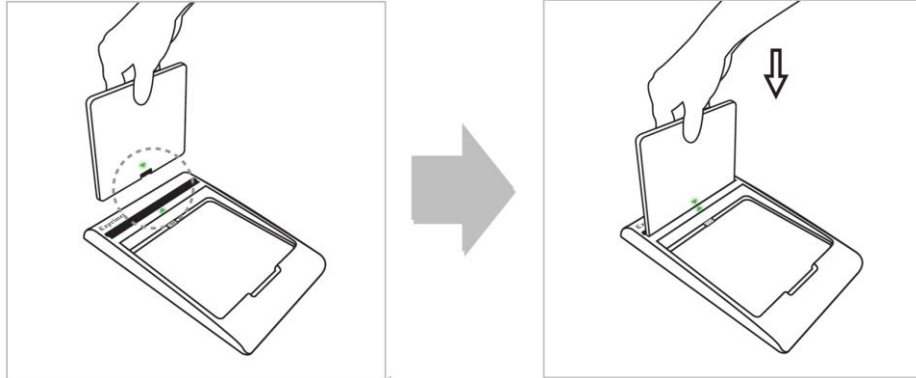

- Stand the battery pack upright to reveal the battery charged connector.
- Check the yellow-green arrows on the charger and bottom of the battery pack.
- Align the left and right side of battery pack to the charger.
- Push down the battery pack.

Vertical Direction (Detachment)

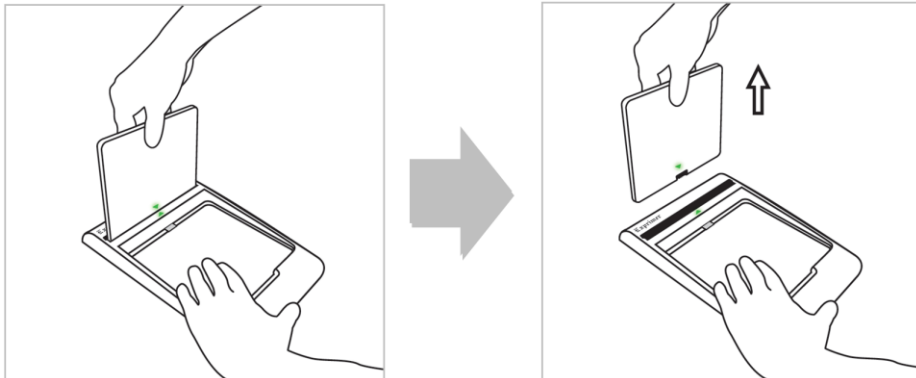

- Grab the battery pack.
- 2) Pull out the battery pack from the charger while holding the charger by the other hand.

3.1.1.7 EVS-WPCS Components



- ① EVS-WPCS Base
- ② RDA Window: IRDA communication window

- ③ Power Connection Cable
- ④ Debug Connector: For debugging
- ⑤ ID Switch: Device ID setting dip switch
- ⑥ Indicate LED Connector: For cradle (Optional)
- ⑦ Indicate LED Connector: For system (Optional)

3.1.4 Additional Function

Mode	Description
AED Mode	<ol style="list-style-type: none"> 1. The detector detects actual amount of X-rays without any connection to the X-ray generator, and then performs image acquiring to the extent of image acquisition time and transmits the image data. 2. No signal used (No need of connector interface cable) <ul style="list-style-type: none"> • You can use AED mode without connecting the generator with USB SW Box physically.

3.1.4.1 AED Mode

AED Mode is available for acquiring images without any connection to X-ray generator. Generator interface cable is not required.

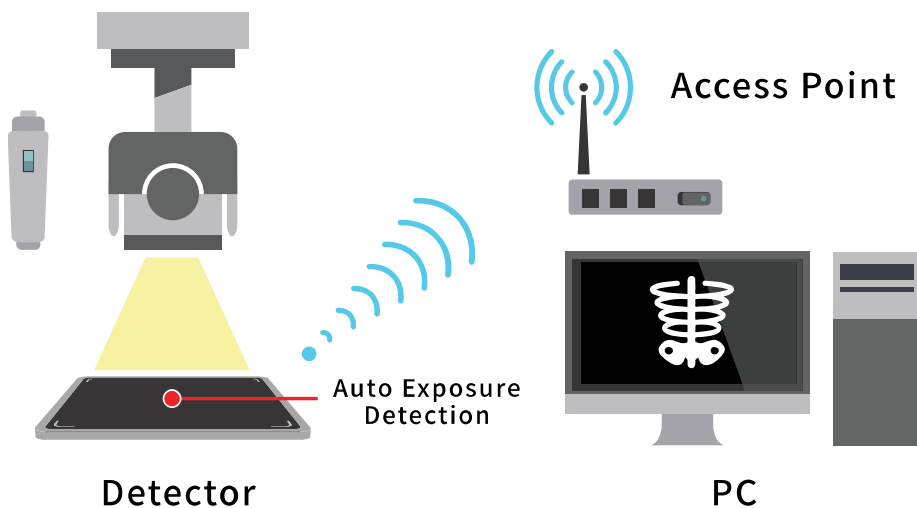



CAUTION
MISE EN GARDE

- Make sure to follow operating environment requirements (Temp. : 10 ~ 35 °C)
Veillez à respecter les exigences de l'environnement d'exploitation (Température : 10 ~ 35°C)
- If you use AED Mode out of operating environmental requirements, unwanted image can be acquired without x-ray image acquiring process.
Si vous utilisez le mode DSA en dehors des conditions environnementales, vous pouvez acquérir des images non désirées sans processus d'acquisition d'images à rayons X.
- Do not hit or drop the equipment. Unwanted images can be acquired in the AED Mode if it receives a strong jolt.
Ne pas frapper ou laisser tomber l'équipement. Les images non désirées peuvent être acquises en mode DSA si le choc subit de fortes secousses.
- If you perform image acquisition of a thick object in the AED Mode with low X-ray tube voltage, an image may not be acquired.
Si vous effectuez l'acquisition d'image d'un objet épais en mode DSA avec une tension de tube à rayons X faible, il est possible que vous ne puissiez pas acquérir d'image.
- AED performance is proportional to KV energy. Therefore, it is recommended to increase KV as much as possible and relatively decrease mA and ms.
La performance des DAE est proportionnelle à l'énergie KV. Par conséquent, il est recommandé d'augmenter le plus possible le KV et de réduire relativement les mA et les ms.
- When you set x-ray exposure area towards the direction of the detector, the center block of the detector should be included in the X-ray exposure area. Otherwise, you may not acquire an image.
Lorsque vous définissez la zone d'exposition aux rayons X dans la direction du détecteur, le bloc central du détecteur doit être inclus dans la zone d'exposition aux rayons X. Sinon, vous ne pouvez pas acquérir une image.
- The minimum X-ray exposure area should be wider than 4cm X 8cm on the center block of detector.
La zone d'exposition aux rayons X minimale doit être plus large que 4 cm sur 8 cm sur le bloc central du détecteur.

3.1.4.2 Recommendation of setting AED Sensing Area

Standard Environment

We suggest the collimated area on detector is wider than 4cm X 8cm, and keep along the vertical direction as shown in below figures.

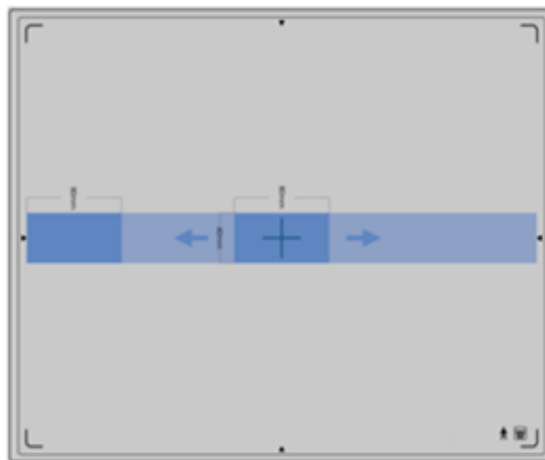
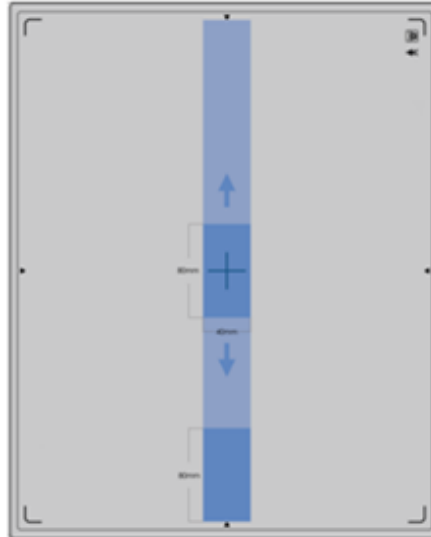

3.3 Environmental Requirements

3.3.1 Specifications of Workstation (Minimum and Recommended PC Requirements)

Item	Specification
Operating system	Windows 7 64 bit SP1 (Professional Edition or higher)
CPU	Intel Core i5 3470 or higher (or compatible CPU)
Memory	8GB or higher
Hard disk	1TB or higher
LAN card	Gigabit (Detector only) Intel® PRO 1000 Series (Gigabit LAN Card for network interface) Min. Requirements: 1Gbps, Jumbo Frames: 9K Receive Descriptors: 2K (higher than 1024) This is not dedicated to DICOM
Monitor	23 inch, 1920 x 1080 or higher
Optional disc drive	CD or DVD R/W

Table 3 Workstation

3.3.2 Recommended Specifications of Grid

Item	Recommended Specification
SID	100 cm / 130 cm / 150 cm / 180 cm
Ratio	10 : 1
Frequency	103 line/inch, 120 line/inch, 215 line/inch
Inter spacer	Al

Table 1 Grid spec



3.3.3 Recommended Exposure Condition

Item	Recommended Condition
X-ray Energy Range	100 cm / 130 cm / 150 cm / 180 cm
Reliability (Lifetime Dose)*	120Gy (206.9uGy/1 shot x200 shot/1day x 25days/Month x 12month/year x 10years = 124.14Gy)

Table 5 Exposure Condition

**Results obtained in a laboratory environment.*

3.4 Before using the detector

 CAUTION MISE EN GARDE	<ul style="list-style-type: none"> • Be sure to use only the specified power supply dedicated for the Product. Veuillez à n'utiliser que l'alimentation appropriée du détecteur produit.
	<ul style="list-style-type: none"> • Wireless Connection EVS W series transmits images and data by wireless communication. Battery pack should be installed in the detector to use it under the wireless configuration. Up to 2 battery packs can be charged simultaneously from a battery charger. • Wired Connection Connect EVS W Series and PC with a tether interface and functional cable to make a wired configuration. Although the functional cable supplies power, a battery pack is needed to be installed in the detector. Data communications are faster than wireless connection. It is possible to charging a battery pack while using the detector.

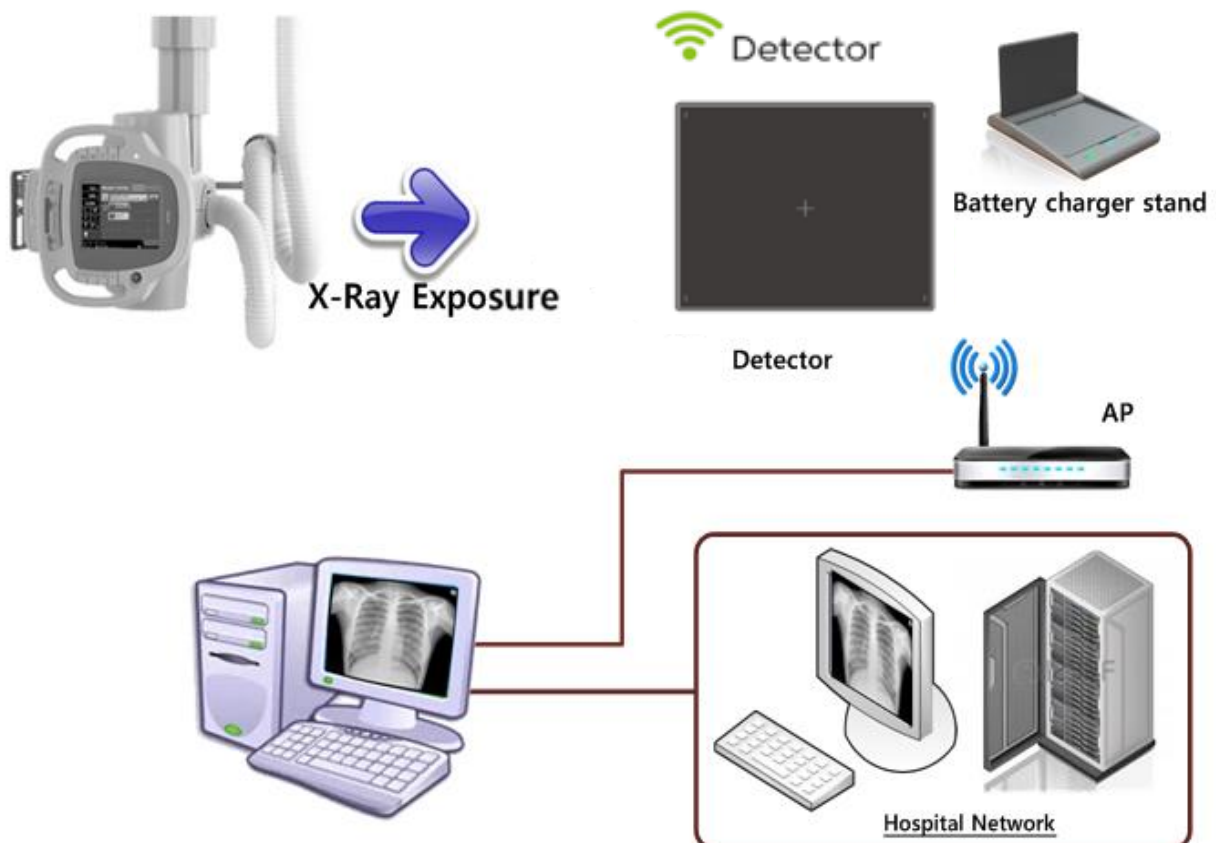

3.5 Operating the detector

3.5.1 Genral Workflow

The following workflow indicates the procedures for acquiring a clinical image after startup of EConsole1 and other system equipments

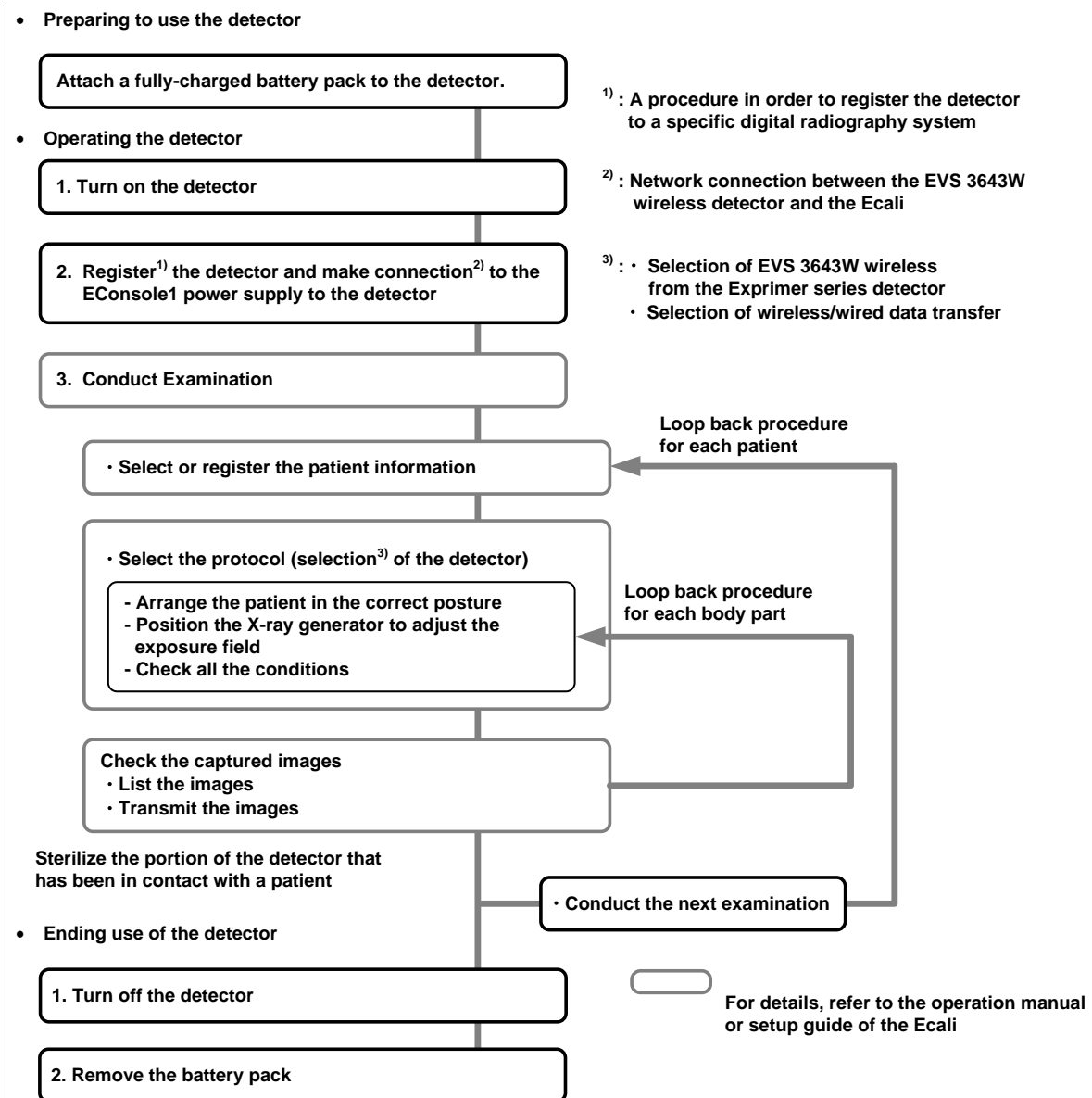









Figure 8. EVS 4343W(G) /3643W(G) General Workflow

3.5.2 Operating the detector

Lamp Type		Operation		Network
	Ready	Busy	AP	Link
Color	 Green	 Orange	 Blue	 Green

* The Network lamp is divided into two different lamps; AP (Blue) and LINK (Green) lamps.

3.5.2.1 Powering on the detector



- Before operating the detector, start up the EConsole1

Press and hold the POWER button
(approx. 1 second)

Operation lamp (Green) lights up



3.5.2.2 Register the detector and make connection to the EVS control system

Registration: AP(Blue) and LINK(Green) lamp blinks





- When the AP lamp is blinking once in 2 seconds, system is in wired mode.
- When the AP lamp is blinking twice in 2 seconds, system is in wireless mode (AP_1).
- When the AP lamp is blinking 3 times in 2 seconds, system is in wireless mode (AP_2).
- When the AP lamp is blinking 4 times in 2 seconds, system is in wireless mode (Detector AP)

**User can set value of AP_1, AP_2, in Ecali Program. Please refer to Ecali1 Operation Manual (Calibration tool).

Connection: Network connection between the internal wireless module of the detector and the wireless access point/EVS control system is secured automatically. The LINK (Green) lamp lights up when the detector is registered and the communication connection has been established.





- The LINK (Green) lamp does not light up when the detector is not registered or the communication connection is not established.
- When the READY (Green) and AP (Blue) lamp are blinking and LINK (Green) lamp does not light up, a communication error has occurred.

3.5.2.3 Conduct examination

For details about operation, refer to the User Manual for the EConsole1.

- ① **Select the patient information or protocols on the screen and start the examination.**



- The READY lamp color is changed from green to orange when the detector and EConsole1 change to exposure ready status.



- Arrange the patient in the correct posture and position the detector aligning it with the target body part.
- Position the X-ray generator to adjust the exposure field.
- Check all conditions before exposure.
- Make sure that Ready (Green) and LINK (Green) lamps are lit and AP lamp (Blue) is blinking. This means that the system is ready to start an examination



- A communication error has occurred when LINK lamp blinks.
- When the READY lamp (Orange) blinks slowly, the detector is in detector selection status (Sleep).
The detector enters detector selection status automatically when it has not been used for a certain period of time.

- ② **Press the exposure switch of the X-ray generator. Images captured with the detector are transmitted to the Ecali1 and appear on the monitor.**

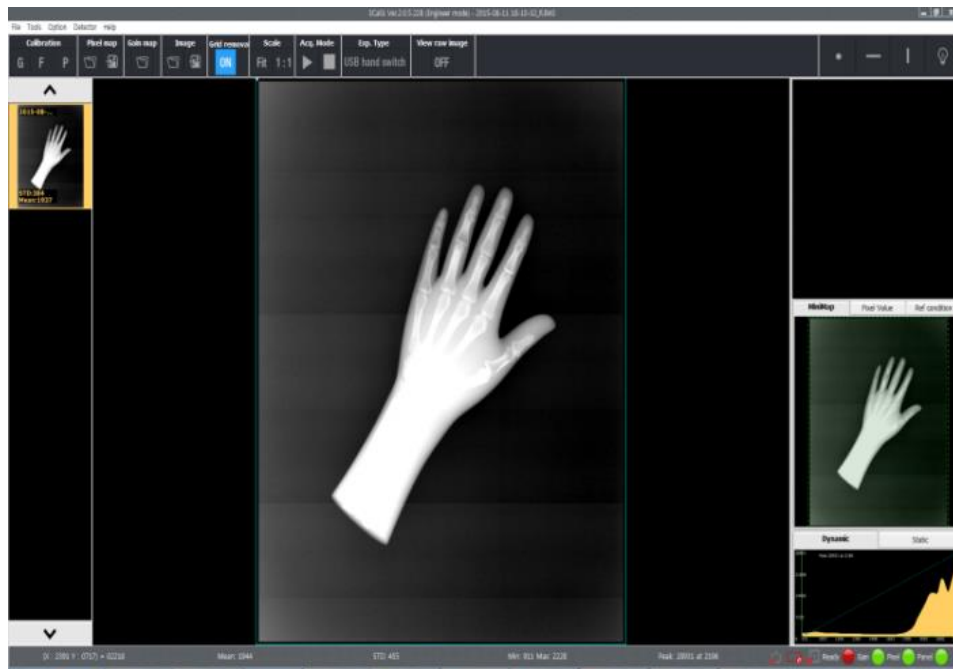

- Check the images on the monitor.
- If any uncompleted protocols remain, repeat the procedure(②).
- Choose the exposure mode before the shooting.

Mode	Description
AED	Auto Exposure Detection Mode

③ Click the button for ending the examination images are stored automatically.

- To conduct examination for another patient, repeat the step(③).







 IMPORTANT	<ul style="list-style-type: none"> • Sterilize the portion of the detector that has been in contact with a patient to prevent infection
---	--

3.6 Powering off the detector

- **Turn off the detector**
 - ① Press the POWER button of the detector.
 - ② All the LED lamps should be off.
 - Select the POWER OFF button from Econsole1.
 - Power plug off of POE adaptor from the outlet.

3.7 Detector status list

3.7.1 Detector Status List





Lamp Type		Operation		Network
	Ready	Busy	AP	Link
Color	 Green	 Orange	 Blue	 Green
Power ON	O	X	X	X
During detector registration	X	O	☆	☆
Detector registration completed (1Sec.)	X	O	☆	O
During exposure preparation	X	O	☆	O
Ready status or performing an examination (Ready)	O	X	☆	O
During image data transmission	X	O	☆	O
Sleep Mode	X	O	☆	O
Deep Sleep Mode	X	O	☆	O
Power OFF	X	X	X	X

O : Light on







X : Lights off

☆ : Blinking

3.7.2 Power Mode Indicator















Display	Power Mode	Status	Required Actions
	Active		
	Sleep		Low power mode
	Deep sleep		Hibernation power mode only
	Power turned off or not linked	Disconnected communications	Power off

3.7.3 Signal Strength Indicator

Display	Signal Strength (communication stability)	Status	Required Actions
	Wireless, high (Stable)	Normal	
	Wireless, Normal (Stable)	Normal	
 	Wireless, Low (Unstable)	Unstable communication. Communication speed is lowered	Check whether there is any obstacle (e.g. your hands) between the wireless module and the wireless access point. If there is any obstacle, remove it. If the problem cannot be resolved, ask for consultation to your sales representative or local DRTECH dealer.
	No signal or No Link (Communication failed)	Disconnected communications	Confirm that detector and the access point are turned on. If the problem cannot be resolved, ask for consultation to your sales representative or local DRTECH dealer.
	Wired Link	Normal	External cable is connected.

	<ul style="list-style-type: none"> A signal strength indicator appears on the screen of the ECali1 computer. It shows the wireless communication level between the detector and ECali1. Keep the wireless communication level stable on capturing or transmitting images.
---	---

3.7.4 Battery Remains Indicator

Display	Status	Ext. Pwr	Required Actions
	Charge complement	Ext. cable & battery	
	Ext. cable charging	Ext. cable & battery	
	100%	Only battery	
	90~99%	Only battery	
	80~89%	Only battery	
	70~79%	Only battery	
	60~69%	Only battery	
	50~59%	Only battery	
	40~49%	Only battery	
	30~39%	Only battery	
	20~29%	Only battery	
	10~19%	Only battery	Warning message is popped up at the bottom-right. Recommend to change the battery.
	0~9%	Only battery	Warning message is popped up at the bottom-right. Change the battery before the battery is discharged.
	No Battery or Error	Unknown	Change the battery. If the problem cannot be resolved, ask for consultation to your sales representative or local DRTECH dealer.

3.8 Additional function

Mode	Description
AED/AWC Mode	3. The detector detects actual amount of X-rays without any connection to the X-ray generator. 4. No signal used (No need of connector interface cable)

3.8.1 Lossless AED/AWC Mode

AED Mode is available for acquiring images without any connection to X-ray generator. Generator interface cable is not required.

The acquired images are stored in the internal storage of the detector in order and the images can be transmitted to the PC after connecting the detector to the PC. The transmitted images in the detector are removed automatically.

Image processing and correction are available after connecting the detector to Viewer.

AWC(Auto Window Control) is a mode that automatically detects the end point of X-ray exposure and adjusts the EWT(Exposure Window Time) set before the examination.

If an X-ray is detected within a shorter time than the preset maximum Exposure Window Time, the Exposure Window is automatically closed and EWT is adjusted for faster operation of the detector.

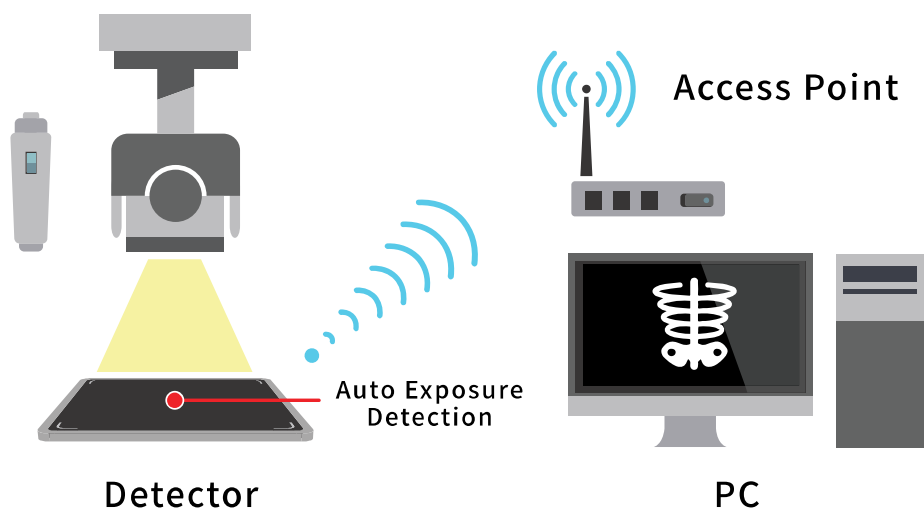

Figure 9. AED Mode Configuration



CAUTION
MISE EN GARDE

- Make sure to follow operating environment requirements (Temp. : 10 ~ 35°C)
Veillez à respecter les exigences de l'environnement d'exploitation (Température : 10 ~ 35°C)
- If you use AED Mode out of operating environmental requirements, unwanted image can be acquired without x-ray image acquiring process.
Si vous utilisez le mode DSA en dehors des conditions environnementales, vous pouvez acquérir des images non désirées sans processus d'acquisition d'images à rayons X.
- Do not hit or drop the equipment. Unwanted images can be acquired in the AED Mode if it receives a strong jolt.
Ne pas frapper ou laisser tomber l'équipement. Les images non désirées peuvent être acquises en mode DSA si le choc subit de fortes secousses.
- If you perform image acquisition of a thick object in the AED Mode with low X-ray tube voltage, an image may not be acquired.
Si vous effectuez l'acquisition d'image d'un objet épais en mode DSA avec une tension de tube à rayons X faible, il est possible que vous ne puissiez pas acquérir d'image.
- AED performance is proportional to KV energy. Therefore, it is recommended to increase KV as much as possible and relatively decrease mA and ms.
La performance des DAE est proportionnelle à l'énergie KV. Par conséquent, il est recommandé d'augmenter le plus possible le KV et de réduire relativement les mA et les ms.
- When you set x-ray exposure area towards the direction of the detector, the center block of the detector should be included in the X-ray exposure area. Otherwise, you may not acquire an image.
Lorsque vous définissez la zone d'exposition aux rayons X dans la direction du détecteur, le bloc central du détecteur doit être inclus dans la zone d'exposition aux rayons X. Sinon, vous ne pouvez pas acquérir une image.
- The minimum X-ray exposure area should be wider than 4cm X 8cm on the center block of detector.
La zone d'exposition aux rayons X minimale doit être plus large que 4 cm sur 8 cm sur le bloc central du détecteur.

i In AWC mode, the MAX "Exposure Window Time" is set as a default in case the end of X-ray exposure is not detected.

3.8.1.1 Recommendation of setting AED Sensing Area

Standard Environment

We suggest the collimated area on detector is wider than 4cm X 8cm, and keep along the vertical direction as shown in figure 15.

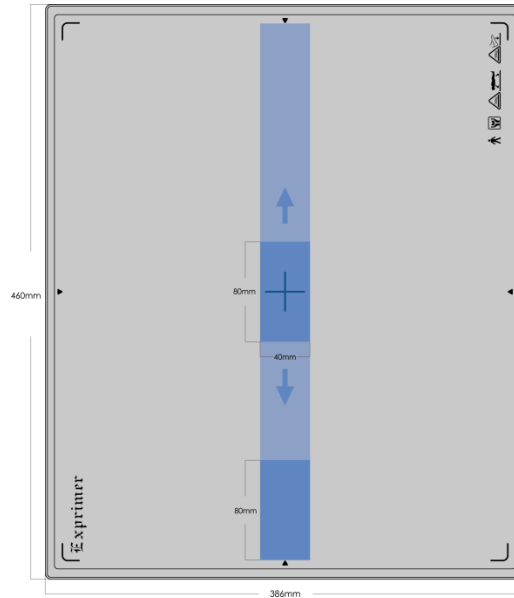

Figure 15. Stand Environment with AED Mode

Table Environment

We suggest the collimated area on detector is wider than 4cm X 8cm, and keep along the horizontal direction as shown in figure 16.

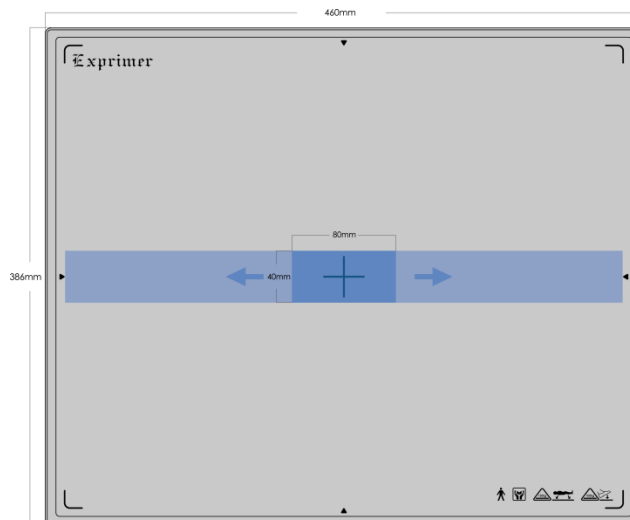

Figure 16. Stand Environment with AED Mode

3.9 Product Installation

3.9.1 Connecting Device

This section describes how to connect the EVS 4343W / EVS 3643W system (Detector).

3.9.1.1 Operating AP



- 1) Connect the LAN cable to **ethernet** port (not internet) of AP, and the other to the LAN Card connector of workstation assigned for the data transfer.

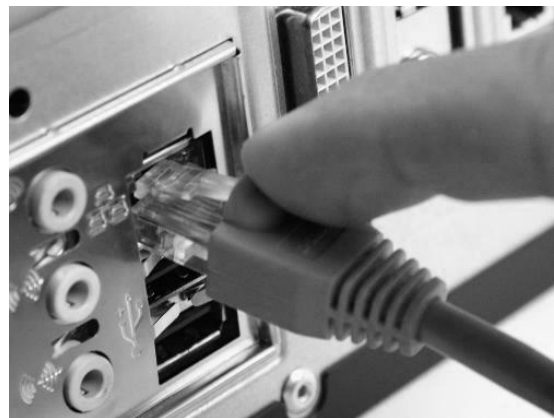

- 2) Connect the power cable to the **power** port of AP to supply power.



3) Turn on **Wireless On/Off** switch and push the **Power** button.



CAUTION
MISE EN GARDE

This equipment must only be connected to the power with protective earth.
Cet appareil ne doit être branché qu'à une prise secteur avec terre de protection.

4. Trouble Shooting

When you encounter problems or error messages in the EVS Console while using this equipment, search the table below for the problem or error message and try the solutions. If the problem persists, turn off the detector and consult your sales representative or local DRTECH dealer. Please refer to the details of the problem or error messages.

Symptom	Cause/Error messages on the EVS Control Software	Remedy
Failed to turn on.	Not Installing battery pack well Dead battery pack Battery pack or Detector is broken	Install the battery pack. Charge the battery pack. Replace other battery packs and check the results. Replace other Detectors and check the results. Replace corresponding devices.
Ready LED(Orange) lamps of detector are blinking 3 time/sec	Internal hardware errors of the detector	Consult with service engineers of DRTECH
Consumption of a fully charged battery pack is fast.	Performance decrease caused by usage of long time. Usage of battery pack in low temperature environment.	Replace to new battery pack if the battery pack has been used for a long time. (Battery pack is a consumable.) Use battery pack in normal room temperature environment. Charging capacity of battery pack in a low temperature environment will decrease the capacity.
Battery pack or compartment for installation of battery pack is getting hot.	Battery pack failure. Detector failure.	Do not use the battery pack. Consult with service engineers of DRTECH.

5. Maintenance

In order to ensure that the equipment is used safely, be sure to inspect the equipment before use. If any problem is detected during the inspection and cannot be corrected, please contact your sales representative or local DRTECH dealer.

5.1 Daily Inspection and Maintenance



WARNING
AVERTISS-EMENT

For safety reasons, be sure to turn OFF the power to each piece of equipment before the following procedures. Otherwise, an electric shock may result.

- **Cable**
 - Ensure that cables are not damaged and cable jackets are not torn.
 - Ensure that the power cord plugs are securely connected to both the equipment AC inlet and the AC outlet.
- **Detector**
 - Ensure that there are no loose screws or broken parts.
 - Ensure that there is no dust or foreign substance on the external connector.
 - Ensure that there are no broken parts or short-circuits in the power supply connector.
- **After turning on the power**
 - Be sure to start the ECal1 before performing the inspection.
 - Perform exposure testing.

5.2 Regular Inspection and Maintenance

- **Monthly Inspection**
 - Ensure that there are no loose screws or broken parts.
 - Ensure that there is no dust or foreign substance on the external connector.
- **Yearly Inspection**
 - Perform a Performance Test or Self-diagnosis Test using a phantom or resolution chart, etc.

5.3 Irregular Inspection and Maintenance

- **Calibration**
 - Perform Calibration when exposure conditions have changed significantly. For details, refer to the Setup Guide for ECal1.

6. Packaging

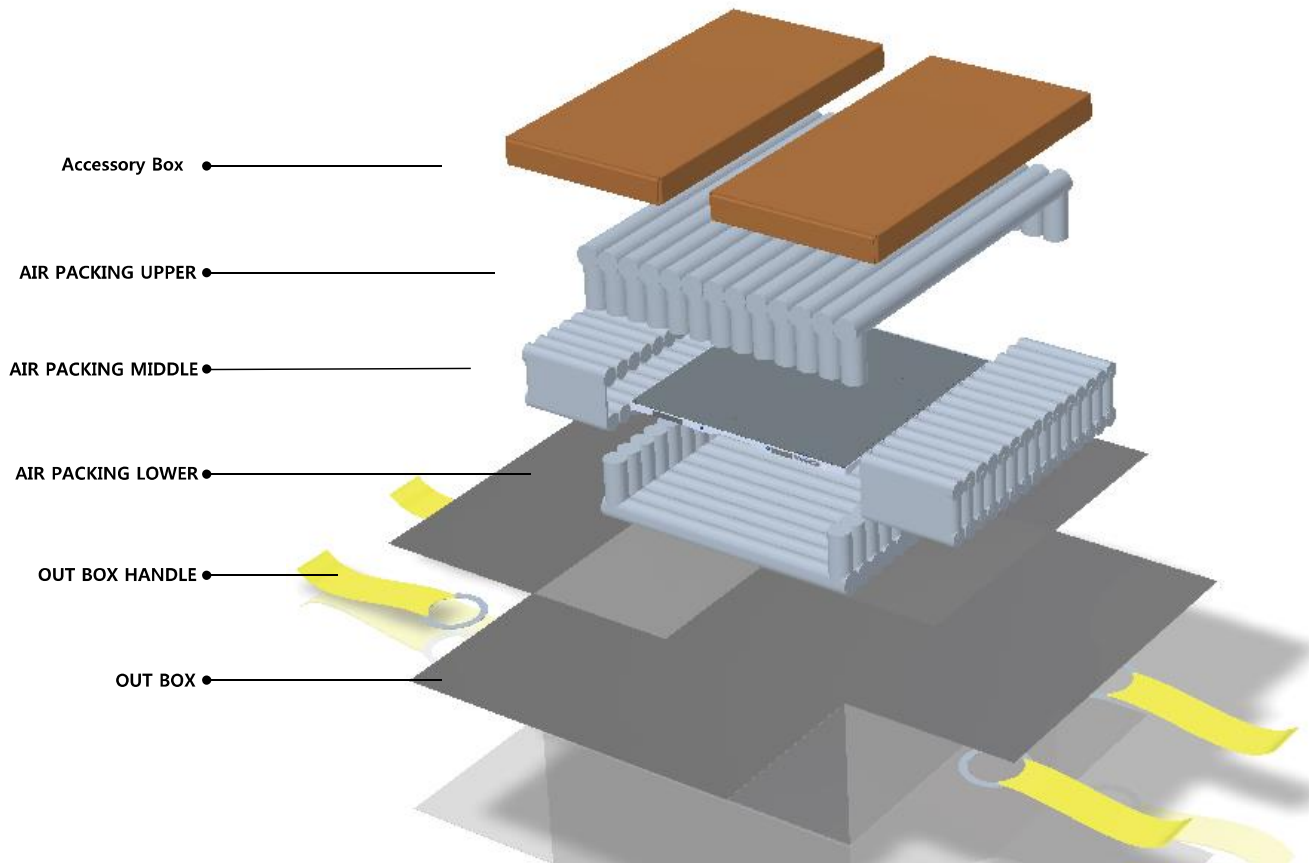

WARNING
AVERTISS-EMENT

Operational issues may occur if inappropriate force is applied to the product during unboxing. Please handle the box containing the product with care.

Note: The packaging that came with the product should not be damaged or discarded as it is needed for after-sales service or for exchanging the product with new product. If the packaing or any component is missing, the damaged product cannot be refunded or exchanged with a new product.

7. Revision History

Revision	Date	Descriptions
00	2019.09.10	Initial Release
01	2019.09.09	Addition of EVS 3643WP / EVS 4343WP model in manual
02	2019.10.11	Update of regulatory information(FCC)
03	2019.10.14	Update of regulatory information(EU) and manual composition
04	2019.11.20	Update of regulatory information(FCC)



DRTECH Co, Ltd

Suite No.1, 1 Floor / Suite No.2, 3 Floor,

29 Dunchon-daero541beon-gil,

Jungwon-gu, Seongnam-si, Gyeonggi-do, Republic of Korea

Website : <http://www.drtech.co.kr>

Customer Support Team

E-mail : drtech@drtech.co.kr

Tel : +82 31 779 7448 / Fax : +82 31 779 7490



DRTECH Europe GmbH

Am Kronberger Hang 2, 65824 Schwalbach am Taunus, Germany

D R T E C H