

2004 TURBO® COMP CYCLOCOMPUTER

Congratulations on your purchase! You are now the owner of one of the world's most advanced cyclocomputers. Your Specialized Turbo® Comp a revolutionary new three-line LCD screen. The large, easy to read, digits allow you to view two functions simultaneously and the alphanumeric dot matrix display provides a quick reference to the currently displayed function. The Turbo® Comp has been designed to provide the best combination of performance, features, durability and ease of use.

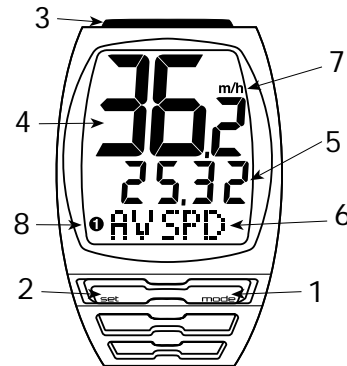

FIGURE 1

This illustration describes the screen display and buttons

- MODE/SET rocker switch
- TOP Button (Start/stop)
- Dot-matrix Display Area
- Digital Display Area
- Wheel Option Indicator
- MPH or KM/H indicator

The following 10 functions are available on your Turbo® Comp:

Turbo® Comp:

- SPEED – Current Speed
- AVSPD – Average speed
- MXSPD – Maximum Speed
- TRIP – Trip Distance
- ODO – Odometer (total distance)
- ATM – Automatic Start/Timer
- TIMER – Stopwatch With Lap-timer
- INT – Interval Timer
- DISTÚ– Distance Countdown
- CLOCK – Digital 12/24 Hour Clock

This computer also features:

- Wired speed sensing
- Two function LCD Display
- Second Wheel Option
- Easy Calibration Mode
- Water resistant housing
- 2 Year Warranty

THE FOLLOWING ITEMS ARE INCLUDED IN YOUR TURBO® COMP PACKAGE:

Turbo® Computer

- CR-2032 Lithium Battery (1)
- Battery Door (1)
- 26.0mm mounting bracket (1)
- 31.8mm mounting bracket (1)
- Wired Speed sensor (1)
- Magnet with screw (1)
- Adhesive backed magnet (1)
- Cable tie wraps (5)
- Mounting bracket sizing straps (3)

FIGURE 2

BATTERY INSTALLATION AND REPLACEMENT-

Before using your Turbo® Comp Computer you will need to install the battery. Turn the computer over so the display is facing downward. Use a coin to unthread the battery cap from the computer. Install the battery (model CR2032, Specialized P/N 481-3004) with the positive pole (+) facing upward. Carefully thread the battery cap back onto the case with a coin. (See

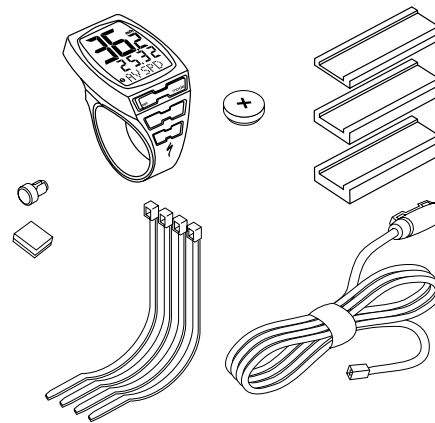

FIGURE 2

Figure 3) If, after battery replacement, the LCD display is blank or shows incomplete digits, turn the computer over and press the “AC” button on the bottom of the case with the tip of a pen or a paper clip. This will clear all the data and re-start the computer. If you need to replace the battery, make a note of your odometer reading and wheel circumference settings before removing it. You can then re-enter the data when you restart the computer.

FIGURE 3: BATTERY INSTALLATION

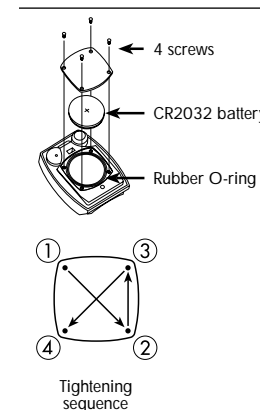

FIGURE 3

MOUNTING THE TURBO® COMP:

The Turbo® Comp wired speed sensor can mount on the right or the left side of the fork blade. Use the cable tie-wraps provided to position the sensor. Do not tighten until the final placement of the sensor magnet is correct.. (See figure 4). Wheel magnets have been provided for both traditional round spokes and bladed (flat) aerodynamic spokes.

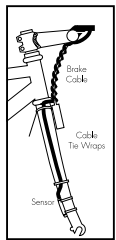

FIGURE 4

Attach the magnet to a spoke across from the transmitter with the magnet screw. The clearance between the magnet and the transmitter should be approximately 1/32"-1/16" (1-2mm). Tighten the magnet and transmitter. Do not over-tighten

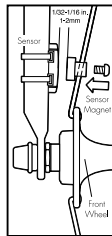

FIGURE 5

the magnet screw. (See figure 5).

For wheels with bladed spokes:

Use some isopropyl (rubbing) alcohol or a mild detergent to thoroughly clean the spoke that you plan to attach the magnet to. Remove the backing from the adhesive tape and firmly press the magnet onto spoke. The tape uses a special pressure sensitive adhesive. To ensure a strong bond, please wait at least 12 hours for the adhesive to cure before riding your bicycle.

Attach the appropriate mount (26.0mm and 31.8mm sizes are included) to the handlebar using the bracket screw provided. Tighten so that the bracket cannot rotate on the handlebar. There are several sizing straps provided to fit different diameter bars. (See figure 6). Slide the computer forward onto the mount until it 'snaps' into place with an

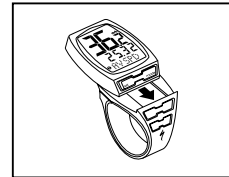

FIGURE 6

audible click. Plug the wire from the speed sensor into the socket on the bottom of your computer. To remove the computer, remove the speed wire (if connected) then push it backward until it releases from the mount.

To test for proper installation of the magnet, transmitter and computer, activate the computer by pushing the 'MODE' (right side) button. Pick up the front of the bicycle and spin the front wheel. The "wheel option" indicator will flash. If it does not flash, check the sensor and magnet alignment. Realign as necessary until the "wheel option" indicator flashes while spinning the wheel

OPERATION AND PROGRAMMING

When your Turbo® Comp

has not detected any speed input for 30 minutes, it will enter sleep-mode in order to conserve battery power. During sleep mode only the digital clock is displayed. The computer will wake it up when wheel speed is detected or when the MODE or SET button is pressed. In order to operate your computer it must be placed in various "modes" (i.e. odometer mode, distance mode). The computer can be cycled through these modes by pressing the "MODE" button located on the right-hand side the MODE/SET rocker switch. There are nine cycling modes available: 1) Clock Mode, 2) Odometer Mode, 3) Trip Distance Mode 4) Average Speed Mode, 5) Maximum Speed Mode, 6) Automatic Timer Mode, 7) Timer/Stopwatch Mode, 8) Interval Mode and 9) Distance Countdown mode. Once you familiarize yourself with the mode operation you will find it

very easy to navigate. The following flowchart outlines the mode sequence. Once a particular mode has been entered, its values can be reset or adjusted by pressing and holding the "SET" button for three seconds.



1. Setting the Display Language

Your Turbo® can display information on the dot-matrix display area in six different languages: English (ENGL), German (GER), French (FR), Italian (ITA), Dutch (NED), and Spanish (ESP). To select your language push the

mode button repeatedly until CLOCK is displayed in the Dot-matrix Display Area. Then, depress hold the "MODE" button for three seconds. The selected language will be displayed. Use the "MODE" button to scroll through the languages. When the selected language is displayed (default language is English), press the "SET" button once to confirm your selection and exit display language mode.

2. Miles or Kilometers selection (English only):

Your Turbo® Comp will record distance and speed in either miles (m & m/h) or kilometers (K & Km/h). Please note that miles can only be selected when the language setting is English. All other languages display only kilometers. (See "Setting the Display Language" above). To enter your selection of miles or kilometers, push the "MODE" button until ODO appears in the Dot-matrix

Display Area (This is called the odometer mode). Next, hold down the "SET" button for three seconds. The "Km" or "m" indicator will begin blinking. You may now alternate between miles and kilometers by pressing the "MODE" button. When the correct choice is flashing, select it by pressing the "SET" button. You will now enter the "Programmable Odometer" mode. If the odometer setting is correct push the "SET" button five times to exit odometer mode. (Otherwise, see "Setting the programmable odometer" below).

3. Setting the Programmable Odometer:

This mode is useful if you have replaced the battery and would like to retain the mileage you have already ridden. To access the Programmable odometer mode, first advance to the Odometer Mode by pressing "MODE" button until ODO appears in the Dot-matrix Display Area. Hold

down the "SET" button for three seconds (If you have selected English language, the Km/h indicator will flash. If the Km/h setting is correct press the "SET" button once) and a five-digit number will appear. You are now in the programmable odometer mode. To enter a mileage into the odometer, press the "MODE" button until the flashing digit is correct. (**Note:** The "MODE" button may be held to quickly scroll to the correct digit.) Press the "SET" button to select the next digit to the right. Repeat this process until all five digits are entered as your existing mileage. (See figure 7)

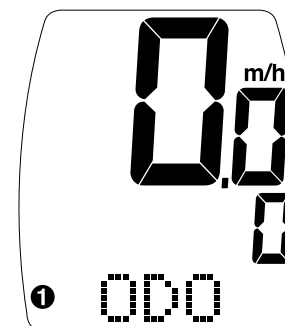

FIGURE 7

4. Wheel Circumference

Selection:

To set the circumference for the type of tires you are using, you can use Specialized's "Easy Calibration Mode" or measure your actual tire circumference by the roll-out method. Two different tire diameters may be entered by using the computer's "Second Wheel Option."

Easy Calibration Mode:

Your Turbo® Comp has been preprogrammed with the following 14 Specialized tire sizes:

- 26 X 1.0
- 26 X 2.2
- 26 X 1.25
- 650c X 20
- 26 X 1.5
- 700c X 20
- 26 X 1.9
- 700c X 23
- 26 X 1.95
- 700c X 26
- 26 X 2.0
- 700c X 32
- 26 X 2.1
- 700c X 38

When using Easy Calibration Mode, the Turbo® Comp will display the tire size on its LCD display screen. (See figure 11) The Easy Calibration Mode is accessed by entering the Odometer (ODO) mode and holding down the "MODE" button for three seconds. The display will now show the currently selected tire size for wheel option #1. To scroll through the preprogrammed tire sizes press the "MODE" button. When you reach the desired tire size press the "SET" button once to select it and enter Easy Calibration Mode for wheel option #2. Follow the same procedure to pro-



FIGURE 11

gram the wheel #2 tire size and tap the "SET" button to exit Easy Calibration Mode.

Roll Out Method

The roll out method will provide the most accurate computer calibration and can take into account variables such as inflation pressure, rim width and rider weight.

1. Extend a tape measure out to 3000mm (120 inches) and lock it in place.
2. With your tire inflated to its proper pressure, place the valve at the 6:00 position (at the bottom) directly over the start of the measuring tape.
3. Roll the wheel one complete revolution until the valve stem is again at the 6:00 position. Read the tape directly under the valve and note the distance in millimeters. (To convert inches to millimeters, multiply inches by 25.4). Use this number to replace the default (default values are

2073 for wheel one, and 2134 for wheel two) when programming your computer. (See figure 12).

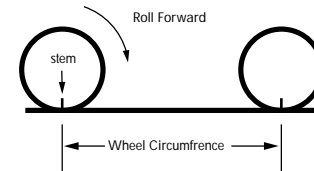

FIGURE 12

You may also use the following quick-reference chart:

Generic Tire Size Chart

This chart is for non-Specialized tires

- 26 X 1.75
- 2140
- 26 X 2.0
- 2074
- 26 X 2.1
- 2090
- 650C X 20
- 1945
- 700C X 26
- 2124
- 700C X 38
- 2170

Programming

the circumference:

To enter the tire circumference number, select the

Odometer (ODO) mode and then hold down the "MODE" button for three seconds. The display will now show the currently selected tire size for wheel option #1. (See figure 13). If necessary scroll through the prepro-

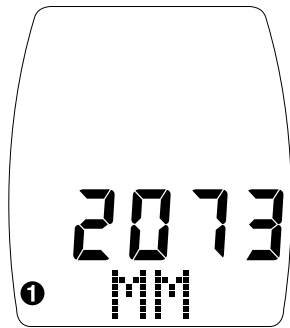

FIGURE 13

grammed tire sizes by tapping the "MODE" button until the display shows MM and four-digit number. This number represents your tire circumference in millimeters. Press the "MODE" button until the flashing digit is correct. (**Note:** The "MODE" button may be held to scroll to the correct digit.) Press the "SET" button to select the next digit to the

right. Repeat the process until all four digits are entered as your tire circumference. Press the "SET" button once to select it and enter the circumference for wheel option #2. Follow the same procedure to program the wheel #2 tire size and tap the "SET" button to exit circumference programming mode.

5. Setting the Clock

Your Turbo® Comp features a digital clock. To access the "clock mode" press and the "MODE" button repeatedly until CLOCK appears in the Dot-matrix Display Area. To set the clock, press the "SET" button for three seconds. The display will flash either twelve (12:) or twenty four (24:). Select between 12: or 24: mode by pressing the "MODE" button. Press the "SET" button to confirm your selection. The hour digit will now begin flashing. Press the "MODE" button to adjust the hour digits.

AM/PM is selected by scrolling the hour digit. Press the "SET" button to accept the hour selection. The minutes will flash and can be adjusted by pressing the "MODE" button. (Hold the "MODE" button to scroll through the digits quickly) Press the "SET" button to set the minutes and return to clock mode.



FIGURE 14

6. Timer Selection

The Turbo® Comp has two timers; Automatic Timer Mode (ATM) and Timer Mode (TIMER). The ATM selection allows you to keep track of your actual riding time. The ATM timer only operates when the wheel is rotating and can-

not be turned on or off manually.

Note: The average speed (AVSPD) calculation is based upon the ATM time.

The TIMER function is just like a conventional stopwatch. The timer is activated manually and records the time whether the wheel is rotating or not. Tapping the "TOP" button starts and stops the stopwatch and when the timer is stopped, holding the "SET" button for three seconds will reset to stopwatch. The TIMER includes a 12-memory lap time feature. To record a lap time, press the "SET" button once while the stopwatch is running. Each time the "SET" button is depressed the Turbo® Comp will record the lap time. After the TIMER has been stopped (by pressing the "TOP" button) the previous twelve lap times can be reviewed by pressing "SET" button. Additionally, the computer will display the total time when LPTOT is shown.

7. Interval Timer (INT)

Your Turbo® Comp is equipped with an Interval Timer. This feature allows you to customize your training by integrating a programmable repeating countdown timer into your workout. To enter the interval timer mode, press the "MODE" button repeatedly until "INT" appears in the Dot Matrix Display Area of the screen. You are now in interval timer mode. To set the interval timer, hold the "SET" button for three seconds. The hour digit will begin flashing. Press the "MODE" Button until the desired number appears. (Hold down the "Mode" button to scroll quickly) Press the "SET" button once to set this number and advance to minutes. Repeat this process until minutes and seconds are set to the desired settings. Press the "SET" button to exit programming mode. Once the time interval timer is programmed, press the "TOP" button to start/stop the countdown. (See figure 15). **Note:** The

shortest interval that can be set is 5 seconds.

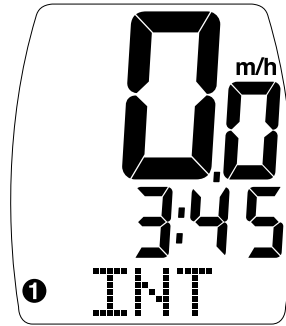

FIGURE 15

10. Distance Countdown (DISTÚ)

Your Turbo® Comp is equipped with Distance Countdown feature. This allows you to set an alarm when the selected mileage is reached. To enter the Distance Countdown mode, press the "MODE" button repeatedly until "DISTÚ" appears in the Dot-matrix Display Area. Note: if your display says "INT", press the "SET" button to change to "DISTÚ". To set the Distance Countdown, hold the "SET" button for three seconds. The hour digit will begin

flashing. Press the "MODE" Button until the desired number appears. (Hold down the "Mode" button to scroll quickly) Press the "SET" button once to set this number and advance to minutes. Repeat this process until minutes and seconds are set to the desired settings. Press the "SET" button to exit programming mode. Once the time interval timer is programmed, press the "TOP" button to stop and start the Distance Countdown.

Note: The shortest distance that can be set is .01 miles/km.

COMPUTER FUNCTIONS

Speedometer (SPEED)- Your current speed is always displayed in large digits on the top line of the LCD screen. The speed is displayed up to 99.9 M/h (99.9 Km/h) with a resolution of 0.1 M/h (0.1 Km/h)

Average Speed (AVSPD)-

The Average Speed is shown on the lower line of the Digital Display Area up to 99.9 M/h (99.9 Km/h) with a resolution of 0.1 M/h (0.1 Km/h). The average speed is based upon the ATM time. The resolution of the average speed data on the Digital Display Area is shown in 0.1M/h or Km/h increments. (See figure 16)

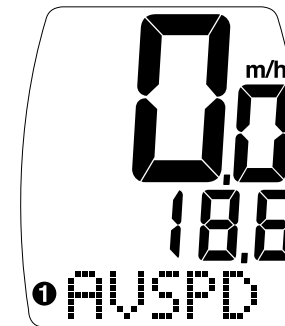

FIGURE 16

Maximum Speed (MXSPD)-

The Maximum Speed is shown on the lower line of the Digital Display Area up to 99.9 M/h (99.9 Km/h) with a resolution of 0.1 M/h (0.1 Km/h). The max-

imum speed is retained in memory and updated when a higher speed is maintained for three seconds. The maximum speed can be reset by pressing the "SET" button for three seconds. (See figure 17)



FIGURE 17

Auto Start/Stop Timer (ATM)-

In ATM mode the timer function records the actual time spent riding. It operates only when there is speed input and is displayed in the Digital Display Area of the screen

Timer Mode (TIMER)-

In TIMER mode the stop-

watch function will operate when the "TOP" button is pressed. The stopwatch will record the total time after the button is pressed regardless of whether there is speed input or not.

Interval Timer (INT)-

The interval timer is displayed on the lower line of the screen when (INT) appears on the left. The timer indicates the end of an interval with one short beep per second for the last 4 seconds of the interval. This is followed by a long beep, indicating the beginning of a new interval.

Trip Distance (DST)-

Trip distance mode will record up to 999.99 miles or kilometers and then roll to zero. The trip distance can be reset by pressing the "SET" button for three seconds. The resolution is 0.01 miles (0.01 Kilometers). The trip distance is shown on the lower line if the screen.

(See figure 19)

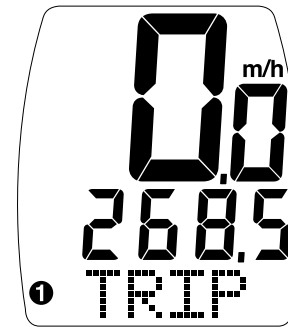

FIGURE 19

Odometer (ODO)-

The odometer will record the total distance traveled up to 99,999 miles or kilometers and then roll to zero. The odometer can be reset by pressing the "SET" button for three seconds. The total distance is shown on the lower line if the screen.

Programmable Odometer-

The odometer digits are programmable. This is convenient for transferring your hard-earned mileage that is usually lost when changing batteries or computers.

Clock-

Your Turbo® Comp is equipped with a digital clock. The clock can be set to operate in either 12 or 24-hour mode.

Second Wheel Option-

For riders who own more than one bicycle or who frequently change tires, the Turbo® Comp is capable of storing two tire sizes. You can change between the two sizes by entering Distance Mode and selecting TRIP. Then, press the "MODE" button for three seconds. The second wheel mode indicator will change from 1 to 2. Mileage recorded will be cumulative between the two sizes. (An accessory handlebar mount is available from your Specialized dealer. P/N 4814-5045)

TROUBLESHOOTING:

Display is blank:

Change the battery or press the AC button on the bottom of the case

Display shows partial digits:

Press the AC button on the bottom of the case.

Speed/distance not recording:

Check sensor/magnet alignment. Make sure that the sensor is no more than 1/16" (2mm) from the magnet. Replace transmitter battery if necessary. Recalibrate Computer and transmitter.

Entire screen is dark:

Did you leave the bike parked in the hot direct sun when it was parked? If so, move the bike to the shade. The data will be OK.

Computer moves on handlebar:

Tighten mount or add sizing straps to improve fit on handlebar.

IMPORTANT!

- Pay attention to traffic and road conditions at all times. Your first obligation is to be attentive and to ride safely.
- Do not expose it to direct sunlight except when you

are riding.

- Do not disassemble you Turbo®. There are no user serviceable parts inside.
- Make sure the magnet and the transmitter are well aligned. Check them regularly.
- Keep the computer and all of its components tightly attached, and check them regularly. If any of the components come loose, it could become tangled in your spokes and cause an accident.
- See your authorized Specialized dealer if you have any trouble installing or maintaining your computer.
- Clean the unit with a mild detergent and a soft dry cloth. Never use any kind of solvent or alcohol.
- The Turbo® Comp computer is intended for use on bicycles only and should not be used on any motorized vehicle.

Specifications:

Current Speed:
0.0 to 99.90 MPH

0.0 to 99.90 Km/H

Average Speed (AVS)
0.0 to 199.9 MPH

0.0 to 199.9 Km/H

Maximum Speed (MXS)
0.0 to 199.9 MPH
to 199.9 Km/H

Trip Distance (DST)
0 to 999.99 miles or Km

Odometer (ODO)
0 to 99,999 miles or Km

Stopwatch (TM)
0 to 9hrs, 59min, 59sec.
recycling type

Automatic Timer (ATM)
0 to 9hrs, 59min, 59sec.
recycling type

Interval Timer (INT)
5 seconds to 9hrs, 59
min, 59 sec.

Distance
Countdown(DISTÚ)
.01 to 999.99Miles

.01 to 999.99Kilometers

Operating Temperature
40°F to 104°F (4°C to
40°C)

The following replacement parts are available from your Specialized dealer or by visiting the Specialized S-store online at WWW.SPECIALIZED.COM

DESCRIPTION	PART#
STANDARD WHEEL	
MAGNET	480-3003
CR-2032 TURBO®	
BATTERY	480-3004
ADHESIVE BACKED	
WHEEL MAGNET	
	4800-3002
CENTER MOUNT	
	4814-5035
TURBO SPORT/COMP	
2ND BIKE KIT	
	4814-5045
TURBO SPORT/COMP	
SENSOR WIRE	
	4814-5055
TURBO MOUNT ONLY	
26.0MM	4814-5060
TURBO MOUNT ONLY	
31.8MM	4814-5065

Two Year Limited Warranty:

Specialized Bicycle

Components Inc. warrants the Original Purchaser of this Specialized® Turbo® Comp cyclocomputer that the product is free from defects of material and workmanship under normal use and service for a period of two (2) years from the date of the original purchase. If within two (2) year from the date of that original purchase, this product is found to be defective in material or workmanship under normal use or service, Specialized Bicycle Components Inc. will, at its sole option, repair or replace the product without charge; provided that the Original Purchaser returns the product, securely packaged, postage pre-paid to: Specialized Bicycle Components Inc., 1137 South, 3800 West Salt Lake City, UT 84104, USA. Attn: Turbo® Comp Warranty. Be sure to include a letter indicating the specific reasons for returning the product and proof of date of purchase.

This warranty does not apply to, and is void as to, defects or physical damage resulting from abuse, neglect, improper repair, improper fit, alterations, modifications or use contrary to that intended by the manufacturer. Except to the extent prohibited by applicable law, any implied warranty of merchantability or fitness for a particular use or purpose is limited in duration of this limited warranty. Specialized Bicycle Sportonents, Inc. shall not be liable for any accidental or consequential damages

arising from any breach of any expressed or implied warranty on this product. This warranty is exclusive and in lieu of all other warranties, expressed or implied, and all other remedies, guaranties or liabilities arising by law or otherwise.

Note: This warranty does not pertain to batteries.

No person or representative is authorized to assume any liability on behalf of Specialized Bicycle Components, Inc. in connection with the sale of this product. Some states do not allow the exclusion or limitation of incidental or consequential damages or limitations on how long an implied warranty lasts, so the above limitation or exclusion may not apply to you. This warranty gives you specific legal rights, and you may also have other rights which vary from state to state.

Turbo® is a registered trademark of Specialized Bicycle Components Inc.

© 2003 **Specialized Bicycle Components Inc.**

WWW.SPECIALIZED.COM