

PHILIPS

SpeechAir

Smart voice recorder

PSP1000 series



User manual

Table of contents

1	Important information	4	5	Philips dictation recorder app	23
	Safety instructions	4		Open the app	23
	Rechargeable built-in battery	4		One-touch start	23
	Data reset	4		Recording screen	24
	Hearing protection	4		Record dictations	25
	Medical device interference	4		Define settings prior to recording	25
	Use in aircraft	4		Record a dictation	26
	Cleaning and disinfection	4		Voice-activated recording	27
	Recycling	4		Playback	27
	About this user manual	5		Delete a dictation	28
	Model-specific features	5		Edit a dictation	28
	Symbols used	5		Insert, overwrite or append recording	28
				Add index marks	28
				Add keywords	29
				Add pictures	30
				Change dictation name	30
				Lock dictations/EOL	30
				Mark priority dictations	30
				Add barcodes	31
				Send a dictation	31
				Send a dictation via email	31
				Send a dictation to Philips SpeechLive	32
				Send a dictation to Philips SpeechLive	33
				transcription service	33
				Send a dictation to Philips SpeechLive	33
				speech recognition service	33
				Send a dictation to Philips SpeechExec	34
				mobile server	34
				Send a dictation to Philips dictation hub	35
				Send a dictation via Philips SpeechExec	35
				software	35
				Send a dictation to a network folder	36
				Using data lists	37
				Data list options	37
				Dictation app settings	38
				Audio settings	38
				Forwarding	39
				Security	39
				User interface	40
				Connectivity	40
				Help	40
				About	40
2	Your smart voice recorder	6	6	Device and data management	41
	Product highlights	6		Transfer data to and from the computer	41
	What's in the box	6		Reset your device and data	41
	Overview of the recorder	7		Device reset	41
	Overview of the docking station	8		Factory data reset	42
				Updating your device	42
3	Getting started	9	7	Philips SpeechAir management software	44
	Charging the battery	9		Install SpeechAir management software	44
	Charge via USB power supply	9		Configure SpeechAir with SpeechAir	44
	Charge via docking station	9		management software	44
	Charge via computer	10		Device configuration screen	45
	Turn the device on and off	10		Configure SpeechAir and Philips dictation	45
				recorder app settings	45
4	Using your voice recorder	11	8	Using SpeechAir with Philips SpeechExec	46
	Using the touch screen	11		software	46
	Home screen	11		Install SpeechExec on your computer	46
	Customize your Home screen	12		Configure SpeechAir in SpeechExec	46
	Add and remove items and widgets	12		Configure SpeechAir with the SpeechAir	46
	Manage Home screen panels	13		wizard	46
	Organize folders	13		Configure delivery methods for SpeechAir	46
	Status bar and notification panel	13		Download dictations to SpeechExec	47
	Status bar	13			
	Notification panel	14			
	Lock screen	14			
	Set screen lock	14			
	Set the date and time	15			
	Set the device and input language	15			
	Change the device language	15			
	Change the input language	15			
	Switch between input languages	15			
	Using apps	15			
	Preinstalled apps	15			
	Install apps	15			
	Uninstall apps	16			
	Change the screen orientation	16			
	Typing text	16			
	Enter text	16			
	Copy and paste text	17			
	Using Wi-Fi	17			
	Using Bluetooth	18			
	Capture screenshots	19			
	Change sound settings and sound mode	19			
	Power saving mode	19			
	Using email app	20			
	Set up an email account	20			
	Add further email accounts	21			
	Remove email accounts	21			
	Send an email	21			
	Email account settings	21			
	Device settings	22			

9 Service and support	48
Display device information	48
Display information about Philips dictation recorder app	48
Open Quick start guide	48
Send email to technical support	48
Contact our supporting Philips partners	48
Open source software	48
Troubleshooting	49

10 Technical data	52
--------------------------	-----------

1 Important information

Don't make any adjustments and modifications that aren't described in this manual. Follow all safety instructions to ensure proper operation of the device. The manufacturer assumes no liability for damages resulting from non-compliance with the safety instructions.

Safety instructions

- Protect the device from rain and liquids to prevent damage to the device or a short circuit.
- Don't expose the device to excessive heat caused by placing it on a heating device or in direct sunlight.
- Protect the cables from damage by being trapped, particularly at the plugs and where cables exit the housing.
- Back up your data and recordings. The manufacturer's warranty doesn't cover loss of data resulting from user actions.
- Don't perform any maintenance operations that aren't described in this user manual. Don't disassemble the device into its component parts to carry out repairs. The device may only be repaired in authorized service centers.

Rechargeable built-in battery

- Don't attempt to replace the battery yourself. The battery may only be replaced in authorized service centers.
- Before your battery is replaced by an authorized service center, back up your data and recordings.
- Batteries contain substances that may pollute the environment. Used batteries should be disposed of at an official collection point.

Data reset

Philips SpeechAir has an internal memory with 1 GB RAM and 16 GB built-in storage. If you want to perform a factory data reset, observe the following cautions:

- Back up your data and recordings. Performing a factory data reset will delete all data on your device.
- Formatting the memory on a computer may cause incompatibilities with your device. Format the memory only on the device.

Hearing protection

Observe the following guidelines when you use headphones:

- Set the volume to a moderate level and don't use headphones to listen for excessively long periods of time.
- Be particularly careful to avoid adjusting the volume to a level that your hearing can't deal with.

- Don't turn the volume up so high that you can't hear what is going on around you.
- In potentially dangerous situations, be particularly careful or temporarily discontinue use.
- Don't use headphones while you are operating a motorized vehicle, cycling, skateboarding, and so on. You could be a hazard to yourself and other road users, and possibly be breaking the law.

Medical device interference

SpeechAir contains components that emit electromagnetic waves. Electromagnetic waves might interfere with the operation of a pacemaker. Keep a safe distance of separation between SpeechAir and your pacemaker.

Use in aircraft

Wireless transmitters can negatively affect the operation of other electronic equipment, causing them to malfunction. Turn off SpeechAir or use Airplane mode when you travel in aircraft. In Airplane mode, SpeechAir's signal transmitting functions are turned off.

Legal restrictions on recording

- The use of the device's recording function is subject to the legal restrictions that may apply in your country. You should also respect the privacy and personal rights of third parties if you record talks or lectures.
- If you want to record telephone calls, check if this is legal in your country. In certain countries, you may be legally required to inform the person you are conversing with on the telephone that you are recording the conversation.

Cleaning and disinfection

- Before cleaning, disconnect all cables from the device.
- To clean the device, use a soft dry cloth.
- To disinfect the device, use products for disinfection of surfaces in clinical areas and patient care equipment, such as surface disinfectant wipes.
- Don't use harsh chemicals or strong detergents.
- Avoid getting moisture in openings.
- Don't rub or strike the surface with anything hard or sharp as this may scratch or damage the surface permanently.

Recycling

A crossed-out wheeled bin symbol attached to a product indicates that the product is covered by the European Directive 2011/65/EU. Please get informed about the local separate collection system for electrical and electronic products.



Please act according to your local rules and don't dispose of your old products with your normal household waste. Correct disposal of your old product helps to prevent potential negative consequences for the environment and human health.

About this user manual

Find a quick overview of your device on the next pages. For detailed description, see the following chapters of this user manual. Read the instructions carefully.

Model-specific features

This user manual describes different models of the device product range. Please note that some features are only available on certain models.

Symbols used



Tip

- This symbol identifies information that helps you to use your device more efficiently and simply.



Note

- This symbol indicates notices which you should observe when handling or operating the device.



Caution

- This symbol warns of damage to the device and possible data loss. Damage can be caused by improper handling.

2 Your smart voice recorder

We are delighted that you have chosen a Philips device. Visit our website for comprehensive support, such as user manuals, software downloads, warranty information and more: www.philips.com/dictation.

Product highlights

- Three dedicated microphones for optimized voice recording
- Large speaker for crystal clear audio playback
- Gorilla glass touch screen and shockproof, antimicrobial housing for durability
- Wear-free and ergonomic slide switch and function button for efficient single-handed operation
- Wi-Fi, LAN, Bluetooth, USB and VoIP for staying connected anywhere you go
- Barcode scanner and camera for quick file association and proof documentation
- File encryption for maximum data security
- Android OS for intuitive use
- Philips dictation recorder app for professional dictation features (optional)
- Docking station for fast battery charging and data transfer
- Dictation workflow software for an even more efficient workflow (optional)

What's in the box

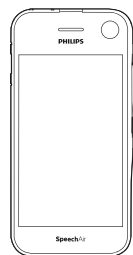

Recorder

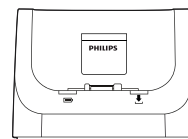

Docking station

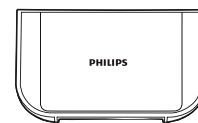

Inlay



USB flash drive

2x

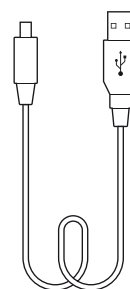

Micro USB cable

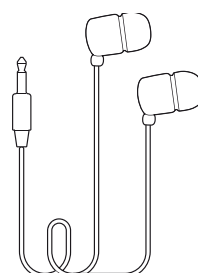

Headphones

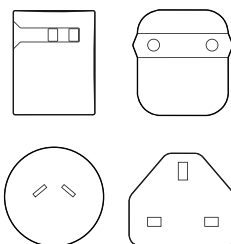

Power supply and outlet adapters



Quick start guide

Overview of the recorder

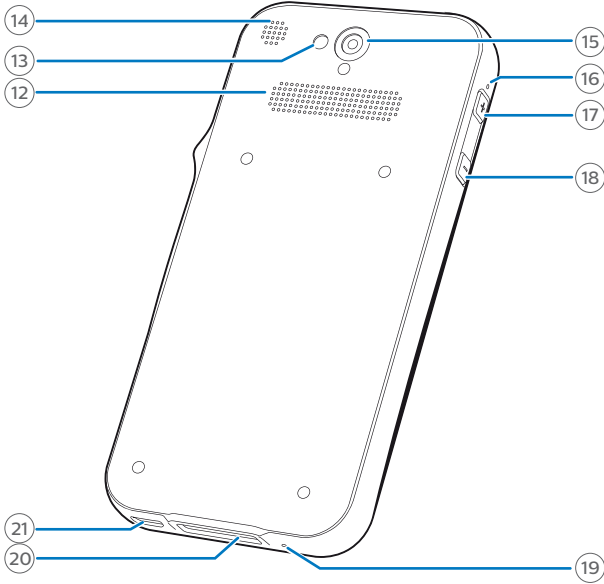
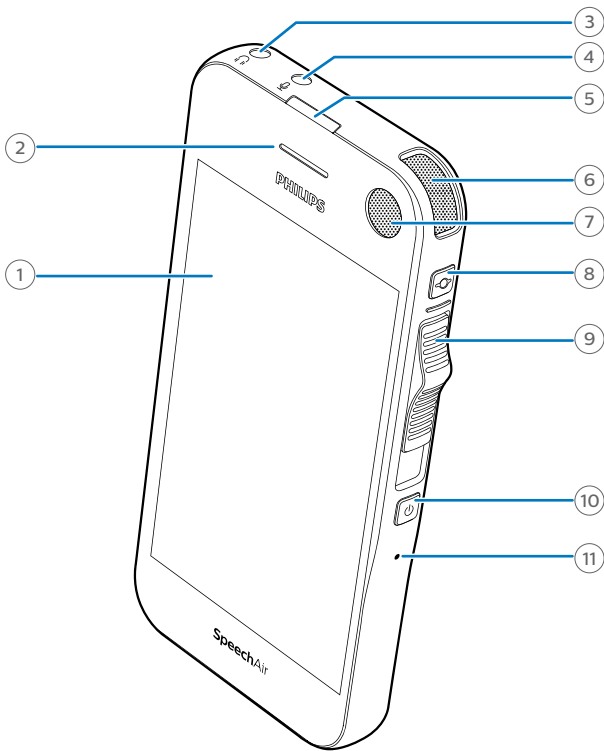

- ① Touch screen
- ② Telephony speaker
- ③ Headphones jack
- ④ External microphone jack
- ⑤ Recording LED light
- ⑥ Dictation microphone (directional microphone)
- ⑦ Dictation microphone (directional microphone)
- ⑧ Function button
- ⑨ Slide switch
- ⑩ Power button
- ⑪ Reset hole
- ⑫ Speaker
- ⑬ Camera flash
- ⑭ Dictation microphone (directional microphone)
- ⑮ Camera
- ⑯ 360° meeting microphone (omnidirectional microphone)
- ⑰ Volume up button
- ⑱ Volume down button
- ⑲ Telephony microphone (VoIP)
- ⑳ Docking station connector
- ㉑ Micro USB port

Overview of the docking station

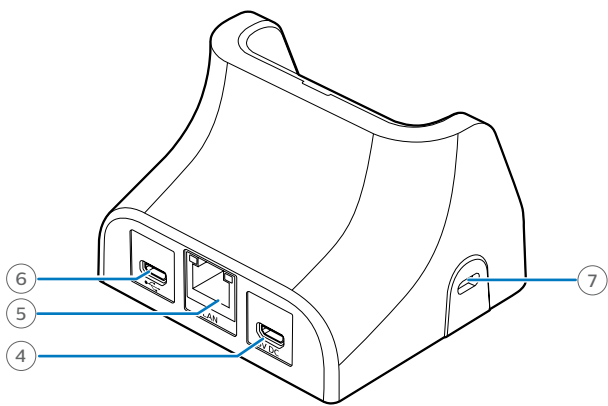
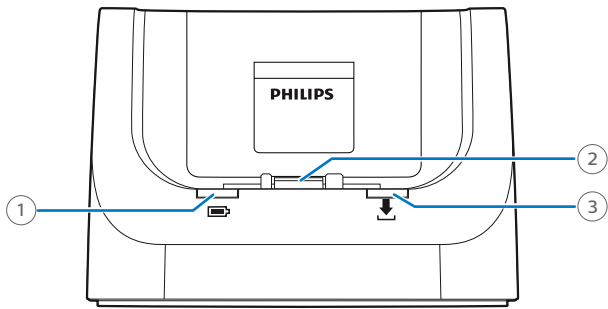

- ① Charging LED light
- ② Docking station connector
- ③ Data transfer LED light
- ④ Data transfer micro USB port
- ⑤ LAN port
- ⑥ Charging micro USB port
- ⑦ Kensington Security Slot

3 Getting started

! Caution

- Before you connect and install your recorder, first read the safety instructions (see [Safety instructions](#)).

Charging the battery

Charge the built-in battery before you use the device for the first time or if you haven't used it for an extended time period. If the battery is completely discharged and your device turns off, allow the battery to charge for a while before you turn on the device.

☰ Note

- The length of the USB cable might impact the charging speed. Longer cables usually extend the charging time.

Charge via USB power supply

☰ Note

- The included USB power supply is a US standard power supply. Depending on your region, you might need to use the supplied outlet adapters to fit regional power outlets.

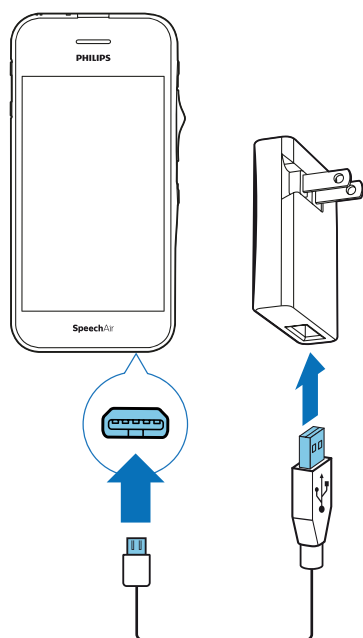

- ↳ The battery icon appears on the touch screen after a few seconds if the device is turned off. This indication disappears after some seconds. To reactivate the indication, press the Power button once.
- ↳ The charging battery icon on the status bar of the Home screen shows the charging status if the device is turned on.

Charge via docking station

If you charge your device via docking station, make sure that the micro USB connector is connected to the charging micro USB port marked with 5V DC.

Charge without case

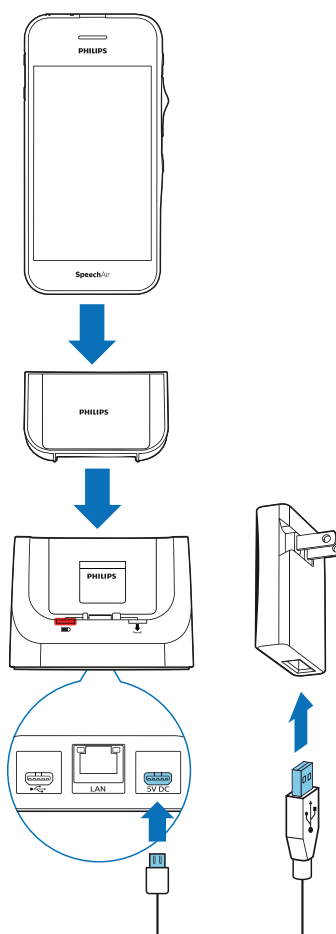

- ↳ The red charging LED on the docking station illuminates.
- ↳ The charging battery icon appears on the touch screen after a few seconds if the device is turned off. This indication disappears after some seconds. To reactivate the indication, press the Power button once.
- ↳ The charging battery icon on the status bar of the Home screen shows the charging status if the device is turned on.

Charge with case (optional)

To charge your SpeechAir with the shock-proof case via docking station, first remove the inlay from the docking station. Afterwards, proceed as described in [Charge without case](#).



Charge via computer

Before you charge the battery via computer, make sure that your computer is turned on.

Note

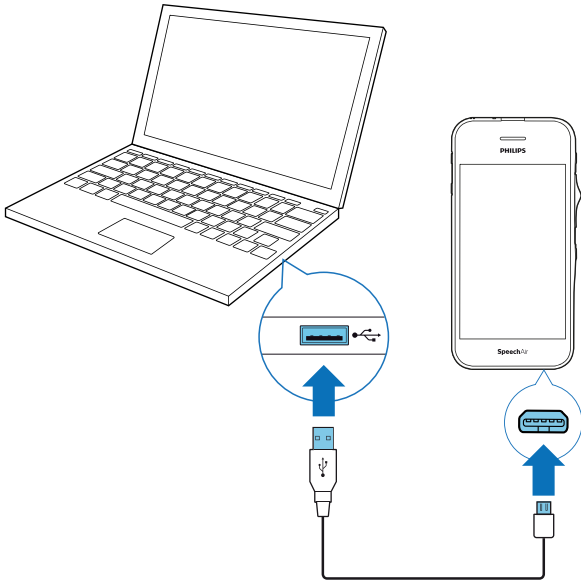
- If you charge your device via computer instead of using the power supply, the charging speed might slow down due to a lower charging current.



- ↳ The battery icon  appears on the touch screen after a few seconds if the device is turned off. This indication disappears when after some seconds. To reactivate the indication, press the Power button once.
- ↳ The USB icon  appears on the touch screen if the device is turned on.

Turn the device on and off

To turn the device on:

- Press and hold the Power button for six seconds until the device gently vibrates.

To turn the device off:

- 1 Press and hold the Power button for one second.
↳ The **Power off** pop-up window appears.
- 2 Tap **Power off**.

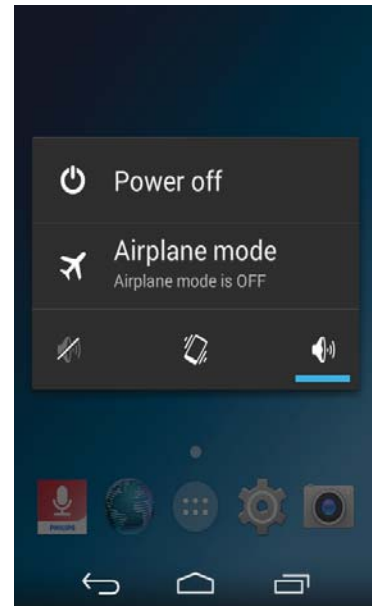

- ↳ A second pop-up window appears.

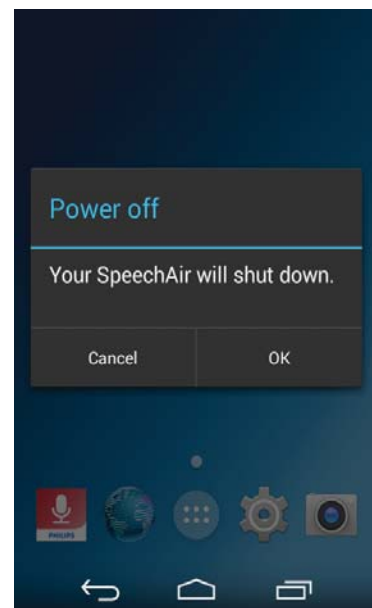

- 3 Tap **OK**.

4 Using your voice recorder

Using the touch screen

The interface of your SpeechAir is operated by touching the screen. To operate the interface, use the following basic gestures:

Tapping



To open an application and to select or unselect an item or menu option:

- Gently tap the item with your fingertip.

To zoom in an image or a web page:

- Double-tap the screen.

To return to the original display size:

- Double-tap the screen again.

To access available options for a selected item:

- Tap and hold the item.

Swiping



To scroll through or switch lists and screens:

- Swipe up, down, left, or right.

Spreading and pinching



To gradually zoom in a part of an image or web page:

- Place your fingers on the screen and spread them apart.

To gradually zoom out again:

- Place your fingers on the screen and pinch them together.

Dragging

To move an item:

- Tap and hold an item and drag it to a new position.

Home screen

From the Home screen, you can access the main features on your recorder and view the status of your device.

Customize your Home screen by adding your favorite apps, widgets and folders, so they're always just a tap away.

You can open the Home screen from anywhere on your device by tapping the Home key .

Keys

At the bottom of your display, no matter which app or feature you are just using, you will always find the navigation bar with the following keys:

Back key 

- Opens the previous screen you were working in, even if it was in a different app. Once you back up to the Home screen, you can't go back any further.

Home key 

- Opens the central Home screen.

Recent Apps key 

- Opens a list of thumbnail images of apps you've worked with recently. This way you can easily and quickly switch between apps or close running apps. To open an app, tap it. To remove a thumbnail from the list, swipe it left or right.

Close Keyboard key 

- Closes the on-screen keypad and replaces the Back key. This key is only available when the keyboard is open. When you tap the Close Keyboard key, the Back key appears on the display again.

Favorites tray

You will find the Favorites tray at the bottom of the Home screen. The Favorites tray is a quick way to access your favorite apps. It is always available when your Home screen is open.

To change the apps on the Favorites tray, see [Add items to Favorites tray](#).



Customize your Home screen

Create your Home screen according to your own preferences. Add apps, widgets, or folders to your Home screen, add Home screen panels, or customize the Favorites tray.



Note

- Depending on the configuration of your device, the starting panel might look different than the starting panel described here.



Add and remove items and widgets

On the All Apps screen, you can find all apps, preinstalled as well as newly installed apps.

To open the All Apps screen, tap the shortcut  on the Home screen.

The All Apps screen has multiple panels. Depending on the number of apps, the device automatically adds new panels. To scroll through the panels, swipe left or right. For more information, see [Manage Home screen panels](#).

Add items to Home screen

To move an app or a folder from the All Apps screen to the Home screen:

- 1 Open the All Apps screen.
- 2 Tap and hold an app or a folder on the All Apps screen, and then drag it to the Home screen.

To move an app or a folder from the All Apps screen to a particular panel of the Home screen:

- 1 Open the All Apps screen.
- 2 Tap and hold an item on the All Apps screen and then drag it left or right to the desired panel.

Add widgets to Home screen

Widgets are small apps that provide specific information and convenient access on your Home screen, such as the bookmarks widget. There are two preinstalled widget panels.

- 1 Tap and hold an empty area on the Home screen.
- 2 Tap **Widgets**.
- 3 Tap and hold a widget, and then drag it to the Home screen.
 - ↳ The **Create widget and allow access** pop-up window appears.
- 4 Tap **Create**, or mark the checkbox **Always allow to create widgets** and then tap **Create**.

To add widgets to a particular panel of the Home screen:

- 1 Tap and hold an empty area on the Home screen.
- 2 Tap **Widgets**.
- 3 Tap and hold a widget, and then drag it left or right to the desired panel.
- 4 Tap **Create**, or mark the checkbox **Always allow to create widgets** and then tap **Create**.

To swipe through widget panels:

- 1 Tap and hold an empty area on the Home screen.
- 2 Tap **Widgets**.
- 3 Swipe right to switch to the next widget panel.

Add items to Favorites tray



Note

- Before you can add items to the Favorites tray, first remove existing items.

You will find the Favorites tray at the bottom of all Home screen panels. With the Favorites tray, you can easily and quickly access frequently used apps and folders. Apart from the non-movable All Apps screen shortcut, you can arrange your Favorites tray as you like.

To move an item to the Favorites tray:

- Tap and hold the item and drag it to the Favorites tray.

To remove an item from the Favorites tray:

- Tap and hold the item and drag it either to **Remove** at the top of the screen or to a Home screen panel.

Remove items and widgets



Note

- By removing items and widgets from the Home screen or Favorites tray, you don't uninstall them. To uninstall items and widgets, see [Uninstall apps](#).

To remove an item or a widget:

- Tap and hold the item on the Home screen, and then drag it to **Remove** at the top of the screen.

Manage Home screen panels

The Home screen has multiple panels. When you use your device for the first time or have reset your data, you will see only the starting panel.

Add a panel

- Tap and hold an item and drag it to the right.
 - ↳ The device automatically adds a new panel.

Remove a panel

- Tap and hold an item on the desired panel and drag it either to **Remove** at the top of the screen or to a different panel.
 - ↳ When you have moved or removed all icons on a panel, the panel is empty and the device automatically removes it.

Move a panel

- 1 Tap and hold an empty area on the Home screen.
 - ↳ A panel preview appears.
- 2 Tap and hold a desired panel and then drag it to a new location.

To scroll through the panels:

- Swipe left or right.

Organize folders

Create a folder

You can create folders on any Home screen panel and also drag them to the Favorites tray.

To create a folder:

- Tap and hold an item and drag it onto another item.

Repeat this step with multiple items which you would like to have in the same folder.

To name or rename a folder:

- 1 Tap the folder.
 - ↳ All apps in the folder are displayed.
- 2 Tap **Unnamed Folder** or the existing name of the folder.

- 3 Name the folder.

Remove a folder

To remove a folder including all its apps:

- Tap and hold the folder and then drag it to **Remove** at the top of the screen.

To only delete a folder, but keep its apps:

- Tap the folder. Tap and hold each app and drag it out.
 - ↳ The folder is deleted automatically.

Status bar and notification panel

Status bar



Note

- In some apps, the status bar might not appear. To view the status bar from these apps, swipe down from the top of the screen.

The status bar at the top of the screen shows indicator icons. On the left side of the status bar, you will find new notifications, such as email notifications. On the right side of the status bar, status information is displayed, such as the time, battery status, or Wi-Fi connection.

Find the most common status bar icons in the following table:

Icon	Meaning
	Wi-Fi connected
	Bluetooth activated
	Battery power level
	Charging battery
	Airplane mode activated
	Mute mode activated
	Vibration mode activated
	New email
	Recording dictation (when outside the recording screen of Philips dictation recorder app)

Notification panel

The notification panel allows you to see a preview of your notifications on the status bar, which you can either acknowledge or clear. You can also access Quick Settings from the notification panel and quickly adjust basic settings.

Open the notification panel

- Swipe down from the top of the screen.

Close the notification panel

- Swipe up on the screen.



- Indicator icons remain on the status bar until you either acknowledge or clear them.

Acknowledge a notification

- Tap the notification.

Clear all notifications

- Tap 

Quick Settings

The notification panel also allows you access to Quick Settings, where you can quickly adjust basic settings, such as Wi-Fi or Bluetooth, and access the Settings menu.

To access Quick Settings:

- 1 Swipe down from the top of the screen.
- 2 Tap 

Lock screen

When you use your SpeechAir for the first time or have reset your data, no screen lock is set.

You can lock the touch screen when it's active to prevent any unwanted device operations or access as well as to save battery power. When your device is on and not used for a set time period, the screen turns off and locks automatically.



- The status bar is also displayed in lock screen mode.

Lock and unlock the screen

To turn off and lock the screen:

- Briefly press the Power button.

To turn on and unlock the screen:

- Briefly press the Power button again.

Set screen lock

You can change the screen lock method by using one of the following options: None, Slide, PIN, Password.

- 1 Tap **Settings**  on the Home screen or on the All Apps screen.
- 2 Swipe down and tap **Security**.
- 3 Tap **Screen lock**.
- 4 Select a screen lock method.

None

Choose this option to deactivate the screen lock.

Slide

Choose the slide lock method to unlock the screen.

PIN

Enter a personal PIN code consisting of 4-16 digits to unlock the screen.

Password

Enter your personal password consisting of 4-16 characters to unlock the screen.



- If you have set a PIN code or password and want to change your screen lock method, first confirm the old PIN or password.
- Longer PIN codes and passwords are safer than short ones.
- It is very important that you remember your PIN or password. If you forget this information, it might not be possible to restore important data.

Set the date and time

You can always change the date and time on your device and how they are displayed. Choose if you want SpeechAir to set the date and time automatically or change the settings manually.

To set the date and time automatically,

- 1 Tap **Settings**  on the Home screen or on the All Apps screen.
- 2 Swipe down and tap **Date & time**.
- 3 Mark the checkbox next to **Automatic date & time**.

To set the date and time manually:

- 1 Tap Settings  on the Home screen or on the All Apps screen.
- 2 Swipe down and tap **Date & time**.
- 3 Unmark the checkbox next to **Automatic date & time**.
- 4 Tap **Set date** or **Set time**.
- 5 Swipe up or down to set the desired date or time.

In the **Date & time** menu, you can also select a time zone and the date and time format.

Set the device and input language



You can always change the device and input language.

If you choose a device language, the device sets the relevant input language automatically.

Change the device language

- 1 Tap **Settings**  on the Home screen or on the All Apps screen.
- 2 Swipe down and tap **Language & input**.
- 3 Tap **Language**, and then select the language to use.

Change the input language

- 1 Tap **Settings**  on the Home screen or on the All Apps screen.
- 2 Swipe down and tap **Language & input**.
- 3 In the **Keyboard & Input methods** sub-menu, tap .
↳ The **Android Keyboard Settings** window opens.
- 4 Tap **Input languages**.
↳ The **Input languages** window opens.
- 5 Make sure that the checkbox next to **Use system language** is unmarked.

- 6 Change the language or select multiple languages to use from the list by marking the relevant checkboxes.

Switch between input languages

If you have selected two or more input languages, you can switch between the languages on your keyboard.

- 1 Tap and hold the space key on your keyboard.
↳ The **Choose input method** pop-up window appears.
- 2 Select the desired language from the list.

Alternatively, tap  next to the space key to switch between the input languages. For more information about using the keyboard, see [Typing text](#).

Using apps

Preinstalled apps

You can find multiple preinstalled apps on your SpeechAir. This allows you to perform basic tasks with your SpeechAir, such as sending an email, browsing the Internet, or taking photos. Four apps are already set on the Favorites tray. More apps are available on the All Apps screen.

To open the All Apps screen, tap the All Apps screen shortcut  on the Home screen. See more information about organizing apps in [Customize your Home screen](#).

Install apps

SpeechAir doesn't support Google Play Store due to security reasons. However, you can install apps by copying and downloading an installation file (.apk file, for example, Filename_xy.apk) for the relevant app to your SpeechAir. This installation file is necessary to install an app on your SpeechAir. We highly recommend using a source you trust for downloading installation files.



Note



- Only the preinstalled apps have been tested for SpeechAir. Download and install apps from external sources only at your own risk. Philips assumes no liability for the functioning of any external apps.
- If you use apps from external sources, make sure that they are compatible with Android 4.4.2.
- Before you download apps from external sources, make sure that the checkbox in **Settings > Security > Unknown sources** is marked.

To install apps via installation file:



Note

- Make sure that your SpeechAir is turned on when you connect it to the computer. Your computer can only detect SpeechAir when it is turned on.

- 1 Connect your device to the computer.
- 2 Open Windows Explorer on a Windows computer, or open Finder on a Mac computer.
 - ↳ SpeechAir is recognized as an external drive.
- 3 Double-click the SpeechAir drive.
 - ↳ The content of your SpeechAir is displayed in a new window.
- 4 Drag the downloaded installation file (.apk file, for example, Filename_xy.apk) to the SpeechAir window.
 - ↳ The .apk file is now available on your SpeechAir.
- 5 Disconnect your device from the computer.
- 6 Tap  on SpeechAir, and then tap **Explorer** .
- 7 Tap **SA-HARDDISK**.
- 8 Swipe to the .apk file, for example, Filename_XY, and tap the .apk file.
- 9 Tap **Next** twice, and then tap **Install**.
 - ↳ The app is installed.
- 10 Tap **Done** to go back to the SA-HARDDISK screen, or tap **Open** to open the app.

Uninstall apps



Caution

- It is not possible to uninstall preinstalled apps, you can only disable them.
- Disabling preinstalled apps might cause other apps to misbehave and will delete associated data for the relevant app.

- **Disable:** Disable preinstalled apps that can't be uninstalled from the device.
- **Uninstall:** Uninstall newly installed apps

To uninstall or disable an app:

- 1 Tap **Settings**  on the Home screen or on the All Apps screen.
- 2 Tap **Apps**.
- 3 To uninstall a downloaded app, select it from the **Downloaded** tab.
To disable a preinstalled app, swipe right to the **All** tab and select the desired app.
 - ↳ The **App info** window opens.
- 4 Tap **Uninstall** or **Disable**.

Alternatively, uninstall an app following the next steps:

- 1 Open the All Apps screen.
- 2 Tap and hold the app you would like to uninstall.
- 3 Drag it to **Uninstall** in the upper left corner of the screen.
 - ↳ A pop-up window appears asking you to cancel or confirm uninstalling the app.
- 4 Tap **OK**.

Change the screen orientation



Tip

- If your screen doesn't automatically change the view when you turn your device sideways, go to **Settings > Display** and mark the checkbox next to **Auto-rotate screen**.

In many apps, you can change the view of your screen when you rotate your device. The screen automatically changes the orientation from portrait to landscape when you turn the device sideways. When entering text, you can turn the device sideways to bring up a bigger keyboard.

Typing text



Tip

- If the on-screen keyboard doesn't open automatically, tap the text field to open the keyboard.

You can enter text with the on-screen Android keyboard (AOSP). The on-screen keyboard opens automatically when you use apps and options where entering text is needed. Set and use multiple keyboard languages, and switch between them while typing (see [Change the input language](#)).

You can also rotate your device to change the keyboard view from portrait to landscape and bring up a bigger keyboard.

Enter text

- Tap each letter on the keyboard individually.
- To uppercase, tap shift.
- To use caps lock, double-tap Shift.
- To release caps lock, tap Shift again.

Delete text

- Tap  on the keyboard.

Enter additional characters

- Tap the additional character key  on the keyboard.
 - ↳ The additional character key automatically changes to a letter key.

Return to the text keyboard

- Tap the letter key  on the keyboard.

Switch between the input languages



Note

- Before you can switch between the input languages on your keyboard, first set your desired input languages (see [Change the input language](#)).

- 1 Tap and hold the space key on your keyboard.
↳ The **Choose input method** pop-up window appears.

- 2 Select the desired language from the list.

Alternatively, tap  next to the space key to switch between the input languages.





Enter language-specific characters

- 1 Select the desired input language on your keyboard as described in [Switch between the input languages](#).
- 2 Tap and hold the desired key.
↳ A pop-up window appears above the key showing available characters.
- 3 Select a character by dragging your finger left or right to the desired character, and then release your finger.

Hide the keyboard

- Tap  on the Home screen when the on-screen keyboard is open.

Copy and paste text

- 1 Tap and hold or double-click part of the entered text.
↳ The selected part of the text is marked.
- 2 Tap and drag  or  left or right to select the text you would like to copy or cut.
↳ An action bar appears at the top of the screen showing available options.
- 3 Tap  to copy or  to cut the text.
- 4 Place the cursor by tapping and holding where you would like to insert the text.
- 5 Tap **Paste** above the marked text.

Using Wi-Fi

Use Wi-Fi to connect your SpeechAir to the Internet or other network devices wirelessly anywhere a Wi-Fi access point or hotspot is available.



Note

- Using Wi-Fi might consume additional battery power. Turn off Wi-Fi when not in use to save battery power.
- The Wi-Fi signal strength might vary depending on obstacles and the distance between the device and Wi-Fi access point.

Turn on Wi-Fi

- 1 Tap **Settings**  on the Home screen.
- 2 Tap the Wi-Fi switch or drag it to the right to turn on Wi-Fi.
↳ Your device searches for available Wi-Fi networks.

Alternatively, turn on Wi-Fi by using Quick Settings:



- 1 Swipe down from the top of the screen.
- 2 Tap  to open Quick Settings.
- 3 Tap **Wi-Fi Off**.
- 4 Tap the Wi-Fi switch or drag it to the right to turn on Wi-Fi.
↳ Your device searches for available Wi-Fi networks.

Connect to a Wi-Fi network





Note

- If you select a secured network, you will be prompted to enter the relevant password or network key.
- If you select an open network, you will be automatically connected to the network.

- 1 Tap **Settings**  on the Home screen.
- 2 Tap **Wi-Fi**.
↳ All available Wi-Fi networks are displayed.
- 3 Select a Wi-Fi network to connect to.
- 4 Tap **Connect**.
↳  is displayed on the status bar once you are connected.

Alternatively, connect to a Wi-Fi network by using Quick Settings:

- 1 Swipe down from the top of the screen.
- 2 Tap  to open Quick Settings.
- 3 Tap **Wi-Fi**.
↳ All available Wi-Fi networks are displayed.
- 4 Select a Wi-Fi network to connect to.

- 5 Tap **Connect**.
↳  is displayed on the status bar once you are connected.

Change the Wi-Fi network

- 1 Tap **Settings**  on the Home screen.
- 2 Tap **Wi-Fi**.
↳ All available Wi-Fi networks are displayed.
- 3 Select a different Wi-Fi network to connect to.

Alternatively, change the Wi-Fi network by using Quick Settings:

- 1 Swipe down from the top of the screen.
- 2 Tap  to open Quick Settings.
- 3 Tap the active Wi-Fi network.
↳ All available Wi-Fi networks are displayed.
- 4 Select a different Wi-Fi network to connect to.

If you have turned on Wi-Fi, but haven't connected to a network yet, a Wi-Fi symbol with a question mark is displayed on the status bar. This notification informs you that there are Wi-Fi networks available.

To open the Wi-Fi network notification:

- 1 Swipe down from the top of the screen.
- 2 Tap the Wi-Fi notification.
↳ All available Wi-Fi networks are displayed.



Using Bluetooth

Use Bluetooth to connect your SpeechAir to other Bluetooth-compatible devices for exchanging files.



Note

- Using Bluetooth might consume additional battery power. Turn off Bluetooth when not in use to save battery power.
- The Bluetooth signal strength might vary depending on obstacles and the distance between the paired devices.
- iPhone devices don't support file transfer via Bluetooth from an Android device.

Turn on Bluetooth

- 1 Tap **Settings**  on the Home screen or on the All Apps screen.
- 2 Tap **Bluetooth**.
- 3 Tap the Bluetooth switch or drag it to the right to turn on Bluetooth.
↳ The Bluetooth symbol  is displayed on the status bar when Bluetooth is turned on.

Alternatively, turn on Bluetooth by using Quick Settings:

- 1 Swipe down from the top of the screen.
- 2 Tap  to open Quick Settings.
- 3 Tap **Bluetooth Off**.
- 4 Tap the Bluetooth switch or drag it to the right to turn on Bluetooth.
↳  is displayed on the status bar when Bluetooth is turned on.



Pair with other devices

Note



- If the device you want to pair with is not displayed in the list of available Bluetooth devices, make sure that it turns on its visibility.
- Some devices might have a generic Bluetooth PIN, such as 0000.

- 1 Turn on Bluetooth.
- 2 Go to the Bluetooth settings in **Settings > Bluetooth**, and turn on your device's visibility by tapping your device name.
- 3 Tap **Search for devices**.
↳ All available Bluetooth devices are displayed.
- 4 Select a device to pair with.
- 5 Enter the passkey or PIN code, if needed, and tap **Pair**. The external device also has to accept the connection and, if needed, enter the passkey or your device's PIN code.

Unpair devices

- 1 Tap **Settings**  on the Home screen or on the All Apps screen.
- 2 Tap **Bluetooth**.
- 3 Tap  next to the device you want to unpair.
↳ The **Paired Bluetooth device** window opens.
- 4 Tap **Unpair**.

Send dictations via Bluetooth

- 1 Turn on Bluetooth on both the sending and the receiving device.
- 2 Select the dictation you want to send.
- 3 Tap the share icon .
- 4 Select Bluetooth .
- 5 Accept the Bluetooth connection request on the paired device.

Capture screenshots

Capture images of your screen while you are using your device.



Note

- Taking screenshots might not be possible in some apps and features.

To capture a screenshot:

- Press and hold the Power button and the Volume down button simultaneously.
 - ↳ Captured images are saved to **Gallery** 
 - ↳ A notification symbol is displayed on the status bar.



Change sound settings and sound mode

Change the settings for various sounds on your device. You can also switch between the sound modes loud, mute and silent.

To change the settings for system sounds:

- 1 Tap **Settings**  on the Home screen or on the All Apps screen.
- 2 Tap **Sound**, and change the desired settings.

To change the sound mode:

- 1 Press the Volume down button all the way down until the sound mode switches to mute.
 - ↳ The mute mode icon  is displayed on the status bar.
 - ↳ The sound is turned off and your device only vibrates now.
- 2 In mute mode, press the Volume key once more to switch the sound mode to silent.
 - ↳ The silent mode icon  is displayed on the status bar.
 - ↳ The sound and the vibration are turned off.
- 3 To turn the vibration on again when in silent mode, press the Volume up button once.
- 4 To turn the sound on again, press the Volume up button until the desired volume is reached.

Power saving mode

To save your SpeechAir's battery power, you can set the display brightness to be automatically controlled, reduce the brightness of the display and the backlight time, or turn on Airplane mode.

Set automatic display brightness or reduce the brightness

- 1 Swipe down from the top of the screen.
- 2 Tap  to open Quick Settings.
- 3 Tap **Brightness**.
- 4 To set automatic display brightness, tap the blue **Auto** bar.
To reduce the display brightness, tap and hold the blue control, and drag it left.

Alternatively, adjust the display brightness following the next steps:

- 1 Tap **Settings**  on the Home screen or on the All Apps screen.
- 2 Tap **Display**.
- 3 Tap **Brightness**.
- 4 To set automatic display brightness, tap the blue **Auto** bar.
To reduce the display brightness, tap and hold the blue control, and drag it left.

Reduce the backlight time

- 1 Tap **Settings**  on the Home screen or on the All Apps screen.
- 2 Tap **Display**.
- 3 Tap **Sleep**.
 - ↳ The **Sleep** pop-up window appears.
- 4 Select the length of time for your screen to turn off the backlight when the device is not used.

Turn on Airplane mode

In Airplane mode, SpeechAir's signal transmitting functions are turned off. This way you can save battery power.

To turn on Airplane mode:

- 1 Swipe down from the top of the screen.
- 2 Tap  to open Quick Settings.
- 3 Tap **Airplane Mode**.

Alternatively, turn on Airplane mode by following the next steps:

- 1 Tap **Settings**  on the Home screen or on the All Apps screen.
- 2 Tap **More...**
- 3 Tap **Airplane Mode**.

Using email app

On the All Apps screen, you will find a preinstalled Android email app. Alternatively, you can also use the browser on your device to check your emails.

To open the email app:

- Tap  on the Home screen, and then tap **Email** .

Set up an email account

Set up an email account to send and receive emails with the email app.

Note

- Before you set up an account, make sure that Wi-Fi is turned on and that you are connected to a Wi-Fi network.

Initial email account setup

- 1 Open the email app on the All Apps screen.
↳ The **Account setup** window opens.
- 2 Enter a valid email address into the **Email address** text field.
- 3 Enter the relevant password you use for your email address into the **Password** text field.
- 4 Tap **Next**.
- 5 Select the desired options for your account.

Note

- Setting short inbox checking frequency intervals might consume additional battery power.
 - If you want to change the inbox checking frequency, tap the relevant field.
↳ A drop-down list opens.
 - Select the desired frequency for email synchronization.
- 6 Tap **Next**.
 - 7 If necessary, enter a name which is displayed on outgoing messages. Optionally, change the account name, then tap **Done**.

Manual email account setup

If you want to set up an email account manually, make sure that you have the correct server settings.

IMAP or POP is an email protocol used to download emails to your device. If you're not sure whether to use IMAP or POP, contact your email provider or check the Internet for more information.

- **IMAP**: Emails are stored on remote email servers until you delete them.
- **POP**: Emails are downloaded for offline reading and might be removed from the remote server.
- **Exchange**: A company email address that uses Microsoft Exchange servers.

Note

- If you set up an IMAP or POP account, only your emails will be synchronized to your device. Any other information associated with that account, for example, calendar details, remain stored on your local computer.

To set up an email account manually:

- 1 Open the email app on the All Apps screen.
↳ The **Account setup** window opens.
- 2 Enter a valid email address into the **Email address** text field.
- 3 Enter the relevant password you use for your email address into the **Password** text field.
- 4 Tap **Manual setup**.
- 5 Depending on the type of account you're setting up, select **IMAP**, **POP3** or **Exchange**.
- 6 If necessary, check all server settings for incoming emails, and tap **Next**.
- 7 If necessary, check all server settings for outgoing emails, and tap **Next**.
- 8 Select the desired options for your account.

Note

- Setting short inbox checking frequency intervals might consume additional battery power.
 - If you want to change the inbox checking frequency, tap the relevant field.
↳ A drop-down list opens.
 - Select the desired frequency for email synchronization.
- 9 Tap **Next**.
 - 10 If necessary, enter a name which is displayed on outgoing messages. Optionally, change the account name, and then tap **Done**.

If you have problems setting up your account, check that you have entered your email address and password correctly, and then try again.

If you still can't set up your account, there might be a problem with the server settings. In this case, contact your email provider or visit their website.

Add further email accounts

- 1 Tap **Settings**  on the Home screen or on the All Apps screen.
- 2 Swipe down, and tap **Add account**.
- 3 Tap **IMAP** or **Corporate**.
- 4 Proceed as described in [Set up an email account](#).



Switch email accounts

If you have added more than one email account, you can switch between the accounts when you want to send an email.

To switch email accounts:

- 1 Open the email app on the All Apps screen.
- 2 In the Email window, tap  in the upper left corner.
 - ↳ A sliding sidebar opens.
 - ↳ All available email accounts are displayed on the sliding sidebar.
- 3 Select your desired account.

Remove email accounts

- 1 Tap **Settings**  on the Home screen or on the All Apps screen.
- 2 Swipe down, and tap **IMAP** or **Exchange**.
- 3 Tap the account you want to remove.
- 4 Tap the options icon .
 - ↳ Tap **Remove account**.
- 5 The **Remove account** pop-up window appears.
- 6 Tap **Remove account**.

Send an email

- 1 Open the email app on the All Apps screen.
- 2 Tap the options icon  in the upper right corner.
- 3 Select **Compose**.
 - ↳ The **Compose** email window opens.
- 4 Enter a recipient and a subject, and then enter your email text by tapping the relevant text field.

- 5 Tap the Send icon .

Email account settings

You can always change the general email settings as well as account-specific settings.

To change email account settings:

- 1 Tap **Settings**  on the Home screen or on the All Apps screen.
- 2 Swipe down, and tap **IMAP** or **Exchange**.
 - ↳ All IMAP or Exchange accounts are displayed.
- 3 Tap **Account settings**.
- 4 To change general email settings, tap **General settings**. To change account-specific settings for a particular account, select the account.
- 5 Select the options for your accounts.

Device settings

In the preinstalled Settings app, you can select various options related to networks, your device, privacy settings, accounts and the system.

To open the Settings app:

- Tap **Settings**  on the Home screen or on the All Apps screen.

Setting	Function
Wi-Fi	<ul style="list-style-type: none">• Turn Wi-Fi on or off.• Select and connect to Wi-Fi networks.• Change Wi-Fi settings.
Bluetooth	<ul style="list-style-type: none">• Turn Bluetooth on or off.• Select and connect to available Bluetooth devices.• Change Bluetooth settings.• View received Bluetooth files.
Data usage	<ul style="list-style-type: none">• Track your data usage for communication via the network.
More...	<ul style="list-style-type: none">• Select Wireless & networks options, for example, Airplane mode or VPN.
Sound	<ul style="list-style-type: none">• Set sound volumes and system sounds.
Display	<ul style="list-style-type: none">• Change display settings, for example, wallpaper or sleep mode.
Storage	<ul style="list-style-type: none">• Track the available and used storage of your device.
Battery	<ul style="list-style-type: none">• Track the battery usage and status.
Apps	<ul style="list-style-type: none">• Check information about all installed apps.
Location	<ul style="list-style-type: none">• Change the location mode.• View recent location requests by apps.
Security	<ul style="list-style-type: none">• Select various security options.
Language & input	<ul style="list-style-type: none">• Select various language and input options, for example, device or input languages.
Backup & reset	<ul style="list-style-type: none">• Reset your device to its original system state and delete all data.

Setting	Function
Add account	<ul style="list-style-type: none">• Add a new email account.
Date & time	<ul style="list-style-type: none">• Set the date and time for your device.
Accessibility	<ul style="list-style-type: none">• Select various options for a personalized access to your device.
About SpeechAir	<ul style="list-style-type: none">• View information about your device.

5 Philips dictation recorder app

The Philips dictation recorder app is designed to fit perfectly with your SpeechAir. Recording, editing, and sending dictation files from your SpeechAir offers mobile flexibility and reduces document turnaround times.



Note

- Depending on the configuration of your device, a different dictation app than the Philips dictation recorder app might be preinstalled on your SpeechAir. For information about other preinstalled dictation apps, contact the supporting Philips partner you purchased your device from.
- Only the default configuration of the slide switch is described in the following section. Your device's slide switch assignment might vary depending on your device's configuration. For more information, contact the supporting Philips partner you purchased the device from. Change the slide switch assignment in **Settings > User interface > Slider assignment**.

Open the app

The Philips dictation recorder app is preinstalled on your device. You will find the app on the Favorites tray of your Home screen. This way you can start dictating from any Home screen panel.

To open the app:

- 1 Open the app  on the Home screen or on the All Apps screen.
 - ↳ A quick walkthrough appears when you open the app for the first time.
- 2 Swipe right to navigate through the walkthrough. To close the walkthrough, tap the Back key on your device .
- ↳ The recording screen is displayed, and you can start dictating straight away.

One-touch start

Start the Philips dictation recorder app with only one touch. Press the function button once to start the app from anywhere on your device.



Note

- To use the one-touch start feature, your device needs to be unlocked. The function button can't be used in lock screen mode.

The recorder app has three tabs: Dictate, Recordings and Settings.

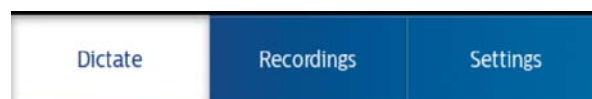

In the Dictate tab, you can record dictations and select all main options related to your current recording, for example, mark a priority dictation, lock the dictation, or edit the recording.

In the Recordings tab, all your recordings are listed. Open, edit or delete dictations from the list.

In the Settings tab, general settings related to your recordings, such as forwarding settings or security settings, are available. To switch between the screens, select the desired tab.

Recording screen

The recording screen is the main interface for recording dictations and editing existing recordings. Mark a recording as a priority dictation, edit the dictation name, add an index, insert, overwrite or append recordings, and more.



Tip

- Change the name of your recording by tapping it either on the recording screen or in the Properties window (see table below).

Find the description of the icons on the recording screen in the following table:



Key	Function
-----	----------

- | | |
|------------------------------|--|
| 1 Start new recording | <ul style="list-style-type: none"> • Start a new dictation right from the recording screen. The current audio file is automatically saved to your recordings list in the Recordings tab when you start a new dictation. |
| 2 Properties | <ul style="list-style-type: none"> • Add a picture to your dictation. • Add various keywords to your dictation, for example, worktype, author, or attributes. Before you add keywords, first set them up in Settings > Forwarding > Workflow. |
| 3 Sending options | <ul style="list-style-type: none"> • Select an option how you want to send your dictation. |
| 4 Barcode scanner | <ul style="list-style-type: none"> • Scan a barcode. The barcode is automatically added to your dictation. |
| 5 Dictation name | <ul style="list-style-type: none"> • Shows the title of the dictation. If you want to change the dictation name, tap the title and enter the new dictation name. |
| 6 Audio time | <ul style="list-style-type: none"> • Shows the passed and the total time of the recording. |
| 7 Microphone mode | <ul style="list-style-type: none"> • Shows the microphone mode. The microphone mode can be controlled by the built-in motion sensor which senses when the device is placed on the desk or held in the hand. The microphone mode is set accordingly then. |
| 8 Record key | <ul style="list-style-type: none"> • Shows that a dictation is being recorded when the slide switch is in the recording position. |
| 9 Stop key | <ul style="list-style-type: none"> • Shows that the recording is stopped when the slide switch is in the stop position. • Shows that the playback of a recording is stopped when the slide switch is in the stop position. |

Key	Function
⑩ Play key	<ul style="list-style-type: none"> Shows that a recording is being played back when the slide switch is in the playback position.
⑪ Rewind key	<ul style="list-style-type: none"> Shows that the recording is being rewinded as long as the slide switch is pressed in the rewind position.
⑫ Audio progress bar	<ul style="list-style-type: none"> Shows your current position in the recording.
⑬ Author name	<ul style="list-style-type: none"> Shows the author name. If you want to change the author name, select a different name in the Properties window.
⑭ Worktype	<ul style="list-style-type: none"> Shows the worktype, for example, email, fax, or letter. If you want to change the worktype, select a different type in the Properties window.
⑮ Category	<ul style="list-style-type: none"> Shows a particular category, for example Standard or Confidential. If you want to change the category, select a different one in the Properties window.
⑯ Barcode number	<ul style="list-style-type: none"> Shows the barcode number. When you scan a barcode, the barcode number is added automatically to your current dictation. You can also change the barcode number manually in the Properties window.
⑰ End of letter key (EOL)	<ul style="list-style-type: none"> Lock your dictation to prevent it from being accidentally modified. The Send options window automatically pops up when you tap the EOL key. This setting must be enabled in Settings > Forwarding > Send EOL dictations automatically. If you don't want to send the dictation straight away, you can see the status of your dictation in the recordings list. The dictation is marked as



Key	Function
⑱ Priority key	<ul style="list-style-type: none"> Mark your dictation as a priority dictation.
⑲ Index key	<ul style="list-style-type: none"> Set an index to mark certain points in a dictation as points of reference.
⑳ Edit mode	<ul style="list-style-type: none"> Edit an existing dictation by overwriting a part of it, inserting or appending additional recording parts.

Record dictations

Define settings prior to recording

Before you start a recording session, set the desired preferences for your recordings, such as audio settings, forwarding settings, security and user interface settings. The most important settings for your recordings are described below. For information about further settings, see [Dictation app settings](#).

Microphone sensitivity

Adjust the microphone sensitivity of your SpeechAir. Select the sensitivity according to the background noise, number of speakers and distance between speaker and microphone.

Low:

5-10 cm (2-4 inches) speaking distance

Medium:

10-20 cm (4-8 inches) speaking distance

High:

Large speaking distance as in meetings, interviews, or conferences

To set the microphone sensitivity:

- 1 Tap **Settings** in the dictation app.
- 2 Tap **Audio Settings**.
- 3 In the **Microphone sensitivity** sub-menu, tap **Sensitivity**, and select the appropriate sensitivity level **Low**, **Medium**, or **High**.

Microphone directivity

Directional:

- The focus is on the right microphone.
- Background sounds are filtered.
- Recommended for dictations with much background noise and low microphone sensitivity.

360°:

- The focus is on the left microphone.
- Sounds from all directions are recorded.
- Recommended for dictations with little background noise and high microphone sensitivity.

SpeechAir allows you to record high-quality single-speaker dictations as well as multi-speaker dictations. By default, the microphone directivity is set to 360° in order to allow the best recording quality for single-speaker as well as multi-speaker dictations.

We recommend using the directional microphone for single-speaker dictations in noisy environments and when you send dictations to speech recognition software. For all other situations, we recommend using the 360° microphone.

You can always change the microphone directivity according to your own preferences.

To change the microphone settings:

- 1 Tap the **Settings** tab in the app.
- 2 Tap **Audio settings**.
- 3 Tap **Mic in hand** or **Mic on desk**, and select the desired setting.

Audio format

Set the recording quality for your dictations and choose between the audio formats WAV (PCM) and DS2 (DSS Pro). DS2 is preset as the standard audio format, but you can always change the audio format in **Settings > Audio settings > Audio format**.

Function button assignment

Change the functionality of the right function button on your device. Choose between End of letter, New dictation, or Fast forward, or disable this feature. The default assignment of the function button is set to End of letter.



Note

- You can only change the function button assignment if your slide switch is set to International. For more information, see [User interface](#).

To change the function button assignment:

- 1 Go to **Settings > User interface > Button assignment**.
↳ The **Button assignment** pop-up window appears.
- 2 Select the desired function button functionality.

Record a dictation



Note

- If your device has only 8% or less battery power left while you are recording, you will see a notification message on your screen and hear a notification sound. Your current dictation will be saved automatically. To avoid unintended data loss, you will neither be able to continue recording nor to start a new recording unless you charge your device.
- While you are in recording mode, all options within the dictation recorder app, except for setting index marks, are disabled for security reasons.
- Be careful not to cover the 360° microphone with your hand or fingers while recording. This might result in a lower recording quality.



Tip

- Your recording continues even if you leave the recording screen. If you leave the recording screen, the recording LED will still be lighted and you will see a microphone symbol on the status bar.
- If you want to stop the recording, you have to go back to the recording screen. Moving the slide switch to the stop position doesn't work outside the recording screen.
- To change the slide switch assignment, go to **Settings > User interface > Slider assignment**. For more information, see [Dictation app settings](#).



To record a dictation:

- Make sure that you see the recording screen, and move the slide switch to the recording position 
 - ↳ If you have enabled the record notification beep in Audio settings, you will hear a beep sound when you start recording. For more information, see [Dictation app settings](#).
 - ↳ The recording LED light illuminates green in insert mode and red in overwrite or append mode while recording.

Stop recording

- Move the slide switch to the stop position .

Start a new recording

- 1 In stop mode, tap the new dictation icon .
- 2 Move the slide switch to the recording position .

Voice-activated recording

Use voice activation to start recording when you begin speaking. When you stop speaking, the device will automatically pause recording after two seconds of silence. It will resume only when you begin speaking again.

Before you start using voice-activated recording, make sure that this feature is enabled.

To enable voice-activated recording:

- 1 Tap the **Settings** tab in the app.
- 2 Tap **Audio settings**.
- 3 In the **Voice activation** sub-menu, tap the switch next to **Voice activation** to enable this feature.

Use the voice activation threshold to set the volume at which the device should begin recording.

To set the voice activation level:

- 1 Tap the **Settings** tab in the app.
- 2 Tap **Audio settings**.
- 3 In the **Voice activation** sub-menu, tap **Level**.
- 4 Tap and hold the blue control, and drag it left or right.
- 5 Tap **OK**.

To start voice-activated recording:

- Point the microphone toward the sound source and move the slide switch to the recording position.
 - ↳ The recording starts when you begin speaking (or the sound level is above the voice activation level).
 - ↳ When you stop speaking (or the sound level drops below the voice activation level), the device will automatically pause recording.

To stop recording:

- Move the slide switch to the stop position 

Playback

Select a recording

- 1 Tap the **Recordings** tab.
- 2 If necessary, swipe up to scroll through the recordings list.
- 3 Select the desired recording by tapping it.

Play back a recording

- 1 Move the slide switch to the playback position.
- 2 Press the Volume up or Volume down button on the device to adjust the volume.

To play back a dictation from a certain point of the recording:

- 1 In Stop mode, tap the green marker on the Audio progress bar and drag it left or right to the desired position of the recording.
- 2 Move the slide switch to the playback position.
- 3 Press the Volume up or Volume down button on the device to adjust the volume.

Rewind a recording

- 1 Move the slide switch to the rewind position and hold it.
- 2 Rewind to the desired part of the recording.
- 3 Release the Rewind button to play back the dictation.

Alternatively, rewind a dictation following the next steps:

- 1 In stop mode, tap the green marker on the Audio progress bar and drag it left to the desired part of the recording.
- 2 Move the slide switch to the playback position.
- 3 Press the Volume up or Volume down button on the device to adjust the volume.

Fast forward a recording

- 1 In stop mode, tap the green marker on the Audio progress bar and drag it right to the desired part of the recording.
- 2 Move the slide switch to the playback position.
- 3 Press the Volume up or Volume down button on the device to adjust the volume.

Quick search

Scan backward or forward in the current dictation quickly and precisely. This allows you to find a specific part of the recording.

In stop mode or in playback mode, tap the green marker on the Audio progress bar and drag it left or right to the desired part of the recording.

Delete a dictation

Delete individual dictations or all recordings simultaneously. In addition, use the automatic purge function to automatically delete all your dictations after a set interval.



To delete individual dictations:

- 1 Go to your recordings list in the **Recordings** tab.
- 2 Swipe right.
↳ Checkboxes appear on the left next to each dictation.



- 3 Mark the checkboxes next to the dictations you want to delete.
- 4 Tap the options icon  in the bottom right corner, and then tap **Delete**.
↳ The **Delete recording(s)** pop-up window appears.
- 5 Tap **Yes**.

To delete all dictations simultaneously:

- 1 Go to your recordings list in the **Recordings** tab.
- 2 Swipe right.
↳ Checkboxes appear on the left next to each dictation.
- 3 Tap the options icon  in the bottom right corner, and then tap **Select all**.
- 4 Tap the options icon  in the bottom right corner again, and then tap **Delete**.
↳ The **Delete recording(s)** pop-up window appears.
- 5 Tap **Yes**.

To automatically delete dictations:

- 1 Tap **Settings** in the dictation app.
- 2 Tap **Audio settings**.
- 3 In the **Purge dictations** sub-menu, tap **Purge intervals**.
- 4 Select an interval for your dictations to be purged.

Edit a dictation

Insert, overwrite or append recording

Insert mode: Insert additional recording parts without overwriting existing dictation.

Overwrite mode: Overwrite a previous recording part starting from any point within the dictation.

Append mode: Add additional recording parts after an existing dictation.

- 1 Tap the green marker on the Audio progress bar and drag it left or right to the desired position of the recording.
- 2 Tap .
- 3 Select **Insert**, **Overwrite** or **Append**.

Add index marks

Use one or more index marks to mark certain points in a recording as points of reference.



To add an index mark:

- 1 Rewind or fast forward to the part of your recording where you want to insert an index mark.
- 2 In playback mode or stop mode, tap the index mark icon .
↳ The index number is displayed for one second. Wait for one second before you add further index marks.



To select an index mark:

Before you select an index mark, make sure you are in stop mode.

You have different options to select an index mark:

- Tap an index mark on the Audio progress bar.
- Tap and hold the green marker on the Audio progress bar and drag it left or right to the desired index mark.
- Press the Volume up or Volume down button to jump between the next index marks.

To delete an index mark:

- 1 Select an index mark.
↳ The index mark icon turns red .
- 2 Tap the red index mark icon .
- ↳ The **Delete index mark** pop-up window appears.
- 3 Tap **Yes**.

Add keywords

Add various keywords to each recording, for example, the author's name, a worktype, or attributes. These keywords can help you identify and assign recordings in your workflow solution, for example, Philips SpeechExec software or SpeechLive.

Note

- Before you add keywords to a recording, first set them up.

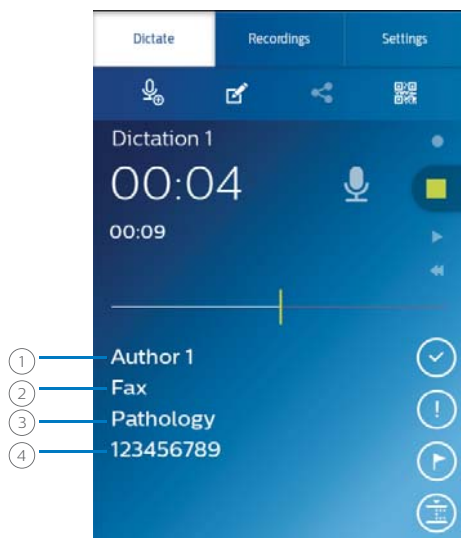

- 1 Author name
- 2 Worktype
- 3 Category
- 4 Barcode

Set up keywords

Set up keywords in order to be able to add them to your dictations.

To set up a keyword:

- 1 Go to **Settings > Forwarding > Workflow** in the dictation recorder app.
- 1 Select the label you want to add keywords to.
- 2 Enter a keyword.
- 3 Tap **OK**.

To add further keywords:

- 1 Go to **Settings > Forwarding > Workflow** in the dictation recorder app.
- 2 Select the label you want to add further keywords to.
- 3 Tap the options icon .

- 4 Tap **Add**.
- 5 Enter a keyword.
- 6 Tap **OK**.

To set a default keyword:



- 1 After you have set up a keyword, go to **Settings > Forwarding > Workflow**.
- 2 Select a label that you have added keywords to.
- 3 Select a keyword from your keywords list.
↳ A pop-up window opens.
- 4 Tap **Set as Default**.

Add keywords to a dictation

Note

- Only the labels Category, Worktype, Author, and Delivery have drop-down lists available. All other labels are free-text fields.
- If you have scanned a barcode, the barcode number will automatically be displayed in the Properties window and on the recording screen.

- 1 Select a recording from your recordings list, and then tap the Properties icon  on the recording screen.



Alternatively, go to your recordings list in the **Recordings** tab, and tap the arrow  next to the relevant recording. Tap the options icon , and then tap **Edit**.

↳ The Properties window opens.

- 2 Tap the text field next to the labels Category, Worktype, Author, or Delivery.
↳ A drop-down list with your predefined keywords opens.
- 3 Select a keyword from the drop-down list.
- 4 Tap the free-text field next to the labels Barcode, Attribute, or Comment, and enter the desired text.
- 5 Tap the Back key when you're finished.
↳ The **Save recording details** pop-up window appears.
- 6 Tap **Save**.
↳ Your selected keywords are displayed on the recording screen.

Add pictures

- 1 Select a recording from your recordings list, and then tap the Properties icon  on the recording screen.



Alternatively, go to your recordings list in the **Recordings** tab, and tap the arrow  next to the relevant recording. Tap the options icon , and then tap **Edit**.

↳ The Properties window opens.



- 2 Tap the Add picture icon .

↳ The **Options** pop-up window appears.

- 3 Tap **Take a picture** to take a photo straight away:

- Tap  to take a photo.
- Tap  to confirm and add the picture to your recording.



Alternatively, tap **Show Gallery** to select a photo from your Gallery app:

- Tap the options icon .
- Tap **Device Gallery**.
- Select a picture.
- Tap the Back key.
 - ↳ The picture is displayed in the Properties window.
 - ↳ An icon  is displayed next to the details of the relevant dictation in the recordings list.



To change an existing picture:

- 1 Select a recording from your recordings list, and then tap the Properties icon  on the recording screen.



Alternatively, go to your recordings list in the **Recordings** tab, and tap the arrow  next to the relevant recording. Tap the options icon , and then tap **Edit**.

↳ The Properties window opens.



- 2 Tap the current picture.

↳ The **Options** pop-up window appears.

- 3 Tap **Take a picture** to take a photo straight away.

- Tap  to take a photo.
- Tap  to confirm and add the picture to your recording.

Tap **Show Gallery** to select a photo from your Gallery app.

- Tap the options icon .
- Tap **Device Gallery**.
- Select a picture.
- Tap the Back key.
 - ↳ The picture is displayed in the Properties window.
 - ↳ An icon  is displayed next to the details of the relevant dictation in the recordings list.

Change dictation name

Change the name of your recordings in order to make it easier to identify and assign your dictations in your workflow solution, for example, SpeechExec software or SpeechLive.

To change the dictation name:

- 1 Select a recording from your recordings list in the **Recordings** tab.
- 2 Tap the dictation name on the recording screen, and edit the existing name. For more information about entering text, see [Typing text](#).

Lock dictations/EOL

Use the End of letter function to lock important recordings and prevent them from being accidentally modified. By default, you can also finish your dictation and send it straight away when you tap the End of letter key.

To lock a dictation:

- 1 Tap the End of letter key while the recorder is in stop mode. Alternatively, press the function button on the right side of the recorder.
 - ↳ The dictation is now marked as locked  on the recording screen and cannot be modified. It is also marked as locked in the recordings list:



↳ The **Send options** pop-window appears if this setting is enabled in **Settings > Forwarding > Send EOL dictations automatically**.

- 2 To unlock a dictation and make changes to the recording, tap the End of letter key or press the function button again while the recorder is in Stop mode.

Mark priority dictations

Mark your recording as a priority dictation. With the priority option, it is easier to identify and prioritize urgent recordings during transcription.

To assign priority status to a dictation:

- 1 Tap the Priority key  while the recorder is in stop mode.
 - ↳ The recording is marked as a priority dictation in your recordings list in the **Recordings** tab.



- 2 To change the priority status of a dictation, tap the priority key again while the recorder is in stop mode.

Add barcodes

With the dictation app's built-in barcode scanning function you can scan QR codes as well as one-dimensional (linear) barcodes. Your device detects barcodes on paper and on screens.



Note



- The maximum scanning distance depends on various factors, such as print quality and size of the barcode, distance between camera and barcode, or lighting conditions.

To add a barcode to a dictation or change a barcode:

- Tap the barcode icon  while the recorder is in stop mode, and scan the barcode.
 - ↳ When the device recognizes the barcode, you will hear a notification sound.
 - ↳ The barcode is automatically displayed on the recording screen.

To add or change a barcode manually:



- 1 Tap the properties icon  on the recording screen.

Alternatively, go to your recordings list in the **Recordings** tab, and tap the arrow  next to the relevant recording. Tap the options icon , and then tap **Edit**.
 - ↳ The Properties window opens.
- 2 Tap the free-text field next to **Barcode** and enter the a barcode.



Send a dictation

Send an individual dictation or multiple dictations simultaneously, and choose between various forwarding options. Before you send your dictations, set up the relevant sending options in **Settings > Forwarding**. For more information, see [Dictation app settings](#).

Send an individual dictation

- 1 Make sure that you are connected to a Wi-Fi network.
- 2 Tap  on the recording screen.
 - ↳ The **Send options** pop-up window appears.
- 3 Select your desired sending option from the displayed list.
 - ↳ The dictation is marked as sent  in the recordings list.

Send multiple dictations simultaneously



- 1 Make sure that you are connected to a Wi-Fi network.
- 2 Open your recordings list from the **Recordings** tab.
- 3 Swipe right.
 - ↳ Checkboxes appear on the left next to each dictation.
- 4 Mark the checkboxes next to the dictations you want to send.
- 5 Tap the options icon  in the bottom right corner, and then tap **Send**.
 - ↳ The **Send options** pop-window appears.
- 6 Select your desired sending option from the displayed list.
 - ↳ The dictation is marked as sent  in the recordings list.

Send a dictation via email



Before you send a dictation via email:

- Set up an email account first. Alternatively, set up an email account when you send the recording via email for the first time. If you haven't set up an account yet, you will be prompted to create an account when you send the dictation. For more information about how to set up an email account, see [Using email app](#).
- Make sure that the email option is enabled in **Settings > Forwarding**.

To send a dictation via email:

- 1 Make sure that you are connected to a Wi-Fi network.
- 2 Tap  on the recording screen.
↳ The **Send options** pop-up window appears.
- 3 Tap **Send mail**.
↳ The **Compose** email window opens.
- 4 Enter the recipient's email address, and then tap  to send the dictation.
↳ The dictation is marked as sent  in the recordings list.

If you haven't set up an email account yet:

- 1 Make sure that you are connected to a Wi-Fi network.
- 2 Tap  on the recording screen.
↳ The **Send options** pop-up window appears.
- 3 Tap **Send mail**.
↳ The **Account setup** window opens. Follow the instructions on the screen. For more information about how to set up an email account, see [Using email app](#).
- 4 Tap the Back key twice.
↳ The **Compose** email window opens.
- 5 Enter the recipient's email address, and then tap  to send the dictation.
↳ The dictation is marked as sent  in the recordings list.

Send a dictation to Philips SpeechLive

Philips SpeechLive is a cloud dictation solution that allows you to store, access and share dictation files from anywhere in the world and around the clock while guaranteeing maximum file security.

For more information about how to use SpeechLive and SpeechLive services, see the SpeechLive Quick start guide for authors or the Quick start guide for administrators. Download the quick starts guides at www.speechlive.com/us/support.

Before you send a dictation to SpeechLive:

- You need to have a valid SpeechLive account. If you are not using SpeechLive yet, create a new user account at www.speechlive.com.
- Set up your SpeechLive user account in the dictation app.
- Make sure that you have enabled SpeechLive in **Settings > Forwarding > SpeechLive**.



Set up SpeechLive

Before you set up SpeechLive in the Philips dictation recorder app, you need to have a valid SpeechLive user account. If you are not using SpeechLive yet, create a new SpeechLive user account at www.speechlive.com.

To set up your SpeechLive account:

- 1 Make sure that you are connected to a Wi-Fi network.
- 2 Go to **Settings > Forwarding > SpeechLive**.
- 3 Tap the **Email address** field.
↳ The **SpeechLive login** window opens.
- 4 Enter your SpeechLive email address and your password.
- 5 Tap **Sign in**.
↳ Your SpeechLive account name is automatically assigned to your email address.
↳ If you have more than one SpeechLive user account with the same email address and password, you will be prompted to select an account. Tap the desired account.
↳ After you have set up your SpeechLive account, you will see a **Syncing successful** notification in your recordings list.

Send a dictation to SpeechLive

- 1 Make sure that you are connected to a Wi-Fi network.
- 2 Tap  on the recording screen.
↳ The **Send options** pop-up window appears.
- 3 Tap **SpeechLive**.
↳ The dictation is marked as sent  in the recordings list.
↳ You can now access your dictations in the SpeechLive portal at login.speechlive.com.

Send a dictation to Philips SpeechLive transcription service

The Philips SpeechLive transcription service offers you a complete speech-to-text workflow solution. If you have assigned your dictation a priority status, you will receive important dictations even faster.

The SpeechLive transcription service also supports dictations with multiple speakers, such as interviews, telephone conversations, or meetings. As soon as a dictation is transcribed, the finished document is attached to your dictation in the SpeechLive portal. Depending on your SpeechLive notification settings, the document can additionally be sent to you via email.

For more information about the Philips SpeechLive transcription service, visit www.speechlive.com.

For information about how to manage dictations and notifications in your SpeechLive account, see the SpeechLive Quick start guide for authors and the Quick start guide for administrators. Download the quick start guides at www.speechlive.com/support.





Note

- You can only send dictations to the transcription service after you have purchased transcription minutes for the SpeechLive transcription service through your account administrator.

Before you send a dictation to the SpeechLive transcription service:

- You need to have a valid SpeechLive user account. If you are not using SpeechLive yet, create a new user account at www.speechlive.com.
- Set up your SpeechLive account in the dictation app.
- Make sure that you have enabled the transcription service in **Settings > Forwarding > SpeechLive > Use transcription service**.

Send a single-speaker dictation to transcription service



- 1 Make sure that you are connected to a Wi-Fi network.
- 2 Enable **Single-speaker** in **Settings > Forwarding > SpeechLive > Use transcription service**.
- 3 Open a recording from the **Recordings** tab.
- 4 Tap  on the recording screen.
↳ The **Send options** pop-up window appears.
- 5 Tap **Transcription service**.
↳ The sent dictation is marked in the recordings list .

Send a multi-speaker dictation to transcription service



Note

- The multi-speaker option is only available in the Philips dictation recorder app if this feature is enabled in your SpeechLive account. For further information, contact your account administrator.

- 1 Make sure that you are connected to a Wi-Fi network.
- 2 Enable **Multi-speaker** in **Settings > Forwarding > SpeechLive > Use transcription service**.
- 3 Open a recording from the **Recordings** tab.
- 4 Tap  on the recording screen.
↳ The **Send options** pop-up window appears.
- 5 Tap **Transcription service**.
↳ The dictation is marked as sent  in the recordings list.

Send a dictation to Philips SpeechLive speech recognition service

The Philips SpeechLive speech recognition service is a fast and efficient speech-to-text solution. Choose between multiple languages that you want your dictation to be transcribed in.



Note

- The SpeechLive speech recognition service languages are intended for native speakers. If you are a non-native speaker, the accuracy of the transcription might be affected.

As soon as a dictation is transcribed, the finished document is attached to your dictation in the SpeechLive portal. Depending on your SpeechLive notification settings, the document can additionally be sent to you via email.

For information about how to manage dictations and notifications in your SpeechLive account, see the SpeechLive Quick start guide for authors or the Quick start guide for administrators. Download the quick start guides at www.speechlive.com/support.





Note

- You can only send dictations to the speech recognition service after you have purchased transcription minutes for the SpeechLive speech recognition service through your account administrator.

Before you send a dictation to the SpeechLive speech recognition service:

- You need to have a valid SpeechLive user account. If you are not using SpeechLive yet, create a new user account at www.speechlive.com.
- Set up your SpeechLive account in the dictation app.

Send a dictation to speech recognition service

- 1 Make sure that you are connected to a Wi-Fi network.
- 2 Enable speech recognition in **Settings > Forwarding > SpeechLive > Use speech recognition service**.
- 3 Open a recording from the **Recordings** tab.
- 4 Tap  on the recording screen.
↳ The **Send options** pop-up window appears.
- 5 Tap **Speech recognition**.
↳ The **Select the language of your dictation** pop-up window appears.
- 6 Select the language of your dictation by scrolling to the desired language.
- 7 Optionally, mark the **Remember setting** checkbox if you don't want the pop-up window to appear again. The dictation app saves this setting.
- 8 Tap **Send**.
↳ The dictation is marked as sent  in the recordings list.

Set a default speech recognition language

Set a default language for the speech recognition service if you mainly record dictations in the same languages.

To set a default language:

- 1 Enable speech recognition in **Settings > Forwarding > SpeechLive > Use speech recognition service**.
- 2 Select your favorite language by scrolling to the desired language.
- 3 Mark the **Remember language** checkbox.
↳ The app will remember this setting for further dictations and you will not be prompted to select a language anymore.

Send a dictation to Philips SpeechExec mobile server

Philips SpeechExec mobile server is an on-premise workflow solution that offers you maximum file security due to real-time encryption.

Before you send a dictation to Philips SpeechExec mobile server:



- Your system administrator needs to set up and activate the server. Contact your system administrator for access data.
- Set up your mobile server account in the dictation app.

Set up mobile server



Before you set up Philips SpeechExec mobile server:

- Send your device ID to your system administrator via email as described below. Make sure that you have set up an email account first.
- Your system administrator needs to set up and activate the server. Contact your system administrator for access data.

To set up mobile server:

- 1 Make sure that you are connected to a Wi-Fi network.
- 2 Go to **Settings > Forwarding > Mobile server**.
- 3 Tap the options icon  and then tap **Send device ID**.
↳ The **Compose** email window opens.
- 4 Enter your system administrator's email address.
- 5 Tap  to send the email.
↳ Your device ID is sent to your system administrator.
- 6 Enter the username, password and URL (Internet address) provided by your system administrator.
- 7 Optionally, change the server name.

Send a dictation to mobile server

- 1 Make sure that you are connected to a Wi-Fi network.
- 2 Tap  on the recording screen.
↳ The **Send options** pop-up window appears.
- 3 Tap **Mobile server**.
↳ The dictation is marked as sent  in the recordings list.

Send a dictation to Philips dictation hub

Philips dictation hub is a mobile server hosted by Philips. With the dictation hub, you can send your dictation files to a predefined email address or to Philips SpeechExec workflow software. If you have special requirements, for example, keyword-based data transfer or sending dictations to an FTP location, contact your supporting Philips partner you purchased the device from.

Note

- To have your dictation files transcribed, your transcriptionist needs to have SpeechExec software installed.

Before you send a dictation to Philips dictation hub:

- You need to have a valid dictation hub account.
- Set up your dictation hub account in the dictation app.

Set up dictation hub



Note

- If you are not using the dictation hub yet and are creating a new dictation hub user account, you will first sign up for a 30-day trial. To purchase an account after the trial period, contact your supporting Philips partner you purchased the device from.

To create a new dictation hub user account or log in to an existing account:

- 1 Go to **Settings > Forwarding > Dictation hub**.
↳ If you are setting up your dictation hub account for the first time, a welcome screen opens.
- 2 On the welcome screen, tap **Yes**.
- 3 On the End user license agreement screen, tap **Accept**.
- 4 Enter the recipient's email address.
- 5 Enter your own email address and your initials.
- 6 Tap **Next**.
- 7 Select an audio format, and then tap **Next**.
- 8 Select a language for your dictation hub workflow emails, and then tap **Connect**.

Send a dictation to dictation hub

- 1 Make sure that you are connected to a Wi-Fi network.
- 2 Tap  on the recording screen.
↳ The **Send options** pop-up window appears.
- 3 Tap **Dictation hub**.
↳ The dictation is marked as sent  in the recordings list.

Send a dictation via Philips SpeechExec software

With Philips SpeechExec workflow software, you can download all new dictations from your connected SpeechAir to the local **Finished** folder in SpeechExec.

For more information about how to download dictations from SpeechAir to SpeechExec, see [Download dictations to SpeechExec](#).

For information about how to install SpeechExec, see [Install SpeechExec on your computer](#).

Additionally, configure delivery options for SpeechAir with the SpeechAir wizard in SpeechExec. SpeechExec uploads the preconfigured delivery options to the dictation recorder app on SpeechAir. Choose between the delivery options SpeechLive speech recognition, SpeechLive transcription service, email, or Dragon speech recognition. If you select a delivery method in the dictation recorder app and connect your device to SpeechExec, the software will automatically send your new dictations via the delivery method preselected in the dictation recorder app.

Configure delivery methods for SpeechAir

- 1 Start SpeechExec.
- 2 Make sure that SpeechAir is turned on and connect the device to your computer.
- 3 Select your desired delivery methods in the SpeechAir wizard in SpeechExec. For more information, see [Configure SpeechAir in SpeechExec](#).
↳ After you have finished the SpeechAir wizard configuration, SpeechExec uploads the selected delivery methods, author name and worktypes to the dictation recorder app on SpeechAir.
- 4 Disconnect SpeechAir from SpeechExec.

Set a default delivery method

- 1 Configure delivery options for SpeechAir as described in [Configure delivery methods for SpeechAir](#).
- 2 Select the desired delivery method in the dictation recorder app in **Settings > Forwarding > Workflow > Delivery** before you send your dictation.
↳ The **Delivery** pop-up window appears.
- 3 Tap **Set as Default**.
↳ SpeechAir will save this setting and remember the selected default delivery method each time you download dictations from SpeechAir to SpeechExec.

Change the delivery method for individual dictations



Note

- If you change the delivery method for your current dictation, you don't change the default delivery option. SpeechAir won't remember this setting for your next dictation. If you want to change the default delivery method, proceed as described in [Set a default delivery method in the dictation app](#).

- 1 Configure delivery methods in SpeechExec as described in [Configure delivery methods for SpeechAir](#).
- 2 Tap the Properties icon  on the recording screen of the dictation recorder app.
- 3 Tap the text field next to **Delivery**.
- 4 Select a delivery option from the drop-down menu.

Send a dictation via SpeechExec

- 1 Configure delivery options for SpeechAir as described in [Configure delivery methods for SpeechAir](#).
- 2 Optionally, tap the Properties icon  on the recording screen of the dictation recorder app if you want to change the delivery method.
 - Tap the text field next to **Delivery**.
 - Select a delivery option from the drop-down menu.
- 3 Connect your SpeechAir to your computer.
- 4 Start SpeechExec on your computer.
 - ↳ SpeechExec downloads all new dictations from SpeechAir and sends them via the delivery method selected in the dictation recorder app.
 - ↳ By default, your dictations are deleted from your recorder after the download is finished.

Send a dictation to a network folder

Share your dictations in folders and subfolders over the network. Everyone who uses the same network can access your dictations in the selected folders.



Note

- To be able to use this feature, make your destination folder accessible over the network.
- Make sure that your device is connected to the right network.
For more information, contact your system administrator.



Before you send a dictation to a network folder:

- Contact your system administrator for access data.
- Set up your network folder settings in the dictation app.

Set up your network folder settings

- 1 Tap **Settings**.
- 2 Tap **Forwarding**.
- 3 Tap **Network folder**.
- 4 Enter the username and password provided by your system administrator.
- 5 Enter the folder path provided by your system administrator. This is an IP address starting with smb://, such as smb://111.111.111.11/Data/XY.
- 6 Optionally, select a subfolder type. Your destination folder will be named according to the selected subfolder type **Author** or **Serial number**.
- 7 Tap the Back key.
 - ↳ The **Save network folder** pop-up window appears.
- 8 Tap **Save**.

Send a dictation to a network folder

- 1 Make sure that you are connected to a Wi-Fi network.
- 2 Tap  on the recording screen.
 - ↳ The **Send options** pop-up window appears.
- 3 Tap **Network folder**.
 - ↳ The dictation is marked as sent  in the recordings list.

Using data lists

Import a .csv file with data, such as patient data, from a web server into your SpeechAir and use it in the dictation recorder app. You also have the option to select a data list refresh interval. After your data list has been imported, it will be updated at the defined interval.

Note

- The data list must contain at least three rows and one property, such as author, patient name, or department. A property may contain a maximum of 30 characters. You can add a maximum of 2000 rows and up to 10 properties to each data list.
- Don't use blank spaces, neither in the data list name nor in the data list items.
- Pay attention to upper and lower case spelling.
- If your data list can't be downloaded, check the Internet address and your Wi-Fi connection.

Import a .csv data list

- 1 Make sure that you are connected to a Wi-Fi network.
- 2 Tap **Settings** in the dictation app.
- 3 Tap **Connectivity**.
- 4 Tap **URL** and enter the Internet address where your .csv file is stored.
 - ↳ The data list is downloaded from the web server and can be used now.

Set a data list refresh interval

- 1 Tap **Settings** in the dictation app.
- 2 Tap **Connectivity**.
- 3 Tap **Refresh interval** and select the desired interval for your data list to be updated.

Use a data list in the dictation app

- 1 Open a dictation from the recordings list or start a new dictation.
- 2 Tap the Properties icon  on the recording screen.
- 3 The **Options** pop-up window appears.

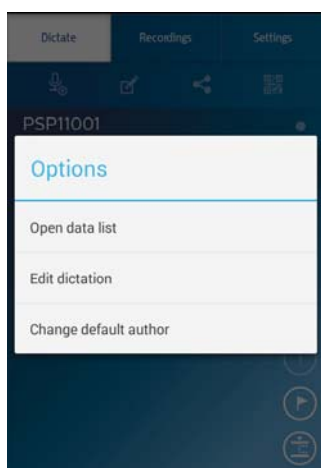

- 4 Tap **Open data list**.
- 5 Select an item from your data list.
 - ↳ The **Details** pop-up window with all details related to that item appears.
- 6 Tap **OK**.
 - ↳ The recording screen opens. The details related to the selected data item are added to your dictation.
 - ↳ The item is marked as used  in your data list.

Data list options

When you open the data list as described in [Use a data list in the dictation app](#), you can choose between various options for your data list. Scan a barcode, change the default author, select how you want your data to be filtered, or search for data list items.

To open the data list options:

- Tap the options icon  on the **Data list** window.

Scan a barcode

Use the barcode feature to find a data list item that matches the scanned barcode.

- 1 Tap the options icon  on the **Data list** window to open the data list options.
- 2 Swipe down and tap **Barcode**.

Alternatively, press the function button on the right side of the device.

- 3 Scan the barcode or the QR code.
 - ↳ The scanned barcode is compared to your data list.
 - ↳ If no item was found that matches the barcode, you will hear a notification beep.
 - ↳ If a match is found, the **Details** pop-up window with all details related to that item appears. The barcode matching an entry in the data list item is highlighted in blue color.
 - ↳ If more than one item was found that matches the barcode, black arrows appear next to the **OK** button.

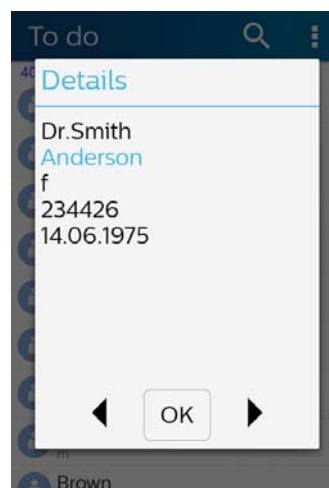

- 4 Tap **OK** on the **Details** pop-up window, or tap the arrow next to the **OK** button to scroll to the desired data list item.
 - ↳ The recording screen opens.

Change default author

If you want to change the default author, first set up different authors in **Settings > Forwarding > Workflow > Author**. For more information, see [Set up keywords](#).



To change the author:

- 1 Tap the options icon  on the **Data list** window to open the data list options.
- 2 Swipe down and tap **Change author**.
 - ↳ The **Author** window opens.
- 3 Select another author from the list.
 - ↳ The **Author** pop-up window appears.
- 4 Tap **Set as Default**.
 - ↳ The selected author is now set as the default author for all further dictations until you change the default author again.

Filter data items

To filter data list items, either use the search function or the data list options.

To filter data list items:

- 1 Tap  and enter text into the search bar to search for an item.
- 2 Tap the options icon  to select additional filters, such as done items or alphabetical sorting.

If no items are found, the reason might be too strong filtering. In this case, tap the options icon  on the **Data list** window to open the data list options. Then swipe down and tap **All items unfiltered**.

Dictation app settings

Change various settings in your dictation app according to your own preferences. Adjust settings related to audio control, forwarding, security, and user interface for the most efficient and comfortable recording with your SpeechAir and the Philips dictation recorder app.

You can see all settings in the **Settings** tab of the dictation recorder app. Find these options described in the following table.

 **Note**

- Depending on the configuration of your device, some of the settings might be locked.

Audio settings

Setting	Function
Purge dictations	<ul style="list-style-type: none"> • Tap Purge dictation intervals to set an interval for your dictations to be automatically deleted from your device. For more information, see Delete a dictation.
Audio format	<ul style="list-style-type: none"> • Select the recording quality for your dictations by choosing between the audio formats WAV (PCM) and DS2. DS2 is preset as the standard audio format.
Microphone sensitivity	<ul style="list-style-type: none"> • Adjust the microphone sensitivity to avoid recording background noises and to adapt to the recording environment. For more information, see Microphone sensitivity.
Microphone directivity	<ul style="list-style-type: none"> • Adjust the settings for directivity in hand and directivity on desk. Choose if you want to use the directional or the 360° microphone when you are dictating with your device in the hand or on the desk. For more information, see Microphone directivity.

Setting	Function
Voice activation	<ul style="list-style-type: none"> Enable voice activation to automatically start recording when you begin speaking, and pause recording when you stop speaking. For more information, see Voice-activated recording.
Record notification beep	<ul style="list-style-type: none"> Enable the record notification beep to hear a beep sound when you start recording.
Auto backspace	<ul style="list-style-type: none"> Tap Jump back to select the number of seconds you want to jump back in your recordings when you rewind them.

Forwarding

Setting	Function
Email	<ul style="list-style-type: none"> Enable this feature to be able to send dictations via email.
SpeechLive	<ul style="list-style-type: none"> Enable this feature to be able to send dictations to SpeechLive. For more information, see Send a dictation to SpeechLive. Set up your SpeechLive account. For more information, see Set up SpeechLive. Enable the SpeechLive transcription service and speech recognition service to be able to send dictations to the transcription service and speech recognition service. For more information, see Send a dictation to Philips SpeechLive transcription service and Send a dictation to Philips SpeechLive speech recognition service.
Mobile server	<ul style="list-style-type: none"> Set up your mobile server account to be able to send dictations via the Philips Speechexec mobile server. For more information, see Send a dictation to Philips SpeechExec mobile server and Set up mobile server.

Setting	Function
Dictation hub	<ul style="list-style-type: none"> Enter a predefined recipient's address and set up your dictation hub account to be able to send dictations to Philips dictation hub. For more information, see Send a dictation to Philips dictation hub and Set up dictation hub.

Network folder	<ul style="list-style-type: none"> The network folder option is a comfortable way to share dictations via defined folders and its subfolders over the network. Everyone who uses the same network can access your dictation files in the selected folders. For more information, see Send a dictation to a network folder.
-----------------------	---

Workflow	<ul style="list-style-type: none"> Define one or more keywords that you can assign to each recording. Use keywords for automatic file routing and to identify recordings more easily. For more information, see Add keywords to a dictation.
-----------------	---

Send EOL dictations automatically	<ul style="list-style-type: none"> Enable this function to automatically be prompted to select a sending option when you mark a dictation as locked.
--	---

Security

Setting	Function
Encryption	<ul style="list-style-type: none"> Tap Encryption to define a 16-character encryption key. If you have selected DS2 as the standard audio format, the encryption key provides real-time encryption of your dictations while you are recording. The encryption key also provides additional encryption of dictations that are sent to Philips dictation hub or Philips SpeechExec mobile server.

Setting	Function
Use encryption	<ul style="list-style-type: none"> Enable encryption to use the defined encryption key and to protect your dictations from unauthorized use or file playback.

User interface

Setting	Function
Display	<ul style="list-style-type: none"> Enable the setting Keep display on during recording if you don't want the display to turn off while you are recording. The predefined length of time before your screen turns off when the device is not used (see Power saving mode) is disabled then.

Slide switch	<ul style="list-style-type: none"> Customize the functionality of the slide switch. By default, the slide switch is set to International. To change the slide switch assignment, go to Settings > User interface > Slider assignment and select Philips, International, or German. <p>Philips</p> <p>▶▶ ▶ Ⓞ/■ (function button) ◀◀</p> <p>International</p> <p>● ■ ▶ ◀◀</p> <p>German</p> <p>▶▶ Ⓞ/■ (function button) ▶ ◀◀</p>
---------------------	---

Function button	<ul style="list-style-type: none"> Customize the functionality of the right function button on your device. Tap Button assignment and select the desired function you want to assign to the function button.
------------------------	--

Connectivity

Setting	Function
Data list	<ul style="list-style-type: none"> Import .csv files with data, such as patient data, from an Internet address into your SpeechAir by entering your data list URL (Internet address). Select your desired data list refresh interval. After your data list has been imported, it will be updated at the defined interval. For more information, see Using data lists.

Help

Setting	Function
Technical support	<ul style="list-style-type: none"> Send an email to our technical support if you have technical issues with your dictation recorder app or if you want to send us feedback on the app.
Quick start guide	<ul style="list-style-type: none"> Open the quick start guide to get a quick overview of the main dictation app functions.

About

<ul style="list-style-type: none"> See information about your dictation app version. Follow the links to our Terms and conditions and to our Privacy policy.
--

6 Device and data management

Transfer data to and from the computer

Move your files from the device to the computer, or vice versa.

Caution

- Don't disconnect the USB cable from the device while you are transferring files. This might cause data loss.
- Don't delete any preinstalled folders from SpeechAir. Deleting them might cause malfunctioning of the device software.

Note

- For reasons of data security, the operation of the device is disabled while the device is connected to the computer.

To transfer data from SpeechAir to the computer:

- 1 Connect the device to the computer via micro USB cable.
Alternatively, connect the device to the computer by using the docking station. Make sure that you use the data transfer micro USB port marked with  on the docking station.
↳ The green transfer LED on the docking station illuminates.
- 2 Open Windows Explorer on a Windows computer, or open Finder on a Mac computer.
↳ SpeechAir is recognized as an external drive.
- 3 Double-click the SpeechAir drive.
↳ The content of your SpeechAir is displayed in a new window.
- 4 Select the desired files in the SpeechAir window and copy, cut or drag them to the desired location on your computer.

To transfer data from the computer to SpeechAir:

- 1 Connect the device to the computer via micro USB cable.
Alternatively, connect the device to the computer by using the docking station. Make sure that you use the data transfer micro USB port marked with  on the docking station.
↳ The green transfer LED on the docking station illuminates.
- 2 Open Windows Explorer on a Windows computer, or open Finder on a Mac computer.
↳ SpeechAir is recognized as an external drive.
- 3 Double-click the SpeechAir drive.
↳ The content of your SpeechAir is displayed in a new window.
- 4 Select the desired files on your computer and copy, cut or drag them to the desired location on your SpeechAir.

Reset your device and data

Device reset

If you should encounter problems with your device software, for example, the software freezes, the device works slowly or apps don't respond, you can reset your device and restart it.

When you reset your SpeechAir, you won't lose any saved data. However, if you reset the device while using a software program or app, the device shuts down all active programs and unsaved data might get lost.

To reset your device:

- 1 Press and hold the reset button on the right side of your device by using a small, pointed object, for example, a paper clip.

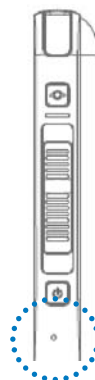

- 2 Restart your device by pressing and holding the Power button until the device gently vibrates.

Factory data reset

You can reset your device to its original system state and delete all data. After a factory data reset, the device is restored to its default settings—the way it was when you first purchased it and turned it on. Any apps you installed, data you added and settings you customized on your device will be lost. Also the firmware will be set to its factory state and needs to be updated again.



Caution

- Performing a factory data reset will delete all data on your device. Before you perform a factory data reset, back up any important data saved on your device.

To perform a factory data reset:

- 1 Tap **Settings**  on the Home screen or on the All Apps screen.
- 2 Swipe down and tap **Backup & reset**.
- 3 Tap **Factory data reset**.
↳ The Factory data reset window opens.
- 4 Tap **Reset SpeechAir**.
↳ The **Reset** window opens.
- 5 Tap **Erase everything**.
↳ SpeechAir turns off and restarts automatically.

Updating your device

Your device is controlled by an internal program called firmware. As a part of ongoing product maintenance, the firmware is upgraded and errors are corrected.

It is possible that a newer version (an 'update') of the firmware has been released since you purchased the device. In this case, you can easily update your device to the latest version.

Update your device manually by copying the update file from our website to your device. Alternatively, update the firmware with the supplied Philips SpeechAir management software. You can find the software on the supplied USB flash drive or implemented in Philips SpeechExec software. For more information, see [Philips SpeechAir management software](#).



Caution

- Before you update the firmware, make sure that your device has at least 30% battery power left. This helps to prevent the power supply being interrupted during the update.
- Before you use other device functions, wait until the firmware update is complete. Failures in the firmware update might result in the device's malfunctioning.



Note

- To find out about new firmware versions, regularly check our website at www.philips.com/dictation.
- Before you can use Philips SpeechAir management software, first install the software. For more information, see [Install SpeechAir management software](#).

Update the firmware manually

- 1 Download the firmware update file **update.img** from the website www.philips.com/dictation to your computer.
- 2 Make sure that SpeechAir is turned on and connect the device to your computer.
- 3 Copy the firmware update file to the SpeechAir folder on your computer. You can find the SpeechAir folder in Windows Explorer on Windows computers, and in Finder on Mac computers.
- 4 Disconnect the device from the computer.
↳ The **Update** pop-up window appears on your SpeechAir.
- 5 Tap **Update now**. If you want to update the firmware at a later time, tap **Postpone for 2 hours**. You can postpone the update three times. Afterwards, the device will inform you that the firmware will automatically be updated.
↳ SpeechAir turns off and starts the installation of the update file.
↳ You can see the progress of the installation on the screen.

- ↳ When the firmware update has finished, SpeechAir restarts automatically.

Update the firmware with SpeechAir management software

Note

- On Mac computers, it is only possible to update the firmware manually with the **update.img** file as described in [Update the firmware manually](#).

- 1 Download the firmware update file **update.safw** from the website www.philips.com/dictation to your computer.
- 2 Start Philips SpeechAir management software.
- 3 Make sure that SpeechAir is turned on and connect the device to your computer.
- 4 On the device configuration window of the software, go to **SpeechAir > Firmware**, and select the firmware file on your computer.

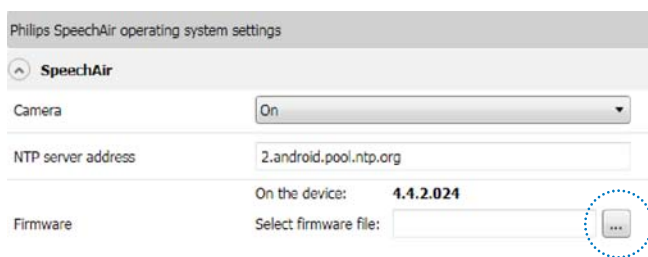

- 5 Click **Send to SpeechAir** on the tool bar.
 - ↳ A pop-up window confirming the successful configuration transfer appears.
- 6 To apply the configuration to SpeechAir, disconnect the device from the computer.
 - ↳ The **Update** pop-up window appears on your SpeechAir.
- 7 Tap **Update now**. If you want to update the firmware at a later time, tap **Postpone for 2 hours**. You can postpone the update three times. Afterwards, the device will inform you that the firmware will automatically be updated.
 - ↳ SpeechAir turns off and starts the installation of the update file.
 - ↳ You can see the progress of the installation on the screen.
 - ↳ When the firmware update has finished, SpeechAir restarts automatically.

7 Philips SpeechAir management software

Philips SpeechAir management software allows advanced configurations of your SpeechAir that can't be performed directly on the device. You can update your device's firmware, define an NTP server address, or disable the camera function. All other settings related to your SpeechAir can be changed directly on the device.

Additionally, the software enables you to configure, change and control all settings for the Philips dictation recorder app. Some of these settings are also accessible directly in the app. Advanced options which are only available in the management software include configuring data list settings or defining text fields to be displayed on the recording screen, for example the author or worktype.

For more information about settings in the dictation recorder app, see [Dictation app settings](#).

Install SpeechAir management software



If you have purchased SpeechAir without SpeechExec software, you will find SpeechAir management software on the supplied USB flash drive.

If you have purchased SpeechAir with SpeechExec software, you will find SpeechAir management software implemented in SpeechExec. For more information about how to install SpeechExec, see [Install SpeechAir management software](#).

Install SpeechAir management software on your computer

- 1 Connect the supplied USB flash drive to your computer.
- 2 Open Windows Explorer on your computer.
- 3 Double-click the USB flash drive in Windows Explorer.
↳ The content of the USB flash drive is displayed in a new window.
- 4 Double-click the file **PhilipsSpeechAirManagementSoftwareSetup.exe**.
↳ The **InstallShield Wizard** window opens.
- 5 Follow the on-screen instructions.
- 6 Click **Finish** when the installation process has finished.
↳ The management software is now installed on your computer.

Start SpeechAir management software from SpeechExec

- 1 Install SpeechExec software as described in [Install SpeechExec on your computer](#).
- 2 Make sure that SpeechAir is turned on and connect the device to your computer.
- 3 Click  or  on the tool bar in SpeechExec.
↳ The **General Settings** window opens.
- 4 In the **General Settings** window, click **SpeechAir configuration > Device configuration > Start SpeechAir management software**.

Configure SpeechAir with SpeechAir management software

The management software allows you to configure various settings for your SpeechAir and Philips dictation recorder app. The configuration can be immediately transferred to your connected SpeechAir.

Note

- Before you start Philips SpeechAir management software, connect SpeechAir to your computer. The management software can only be used with a connected device.
- Depending on your device's preset configurations, some settings might be locked. In this case, you can't configure any settings with SpeechAir management software.

Device configuration screen

When you start the management software, you will see a welcome screen. Once you connect SpeechAir to your computer, you will see the device configuration screen.

The tool bar contains the following options:

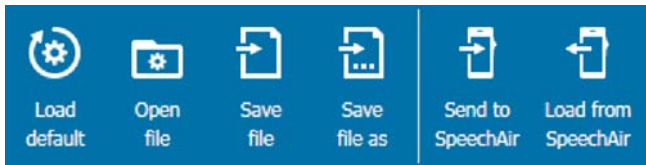

- Click **Load default** to discard all your changes and revert back to the factory settings.
- Click **Open file** to open a configuration previously saved on your computer.
- Click **Save file** to save the current configuration to your computer.
- Click **Save file as** to save the current configuration to your computer with a different name.
- Click **Send to SpeechAir** to transfer the current configuration to your SpeechAir.
- Click **Load from SpeechAir** to download the current SpeechAir configuration to the management software.

Below the tool bar, you will see two sections: a configuration section for SpeechAir and a configuration section for the Philips dictation recorder app. You can set your desired configurations for SpeechAir or the Philips dictation recorder app in the relevant section.

Philips SpeechAir operating system settings

Philips dictation recorder app settings

Configure SpeechAir and Philips dictation recorder app settings

- 1 Start the management software and connect your SpeechAir to the computer.
 - ↳ The device configuration screen opens.
- 2 To configure settings for SpeechAir, click the arrow in the **SpeechAir** section. To configure settings for the dictation recorder app, click the arrow in the **Philips dictation recorder app** section.

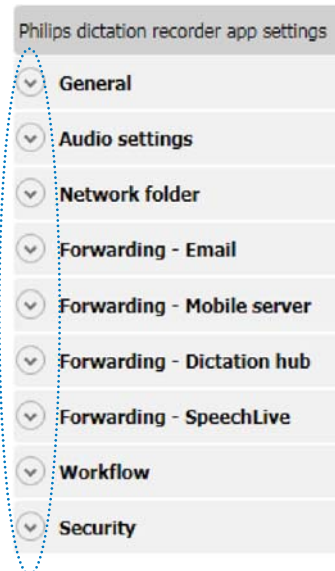
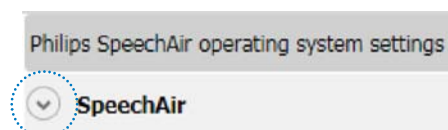

- 3 Configure your desired settings.
 - ↳ Whenever you change a setting, the relevant setting is highlighted in green and a pencil icon appears next to it.



- 4 After you have finished your configuration, click **Save file**, **Save file as** or **Send to SpeechAir** on the tool bar.

8 Using SpeechAir with Philips SpeechExec software

If you use Philips SpeechExec workflow software, you can connect your SpeechAir to your computer and download your dictations from your device to SpeechExec software. Your secretary can access your dictations in SpeechExec transcription software. This way you can forward your dictations to transcription without having to use an Internet connection.

Additionally, you can configure delivery options for SpeechAir with the SpeechAir wizard in SpeechExec. SpeechExec uploads the preconfigured delivery options to the dictation recorder app on SpeechAir. The author name and worktypes defined in SpeechExec are also uploaded to the dictation recorder app.

Choose between the delivery options SpeechLive speech recognition, SpeechLive transcription service, email, or Dragon speech recognition. If you select a delivery method in the dictation recorder app and connect your device to SpeechExec, the software will automatically send your new dictations via the delivery method preselected in the dictation recorder app.

For more information about SpeechExec, refer to the SpeechExec user manual or the online help in SpeechExec. Download the SpeechExec user manual at www.dictation.philips.com/support.

Install SpeechExec on your computer

Before you connect your SpeechAir to SpeechExec software, you first need to install the software on your computer.

If you have purchased SpeechAir including SpeechExec software (SpeechAir PSP1200), you will find the software on the supplied USB flash drive. The necessary license key is printed on a sticker on the USB flash drive.

To install SpeechExec on your computer:



- 1 Connect the supplied USB flash drive to your computer.
- 2 Open Windows Explorer on your computer.
- 3 Double-click the USB flash drive in Windows Explorer.
↳ The content of the USB flash drive is displayed in a new window.
- 4 Double-click the **Autorun.exe** file.
- 5 Follow the on-screen instructions.
- 6 Click **Finish** when the installation process has finished.
↳ SpeechExec is now installed on your computer.

Configure SpeechAir in SpeechExec

Generally, you don't need to perform any configurations for using SpeechAir with SpeechExec. After installation, the software is immediately ready for use with SpeechAir. However, you can change basic settings of your SpeechAir device in SpeechExec using the SpeechAir wizard.

With the SpeechAir wizard, you can also configure the delivery methods you want to use in the dictation recorder app.

Configure SpeechAir with the SpeechAir wizard

- 1 Start SpeechExec.
- 2 Make sure that SpeechAir is turned on and connect the device to your computer.
- 3 Click  or  on the tool bar in SpeechExec.
↳ The **General Settings** window opens.
- 4 In the **General Settings** window, click **SpeechAir configuration > Device configuration**, and then click **Open SpeechAir wizard**.
↳ The SpeechAir wizard opens.
- 5 Follow the on-screen instructions.
- 6 Click **Finish** in the **Summary** section.
↳ Your settings have been applied and the configuration is finished.
- 7 Disconnect SpeechAir from your computer.



Configure delivery methods for SpeechAir

If you connect SpeechAir to SpeechExec, the preconfigured delivery methods will be uploaded from the software to SpeechAir. Each time you connect SpeechAir to SpeechExec, the software will automatically download all new dictations from your device and send them via the preconfigured delivery methods SpeechLive speech recognition, SpeechLive transcription service, email, or Dragon speech recognition.

Note

- If you want to use SpeechLive speech recognition or SpeechLive transcription service as delivery methods, you first need to allow SpeechExec to download your dictations to your SpeechLive folder. Click **Settings > SpeechAir Configuration > SpeechAir and SpeechLive**. In the **Location for download** window, select **In SpeechLive folders** from the drop-down menu.
- Before you can send dictations to SpeechLive services, you need to have a valid SpeechLive account. If you are not using SpeechLive yet, create a new user account at www.speechlive.com.

To configure delivery methods:

- 1 Start SpeechExec.
- 2 Make sure that SpeechAir is turned on and connect the device to your computer.
- 3 Click  or  on the tool bar in SpeechExec.
↳ The **General Settings** window opens.
- 4 In the **General Settings** window, click **SpeechAir configuration > Device configuration**, and then click **Open SpeechAir wizard**.
↳ The SpeechAir wizard opens.
- 5 Follow the on-screen instructions until you reach the **USB download** section.
- 6 Make sure that the checkbox '**Yes, I would like to use...**' is marked, and select your desired delivery methods.
- 7 Click **Finish** in the **Summary** section.
↳ Your settings have been applied and the configuration is finished.
- 8 Disconnect SpeechAir from your computer.

Set a default delivery method in the dictation app

- 1 Configure delivery options for SpeechAir as described in [Configure delivery methods for SpeechAir](#).
- 2 Select the desired delivery method in the dictation recorder app in **Settings > Forwarding > Workflow > Delivery** before you send your dictation.
↳ The **Delivery** pop-up window appears.
- 3 Tap **Set as Default**.
↳ SpeechAir will save this setting and remember the selected default delivery method each time you download dictations from SpeechAir to SpeechExec.

Change the delivery method for individual dictations



Note

- If you change the delivery method for your current dictation, you don't change the default delivery option. SpeechAir won't remember this setting for your next dictation. If you want to change the default delivery method, proceed as described in [Set a default delivery method](#).

- 1 Configure delivery methods in SpeechExec as described in [Configure delivery methods for SpeechAir](#).
- 2 Tap the Properties icon  on the recording screen of the dictation recorder app.
- 3 Tap the text field next to **Delivery**.
- 4 Select a delivery option from the drop-down menu.

Send a dictation via SpeechExec

- 1 Configure delivery methods in SpeechExec as described in [Configure delivery methods for SpeechAir](#).
- 2 Connect your SpeechAir to your computer.
- 3 Start SpeechExec on your computer.
↳ SpeechExec downloads all new dictations from SpeechAir and sends them via the delivery method selected in the dictation recorder app.
↳ By default, your dictations are deleted from your recorder after the download is finished.

Download dictations to SpeechExec

If you don't want to use Wi-Fi to send your dictations, connect SpeechAir to your computer and download your dictations from the recorder to SpeechExec workflow software. The downloaded dictations are saved to a local SpeechExec folder. Your secretary can access your dictations via SpeechExec Pro Transcribe software. This way you can exchange your dictations with your transcriptionist without having to use an Internet connection.



Note

- To exchange dictation files with your transcriptionist within SpeechExec software, your secretary needs to have SpeechExec Pro Transcribe software installed.

Select your desired download settings

- 1 Start SpeechExec.
- 2 Click **Settings**  on the tool bar in SpeechExec.
↳ The **General Settings** window opens.
- 3 In the **General Settings** window, click **SpeechAir configuration > Download**.
- 4 Select your desired settings.

Download dictations from SpeechAir to SpeechExec

- Make sure that SpeechAir is turned on and connect the device to your computer.
↳ By default, SpeechExec automatically downloads all new dictations from SpeechAir. To change this setting, proceed as described in [Select your desired download settings](#).
↳ A pop-up window in SpeechExec appears and confirms that your dictations have been downloaded to SpeechExec.
↳ By default, your dictations are deleted from your recorder after the download is finished.

9 Service and support

Don't perform any maintenance operations that aren't described in this user manual. Don't disassemble the device into its component parts to carry out repairs. The device may only be repaired in authorized service centers.

Display device information

See various information about your device, such as the serial number or model number.

- 1 Tap **Settings**  on the Home screen or on the All Apps screen.
- 2 Scroll down to the very bottom and tap **About SpeechAir**.

Display information about Philips dictation recorder app

See information about your dictation app version, our Terms and conditions, and our Privacy policy.

- 1 Open the app  on the Home screen or on the All Apps screen.
- 2 Tap the **Settings** tab.
- 3 Tap **About**.

Open Quick start guide

Open the quick start guide to get a quick overview of the main dictation app functions.

- 1 Open the app  on the Home screen or on the All Apps screen.
- 2 Tap the **Settings** tab.
- 3 Tap **Help**.
- 4 Tap **Quick start guide > Start now**.

Send email to technical support

Send an email to our technical support if you have technical issues with your dictation recorder app or if you want to send us feedback on the app.

- 1 Open the app  on the Home screen or on the All Apps screen.
- 2 Tap the **Settings** tab.
- 3 Tap **Help**.
- 4 Tap **Technical support > Submit issue**.

- ↳ The **Compose** email window opens.
- ↳ Our technical support's email address is automatically inserted.

- 5 Compose an email and send it to us.

Contact our supporting Philips partners

If you have any questions on your SpeechAir or experience technical issues, contact one of our supporting Philips partners. The local partner you purchased your SpeechAir from will strive to answer your questions and to solve your problem as soon as possible.

Open source software

This product may contain open source software. Speech Processing Solutions GmbH hereby offers to deliver, upon request, a copy of the complete corresponding source code for the copyrighted open source software packages used in this product for which such offer is requested by the respective licenses. This offer is valid up to three years after product purchase. To obtain the source code, please write in English to: info@speech.com.

Troubleshooting

Find the most common problems you could encounter with SpeechAir in the following table. If you are unable to solve the problem with the information below, contact the supporting Philips partner you purchased the device from.

Problem	Possible cause	Solution
The device doesn't turn on.	<ul style="list-style-type: none"> The battery has run out of power. 	<ul style="list-style-type: none"> Charge the device for a while and then turn it on again.
The device doesn't respond.	<ul style="list-style-type: none"> There is a problem with the operating system. 	<ul style="list-style-type: none"> Try to turn the device off and then restart it. If you can't turn the device off or if turning the device off doesn't solve the problem, perform a device reset. For more information, see Device reset.
The device doesn't play back recordings.	<ul style="list-style-type: none"> The volume is off or too low. The playback marker on the recording screen is placed at the end of the recording (dictation recorder app). You are outside the recording screen (dictation recorder app). 	<ul style="list-style-type: none"> Turn on or turn up the volume. Rewind the recording and play back the dictation again, or drag the playback marker on the recording screen to the left (dictation recorder app). For more information, see Rewind a recording. Go back to the recording screen and restart the playback (dictation recorder app).
I can't hear anything from the speakers.	<ul style="list-style-type: none"> The headphones are connected to the device. The volume is off or too low. 	<ul style="list-style-type: none"> Unplug the headphones. Turn on or turn up the volume.
The recording doesn't start.	<ul style="list-style-type: none"> The battery has only 8% or less power left (dictation recorder app). You are outside the recording screen (dictation recorder app). 	<ul style="list-style-type: none"> Charge the device before you start recording or connect the device to the power supply while recording. Go back to the recording screen and start the recording (dictation recorder app).
I can't download a data list.	<ul style="list-style-type: none"> Wi-Fi isn't turned on or you aren't connected to a Wi-Fi network. The Internet address (URL) where your data list is stored is incorrect or invalid. 	<ul style="list-style-type: none"> Make sure that Wi-Fi is turned on and that you are connected to a Wi-Fi network. Make sure that the Internet address you entered is correct and valid (dictation recorder app). For more information, see Import a .csv data list.

Problem	Possible cause	Solution
The recording quality is poor.	<ul style="list-style-type: none"> The microphone sensitivity is too high. You recorded the dictation with the built-in 360° meeting microphone. The distance between your mouth and the built-in microphone was too short. You recorded a dictation with an external microphone and connected it to the wrong jack (i.e. headphones jack). 	<ul style="list-style-type: none"> Change the microphone sensitivity to medium or low (dictation recorder app). For more information, see Microphone sensitivity. Change the microphone directivity and use the built-in directional microphone (dictation recorder app). For more information, see Microphone directivity. Try to keep a distance of approx. 10 cm (4") between your mouth and the microphone while recording. Disconnect the external microphone and connect it to the microphone jack on SpeechAir.
There's too much background noise in my recording.	<ul style="list-style-type: none"> The microphone sensitivity is too high. You recorded the dictation with the built-in 360° meeting microphone. 	<ul style="list-style-type: none"> Change the microphone sensitivity to medium or low (dictation recorder app). For more information, see Microphone sensitivity. Change the microphone directivity and use the built-in directional microphone (dictation recorder app). For more information, see Microphone directivity.
I can't hear anything from the headphones.	<ul style="list-style-type: none"> The volume is off or too low. The headphones aren't connected properly. The headphones are connected to the wrong jack (i.e. external microphone jack). 	<ul style="list-style-type: none"> Turn on or turn up the volume. Disconnect the headphones and connect them to the headphones jack again. Disconnect the headphones and connect them to the headphones jack.
An external microphone connected to SpeechAir doesn't work.	<ul style="list-style-type: none"> The external microphone is connected to the wrong jack (headphones jack). 	<ul style="list-style-type: none"> Disconnect the external microphone and connect it to the microphone jack on SpeechAir.
I can't scan barcodes.	<ul style="list-style-type: none"> The camera lens is dirty. 	<ul style="list-style-type: none"> Clean the camera lens with a soft, dry cloth.
The picture quality is poor.	<ul style="list-style-type: none"> The camera lens is dirty. 	<ul style="list-style-type: none"> Clean the camera lens with a soft, dry cloth.
The battery charges slowly.	<ul style="list-style-type: none"> The device is connected to the computer. The device is connected to the wrong micro USB port (i.e. data transfer micro USB port) on the docking station. You are using a different micro USB cable than the cable originally supplied with the device. 	<ul style="list-style-type: none"> Disconnect the device from the computer and connect it to the power supply. Disconnect the device from the docking station and connect it to the charging micro USB port marked with 5V DC on the docking station. Use the original micro USB cable that was supplied with the device.

Problem	Possible cause	Solution
I can't connect to a Wi-Fi network.	<ul style="list-style-type: none"> • The Wi-Fi function is turned off. • The connection settings for the Wi-Fi network are incorrect. • The distance between the device and the Wi-Fi access point is too long. • An obstacle is blocking the signal between the device and the Wi-Fi access point. 	<ul style="list-style-type: none"> • Turn on Wi-Fi. For more information, see Turn on Wi-Fi. • Check the Wi-Fi settings. • Try to move the device closer to the Wi-Fi access point. • Check if there are any obstacles between the device and the Wi-Fi access point.
I can't transfer data from my SpeechAir to my computer.	<ul style="list-style-type: none"> • The micro USB cable is connected to the wrong micro USB port (i.e. charging micro USB port) on the docking station. 	<ul style="list-style-type: none"> • Disconnect the micro USB cable from the docking station and connect it to the data transfer micro USB port marked with  on the docking station.

10 Technical data

Device

- Model color: dark grey pearl metallic and chrome frame
- Slide switch type: International slide switch: Record/Stop/Play/Rewind
- OS: Android 4.4.2
- CPU: Dual Core Cortex-A9 1.6 GHz
- RAM: 1GB DDR3
- Wi-Fi: IEEE802.11b/g/n
- Bluetooth: 4.0
- Vibration module
- Anti-microbial housing parts
- Customizable function button

Docking station

- LAN connection
- Kensington Security Slot
- Removable magnetic inlay for use with case

Specifications

- Product dimensions (W×D×H):
SpeechAir: 62×127×15 mm / 2.4×5×0.6"
Docking station: 82×77×56 mm / 3.2×3×2.2"
- Weight:
SpeechAir: 116 g / 4.1 oz
Docking station: 264 g / 9.3 oz

Sensors:

- Light sensor
- Motion sensor
- Optical proximity sensor

Connectivity

- Headphones: 3.5 mm / 1.4"
- Microphone: 3.5 mm / 1.4"
- USB: micro USB 2.0
- Docking connector

Display

- Type: IPS with 16 million colors
- Touch screen
- Scratch-resistant Gorilla glass
- Diagonal screen size: 10.16 cm / 4"
- Resolution: 800×480 px

Memory

- 1 GB RAM
- Total internal memory: 16 GB (available user memory approx. 12 GB)

Audio

- Recording format supported by OS: AMR, ACC
- Playback format supported by OS: MPEG (MP1, MP2, MP3), WMA, WAV, APE, OGG (OGG, OGA), FLAC, AAC (AAC, M4A)
- Built-in microphones: one dictation microphone (directional), one 360° meeting microphone (omnidirectional), one telephony microphone (VoIP)

Philips dictation recorder app

- Recording time: 1073 hrs (DS2), 117 hrs (WAV)
- Recording modes: DSS Pro (DS2/mono), PCM Voice (WAV/mono)
- Bit rate: 28 kbit/s (DS2), 256 kbit/s (WAV)
- Sample rate: 16 kHz/16 bit (WAV), 16 kHz/16 bit (DS2)

Sound

Front speaker:

- Speaker type: built-in rectangular dynamic speaker
- Speaker dimensions: 6×12 mm / 0.2×0.5"

Rear speaker:

- Speaker type: built-in rectangular dynamic speaker
- Speaker dimensions: 11×15 mm / 0.4×0.6"

Camera

- 5 Mpx
- Image formats supported by OS: JPG, JPEG, BMP, GIF, PNG
- Autofocus
- Flash

Video

- Recording formats supported by OS: H.264/AVC (MOV, 3GP) 30 fps up to 1920×1088 px
- Playback formats supported by OS: MPEG-1/2 (DAT, MPG, VOB, TS) 30 fps up to 1920×1088 px, MPEG4 (AVI, MKV, MP4, MOV, 3GP) 30 fps up to 1920×1088 px, DIVX (AVI, MKV, MP4, MOV, 3GP) 30 fps up to 1920×1088 px, REAL MEDIA (RM, RMVB) 30 fps up to 1920×1088 px, H.264 (AVI, MKV, MP4, MOV, 3GP, TS, FLV) 30 fps up to 1920×1088 px, H.264 MVC (AVI, MOV) 60 fps up to 1920×1088 px, VP8 (WEBM) 30 fps up to 1920×1088 px, VC-1 (WMV, ASF, TS, MKV, AVI) 30 fps up to 1920×1088 px, H.263 (3GP, MOV, MP4) 30 fps up to 704×576 px, Sorenson Spark (FLV) 30 fps up to 1920×1088 px, ON2 VP6 (AVI, FLV) 30 fps up to 1920×1088 px, Motion JPEG (AVI, MOV) 30 fps up to 1920×1088 px
- Autofocus
- Flash

Barcode scanning

- 1D barcodes: Code 39, Code 93, Codabar, Code128, Code 25, Code 11, MSI/Plessey, EAN, UPC
- 2D barcodes: QR code, Data Matrix code

Power

- Battery type: built-in rechargeable Li-ion battery
- Battery capacity: 2700mAh
- Battery lifetime: up to 12 hours of recording (DSS Pro mode)
- Standby time: 97 hours
- Charging time (full charge): 3 hours

Security

- Real-time file encryption
- Encryption standard (Philips dictation recorder app): Advanced Encryption Standard (AES) 256 bits
- Configurable security settings (with Software Development Kit (SDK) or configuration software)
- Device lock with PIN code or password
- Lockable settings

Green specifications

- Compliant to 2011/65/EU (RoHS)

Operation conditions

- Temperature: 5° – 45° C/41° – 113° F
- Humidity: 10% – 90%, non-condensing

System requirements for SpeechExec workflow software

- Processor: 1 GHz Intel® dual core or equivalent AMD processor
- RAM: 1 GHz Intel® dual core or equivalent AMD processor
- Free hard disk space: 100 MB for SpeechExec installation, 1 GB (32 bit) or 2 GB (64 bit) for Microsoft .NET 4.0 Framework Client Profile
- Operating systems: Windows 10/8/7 (32/64 bit)
- Free USB port
- Screen resolution: minimum 1024×768 px, maximum 3200×1800 px with a maximum display size of 150%
- Windows Media Player must be installed on a Windows operating system

Accessories (optional)

- Philips SpeechAir shock-proof case ACC1120
- Philips telephone pickup microphone LFH9162
- Philips meeting microphone LFH9172
- Philips SDK for dictation hardware LFH7475



FCC Warning Statement



Changes or modifications not expressly approved by the party responsible for compliance could void the user's authority to operate the equipment.

This equipment has been tested and found to comply with the limits for a Class B digital device, pursuant to Part 15 of the FCC Rules. These limits are designed to provide reasonable protection against harmful interference in a residential installation. This equipment generates uses and can radiate radio frequency energy and, if not installed and used in accordance with the instructions, may cause harmful interference to radio communications. However, there is no guarantee that interference will not occur in a particular installation. If this equipment does cause harmful interference to radio or television reception, which can be determined by turning the equipment off and on, the user is encouraged to try to correct the interference by one or more of the following measures:

- Reorient or relocate the receiving antenna.
- Increase the separation between the equipment and receiver.
- Connect the equipment into an outlet on a circuit different from that to which the receiver is connected
- Consult the dealer or an experienced radio/TV technician for help.

CE Declaration of Conformity

 The conformity with the relevant EU directives is confirmed by the CE mark.

Declaration of conformity

Speech Processing Solutions GmbH hereby declares that the devices SpeechAir PSP1000 series fully comply with the basic requirements and other relevant provisions of directives 2006/95/EC, 2004/108/EC and 2009/125/EC. A complete declaration of conformity for this product is available at www.philips.com/dictation.

Neither Speech Processing Solutions GmbH nor its affiliates shall be liable to the purchaser of this product or third parties with respect to claims for damages, losses, costs or expenses incurred by purchaser or third parties as a result of an accident, misuse or abuse of this product or unauthorized modifications, repair, modification of the product or failure to meet the operating and maintenance instructions provided by the manufacturer.

MPEG Layer-3 audio coding technology licensed from Fraunhofer IIS and Thomson Licensing.

This user manual is a document with no contractual nature. We accept no liability for changes, mistakes or printing errors.





Issue date 2016-05-02
Version 1.0

© 2016 Speech Processing Solutions GmbH. All rights reserved.

Specifications are subject to change without notice. Philips and the Philips shield emblem are registered trademarks of Koninklijke Philips N.V. and are used by Speech Processing Solutions GmbH under license from Koninklijke Philips N.V. All trademarks are the property of their respective owners.

www.philips.com/dictation