

637f



Servo drive



**Product
Manual**

UL:07-02-01



Product Manual Rack 6 U and EMV

UL:07-02-02-01



Product Manual Power Supply Plug-in Module NE B

UL: 07-02-09-02



Feedback System HIPERFACE®

UL:07-02-10-02



Product - Manual Safe Standstill SBT

UL:07-05-02-03



Product Manual SUCOnet K

UL:07-05-03-02



Product Manual Bus Interface CAN for 635 / 637 / 637+ / 637f

UL:07-05-04-02



Product Manual Bus Interface DP for 635 / 637 / 637+ / 637f

UL:07-05-05-02



Product Manual Bus Interface Interbus S for 635 / 637 / 637+ / 637f

UL:07-05-07-02



Product Manual I/O Interface for 635 / 637 / 637+ / 637f

UL:07-05-08-02



Product Manual Bus Interface Device Net for 635 / 637 / 637+ / 637f

UL:07-09-04-02



Product Manual Suppression Aids EH

UL:10-06-03



Product Manual Serial Transfer Protocol
635 / 637 / 637+ / 637f EASY- Serial

UL: CD



EASYRIDER® Windows - Software

UL:10-06-05



Product Manual Software BIAS®

UL: 12-01



Product Manual Accessories - Plugs

UL:12-02



Product Manual Accessories - Cable

UL:12-03



Product Manual Ballast Resistors

©SSD Drives GmbH.

All rights reserved. No portion of this description may be produced or processed in any form without the consent of the company.

Changes are subject to change without notice.

SSD Drives has registered in part trademark protection and legal protection of designs.
The handing over of the descriptions may not be construed as the transfer of any rights.

Made in Germany, 2005

The Most Important Thing First	7
Safety Precaution	8
1 General Information.....	10
1.1 System Description	10
1.1.1 Digital Communication	11
1.1.2 Operation configurations.....	11
1.1.3 Compatibility with 637 Servo Drives (Not required for new projects)	12
1.1.4 Compatibility with 637+ Servo Drives	12
1.2 Type Code	Fehler! Textmarke nicht definiert.
1.2.1 Combination <u>possibilities</u> for the various <u>communications</u> / I/O - modules	14
1.2.2 Layout module slots	15
1.2.3 Layout of Power Board	15
1.3 Range Data	16
1.3.1 Insulation Concept	16
1.3.2 General Data.....	16
1.3.3 Compact Units 637f/K D6R.....	17
1.3.4 Plug-In Modules 637f/D6R.....	18
1.3.5 Single- and Three-Phase Supply.....	19
1.3.6 Output Power	20
1.4 Dimensions	21
1.4.1 Dimensions for Compact Device and Plug-In Module.....	21
1.4.2 EMC-Clip (optional)	22
2 Connector Assignments and Functions	23
2.1 General View of Connections for Compact Device 637f/ K D6R 02 – 10	23
2.1.1 637f/K D6R 02...10 Width 14 HP	23
2.1.2 637f/K D6R 16...30 Width 20 HP	24
2.2 Connector Pin Assignments and Contact Functions	25
2.2.1 Power Connections for <u>Plug-In Module</u> 637f/D6R.....	25
2.3 Signal Connections	26
2.3.1 Control Signal Plug X10 - SUB D25 Socket	26
2.4 Feedback Sensor X30	29
2.4.1 Function module X300.....	29
2.4.2 Feedback Sensor Connection X30 (SUB D 09 Socket)	30
2.5 Multi-function X40	31
2.5.1 Incremental <u>Output</u>	32
2.5.2 Incremental- <u>Input</u>	32
2.5.3 Stepper Motor <u>Input</u>	33
2.5.4 Stepper Motor <u>Input</u>	33
2.5.5 SSI Encoder Interface.....	34
2.6 Digital Interfaces	35
2.6.1 Service Interface - COM1 (RS232).....	35
2.6.2 Fieldbus Interface - <u>COM2</u>	36
2.7 Option module RP SBT	44
2.7.1 Safe Stop	44
2.7.2 Brake control and PTC evaluation.....	45

3	Operating modes	46
3.1	Operating modes and pin functions.....	47
3.2	Configurable pin-functions (depending on the operating mode)	48
3.3	Function diagrams from inputs and outputs	49
4	Mechanical Installation	50
4.1	Mounting	50
4.2	Control cabinet - mounting.....	50
4.3	Cooling.....	50
5	Electrical Installation.....	51
5.1	Safety	51
5.2	The danger of electric shocks.....	51
5.3	Danger areas	51
5.4	Grounding, safety grounding	51
5.4.1	Ground connections.....	51
5.5	Short-circuit capability and discharge currents.....	51
5.6	Fuses, contactors, filters.....	52
5.7	Correction of supply current	53
5.8	Brake resistor.....	54
5.8.1	Selection of the brake resistor	54
5.8.2	Configuration of the brake resistor	55
6	Wiring instructions	57
6.1	General Information	57
6.2	Control cabling	57
6.3	Power cabling	57
6.4	Installation of the rack.....	57
6.5	Analog setpoint	57
6.6	Safety rules	57
6.7	Electromagnetic compatibility (EMC).....	57
6.7.1	Hints for mounting.....	58
6.7.2	Example for mounting.....	59
6.7.3	Achievable specifications and conditions	59
7	Setting and programming.....	60
7.1	Jumper	60
7.2	Digital communication see: Chapter 13.....	60
8	Commissioning.....	61
8.1	Preparation	61
8.2	Commissioning in steps.....	62
9	Diagnose und Fehlersuche.....	65
9.1	7-segment display.....	65
9.2	Reset of a regulator trouble	69
9.3	Trouble shooting	70
10	Block circuit diagram	71

11	General Technical Data	72
11.1	Power circuit	72
11.2	Control circuit.....	72
11.3	Signal inputs and outputs, connection X10	72
11.4	Signal inputs and outputs, connection X120B resp. 120C	73
11.5	Digital control	73
11.6	Digitale communication.....	74
11.7	Resolver evaluation/transmitter principle.....	74
11.8	Controllsystem	74
11.9	Analog-Outps	75
11.10	Thermal data.....	75
11.11	Mechanical data.....	75
12	Disposal	76
13	Software	77
13.1	EASYRIDER® Windows - Software	77
13.2	SSD Drives programming language BIAS.....	78
14	Certificates	81
15	Index	86
16	Modification Record	88

Thanks for your confidence choosing our product.

These operating instructions present themselves as an overview of the technical data and features.

Please read the operating instructions before operating the product.

If you have any questions, please contact your nearest SSD Drives representative. Improper application of the product in combination with dangerous voltage can lead to injuries.

In addition, damage can also occur to motors or other products. Therefore please observe our safety precautions strictly.

Safety precautions

We assume that, as an expert, you are familiar with the relevant safety regulations, especially in accordance with VDE 0100, VDE 0113, VDE 0160, EN 50178, the accident prevention regulations of the employers liability insurance company and the DIN regulations and that you are able to use and apply them.

As well, relevant European Directives must be observed.

Depending on the kind of application, additional regulations e.g. UL, DIN are subject to be observed.

If our products are operated in connection with components from other manufacturers, their operating instructions are also subject to be observed strictly.



Attention

Digital servo drives, corresponding to EN 50178/VDE 0160, are power electronic components utilized for the regulation of the flow of energy in electrical power installations. They are exclusively designed and configured to supply SSD Drives, or SSD Drives approved, servo motors. Handling, installation, operation, and maintenance are only permitted under the conditions of and in keeping with the effective and/or legal regulations, regulation publications and this technical document.

The operator must make sure that these regulations are strictly followed.

The Concept of Galvanic Separation and Insulation:

Galvanic separation and insulation corresponding to EN 50178/VDE 0160, provides for additional insulation protection.

In addition, all digital signal inputs and outputs are provided with a galvanic separation utilizing either a relay or an optical coupler. In this way, an increased level of protection against potential interference and a limitation of potential damage due to incorrect connections are provided.

The voltage level must not exceed the designated low safety voltage of 60V DC or 25V AC, respectively, in accordance with EN 50178/VDE 0160.

The operator must make sure that these regulations are strictly followed.



Danger !

**High Voltage!
Danger of Electrocutation!
Life Threatening Danger!**



Caution !

Due to safety considerations and the product guarantee, the operator is prohibited from opening the servo drive case. Service, maintenance and repair of SSD Drives products should only be carried out by specified representatives of the company. Expert configuration and professional installation, as described by this document, are the best way to insure for the problem-free operation of the SSD Drives servo drive!

**Please
observe!**

Pay Special Attention to the Following:

Permissible Protection Class: Protective Grounding - operation is only permitted when the protective conductor is connected according to regulations.

The operation of servo drives is not allowed, under the sole use of a residual current operated protective device as protection against indirect touching. The servo drive may only be used in the rack or in its compact enclosure.

Furthermore the regulator is designed solely for control cabinet operation.

Work on or with the servo drive may only be carried out with insulated tools.

Installation work may only be done in a de-energized state. When working on the drive, one should not only block the active – input, but also separate the drive completely from the main power connection.

CAUTION - Risk of Electrical Shock:

Wait 3 minutes after switching the component off, to allow the capacitors to discharge.

Screws sealed with varnish fulfill an important protection function and may not be moved or removed.

It is prohibited to penetrate the inside of the unit with objects of any kind.

Protect the unit from falling parts, pieces of wire, metal parts, etc., during installation or other work in the control cabinet. Metal parts can lead to a short-circuit in the servo drive.

Before putting the unit into operation, remove additional covers so that the unit does not overheat. With measurements at the servo drive it is absolutely necessary to observe the potential separation



Stop !

SSD Drives GmbH is not liable for damages which may occur when the instructions and/or the applicable regulations are not explicitly observed!

1.1 System Description

The 5th generation of the digital servo drive serves to regulate the current, speed and position of **AC servo motors**, (standard: with resolver)

All control circuits and functions are realized digitally.

System variants

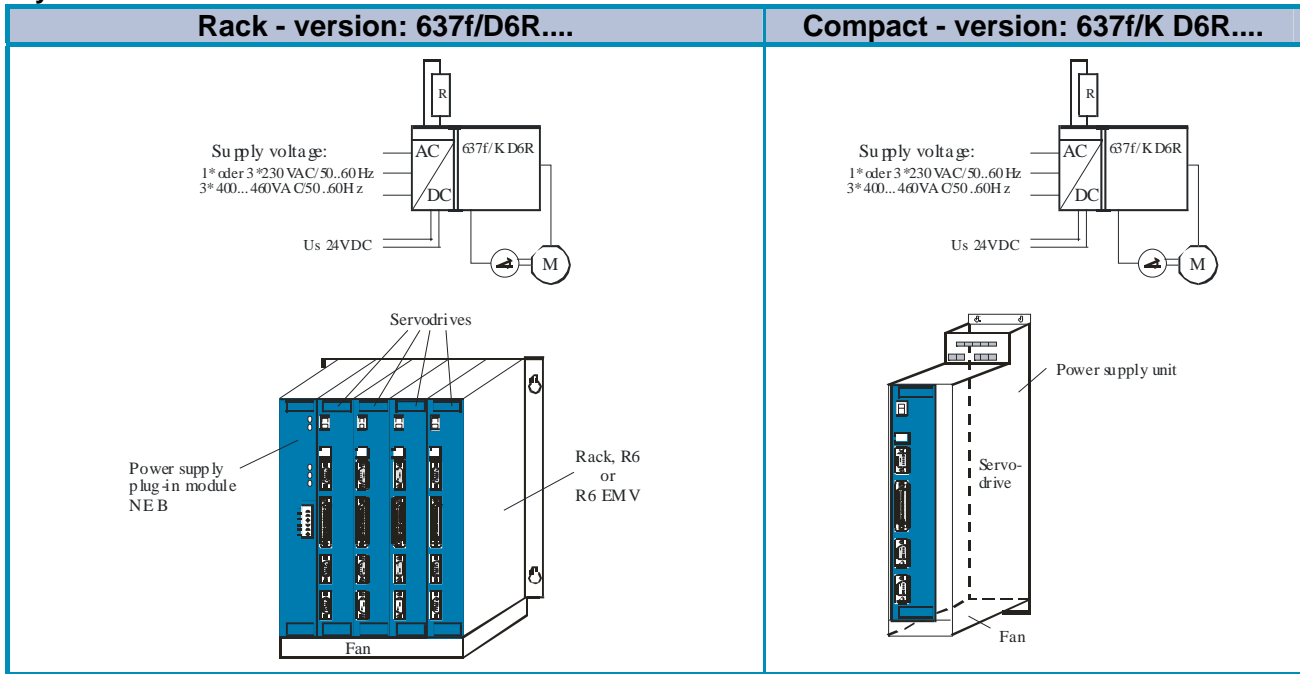

Explanations for the rack and power supply modules are documented in separate descriptions.

If required, the returned braking energy can be drawn off into additional external ballast resistors.

The AC-supply voltage is fed directly or via transformer to the associated power supply module.

The devices are designed to be operated on networks which are grounded at the centre point (TN networks) !

System Description

1.1.1 Digital Communication

Diagnostics / Setup

General: by 7 segment display

Comfortable: via PC with EASYRIDER® Windows – Software from version V8.xx
(serial interface RS232)

Communication

The serial-communication-protocol is open and fully documented.

(Explanation see separate documentation)

Every user has unrestricted access to all functions and parameters.

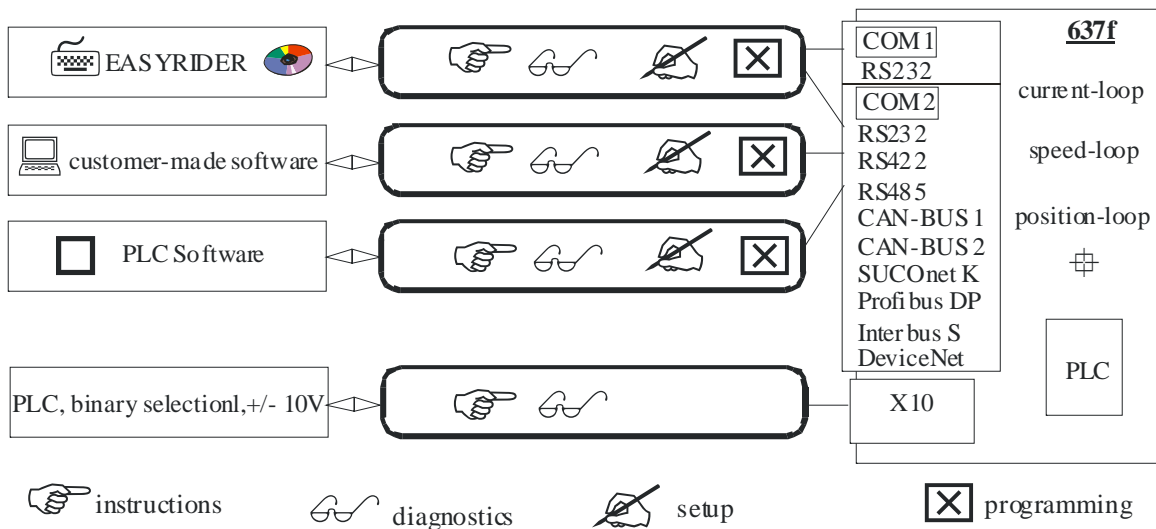

1.1.2 Operation configurations

There are opportunities ranging from simple current and speed control to programmable position control processes (PLC), supported by the 1500 BIAS command blocks.

"BIAS" User shell for intelligent drive controls

see:

- chapter 3 Operating modes
- chapter 13.2 BIAS commands
- chapter 13.3 Extended BIAS commands

System Description

1.1.3 Compatibility with 637 Servo Drives (Not required for new projects)

The 637f series servo drives are essentially pin- and functionally compatible with the servo drives 637. However, when a servo drive 637 is replaced with a 637f drive, the existing application must be checked and carefully tested to determine compliance under the corresponding safety precautions.

The following points should be checked in any case and eventually be adjusted before the function test:

1. Motor direction parameter and limit switch setting (see release note V6.12)
2. Position setpoints and comparison values have to be quadrupled, resp. sixteenfold (low encoder resolution at 637)
3. Coupling factors in synchronous applications have to be quadrupled, resp. sixteenfold (low encoder resolution at 637)
4. Execution of BIAS- and PLC programs is 2.25 times quicker than with the 637. This can cause timing problems with improper programming (e.g. wait times with NOPs)

1.1.4 Compatibility with 637+ Servo Drives (Not required for new projects)

Der Servoregler **637f** ist voll funktionskompatibel zu **637+**

Funktion	637	637+	637f
PC-Operating-Software	EASYRIDER® DOS Version or Windows Version	EASYRIDER® Windows Version	EASYRIDER® Windows Version V8.xx
PC-Connection-Cable see: chapter 2.6.2.3	PC - SUBD-9 to LEMO connector (COM1)	PC - SUBD-9 to 4-pin module connector (COM1)	
Power Part, Power Data and Power Connectors	equal		
Control Singals, Connector X10 see: chapter 2.3.2	equal pinning and function		
Analog Set Point X10.5/18, Resolution	12 bits	14 bits	
Resolver Signals, Connector X30 see: chapter 2.4.2	pin-compatible 12/14 Bit Resolution	extended functionality 16 Bit Resolution	
Feedback – Interface - Module X300 see: chapter 2.4.1	-	HIPERFACE	
Multifunction, Connector X40 see: chapter 2.5	compatible	extended functionality	
Interface, Connector COM2 see: chapter 2.6.2 – 2.6.2.9	equal		extended functionality CAN BUS 2, RP_2Cx
Options Module see: chapter 2.6.2 – 2.6.2.10	equal		extended functionality RP_SBT
Operating Modes, BIAS – Functions see: chapter 3 and 13.2	command set compatible position value 12/14 bits ≈ 1revolution	future extensions possible position value 16 bit ≈ 1 revolution	
PROG-Key	present	not available	
Analog-Output - Test Signals MP1/MP2: > connector X 10	X 10.6 / X 10.17		
> Front Test Sockets	yes	no	
Technical Data Analog Out MP1 / X10.17 MP2 / X10.6	7 bits , Rout = 10 kOhm 7 bits , Rout = 10 kOhm	8 bits , Rout = 1.8 kOhm 10 bits , Rout = 1.8 kOhm	
Control Loops see: chapter 11.5		performance boost compared to 637: cycle time twice as fast	performance boost as compared to 637f: cycle time for speed twice as fast, position eight times as fast
Control Loop Parameters	Generally compatible, possible optimization required		
Jumper see: chapter 7.1	JP2.2, JP2.3, JP2.7, JP2.8		

1.2 Modle code

marking	standard					optional				special	
		a	b	c	d	e	f	g1	g2	h	i
type:	637f/	X	D6R	XX	.S5	-X	-X	-XXX	-XXX	-XXx	-XXX

marking	description										
	XXXX/ = 637f ≡ SSD Drives- fast -design										
a	K	= 1-axis-compact digital-servo drive system									
	0	= design plug-in device									
b	D6R	= Digital 6U drive									
c	Rated current:										
	02	= 2 amps									
	04	= 4 amps									
	06	= 6 amps									
	10	= 10 amps									
	16	= 16 amps									
	22	= 22 amps									
	30	= 30 amps									
d	.S5	= Digital servo drive 5 th generation									
e	Intermediate circuit rated voltage:										
	-3	= 325V (230V AC) 16..30A only as rack system possible									
	-7	= 650V (460V AC)									
f	-E	= With EMC-Clip unit									
	-0	= Without EMC-Clip unit									
g1	additional option modules on the drive for communication via COM2										
	-000	= None option									
	-232	= RS 232 interface								≡ slot A (B)	
	-422	= RS 422 interface								≡ slot A (B)	
	-485	= RS 485 interface								≡ slot A (B)	
	-CAN	= CAN – Bus								≡ slot A (B)	

	-2CA	= 2 x CAN (without I/O's)								≡ slot B (A) / [C*]	
	-2C8	= 2 x CAN + 4 outputs and 4 inputs								≡ slot B (A) / [C*]	
	-DEV	= CAN - Bus / DeviceNet								≡ slot B (A)	
	-SUC	= SUCOnet K								≡ slot B (A)	
	-PDP	= Profibus DP								≡ slot B (A)	
	-IBS	= Interbus S (Attention: changed front plate)								≡ slot B (A)	
	-EA5	= I/O interface (5 inputs, 2 outputs)								≡ slot B (A)	
g2	additional option modules on the drive via X200 (Attention: changed front plate)										
	-000	= No Options									
	-EAE	= I/O interface (14 inputs, 10 outputs)								≡ slot C	
	-SBT	= Safety – Board Module								≡ slot C	
h	X300 – Function module										
	-RD2	= Standard X30 Resolver module 2 nd version								≡ slot D	
	-HF2	= HIPERFACE module 2 nd version								≡ slot D	
	-SC2	= Sinus / Cosinus - module 2 nd version								≡ slot D	
i	Entry only at use										
	-Sxx	= Special - resistance - setting									
	-X7x	= Broad-band contact X10.7 - X10.8									
	-BSx	= Protection moisture condensation									
	-B7x	= Protection moisture condensation + Broad-band contact X10.7 - X10.8									
	-923	= Jumper 209 / 2 - 3 open , by SBT - Option Thermo - Contact X30 (PTC / NTC)									

at assignment [C] Interface you can used 1 x CAN *

Typical Example

A typical example of an order of a 1-axis compact device in SSD Drives design:

Type:	a	b	c	d	e	f	g1	g2	h	i
	637f/	KD6R	02	.S5	-3	-0	-2CA	-EAE	-RD2	-

Modle Code

1.2.1 Combination possibilities for the various communications / I/O - modules

Slots ⇨	A				B							C				
Option modules ⇨	232	422	485	CAN	2CA	2C8	DEV	SUC	PDP	IBS	EA5	EAE	SBT	*2CA	*2C8	
Type Code ↓																
637f/xD6Rxx.S5-x-x-232-000-xxx	●	-	-	-	-	-	-	-	-	-	-	-	-	-	-	
637f/xD6Rxx.S5-x-x-232-EAE-xxx	●	-	-	-	-	-	-	-	-	-	-	●	-	-	-	
637f/xD6Rxx.S5-x-x-232-SBT-xxx	●	-	-	-	-	-	-	-	-	-	-	-	●	-	-	
637f/xD6Rxx.S5-x-x-232-2CA-xxx	●	-	-	-	-	-	-	-	-	-	-	-	-	●	-	
637f/xD6Rxx.S5-x-x-232-2C8-xxx	●	-	-	-	-	-	-	-	-	-	-	-	-	-	●	
637f/xD6Rxx.S5-x-x-422-000-xxx	-	●	-	-	-	-	-	-	-	-	-	-	-	-	-	
637f/xD6Rxx.S5-x-x-422-EAE-xxx	-	●	-	-	-	-	-	-	-	-	-	●	-	-	-	
637f/xD6Rxx.S5-x-x-422-SBT-xxx	-	●	-	-	-	-	-	-	-	-	-	-	●	-	-	
637f/xD6Rxx.S5-x-x-422-2CA-xxx	-	●	-	-	-	-	-	-	-	-	-	-	-	●	-	
637f/xD6Rxx.S5-x-x-422-2C8-xxx	-	●	-	-	-	-	-	-	-	-	-	-	-	-	●	
637f/xD6Rxx.S5-x-x-485-000-xxx	-	-	●	-	-	-	-	-	-	-	-	-	-	-	-	
637f/xD6Rxx.S5-x-x-485-EAE-xxx	-	-	●	-	-	-	-	-	-	-	-	●	-	-	-	
637f/xD6Rxx.S5-x-x-485-SBT-xxx	-	-	●	-	-	-	-	-	-	-	-	-	●	-	-	
637f/xD6Rxx.S5-x-x-485-2CA-xxx	-	-	●	-	-	-	-	-	-	-	-	-	-	●	-	
637f/xD6Rxx.S5-x-x-485-2C8-xxx	-	-	●	-	-	-	-	-	-	-	-	-	-	-	●	
637f/xD6Rxx.S5-x-x-CAN-000-xxx	-	-	-	●	-	-	-	-	-	-	-	-	-	-	-	
637f/xD6Rxx.S5-x-x-CAN-EAE-xxx	-	-	-	●	-	-	-	-	-	-	-	●	-	-	-	
637f/xD6Rxx.S5-x-x-CAN-SBT-xxx	-	-	-	●	-	-	-	-	-	-	-	-	●	-	-	
637f/xD6Rxx.S5-x-x-2CA-000-xxx	-	-	-	-	●	-	-	-	-	-	-	-	-	-	-	
637f/xD6Rxx.S5-x-x-2CA-EAE-xxx	-	-	-	-	●	-	-	-	-	-	-	●	-	-	-	
637f/xD6Rxx.S5-x-x-2CA-SBT-xxx	-	-	-	-	●	-	-	-	-	-	-	-	●	-	-	
637f/xD6Rxx.S5-x-x-2C8-000-xxx	-	-	-	-	-	●	-	-	-	-	-	-	-	-	-	
637f/xD6Rxx.S5-x-x-2C8-EAE-xxx	-	-	-	-	-	●	-	-	-	-	-	●	-	-	-	
637f/xD6Rxx.S5-x-x-2C8-SBT-xxx	-	-	-	-	-	●	-	-	-	-	-	-	●	-	-	
637f/xD6Rxx.S5-x-x-DEV-000-xxx	-	-	-	-	-	-	●	-	-	-	-	-	-	-	-	
637f/xD6Rxx.S5-x-x-DEV-EAE-xxx	-	-	-	-	-	-	●	-	-	-	-	●	-	-	-	
637f/xD6Rxx.S5-x-x-DEV-SBT-xxx	-	-	-	-	-	-	●	-	-	-	-	-	●	-	-	
637f/xD6Rxx.S5-x-x-SUC-000-xxx	-	-	-	-	-	-	-	●	-	-	-	-	-	-	-	
637f/xD6Rxx.S5-x-x-SUC-EAE-xxx	-	-	-	-	-	-	-	●	-	-	-	●	-	-	-	
637f/xD6Rxx.S5-x-x-SUC-SBT-xxx	-	-	-	-	-	-	-	●	-	-	-	-	●	-	-	
637f/xD6Rxx.S5-x-x-PDP-000-xxx	-	-	-	-	-	-	-	-	●	-	-	-	-	-	-	
637f/xD6Rxx.S5-x-x-PDP-EAE-xxx	-	-	-	-	-	-	-	-	●	-	-	●	-	-	-	
637f/xD6Rxx.S5-x-x-PDP-SBT-xxx	-	-	-	-	-	-	-	-	●	-	-	-	●	-	-	
637f/xD6Rxx.S5-x-x-PDP-2CA-xxx	-	-	-	-	-	-	-	-	●	-	-	-	-	●	-	
637f/xD6Rxx.S5-x-x-PDP-2C8-xxx	-	-	-	-	-	-	-	-	●	-	-	-	-	-	●	
637f/xD6Rxx.S5-x-x-IBS-000-xxx	-	-	-	-	-	-	-	-	-	●	-	-	-	-	-	
637f/xD6Rxx.S5-x-x-IBS-EAE-xxx	-	-	-	-	-	-	-	-	-	●	-	●	-	-	-	
637f/xD6Rxx.S5-x-x-IBS-SBT-xxx	-	-	-	-	-	-	-	-	-	●	-	-	●	-	-	
637f/xD6Rxx.S5-x-x-EA5-000-xxx	-	-	-	-	-	-	-	-	-	-	●	-	-	-	-	
637f/xD6Rxx.S5-x-x-EA5-EAE-xxx	-	-	-	-	-	-	-	-	-	-	●	-	-	-	-	
637f/xD6Rxx.S5-x-x-EA5-SBT-xxx	-	-	-	-	-	-	-	-	-	-	●	-	●	-	-	
637f/xD6Rxx.S5-x-x-000-EAE-xxx	-	-	-	-	-	-	-	-	-	-	-	●	-	-	-	
637f/xD6Rxx.S5-x-x-000-SBT-xxx	-	-	-	-	-	-	-	-	-	-	-	-	●	-	-	

-000 = none option

● possible combination

at assignment [C] Interface you can used 1 x CAN *

Example:

637f/xD6Rxx.S5-x-x-232-EAE-RD2

... -232

... -EAE

... -RD2

= on slot A

= on slot C

= on slot D (Motor - Feedbacksystem)

Module Code

1.2.2 Layout module slots

Module slots:

- A**
 - 232
 - 422
 - 485
 - CAN
- B**
 - 2CA
 - 2C8
 - DEV
 - SUC
 - PDP
 - IBS
 - EA5
- C**
 - EAE
 - SBT
 - *-2CA
 - *-2C8

Motor - Feedbacksysteme:

- D**
 - RD2: Standard resolver
 - HF2: Option HIPERFACE®
 - SC2: Option rotor position transmitter

* kann nur 1 mal CAN verwendet werden

Note: The option modules of the slots A / B / C can only be reached after removing the cooling plate.

1.2.3 Layout of Power Board

View solder side (solder jumper)

- JP2.8
- JP2.3
- JP2.7
- JP2.2
- JP101. 1/ 2/ 3
- JP102 1/ 3/ 2
- JP100 2/ 3/ 1
- JP1 1/ 3/ 2
- JP2 2/ 3/ 1
- JP3 1/ 3/ 2
- JP4 2/ 3/ 1
- JP209. 1/ 2/ 3

Solder jumper function
see: Chapter 7.1

1.3 Range Data

1.3.1 Insulation Concept

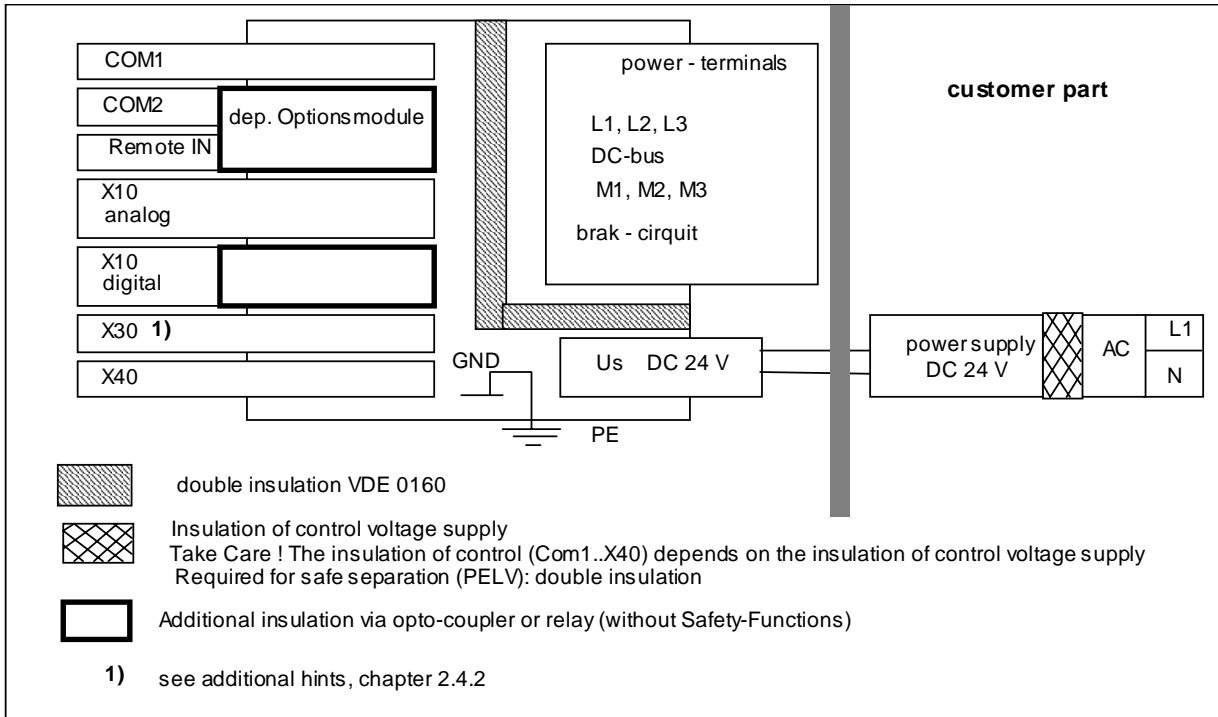

1.3.2 General Data

Enclosure Rating - for Mounting in a Cubicle		IP20
Operating Temperature Range		EN 50178 / VDE 0160, class 3K3
Storage Temperature Range		-25°...+55° C
Air Pressure		86 kPa - 106 kPa
Humidity		5% - 85%, 40°C
Operating Temp		0...40°C
Reduced Operation De-rating of the Output Current	1)	>40°...< 50°C 2% / °C
Altitude h		h ≤ 1000m
Reduced Operation De-rating of the Output Current	1)	h > 1000...≤ 4000m 1% / 100m
Safety Over Voltage - Category of Power Circuit		EN 50178 / VDE 0160, UL, cUL III,
Pollution Degree - for Mounting in a Cubicle		VDE / UL: 2
Vibration Test in Accordance with DIN IEC 68-2-6, Test FC Condition for Testing Frequency Range Amplitude Acceleration Test Time per Axis Frequency Sweep Speed		10...57Hz 57...150Hz 0,075 mm 1g 10 sweep cycle 1 octave/min

1) Use only fan-cooled devices. For reduced operating conditions, no UL approval is available.

Range Data

1.3.3 Compact Units 637f/K D6R

Compact Units		637f /	K D6R 02		K D6R 04		K D6R 06		K D6R 10		K D6R 16		K D6R 22		K D6R 30			
			.S5	.S5	.S5	.S5	.S5	.S5	.S5	.S5	.S5	.S5	.S5	.S5	.S5	.S5	.S5	
			-3	-7	-3	-7	-3	-7	-3	-7	-3	-7	-3	-7	-3	-7		
Input																		
Supply Voltage	min.	[V]	14															
50..60 Hz	Un	[V]	230	460	230	460	230	460	230	460	460	460	460	460	460	460		
	max.	tolerance	+ 10%															
Phases			1;3	3	1;3	3	1;3	3	3									
Supply Preparation			Fuses, contacts, filters see chapter 5.6															
Power-On Current Limit	model		NTC 4 Ohm								NTC 2 Ohm							
Control Voltage	¹⁾ Us	[V]	21,5....24....29, attention: insulation-concept chapter 1.3.1															
Control Current incl. Fan	Is DC	[A]	Continuous: max. 1,2A Power-On-Peak: nom. 3A; max.. 6A / 0,8 mS, 2,5A / 25 mS								Continuous: max 1,5A Power-On-Peak: nom. 3A; max. 6A / 0,8 mS, 3A / 25 mS							
Output																		
Sine-Wave Voltage at Un	Unr	[Veff]	220	447	220	447	220	447	220	447	447	447	447	447	447	447 ³⁾		
De-rating of Unr			depending upon load and single or 3-phase supply. (see chapter 1.3.5)															
Rated Current RMS	Inr	[A]	2	4	4	8	6	10	16	22	30 ³⁾	30 ³⁾	30 ³⁾	30 ³⁾	30 ³⁾	30 ³⁾		
Max. Current RMS Time for Imax	⁴⁾ Imaxr min.	[A] Sec	4	5	8	5	12	5	20	5	32	5	44	5	60	5		
Min. Motor Inductance (terminal / terminal)	Lph/ph	[mH]	6,0	12,0	3,0	6,0	2,0	4,0	1,2	2,4	2,0	1,1	0,8	0,8	0,8	0,8		
Brake Circuit																		
Setpoint DC	Ub	[V]	375	730	375	730	375	730	375	730	730	730	730	730	730	730		
Max. Power	Pbmax	[kW]	4,5	8,7	4,5	8,7	6,7	13,0	11,2	21,7	29,0	34,8	34,8	34,8	34,8	34,8		
Continuous Power	Pbnenn	[W]	≤ 560															
Internal Resistor	Rbint	[Ω]	100	300	100	300	100	300	100	300	-----							
	Pd	[W]	30	30	30	30	30	30	30	30	-----							
	Pmax	[kW]	1,4	1,7	1,4	1,7	1,4	1,7	1,4	1,7	-----							
Min. External Resistor	²⁾ Rbextmin	[Ω]	47	82	47	82	27	47	15	27	20	15	15	15	15	15		
General																		
Power Loss Fan, Electronic	PE loss	[W]	29	29	29	29	29	29	29	29	36	36	36	36	36	36		
Fan Models 24V DC		[V]	2 Piece L 024 / (12TE * 25) 1 Piece L 024 / (12TE * 15)								2 Piece L 024 / (16TE x 25) 1 2 Piece L 024 / (16TE x 20)							
Power Stage per A		[W/A]	9	12	9	12	9	12	9	12	12	12	12	12	12	12		
Weight		[kg]	5,0								8,8							
Additional Data			see: chapter 11															

- 1) Suggested: transformer-based supply
- 2) Use only SSD Drives-released types
- 3) Max. continuous performance reduced to 80%, see chapter 1.3.6
- 4) References chapter 1.3.6

Range Data

1.3.4 Plug-In Modules 637f/D6R

Plug-In Modules			637f/		D6R 02		D6R 04		D6R 06		D6R 10		D6R 16		D6R 22		D6R 30		
			.S5		.S5		.S5		.S5		.S5		.S5		.S5		.S5		
			-3	-7	-3	-7	-3	-7	-3	-7	-3	-7	-3	-7	-3	-7	-3	-7	
Input																			
DC-BUS Rated		min.	[V]	20															
		U _g	[V]	325	650	325	650	325	650	325	650	325	650	325	650	325	650	325	650
		max.	tolerance	+ 10%															
Control Voltage		U _s	[V]	24V DC +20% -10%, attention: insulation-concept chapter 1.3.1															
Control Current	¹⁾	I _s DC	[A]	Continuous: max 0,8A Power-On-Peak: nom. 2A; max 5A / 0,8 mS, 2A / 25mS															
Fan	²⁾	Typ		---	L220 K	---	L220K					L220G							
Output																			
Sine-Wave Voltage at Un		Unr	[Veff]	220	447	220	447	220	447	220	447	220	447	220	447	220	447	220	447 ³⁾
De-rating of Unr				depending on load and single or 3-phase supply (see chapter 1.3.5)															
Rated Current RMS		Inr	[A]	2		4		6		10		16		22		30 ³⁾			
Max. Current RMS		I _{maxr}	[A]	4		8		12		20		32		44		60			
Time for I _{max}			min.	5 Sec		5 Sec		5 Sec		5 Sec		5 Sec		5 Sec		5 Sec			
Min. Motor Inductance (terminal / terminal)		L _{ph/ph}	[mH]	6,0	12,0	3,0	6,0	2,0	4,0	1,2	2,4	1,0	2,0	0,55	1,1	0,4	0,8		
Brake-Circuit																			
Setpoint DC		U _b	[V]	375	730	375	730	375	730	375	730	375	730	375	730	375	730	375	730
Max. Power		P _{bmax}	[kW]	4,5	8,7	4,5	8,7	6,7	13,0	11,2	21,7	15,0	29,0	18,0	34,8	18,0	34,8		
Continuous Rating		P _{bnenn}	[W]	≤ 560															
Min. External Resistor	²⁾	R _{bextmin}	[Ω]	33	63	33	63	22	43	12	24	10	20	8,2	15	8,2	15		
General																			
Power Loss Electronic Output Stage per A		PE loss	[W]	20	20	20	20	20	20	20	20	20	20	20	20	20	20	20	
			[W/A]	9	12	9	12	9	12	9	12	9	12	9	12	9	12		
Weight			[kg]	1,5								4,0							
Additional Data				see chapter 11															

- 1) Suggested: transformer-based supply
- 2) Use only SSD Drives-released types
- 3) Max. continuous performance reduced to 80%, see chapter 1.3.6
- 4) References chapter 1.3.6

Range Data

1.3.5 Single- and Three-Phase Supply

Due to the line-ripple of the DC-Bus, the rate of usable output voltage is reduced as follows. This reduction affects the maximum attainable speed of the applied motor.

Three-phase supply:
The unloaded output voltage will be reduced to approx. 90%, maximally 85 %

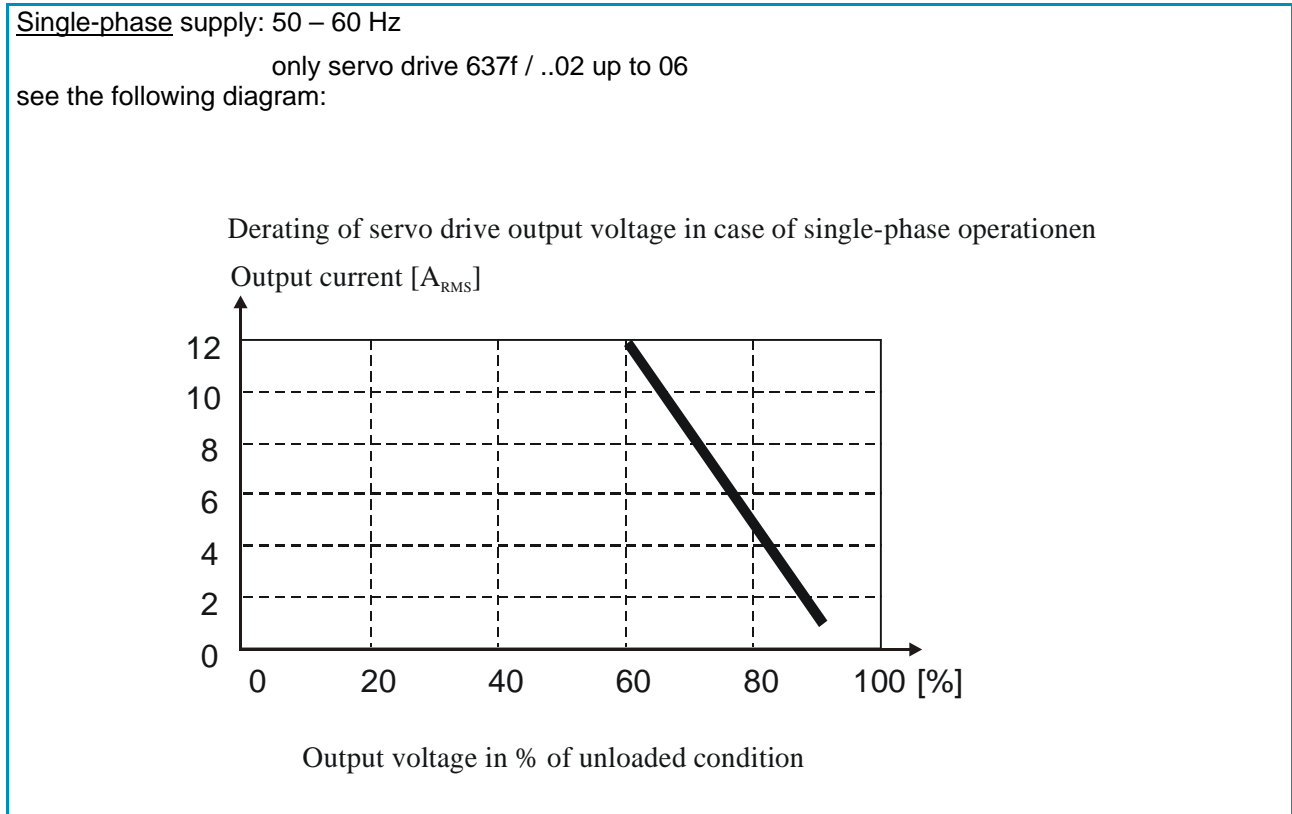

Hint for parameterization:

To avoid unexpected tripping of the under voltage threshold, the parameter setting should be left on default values (EASYRIDER® Windows – Software).

Required motor-terminal-voltage for specified speed.

Approximation: (up to 3000RPM)

$$U_{kl} = 1,2 * (EMF * n / 1000) + I * (R_{ph} + R_L) [V]$$

U_{kl} Required motor voltage [V_{RMS}]
 EMF Back-EMF of motor [V_{RMS}] / 1000 RPM
 R_{ph} Resistance of motor (between terminals) [Ω]
 R_L Line resistance of motor cable [Ω]
 I Motor-current [A_{RMS}]

Range Data

1.3.6 Output Power

In case of continuous operation in the full-load range, the limits as shown in the following diagram need to be respected.

Typical servo applications are not affected by this restriction. (S3 operation: Start/Stop).

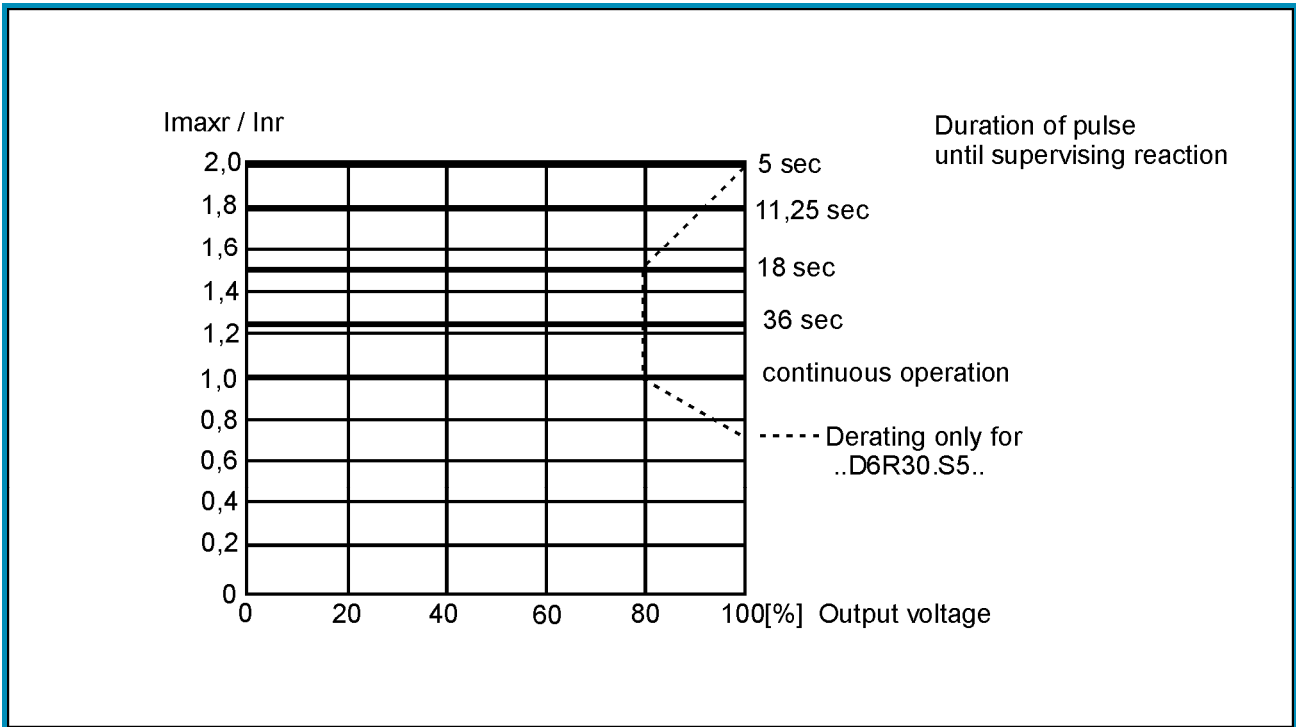

1.4 Dimensions

1.4.1 Dimensions for Compact Device and Plug-In Module

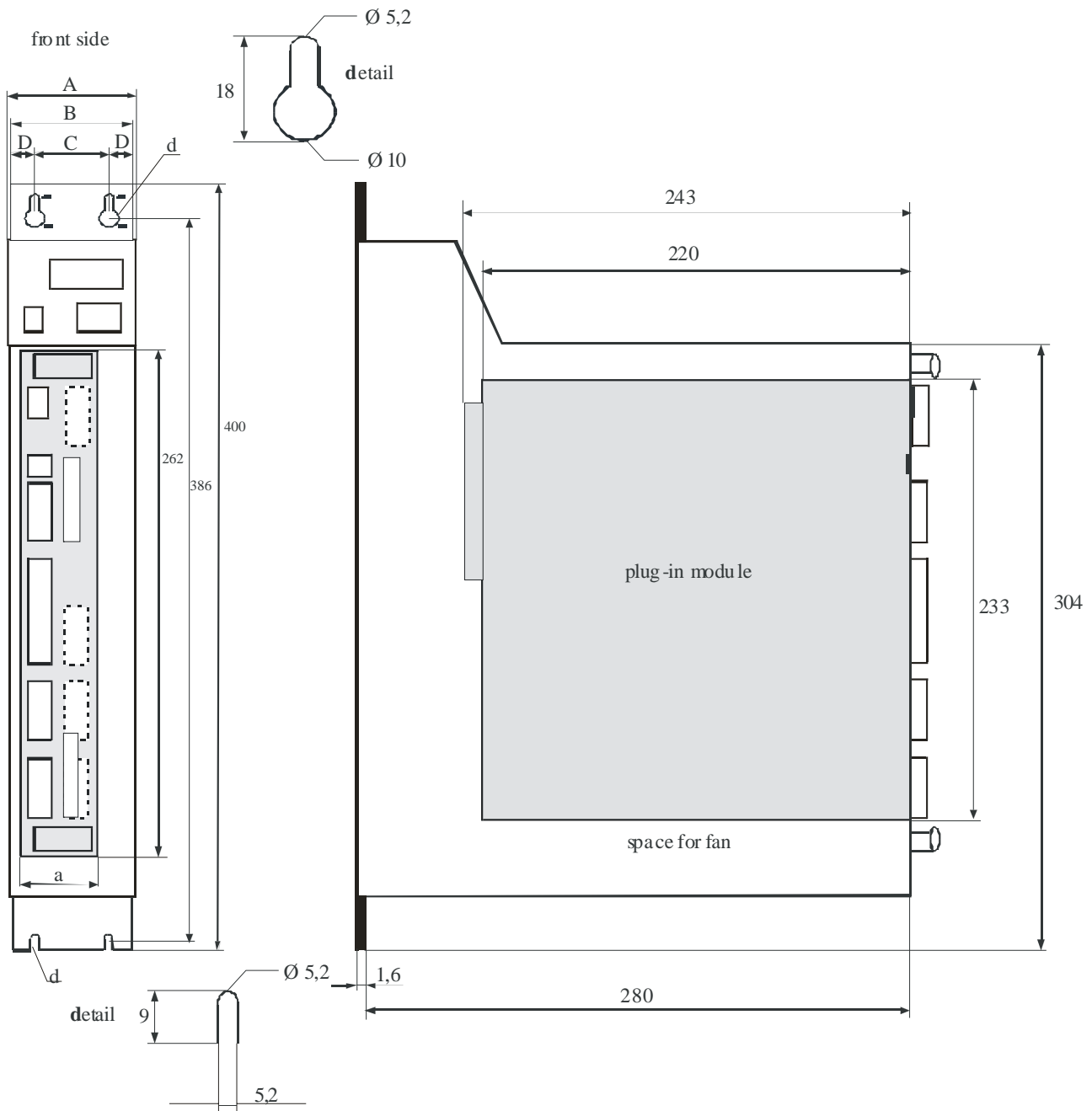

	637f/K D6R 02...10	width	637f/K D6R 16...30	width
A	65,0 mm	14 HP	104,6 mm	20 HP
B	60,0 mm		100,0 mm	
C	30,0 mm		71,0 mm	
D	14,5 mm		14,5 mm	
a	40,2 mm	8 HP	80,4 mm	16 HP

1 HP ≈ 5,08mm

Important Note:

You will need additional space on the front side, of approx. 70 mm, for the signal mating plugs!

Dimensions

1.4.2 EMC-Clip (optional)

1.4.2.1 For 8 HP Drive

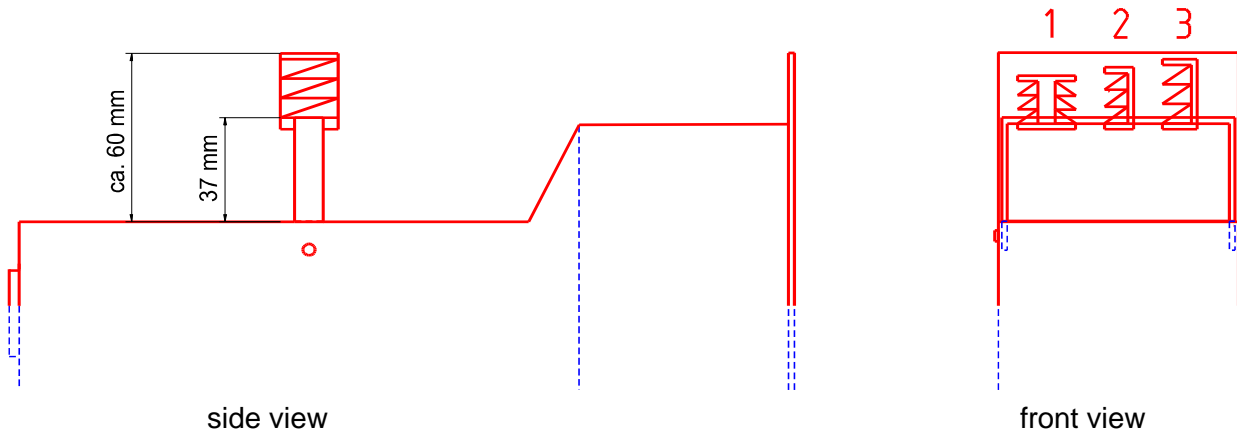

1.4.2.2 For 16 HP Drive

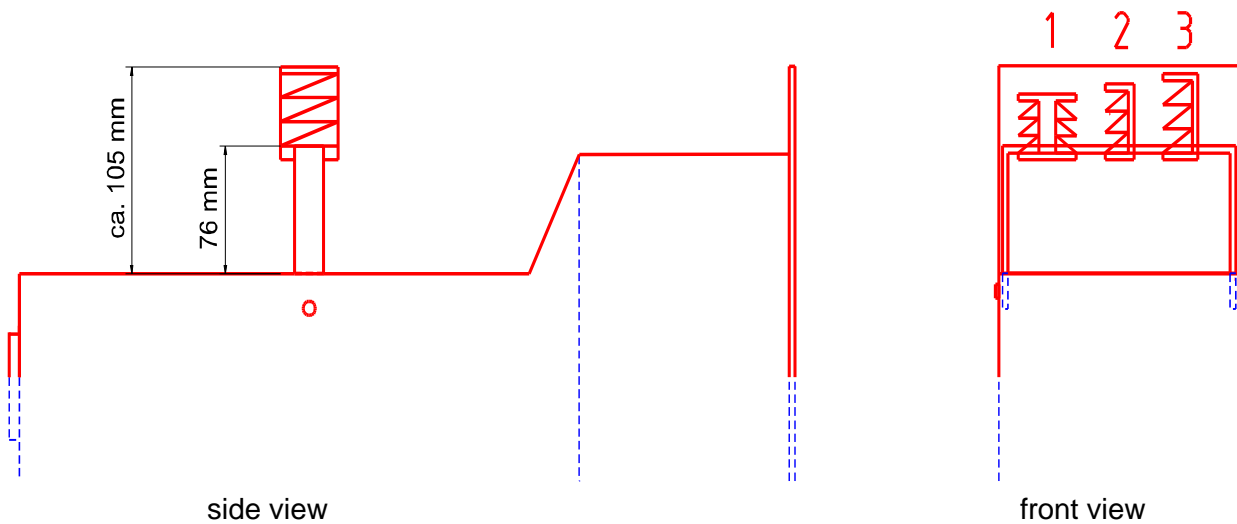

EMC - Clip for	
Feedback cable (e.g. Resolver)	1
Mains cable	2
Motor cable	3

Meaning:

1,2,3 = cage clamp terminals

2.1 General View of Connections for Compact Device 637f/ K D6R 02 – 10

2.1.1 637f/K D6R 02...10 Width 14 HP

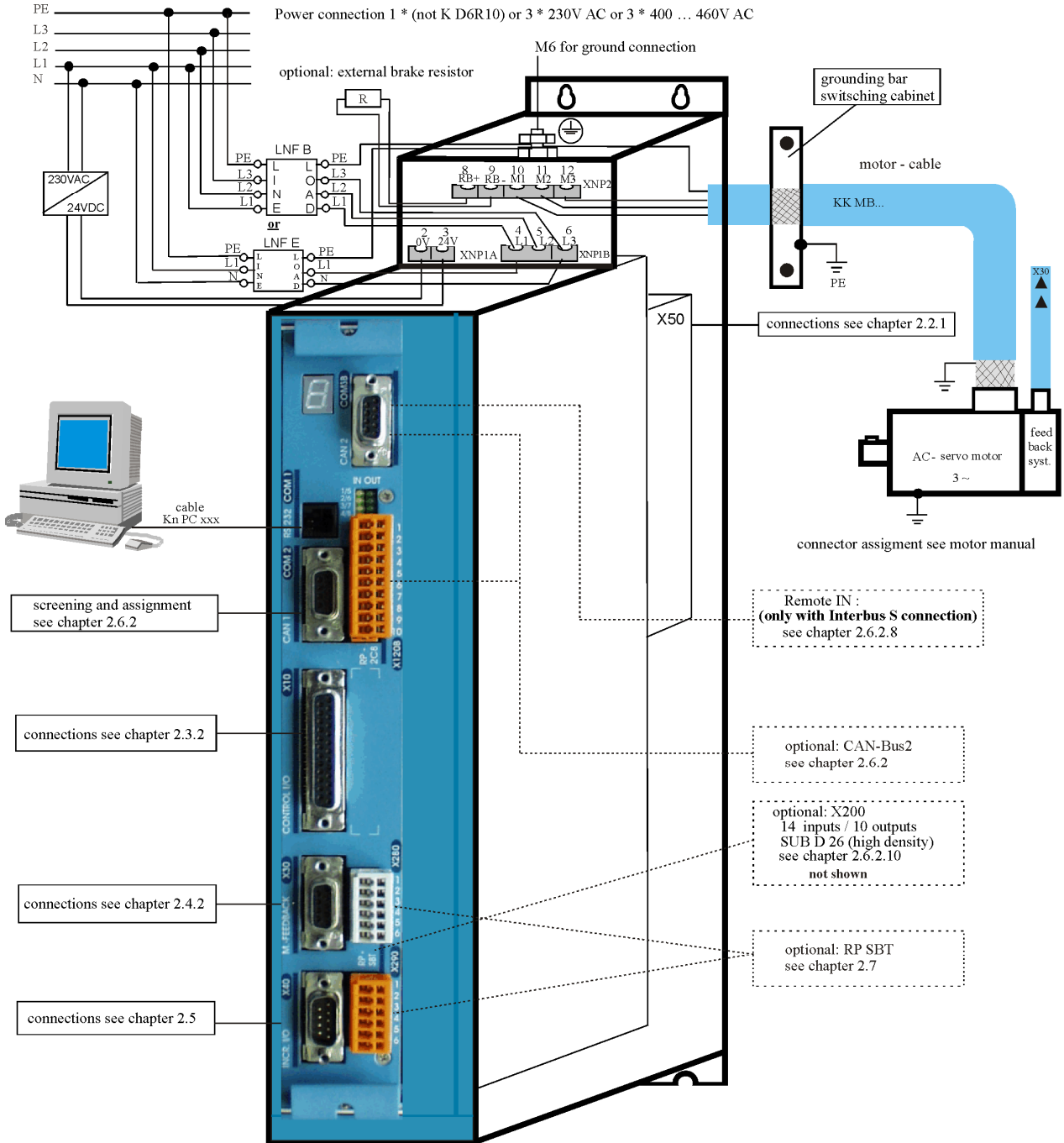

General View of Connections for Compact Device 637f/ K D6R 02 – 10

2.1.2 637f/K D6R 16...30 Width 20 HP

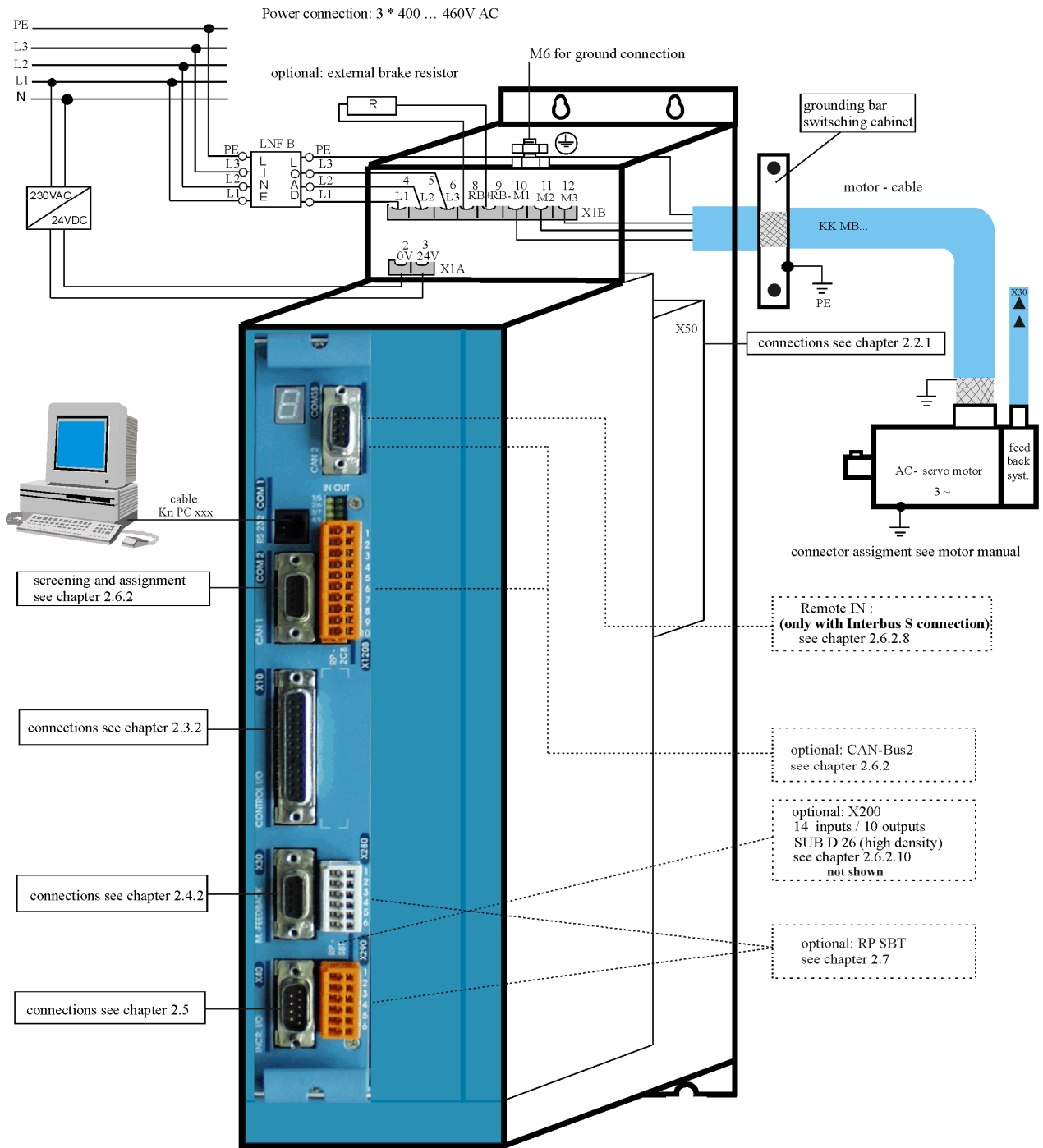

2.2 Connector Pin Assignments and Contact Functions

2.2.1 Power Connections for Plug-In Module 637f/D6R (at the rear of the rack) (H15 multiple pin strip according to DIN 41612)

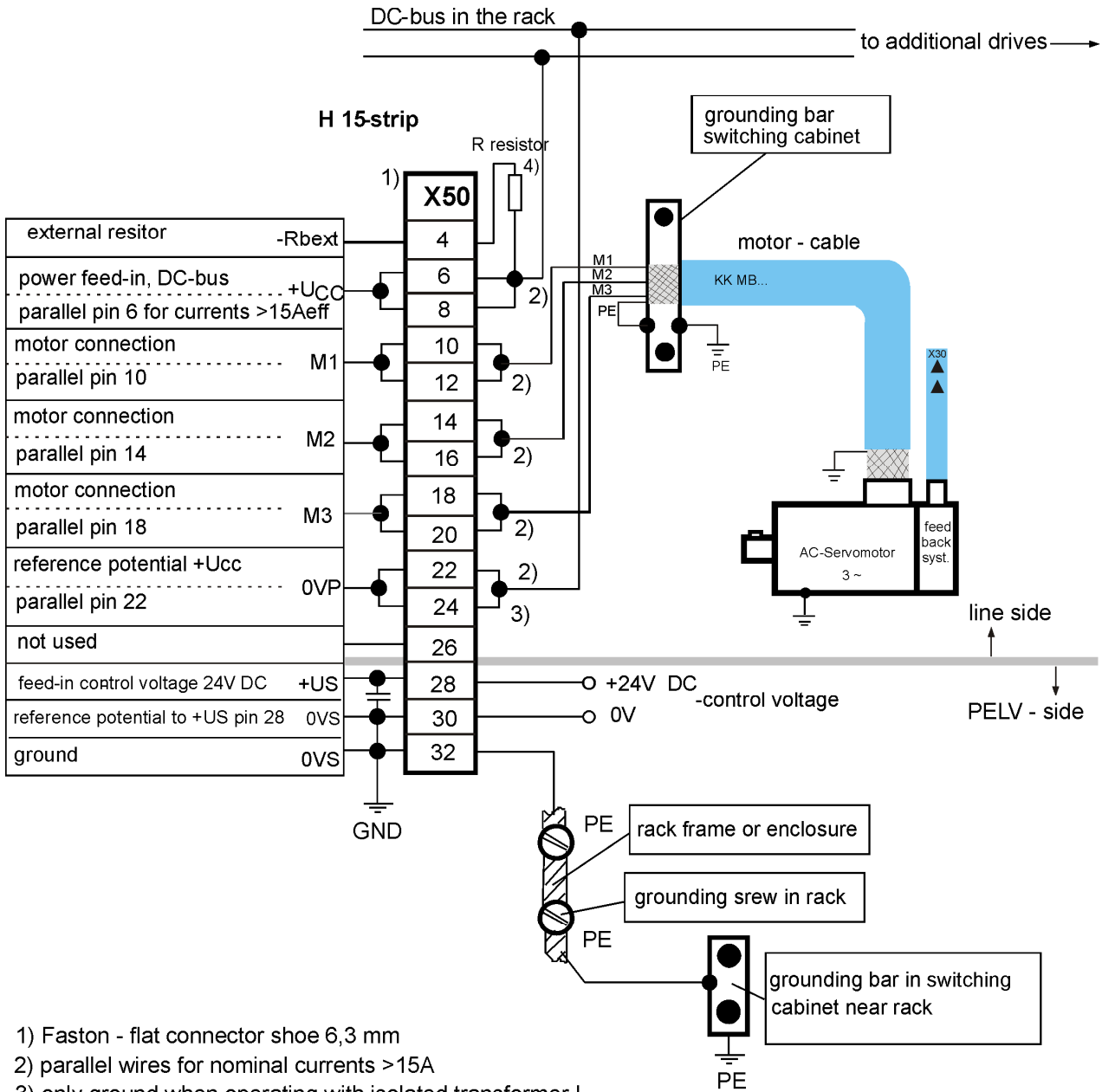

- 1) Faston - flat connector shoe 6,3 mm
- 2) parallel wires for nominal currents >15A
- 3) only ground when operating with isolated transformer !
Do not ground when operating with autotransformer or directly on mains!
- 4) resistor, provided that it is not accessed from power unit NEB.

2.3 Signal Connections

2.3.1 Control Signal Plug X10 - SUB D25 Socket
Complete Representation X10

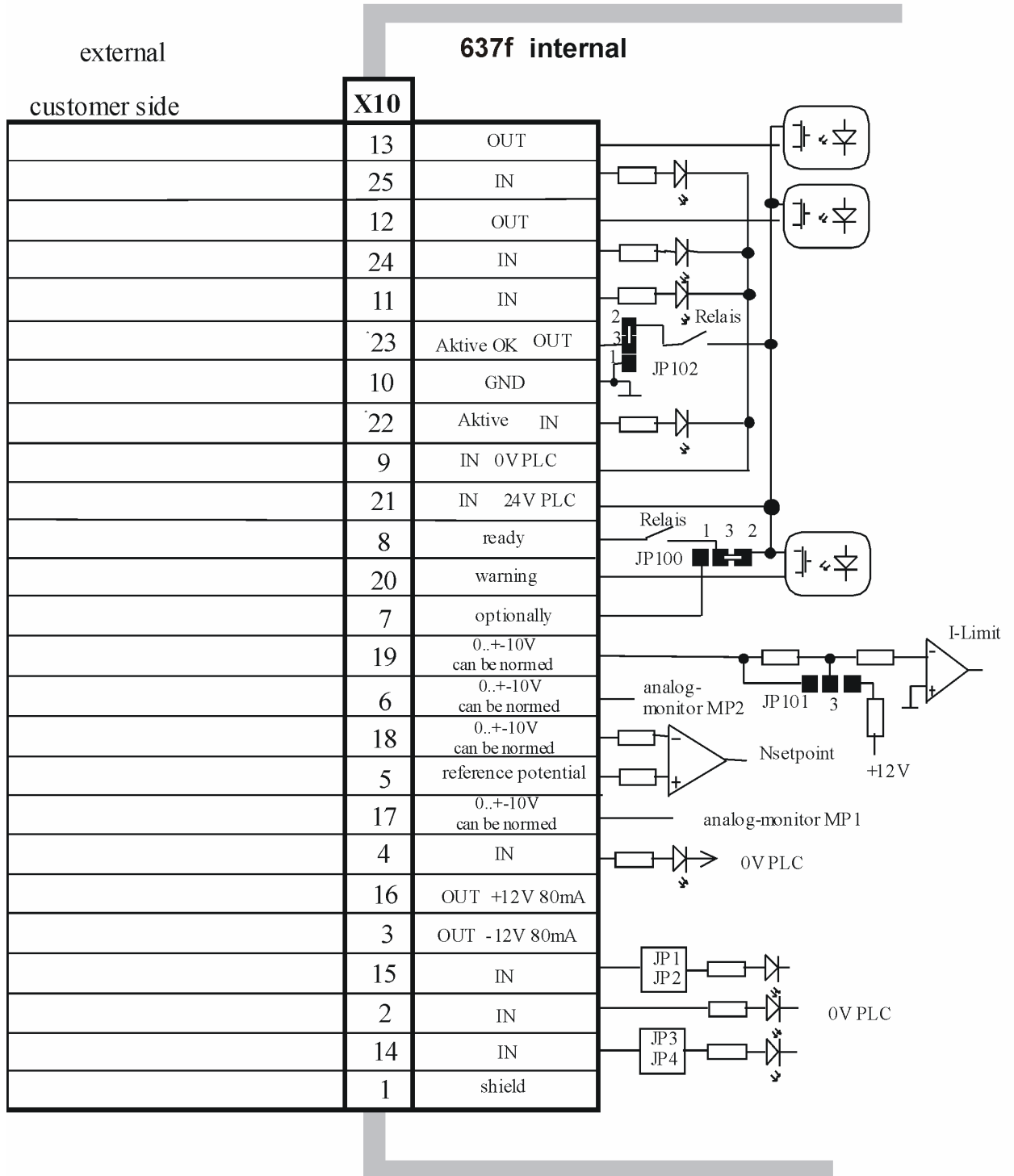

Reference to pin 22 & pin 23: With controllers with option module SBT, kindly note the extended functions of these signals (see documentation 07-02-10-02-E-Vxxxx).

Signal Connections

Control Signal Plug X10 - SUB D25 Socket

Connection Example
(without option SBT)

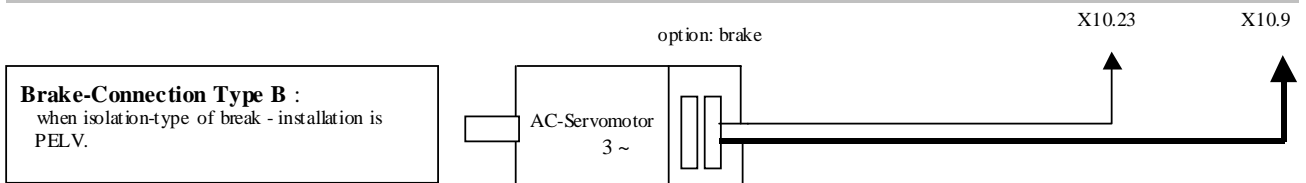
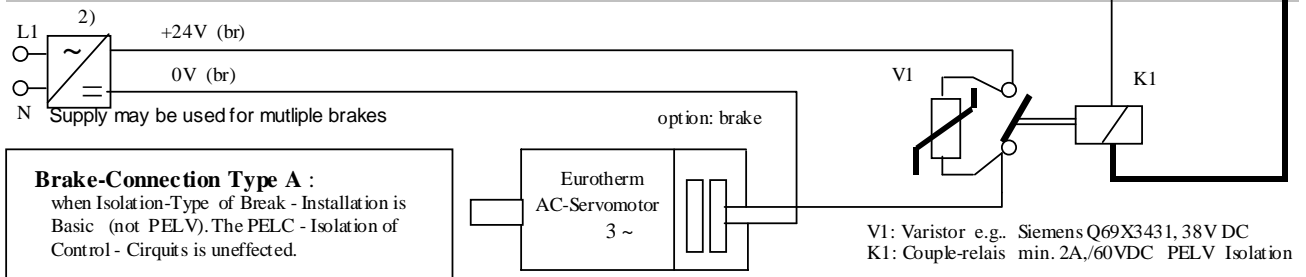
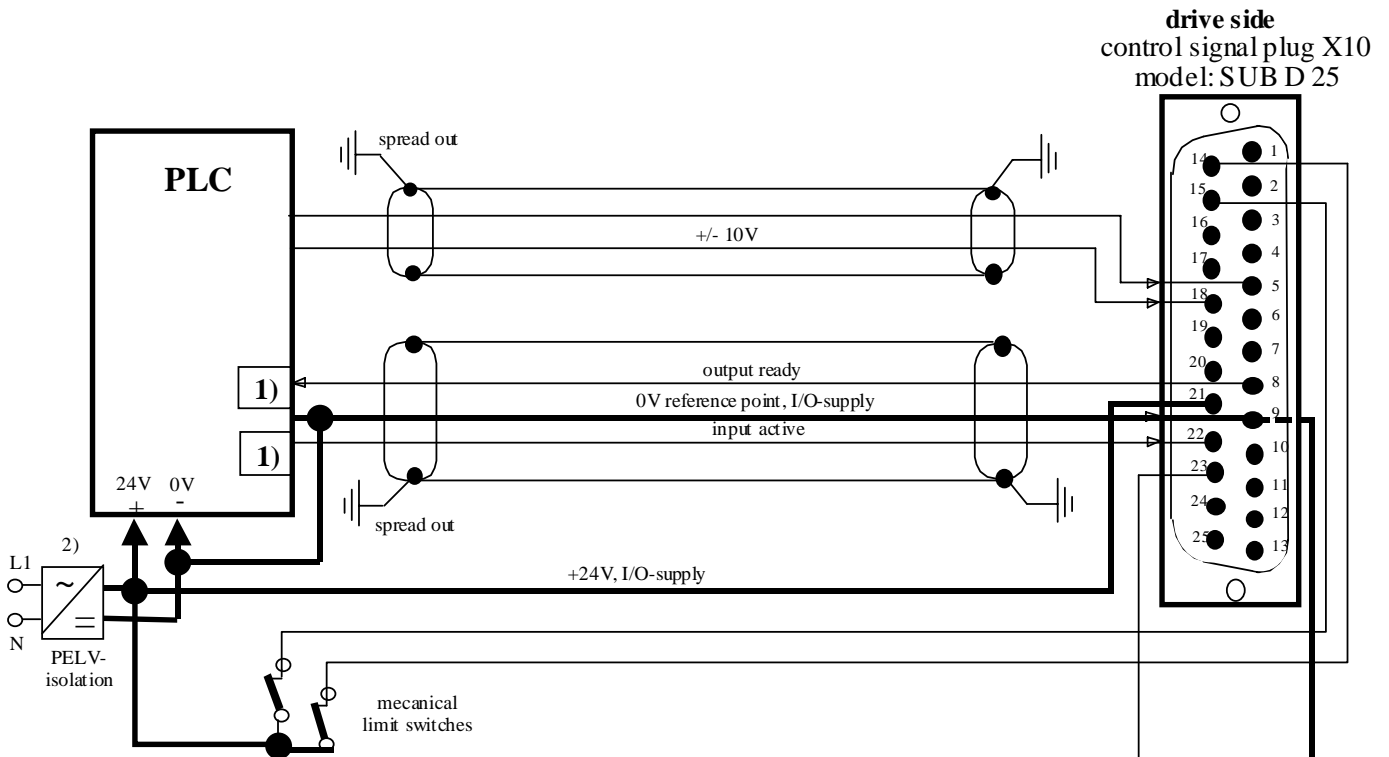

- 1) Security- and supervising logic, to be programmed by user !
- 2) **IMPORTANT:**
The power-supply for the motor-brake has to be adapted to the type of brake.
Voltage-Drops caused by long cables also may effect malfunctions of the brake.

Signal Connections

Control Signal Plug X10 - SUB D25 Socket

Inputs / Outputs

Control Signal Plug X10			
PIN X10	function	type	description
1	shield connector		shield
2	configurable (chapter 3)	OPTO	input
3	stabilized auxiliary voltage -12VDC; max. 80 mA		output auxiliary voltage
4	configurable (chapter 3)	OPTO	input
5	reference point to X10.18		analog input 0...+10V Ri = 10 kOhm
6	Current monitor can be scaled in the speed controller menu via JP100 (solder jumper)		MP2 analog output, 0...+10V
7	can be assigned as free and loopable potential of the READY contact		Optional
8	ON: regulator without fault OUT: regulator fault or supply voltage off	Relay	Output fixed: ready
9	Reference point for digital inputs		Reference point for digital inputs
10	Reference potential for analog signals		Ground
11	configurable (chapter 3)	OPTO	Input
12	configurable (chapter 3)	OPTO	Output
13	configurable (chapter 3)	OPTO	Output
14	configurable (chapter 3)	OPTO	Input
15	configurable (chapter 3)	OPTO	Input
16	stabilized auxiliary voltage +12V DC; max 80 mA		output auxiliary voltage
17	actual speed value monitor, scalable		MP1 analog output, 0...+10V
18	nominal speed value; scalable differential referenced to X10.5		Analog input 0...+10V / Ri = 10 kOhm
19	Setting of the current limit can be activated and scaled (0..+10V for 0.. I _{max})		analog input 0..+10V Ri = 10 kOhm
20	configurable (chapter 3)	OPTO	Output
21	Nominal: 24V DC		Supply for outputs
22	H = output stage is active L = output stage inactive	OPTO	input fixed: active
23	configurable (chapter 3)	Relay	output
24	configurable (chapter 3)	OPTO	input
25	configurable (chapter 3)	OPTO	input

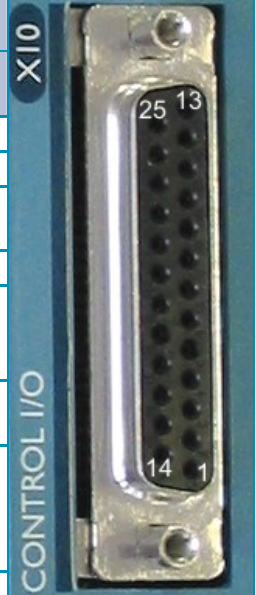

Data of the digital inputs and outputs **see** chapter 11 General technical data

Reference to Pin 22 & Pin 23: With controllers with option module SBT, kindly note the extended functions of these signals (see documentation 07-02-10-02-E-Vxxxx).

2.4 Feedback Sensor X30

The Feedback system generates a digital value, representing the rotor position

Derived from this value:

- commutation according to pole pair number
- actual speed value
- position value for position control

2.4.1 Function module X300

The connector X30 is directly related to the function module X300. This plug-in module (**see** chapter 1.4.3.1) determines the type of usable Feedback system. Thus the 637f drive system gets flexibility and is adaptable to future requirements.

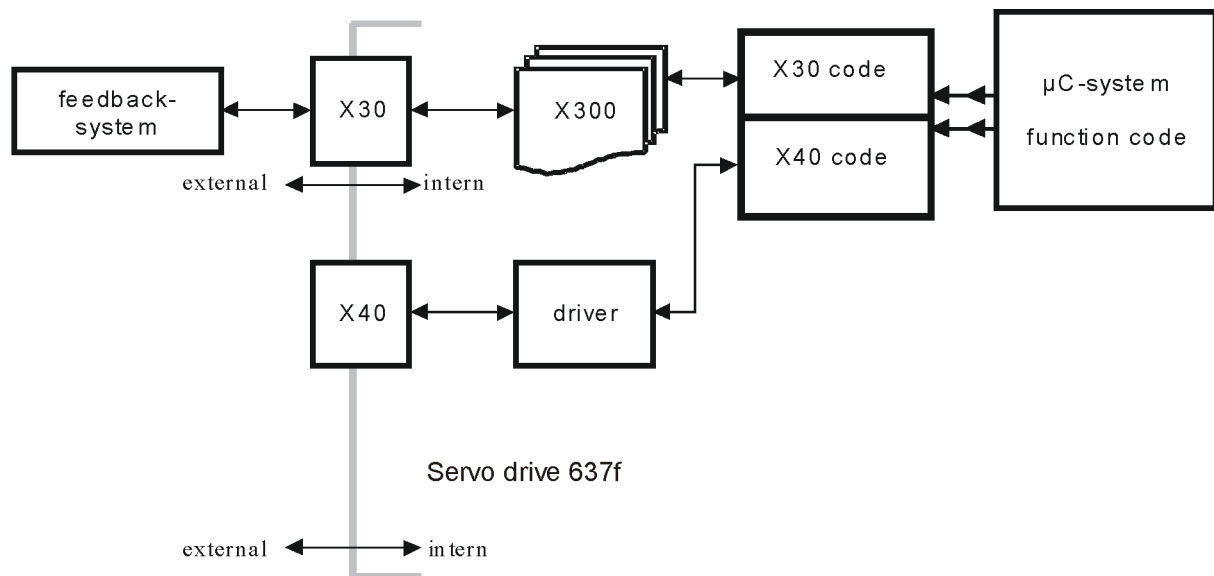

Types X300	Description
X300_RD2	Standard Resolver
X300_HF2	Option HIPERFACE®
X300_SC2	Option Sinus/Cosinus
Further types on request	

Plug and Play

The 637f identifies the type of the module X300.
 The EASYRIDER® Windows – Software loads the correct function code.
 You follow the instructions in the EASYRIDER® Windows – Software.

At function module RD2 the function code is already installed (factory default).

Note:

With application of the function module X300_HF2 (HIPERFACE®) please observe documentation 07-02-09-02-E-Vxxxx.

Feedback Sensor X30

2.4.2 Feedback Sensor Connection X30 (SUB D 09 Socket)

Pinning of Motor - Feedback - Socket X30 with:

Resolver Module X300_RD2 (Standard Module)

Module: X300_RD2	
PIN X30	Function
1	shield
2	PTC optional
3	cos +
4	sin +
5	carrier +
6	PTC optional
7	cos -
8	sin -
9	carrier -



The image shows a close-up of the X30 connector on the X300_RD2 module. The connector is a 9-pin D-sub socket. The pins are numbered 1 through 9. The label 'M.-FEEDBACK X30' is visible on the left side of the connector. The pinout is as follows: 1: shield, 2: PTC optional, 3: cos +, 4: sin +, 5: carrier +, 6: PTC optional, 7: cos -, 8: sin -, 9: carrier -.

HIPERFACE® - Module X300_HF2

Module: X300_HF2	
PIN X30	Function
1	GND
2	10 VDC
3	cos +
4	sin +
5	data -
6	-
7	ref cos
8	ref sin
9	data +



The image shows a close-up of the X30 connector on the X300_HF2 module. The connector is a 9-pin D-sub socket. The pins are numbered 1 through 9. The label 'M.-FEEDBACK X30' is visible on the left side of the connector. The pinout is as follows: 1: GND, 2: 10 VDC, 3: cos +, 4: sin +, 5: data -, 6: -, 7: ref cos, 8: ref sin, 9: data +.

Sinus / Cosinus - Module X300_SC2

Module: X300_SC2	
PIN X30	Function
1	GND
2	5,5 V
3	cos +
4	sin +
5	zero pulse +
6	-
7	ref cos
8	ref sin
9	zero pulse -



The image shows a close-up of the X30 connector on the X300_SC2 module. The connector is a 9-pin D-sub socket. The pins are numbered 1 through 9. The label 'M.-FEEDBACK X30' is visible on the left side of the connector. The pinout is as follows: 1: GND, 2: 5,5 V, 3: cos +, 4: sin +, 5: zero pulse +, 6: -, 7: ref cos, 8: ref sin, 9: zero pulse -.

2.5 Multi-function X40

Description of the X40:

Via a programmable I/O processor, the X40 connection can be configured differently.

EASYSRIDER® Windows - Software

Standard functions:

- Incremental output
- Incremental input
- Stepper motor - pulse inputs
- SSI interface

The unobstructed configurability provides ideal conditions for synchronous applications.

General data	X40
plug type:	SUB D 09 male plug
maximum input or output frequency:	200 kHz
maximum cable length connected to galvanical insulated terminals (Encoder, controls)	25 m; for extended distances please contact our engineer
maximum cable length connected to ground-related terminals (other drives, controls)	2 m, take care for good common grounding !
maximum number of signal inputs to one as incremental-output configured device	8
output signals:	driver model MAX483 or compatible, RS422
differential logic level:	L ≤ 0,5V H ≥ 2,5V
nominal range:	0,0 ... 5,0V 150mA max.
input signals:	receiver model MAX483 or compatible, RS422
differential input level:	diff min = 0,2V
nominal signal difference:	1,0V
current consumption:	1...4 mA (depending on frequency)

Notice:

Master / Slave operation

1 Master, maximum 8 Slaves

Condition: Devices directly side by side !

Multi-function X40

2.5.1 Incremental Output

EASYRIDER® Windows - Software X40 **Mode = 0**

Incremental encoder simulation for processing in positioning modules

Standard: 1024 increments

pulse duty cycle

further selectable pulse numbers: 2048, 512, 256, 128, 64, 4096

Inr. I/O X40		
PIN X40	Function	Designation
1	Channel B	B
2	Channel B inverted	/B
3	Shield connector	Shield
4	Channel A	A
5	Channel A inverted	/A
6	Reference *	GND
7	Channel Z inverted zero impulse	/Z
8	Channel Z, zero impulse	Z
9	Supply voltage output max. 150 mA	+ 5 VDC



Design Rule:

The input frequency range of the connected control must meet at least the value of pulse output frequency on X40.

n = max. speed (rpm)

x = increments e.g. 1024

f = output frequency at X40.1,2,4,5

$$\text{Formula: } f = \frac{1,2 * (n * x)}{60} = [\text{Hz}]$$

Example: n = 4000 1/min

$$f = \frac{1,2 * (4000 * 1024)}{60} = 81920 \text{ Hz}$$

2.5.2 Incremental-Input

EASYRIDER® Windows - Software X40 **Mode = 1**

Parameter range of the input signals: 10...1000000 increments

Figure:

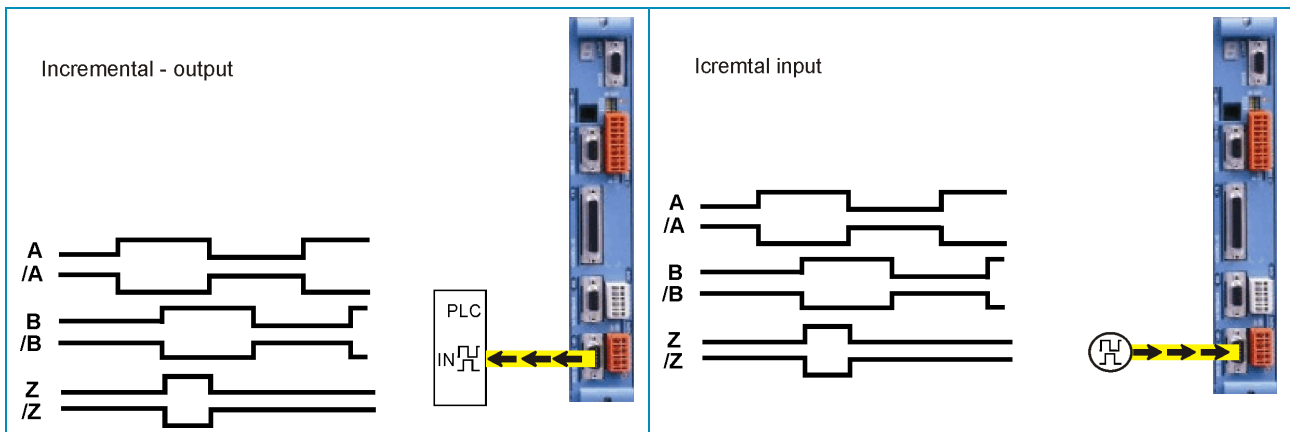

Note:

The operation of incremental encoders via long cables may cause a voltage drop of the encoder power supply. We recommend the use of a separate voltage supply if necessary.

Multi-function X40

2.5.3 Stepper Motor Input

pulse / direction

EASYRIDER® Windows - Software X40 **Mode = 2**

Inr. I/O X40		
PIN X40	Function	Designation
1	Output: Drive active inverted	/READY
2	Output: Drive active	READY
3	Shield connector	Schild
4	Pulse inverted	/P
5	Pulse	P
6	Reference potential (generally to connect)	GND
7	Direction inverted	/R
8	Direction	R
9	Supply voltage output max. 150 mA	+5 VDC



2.5.4 Stepper Motor Input

pulse positive / negative

EASYRIDER® Windows - Software X40 **Mode = 3**

Figure: Puls / Richtung

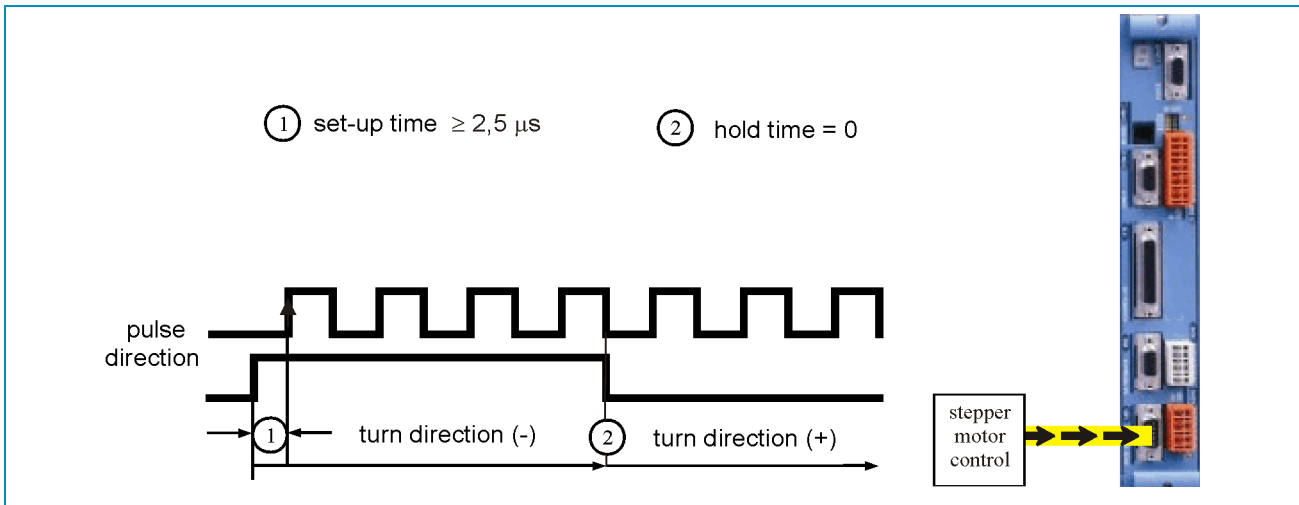
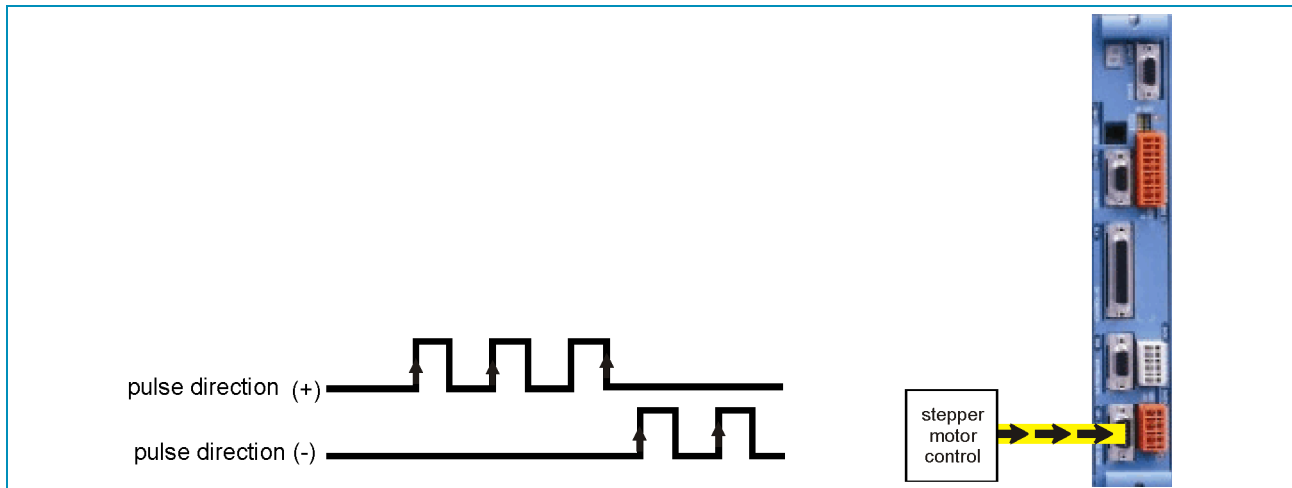

Figure: Puls positiv / negativ



Multi-function X40

2.5.5 SSI Encoder Interface

EASYRIDER® Windows - Software X40 Mode = SSI_13 bit Singleturn

EASYRIDER® Windows - Software X40 Mode = SSI_14 bit Singleturn

EASYRIDER® Windows - Software X40 Mode = SSI_25 bit Multiturn

(13 bit Single- / 12 bit Multiturn)

EASYRIDER® Windows - Software X40 Mode = SSI_26 bit Multiturn

(14 bit Single- / 12 bit Multiturn)

Inr. I/O X40		
PIN X40	Function	Designation
1	Serial data from SSI encoder, GRAY code up to 26 bit inverted	/DATA
2	Serial data from SSI encoder, GRAY code up to 26 bit	DATA
3	Shield connector	Schirm
4	Clock output, inverted Standard frequency: 179 kHz	/TAKT
5	Clock output Standard frequency: 179 kHz	TAKT
6	Reference potential	GND
7	do not connect	
8	do not connect	
9	Supply voltage output max. 150 mA If other data required: a) Use of X300 module b) External supply	+5 VDC



TAKT and /TAKT twisted pair
DATA and /DATA twisted pair
Cable screened, screen grounded at both sides,
max. cable length: 200m

Note:

For further information about SSI (Synchronous Serial Interface), please refer to the documentations of appropriate suppliers. (e.g.: Comp. Sick or Hengstler)

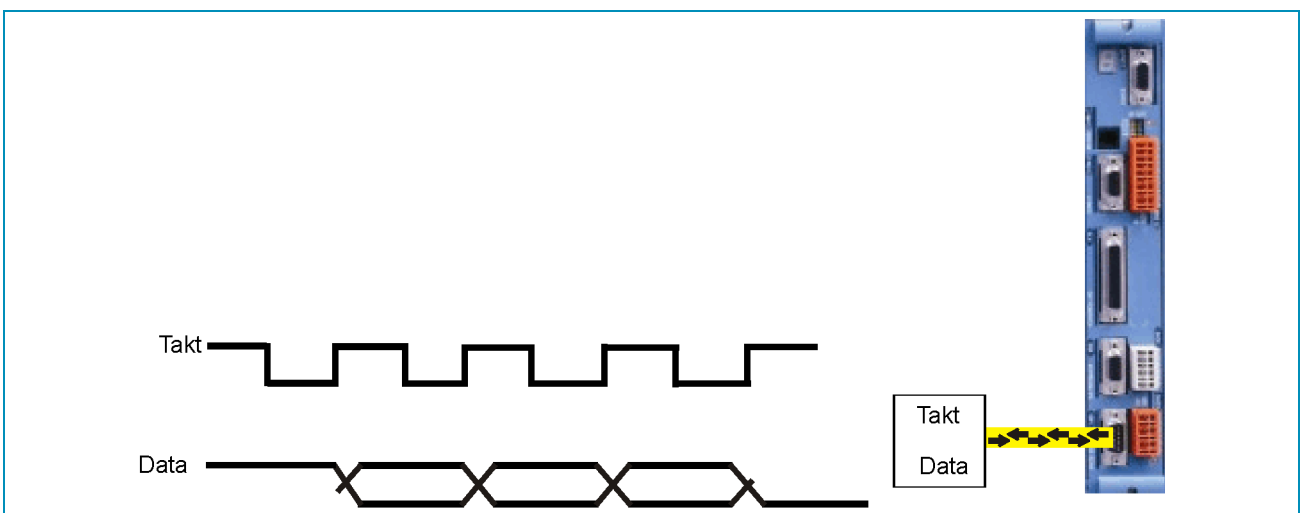



2.6 Digital Interfaces

2.6.1 Service Interface - COM1 (RS232)

Standard

Functions:

- Supporting all diagnosis and setup tasks
- Connection to your PC is made with the SSD Drives communication cable KnPC/D
- Communication is made via the SSD Drives operating program (EASYRIDER® Windows - Software)

Com 1 RS232		Function drive side	RS232 PC side	
	PIN		PIN	
4-pin modular jack				
				
RXD	1	Receive serial data	3	TXD
TXD	2	Transmit serial data	2	RXD
	3	do not connect		
GND	4	GND	5	GND

Type Code	Länge	Beschreibung
Kn PC 637f / 631-03.0	3 m	PC-side, Sub D 09-plug
Kn PC 637f / 631-05.0	5 m	Drive side, 4-pin RJ 10-plug



Note:

The service interface RS232 is not galvanically isolated and should not be planned for this reason as an operating interface ("hard-wiring")!
 The mains connection of the PC must be made closed to the drive, to achieve a common ground.

Digital Interfaces

2.6.2 Fieldbus Interface - **COM2**

Option modules SUB D09 socket

Many different functions can be implemented by **optional** using of the **option modules**. Funktionen realisiert werden. Layout - **see** chapter 1.2.3

Overview:

module designation		interface	galvanic isolation	design	slot
RP 232		RS 232	-	A	A
RP 422	¹⁾	RS 422/485	-	A	A
RP 485	¹⁾	RS 422/485	X	A	A
RP CAN		CAN	X	A	A
RP PDP		Profibus DP	X	B	B
RP SUC		SUCOnet K	X	B	B
RP IBS	²⁾	Interbus S	X	B	B
RP DEV		DeviceNet	X	B	B
RP 2CA	³⁾	CAN1/CAN2	X	B	B or C
RP 2C8	³⁾	CAN1/CAN2	X	B	B or C

¹⁾ full - duplex (4-wire)

²⁾ additional plug Interbus Rem. IN (SUB D)

³⁾ additional plug COM 3 (B)

2.6.2.1 additional In-/Outputs

module designation		inputs	outputs	connection via	design	slot
RP EA5	⁴⁾	5	2	COM2	B	B
RP EAE		14	10	X200	C	C
RP 2C8		4	4	X120 B/C	B	B or C

⁴⁾ no Fieldbus possibility (interface)

Caution!

The connections COM2 or COM3 B/C and X30 are implemented via SUB D09 socket. It is to be guaranteed by the customer that an interchanging is not possible!

The solder ring jumpers JP2.8, 2.3, 2.7, 2.2 must be switched dependent on the option module. See chapter 7.1 (factory-adjusted)

2.6.2.2 Additional CAN-BUS2 Interface

(Use in combination with other Fieldbus)

modul designation		interface	galvanic isolation	design	slot
RP 2CA		CAN2	X	C	C
RP 2C8	³⁾	CAN2	X	C	C

³⁾ additional plug COM 3 (B)

Digital Interfaces

2.6.2.3 Module Designs

Design A

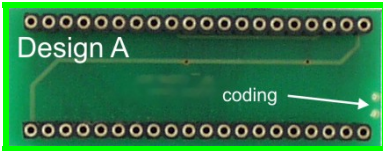

Design B

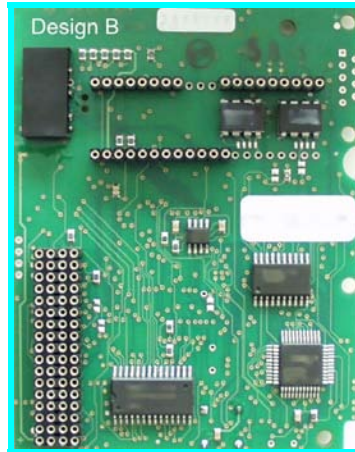

Design C



2.6.2.4 Pin assignment for RS232 with option module RP 232

Pin	assignment as RS232
1	-
2	RXD
3	TXD
4	-
5	GND
6	-
7	-
8	-
9	-

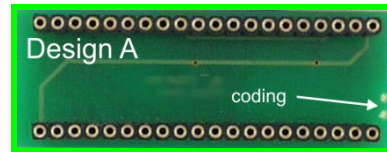

2.6.2.5 Pin assignment for RS422/485 with option module RP 422, without galvanic isolation with option module RP 485, with galvanic isolation

Pin	assignment as RS422/485
1	-
2	-
3	-
4	Data In
5	GND
6	Data In inverted
7	Data Out inverted
8	Data Out
9	-

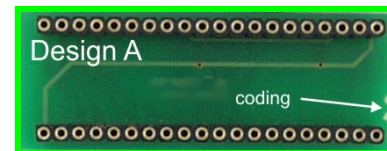

Parallel wiring up to 16 devices

Digital Interfaces

2.6.2.6 Pin Assignment for CAN/DeviceNet

with option module **RP CAN / RP DEV / RP 2CA / RP 2C8**, with galvanic isolation

Pin	description	designation
1	-	-
2	CAN_L bus line (dominant low)	CAN_L
3	Ground	GND
4	-	-
5	-	-
6	Optional ground	GND
7	CAN_H bus line (dominant high)	CAN_H
8	-	-
9	-	-

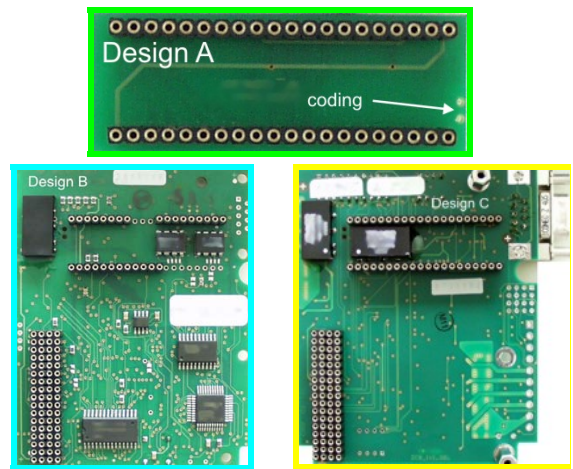

2.6.2.7 Pin assignment for Profibus DP

with option module **RP PDP**, with galvanic isolation

Pin	description	designation
1	-	-
2	-	-
3	Line B	B
4	Request to send	RTS
5	Ground	GND
6	Potential +5V	+5V
7	-	-
8	Line A	A
9	-	-

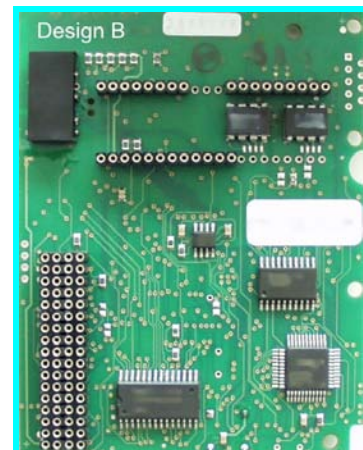

2.6.2.8 Pin assignment for SUCOnet K

with option module **RP SUC**, with galvanic isolation

Pin	description	designation
1	-	-
2	-	-
3	Data line +	TA/RA
4	-	-
5	Signal ground	SGND
6	-	-
7	Data line -	TB/RB
8	-	-
9	-	-

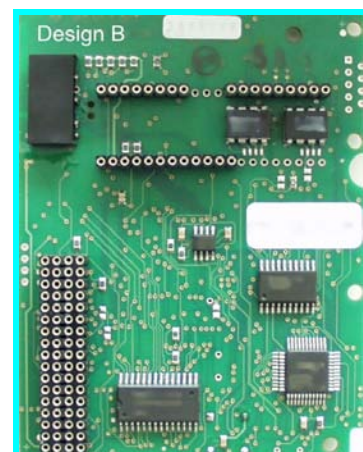

Digital Interfaces

2.6.2.9 Pin assignment for Interbus S with option module RP IBS, with galvanic isolation

Remote OUT (COM2)
Remote OUT (SUB D09 socket)

PIN Com 2	description	designation
1	Data line OUT forward (error voltage A)	DO2
2	Data line IN backward (error voltage A)	DI2
3	Reference potential	GND I
4	-	-
5	VCCI	+5V
6	Data line OUT forward (error voltage B)	/DO2
7	Data line IN backward (error voltage B)	/DI2
8	-	-
9	Reporting input *	RBST

* to forward Interbus-S interface

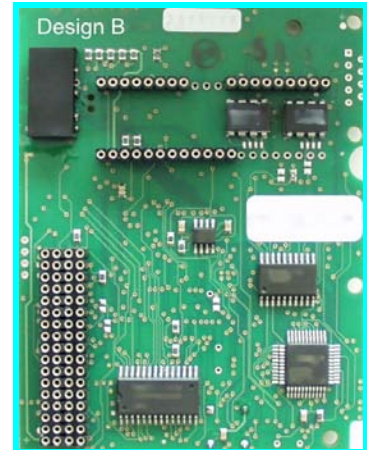

Remote IN (COM3 B)
Remote IN (SUB D09 plug)
≅ additional plug

PIN Remote IN	description	designation
1	Data line IN forward (error voltage A)	DO1
2	Data line OUT backward (error voltage A)	DI1
3	Reference potential	GND I
4	-	-
5	-	-
6	Data line IN forward (error voltage B)	/DO1
7	Data line OUT backward (error voltage B)	/DI1
8	-	-
9	-	-

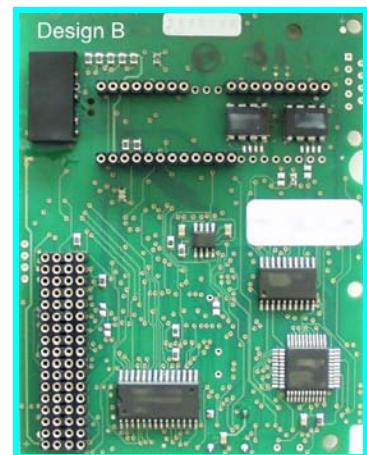

Attention: specific front panel is required !

Digital Interfaces

2.6.2.10 Pin assignment for I/O interface
with option module RP EA5, with galvanic isolation

Digitale I/O Option
COM2 SUB D09 socket

PIN Com 2	designation	comment	status
1	BIAS input 101	standard	input
2	BIAS input 102	standard	input
3	BIAS input 107	standard	input
4	BIAS input 108	standard	input
5	0VSPS	ground reference 0VSPS	B
6	BIAS input 106	standard	input
7	BIAS output 109	standard	output
8	BIAS output 110	standard	A
9	+24VSPS	ext. +24V feed-in	UB

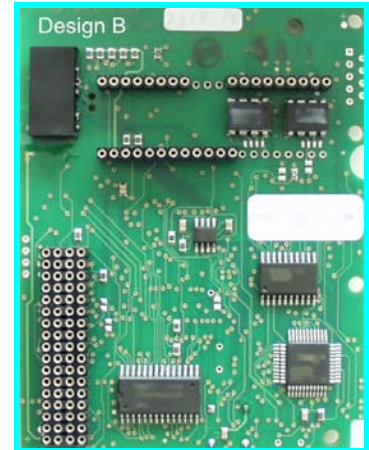

Notice !!

The inputs with the internal number 107 and 108 must be connected to the pins with number 3 and 4.
The outputs with the internal number 109 and 110 must be connected to the pins with number 7 and 8

Digital Interfaces

2.6.2.11 Pin assignment for I/O interface with option module RP EAE, with galvanic isolation

Digitale I/O Option
X200 SUB D26 High Density socket

PIN X200	designation	comment	status
1	Bias input 201	standard	input
2	Bias input 202	standard	input
3	Bias input 203	standard	input
4	Bias input 204	standard	input
5	Bias input 205	standard	input
6	Bias input 206	standard	input
7	Bias input 207	standard	input
8	Bias input 208	standard	input
9	Bias output 209	standard	output
10	Bias output 210	standard	output
11	Bias input 211	standard	input
12	Bias input 212	standard	input
13	Bias input 213	standard	input
14	Bias input 214	standard	input
15	Bias input 215	standard	input
16	Bias input 216	standard	input
17	Bias output 217	standard	output
18	Bias output 218	standard	output
19	Bias output 219	standard	output
20	Bias output 220	standard	output
21	Bias output 221	standard	output
22	Bias output 222	standard	output
23	Bias output 223	standard	output
24	Bias output 224	standard	output
25	+24 V SPS	Ext. +24 V feed-in	Ub
26	0 V SPS	Ground reference 0 V SPS	B



Digital Interfaces

2.6.2.12 Pin assignment for I/O interface with option module RP 2C8, with galvanic isolation

Digitale I/O Option

X120B or **X120C** Cage – Clamp terminal 10pole..
(min./max. cable cross-section: 0,08mm² / 1,5mm²)

PIN X120	designation	comment		status
		Function 0	Function 1	
1	Input 121	BIAS	Reset drive fault	Input
2	Input 122	BIAS	Limit switch +	Input
3	Input 123	BIAS	Limit switch -	Input
4	Input 124	BIAS	Reference switch	Input
5	Output 125	BIAS	Cam 1	Output
6	Output 126	BIAS	Cam 2	Output
7	Output 127	BIAS	Cam 3	Output
8	Output 128	BIAS	Cam 4	Output
9	+24 V SPS	Ext. +24 V feed-in		Ub
10	0 V SPS	Ground reference 0 V SPS		B

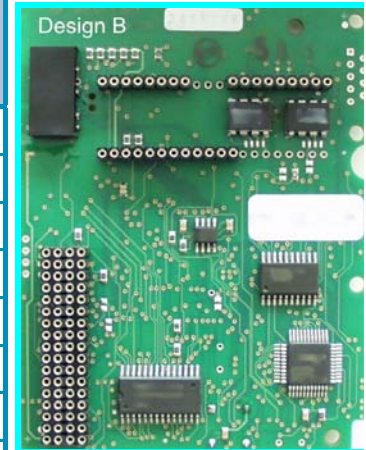

Signal statuses of the I/O are indicated in each case by a 2mm LED at the front plate.

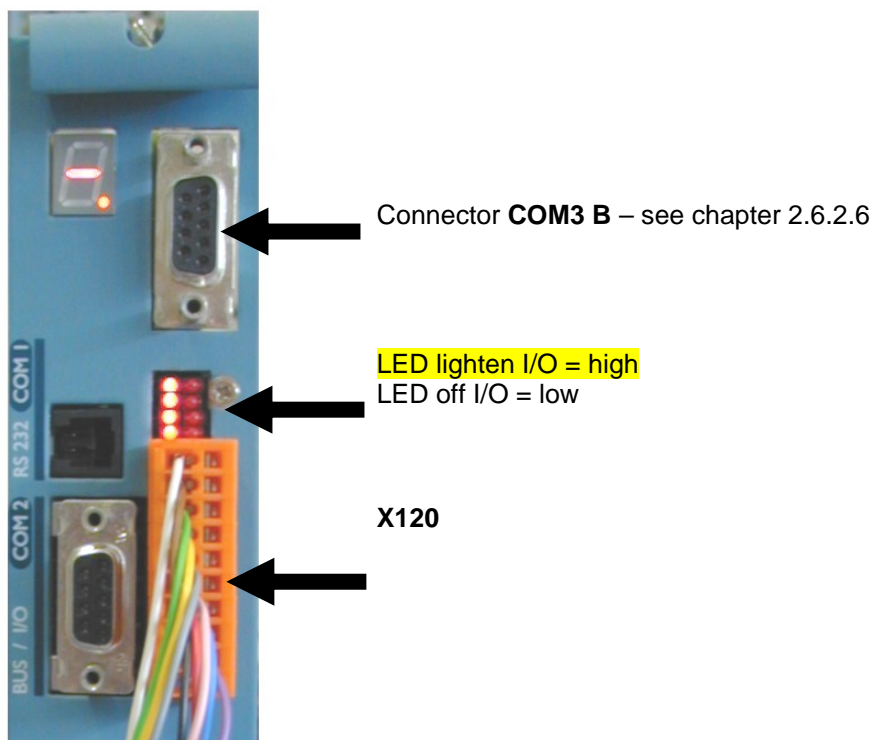

Digital Interfaces

2.6.2.12.1 DIL – switch position for module RP2CA and RP 2C8, with galvanic separation

DIL – switch position **CAN**

Default = all off

note number
0 - 127

2^0 ----- 2^6	2^0 ----- 2^2	2^2 2^1 2^0			
		0 0 0	0	20 kBaud	
		0 0 1	1	50 kBaud	
		0 1 0	2	100 kBaud	
		0 1 1	3	125 kBaud	
		1 0 0	4	250 kBaud	
		1 0 1	5	500 kBaud	
		1 1 0	6	800 kBaud	
		1 1 1	7	1000 kBaud (1MBaud)	

Example: node number 5; 1MBaud

DIL – switch position **bus termination**

COM2

COM3

Default

COM2/COM3

2.7 Option module RP SBT

2.7.1 Safe Stop

Connector assignment X290:

PIN X290	designation	comment	status
1	Input Active	¹⁾ OPTO	Input
2	Reference point Input Active	OPTO	Input
3	Starting lockout deactivated	Relais	Input
4	Reference point Starting lockout	Relais	Input
5	Checkback contact	Free contact	Break contact
6	Checkback contact	Free contact	Break contact



Hinweis:

- ¹⁾ With employment the option module RP SBT changes the function "AKTIV" from the connecting plug X10.22 after X290.1! The input X10.22 can be used then as free programmable input (BIAS).

Use of the function Safe Stop

The option RP_SBT of the drive controller 637fx-x.S5 supports the safety function "Safe Stop", protection against unexpected starting, according to the requirements of the EN954-1 "Category 3" and EN1037.

The stop of the machine must be caused and guaranteed before by the external machine control.

This applies in particular to vertical axes without selflocking mechanics or counterweight.

If an error arises in the drive system during the active brake phase, the axis can coast down uncontrolled or even accelerate actively.

In order to use the Starting lockout function intended, it is to be looped into the net contactor circle or emergency stop circle with the obligation-led reporting contact X290.5/6. With not plausible functioning of the Starting lockout relay, related to the operating mode of the machine, a galvanic separation of the drive concerned from the net must take place. The Starting lockout and the associated mode may be used again only after error correction.

Due to a danger analysis / view of risk (to be accomplished according to machine guideline 89/392/EWG and/or EN 292; EN 954 and EN 1050) the machine manufacturer must project the safety circuit of its machine types for the **entire machine** including all integrated components (also the electric drives).

Block diagram:

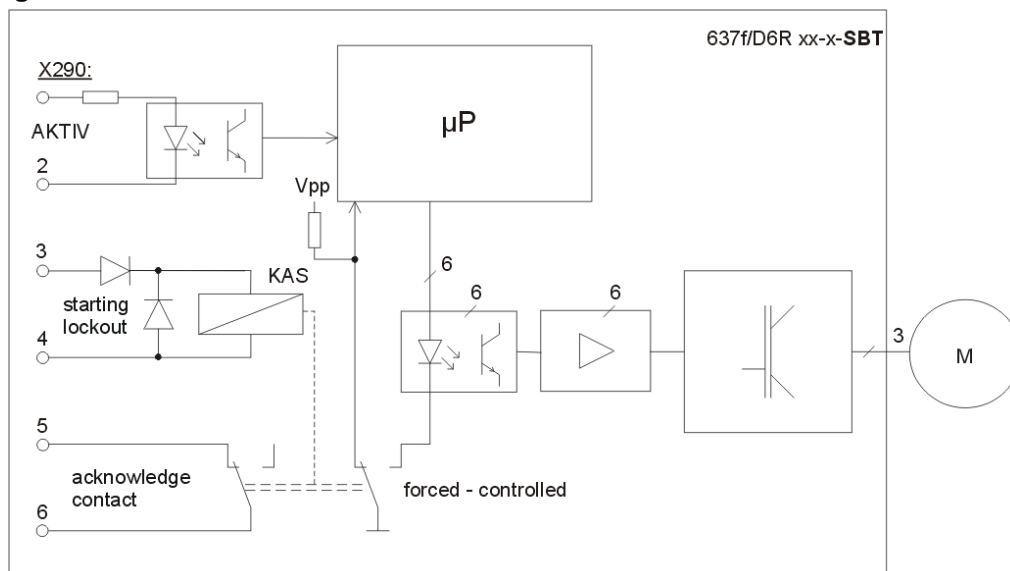

Option module RP SBT

2.7.2 Brake control and PTC evaluation

Connector assignment X280

PIN X280	designation	status
1	Supply for brake output and PTC evaluation	Input
2	Reference point for supply	Input
3	Reference point for Brake control	Output
4	Brake control Active ok.	Relais output
5	PTC	Input
6	PTC	Input

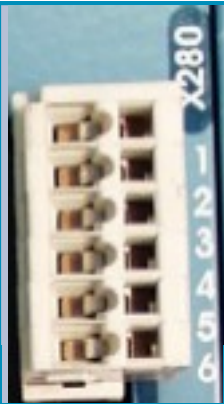

Use of the Brake control

The relay output X290.3 serves for the control of holding brakes. This output is functionally identical to the output X10.23.

The output at X290.3 has the following advantages over X10.23:

The isolation relay contact → control electronics corresponds to the basis isolation. I.e. also brake installations (which correspond to the basis isolation) without interface relays, while maintaining the PELV isolation (double) of the drive controller are operated (see X10 connection example chapter 2.3.2)

The brake control possesses an active clamping of over voltages between the two brake connections.

Stronger dimensioning of the brake contact.

Use of the PTC evaluation

The PTC connection serves for the monitoring of the engine temperature. In its function mode it is identical to the port X30.2/6. The following advantage exists over X30.2/6 :

The isolation evaluation circle → control electronics corresponds to the basis isolation. I.e. also PTC thermistors (which correspond to the basis isolation) can be evaluated, without waiving the safe separation to the control electronics.

Block diagram / Connector assignment Circuit diagram

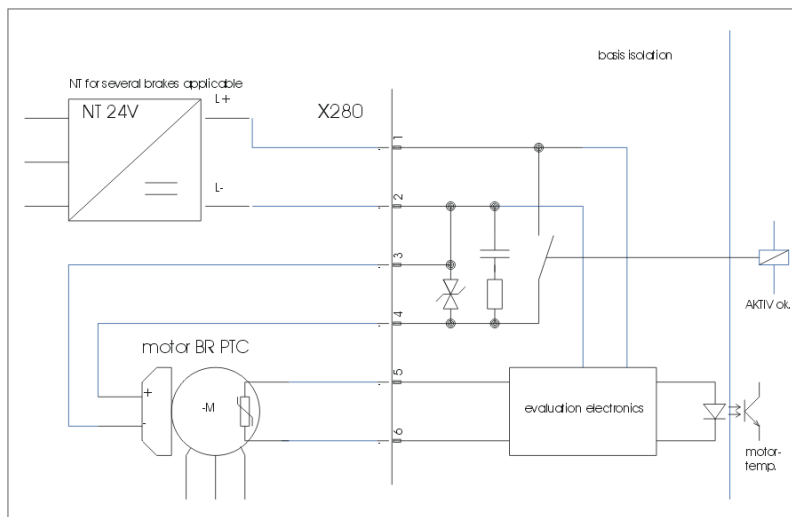

Further details see product manual **07-02-10-02-E-V..**

The preselection of the device functions are carried out by choosing the operating modes 0...5 according to the following table, see chapter 3.1, (EASYSRIDER® Windows - Software).

Each operating mode allows the assignment of different in- and output functions (F0..F6).

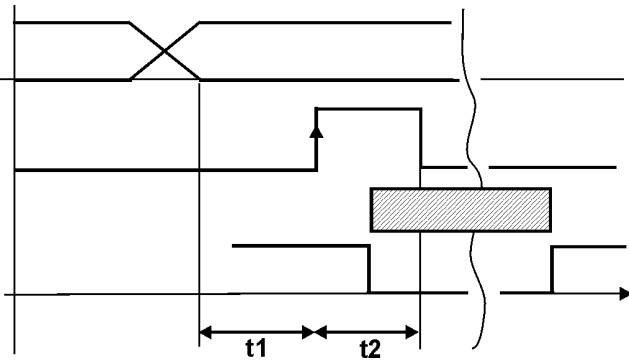
Operating mode	Reference-source	Hints for selecting the operating
0 1 2	analog (X10.5/18)	switchable the operating modes 1 and 2 by input X10.24 speed control analog torque controller analog
3	analog (X10.5/18) / digital	simple applications with requirement of switching between position and speed control position controller (input X10.24) handling like operating mode 4
4	digital or analog in acc. to parameter set	general position-controlled systems. Up to 10 positions can be stored under identifier-numbers and activated like shown.
	pos. selection (Nr. 0...9) function F2 data 2 ⁰ ...2 ⁴ input start function F2 X10.2 axis move to selected position-number output position reached function F0 X10.12 t1= 2ms minimum t2= 2ms minimum	
5	digital or analog in acc. to programming or via digital communication (e.g. fieldbus)	simple to complex systems using instructions BIAS (up to 1500 command blocks) PLC - functions for further information: see chapter 13.1 and 13.2

3.1 Operating modes and pin functions

Available pins number	operating modes					
	0 torque / speed-control	1 speed control	2 torque control	3 position / speed-control	4 position control	5 position control + BIAS functions
input X10.14	F0, F1	F0, F1	F0, F1	F0, F1, F2, F3	F0, F1, F2, F3, F6	F0, F1, F2, F6
input X10.15	F0, F1	F0, F1	F0, F1	F0, F1, F2, F3	F0, F1, F2, F3, F6	F0, F1, F2, F6
input X10.4	---	---	---	---	F2, F6	F0, F2, F3, F6
input X10.25	---	---	---	---	F2, F6	F0, F2, F3, F6
input X10.11	F1	F1	F1	F1	F1, F2, F6	F0, F1, F2, F3, F6
input X10.24	F0 L = torque- H = speed control	---	---	F0 L = torque- H = speed control	F1, F2, F6	F1, F2, F3, F6
input X10.2	---	---	---	---	F0	F2, F3

output X10.12	F0, F2, F5	F0, F2, F5	F0, F2, F5	F0, F1, F3, F5	F0, F1, F3, F5	F0, F1, F2, F3, F4, F5
output X10.13	F0, F2, F5	F0, F2, F5	F0, F2, F5	F0, F1, F3, F5	F0, F1, F3, F5	F0, F1, F2, F3, F4, F5
output X10.20	F0, F2, F5	F0, F2, F5	F0, F2, F5	F0, F1, F3, F5	F0, F1, F3, F5	F0, F1, F2, F3, F4, F5
output X10.23	F0, F2, F5	F0, F2, F5	F0, F2, F5	F0, F1, F3, F5	F0, F1, F3, F5	F0, F1, F2, F3, F4, F5

The assignment of the functions F0..F5 is listed in the following table

3.2 Configurable pin-functions (depending on the operating mode)

input Nr.	Input functions (depending on the operating modes)						
	function F0	function F1	function F2	function F3	function F4	function F5	function F6 ²⁾
input X10.14	<input checked="" type="checkbox"/>	3) limit switch +	1) set selection data 2 ⁰	move manually +	<input checked="" type="checkbox"/>	<input checked="" type="checkbox"/>	CAN Node no. 2 ⁰
input X10.15	<input checked="" type="checkbox"/>	3) limit switch -	1) set selection data 2 ^a	move manually -	<input checked="" type="checkbox"/>	<input checked="" type="checkbox"/>	CAN Node no. 2 ^a
input X10.4	latch input 1 <input checked="" type="checkbox"/>	extended latch	1) set selection data 2 ^b	<input checked="" type="checkbox"/>	<input checked="" type="checkbox"/>	<input checked="" type="checkbox"/>	CAN Node no. 2 ^b
input X10.25	latch input 2 <input checked="" type="checkbox"/>	<input checked="" type="checkbox"/>	1) set selection data 2 ^c	<input checked="" type="checkbox"/>	<input checked="" type="checkbox"/>	<input checked="" type="checkbox"/>	CAN Node no. 2 ^c
input X10.11	start (slope 0-->1) for BIAS - move commands	3) regulator trouble reset	1) set selection data 2 ^d	<input checked="" type="checkbox"/>	<input checked="" type="checkbox"/>	<input checked="" type="checkbox"/>	CAN Node no. 2 ^d
input X10.24	operating mode selection (0) – 1 or 2 (3) – 1 or 4	3) reference sensor	1) set selection data 2 ^{max}	<input checked="" type="checkbox"/>	<input checked="" type="checkbox"/>	<input checked="" type="checkbox"/>	CAN Node no. 2 ^{max}
input X10.2	start (slope 0-->1) with position set selection in position control (4)	<input checked="" type="checkbox"/>	strobe (slope 0-->1) for BIAS-set selection	<input checked="" type="checkbox"/>	<input checked="" type="checkbox"/>	<input checked="" type="checkbox"/>	<input checked="" type="checkbox"/>

output X10.12	position reached	reference output	<input checked="" type="checkbox"/>	tracking window exceeded	synchron-format trigger	non drive trouble	-
output X10.13	temperature monitoring	reference output	<input checked="" type="checkbox"/>	tracking window exceeded	start offset trigger	non regulator trouble	-
output X10.20	warning	reference output	<input checked="" type="checkbox"/>	tracking window exceeded	<input checked="" type="checkbox"/>	non drive trouble	-
output X10.23	active ok (motor brake)	reference output	<input checked="" type="checkbox"/>	tracking window exceeded	<input checked="" type="checkbox"/>	non drive trouble	-

BIAS-function, free programmable.(in operating mode 5) resp. no function in operating mode 0 at 4.

fast input for optimal timing

- 1) With every row (from the top to the bottom) in which the function F2 is assigned to an input, the binary value (2ⁿ) increases by 1. (see example)
Operating mode 4: only permissible set number 0 - 9 !
- 2) only possible with module RP-CAN.
- 3) Is the Option RP 2C8 (chapter. 2.6.2.12) insertion, are the contact function as the same definition on X10-plug invalid (the inputs can freely programmable and use in BIAS program)

3.3 Function diagrams from inputs and outputs

Fault signal / protection function	Protection mode switching off in acc. with EASYRIDER config.- menu	Protection mode limiting acc. with EASYRIDER config. menu
I²t regulator protection output Warning(F0) X10.20 output Ready X10.8 Warning display fault signal display		
I²t motor protection output Warning(F0) X10.20 output Ready X10.8 Warning display fault signal display		
NTC-output stage protection output Warning(F0) X10.20 output Ready X10.8 Warning display fault signal display		
assume motor temperature curve Temp.		
NTC-motor protection output Temp.(F0) X10.13 output Ready X10.8 Warning display fault signal display		
PTC-motor protection output Temp.(F0) X10.13 output Ready X10.8 Warning display fault signal display		<div style="border: 1px solid black; padding: 5px; text-align: center;">no limiting function with PTC</div>
Function Passive -Delay (recommended by use of motor brake) input ACTIVE X10.22 setpoint internally to zero output stage Active output AKTIVE -OK (F0) X10.23 (holding brake)		

Hint: With the assembly of the option module SBT you kindly note the extended functions of the signals (see documentation 07-02-10-02-E..)

4.1 Mounting

SSD Drives digital servo drives may be installed only in a vertical position to guarantee the best air circulation for the cooling ribs of the heat sink. Vertical installation above other drive racks or above other heat producing devices can lead to overheating. In addition the drives are to be operated exclusively in SSD Drives racks or the compact enclosure respectively.

4.2 Control cabinet - mounting

Installation should be carried out only in a control cabinet in which the inside must be free from dust, corrosive fumes, gases and all liquids.

Make absolutely sure that the condensing of evaporating liquids including atmospheric moisture is avoided. Should the digital servo drive be installed in a place where condensation is likely, a suitable anticondensation heater must be installed. The heater must be SWITCHED OFF during normal operation.

Automatic switch off is recommended

SSD Drives-digital servo drives should not be installed in areas which have been classified as dangerous, if they have not been installed in an approved enclosure in accordance with regulations and checked.

Make sure, there is enough cooling and space ! (see sketch)

- only horizontal !
- on the side
no distance is required

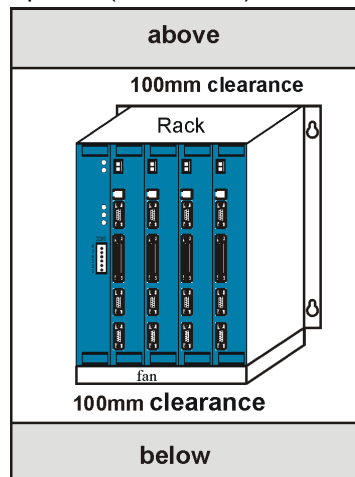

General rule:

It is better to place heat-producing devices low in an enclosure to support internal convection and to spread the heat. If placing such devices up high is unavoidable, enlarging the upper dimensions at the expense of height or installing fans should be considered.

4.3 Cooling

The digital servo drives are protected against damages caused by overheating. There is a thermal sensor installed on the heat sink. When the temperature rises to $>95^{\circ}\text{C}$, the drive is automatically switched off. This setting cannot be changed. Make sure a cabinet of proper size is selected for adequate air circulation

If the device becomes operated in a not ventilated device, the case volume of the specified control cabinet must be calculated in accordance with the following table !

Units	Volume of cabinet
637f/0D6R02...D6R10	0,12 m ³
637f/0D6R16...D6R30	0,25 m ³

For more exact information, please, address to the control-cabinet manufacture

5.1 Safety

The voltages carried by power supply cables, motor cables, connectors, and certain parts of the drive can cause serious electric shocks and even death

5.2 The danger of electric shocks



Caution !

Risk of electrical shock, wait 3 minutes after switching off, for discharging the capacitors.

Disconnect SSD Drives plug-in units from mains before working on them. A period of **three** minutes **must** pass after switching off so that the internal capacitors can discharge completely. Until the discharge time is over, there can be dangerous voltages in the module !

Persons, which monitoring or carrying out electrical installation and maintenance must be adequately qualified and schooled in these activities.

5.3 Danger areas

The use of variable speed drives of all kinds can invalidate the certification for dangerous areas (apparatus group and/or temperature class) of explosion-protected motors. Inspection and certification for the complete installation of servo motors and electronic components **must** be obtained.

5.4 Grounding, safety grounding

The grounding impedance must meet the requirements of local industrial safety regulations and should be inspected and checked at appropriate and regular intervals

5.4.1 Ground connections

It is recommended to attach a ground bus of high conductivity copper as near as possible to the servo-rack or regulator modules in order to minimize the length of the cable connections.

The recommended dimensions are:

Thickness: $d = 5$ to 6 mm

Length (m)	Width (mm)
$< 0,5$	20
$0,5 < 1,0$	40
$1,0 < 1,5$	50

Ways of raised discharge currents $> DC 10mA$ resp. $> AC 3,5mA$ the PE-Bolt of the drive has to be connected to PE using copper-cable minimum $10mm^2$!

5.5 Short-circuit capability and discharge currents

Due to the working-principle of servo drives there may discharge currents to PE exceeding DC $10mA$ resp. AC $3,5mA$.

Suitable for use on a circuit capable of delivery not more than 5000 RMS symmetrical amperes 505V maximum. (Note according to UL508C)

5.6 Fuses, contactors, filters

Compact units	637f/ KD6R 02		KD6R 04		KD6R 06		KD6R 10		KD6R 16		KD6R 22		KD6R 30		
	.S5		.S5		.S5		.S5		.S5		.S5		.S5		
		-3	-7	-3	-7	-3	-7	-3	-7	-7	-7	-7	-7	-7	
Fuses, Contactors	4)														
RCD-switch		not recommended. Required setpoint: 300 mA, no protection against life danger													
mains input currents	[A]	3,5		5		7,5		12		19		26		30	
mains protection	1) Type	T10A		T10A		T10A		T20A		T25A		(T32A) 35A		(T32A) 35A	
protector-switch	2) Type	PKZM0-16		PKZM0-16		PKZM0-16		PKZM0-16		PKZM0-25		PKZ2/ZM32		PKZ2/ZM32	
mains fuse	2) Type	DIL 00M		DIL 00M		DIL 00M		DIL 00M		DIL 0M		DIL 0M		DIL 0M	
Line filters	4)														
general		only for use in earth referenced supplies(TN). Current drain to PE !													
		single-phase													
industrial env. max. motor cable 50m (EN55011 A)	Type	LNF E 1*230/012 up to AC 230V !! + ferrite core						not possible !							
residential env. max. motor cable 20m (EN55011 B)	Type	LNF E 1*230/012 up to AC 230V !! + ferrite core						not possible !							
		3-phasig													
industrial env. max. motor cable 50m (EN55011 A)	Type	LNF B 3*480/008 + ferrite core FR 3				LNF B 3*480/018 + ferrite core FR 6				LNF B 3*480/033 + ferrite core FR 6					
residential env. max motor cable 20m (EN55011 B)	Type	LNF B 3*480/008 + ferrite core FR 3				LNF B 3*480/018 + ferrite core FR 3				LNF B 3*480/033 + ferrite core FR 3					
		3-phasen, max. 3 Units, supplied by a common filter													
industrial env. max. motor cable 20m (EN55011 A)	Type	LNF B 3*480/018; LNF B *480/033 + ferrite core FR other types upon request (according to ref.measurements with 3 units, supplied by common line)													
residential env. max motor cable 20m (EN55011 B)	3) Type	LNF B 3*480/018; LNF B 3*480/033 + ferrite core FR other types upon request (according to ref.measurements with 3 units, supplied by common line)													

Plug-in modules	637f / D6R 02		D6R 04		D6R 06		D6R 10		D6R 16		D6R 22		D6R 30		
	.S5		.S5		.S5		.S5		.S5		.S5		.S5		
		-3	-7	-3	-7	-3	-7	-3	-7	-3	-7	-3	-7	-3	-7
Fuses, contactors, filters	4) 1)														
general		Orientation: Table for compact units and the addition of rated currents of used units on the DC-Bus. Depending on the application, energy sharing effects by DC-link may reduce the required supply current considerable.													
fuses		Rule of the thumb: single-phase operation: 2...3 times of added rated currents Rule of the thumb: 3-phase operation: 1,5...2 times of added rated currents													
peak making currents		Depending on power-supply unit, limiting equipment is required (delay contactor)													
filters		only for use in earth referenced supplies(TN). Current drain to PE !													
filter types		Orientation: Table of compact units. Further types: see separate manual													

- 1) recommended for UL-requirements: Bussmann Type FRS-R, 600V, use only UL-approved fuse-holders !
- 2) recommended, Klöckner Moeller for instance
- 3) Measurement of conducted emissions only
- 4) for applications with continuous load: see notes in chapter 5.7

5.7 Correction of supply current

Attention in case of continuous load:

Due to the capacitive input impedance of DC-Bus, the input current is deformed.

This guides to RMS -values higher than the sinus-based calculated values. Fuses, contactors and line filters have to be selected in respect to this effect.

In typical servo application with Stop/Go-operation (S3-Operation), the rating to nominal data will be sufficient.

In other cases, the value has to be corrected using the following diagram.

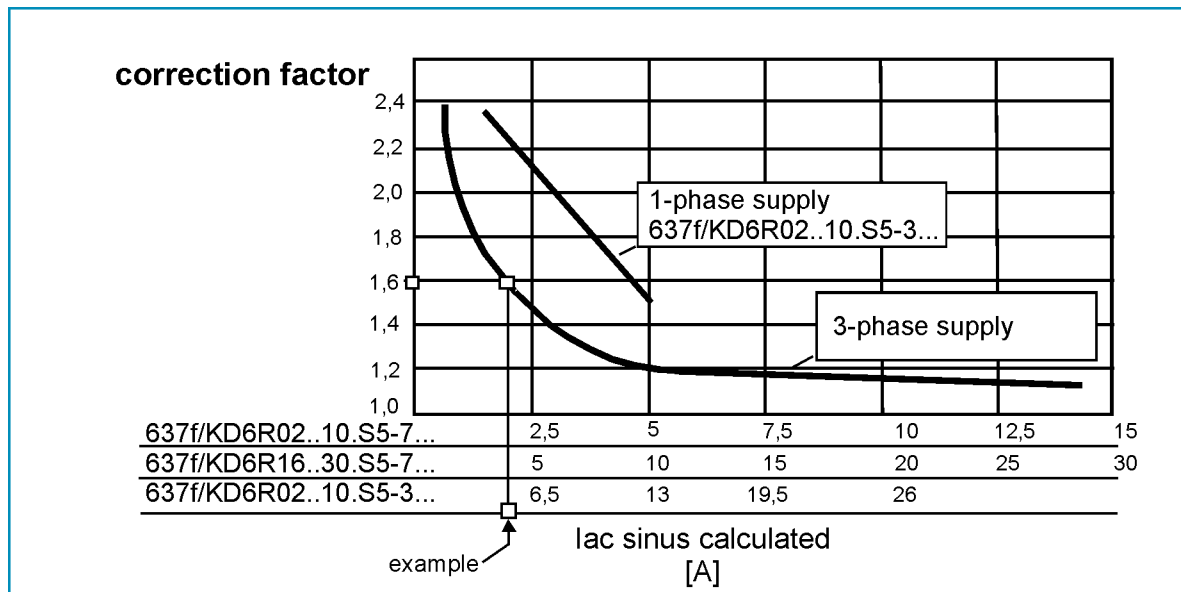

Example:

Drive type 637f/KD6R16.S5-7 is supplied by AC 230V 3-ph.

Output-power: $P_{out} = 200V \times 16A \times 1,73 = 5,54 \text{ kW}$

This output-power must be generated by:

calculated supply-current $I_{ac \text{ sinus}} = 5,54kW / (230V \times 1,73) = 13,9 \text{ A}$

Correction-Factor from diagram: 1,6

RMS. Supply-Current $I_{eff} = I_{ac \text{ sinus}} \times 1,6 = 22,3 \text{ A}$

Result:

All supply-equipment has to be selected in respect to the enhanced current.

5.8 Brake resistor

5.8.1 Selection of the brake resistor

The energy of a moving system flows back to the Drive. The DC-Bus capacitors are able to take a small value. The rest has to be converted to heat by a resistor.

Switching of this brake resistor depends on the DC-Bus voltage.

The load of the resistor is simulated and supervised electronically

(EASYSRIDER® Windows - Software). Peak power (P_{max}) and continuous power (P_d) ratings have to be sufficient to meet the requirements of the application.

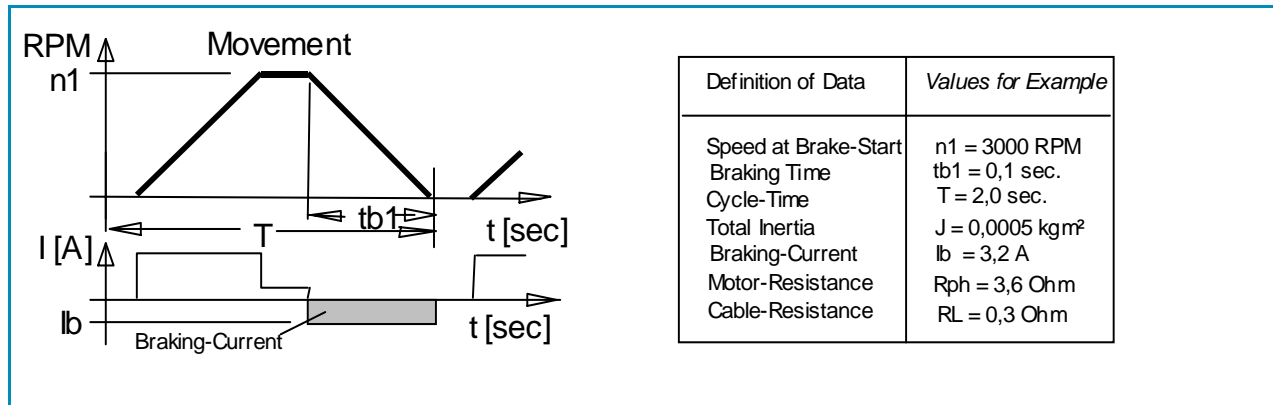

Calculation	
Step 1	example
Calculation of brake-power (Approximation. Capacitor-load, friction-and drive-losses neglected)	
Power of motion: $P_{kin} = 0,0055 * J * n1^2 / tb1 \text{ [W]}$	$P_{kin} = 0,0055 * 0,0005 * 3000^2 / 0,1$ $P_{kin} = 247 \text{ W}$
Motor-losses: $P_{vmot} = lb^2 * (Ri + RL) \text{ [W]}$	$P_{vmot} = 3,2^2 * (3,6 + 0,3)$ $P_{vmot} = 40 \text{ W}$
Cont. Power: $P_d = 0,9 * (P_{kin} - P_{vmot}) * tb1 / T \text{ [W]}$	$P_d = 0,9 * (247 - 40) * 0,1 / 2$ $P_d = 9,3 \text{ W}$
Peak-Power: $P_{max} = (1,8 * P_{kin}) - P_{vmot} \text{ [W]}$	$P_{max} = (1,8 * 247) - 40$ $P_{max} = 405 \text{ W}$
used units: J total inertia [kgm ²] n1 speed at Brake-Start [RPM] tb1 braking time [Sec] T cykle time [Sec] lb brake-current [A] Rph resistance of motor (between terminals) [Ω] RL line resistance of motor cable [Ω]	

Brake resistor selection of the brake resistor

<p>Step 2 Internal / external Brake-resistor required ? see data in chapter 1.3.3 / 1.3.4</p> <p>In case of insufficient capability or not included internal Brake-Resistor, a type may be selected from the following list</p> <p>External and internal Brake-Resistors will be switched in parallel. The internal and external performance-Data may be added in this case.</p>	<p>Example-Drive type 637f/K D6R04-7</p> <p>acc. to data in 1.3.3: internal resistor: Cont. Power Pd = 30W Peak Power Pmax = 1700W Required: Pd = 9,3W Pmax = 405W Result: The internal capability is sufficient</p>																																													
<table border="1"> <thead> <tr> <th>selection guide external brakeresistors</th> <th>drive-type</th> <th>Ub-setpoint</th> <th>Pmax ext[W]</th> <th>Pd ext [W]</th> <th>Rb ext [Ohm]</th> <th>SSD Drives - type</th> </tr> </thead> <tbody> <tr> <td rowspan="3">..D6R..S5-3</td> <td>DC 375V</td> <td></td> <td>4260</td> <td>100</td> <td>33</td> <td>B100/33-3</td> </tr> <tr> <td>DC 375V</td> <td></td> <td>17150</td> <td>300</td> <td>8,2</td> <td>B300/8,2-3</td> </tr> <tr> <td>DC 375V</td> <td></td> <td>17800</td> <td>560</td> <td>7,9</td> <td>B560/7,9-3</td> </tr> <tr> <td rowspan="3">..D6R..S5-7</td> <td>DC 730V</td> <td></td> <td>5330</td> <td>100</td> <td>100</td> <td>B100/100-6</td> </tr> <tr> <td>DC 730V</td> <td></td> <td>16150</td> <td>300</td> <td>33</td> <td>B300/33-6</td> </tr> <tr> <td>DC 730V</td> <td></td> <td>20400</td> <td>560</td> <td>26</td> <td>B560/26-6</td> </tr> </tbody> </table> <p style="text-align: center;">Overload-Capability: approx 5000% / 0,5 Sec</p>	selection guide external brakeresistors	drive-type	Ub-setpoint	Pmax ext[W]	Pd ext [W]	Rb ext [Ohm]	SSD Drives - type	..D6R..S5-3	DC 375V		4260	100	33	B100/33-3	DC 375V		17150	300	8,2	B300/8,2-3	DC 375V		17800	560	7,9	B560/7,9-3	..D6R..S5-7	DC 730V		5330	100	100	B100/100-6	DC 730V		16150	300	33	B300/33-6	DC 730V		20400	560	26	B560/26-6	
selection guide external brakeresistors	drive-type	Ub-setpoint	Pmax ext[W]	Pd ext [W]	Rb ext [Ohm]	SSD Drives - type																																								
..D6R..S5-3	DC 375V		4260	100	33	B100/33-3																																								
	DC 375V		17150	300	8,2	B300/8,2-3																																								
	DC 375V		17800	560	7,9	B560/7,9-3																																								
..D6R..S5-7	DC 730V		5330	100	100	B100/100-6																																								
	DC 730V		16150	300	33	B300/33-6																																								
	DC 730V		20400	560	26	B560/26-6																																								

5.8.2 Configuration of the brake resistor

Possible ballast circuit configurations at digital devices

a) Compact design

The plug-in modules of servo-control series 635/637/637+/637f are provided with an on board ballast electronics. It is intended for application as compact unit KDER resp. KD6R. These compact units contain the necessary ballast resistor incl. fuse for the ballast circuit. Except KD6R 16..30-7 (external resistor only).

b) Rack design

While the plug-in modules are used in a rack, the NEB power supply module takes dissipation of the braking energy (adjustment of ballast monitoring: please see NEB manual). In this case the ballast electronics of the plug-in module will be deactivated with the configuration parameter "Ballast activate = N". All further ballast parameters are no longer relevant then.

r.g. a) Adjustment of ballast circuit for compact units:

1. Ballast electronics activated:

In this case the ballast electronics of the plug-in module will be activated. "Ballast activate = J".

2. Operating point:

The operating point has to be adjusted dependent on the voltage variant.

"Ucc Ballast on = 375 V" for 230 V AC supply

"Ucc Ballast on = 720 V" for 400..460 V AC supply

3. Resistance value:

As resistance value, the parallel resistance from internal and external resistance has to be adjusted.

4. Rated power:

As ballast power (braking energy), the sum total of internal and external resistor power has to be adjusted.

Precondition for correct monitoring of shunted ballast resistors is the nearly same ratio of P - cont. power to P - pulse power. This is guaranteed with the SSD Drives standard combinations.

..KD6R 16..30-7 units do not contain an internal ballast resistor.

At these versions the values of the external resistor can be feed directly.

Brake resistor selection of the brake resistor

Example:

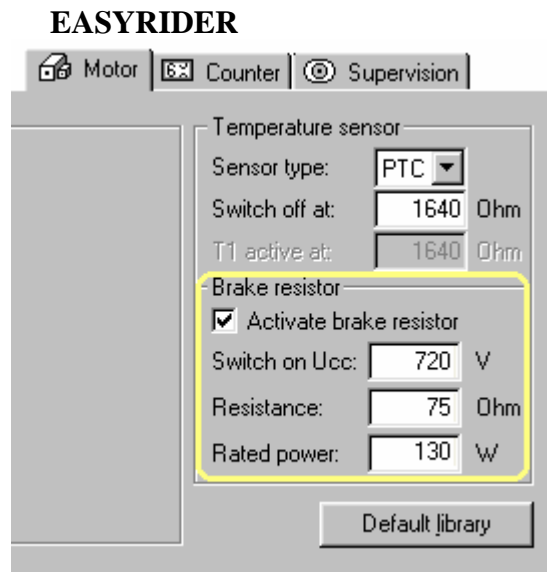

Evaluation resistance value in use of internal and external resistances.

Internal "Ballast resistances = 300 Ohm" for ..KD6R10..-7

External "Ballast resistances = 100 Ohm" for ..KD6R10..-7

$$\text{formula : } \frac{1}{R_{\text{total}}} = \frac{1}{R_{\text{int.}}} + \frac{1}{R_{\text{ext.}}}$$

$$\frac{1}{R_{\text{total}}} = \frac{1}{300\Omega} + \frac{1}{100\Omega} \Rightarrow R_{\text{total}} = 75\Omega$$

Set up resistance value = **75 Ohm**

Evaluation Ballst power in use of internal and external Ballast power.

Internal "Ballast power = 30 Watt" for ..KD6R10..-7

External "Ballast power = 100 Watt" for ..KD6R10..-7

$$\text{formula : } P_{\text{total}} = P_{\text{int.}} + P_{\text{ext.}}$$

$$P_{\text{total}} = 30W + 100W \Rightarrow P_{\text{ges.}} = 130W$$

Set up rated power = **130 Watt**



Caution !

Placing of external brake resistors

Brake-resistor are dissipating heat !

Make sure, that there will be no fire-danger in case of operating the resistor in nominal- or fail-conditions

6.1 General Information

Digital servo drives are designed for **operation in metallic grounded enclosures**. For perfect operation as well as for observance of all regulations the **front board must be connected with the enclosure electrically and fixed**.

6.2 Control cabling

Recommended cross section 0,25 mm². The control signal lines must be laid separate from the power signal lines. (see chapter 6.7.1)

The resolver cable must contain three shielded pairs **and** must be shielded as a whole. The shielding should be connected to the ground spread out on the regulator side. We recommend using SSD Drives resolver cable **KIR**. Cable for transmitting data are always to be laid shielded !

6.3 Power cabling

Recommended section according to rated current. Use only 75° Cu-cables.

6.4 Installation of the rack

When the rack is secured not in a hinged bay but on a mounting plate, it is recommended to do the wiring of the connections for the power connector X50 on the rear of the rack before installing. With hinged-bay installation, the customer must ensure that the parts sensitive to voltage such as the Ucc bus, mains supply lines, etc., are protected against electric shock.

6.5 Analog setpoint

The setpoint input is a differential input. Therefore the poling can be done depending on the requirements. Important: the setpoint voltage must be galvanically connected to the reference potential of the control connections (plug X10). It is possible to connect one pole directly to GND.

6.6 Safety rules



Caution !

Plug / unplug all modules only when Ucc (DC-BUS) is off, that is, the green LED on the power supply module is off and the discharge time > 3 minutes has elapsed.
The user must ensure protection against accidental touching.

6.7 Electromagnetic compatibility (EMC)





Conformity in accordance with the EEC Directive 89/336/EEC has been evaluated using a reference-system, consisting of a compact type drive and a line-filter on mounting-plate, connected to an AC-synchronous motor.

Mainly responsible for EMC-emissions is the motor cable. So this has to be installed exceptional carefully. The layout of grounding is very important. Grounding has to be low-impedant for high frequencies. That means, all ground-connecting parts have to use area.

The measurements made are valid under the use of SSD Drives - cables, suppression aids and line filters and by application of the following wiring instructions:

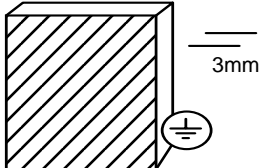
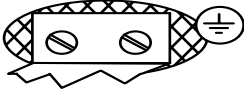
Electromagnetic compatibility (EMC)

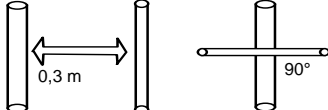
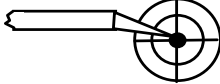
6.7.1 Hints for mounting

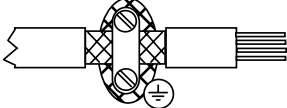
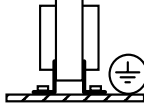
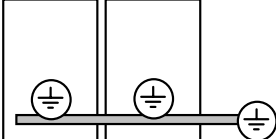
A	All components are mounted inside of a steel control cubicle on a mounting plate (thickness min. 3mm). Recommended: Galvanizing	
B	The connection between drive housing filter-housing and mounting-plate must be blank and not reduced by varnish. All screws must be well fixed !	
C	Use only SSD Drives-filters and cables for motor and resolver	
D	Place all wires and cables as close as possible to any grounded metal parts	
E	Separate power- and control cables. Minimum distance: 0,3m crosspoints: 90°	
F	Avoid cable-loops. Especially the line between line-filter and drive has to be as close and short as possible (drilled)	
G	Maintain screen as close as possible to the cable-end (max distance 8 cm)	
H	Connect screen-connections according to general view of connetions, see chapter 2.1. Ground screens on both sides, shortest way. For long cables: Connect additional screen-area along the way	
I	Connect screens area-contacted to good grounded points	
K	Connect unused wires in cables to ground	
L	Install control cables directly close to grounded metal-parts or screend when leaving the control-cubicle	
M	Take care for good grounding of control-transformer (DC 24V). Use transformer with metal-socket and take care for conductive contact to mounting-plate	
N	Take care for good general grounding of the complete system. Interconnect several mounting-plates with copper-rails or copperband. Take care for ground connection between control-cubicle and machine !	

Electromagnetic compatibility (EMC)

6.7.2 Example for mounting

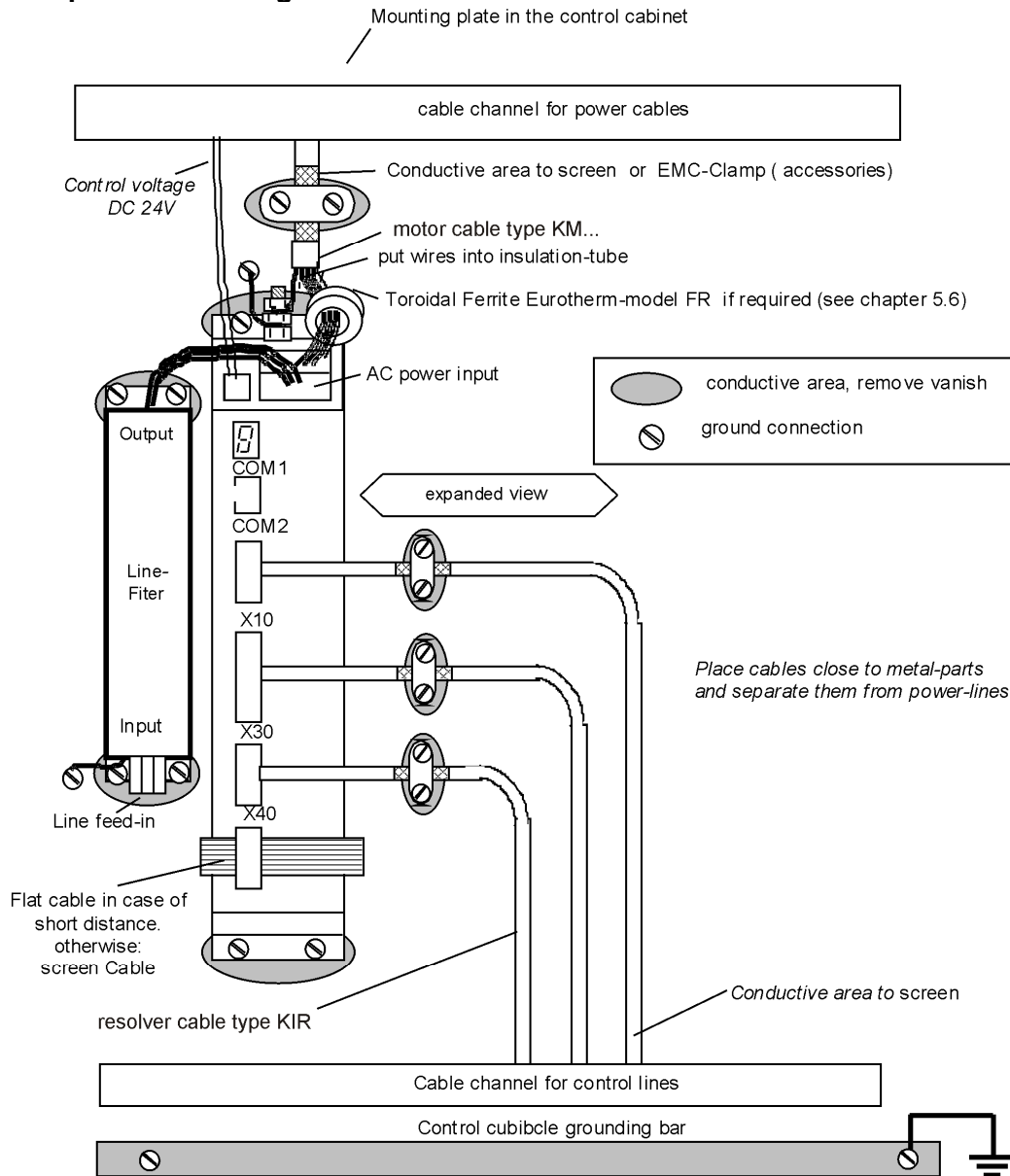

6.7.3 Achievable specifications and conditions

			Standard	conditions		additional conditions	
	Area	Class		Motor-cable length	Area	Class	Standard
Emissions: transmitted by cable or by air	Industrial	A	EN50081-2/ EN55011 Klasse A	see chapter 5.6	LNF S/E LNF B	closed cabinet with ≥ 15 dB attenuation	toroidal ferrite cores see chapter 5.6
	Residential	B	EN50081-1/ EN55011 Klasse B	see chapter 5.6	LNF S/E LNF B		
Interference immunity: (≅ radiation) transmitted by cable or by air	Industrial	A	EN50082-2	-	-	-	-
	Residential	B		-	-	-	-

7.1 Jumper

All jumpers are set to a standard position in production !

Layout of the Jumpers **see:** Chapter 1.2.3

JP100, bridged pad...	
2 and 3 (standard)	READY contact with reference to common output supply voltage on X10.21
1 and 3	READY contact can be wired freely

JP101, bridged pad...	
2 and 3 (standard)	Analog input X10.19 without internal Pull-up.
1 and 3	Analog input X10.19 with internal Pull- up to +12 V (FRR compatible)

JP102, bridged pad...	
2 and 3 (standard)	X10.23 = active ok. output
1 and 3	X10.23 = GND internal (FRR compatible)

JP1, JP2 bridged pad...	adjust identically !
2 and 3 (standard)	X10.15 = high-active
1 and 3	X10.15 = low-active

JP3, JP4 bridged pad...	adjust identically !
2 and 3 (standard)	X10.14 = high-active
1 and 3	X10.14 = low-active

JP2.8, JP2.3 JP2.7, JP2.2	
open	Default, RP CAN, RP DEV, RP PDP RP 2CA, RP 2C8
close	RP 232, RP 422, RP 485, RP IBS, RP EA5, RP SUC

JP209 2-3 JP209 1-3	
close	Default RP SBT
Further connecting configuration see: Product Manualo 07-02-10-02-E-Vxxxx RP_SBT	

7.2 Digital communication

see: Chapter 13



Caution !



**Wiring errors or incompatible operation may cause unpredictable motions.
Avoid danger for man and machine !**

8.1 Preparation

- For PC-link use the SSD Drives communication software EASYRIDER® Windows - Software. For the start, we suggest exercises in simulation mode to get familiar with EASYRIDER. This chapter presumes the knowledge how to handle EASYRIDER. Suggestions: Use test equipment to train yourself. EASYRIDER® Windows - Software contains interactive HELP - functions.
- For security-reasons the access to several functions is blocked by password. Commissioning has to be executed by trained staff only.
- Users may have their application-adapted commissioning methods when familiar with the product, on their own responsibility.
- The system must be in accordance with all valid safety specifications. The function of all safety equipment (limit-switches for example) have to be checked.
- To activate the power-stage of the drive, the "ACTIVE"-signal (X10.22 against X10.9) has to be exited.

Hint: With the assembly of the option module SBT you kindly note the extended functions of the signals
(see documentation 07-02-10-02-E..)

8.2 Commissioning in steps

Step	Action	Remark	
1	Before switching on Check the wiring, especially: Filter polarity, supply Motor wiring, motor polarity Resolver wiring, polarity (or other feedback systems)		
2	With critical mechanical part: remove motor shaft from application	avoid danger	
3	Connect PC by RS232 link to the drive service port COM1 and start EASYRIDER [®]		
4	Set up state NOT ACTIVE	7-segment-dispay	
	635/ 637/ 637+/ 637f ¹⁾	631	
	X10.22 against X10.9	X10.7 against X10.4	
	Power on		
5	Switch on control voltage	7-segment-dispay	
	635/ 637/ 637+/ 637f	631	
	Us = 24V DC	Us = 230V AC	
	EASYRIDER [®] communicates (see diagnosis F9)		
6	Are parameters already evaluated?		
	Yes: load parameter-file xxx.WDD. Store parameters in the drive. If existent: load BIAS-file xxx.WBD and store in drive. Proceed with 10 or 15 (experts)	No: continue with 7	
7	Menu Commissioning: Select the used motor from the EASYRIDER [®] - Library Adjust max. current to nominal motor current or smaller	reduced torque	
8	When leaving that menu: Tuning-parameters for current loop will be calculated and offered to the user. Normally, these values give dynamic servo motion.	Confirm acceptance of offered parameters	
9	Store data power-fail-save in the drive		
10	Menu: Tuning speed loop		

¹⁾ **Hint:** With the assembly of the option module SBT you kindly note the extended functions of the signals (see documentation 07-02-10-02-E..)

Commissioning in steps

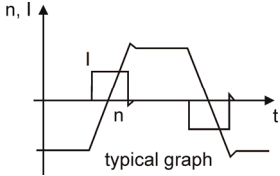
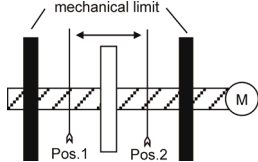
Step	Action	Remark
11	"ACTIVE" switched	7-segment-dispay 
12	Adjust test generator as required. Activate test generator with "START F8". Activate graph to display motor current or speed. Can be optimize manually (P- and I- gain)	
13	Is the result ok?	
	Yes: continue with 14 No: continue with U1	
14	Preparation to the position controller The commissioning of the position controller is first recommended without linked mechanics. In the case of secure function, the mechanics can then be linked up.	
15	Power OFF. Connect motor-shaft to application Move application to a free area between mechanical limits. Power ON. Menu: Tuning position loop	
16	Adjust test generator. Select Pos. 1 and Pos. 2 to uncritical value. Select slow speed and low acceleration first, rise up later	mind: reaction-time- to Emergency stop
17	"ACTIVE" – switched. Every activation of "START F8" excites a motion form Pos. 1 to Pos 2 and with next activation, form Pos. 2 to Pos. 1	
18	Observe the behaviour of application and graph. Optimize tuning-parameters (P-, I- and V gain)	
19	Is the result ok?	
	Yes: continue with 20 No: continue with 9	
20	Basic power-up is done now. Further functions (Interfaces, fieldbus functions, synchronizing and so on may be done adapted to selected equipments	
21	Select the menu "File" store parameters" and store the data in the regulator, protect against lost, with F7-key	data save

Commissioning in steps

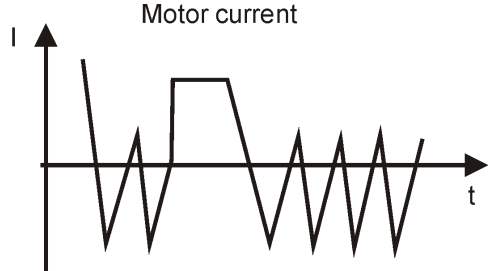
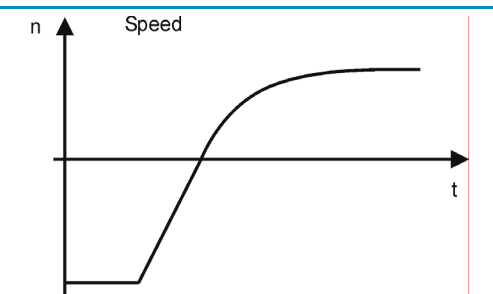
Step	Action	Remark				
U1.1	<p>Menu: Tuning Speed Loop</p> <p>Stable parameters are calculate bases on the system data; and can be called up with "Default value". Sometimes it is recommended to make further manual tuning. Rated value can be soured either digital by the internal generator or analogue by</p> <table border="1"> <tr> <td>635/ 637/ 637+/ 637f</td> <td>631</td> </tr> <tr> <td>+/- 10V at X10.5/18</td> <td>+/- 10V at X10.1/2</td> </tr> </table> <p>ATTENTION! Too hard tuning will cause current-ripple and high power dissipation.</p>	635/ 637/ 637+/ 637f	631	+/- 10V at X10.5/18	+/- 10V at X10.1/2	<p>Motor current</p>  <p>P- gain too high or I-time constant too small Motor noise</p>
635/ 637/ 637+/ 637f	631					
+/- 10V at X10.5/18	+/- 10V at X10.1/2					
U1.2	<p>Too weak adjustment cause slow loops reactions that may cause problems for the tuning of position loops.</p>	<p>Speed</p>  <p>P- gain too small or I-time constant too high</p>				
U1.3	<p>It the result ok?</p> <p>Yes: continue with 9</p>	<p>No: continue with U2.1</p>				
U2.1	<p>Menu: Tuning Current Loop</p> <p>Stable parameters are calculated bases on the system data and can be called up with "default value" Manual tuning may be useful. Rated value can be soured either digital by the internal generator or analogue by</p> <table border="1"> <tr> <td>635/ 637/ 637+/ 637f</td> <td>631</td> </tr> <tr> <td>+/- 10V at X10.5/18</td> <td>+/- 10V at X10.1/2</td> </tr> </table> <p>ATTENTION! Tuning of current loops should be only done after consultation of SSD Drives experts. continue with 9</p>	635/ 637/ 637+/ 637f	631	+/- 10V at X10.5/18	+/- 10V at X10.1/2	
635/ 637/ 637+/ 637f	631					
+/- 10V at X10.5/18	+/- 10V at X10.1/2					

9.1 7-segment display

Many sources of faults can be narrowed down with the diagnosis display.

display	explanation comment	Output		servo drive			
		ready	warning ²⁾	631	635/637	637+	637f
	no display	off	off	☑	☑	☑	☑
	any control voltage? external fuses ok?						
	system ready for operate	off	off	☑	☑	☑	☑
	drive ready, not active						
	drive ready for operate!			☑	☑	☑	☑
	DC link voltage within the limits, power stage active, fault-free						
	internal STOP with serial deactivating	off	off	☑	☑	☑	☑
	activate drive via serial interface						
	regulator of serial interface (bus interface) deactivated !	off	off	☑	☑	☑	☑
	only if bus interface is integrated						
	deactivated with delay time for the brake			☑	☑	☑	☑
	deactivated via input.	on	off				
	deactivated via serial command.	off	off				
	Active input is activated with switching on 24 V control voltage	off	off	☑	☑	☑	☑
	switch enable X10.xx switch on 0 V and after that 24 V			X10.7	X10.22	X10.22	X10.22
	Under voltage of control voltage	off	off	☐	☑	☑	☑
	Power supply switched on? Power supply o.k ? internal fuse o.k.? control voltage < 17 V						
	Under voltage in DC-bus < Ua low threshold	off	off	☑	☑	☑	☑
	check power supply (power supply unit, wiring, fuse), check under voltage parameter						
	feedback system error (e.g. resolver)	off	off	☑	☑	☑	☑
	wiring to encoder system ok? encoder system supply ok?						
	I ² t- overload of the drive	1)	1)	☑	☑	☑	☑
	does the control loop oscillate? P-amplification too high mechanics stiff? requirements too high? is warning /8/ evaluated?						

1) Reaction to these errors chapter: **Function diagrams from inputs and outputs**

2) With configuration corresponding chapter : **Operating modes and pin functions**

3) Only warning respect. status indicator

The error signals are shown as long as there is control voltage (Us), also when the power (DC-Bus) is switched off for safety reasons.

7-segment display

display	explanation	Output		servo drive			
	comment	ready	warning ²⁾	631	635/637	637+	637f
	overload of the motor I ² t	1)	1)	<input checked="" type="checkbox"/>	<input checked="" type="checkbox"/>	<input checked="" type="checkbox"/>	<input checked="" type="checkbox"/>
	does the control loop oscillate? P-amplification too high mechanics stiff? requirements too high? is warning /8/ evaluated?						
	over temperature of the output stage (> 95°C)	1)	1)	<input checked="" type="checkbox"/>	<input checked="" type="checkbox"/>	<input checked="" type="checkbox"/>	<input checked="" type="checkbox"/>
	adequate cooling of the regulator? ambient temperature too high?						
	over voltage on DC bus	1)	1)	<input checked="" type="checkbox"/>	<input checked="" type="checkbox"/>	<input checked="" type="checkbox"/>	<input checked="" type="checkbox"/>
	ballast module ok? adequate ballast module?						
	chassis shorting and short circuit due to hardware	off	off	<input checked="" type="checkbox"/>	<input checked="" type="checkbox"/>	<input checked="" type="checkbox"/>	<input checked="" type="checkbox"/>
	motor cabling ok? digital-loops setup ok? short circuit to chassis in the motor? braking resistor: ohm- value too low? try to start fresh! send in for repair						
	WARNING! Overload of the regulator I ² t or motor I ² t or temp.-output stage too high. If no reaction within approx. 3sec.it switches off with signals /3/, /4/ or /5/. Signal /8/ clears when there is no more danger or it is switched off	on	1)	<input checked="" type="checkbox"/>	<input checked="" type="checkbox"/>	<input checked="" type="checkbox"/>	<input checked="" type="checkbox"/>
	mechanics stiff? defective bearings; cold grease? reduce requirements and creep to next possible STOP						
	over temperature motor(NTC/PTC)	off		<input checked="" type="checkbox"/>	<input checked="" type="checkbox"/>	<input checked="" type="checkbox"/>	<input checked="" type="checkbox"/>
	check overload of the motor / cooling etc.						
	motor temperature too high	on	1)	<input checked="" type="checkbox"/>	<input checked="" type="checkbox"/>	<input checked="" type="checkbox"/>	<input checked="" type="checkbox"/>
	check overload of the motor / cooling etc.						
	ballast active			<input checked="" type="checkbox"/>	<input checked="" type="checkbox"/>	<input checked="" type="checkbox"/>	<input checked="" type="checkbox"/>
	Brake energy is removed						
	warning I ² t ballast too high			<input checked="" type="checkbox"/>	<input checked="" type="checkbox"/>	<input checked="" type="checkbox"/>	<input checked="" type="checkbox"/>
	ballast resistance usage >90%						
	switch off ballast	on	1)	<input checked="" type="checkbox"/>	<input checked="" type="checkbox"/>	<input checked="" type="checkbox"/>	<input checked="" type="checkbox"/>
	ballast resistance overloaded						

1) Reaction to these errors chapter: **Function diagrams from inputs and outputs**

2) With configuration corresponding chapter : **Operating modes and pin functions**

3) Only warning respect. status indicator

The error signals are shown as long as there is control voltage (Us), also when the power (DC-Bus) is switched off for safety reasons.



7-segment display

display	explanation	Output		servo drive			
	comment	ready	warning ²⁾	631	635/637	637+	637f
	X 300 – Module not inserted or wrong inserted or defect	off	off	<input type="checkbox"/>	<input type="checkbox"/>	<input checked="" type="checkbox"/>	<input checked="" type="checkbox"/>
	X 300 testing						
	X 300 – setting wrong			<input type="checkbox"/>	<input type="checkbox"/>	<input checked="" type="checkbox"/>	<input checked="" type="checkbox"/>
	X 30 / X40 Counter-Configuration test in the EASYRIDER® Windows – Software						
	³⁾ tracking window exceeded			<input checked="" type="checkbox"/>	<input checked="" type="checkbox"/>	<input checked="" type="checkbox"/>	<input checked="" type="checkbox"/>
	only in operation mode position control, will be deleted with the next run-command						
	tracking error with switch off			<input checked="" type="checkbox"/>	<input checked="" type="checkbox"/>	<input checked="" type="checkbox"/>	<input checked="" type="checkbox"/>
	only in operation mode "position control"						
	³⁾ limit switch +			<input checked="" type="checkbox"/>	<input checked="" type="checkbox"/>	<input checked="" type="checkbox"/>	<input checked="" type="checkbox"/>
	limit switch + X10.xx on 0 Volt, from Firmware 6.16			X10.8	X10.14	X10.14	X10.14
	³⁾ limit switch -			<input checked="" type="checkbox"/>	<input checked="" type="checkbox"/>	<input checked="" type="checkbox"/>	<input checked="" type="checkbox"/>
	limit switch - X10.xx on 0 Volt, from Firmware 6.16			X10.9	X10.15	X10.15	X10.15
	³⁾ limit switch + / limit switch -			<input checked="" type="checkbox"/>	<input checked="" type="checkbox"/>	<input checked="" type="checkbox"/>	<input checked="" type="checkbox"/>
	both limit switch X10.xx on 0 Volt, from Firmware 6.16			X10.8 X10.9	X10.14 X10.15	X10.14 X10.15	X10.14 X10.15
	memory-checksum-error	off	off	<input checked="" type="checkbox"/>	<input checked="" type="checkbox"/>	<input checked="" type="checkbox"/>	<input checked="" type="checkbox"/>
	try new start, store the value again						
	DC Bus Unterspannung < 100 V			<input checked="" type="checkbox"/>	<input type="checkbox"/>	<input type="checkbox"/>	<input type="checkbox"/>
	-						
	1: internal software error, Watchdog			<input checked="" type="checkbox"/>	<input checked="" type="checkbox"/>	<input checked="" type="checkbox"/>	<input checked="" type="checkbox"/>
	2: blinking: BIAS software error			<input type="checkbox"/>	<input type="checkbox"/>	<input type="checkbox"/>	<input checked="" type="checkbox"/>
	1: Firmware version check						
	2: Bias program error fix						

- 1) Reaction to these errors chapter: **Function diagrams from inputs and outputs**
- 2) With configuration corresponding chapter : **Operating modes and pin functions**
- 3) Only warning respect. status indicator

The error signals are shown as long as there is control voltage (Us), also when the power (DC-Bus) is switched off for safety reasons.

7-segment display

display	explanation	Output		servo drive			
	comment	ready	warning ²⁾	631	635/637	637+	637f
	starting lockout RP SBT			<input type="checkbox"/>	<input type="checkbox"/>	<input type="checkbox"/>	<input checked="" type="checkbox"/>
	terminal X290. 3/4 check						
	Max. speed overload			<input type="checkbox"/>	<input type="checkbox"/>	<input type="checkbox"/>	<input checked="" type="checkbox"/>
	check speed limits resp. setpoint speed						
	CAN - Open 402 Sync Message error in Interpolated positioning mode			<input checked="" type="checkbox"/> 6.19c	<input type="checkbox"/>	<input type="checkbox"/>	<input checked="" type="checkbox"/> 8.19d
	-						

- 1) Reaction to these errors chapter: **Function diagrams from inputs and outputs**
- 2) With configuration corresponding chapter : **Operating modes and pin functions**
- 3) Only warning respect. status indicator

The error signals are shown as long as there is control voltage (Us), also when the power (DC-Bus) is switched off for safety reasons.

9.2 Reset of a regulator trouble

A general precondition for correct execution of the Reset is the elimination of the error cause.

The error signals

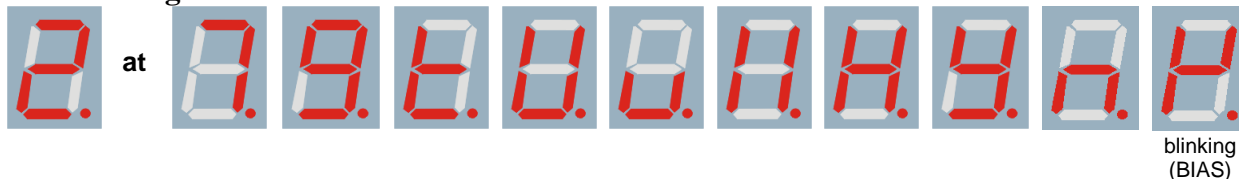

of the drive can be reset via:

1. **Control voltage OFF/ON,**
2. **the serial command “Drive Reset“ 0x02**

The host login must be occurred.

The drive must be deactivated via the serial command “deactivate Drive“ 0x00.

3. **the fieldbus-command “ Drive Reset“ 0x16 (22 decimal)**

The host login must be occurred via the BUS command 0x01. The drive must be deactivated via the BUS command “deactivate Drive“ 0x14.

The fieldbus command “Drive Reset“ with constant repetition of the fieldbus command 0x16 will be works-off only once.



For further processing, it is necessary, meanwhile to send another control word (e.g. 0 status order).

4. **a 0 – 1 flank on input X10.11**

Precondition:

- The input X10.11 is with function 1“Reset drive fault“ configured (EASYRIDER® Windows – Software)
- There is no host login.
- The input Active,(X10.22) is inactive (0V) ¹⁾
- The signal must be present min. 250 ms

Notice !!

After remove of the tracking error deactivation  the warning message  (tracking error) is active up to the next move command.



The **error signal** (releasing before ready) can be reset by deactivation the drive.

¹⁾ **Hint:** With the assembly of the option module SBT you kindly note the extended functions of the signals (see documentation 07-02-10-02-E..)

9.3 Trouble shooting

The following list refers to faults which can occur during operation.

Display:



Error	Explanation and remedy	
no motor run despite current flow	motor mechanically blocked? motor brake released?	1)
motor runs unevenly	check setpoint wiring check grounding and shielding too high P-amplification in the speed controller reduce value (with EASYRIDER® setting/speed control) too small I-time in the speed controller? reduce value (with EASYRIDER® setting/speed control)	
no reaction of setpoint progression, despite torque in standstill	Limit switch functions effective (BIAS)	
no current flow; no torque despite activating the regulator correctly	motor cables interrupted? Is input "I extern" (X10.19) activated (config. menu) and not notched up? limit switch - input activated and not notched up?	
Interference symptoms with power frequency	Ground loops in setpoint or actual value wiring? Shieldings laid on both sides? Signal cables near high voltage cables?	
Motor takes up preferred positions after activation	Position encoder or motor cables with reversed poles? Resolver or Feedback- encoder incorrectly adjusted? Number of motor poles wrong matching? (config. menu)	1)
Motor runs up immediately after activation although there is no setpoint	Motor cables or feedback- cables reversed? Encoder incorrectly adjusted? (e.g. Resolver)	1)
Motor reaches in idling cycle very different speed when running to the right or to the left	Feedback-Encoder incorrectly adjusted (e.g. Resolver)	

1) Display



or



mostly short after activating; before warning



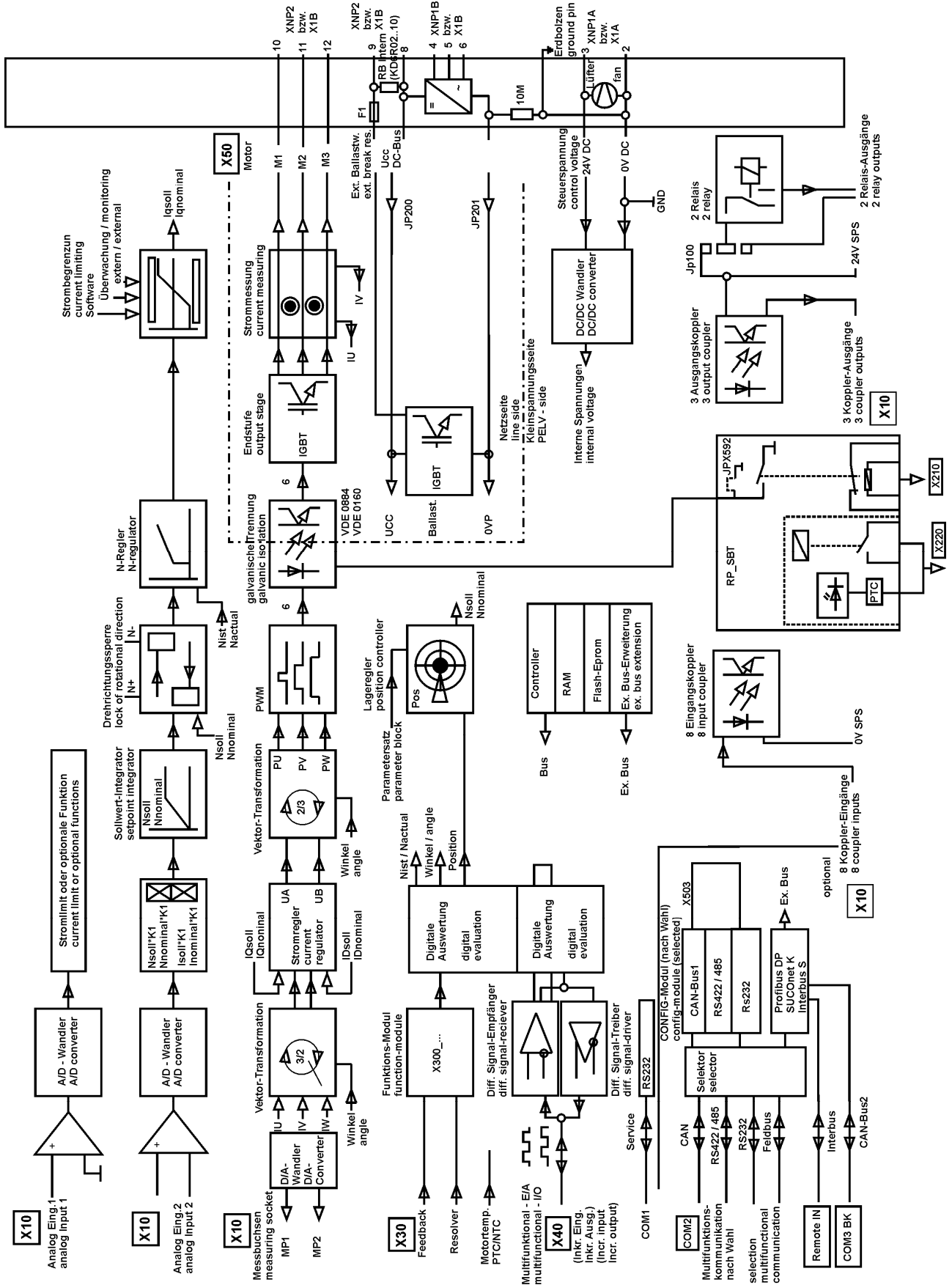

11.1 Power circuit

galvanic separation from control circuit	in acc. with EN 50178 / VDE 0160
specification in accordance with	UL 508C and cUL
short circuit and to frame proof for	Min. 2000 releasings
overvoltage monitoring D6R..-3	Max. 400V DC \pm 5V DC
overvoltage monitoring D6R..-7	Max. 765V DC \pm 10V DC
undervoltage monitoring	min. 15V DC; configurable
overtemperature switch off at	95 ° C \pm 5%
clock frequency	4,75 kHz
frequency of current ripple	9,5 kHz

11.2 Control circuit

galvanic separation from power circuit	in acc. with EN 50178 / VDE 0160
further information:	see concept of insulation chapter 1.3.1
	see data compact units chapter. 1.3.3
	see data plug-in modules chapter 1.3.4

11.3 Signal inputs and outputs, connection X10

additional galvanic separation from power and control circuit	
nominal voltage of the in- and outputs	24 V DC
number of outputs signal outputs via OPTO coupler	5 $U_{max} = 45V DC$; $I = 0..60 mA$; short circuit proof, resistive load
signal outputs via RELAY	$U_{max} = 45V DC$; $I = 1\mu A...1,2A$
contact protection with inductive load	internal varistor
number of inputs signal outputs via OPTO coupler	8 $L = 0...7 V DC$ or open $H = 15...30 V DC$ $I_{in} 24VDC: 8 mA$
Shortest time of signal at all input to accept the signal in an application:	> 1 ms
Damping of the transfer from low to high (0-->24V):	fast input: 20 μ s (X10.4, X10.25) Damping of the transfer from low to high (0-->24V):
Interrupt response time for fast input	10 μ s (X10.4, X10.25)
Damping of the transfer from high to low (24-->0V)	fast input: 250 μ s (X10.4, X10.25) Damping of the transfer from high to low (24-->0V)

11.4 Signal inputs and outputs, connection X120B resp. 120C

additional galvanic separation from power and control circuit																
nominal voltage of the in- and outputs	24 V DC +20% / -10%															
number of outputs signal outputs via OPTO coupler	4 resistive load I _{max.} = 2A inductive loadmax. 1Henry <table border="1" style="width: 100%; text-align: center;"> <thead> <tr> <th>I_{out•}</th> <th>I_{out•}</th> <th>I_{out•}</th> </tr> </thead> <tbody> <tr> <td>1A</td> <td>1A</td> <td>1A</td> </tr> <tr> <td>1A</td> <td>1A</td> <td>1A</td> </tr> <tr> <td>0,33A</td> <td>0,33A</td> <td>0,33A</td> </tr> <tr> <td>0,2A</td> <td>0,2A</td> <td>0,2A</td> </tr> </tbody> </table> <p>short-circuit current limited by (5A) over-temperature protection, active overvoltage clamping (50V); keyed</p>	I _{out•}	I _{out•}	I _{out•}	1A	1A	1A	1A	1A	1A	0,33A	0,33A	0,33A	0,2A	0,2A	0,2A
I _{out•}	I _{out•}	I _{out•}														
1A	1A	1A														
1A	1A	1A														
0,33A	0,33A	0,33A														
0,2A	0,2A	0,2A														
number of inputs signal outputs via OPTO coupler	4 L = 0...7 V DC or open H = 15...30 V DC I _{in} at 24VDC: 8 mA															
Shortest time of signal at all input to accept the signal in an application:	> 1 ms															
Damping of the transfer from low to high (0-->24V):	default input: 200µs															
Damping of the transfer from high to low (24-->0V)	default input: 1000µs															

11.5 Digital control

current control	
Loop-Cycle-Time	105 µs
settings	according to factory specifications or motor data
current limits, Adjustment by:	speed control -menue Analog Input 0..10V = 0..100%; can be normed, 10Bit

speed control	
Loop-Cycle-Time	105 µs
settings	speed control menue
differential setpoint input analog resolution (including sign)	U _{Soll} = 10 V, can be normed; R _i = 10k 14 bit
digital setpoint input	via interfaces

position control	
Loop-Cycle-Time	105 µs

11.6 Digitale communication

RS232 - service interface	COM1 19200 baud, 8 databits, 1 startbit, 1 stopbit, parity: even
<u>Optional</u> RS232 / RS422 / RS 485 on SUB D – socket	COM2
CAN1, Profibus DP, SUCOnet K on SUB D – socket Interbus S on SUB D – socket (OUT)	
Interbus S (Remote IN) CAN2	additional on SUB D – socket

11.7 Resolver evaluation/transmitter principle

<u>General:</u> The specified data refer to the combination of the standard resolver interface with Function-Module X300_RD2; operated with the SSD Drives resolver R 21-T05, R15-T05	
carrier frequency	$f_t = 4,75 \text{ kHz}$
ripple of the speed actual value signal	2% ¹⁾
max. position resolution for one revolution	65536 / 16 bit
absolute position accuracy	$\pm 0,7^\circ$ ¹⁾
relative position accuracy	$\pm 0,08^\circ$ ¹⁾

¹⁾ Data under check, Reality: Quality improved

11.8 Controllsystem

system run-up time after switching on the control voltage	max. 6 sec.
data memory / organization	Flash Eprom 256 KB RAM 64 KB; EEPROM 96 kByte

11.9 Analog-Outps

measuring pin X10.17

signal range	-10V.....0.....+10V magnifier function can be normed
resolution	10 bit, independend of norming
internal resistance	1,8 kOhm

measuring pin X10.6

signal range	-10V.....0.....+10V magnifier function can be normed
resolution	8 bit, independend of norming
internal resistance	1,8 kOhm

11.10 Thermal data

thermal data	see chapter 1.3
--------------	-----------------

11.11 Mechanical data

dimensions	see chapter 1.4
weight	see chapter 1.3

Further data you will find in chapter 1.3

The digital servo drive consists of different materials.

The following table shows, which materials can be recycled and which have to be disposed of in a special way.

material	recycle	disposal
Metal	yes	no
plastics material	yes	no
printed board assembly	no	yes

Dispose of the appropriate materials in accordance with the valid environmental control laws.

13.1 EASYRIDER® Windows - Software

EASYRIDER® Windows - Software is an comfortable tool to use all drive functions. Detailed Online-Help-information's and instruction are available.

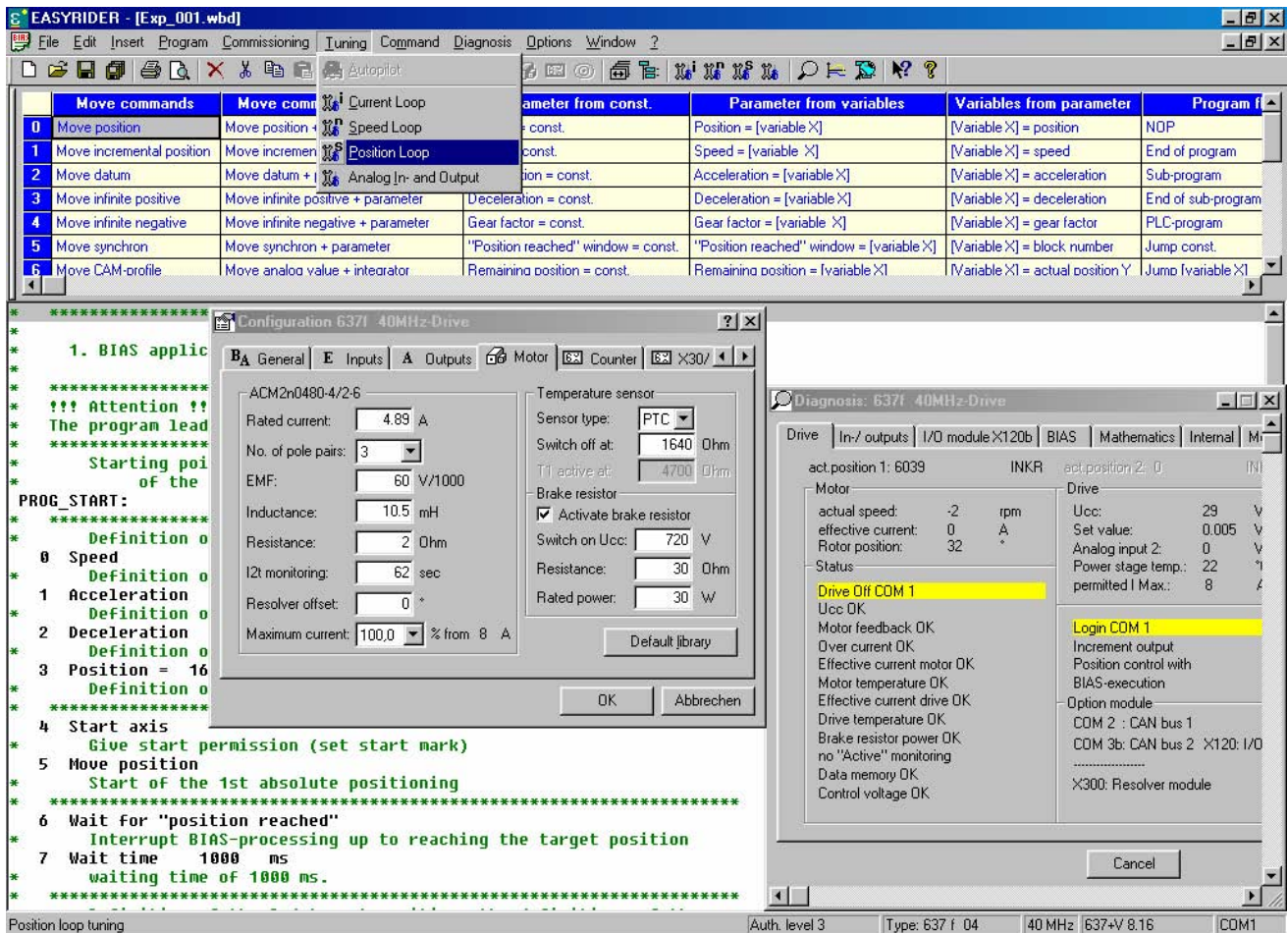

EASYRIDER® Instructions: (extract)

- Autopilote-function as interactive tutorial
- System identification
- BIAS - instruction-set editor
- Oszilloscope-function
- start-up and comissioning-tools
- Setting of parameters, Setting of configurations
- Servo-diagnostics, Interface diagnostics, Fieldbus diagnostics
- Motor library
- save system data in file, load system data from file
- send system data to servo drive, save system data in servo drive
- load system data from servo drive

Important:

Edited data in EASYRIDER® are transmitted to the RAM of the servo drive and **active after** use of the instruction **SEND**. **Only the instruction SAVE in EEPROM** writes data into a not volatile memory. Data are stored there power-fail save.

13.2 SSD Drives programming language BIAS

In **Operating mode 5** – Position control with BIAS, three user-defined programs can be executed parallel. The BIAS-program and the PLC-program (sequence cascades, 1 command per position controller sampling = 844 μ s) as well as the Mathematics program (cyclic execution in remaining time of processor).

The BIAS-program is primary intended for administration of travel commands. If application permits, also simple calculations can be performed and analog/digital I/O's can be serviced in this task. The PLC-task is conceived to perform I/O logic, sequence control, monitoring and CAN-Bus communication.

The Mathematics program is designed for complex calculations, e.g. computing of a cam, executed by the BIAS-program afterwards. But it is also possible to store the same tasks here, as basically defined for PLC-task, which can increase PLC performance of the 637+ controller approx. twenty times.

While the BIAS-program will be executed from the start block directly after activation of **operating mode 5**, the PLC-program will be first started by BIAS-command "PLC-program" and the Mathematics program by command "Mathematics program". At reaching the command "End of program" (Mode = 0) the respective execution pointer re-jumps to his start label. Within the command set the following command groups are provided:

Program flow control

- Fixing start/end of main- and sub-programs
- Conditional and unconditional jump commands

Travel relevant commands

- Positioning commands
- Parameter commands
- Technology functions
 - >Register positioning
 - >PID-control
 - >Synchronous applications

Logic commands

- Logic commands for coils and internal relays

Variable commands

- Writing and reading of parameters
- Fundamental operations of arithmetic with long integer
- Type-conversions long integer \Leftrightarrow double float (Math.task only)
- Fundamental operations of arithmetic with double float (Math.task only)
- SIN(x),COS(x),SQRT(x) with double float (Math.task only)
- Writing and reading of synchronous profile tables.

CAN-Bus commands

- Communication with other SSD Drives products

SSD Drives programming language BIAS

The user has the possibility to program his sequence himself from this set of commands.

Available program area	
Set number	
0000 -	
...	
...	can be selected via
...	data inputs X10.xx
...	max. to block no. 63 and
...	and Strobe X10.2
...	
0063 -	
...	
...	
1499	last block

The BIAS operation set is listed on the next page.

You can read the exact function of the individual commands in the help function of the EASYRIDER® Windows -Software in the BIAS editor or in the BIAS command description (10-06-05-E-Vxxxx).



13.3 BIAS – Commands

Position = const. This command is only permitted in the BIAS- task	[Variable X] = position This command is only permitted in the BIAS, PLC and MATH-Task	BIAS-execution pointer This command is only permitted in the PLC and MATH-Task	[Variable X] =flag Y This command is only permitted in the BIAS and PLC -Task	Profile value = [variable X] This command is only permitted in the MATH-Task	Save table This command is only permitted in the MATH-Task	PLC-program This command is only permitted in the BIAS and MATH-Task
---	--	---	--	---	---	---

	0	1	2	3			7	8	9	A	B	
0	Move position	Move position + parameter	Position = const.	Position = [variable X]	[Variable X] = position	NOP	Flag X = const.	If input X ? const.	[Variable X] = const.	Mathematic program	Table [[variable X]] = const.	[D Variable X] = [D Variable Y] + [D Variable Z]
1	Move incremental position	Move incremental position + parameter	Speed = const.	Speed = [variable X]	[Variable X] = speed	End of program	If flag X ? const.	If output X ? const.	If [variable X] ? const.	Profile initialization = const.	Table [[variable X]] = [Y Variable Z]	[D Variable X] = [D Variable Y] - [D Variable Z]
2	Move datum	Move datum + parameter	Acceleration = const.	Acceleration = [Variable X]	[Variable X] = acceleration	Sub- program	Flag X = flag Y	Output X = const.	[Variable X] = [variable Y] + const.	Profile cycle length = [variable X]	[X Variable Y] = Table [[variable Z]]	[D Variable X] = [D Variable Y] * [D Variable Z]
3	Move infinite positive	Move infinite positive + parameter	Deceleration = const.	Deceleration = [variable X]	[Variable X] = deceleration	End of Sub-program	Flag X = input Y	Output X = flag Y	[Variable X] = [variable Y] - const.	[Variable X] = profile value	[W Variable X] = [Y Variable Z]	[D Variable X] = [D Variable Y] / [D Variable Z]
4	Move infinite negative	Move infinite negative + parameter	Gear factor = const.	Gear factor = [Variable X]	[Variable X] = gear factor	PLC-program	Flag X = output Y	---	[Variable X] = [variable Y] * const.	Profile value = [variable X]	[X Variable Y] = const.	If [D Variable X] ? [D Variable Y]
5	Move synchron	Move synchron + parameter	"Position reached" window = const.	"Position reached" window = [variable X]	[Variable X] = block number	Jump const.	Flag X = flag Y & flag Z	---	[Variable X] = [variable Y] / const.	---	[Variable X] = const.	[D Variable X] = SIN ([D Variable Y])
6	Move CAM profile	Move analogue value + integrator	Remaining position = const.	Remaining position = [variable X]	[Variable X] = actual position Y	Jump [variable X]	Flag X = flag Y flag Z	---	[Variable X] = flag Y	---	[Variable X] = [variable Y]	[D Variable X] = COS ([D Variable Y])
7	Synchronous settings 1	Move speed + integrator	Ramp filter = const., [variable X]	Maximal current = [variable X]	[Variable X] = analogue input Y	BIAS-Execution pointer = const.	Flag X = flag Y ^ flag Z	---	[Variable X] = [variable Y].bit Z number	Save table	[Variable X] = [variable Y]	[D Variable X] = SQRT ([D Variable Y])
8	Synchronous settings 2	---	Actual position X = const.	Actual position X = [variable Y]	[Variable X] = latch position Y	Wait for "position reached"	Flag X = ! flag Y	IBT- mask number = const.	[Variable X] = [variable Y]	---	[Variable X] = [variable Y] ? [variable Z]	---
9	Move PID: speed	---	If actual position X ? const.	Analogue output X = [variable Y]	[Variable X] = actual speed Y	Wait time = const.	Flag X = status Y	IBT- notification number = const.	If [variable X] ? [variable Y]	---	[Variable X] = [variable Y] ? const.	---
A	Move PID: torque	Cycle length = const.	If actual position X ? [variable Y]	PID scaling	[Variable X] = latch status Y	Wait time = [variable X]	If status X ? const.	CAN Command = [variable X]	[Variable X] = [variable Y] + [variable Z]	---	---	---
B	Set point [axis no.] = const.	Cycle length = [variable X]	Sensor window = const.	Sensor window = [variable X]	[Variable X] = position Y; axis no.	BIAS-execution pointer = [variable X]	Modus X = const.	IBT- data transfer	[Variable X] = [variable Y] - [variable Z]	---	---	---
C	Set point [axis no.] = [variable X]	Load parameter set X = [variable Y]	Sensor position = const.	Sensor position = [Variable X]	[Variable X] = value Y	Jump [Var.X]; length = const.; from	Flag X = [variable Y]	CAN2 Command = [variable X]	[Variable X] = [variable Y] * [variable Z]	---	---	---
D	Move relative	---	Sensor adjustment 1 = const.	Sensor adjustment 1 = [variable X]	[Variable X] = axis status, axis no. Y	Execute X commands	[Variable X]. bit[Y] = const.	---	[Variable X] = [variable Y] / [variable Z]	---	---	---
E	Start axis	---	Sensor adjustment 2 = const.	Sensor adjustment 2 = [variable X]	---	---	If [Var. X]. bit Y == const. then jump	---	[Teachvariable X] = [variable Y]	---	---	---
F	Stop axis	Stop axis ± parameter	Update parameter	PID parameter	---	Virtual program	Axis state, axis no. X, bit Y = const., [flag Z]	---	[Variable X] = [teachvariable Y]	---	---	---

- [Command group "Move commands"](#)
- [Command group "Parameter commands"](#)
- [Command group "Variable commands"](#)
- [Command group "Flag commands"](#)
- [Command group "Conditional jump commands"](#)

- [Command group "Program control commands"](#)
- [Command group "Mathematic commands"](#)
- [Command group "Output commands"](#)
- [Command group "CAN- Commands"](#)
- [Command group "637f commands"](#)

VDE Prüf- und Zertifizierungsinstitut

ZEICHENGENEHMIGUNG MARKS LICENCE

SSD Drives GmbH
Im Sand 14
76669 Bad Schönborn-Langenbrücken

ist berechtigt, für ihr Produkt /
is authorized to use for their product

**Gerät, sonstiges
Other appliance
Kompakt-Servoregler**

die hier abgebildeten markenrechtlich geschützten Zeichen
für die ab Blatt 2 aufgeführten Typen zu benutzen /
the legally protected Marks as shown below for the types referred to on page 2 ff.



Geprüft und zertifiziert nach /
Tested and certified according to

DIN EN 50178 (VDE 0160):1998-04; EN 50178:1997



Aktenzeichen: 1923500-3990-0003 / 19496

File ref.:

Ausweis-Nr. 108336

Blatt 1

Licence No.

Page

Weitere Bedingungen siehe Rückseite und Folgebblätter /
further conditions see overleaf and following pages

Offenbach, 1998-07-02

(letzte Änderung/updated 2004-11-12)

VDE Prüf- und Zertifizierungsinstitut
VDE Testing and Certification Institute
Zertifizierungsstelle
Certification

VDE VERBAND DER ELEKTROTECHNIK
ELEKTRONIK INFORMATIONSTECHNIK e.V.



VDE Prüf- und Zertifizierungsinstitut Zeichengenehmigung

Ausweis-Nr. / Licence No.	Blatt / page
108336	2

Name und Sitz des Genehmigungs-Inhabers / *Name and registered seat of the Licence holder*
SSD Drives GmbH, Im Sand 14, 76669 Bad Schönborn-Langenbrücken

Aktenzeichen / <i>File ref.</i>	letzte Änderung / <i>updated</i>	Datum / <i>Date</i>
1923500-3990-0003 / 19496 / FG13 / EN	2004-11-12	1998-07-02

Dieses Blatt gilt nur in Verbindung mit Blatt 1 des Zeichengenehmigungsausweises Nr. 108336.
This supplement is only valid in conjunction with page 1 of the Licence No. 108336.

Gerät, sonstiges *Other appliance* Kompakt-Servoregler

Typ(en) / *Type(s)*:

637/K D6R02.S3-3
637/K D6R02.S3-7
637/K D6R04.S3-3
637/K D6R04.S3-7
637/K D6R06.S3-3
637/K D6R06.S3-7
637/K D6R10.S3-3
637/K D6R10.S3-7
637/K D6R16.S3-3
637/K D6R16.S3-7
637/K D6R22.S3-3
637/K D6R22.S3-7
637/K D6R30.S3-3
637/K D6R30.S3-7

Nennspannung <i>Nominal Voltage</i>	1/N/PE 230 V oder 3PE AC 230 V; 50/60 Hz (S3-3 Typen) 3/PE AC 460 V; 50/60 Hz (S3-7 Typen)
--	--

Nennstrom <i>Rated current</i>	siehe Anlage Nr. 1 <i>see Appendix No. 1</i>
-----------------------------------	---

zulässige Umgebungstemperatur <i>Ambiant temperature</i>	0...40°C
---	----------

Schutzmaßnahme <i>Protection against electric shock</i>	Schutzklasse I <i>Class I</i>
--	----------------------------------

Fortsetzung siehe Blatt 3 /
continued on page 3

VDE Testing and Certification Institute * Institut VDE d'Essais et de Certification

Merianstrasse 28, D-63069 Offenbach



Telefon +49 (0) 69 83 06-0
Telefax +49 (0) 69 83 06-555

VDE Prüf- und Zertifizierungsinstitut Zeichengenehmigung

Ausweis-Nr. / Blatt /
Licence No. / page
108336 / 3

Name und Sitz des Genehmigungs-Inhabers / *Name and registered seat of the Licence holder*
SSD Drives GmbH, Im Sand 14, 76669 Bad Schönborn-Langenbrücken

Aktenzeichen / *File ref.* / letzte Änderung / *updated* / Datum / *Date*
1923500-3990-0003 / 19496 / FG13 / EN / 2004-11-12 / 1998-07-02

Dieses Blatt gilt nur in Verbindung mit Blatt 1 des Zeichengenehmigungsausweises Nr. 108336.
This supplement is only valid in conjunction with page 1 of the Licence No. 108336.

Schutzart	Einbaugerät, die Servoregler sind ausschließlich zur Speisung von Eurotherm (oder von Eurotherm freigegeben) Servomotoren bestimmt.
<i>Degree of protection</i>	<i>Built in devise, the servo controller are used only for Eurotherm servo motors or released from Eurotherm if others.</i>
Überspannungskategorie <i>overvoltage category</i>	III
Kurzschlussfestigkeit <i>Short circuit protection</i>	bedingt kurzschlußfest <i>conditionally short-circuit-proof</i>
Transformator <i>Transformer</i>	Fa. J. Lasslop, Typ TIV2DER Az.: 19235-3990-0002 Fa. Pulse FEE Typ MTA 12358 Fa. J. Lasslop, Typ T1 TEX-E V5
Weitere Angaben <i>Further information</i>	vergleiche Anlagen Nr. 1 und 2. <i>see Appendix No. 1 and 2.</i>
Beim Einbau	des genehmigten Erzeugnisses, der entsprechend der zugehörigen Installationsanleitung zu erfolgen hat, ist darauf zu achten, daß alle Anforderungen gemäß der oben genannten Bestimmung(en) eingehalten sind.
<i>Built-in</i>	<i>When the certified product is build in, installation must be in accordance to the provided installation instructions and requirements of the referenced standards must be assured</i>

Fortsetzung siehe Blatt 4 /
continued on page 4

VDE Testing and Certification Institute * Institut VDE d'Essais et de Certification

Merianstrasse 28, D-63069 Offenbach



Telefon +49 (0) 69 83 06-0
Telefax +49 (0) 69 83 06-555

VDE Prüf- und Zertifizierungsinstitut Zeichengenehmigung

Ausweis-Nr. / Licence No.	Blatt / page
108336	4

Name und Sitz des Genehmigungs-Inhabers / *Name and registered seat of the Licence holder*
SSD Drives GmbH, Im Sand 14, 76669 Bad Schönborn-Langenbrücken

Aktenzeichen / <i>File ref.</i>	letzte Änderung / <i>updated</i>	Datum / <i>Date</i>
1923500-3990-0003 / 19496 / FG13 / EN	2004-11-12	1998-07-02

Dieses Blatt gilt nur in Verbindung mit Blatt 1 des Zeichengenehmigungsausweises Nr. 108336.
This supplement is only valid in conjunction with page 1 of the Licence No. 108336.

Dieser Zeichengenehmigungs-Ausweis bildet die Grundlage für die EG-Konformitätserklärung und CE-Kennzeichnung durch den Hersteller oder dessen Bevollmächtigten und bescheinigt die Konformität mit den genannten Normen im Sinne der **EG-Niederspannungsrichtlinie 73/23/EWG** mit ihren Änderungen.

This Marks Licence is the basis for the EC Declaration of Conformity and the CE Marking by the manufacturer or his agent and shows the conformity with the said standards as defined by the EC Low-Voltage Directive 73/23/EEC including amendments.

VDE Prüf- und Zertifizierungsinstitut
VDE Testing and Certification Institute
Zertifizierungsstelle
Certification

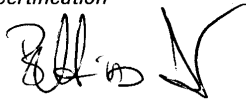

VDE Testing and Certification Institute * Institut VDE d'Essais et de Certification

Merianstrasse 28, D-63069 Offenbach



Telefon +49 (0) 69 83 06-0
Telefax +49 (0) 69 83 06-555

EC Declaration of Conformity

Issuer's name and address:

SSD Drives GmbH
Im Sand 14
76669 Bad Schönborn-Langenbrücken

Product:

Other appliance

Type designation:

637/K D6R02.S3-3; 637/K D6R02.S3-7; 637/K
D6R04.S3-3; 637/K D6R04.S3-7; 637/K D6R06.S3-3;
637/K D6R06.S3-7; 637/K D6R10.S3-3; 637/K
D6R10.S3-7; 637/K D6R16.S3-3; 637/K D6R16.S3-7;
637/K D6R22.S3-3; 637/K D6R22.S3-7; 637/K
D6R30.S3-3; 637/K D6R30.S3-7

The designated product is in conformity with the European Directive:

73/23/EEC
including amendments

"Council Directive of 19 February 1973 on the harmonization of the laws of the Member States relating to electrical equipment designed for use within certain voltage limits".

Full compliance with the standards listed below proves the conformity of the designated product with the provisions of the above-mentioned EC Directive:

DIN EN 50178 (VDE 0160):1998-04; EN 50178:1997

The VDE Testing and Certification Institute (EU Identification No. 0366), Merianstr. 28, D-63069 Offenbach, has tested and certified the product granting the VDE Licence for the mark(s) as displayed.



Licence No.
File Reference

108336
1923500-3990-0003 / 19496 FG13 / EN

Bad Schönborn

22.11.04

(Place, Date)

ppa. C. G. G.

(Legally binding signature of the issuer)

7

7-segment display 65, 66, 67, 68

A

Achievable specifications and conditions 59
 Allgemein technische Daten 72
 Analog setpoint 57
 Analog-Outps 75
 Änderungsliste 88

B

BIAS – Commands 80
 BIAS commands 78
 Block circuit diagram 71
 Brake control and PTC evaluation 45
 Brake resistor 54

C

CAN-BUS2 interface 36
 Certificates 81, 82, 83, 84, 85
 Combination possibilities for the various communications /
 I/O - modules 14
 Commissioning 61
 Commissioning in steps 62
 Compact Units 637f/K D6R 17
 Compatibility with 637+ Servo Drives 12
 Compatibility with 637 Servo Drives 12
 Configurable pin-functions 48
 Configuration of the brake resistor 55
 Connector assignment X280 45
 Connector assignment X290 44
 Control cabinet - mounting 50
 Control cabling 57
 Control circuit 72
 Control Signal Plug X10 26
 Control Signal Plug X10 27
 Control Signal Plug X10 28
 Controllsystem 74
 Cooling 50
 Correction of supply current 53

D

Danger areas 51
 Description X40 31
 Diagnose und Fehlersuche 65
 Digital Communication 11
 Digital control 73
 Digitale communication 74
 DIL – switch position 43
 DIL – switch position bus termination 43
 DIL – switch position for module RP2CA and RP 2C8 43
 Dimensions for Compact Device and Plug-In Module 21
 Disposal 76

E

EASYRIDER Instructions 77
 EASYRIDER® Windows - Software 77
 election of the brake resistor 55, 56
 Electrical Installation 51
 Electromagnetic compatibility (EMC) 57
 EMC Clip 22
 Example for mounting 59
 example of an order 13

F

Feedback Sensor Connection X30 30
 Feedback-Sensor 29
 Fieldbus interface COM2 36
 Function diagrams from inputs and outputs 49
 Fuses, contactors, filters 52

G

General Data 16
 General Information 10
 General view of connections 23, 24
 Ground connections 51
 Grounding, safety grounding 51

H

H15 multiple pin strip 25
 Hints for mounting 58
HIPERFACE® - Module X300 HF2 30

I

Incremental output 32
 Incremental-Input 32
 Installation of the rack 57
 Insulation concept 16
 interface COM1 35

J

Jumper 60

L

Layout of Power Board 15

M

measuring pin X10.17 75
 measuring pin X10.6 75
 Mechanical data 75
 Mechanical Installation 50
 Modle code 13
 Modul – Designs 37
 module slots 15
 module X300 29
 Mounting 50

O

Operating modes.....	46
Operating modes and pin functions	47
Operation configurations	11
Option module RP SBT.....	44
Option module RP SBT.....	45
Output power.....	20

P

Pin Assignment for CAN/DeviceNet.....	38
Pin assignment for I/O interface.....	40, 41, 42
Pin assignment for Interbus S.....	39
Pin assignment for Interbus S.....	88
Pin assignment for Profibus DP.....	38
Pin assignment for RS232	37
Pin assignment for RS422/485	37
Pin assignment for SUCOnet K.....	38
Plug-In Modules 637f/D6R	18
Power cabling.....	57
Power circuit	72
Preparation	61

R

Range data	16
Remote IN (COM3 B)	39
Remote OUT (COM2).....	39
Reset of a regulator trouble	69
Resolver evaluation	74
Resolver Module <u>X300_RD2</u>	30
RS232.....	35

S

Safe Stop	44
Safety	51
Safety Precautions	9
Safety rules.....	57
Selection of the brake resistor	54
Sicherheitshinweise	4, 8
Signal inputs and outputs.....	72, 73
Single- and Three-Phase Supply	19
Single-phase supply.....	19
Sinus / Cosinus - Module <u>X300_SC2</u>	30
Software	77
SSD Drives programming language BIAS	79
SSI-Encoder Interface	34
Stepper motor input.....	33
<u>Stepper motor input</u>	33
System Description.....	10
System variants	10

T

The Most Important Thing First	7
Thermal data.....	75
Three-phase-supply	19
Trouble shooting	70

W

Wiring instructions	57
---------------------------	----

X

<u>X120B</u>	42
<u>X120C</u>	42
<u>X200</u>	41

Version	Modification	Chapter	Date	Name	Comment
V0103	-	-	02.06.03	N. Dreilich	new
V0204	text correction new functions connection X30 additional In-/Outputs Pin assignment for Interbus S correction safety module SBT Text addition for SBT 7-segment display new BIAS commands	1.2 2.1-2.1.1 2.4.2 2.6.2.1 2.6.2.9 2.5.5 2.7 9.1-9.2 13.3	 16.03.04	 N. Dreilich N.Dreilich	 photo page 29-30 correction text addition "COM3 B" page 36 page 46-47 page 12-13/25-27/ 44-45/50-51/65-66 /72 new options Logos
V03004	SSD Drives	-	19.10.2004	N.Dreilich	Logos
V0405	diverse correction (text, design and photos)	all	12.05.2005	N. Dreilich	
V0505	Model code, extended		18.05.2005	N. Dreilich	

AUSTRALIA
Eurotherm Pty Ltd
Unit 1
20-22 Foundry Road
Seven Hills
New South Wales 2147
Tel: +61 2 9838 0099
Fax: +61 2 9838 9288

CANADA
SSD Drives Inc
880 Laurentian Drive
Burlington
Ontario
Canada, L7N 3V6
Tel: +1 905 333-7787
Fax: +1 905 632-0107

CHINA
Eurotherm Pty Ltd
Apt. 1805, 8 Building Hua Wei Li
Chao Yang District,
Beijing 100021
Tel: +86 10 87785520
Fax: +86 10 87790272

DENEMARK
SSD Drives
Enghavevej 11
DK-7100 Vejle
Tel: +45 70 201311
Fax: +45 70 201312

FRANCE
SSD Drives SAS
15 Avenue de Norvège
Villebon sur Yvette
91953 Courtaboeuf Cedex / Paris
Tel: +33 1 69 185151
Fax: +33 1 69 185159

GERMANY
SSD DRIVES GmbH
Von-Humboldt-Straße 10
64646 Heppenheim
Tel: +49 6252 7982-00
Fax: +49 6252 7982-05

HONG KONG
Eurotherm Ltd
Unit D
18/F Gee Chang Hong Centre
65 Wong Chuk Hang Road
Aberdeen
Tel: +852 2873 3826
Fax: +852 2870 0148

INDIA
Eurotherm DEL India Ltd
152, Developed Plots Estate
Perungudi
Chennai 600 096, India
Tel: +91 44 2496 1129
Fax: +91 44 2496 1831

IRELAND
SSD Drives
2004/4 Orchard Ave
Citywest Business Park
Naas Rd, Dublin 24
Tel: +353 1 4691800
Fax: +353 1 4691300

ITALY
SSD Drives SpA
Via Gran Sasso 9
20030 Lentate Sul Seveso
Milano
Tel: +39 0362 557308
Fax: +39 0362 557312

JAPAN
PTI Japan Ltd
7F, Yurakucho Building
10-1, Yuakucho 1-Chome
Chiyoda-ku, Tokyo 100-0006
Tel: +81 3 32132111
Fax: +81 3 32131900

KOREA
SSD Korea Co., Ltd.
1308, Daeryung Techno Town
8th Bldg., 481-11 Gasan-Dong,
Geumcheon-Gu,
Seoul 153-803
Tel: +82 2 2163 6677
Fax: +82 2 2163 8982

NETHERLANDS
Eurotherm BV
Genielaan 4
2404CH
Alphen aan den Rijn
Tel: +31 172 411 752
Fax: +31 172 417 260

Poland
OBR-USN
ul. Batorego 107
PL 87-100 Torun
Tel: +48 56 62340-21
Fax: +48 56 62344-25

Romania
Servosisteme SRL
Sibiu 17
061535 Bukarest
Tel: +40 723348999
Fax: +40 214131290

SCHWEDEN
SSD Drives AB
Montörögatan 7
S-30260 Halmstad
Tel: +46 35 177300
Fax: +46 35 108407

SPAN
Eurotherm Espana S.A.
Pol. Ind. Alcobendas
C/ La Granja, 74
28108 Madrid
Tel: +34 91 661 60 01
Fax: +34 91 661 90 93

SWITZERLAND
Indur Antriebstechnik AG
Margarethenstraße 87
CH 4008 Basel
Tel: +41 61 27929-00
Fax: +41 61 27929-10

United Kingdom
SSD Drives Ltd
New Courtwick Lane
Littlehampton
West Sussex BN17 7RZ
Tel: +44 1903 737000
Fax: +44 1903 737100

U.S.A
SSD Drives Inc.
9225 Forsyth Park Drive
Charlotte
North Carolina 28273-3884
Tel: +1 704 588 3246
Fax: +1 704 588 3249

Local availability and service support also in:

Argentina · Austria · Bangladesh · Brazil · Chile · Colombia · Costa Rica · Cyprus · Czech Republic · Ecuador · Greece · Hungary · Indonesia · Iceland · Israel · Kuwait · Lithuania · Malaysia · Marocco · Mexico · New Zealand · Nigeria · Peru · Philippines · Portugal · Saudi Arabia · Singapore · Slovenia · Sri Lanka · South Africa · Taiwan · Thailand · Turkey · United Arab Emirates · Vietnam

SSD Drives GmbH

Head Office

Von-Humboldt-Straße 10, D-64646 Heppenheim
Telefon +49 (0)6252 7982-00, Fax +49 (0)6252 7982-05

Plant Servosystems

Im Sand 14, D-76669 Bad Schönborn
Telefon +49 (0)7253 9404-0, Fax +49 (0)7253 9404-99

www.SSDdrives.com

ssd@ssddrives.de