



STANDARD HORIZON®

GPS Chart Plotters

CP500

12" WAAS GPS Chart Plotter

Owner's Manual



MAX
C-MAP NT

WARNING!!!

Electronic charts displayed by the GPS Chart Plotter are believed to be accurate and reliable, but are not intended to be a substitute for the official charts, which should remain your main reference for all matters related to the execution of safe navigation.

For this reason we would like to remind you that you should carry on board and use the official published and approved nautical charts.



FCC Compliance Statement

This device complies with Part 15 of the FCC limits for Class A digital devices. This equipment generates, uses, and can radiate radio frequency energy and, if not installed or used in accordance with the instructions may cause harmful interference with radio communications.

There is no guarantee that interference will not occur in a particular instance. If this equipment does cause harmful interference to other equipment, try to correct the problem by relocating the equipment.

Consult an authorized STANDARD HORIZON dealer or other qualified service technician if the problem cannot be corrected. Operation is subject to the following conditions: (1) This device cannot cause harmful interference, and (2) this device must accept any interference received, including interference that may cause undesired operation.

CAUTION

- The GPS Chart Plotter is designed for maritime use. To avoid water intrusion ensure the C-MAP C-CARD door is completely closed.
 - Extensive exposure to heat may result in damage to the GPS Chart Plotter.
 - The GPS Chart Plotter contains dangerous high voltage circuits which only experienced technicians can handle.
 - STANDARD HORIZON will not be liable for errors contained herein, or for incidental or consequential damages in connection with the performance or use of this material.
-

CLEANING PROCEDURE FOR THE GPS CHART PLOTTER SCREEN

Cleaning of the chart plotter screen is a very important operation and must be done carefully. Since the surface is covered by a antireflective coating, the procedure for cleaning all the surfaces can be performed using the following procedure: You need a tissue or lens tissue and a cleaning spray (Windex) containing Isopropanol (a normal spray cleaner sold for the PC screen, for example PolaClear by Polaroid). Fold the tissue or lens tissue into a triangular shape, moisten the tip and use the index finger behind a corner to move the tissue across the surface, in overlapping side to side strokes. If the tissue is too wet, a noticeable wet film will be left in its path and you will need to repeat the process. If too dry, the tissue won't glide easily, and may damage the surface.

TABLE OF CONTENTS

1. INTRODUCTION	11
1.0 GENERAL INFORMATION	11
1.1 PACKING LIST	11
1.2 OPTIONAL ACCESSORIES	12
1.3 RADAR UNIT SUPPLIED BY SI-TEX USA	12
2. GETTING STARTED	13
2.0 MOUNTING THE GPS CHART PLOTTER	13
2.1 BRACKET MOUNTING	13
2.3 EXTERNAL GPS ANTENNA MOUNTING	14
2.3.0 Flush mounting the antenna	14
2.3.1 GPS cable	15
2.3.2 GPS antenna connections	15
3. CONTROLS AND INDICATORS	21
3.0 CONTROLS AND CONNECTIONS	21
3.0.1 The alphanumeric keys	22
3.1 GETTING STARTED	23
3.1.0 Power On, Off and ShuttlePoint knob operation	23
3.1.1 Cursor Vs. Home Mode	24
3.1.2 Cursor and Menu selection speed	24
3.1.3 Changing the Ships Icon	24
3.1.4 Changing the backlight and contrast	25
3.1.5 Selecting North Up or Course Up	25
3.2 ADJUSTING THE TIME	26
3.3 SELECTING LORAN TD OR OTHER COORDINATE SYSTEM	27
3.4 CHANGING THE CHART COLOR	27
3.5 SELECTING PAGES WITH SOFT KEYS	28
3.6 CUSTOMIZING THE SOFT KEYS	28
3.7 OTHER SETTINGS IN GENERAL SETUP MENU	29
3.8 ABOUT PAGE	30
4. USING FIND SERVICES & MORE FUNCTION	31
4.0 PORT SERVICES	31
4.1 OTHER AVAILABLE SEARCHES	31
4.2 INFO ON LAKES	32
4.2.0 Quick Info On Lakes	32
4.2.1 Full Info On Lakes	32
5. C-MAP MAX OVERVIEW	35
5.0 INSERTING THE C-CARD	35
6. MAP FUNCTIONS	37
6.0 MAX FUNCTIONS MENU	37
6.0.0 Zoom Type	37
6.0.1 Fonts & Symbols	37
6.0.2 Perspective View	38

6.0.3	Dynamic Nav-Aids	38
6.0.4	Safety Status Bar (DSI - Data Safety Indicator)	39
6.0.5	Currents Prediction	40
6.0.6	Pictures & Diagrams	41
	How to show the pictures or diagrams of a Multimedia Object	41
6.0.7	Enhanced Port Info	42
7.	CREATING MARKS	43
7.0	CREATING A NEW MARK USING THE CHART PAGE	43
7.1	EDITING a MARK	43
7.1.0	Deleting a Mark or Waypoint	44
7.1.1	Moving a Mark or Waypoint	44
7.2	MARKS/WAYPOINTS LIST	45
7.3	CREATING/MODIFY A NEW MARK In THE USER POINTS LIST	46
7.4	GOTO CURSOR	46
8.	MAN OVER BOARD (MOB) FUNCTION	49
8.0	PLACING A MOB POINT	49
8.1	DELETING A MOB POINT	49
9.	ROUTES	51
9.0	CREATING A ROUTE USING WAYPOINTS	51
9.1	CHANGING NAME TO A ROUTE	51
9.2	MAKING ADDITIONAL ROUTES	52
9.3	CREATING A ROUTE USING MARKS ON THE CHART PAGE	52
9.4	INSERTING A WAYPOINT INTO A ROUTE	53
9.5	GOTO A ROUTE	53
9.5.0	By select Route	53
9.5.1	By Cursor key	53
9.6	OTHER SETTINGS IN ROUTE MENU	53
10.	TRACKS	55
10.0	TRACKING	55
10.0.0	Saving and starting a new Track	56
10.0.1	Other Settings in Track Menu	56
10.1	USING THE TRIP LOG	56
10.1.0	Resetting the Trip Log	57
11.	USER C-CARD	59
11.0	USER C-CARD MENU	59
11.0.0	Formatting the User C-CARD	59
11.0.1	Transferring files to the optional User C-CARD	60
11.0.2	Loading a file	60
11.0.3	Deleting a file from the User C-CARD	60
11.0.4	Changing the User C-CARD	60
12.	PAGES	61
12.0	CHART PAGE	62
12.0.0	Window Selections	62
12.0.1	Additional Functions on Chart page	62
12.0.2	Turning Off Information on Icon Points	63
12.0.3	Display Mode	63
12.0.4	Customizing the Map Configurations	65

12.0.5 Customizing the Data Windows	65
12.1 NAVIGATION PAGE	66
12.2 HIGHWAY PAGE	66
12.3 CELESTIAL PAGE	67
12.4 GPS STATUS PAGE	67
12.5 NMEA DISPLAY PAGE	68
12.6 NMEA DATA PAGE	69
12.7 NMEA DEPTH, WIND SPEED, TEMP AND SOG TREND PAGES	69
12.8 VHF DIGITAL SELECTIVE CALLING	69
12.8.0 DSC Distress Call	70
12.8.1 Position Request	70
13. ADVANCED SETTINGS	71
13.0 INPUT/OUTPUT (NMEA) CONNECTION	71
13.1 NAVIGATE	71
13.2 COMPASS	72
13.3 ALARMS	72
14. AIS	75
14.0 AIS SYSTEM DEFINITIONS	75
14.1 AIS MENU	76
14.2 TO SET THE CHART PLOTTER FOR RECEIVING AIS	76
14.3 QUICK INFO ON AIS TARGET	76
15. C-MAP WEATHER SERVICE	77
15.0 C-MAP WEATHER SERVICE MENU	77
15.0.0 Load From File	77
15.0.1 Forecast	78
15.0.2 Real Time View	78
15.0.3 Type of Data	78
16. TROUBLESHOOTING	79
17. TECHNICAL TESTS	81
17.0 SYSTEM TEST	81
17.0.0 RAM Menu (reset)	81
17.0.1 DIM Menu	81
17.0.2 Cartridges (used by Standard Horizon Technicians)	82
17.0.3 Serial Ports (used by Standard Horizon Technicians)	82
18. SPECIFICATIONS	83
18.0 GPS WAAS SMART Receiver Specifications	85
19. APPENDIX: TERMS	87
ANALYTICAL INDEX	89

1. INTRODUCTION

Congratulations on your purchase of the CP500. Whether this is your first GPS Chart Plotter, or if you have other STANDARD HORIZON equipment, the STANDARD HORIZON organization is committed to ensuring your enjoyment of CP500. STANDARD HORIZON technical support personnel stand behind every product we sell, and our Product Support team invites you to contact us should you require technical advice or assistance, at 800/767-2450, or marinetech@vxstdusa.com.

1.0 GENERAL INFORMATION

The CP500 is a precision-crafted GPS Chart Plotters with a 16 Channel WAAS high-performance receiver for the Global Positioning System (EGNOS Europe, MSAS Asia) constellation of satellites, providing precise location data with a host of navigation features. Ideal for nautical use and sealed against water ingress. The GPS Chart Plotter is housed in a rugged, impact-resistant case with outstanding ergonomic design, for effortless operation.

The advanced features of the GPS Chart Plotter include:

- 12-inch sunlight viewable display
- Full VGA 800 x 600 high resolution LCD
- 16 channel WAAS GPS antenna with 15 meter of cable
- 2 Video camera or DVD (NTSC or PAL) inputs
- 1 VGA video output, connects to compatible TV or monitor
- Customizable Picture In Picture video window
- Dual Frequency Fish Finder capable with optional FF520 and transducer
- Capable of using a RADAR Antenna (USA only)
- AIS Target and information capable
- C-Map NT+ or MAX Cartography capable.
- World wide background map with detail to 2NM included
- Stores up to 3000 Marks and 50 Routes
- 3-year waterproof warranty



1.1 PACKING LIST





When the package containing the CP500 is first opened, please check for the following contents. If any parts are missing contact the dealer this GPS Chart Plotter was purchased from. Accessories and replacement parts may be ordered from STANDARD HORIZON's Parts Department at 767/827-7600 ext 6800 or email at yaesuparts@vxstdusa.com.

PART CODE	ITEM
S8002251	External bracket (includes two knob-screws)
S8002252	Dust cover
T9101553	PWR ACC1 & ACC2 cable
S8002253	Flush mounting screws
Q7000619	GPS ANT Unit GSU Series UX0GSU50SD*
EM029U100	Owner's Manual
EM029U500	Quick Reference Guide

NOTE: "*" is a revision number

1.2 OPTIONAL ACCESSORIES

		
FF520 Fish Finder	ACVC10 Video Adapter cable	VGAC10 VGA Adapter cable

						
DST 520 2" Nylon Thru-hull Depth & Temp	DST 521 Transom Mount, Depth, Speed & Temp	DST 523 2" Bronze Thru-hull Depth & Temp	DST 525 In-Hull Mount, Depth	DST 526 Bronze Thru-hull, Triducer, Depth, Speed & Temp	DST 527 In-Hull Mount, Depth	DST 528 Thru-hull, Long stem, Depth & Temp
500W Transducers					1000W Transducers	

1.3 RADAR UNIT SUPPLIED BY SI-TEX USA

The Radar antenna will be supplied by SI-TEX in USA only and the part code is as follows:

MODEL NUMBER	DESCRIPTION
MDS-1	2kW 24 Mile 12.4" diameter Radome antenna
MDS-8	2kW 24 Mile 20" diameter Radome antenna
MDS-9	4kW 36 Mile 23.5" diameter Radome antenna
MDS-10-4	4kW 48 Mile 4Ft Open Array
MDS-10-5	4kW 48 Mile 5Ft Open Array

NOTE

Please contact to the Standard Horizon Authorized dealer, STANDARD HORIZON technical support or SI-TEX directly for additional information.

2. GETTING STARTED

Through this manual you will see highlighted words. Please refer to the legend below:

[MENU]	If you see brackets around a bold and capital letter word this refers to a key press.
[CHART]	If you see brackets around a bold and small capital letter word this refers to a Soft Key press.
<u>GENERAL SETUP</u>	When a word(s) is bold capital letters and underlined, this refers to a menu selection item.

2.0 MOUNTING THE GPS CHART PLOTTER

The CP500 is supplied with hardware for bracket or flush mounting. Below are pictures showing actual examples of the two types of installation.

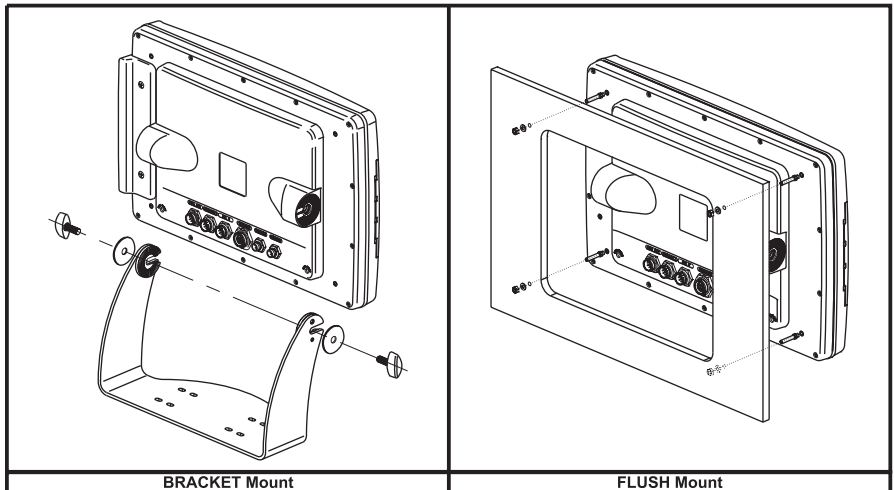

2.1 BRACKET MOUNTING

Before installing ensure the area the bracket is mounted to is strong enough to support the weight of the GPS Chart Plotter especially while under way. After the location is found, attach the mounting base to the area using the supplied hardware.

The CP500 is supplied with a flush mount template for the cutout hole and screw holes required to install the GPS Chart Plotter.

NOTE

Before drilling holes make sure there is enough room to mount the GPS Chart Plotter and there are no obstructions.

1. After a location is found, peel the template label from the backing and apply the label to the mounting area.

2. Drill a hole in one area of the cutout area that will allow the blade of a jigsaw to be inserted. Insert and cut out the area on the panel using the jigsaw.
3. Next drill the four holes required to insert the GPS Chart Plotter with the mounting studs.
4. Install the mounting studs on the GPS Chart Plotter and insert into the mounting hole.
5. Attach the GPS Chart Plotter to the mounting location by attaching the supplied hardware to the mounting studs.

2.3 EXTERNAL GPS ANTENNA MOUNTING

The CP500 is supplied with a external GPS WAAS antenna with 15 meter of routing cable. This antenna is designed to be mounted on a base, installed on an extension or even flush mounted.

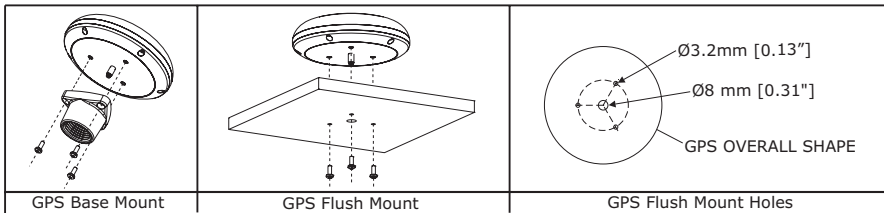

Choose a location for the antenna that has a clear view of the sky and is not located within 3 FT of Radar or other transmitting antennas. Ensure there are no major obstructions or fixtures in the immediate proximity to the antenna. The antenna relies on direct "line of sight" satellite reception. If you are unsure of the chosen location, temporarily mount the antenna in the desired location to verify correct operation. If mounted close to Radar, after the GPS Chart Plotter has a fix, turn on the Radar to ensure the GPS Chart Plotter holds the fix (use the GPS Status Page). The thread used on the antenna is an industry standard (1inch 14TPI) used on a wide range of mounting brackets. Due to the manufacturing process of these mounting brackets, the antenna may not tighten all the way down onto all the threads. This is no concern however as the antenna must be tightened until the antenna stops rotating.

NOTE

The antenna cable can be cut and spliced to ease installation. Care must be taken when reconnecting the antenna cable to protect from water and corrosion.

2.3.0 Flush mounting the antenna

NOTE

Before drilling holes, it is recommended the antenna be positioned where the location is planned, cable connected to the GPS Chart Plotter and power turned On to ensure a GPS Fix is received.

1. Remove the threaded base from the antenna dome.
2. To ease installation a flush mounting template for the antenna has been included.
3. Apply the mounting template sticker to the area that was verified for GPS reception.
4. Then, drill out the 0.31" (8mm) and 0.13" (3.2mm) holes, and remove the template.
5. Insert the cable into the 0.31" (8mm) hole and route to the GPS Chart Plotter.
6. Apply a small amount of RTV to the under side of the antenna.
7. Place the antenna and then screw it into place using the screws.

NOTE

In some cases the screw may not be long enough, if this happens simply apply more RTV to the underside of the antenna to glue it into place.

2.3.1 GPS cable

The following table is to be used as a reference.

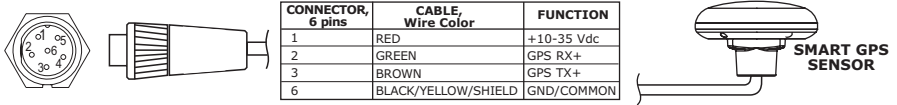

2.3.2 GPS antenna connections

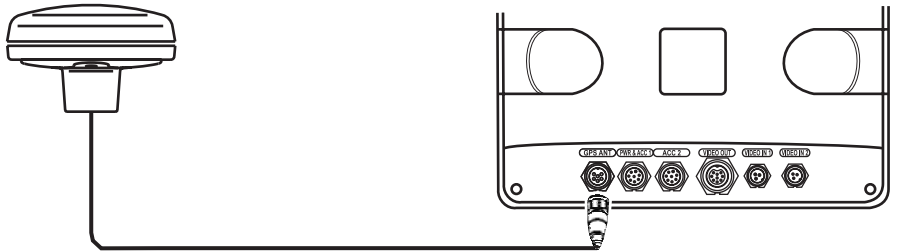

2.3.2.0 PWR & ACC 1 Cable

BATTERY CONNECTIONS

1. The CP500 is supplied with a fuse and holder. This fuse should be installed into the Black wire to protect the NMEA Output/Input circuits from becoming damaged.
2. Two Accessory cables (exactly the same cable) are supplied with the CP500.
3. Connect one of the Accessory cables to the PWR ACC 1 connector on the rear panel. The other Accessory cable is used to connect to ACC 2 connector.
4. This cable has many wires, however only the RED and BLACK wires are used to connect to a switched battery supply. Refer to the image below. For additional connections refer to NMEA connections.

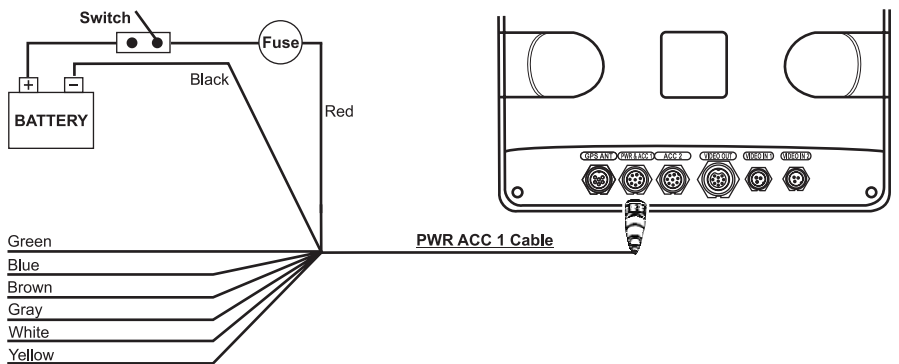

NMEA CONNECTIONS

The CP500 PWR ACC 1 connector is also used to attach NMEA devices such as AIS Receivers, digital instruments, Personal Computers, autopilots and the optional FF520 BOX FISH FINDER.

PIN	WIRE COLOR	FUNCTION	CONNECTION EXAMPLE
1	BLACK	Battery Ground	
2	RED	Battery Positive	
3	GREEN	NMEA Common	Common (ground) for NMEA devices
4*	BLUE	Port1 Input	Connect to Output of NMEA device
5	BROWN	Port1 Output	Connect to Input of NMEA device, Default is NMEA-0183 with GLL, RMB, RMC and XTE sentences
6**	GRAY	Port2 Input	Connect to Output of NMEA device
7**	WHITE	Port2 Output	Connect to Input of NMEA device, Default is NMEA-0183 with GLL, RMB, RMC and XTE sentences
8***	YELLOW	Port3 Output	Connect to Input of NMEA device Default is NMEA-0183 with APA, APB, XTE, COG and BOD sentences

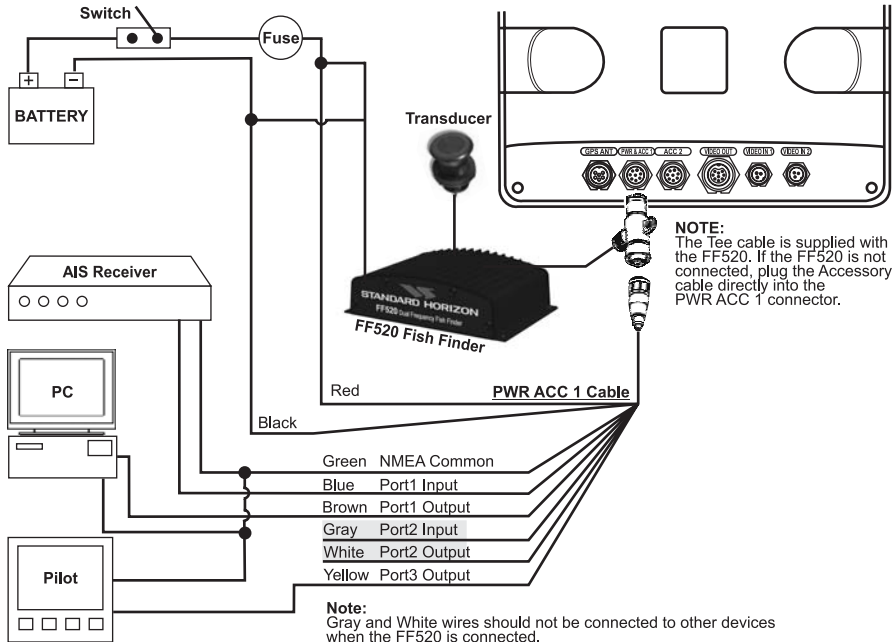

*NOTE: AIS RECEIVER OPTION (for more information on AIS refer to Section 14)

When an optional AIS receiver is connected, Port 1 of the NMEA In/Out Communication Setup menu must be changed to AIS 38400 as shown below for communications.

1. From the Chart page, press **[MENU]**. Move the ShuttlePoint knob to highlight **SETUP MENU** and press **[ENT]**.
2. Move the ShuttlePoint knob to highlight **ADVANCED SETUP** and press **[ENT]** or move the ShuttlePoint knob to the right.
3. Move the ShuttlePoint knob to highlight **IN/OUT CONNECTIONS** and press **[ENT]** or move the ShuttlePoint knob to the right.
4. Move the ShuttlePoint knob to highlight **PORT 1 INPUT** and press **[ENT]** or move the ShuttlePoint knob to the right.
5. Move the ShuttlePoint knob up/down to select **AIS 38400** and press **[ENT]** or move the ShuttlePoint knob to the right.
6. Press **[CLR]** or move the ShuttlePoint knob to the left until the Chart page is shown.

****NOTE: FF520 FISH FINDER OPTION**

STANDARD HORIZON offers an optional BLACK BOX FISH FINDER called the FF520. When connected to the CP500, Port 2 of the NMEA In/Out Communication Setup menu must be changed to FF520 as shown below for communications.

1. From the Chart page, press **[MENU]**. Move the ShuttlePoint knob to highlight **SETUP MENU** and press **[ENT]**.
2. Move the ShuttlePoint knob to highlight **ADVANCED SETUP** and press **[ENT]** or move the ShuttlePoint knob to the right.
3. Move the ShuttlePoint knob to highlight **IN/OUT CONNECTIONS** and press **[ENT]** or move the ShuttlePoint knob to the right.
4. Move the ShuttlePoint knob to highlight **PORT 2 INPUT** and press **[ENT]** or move the ShuttlePoint knob to the right.
5. Move the ShuttlePoint knob up/down to select **FF520** and press **[ENT]** or move the ShuttlePoint knob to the right.
6. Press **[CLR]** or move the ShuttlePoint knob to the left until the Chart page is shown.

*****NOTE: AUTOPILOT CONNECTION**

Care must be taken when connecting the GPS Chart Plotter to an autopilot. Normally Port 3 (Yellow wire) will be used to connect to an Autopilot input, however older autopilots may not be able to read the sentences due to the talker ID that is being used (II Integrated Instrument). If the autopilot connections are made to Port 3 (Yellow wire) and the autopilot is not reading the sentences, change the connections to Port 1 (Brown) or 2 (White) and change the sentences to APA, APB, XTE, COG and BOD.

PERSONAL COMPUTER CONNECTION / SETUP

Any of the NMEA ports can be used to send and receive Marks, Routes and tracks to PC programs.

The CP500 uses NMEA WPL and RTE sentences to share information from the PC. Refer to the table below for connection to a Serial DB9 connector.

DB9 PIN	CONNECTION	CP500
2	Receive +	NMEA Out
3	Transmit +	NMEA In
5	Signal Common	Green wire

SETTING UP THE COM PORT

The send and receive default is Port 1. To change the port follow the directions below:

1. Press **[MENU]** twice. Move the ShuttlePoint knob to highlight **ADVANCED SETUP** and press **[ENT]**.
2. Move the ShuttlePoint knob to highlight **IN/OUTPUT CONNECTIONS** and press the **[ENT]**.
3. Select **SEND/REC RTE&MARKS** and press **[ENT]**.
4. Choose the desired port number and press **[ENT]**.
5. Press **[CLR]** until the chart page is shown.

Send or Receiving RTE and WPL

1. Press **[MENU]**. Move the ShuttlePoint knob to highlight **USER POINTS** and press **[ENT]**.
2. Move the ShuttlePoint knob to highlight **Marks/Waypoints** and press **[ENT]**.
3. After the messages are sent or received a popup window will be shown.

2.3.2.1 ACC 2 CONNECTOR

This cable allows connections to a VHF, NMEA device with NMEA Output or the Input of the optional Radar antenna.

PIN	WIRE COLOR	FUNCTION	CONNECTION EXAMPLE
1	BLACK	No Connection	
2	RED	No Connection	
3	GREEN	NMEA Common	Common (ground) for NMEA devices
4	BLUE	Port4 Input	Connect to Output of NMEA device
5	BROWN	Port4 Output	Connect to Input of NMEA device. Default is NMEA-0183 with GLL, RMB, RMC and XTE sentences
6*	GRAY	Port5 Input	Connect to Output of NMEA device
7*	WHITE	Port5 Output	Connect to Input of NMEA device. Default is NMEA-0183 with GLL, RMB, RMC and XTE sentences
8	YELLOW	No Connection	

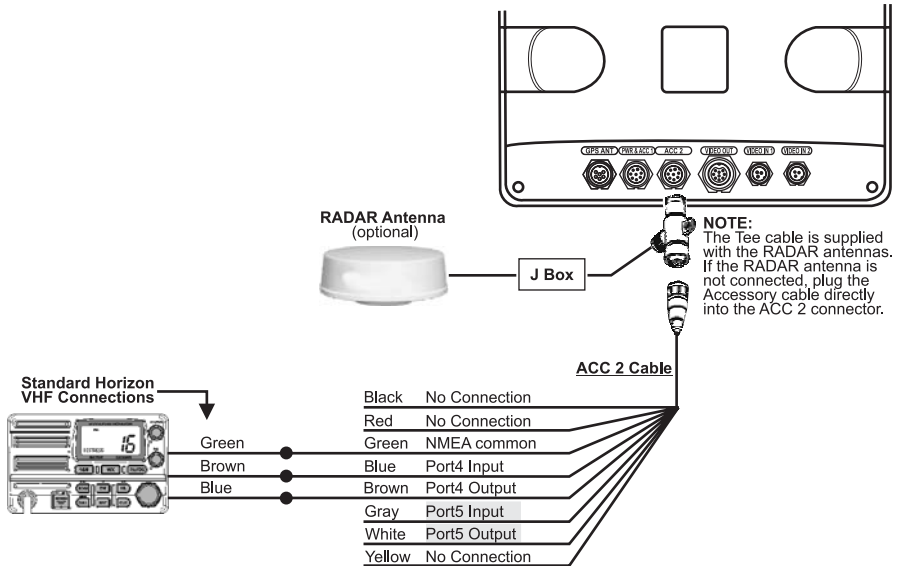

Note:
Gray and White wires should not be connected to other devices when the RADAR antenna is connected.

*NOTE: RADAR Antenna connection (optional)

When an optional Radar antenna is connected to the CP500, Port 5 of the NMEA In/Out is disabled. Contact Standard Horizon for details or refer the Radar Antenna's manual for setup details.

VHF Connections

To connect the CP500 to the above VHF wires a port will be needed to be selected. Refer to the ACC 2 connections for a connection example.

NOTE

The optional FF520 uses port 2 when connected and the optional Radar antenna uses port 5. When these optional devices are connected use port 1, 2 or 4 Input and Output to connect to the VHF radio.

Some manufacturers of DSC VHF's are not capable of receiving NMEA DSC sentences from the CP500. Refer to the Owner's Manual and confirm the VHF can receive NMEA DSC and DSE sentences.

VGA Video Output

The CP500 has:

- **One VGA output**

Allows connection to a compatible TV or monitor using the optional VGAC10 adapter cable.



VGAC10 VGA Adapter cable

- **Two NTSC or PAL Video Inputs**

NTSC or PAL video inputs allowing a camera, DVD or VCR. To connect a video source use the optional ACVC10 cable (3 pin to RCA phone adapter).

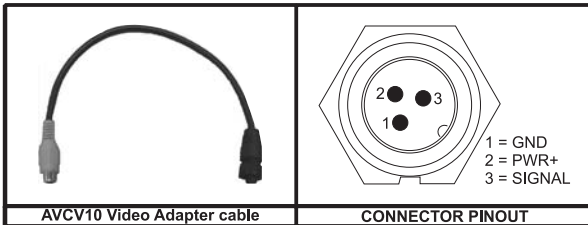

ACVC10 Video Adapter cable

CONNECTOR PINOUT

1 = GND
2 = PWR+
3 = SIGNAL

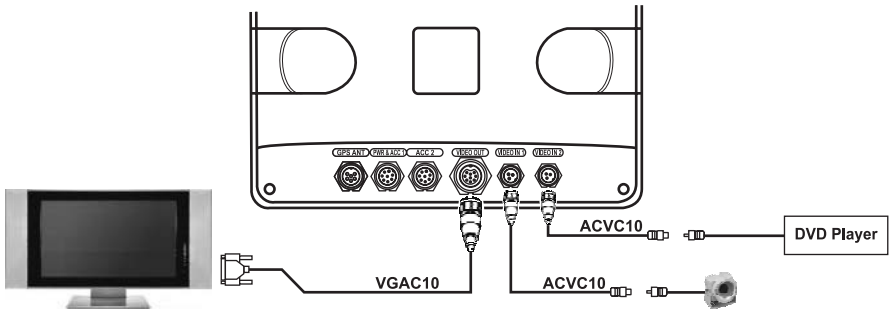

The CP500 has the capability to select the Video Input in three ways.

a) From the menu

1. Press **[MENU]** twice and move the ShuttlePoint knob to highlight **VIDEO INPUT** and press **[ENT]**.
2. A menu appears with the following options:
 - **ACTIVATE VIDEO**, the possible choices are Full Screen View, PiP (Picture in Picture) View and Auto Switch (*).
 - If **Full Screen View** is chosen, the GPS Chart Plotter will show a warning message with the instructions to adjust the image from the Video Input. If the user agrees to proceed, the image from the video input will be shown.
 - If **Picture in Picture (PiP) View** is chosen, a Video Input image can be shown on a window and placed over the selected page at full screen. By moving the ShuttlePoint knob, the PiP image is moved. When the focus is on the PiP image, press **[CLR]** to close the PiP image.

- If **Auto Switch** is chosen, all the menus will be closed and the video input will be shown switching between the Video Input Full View (if connected) and the selected page. See next section for details of setting up the switching times. If the user agrees to proceed, the image from the video input and the GPS Chart Plotter page will be shown intermittently. The intermittence time is selected by Switching Timeout item.
- **SWITCHING TIMEOUT**, the possible choices are 5,10,30 sec, 1, 5, 10 min. Allows selecting the timing to change from Video Input and GPS Chart Plotter display.
- **RESTORE DEFAULTS**, allows restoring the factory defaults for the Input picture adjustment. When Restore default is executed, the message "OK" is shown next to the selected menu item.

NOTE

If the video signal is not present on the video connector, the corresponding item in the menu will be shown in gray and will not be selectable.

b) Quick Activation by pressing [CLR] for 1 second

Pressing and holding [CLR] for 1 second from the Chart page Display or from any main page (Navigation, Highway, Celestial, GPS Status, DSC, NMEA DISPLAY); the following Soft Keys are shown: [FULL SCREEN], [PIP VIEW], [AUTO SWITCH]. **If no video signal is detected on the Video Input connector, the Soft Keys will be shown in gray and will not be selectable.**

c) Quick Activation by Soft Keys

It is possible to assign the Video Input mode to any of the Soft Keys. Press one of the Soft Keys, the Soft Keys functions are shown. Pressing and holding for 1 second one of the Soft Keys, the Soft Keys customization list will be shown. By selecting **VIDEO** option it will be possible to assign the Soft Key to execute the Video Input function. Once the Soft Key has been assigned to Video Input, its label will show the message [VIDEO]. **If [VIDEO] is pressed, the Soft Keys will be assigned this way: [FULL SCREEN], [PIP VIEW], [AUTO SWITCH]. From now on, the functioning is identical to case b).**

3. CONTROLS AND INDICATORS

3.0 CONTROLS AND CONNECTIONS

Using the keys located on the front panel controls the CP500. These labelled keys are dedicated to specific functions. As you press a key, a single audio beep confirms the key action; every time a key press is not valid, three rapid beeps sound to indicate that the key action is not valid. There is also a ShuttlePoint knob to move the cursor across the screen.

The ZOOM IN and ZOOM OUT keys

- Pressing **[ZOOM IN]** shows more detail of a smaller area, by changing the chart scale and zooming in on your display.
- Press **[ZOOM OUT]** to change the scale and show a wider, otherwise less detailed view.
- Pressing and holding **[ZOOM IN]/[ZOOM OUT]** allows for quick zoom, that is the fast change of the chart scale where only the land areas are drawn.
- When **[ZOOM IN]/[ZOOM OUT]** is released all map details are shown.

NOTE

The GPS Chart Plotter contains a Worldwide background that allows you to zoom into 2NM. For more detail, a C-MAP NT*/MAX C-CARD must be purchased and installed.

The ShuttlePoint knob

- The ShuttlePoint knob moves the cursor about on the display screen, quickly and accurately.
- It also scrolls the desired option in the menu page(s). It changes the Chart Plotter from Home Mode to Cursor Mode on the Chart Screen.
- For a detailed explanation of Cursor VS Home mode refer to Par. 3.1.1.

The ENT key

Press **[ENT]** to select the desired option or to confirm selection.

The CLR key

- Press **[CLR]** to set Home mode.
- Press **[CLR]** to exit from menu or data windows or to leave a menu without making changes, to abort selected function or to step backward from a selection made in the menu.

The MENU key

- Selects the Main Menu.
- When in the Setup Menu mode, moving the ShuttlePoint knob to the right enters a selection, moving the knob to the left clears the function.
- Press and hold **[MENU]** for 3 seconds allows you to change the fields contained within the data windows while on the Chart, Navigation, Highway, GPS Status or NMEA Display Page.
- Press and hold **[MENU]** for 3 seconds from Navigation, Highway, GPS Status, NMEA and Chart pages allows the data fields to be customize.

The GOTO key

- This key is very useful when you desire to start navigating (goto) to a destination point.
- When pressed, a popup window will be shown allowing you to select to start navigating to the position of the cursor, Mark or Route.
- To stop navigation to a point, press **[GO TO]** and select Stop on the pop-up window.

The MARK key

Places a Mark under the ships position when in Home Mode, or when the cursor is shown will place a Mark under the location of the cursor.

The ROUTE key

- When pressed places a Waypoint.
- Succeeding presses place more Waypoints to form a Route.

The PWR key and Lamp/Contrast

- Press and hold [PWR] to turn the GPS Chart Plotter On or Off.
- Once On, press [PWR] momentarily, to show the Contrast and Lamp popup window.

The MOB key

When pressed the GPS Chart Plotter automatically places a Mark on the Chart page under the boats position and all navigation is towards the position of the MOB Mark to aid in the rescue of a person that may have fallen overboard.

The INFO key

When pressed shows information on the selected point.

The Soft Keys

The 6 keys in the bottom of the front panel (hereinafter named Soft Keys) have different functions associated depending on the software: their labels are shown on the screen immediately above the keys (the user can customize the function associated).

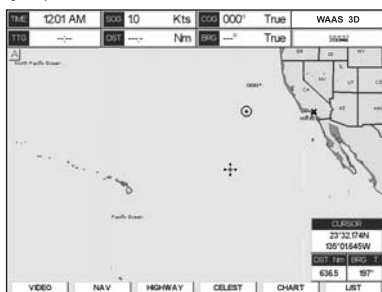

Figure 3.0 - Soft Keys

These keys allow quick selection to the many pages the GPS Chart Plotter has. These keys can be customized to your preference, however from the factory the keys are preprogrammed with the following pages. From left to right VIDEO, NAV, HIGHWAY, CELEST, CHART, LIST. Press any of the keys and you will see popup windows above the keys. To go to a specific page press the key with the desired popup window. The popup windows will automatically disappear if a key is not pressed or can be removed by pressing [CLR].

3.0.1 The alphanumeric keys

The 10 alphanumeric keys are used for entering in alphanumeric data.

For alphanumeric input: pressing the key the first time enters the first letter, the second time it enters the second letter, the third time it enters the third letter; the fourth time it enters the number. After a short time the entered character (letter or number) is confirmed and the cursor is moved to the next location.

For numeric input: to enter a number in a Lat Lon: press the key of the number you wish to enter, continue pressing the numbered keys until the Lat Lon is entered. The cursor is

moved to the next position. Pressing the ShuttlePoint knob up/down changes the value; pressing the ShuttlePoint knob left/right moves the cursor to the previous/next location.

3.1 GETTING STARTED

The Getting Started section will take you through the frequently used operations and assist you to customize the look of the GPS Chart Plotter.

3.1.0 Power On, Off and ShuttlePoint knob operation

1. Press and hold **[PWR]** until the display shows the start-up page. To turn off, press and hold **[PWR]** until the display turns off.
2. When the power is first turned on two pages the start-up page (see the following picture) and the Caution page are briefly shown before the GPS Status page.



Figure 3.1.0 - Start-Up page

3. When the GPS Chart Plotter is first turned on it will take some time for the GPS to acquire a fix of your position. Look closely at the GPS Status page and you will see satellites and relative signal strengths. After a fix is received the GPS Chart Plotter will automatically switch to the Chart page with the ships icon centered on the screen.

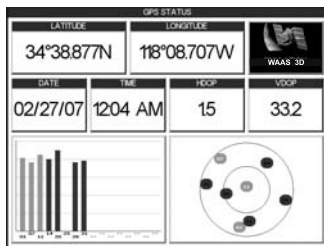

Figure 3.1.0a - GPS Status and Chart pages

4. On the Chart page the ShuttlePoint knob is used to pan around the chart. Move the ShuttlePoint knob to the left and you will notice a cross hair \pm appears, this is called the cursor.
5. When you move the ShuttlePoint knob you will notice DST and BRG values in the Data window change. This shows the Distance and Bearing from the GPS Fix of your vessel to the position of the Cursor.
6. If the cursor is moved to the edge of the screen the GPS Chart Plotter will automatically pan in the desired direction.

3.1.1 Cursor Vs. Home Mode

Cursor Mode

When the ⚓ cursor is shown on the Chart page, this is called Cursor mode.

In Cursor mode the position of the vessel will not stay in the center of the page and will move right off the edge of the screen (as your boat moves) Cursor mode allows you to pan around and look at areas on the map. In this mode you can also measure distance and bearings from your current position.

Home mode

When the Ⓢ ships icon is shown on the Chart page (cursor is not shown) you are in Home mode. Now as the ship moves through the water the vessels position will be kept in the center of the display.

NOTE

To change from Cursor mode to Home mode press **[CLR]**.

3.1.2 Cursor and Menu selection speed

The GPS Chart Plotter allows you to control the speed the Cursor moves when the ShuttlePoint knob is pressed. To change the speed:

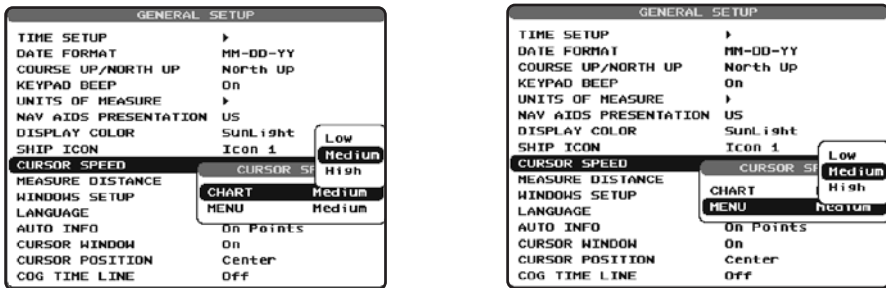

Figure 3.1.2 - Cursor Speed menu

1. Press **[MENU]**. Move the ShuttlePoint knob to highlight **SETUP MENU** and press **[ENT]**.
2. Move the ShuttlePoint knob to highlight **GENERAL SETUP** and press **[ENT]** or move the ShuttlePoint knob to the right.
3. Move the ShuttlePoint knob to highlight **CURSOR SPEED** and press **[ENT]** or move the ShuttlePoint knob to the right.
4. The menu now shows two selections, CHART and MENU which allows the Cursor Speed to be selected to High, Medium or Low on Chart page or within the menus.
5. With **CHART** or **MENU** selected, press **[ENT]** or move the ShuttlePoint knob to the right. Move the ShuttlePoint knob to the desired setting and press **[ENT]** or move the ShuttlePoint knob to the right.
6. Press **[CLR]** until the menu disappears or an easier method is to press the ShuttlePoint knob to the left a few times.
7. Move the cursor on the Chart page and see if the speed is to your liking.

3.1.3 Changing the Ships Icon

The cursor may be changed to any of the following:



Figure 3.1.3 - Ship icons

1. Press **[MENU]**. Move the ShuttlePoint knob to highlight **SETUP MENU** and press **[ENT]**.
2. Move the ShuttlePoint knob to highlight **GENERAL SETUP** and press **[ENT]** or move the ShuttlePoint knob to the right.
3. Move the ShuttlePoint knob to highlight **SHIP ICON** and press **[ENT]** or move the ShuttlePoint knob to the right to show the popup window with ship icons.
4. Move the ShuttlePoint knob to select the desired icon and press **[ENT]** or move the ShuttlePoint knob to the right to select a new icon.
5. Press **[CLR]** or move the ShuttlePoint knob to the left to exit the menu and show the Chart page.

3.1.4 Changing the backlight and contrast

With the GPS Chart Plotter is turned On, briefly press **[PWR]** to show the light and contrast popup window. Move the ShuttlePoint knob to the left or right to adjust the LCD backlight intensity or up or down to change the LCD contrast. Press **[ENT]** to set.

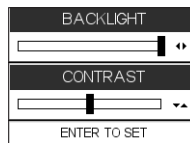

Figure 3.1.4 - Backlight and Contrast adjustment

3.1.5 Selecting North Up or Course Up

The default selection is **NORTH UP**, however you may want the top of the Chart page oriented so it will always show the area ahead of the direction your vessel is travelling which is called **COURSE UP**.



Figure 3.1.5 - Course Up/North Up menu

1. Press **[MENU]**. Move the ShuttlePoint knob to highlight **SETUP MENU** and press **[ENT]**.
2. Move the ShuttlePoint knob to highlight **GENERAL SETUP** and press **[ENT]** or move the ShuttlePoint knob to the right.
3. Move the ShuttlePoint knob to highlight **COURSE UP/NORTH UP** and press **[ENT]** or move the ShuttlePoint knob to the right.
4. Another popup window will be shown with **NORTH UP** and **COURSE UP**, move the

ShuttlePoint knob to the desired selection and press **[ENT]** or move the ShuttlePoint knob to the right.

5. Press **[CLR]** or move the ShuttlePoint knob to the left to exit the menu and show the Chart page.

NOTE

When the GPS Chart Plotter is in COURSE UP mode a small arrow icon  will be shown on the Chart page indicating the direction of North.

3.2 ADJUSTING THE TIME

The time information supplied by the GPS satellites is in Universal Time Coordinates (UTC or Greenwich England Mean Time). To change the GPS Chart Plotter to read the correct time, first you must figure out the offset and if it is daylight savings time. For example on the West coast of the United States or Pacific Standard Time the offset needed would be $-08:00$ or $-07:00$ for daylight savings time, Eastern Standard Time $-05:00$ or $-04:00$ for daylight savings time.

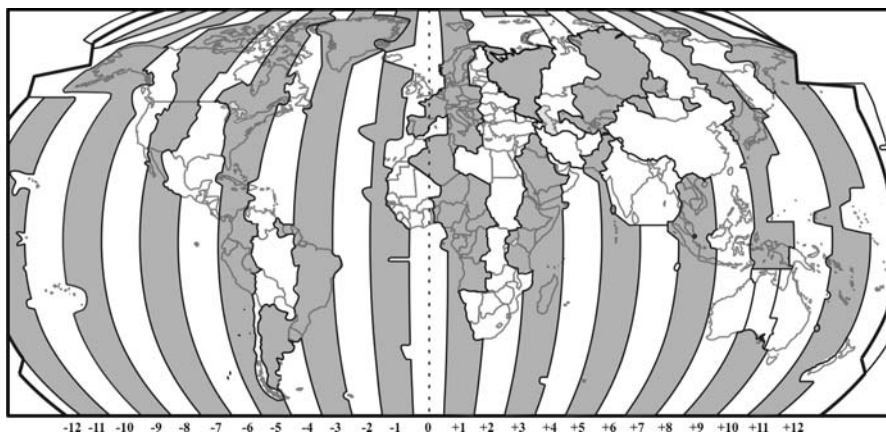

Figure 3.2 - Adjusting Time

NOTE

This map shows offset for standard time. For daylight saving time, subtract one hour from the offset time.



Figure 3.2a - Time Setup menu

1. Press **[MENU]**. Move the ShuttlePoint knob to highlight **SETUP MENU** and press **[ENT]**.

2. Move the ShuttlePoint knob to highlight **GENERAL SETUP** and press [ENT] or move the ShuttlePoint knob to the right.
3. Move the ShuttlePoint knob to highlight **TIME SETUP** and press [ENT] or move the ShuttlePoint knob to the right.
4. Move the ShuttlePoint knob to highlight **GPS TIME OFFSET** and press [ENT] or move the ShuttlePoint knob to the right.
5. Move the ShuttlePoint knob down to select **+00:00**, press [ENT] and move the ShuttlePoint knob to the right to edit the number.
6. Look at the table and find the offset for your area. You will need to enter this offset to make the GPS Chart Plotter shows the correct time.
7. Move the ShuttlePoint knob to the "+". Move the ShuttlePoint knob up or down to change to the desired offset.
8. Next move the ShuttlePoint knob to the right to select Hours and move the ShuttlePoint knob up or down to change the hour.
9. Repeat this method to change the minutes, if necessary.
10. Once you have the correct GPS time offset, press [ENT] to set.

3.3 SELECTING LORAN TD OR OTHER COORDINATE SYSTEM

The GPS Fix coordinates can be changed to show Latitude/Longitude, Loran TD's or UTM. Below is the window that will appear when customizing the Coordinate System.

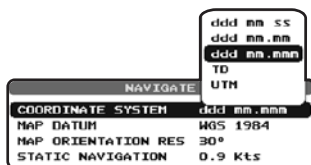

Figure 3.3 - Coordinate System menu

1. Press [MENU]. Move the ShuttlePoint knob to highlight **SETUP MENU** and press [ENT].
2. Move the ShuttlePoint knob to highlight **ADVANCED SETUP** and press [ENT] or move the ShuttlePoint knob to the right.
3. Move the ShuttlePoint knob to highlight **NAVIGATE** and press [ENT] or move the ShuttlePoint knob to the right.
4. Move the ShuttlePoint knob to highlight **COORDINATE SYSTEM** and press [ENT] or move the ShuttlePoint knob to the right.
5. Move the ShuttlePoint knob to highlight the desired coordinate type and press [ENT] or move the ShuttlePoint knob to the right.
6. Press [CLR] or move the ShuttlePoint knob to the left until the Chart page is shown.

NOTE

If the TD is selected, you should set the Chain, Pair, ASF1, ASF2 and Alter. If the TD numbers are not correct the Pair letters may be backwards. Reversing the two letters usually solves this issue. Example Y/Z change to Z/Y.

3.4 CHANGING THE CHART COLOR

The GPS Chart Plotter has preprogrammed settings allowing you to customize the look of the Chart page. The default is "Sunlight" however there are other settings; Normal, Classic and Night. Night is very useful during evening hours so not to impair night vision.

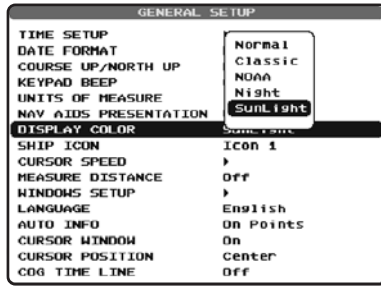

Figure 3.4 - Display Color menu

1. Press **[MENU]**. Move the ShuttlePoint knob to highlight **SETUP MENU** and press **[ENT]**.
2. Move the ShuttlePoint knob to highlight **GENERAL SETUP** and press **[ENT]** or move the ShuttlePoint knob to the right.
3. Move the ShuttlePoint knob to highlight **DISPLAY COLOR** and press **[ENT]** or move the ShuttlePoint knob to the right.
4. A popup window will be shown with Normal, Classic, NOAA, Night and Sunlight. Move the ShuttlePoint knob to the desired selection and press **[ENT]** or move the ShuttlePoint knob to the right.
5. Press **[CLR]** or move the ShuttlePoint knob to the left to exit the menu and show the Chart page.

3.5 SELECTING PAGES WITH SOFT KEYS

The Soft Keys located under the LCD are used to select the pages quickly without the need to go into the menu. The default pages are VIDEO, CHART, NAV, HIGHWAY, CELESTIAL and NMEA DISPLAY.

When one of the Soft Keys is pressed popup windows above each Soft Key are shown with the key description. Press the Soft Key with the desired page description and the GPS Chart Plotter will change to that page.



Figure 3.5 - Screen display pages

3.6 CUSTOMIZING THE SOFT KEYS

The Soft Keys can be individually customized from the default pages (discussed above) to

the following: CHART, CHART/COMPASS, CHART/HIGHWAY, NAVIGATION, HIGHWAY, CELESTIAL, GPS STATUS, DSC LOG, DSC DIRECTORY, NMEA DISPLAY, NMEA DATA, DEPTH TREND, WIND SPEED TREND, TEMP TREND, SOG TREND, MARKS/WAYPOINTS, USER C-CARD and VIDEO INPUT.

When the Optional FF520 50/200kHz BLACK BOX FISH FINDER is connected, any Soft Key can be customized to show 50 or 200kHz full page, 50 or 200kHz Chart/Fish split screen and zoom screens. Also when a SI-TEX RADAR Antenna is connected (USA only), any Soft Key can be customized to show Radar pages, RADAR FULL, RADAR CHART, RADAR OVERLAY and RADAR/FISH FINDER.

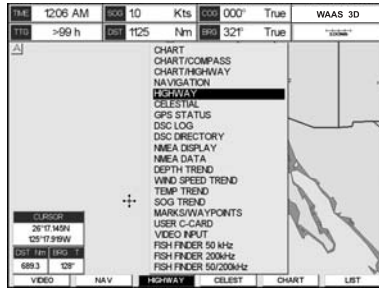

Figure 3.6 - Window options of the selected Soft Key

1. To change, momentarily press any of the Soft Keys, then press and hold the Soft Key you want to customize.
2. A popup window will be shown with the above settings.
3. Move the ShuttlePoint knob up or down to select the desired page.
4. Press **[ENT]** or move the ShuttlePoint knob to the right to save the page to the selected Soft Key.

3.7 OTHER SETTINGS IN GENERAL SETUP MENU

You will notice the **GENERAL SETUP** menu has other selections that allow you to customize:

TIME SETUP	Selects a sub-menu to allow the time setup. It is possible to set the GPS Time Offset, choosing the UTC or Local Time display, and the Time Format, switching 12 or 24 hours time format.
DATE FORMAT	Allows choosing date format MM-DD-YY or DD-MM-YY.
COURSE UP/NORTH UP	Selections are North Up (the Top of the page is fixed to North) or Course Up (the top of the page is orientated to the direction the vessel is heading).
KEYPAD BEEP	Allows the beep produced when a key is pressed to be turned on or off.
UNITS OF MEASURE	Units of Measure can be selected for Distance, Speed, Depth, Altitude and Temperature.
NAV AIDS PRESENTATION	Allows the Nav Aids presentation to be drawn using NOAA symbology when US is selected or International symbols will be used when International is selected. When selected these functions affect how the icons for Lights, Signals, Buoys and beacons are displayed.
DISPLAY COLOR	Changes the background colors of the chart page to enhance the visibility of the screen depending on the surrounding light conditions. Selections are Normal (is recommended when the GPS Chart Plotter is not exposed to the direct sunlight. When this mode is set the maps are displayed in order to use colors as similar as possible to ones used in the original paper charts), Classic (uses vivid chart colors presentation), NOAA (allows setting NOAA paper chart colors presentation), Night is recommended when the environment is dark in order to reduce the glare of the display. The GPS Chart Plotter displays maps and screen in darker colors) and Sunlight (is designed to enhance the visibility of the screen when the GPS Chart Plotter is exposed to sunlight. The maps are much brighter than in the other modes and the depth areas are filled with the white color so different depth areas are not easily distinguishable).

SHIP ICON	Allows selection of one of 5 choices of ship icons that represent your vessels position shown on the chart page.
CURSOR SPEED	Selects the preferred speed among Low, Medium and High for the cursor in the Chart page and within the menu.
MEASURE DISTANCE	When this function is turned on allows a distance to be measured between two points using the ShuttlePoint knob and [ENT] .
WINDOWS SETUP	This menu selection allows the data windows to be customized on the Chart and Navigation pages.
LANGUAGE	Allows changing the language for menus and data screens.
AUTO INFO	By default when the cursor is moved over a buoy, Mark or other item a popup window will show information of the item. This menu item allows the window to be turned On or Off.
CURSOR WINDOW	By default when the cursor is moved a window is shown with the lat/lon Distance and bearing from the vessels location to the cursor. This selection allows the window to be turned Off.
CURSOR POSITION	The position of the cursor (vessels location) can be customized so it centered in the middle or centered on the bottom of the chart page.
COG TIME LINE	Is a line projected from the vessel icon which indicates the distance your vessel will travel at the current speed. Selections are 2, 10, 30 minutes, 1, 2 hours and Infinite.

3.8 ABOUT PAGE

From Main Menu page it is possible to select an Information page containing Software, Chart and Optional devices information.

① Software System Information

② Cartography Information

③ Storage Capacity

CHARTEPLOT SYSTEM		
Copyright (C) 2007 - 2009 JEPRESEN Italia Srl		
Software	XXXXXXXX YYYY	①
HTK	V10055 R (05/10/2007)	
HEKEL	V10010 R (04/03/2008)	
FILE SYSTEM	V3270 R (05/01/2007)	
BSS	V14221 M (04/09/2007)	
GPS	Generic	
FF LIBRARY	V12000 R (04/10/2007)	
FF MODULE	Not detected	
RADAR LIBRARY	V19000 R (02/10/2007)	
RADAR MODULE	Not detected	
C-WEATHER	V19000 R (03/10/2007)	
C-CARD 1	MANA-M632.00 LOS ANGELES and SAN PEDRO BAYS	②
C-CARD 2	116 C-CARD	
User Ports	3000	③
Routes	50	
Track Ports	3000	
Tracks	5	
		
MENU for System Update Menu		

Figure 3.8 - Example of About page

1. Press **[MENU]**. Move the ShuttlePoint knob to highlight **SETUP MENU** and press **[ENT]**.
2. Move the ShuttlePoint knob to highlight **About...** and press **[ENT]** or move the ShuttlePoint knob to the right.
3. The Information page appears on the screen (see the previous Figure).
4. Press **[CLR]** or move the ShuttlePoint knob to the left to exit and show the Chart page.

4. USING FIND SERVICES & MORE FUNCTION

With an optional C-MAP NT+/MAX C-CARD installed the CP500 allows you to search for a Port Service, Port, Tide Stations, Wrecks, Obstructions, POIs, Lakes, User Points, or GPS Coordinates.

4.0 PORT SERVICES

With a C-MAP NT+/MAX C-CARD installed, the GPS Chart Plotter can find Port Services contained on the map.

1. Press **[MENU]**. Move the ShuttlePoint knob to highlight **FIND SERVICES** and press **[ENT]**.
2. Move the ShuttlePoint knob to highlight **PORT SERVICES** and press **[ENT]** or move the ShuttlePoint knob to the right.
3. A popup window will be shown with the Port Services.
4. Move the ShuttlePoint knob to highlight the desired Service and press **[ENT]**.
5. Another popup window will show the name, distance and position of the Services closest to your location.
6. Using the ShuttlePoint knob, highlight the desired Service and press **[ENT]** which will show the name and phone number of the Service.
7. Press **[CLR]** which will show the available Services at the location.
8. Press **[CLR]** to show the actual position of the Services.

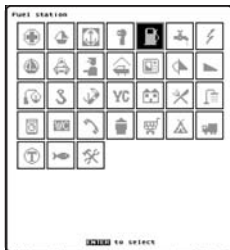

Figure 4.0 - Port Services

4.1 OTHER AVAILABLE SEARCHES

PORT	: Shows the list of all ports stored on the C-CARD in distance order. Pressing [MENU] shows the list of all ports in alphabetic order; press [MENU] again to insert the name to search.
TIDE STATIONS	: Searches for the closest Tide Station and shows the information of the selected tide station.
WRECKS	: Searches for the closest Wreck.
OBSTRUCTIONS	: Searches for the closest Obstruction.
LAKES INFORMATION	: Searches and shows information on the selected Lake.
LAKES BY NAME	: Shows the list of all lakes stored on the C-CARD in alphabetic order. Pressing [MENU] to insert the Lake name.
POINTS OF INTEREST	: Searches and shows information on the selected Point Of Interest.
USER POINTS	: Searches and shows on the Chart page the closest User Points (Marks or Waypoints).
COORDINATES	: Searches and shows on the Chart page GPS Coordinates.

4.2 INFO ON LAKES

4.2.0 Quick Info On Lakes

Upon viewing the chart of a lake, you will click on to query the available information immediately displayed with many details. For example, see the following picture:

Lakes Info icon

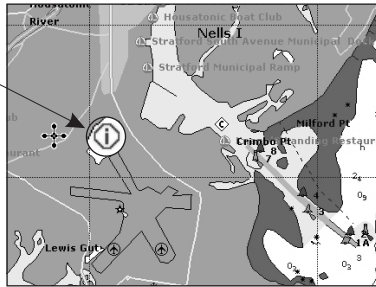

Figure 4.2.0 - Example of Lakes info

When the cursor is placed over the icon, the icons of the available services are shown:

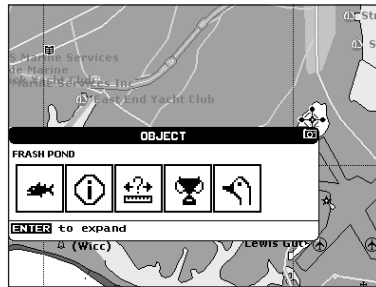

Figure 4.2.0a - Quick Info: available services

If you press **[ENT]** all available information about the cartographic point under the cursor will be shown. See the next paragraph.

4.2.1 Full Info On Lakes

The following is an example of Full Info on Lakes:

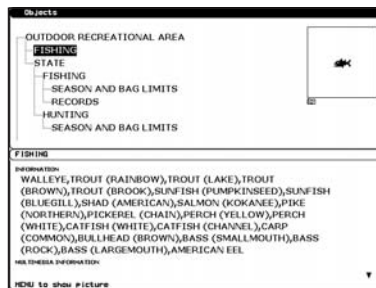

Figure 4.2.1 - Example of Full Info page

To see the "Fishing" object press **[MENU]** (when the "Fishing" object is highlighted). On the screen appears:

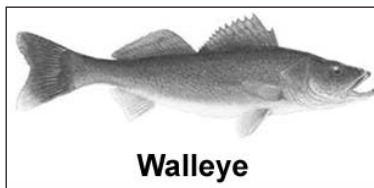

Figure 4.2.1a - Example of picture associated to the Fishing object

5. C-MAP MAX OVERVIEW

5.0 INSERTING THE C-CARD

Hold the C-CARD by the long inclined side so that you can see the C-MAP label. Open the door, gently push the C-CARD into the slot: push the C-CARD in as far as it will go, then close the door.

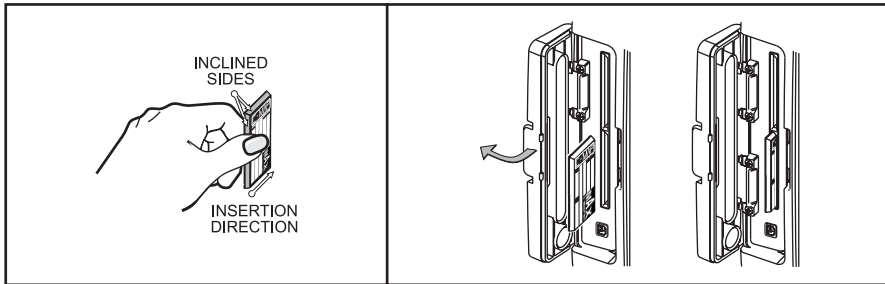

Figure 5.0a - Inserting C-CARD

C-MAP MAX is a major evolution of the NT/NT+ product technology. Key points are:

New Data Features

- Tides and Currents (intuitive arrows show direction and strength)
- World Background Charts with terrestrial data
- Value Added Data (Pictures and Diagrams, Land Data)
- Enhanced Port Info

New Presentation Features

- Clear Info (sophisticated "Human Dictionary" to translate Nav-Aid abbreviations found on paper charts)
- Dynamic Nav-Aids (an innovative and dynamic presentation mode)
- Flexi-Zoom (increased Under and Over Zoom between chart levels, resulting in optimal scale display for any situation)
- Dynamic Elevation Data (optimized palettes for GPS Chart Plotters; includes new NOAA palette)
- Perspective View ("Real World" perspective view of the chart, updated real-time during navigation)

MAX and NT/NT+ C-CARD coexistence

- When NT+ data and MAX data cover different areas, the GPS Chart Plotter receives data from both charts (depending on the current position).
- When NT+ data and MAX data cover the same area, the GPS Chart Plotter receives data only from MAX chart.

6. MAP FUNCTIONS

6.0 MAX FUNCTIONS MENU

1. Press **[MENU]**. Move the ShuttlePoint knob to highlight **SETUP MENU** and press **[ENT]**.
2. Move the ShuttlePoint knob to highlight **MAX FUNCTIONS** and press **[ENT]** or move the ShuttlePoint knob to the right. The MAX Functions menu appears on the screen:

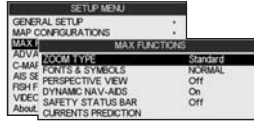

Figure 6.0 - Max Function Menu

The available Functions are described in the following.

6.0.0 Zoom Type

Allows zooming into our out on the chart page. Zoom Mode has two options; STANDARD (default) or FLEXI-ZOOM. When in FLEXI-ZOOM mode, a short **[ZOOM...]** push causes a change of chart, while a long **[ZOOM...]** push (press and hold) causes a pop-up window to be displayed on a corner of the screen. The window shows the current Zoom Factor. By pressing **[ZOOM IN]/[ZOOM OUT]** the map is expanded or compressed according to the zoom factor selected. The window is automatically closed if **[ZOOM...]** is not pressed for 2 seconds and the selected zoom factor will be used at the next zoom in/out.

To activate this function follow the procedure:

1. Press **[MENU]**. Move the ShuttlePoint knob to highlight **SETUP MENU** and press **[ENT]**.
2. Move the ShuttlePoint knob to highlight **MAX FUNCTIONS** and press **[ENT]** or move the ShuttlePoint knob to the right.
3. Move the ShuttlePoint knob to highlight **ZOOM TYPE** and press **[ENT]** or move the ShuttlePoint knob to the right.
4. The menu now shows two selections, **STANDARD** or **FLEXI-ZOOM**.
5. Move the ShuttlePoint knob to select the selection and press **[ENT]**.
6. Press **[CLR]** until the menu disappears or an easier method is to move the ShuttlePoint knob to the left a few times.

6.0.1 Fonts & Symbols

On MAX charts it is possible to set the size of all names and symbols drawn on the charts, selecting between Normal size (the regular characters size) and Large size.

To activate this function follow the procedure:

1. Press **[MENU]**. Move the ShuttlePoint knob to highlight **SETUP MENU** and press **[ENT]**.
2. Move the ShuttlePoint knob to highlight **MAX FUNCTIONS** and press **[ENT]** or move the ShuttlePoint knob to the right.
3. Move the ShuttlePoint knob to highlight **FONTS & SYMBOLS** and press **[ENT]** or move the ShuttlePoint knob to the right.

- The menu now shows two selections, **NORMAL** or **LARGE**.
- Move the ShuttlePoint knob to select the selection and press **[ENT]**.
- Press **[CLR]** until the menu disappears or an easier method is to move the ShuttlePoint knob to the left a few times.

NORMAL size

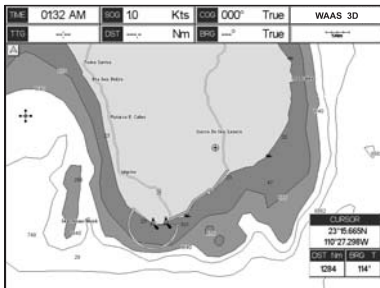

LARGE size

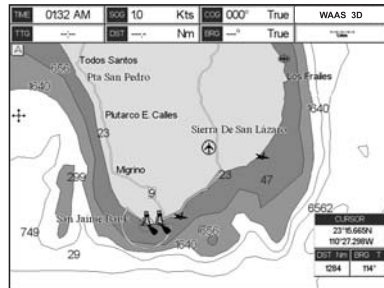

Figure 6.0.1 - Example of Normal size (on the left side) and Large size (on the right side) settings

6.0.2 Perspective View

Chart data may be projected in perspective mode during navigation. This function allows setting the panoramic View of the chart. As the upper side of the map is more compressed than the lower side, a wider map area is visible. The perspective view allows showing more chart information immediately ahead and around the cursor.

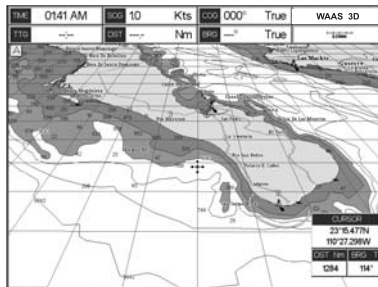

Figure 6.0.2 - Perspective View

To activate this function follow the procedure:

- Press **[MENU]**. Move the ShuttlePoint knob to highlight **SETUP MENU** and press **[ENT]**.
- Move the ShuttlePoint knob to highlight **MAX FUNCTIONS** and press **[ENT]** or move the ShuttlePoint knob to the right.
- Move the ShuttlePoint knob to highlight **PERSPECTIVE VIEW** and press **[ENT]** or move the ShuttlePoint knob to the right.
- The menu now shows two selections, **ON** or **OFF**.
- Move the ShuttlePoint knob to select the selection and press **[ENT]**.
- Press **[CLR]** until the menu disappears or an easier method is to move the ShuttlePoint knob to the left until the chart page is shown.

6.0.3 Dynamic Nav-Aids

This function allows the Nav-Aids to be turned On or Off. The blink period and color of each

Nav-aid is read from the Nav-Aid attributes available on the data cartridge. When the ship is inside the Nav-Aid nominal range, the light of the Nav-Aid will start blinking. When Dynamic Nav-Aids option is set to On, when the flashing light is Off, or when fix position is out of the sector, the light color is displayed by using in gray and will not be selectable.

To activate this function follow the procedure below:

1. Press **[MENU]**. Move the ShuttlePoint knob to highlight **SETUP MENU** and press **[ENT]**.
2. Move the ShuttlePoint knob to highlight **MAX FUNCTIONS** and press **[ENT]** or move the ShuttlePoint knob to the right.
3. Move the ShuttlePoint knob to highlight **DYNAMIC NAV-AIDS** and press **[ENT]** or move the ShuttlePoint knob to the right.
4. The menu now shows two selections, **ON** or **OFF**.
5. Move the ShuttlePoint knob to select the selection and press **[ENT]**.
6. Press **[CLR]** until the menu disappears or an easier method is to move the ShuttlePoint knob to the left until the chart page is shown.

6.0.4 Safety Status Bar (DSI - Data Safety Indicator)

When Safety Status Bar is On, a status bar with six boxes showing the status of certain functions is displayed. Any warning or alarm condition is identified by the red color to indicate possible risk.

To activate this function follow the procedure:

1. Press **[MENU]**. Move the ShuttlePoint knob to highlight **SETUP MENU** and press **[ENT]**.
2. Move the ShuttlePoint knob to highlight **MAX FUNCTIONS** and press **[ENT]** or move the ShuttlePoint knob to the right.
3. Move the ShuttlePoint knob to highlight **SAFETY STATUS BAR** and press **[ENT]** or move the ShuttlePoint knob to the right.
4. The menu now shows the following selections: **ON** (The Safety Status Bar is shown), **OFF** (The Safety Status Bar is not shown), **ICON** (The Safety Status Bar is not shown, but a Warning alarm Icon is shown on the corner of the map screen as soon as any item controlled by the DSI function returns an alarm condition. The Warning Icon remains displayed until the alarm condition persists. Placing the cursor over this Icon, a quick help message is shown next to the Icon, allowing the Safety Status Bar to be shown. In this case - when the Safety Status Bar is opened via Warning alarm Icon - it is allowed to obtain information about each "active" Safety Status box (the red ones): it is possible to select them by ShuttlePoint knob movement left/right, and a list of active alarms is shown underneath the selected box. By pressing **[CLR]**, the Safety Status Bar is removed from the screen.
5. Move the ShuttlePoint knob to select the selection and press **[ENT]**.
6. Press **[CLR]** until the menu disappears or an easier method is to press the ShuttlePoint knob to the left a few times.



Figure 6.0.4 - Safety Status Bar

Boxes definition is as follows:

- ① **Zoom**
 - Normal: when the chart is displayed at normal scale.
 - U. Zoom: red when the chart is under-zoomed out more than twice normal scale, gray otherwise.

- O. Zoom: red when the chart is over-zoomed in more than twice normal scale, gray otherwise.
- Chart Lock: red when the chart is zoomed in more than twice normal scale, gray otherwise.

NOTE

U. Zoom, O. Zoom and chart lock are used with Flexi zoom selected.

- ② **Best Map**
Red when a more detailed chart is available under the cursor position.
- ③ **Data Off**
Red when at least one of the following objects or layers is turned off (by the user): Depths/soundings; Wrecks/obstructions; Tracks/routes; Attention Areas; Nav-Aids.
- ④ **Declutter**
Displays red when clearing overlapping objects.
- ⑤ **Dangers**
Red when “Guardian Technology” detects one of the following objects: Land, Intertidal, Depth Area, Rocks, Obstructions, Shoreline Constructions, Fishing Facility, Wrecks, Dragged area, Diffusion area, Mooring facilities, Pings and Production installations.
- ⑥ **Caution**
Red when “Guardian Technology” detects cautionary or restricted area.

6.0.5 Currents Prediction

It is possible to see the variation of the Tidal arrows on the selected area at any given time.

To activate this function follow the procedure:

1. Press **[MENU]**. Move the ShuttlePoint knob to highlight **SETUP MENU** and press **[ENT]**.
2. Move the ShuttlePoint knob to highlight **MAX FUNCTIONS** and press **[ENT]** or move the ShuttlePoint knob to the right.
3. Move the ShuttlePoint knob to highlight **CURRENTS PREDICTION** and press **[ENT]** or move the ShuttlePoint knob to the right.
4. A window is shown on the high-left side of the chart.
5. Press **[INCR. TIME]** to increase the time in 30 minute increments.
Press **[DECR. TIME]** to decrease the time in 30 minute increments.
Press **[SET TIME]** to change the date and time manually.
 - a. Press Alphanumeric key or move the ShuttlePoint knob up or down to select the number in the date.
 - b. To select the next number in the Date field, move the ShuttlePoint knob to the right and repeat step a. until the date is shown.
 - c. To store the date press **[ENT]** and the Time will be selected.
 - d. Press Alphanumeric key or move the ShuttlePoint knob up or down to select the number in the Time.
 - e. To select the next number in the Time field, move the ShuttlePoint knob to the right and repeat step a. until the time is shown.
 - f. To store the Time, press **[ENT]** and Speed (SPD) and Direction (DIR) will be updated in the table.
6. Press **[Ext]**.

6.0.6 Pictures & Diagrams

Using C-Map MAX data cards allows you to show pictures or diagrams on the Chart Plotter display. These *Pictures* are typically used to facilitate the identification of cartographic objects or places around the map: they can be the landscape layout nearby a harbor, the shape of a bridge or of a buoy etc.

On some objects, such as bridges, the image associated can represent the *Diagram* representing the shape of the objects and the various characteristics (length, height, type of bridge etc.).

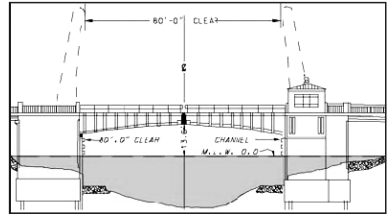



Figure 6.0.6 - Pictures and Diagrams

The pictures or diagrams can be a MULTIMEDIA OBJECT or they can be associated to a generic cartographic object, like a port marina.

How to show the pictures or diagrams of a Multimedia Object

They are shown on the chart page with the camera icon 

Move the cursor over the camera icon. You will get the quick info on the object and there will be the camera icon on the top bar of the window:

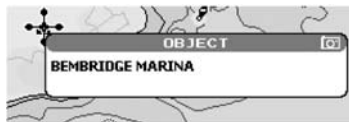

Figure 6.0.6a - Example of Quick Info on MULTIMEDIA object

Press **[IMAGE]** to show the picture. Press **[EXPAND]** to open the Full info on the object:

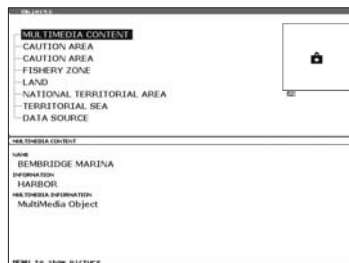

Figure 6.0.6b - Example of Full Info on MULTIMEDIA object

On the Full Info, there will be the small camera icon on a corner of the square containing the object icon.

To see the picture press **[MENU]** when the object with a picture is highlighted. When the picture is shown, it is possible to fit it to screen by pressing **[ENT]**. When the picture is shown, it is possible to change the contrast by pressing **[ZOOM IN]** or **[ZOOM OUT]**. When the picture is shown, it is possible to display the next picture associated, if any, by pressing the ShuttlePoint knob left or right.

6.0.7 Enhanced Port Info

MAX charts include additional port services that were not present before. Additional attributes of Port Areas and Port Marinas have been included (Location, Country, Region, State, Harbor master telephone number etc.).

7. CREATING MARKS

Definitions:

MARK

Can be a stand alone position or be linked to a Route. A Mark is place on the Chart page using **[MARK]** or by entering in information in the **MARK/WAYPOINTS** List **NEW MARK** selection.

WAYPOINTS

Always linked to a Route. Are placed on the Chart page using **[ROUTE]**.

NOTE

The difference between a Mark and a Waypoint is

a. When a Route is created using WAYPOINTS and the ROUTE is deleted the WAYPOINTS are also deleted.

b. If a Route is created using MARKS and the ROUTE is deleted the MARKS remain.

7.0 CREATING A NEW MARK USING THE CHART PAGE

1. Move the ShuttlePoint knob to the desired or approx. Lat/Lon and press **[MARK]**.
2. You will notice a Mark is placed under the location of the Cursor and a popup window is shown with the exact Lat/Lon of the Mark.
3. If the position is incorrect, pressing **[Edit]** allows changing of the position, Mark name, icon type and color of the icon.

- ① Mark placed under Cursor
- ② Lat/Lon of Mark, DST/BRG from vessel location
- ③ Press Soft Key to show the Marks/Waypoint List, to edit, to move or to delete Mark
- ④ Vessel location

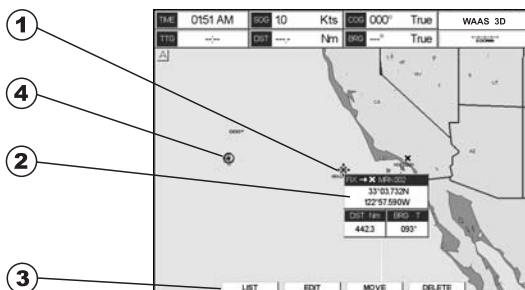

Figure 7.0 - Mark creation

NOTE

After entering in all the Marks it is a good practice to back up the points to a C-MAP User C-CARD. Refer to Section 11.

7.1 EDITING A MARK

1. If a Mark has previously been created and you wish to Edit it, using the ShuttlePoint knob move the cursor over the top of the Mark.
A popup window will be shown:



Figure 7.1 - Mark editing

- Using the ShuttlePoint knob move the cursor over the Mark. Press **[Edit]** to show the edit popup window.

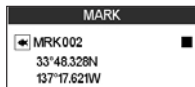

Figure 7.1a - Mark editing

- Use the ShuttlePoint knob to change to the Mark Icon, when finished press **[ENT]**.
- Move the ShuttlePoint knob to the right to select the Mark Name. Press **[ENT]** and the first digit in the name will be highlighted.
- Move the ShuttlePoint knob up or down to select the first character.
- Move the ShuttlePoint knob to the right to select the next character.
- Repeat steps 5 and 6 until the Mark name is shown. Press **[ENT]**.
- Move the ShuttlePoint knob to the right and press **[ENT]** to change the Mark Icon's Color.
- Move the ShuttlePoint knob to up/down, left/right to select the Mark Icon's Color. When finished press **[ENT]**.
- Move the ShuttlePoint knob to the right to select the Lat/Lon and press **[ENT]**.
- Move the ShuttlePoint knob up or down to select the first character.
- Move the ShuttlePoint knob to the right to select the next character.
- Repeat steps 11 and 12 until the desired position is shown. Press **[ENT]** and **[CLR]** to store the Mark.

7.1.0 Deleting a Mark or Waypoint

Using the ShuttlePoint knob, move the cursor over the Mark or Waypoint to delete. Press **[DELETE]**. A Warning popup window will be shown. Select **YES** and press **[ENT]**.

7.1.1 Moving a Mark or Waypoint

Place the cursor over the Mark or Waypoint which you want to move and press **[MOVE]**. Use the ShuttlePoint knob to move the cursor. A dotted line, connecting the previous Waypoint position to the new position, is shown:

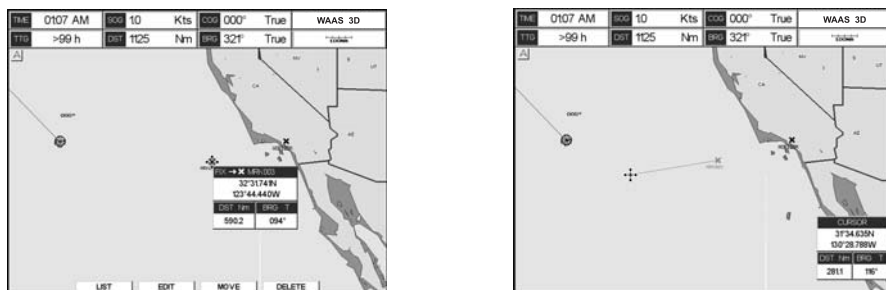

Figure 7.1.1 - Moving Mark or Waypoint (I)

Press **[ENT]** (**[CLR]** to abort the move), the Waypoint appears in the new position.

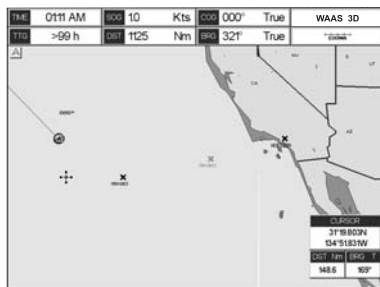

Figure 7.1.1a - Moving Mark or Waypoint (II)

7.2 MARKS/WAYPOINTS LIST

The **MARKS/WPTS** List shows all the Marks and Waypoints that have been stored into the CP500. To obtain the List page:

1. Created a Mark.
2. Place the cursor over the Mark, press **[List]**.

This page also allows you to:

ICON	Allows sorting by icon type
FIND	Searches through the Marks or Waypoints to find a point by name using the ShuttlePoint knob
LOCATE	Shows the position of a Mark or Waypoint on the Chart page
EDIT	Allows you to edit a previous stored Mark or Waypoint
NEW MARK	Allows entering in Marks, editing icon type and position
MODE	This selection controls how the Marks or Waypoints are shown on the Chart page. Selections are: a. SHOW - icon and name are shown b. ICON - only icon (no name) is shown c. HIDE - Mark or Waypoint is hidden d. SHOW ALL - All Marks or Waypoints are shown e. ICON ALL - All Icons are shown without name f. HIDE ALL - All Marks or Waypoints are hidden
DELETE	Allows deleting the selected point.
DEL ALL	Allows deleting all stored points.
SORT	Sorts the name of the Mark or Waypoint in ascending or descending order
SEND	Sends the stored points to a external device (PC) capable of listening to NMEA WPL and RTE sentences.
RECEIVE	When selected, receives points from an external device (PC) that is capable of sending NMEA WPL sentence.

NOTE

The **SEND** and **RECEIVE** functions are usually used by navigation programs running on a Personal Computer.

MARKS/WAYPOINTS						
SYM	NAME	TYPE	LATITUDE LONGITUDE	DISTANCE BECKET	MODE	
▶	DEST	MARK	4°17.230N 82°28.370W	003 003'	SHOWN	
×	HORIZON	MARK	3°19.803N 154°02.265W	076 076'	SHOWN	
×	MFK003	MARK	3°19.803N 152°28.788W	094 094'	SHOWN	

ICON FIND LOCATE EDIT SORT NEW MARK
MODE DELETE DEL ALL SEND RECEIVE

Figure 7.2 -Example of Marks/Waypoints List

7.3 CREATING/MODIFY A NEW MARK IN THE USER POINTS LIST

NOTE

This function is very useful if you have a list of Marks that you want to enter into the GPS Chart Plotter.

1. Press **[MENU]**. Move the ShuttlePoint knob to highlight **USER POINTS** and press **[ENT]**.
2. Move the ShuttlePoint knob to highlight **MARKS/WPTS** and press **[ENT]**.
3. The MARKS/WAYPOINTS List page will be shown (see previous Figure).
4. To create a New Mark, move the ShuttlePoint knob to the right to highlight **NEW MARK** and press **[ENT]**.

NOTE

In the User Point List page, you can also modify the Icon, Name, Lat/Lon and Mode to show the Mark on the Chart page.

5. Move the ShuttlePoint knob to highlight **EDIT** and press **[ENT]** to change the Icon field.
6. Move the ShuttlePoint knob to highlight the desired Icon and press **[ENT]**.
7. Move the ShuttlePoint knob to the right to select the Mark name field. Press **[ENT]** and the first digit in the name will be highlighted.
8. Move the ShuttlePoint knob up or down to select the first character.
9. Move the ShuttlePoint knob to the right to select the next character.
10. Repeat steps 8 and 9 until the Mark name is shown. Press **[ENT]**.
11. Move the ShuttlePoint knob to the right to select the Lat/Lon field and press **[ENT]**.
12. Move the ShuttlePoint knob up or down to select the first character.
13. Move the ShuttlePoint knob to the right to select the next character.
14. Repeat steps 12 and 13 until the desired position is shown.
15. Move the ShuttlePoint knob to the right to select the Mode field and press **[ENT]**.
16. Move the ShuttlePoint knob up or down to select the mode to show the Mark. You can choose among SHOW to show on the chart the name and icon of Mark, ICON to show on the chart only the icon of Mark or HIDE to hide on the Chart page the created Mark. Press **[ENT]**.
17. Press **[CLR]** and a WARNING "Save the new Mark?" popup window will be shown. Move the ShuttlePoint knob to the right or left to select **YES** or **NO** and press **[ENT]**.
18. Press **[CLR]** and the new Mark appear on the Chart page.

NOTE

After entering in all the Marks it is a good practice to back up the points to a C-MAP User C-CARD. Refer to Section 11.

7.4 GOTO CURSOR

The GPS Chart Plotter allows you to quickly start navigating to the Cursor, Route or Mark.

GOTO CURSOR

1. Move the ShuttlePoint knob to the exact position you want to navigate to.
2. Press **[GOTO]** and a GOTO popup window will be shown



Figure 7.4 - GO TO menu

3. Move the ShuttlePoint knob to highlight **CURS** and press **[ENT]**.
4. The GPS Chart Plotter is now navigating from your current position to the location selected at step 1.

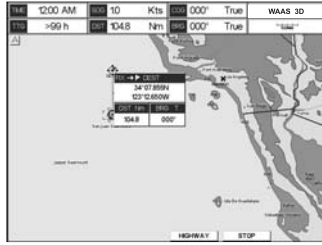

Figure 7.4a - Navigating to Cursor Example

5. Now the GPS Chart Plotter shows a bearing line between the vessels location and the destination point. A popup window shows the Distance (DST) and Bearing (BRG) from the vessels location to the destination point.
6. Two Soft Keys are also shown that allow you to quickly switch to the HIGHWAY page or to stop navigation.
7. The GPS Chart Plotter is in Cursor mode. To switch to Home mode press **[CLR]** so the vessel will stay in the center of the page.
8. To STOP Navigation, press **[GOTO]** and the WARNING page is shown. Select **STOP** and press **[ENT]**.

GOTO ROUTE

When a route is shown on the chart page, move the cursor over the designed waypoint and press **[GOTO]**. For more information about routes refer to Section 9.

GOTO MARK

1. Move the ShuttlePoint knob to an open position (no buoy, warning etc. under the cursor) on the Chart page.
2. Press **[GOTO]** to show the GOTO popup window.
3. Move the ShuttlePoint knob to highlight **MARK** and press **[ENT]** to show the MARKS/WAYPOINTS List.
4. Move the ShuttlePoint to highlight the desired Mark or Waypoint and press **[GOTO]**.
5. You will notice a circle is drawn around the Icon Symbol. This means the GPS Chart Plotter is now navigating to the point.
6. Press **[CLR]** to switch to the Chart page or Highway page to start navigating to the point.

8. MAN OVER BOARD (MOB) FUNCTION

During navigation, the “MOB” feature provides a one-touch method of storing a location, such as a point where a crew member fell overboard. In this mode, the GPS Chart Plotter places a MOB point on the Chart page and all the navigation data shown is related to navigating back to this point, allowing you to retrace your path to the MOB point efficiently.

8.0 PLACING A MOB POINT

1. On the Chart page, press **[MOB]** to start navigating back to the point. Press **[CLR]**.
2. You will notice a MOB Mark will be on the Chart page and all navigation is referring back to this point.
3. If the cursor is moved over the MOB Icon, the popup windows over Soft Keys will be shown allowing quick access to the Navigation or Highway pages.



8.1 DELETING A MOB POINT

1. Move the ShuttlePoint knob until the cursor is over the top of the MOB icon.
2. Press **[DELETE]**.
3. A popup window will be shown to confirm deleting the MOB point. Move the ShuttlePoint knob to highlight **YES** and press **[ENT]**.

9. ROUTES

The CP500 has the capability to store 50 Routes with a maximum of 50 Waypoints each. A Route can consist of Waypoints or Marks. The difference is when a Route is made using Waypoints and the Route is deleted the Waypoints are also deleted. However if a Route is made of Marks and the Route is deleted the Marks stay in memory.

9.0 CREATING A ROUTE USING WAYPOINTS

1. On the Chart page move the ShuttlePoint knob to the Lat/Lon of the starting Waypoint in the Route.
2. Press **[ROUTE]**, you will notice the Starting Waypoint  will be placed under the cursor.
3. Move the ShuttlePoint knob to the second Lat/Lon of the next leg  in the Route.
4. Press **[ROUTE]**. You will notice another Waypoint is shown under the cursor and a line joins the starting Waypoint to the Second Waypoint.

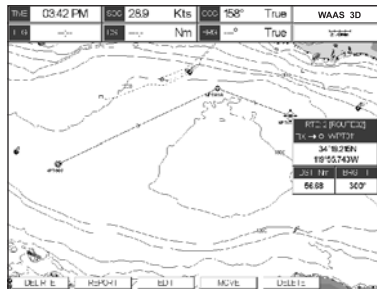

Figure 9.0 - Creating a Route using Waypoints

5. Repeat steps 3 and 4 until all Waypoints are entered into the Route.

NOTE

At this point the Route is saved as ROUTE01. If you would like to save the Route under a specific name follow the next steps.

9.1 CHANGING NAME TO A ROUTE

To name the Route:

1. Place the ShuttlePoint knob on the Route (on Waypoint or on leg) and press **[REPORT]**.
2. Move the ShuttlePoint knob to highlight **NAME** and press **[ENT]**. A popup window will be shown.
3. Move the ShuttlePoint knob up/down to change the characters and left/right to select a different character in the Routes Name.

ROUTE REPORT							
ROUTE 1	NAME	ROUTE#	SPEED: 16.0 Kts	FUEL: 16.0 Hr			
WAYPOINT	LATITUDE	LONGITUDE	SRG	LDST	TDST	TIME	FUEL
	T	W	Min	Min	Min		
WPT004	30°28.50N	159°58.32W					
WPT005	30°28.50N	159°26.08W	000°	01.0	01.0	01:06	0.1
WPT006	30°23.00N	159°26.08W	000°	107.8	238.9	02:53	2.8

NAME ROUTE#

Figure 9.1 - Route Report

4. When finished press **[ENT]** to save.
5. Press **[CLR]** to show the Chart page.

9.2 MAKING ADDITIONAL ROUTES

To create another Route the GPS Chart Plotter must be told that you want to create a second Route.

1. Press **[ROUTE]** and then **[REPORT]**.
2. Move the ShuttlePoint knob to highlight **SELECT** and press **[ENT]**.
3. Move the ShuttlePoint knob to an open Route number: example, Route 2. Press **[ENT]**.
4. Press **[CLR]**.
5. To create the new Route, follow now the steps in the previous section “Creating a Route using Waypoints”.

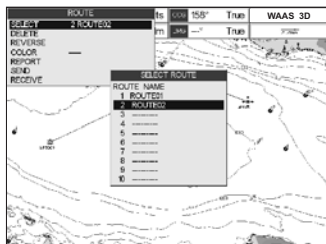

Figure 9.2 - Create additional Route

9.3 CREATING A ROUTE USING MARKS ON THE CHART PAGE

To create a Route containing Marks you first must create the Marks and show them on the Chart page.

1. Move the ShuttlePoint knob over the top of a Mark that you wish to be the starting point in the Route and press **[ROUTE]**.
2. Next move the ShuttlePoint knob until the cursor is over the Mark that you want to be the next leg in the Route.
3. Press **[ROUTE]**. You will notice a bearing line joins the first and second Mark which means these Marks are selected into the Route.
4. Repeat steps 3 and 4 until all Marks are entered into the Route.

NOTE

At this point the Route is saved as ROUTE01. If you would like to save the Route under a specific name follow the steps on the previous 9.1 paragraph.

9.4 INSERTING A WAYPOINT INTO A ROUTE

- 1a. Place the cursor on the navigation line between two points and press **[ROUTE]**.
- 1b. Place the cursor on the navigation line between two points and press **[INSERT]**.
2. Move the ShuttlePoint knob to the desired location of the Waypoint and press **[ENT]**.

9.5 GOTO A ROUTE

By having created some Routes, you can choose one of them to place a GOTO on.

9.5.0 By select Route

1. Move the ShuttlePoint knob to an open position (no buoy, warning etc. under the cursor) on the Chart page.
2. Press **[GOTO]** to show the GOTO popup window.
3. Move the ShuttlePoint knob to highlight **ROUTE** and press **[ENT]**.
4. The SELECT ROUTE popup window will be shown.

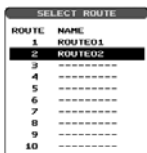

Figure 9.5.0 - Select a Route

5. Move the ShuttlePoint knob to the highlight the desired Route and press **[ENT]**.
6. On the Chart page, a circle with a Flag is shown on the first leg of the Route you chose and a navigation line is shown, indicating the GPS Chart Plotter is navigating to the first Waypoint in the Route.

9.5.1 By Cursor key

1. On the Chart page move the ShuttlePoint knob until the cursor reaches the starting point of the Route.
2. Press **[GOTO]** to start following the Route.
3. Press **[CLR]** twice to revert to Home mode.

9.6 OTHER SETTINGS IN ROUTE MENU

You will notice the **ROUTE** menu has other selections.

SELECT	Choose an available Route to create or choose a stored Route to show and follow on the Chart page.
DELETE	Deletes the Route when shown in the above SELECT menu.
REVERSE	Reverses the Route, when chosen Starting point is at the end of the Route.
COLOR	Allows changing the color of the navigation lines between in leg in the Route.
REPORT	The Route Report menu is useful to show details of the Waypoints contained within the Route. This menu also allows you to enter in your average speed and fuel consumption and calculate the approximate fuel used when following the Route.
SEND	Sends the stored points to an external device (PC) capable of listening to NMEA RTE sentence.
RECEIVE	Receive the points from an external device (PC) capable of sending NMEA RTE sentence.

10. TRACKS

The GPS Chart Plotter has the capability to store 5 individual tracks and record up to 3000 Track Points.

Before using the Track function you will need to setup the Track function that suits your boat. The Track function tracks your vessels location as it moves through the water. The Track function can be setup to lay down a Track for a predetermined time or distance interval. If you have a fast moving boat you may want to setup the GPS Chart Plotter to record a Track point every 0.5NM or if you have a sail boat you may want to setup to lay down a Track point once ever 1 minute.

NOTE

Please note the Track point memory is 3000 points. This means for a long journey you may have to adjust the time or distance to be able to track your journey. It should be noted when the 3000 Track points are used up, the first Track point layed down will be deleted when a new point is placed on the chart.

1. Press **[MENU]**. Move the ShuttlePoint knob to highlight **USER POINTS** and press **[ENT]**.
2. Move the ShuttlePoint knob to highlight **TRACK** and press **[ENT]**.
3. Move the ShuttlePoint knob to highlight **STEP UNIT** and press **[ENT]** or move the ShuttlePoint knob to the right.
4. Move the ShuttlePoint knob to highlight and choose **Dist** or **Time** and press **[ENT]** or move the ShuttlePoint knob to the right.

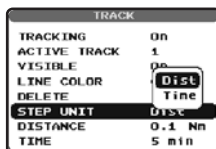

Figure 10 - Distance Units and Time Units

5. Move the ShuttlePoint knob to highlight **DISTANCE** or **TIME** step interval and press **[ENT]** or move the ShuttlePoint knob to the right.
6. Move the ShuttlePoint knob up/down to the desired step value and press **[ENT]** or move the ShuttlePoint knob to the right.
7. Press **[CLR]** or move the ShuttlePoint knob to the left until the Chart page is shown.

10.0 TRACKING

You may have to take a few trips to see how you like the Distance or Time Interval setup on the previous step. When using the tracking feature you will notice every time a Track Point is layed down on the Chart page a small filled in circle is shown on the Track line. If you move the cursor over the active track line, a popup window will be shown with the Time, Water Temperature (shown when FF520 is connected), Speed and Course Over Ground (COG): this is very useful if you are fishing and want to review the conditions where the fish were being caught.

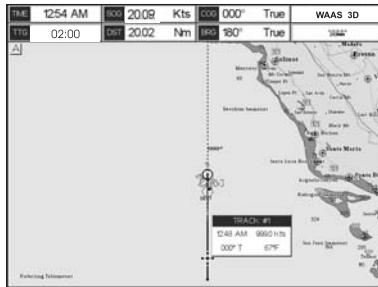

Figure 10.0 - Tracking

10.0.0 Saving and starting a new Track

A Track is automatically saved to memory. To start a new Track:

1. Press **[MENU]**. Move the ShuttlePoint knob to highlight **USER POINTS** and press **[ENT]**.
2. Move the ShuttlePoint knob to highlight **TRACK** and press **[ENT]**.
3. Move the ShuttlePoint knob to highlight **ACTIVE TRACK** and press **[ENT]** or move the ShuttlePoint knob to the right.
4. Move the ShuttlePoint knob up/down to select the next available open Track and press **[ENT]** or move the ShuttlePoint knob to the right.
5. Move the ShuttlePoint knob to highlight **TRACKING** and press **[ENT]**. Move the ShuttlePoint knob to set On and press **[ENT]**.
6. Press **[CLR]** or move the ShuttlePoint knob to the left until the Chart page is shown.
7. A new Track now will be laid down.

10.0.1 Other Settings in Track Menu

You will notice the Track menu has other selections:

TRACKING	Allows turning on or off the tracking function
ACTIVE TRACK	This selection allows you to save a Track to one of the 5 Tracks available
VISIBLE	Shows or hides a Track shown in ACTIVE TRACK menu
LINE COLOR	Selects the color of the Track line
DELETE	Deletes a Track selected in the ACTIVE TRACK menu
STEP UNIT	Allowable selection are Distance or Time
DISTANCE	Setup the Distance interval the Track point is placed on the Chart page
TIME	Setup the TIME interval the Track point is placed on the Chart page

10.1 USING THE TRIP LOG

On the Chart, Navigation, Highway and NMEA Data pages the windows may be customized to show TRIP LOG information.

1. Select one of the pages listed above, press and hold **[MENU]**. You will notice one of the data boxes will be highlighted.
2. Press **[ENT]** and move the ShuttlePoint knob to highlight **TRIP LOG**, press **[ENT]**.
3. A popup window will be shown with **Nm** (Nautical Mile), **Sm** (Statute Mile), **Km** (Kilometer) and **RESET**. Move the ShuttlePoint knob to select the desired units of measure and press **[ENT]**.

4. Press **[CLR]** or move the ShuttlePoint knob to the right until the selected page (Chart, Navigation, Highway or NMEA Data Page) is shown.

10.1.0 Resetting the Trip Log

Select the page with TRIP LOG in one of the data windows as setup in the “Using the TRIP LOG” section.

1. Press and hold **[MENU]** and press **[ENT]**, move the ShuttlePoint knob to highlight **TRIP LOG**.
2. Press **[ENT]** to show a popup window, select **RESET** and press **[ENT]**.
3. A Warning popup window will be shown to confirm if you want to reset the Trip Log. Using the ShuttlePoint knob select **YES** and press **[ENT]**. The Trip Log is now reset.

11. USER C-CARD

The Optional C-MAP User C-CARD is used to back up Marks, Routes, and Tracks stored in your GPS Chart Plotter's memory. The User C-CARD is similar to a back up disk used with a PC, in case you have to clear your GPS Chart Plotter's memory, or if you would like to transfer Waypoint, Track and Route information from one STANDARD HORIZON GPS Chart Plotter to another.

11.0 USER C-CARD MENU

C-MAP offers a special card that may be used to backup the User Points and Tracks the you have created in the GPS Chart Plotter. This optional card is similar to using a floppy disk on a PC to backup your files or to transfer the information that you have stored to a friends GPS Chart Plotter. The information shown below will assist you to transfer the User Points, Routes and Track history to the optional User C-CARD.

To open the User C-CARD page:

1. Press **[MENU]** twice. Move the ShuttlePoint knob to highlight **USER POINTS** and press **[ENT]**.
2. Move the ShuttlePoint knob to highlight **USER C-CARD** and press **[ENT]**.

- ① Number of selected Slot
- ② Number of selected File
- ③ Information on stored User Points on Internal Memory
- ④ Time of file creation
- ⑤ Date of file creation
- ⑥ Type of data contained in the file (Mark file, Waypoint file...)
- ⑦ File name

SLOT	NAME	TYPE	DATE	TIME
1	FILE01	MARKS	03/04/07	11:03:05
2	FILE01	MARKS	03/04/07	22:09:42
3	FILE01	TRACKS	03/04/07	03:11:05

Additional menu items listed on the left side of the screen:

- MRKS 3
- WPPTS 5
- RTES 1
- TRKS 2000

Figure 11.0 - User C-CARD Menu

11.0.0 Formatting the User C-CARD

1. Press **[MENU]** twice. Move the ShuttlePoint knob to highlight **USER POINTS** and press **[ENT]**.
2. Move the ShuttlePoint knob to highlight **USER C-CARD** and press **[ENT]**. A screen will appear.
3. Move the ShuttlePoint knob to highlight **FORMAT** and press **[ENT]**.
4. A popup Warning window will to confirm you want to format the User C-CARD.
5. Select **YES** and press **[ENT]** to confirm (select **NO** otherwise). The format of User C-CARD must be done before using a new User C-CARD: this operation prepares the User C-CARD to receive and store information.

NOTE

Formatting permanently erases all files previously saved on the User C-CARD.

11.0.1 Transferring files to the optional User C-CARD

1. Remove a C-MAP NT+/MAX C-CARD if present and insert the optional User C-CARD into the slot.
2. Press **[MENU]** twice. Move the ShuttlePoint knob to highlight **USER POINTS** and press **[ENT]**.
3. Move the ShuttlePoint knob to highlight **USER C-CARD** and press **[ENT]**. A screen will appear.
4. Move the ShuttlePoint knob to highlight **SAVE** and press **[ENT]**.
5. A popup **SAVE FILE** window appears. In this window you can change the Name and the file Type by using the ShuttlePoint knob.
6. To save the file, move the ShuttlePoint knob to **SAVE** in window and press **[ENT]**.
7. A Information pop window will momentarily be shown "SAVING" then show **SAVING OK**.
8. Press **[ENT]** to confirm.

11.0.2 Loading a file

If you have a problem and accidentally loose the User Points in the GPS Chart Plotter with the optional User C-CARD it is possible to load the data back into the GPS Chart Plotter using the following procedure:

1. Press **[MENU]** twice. Move the ShuttlePoint knob to highlight **USER POINTS** and press **[ENT]**.
2. Move the ShuttlePoint knob to highlight **USER C-CARD** and press **[ENT]**. A screen will appear.
3. Select the file from the User C-CARD list by using the ShuttlePoint knob and press **[ENT]**.
4. Move the ShuttlePoint knob to highlight **LOAD** and press **[ENT]**.
5. A "LOADING" message will momentarily be shown then a pop up Information window show "LOADING...OK".
6. Press **[ENT]** to confirm.

11.0.3 Deleting a file from the User C-CARD

You may want to delete a saved file on the User C-CARD.

1. Press **[MENU]** twice. Move the ShuttlePoint knob to highlight **USER POINTS** and press **[ENT]**.
2. Move the ShuttlePoint knob to highlight **USER C-CARD** and press **[ENT]**. A screen will appear.
3. Select the file from the User C-CARD list by using the ShuttlePoint knob and press **[ENT]**.
4. Move the ShuttlePoint knob to highlight **DELETE** and press **[ENT]**.
5. A popup Warning window will to confirm you want to delete the file. Select **YES** and press **[ENT]** to confirm (select **NO** otherwise).
6. Press **[ENT]** to confirm.

11.0.4 Changing the User C-CARD

You may want to change the User C-CARD inserted in the slot with a new one.

1. Press **[MENU]** twice. Move the ShuttlePoint knob to highlight **USER POINTS** and press **[ENT]**.
2. Move the ShuttlePoint knob to highlight **USER C-CARD** and press **[ENT]**. A screen will appear.
3. Open the door. Change the User C-CARD into the same slot or insert a new one into the other slot.
4. Move the ShuttlePoint knob to highlight **CHANGE** and press **[ENT]** to confirm.

12. PAGES

The GPS Chart Plotter has many pages that are designed to ease your navigation.



Figure 12 - Screen display pages

The pages can be selected in the following ways:

- **Selection by MENU**

1. Press **[MENU]**. The following page is shown on the screen:

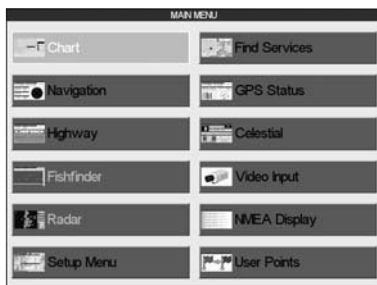

Figure 12a - Main Menu

2. Move the ShuttlePoint knob to highlight the desired page and press **[ENT]**.

- **Selection by SOFT KEY**

Press one of the Soft Keys under the display, then press the relating Soft Key to show the desired page.

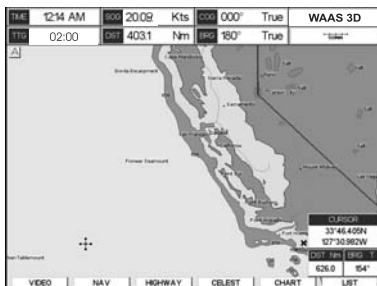

Figure 12b - Screen display pages by Soft Keys

12.0 CHART PAGE

The Chart page is the main page of the GPS Chart Plotter. From this page the user can zoom In/Out, pan around the chart, show information about cartographic objects, see the exact vessel position with the COG and SOG, place points, GOTO a destination point, show Track history etc. The GPS Chart Plotter is provided with a Worldwide background showing C-MAP NT+/MAX detail up to 2.0 NM. For more detail, optional C-MAP NT+/MAX C-CARDS are used.

- ① Fix Status
- ② Cursor coordinates
- ③ Speed Over Ground and Course Over Ground
- ④ Distance and Bearings from Fix to Cursor (if the Fix is NOT received, DST and BRG are empty)
- ⑤ Chart Scale

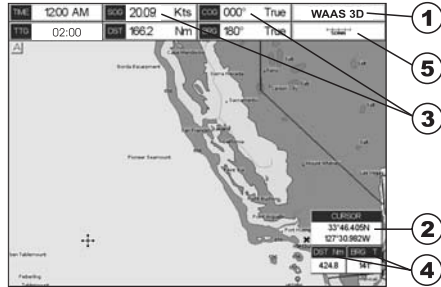

Figure 12.0 - Charts and general text area

12.0.0 Window Selections

The window on the right side of the Chart page is called the General Window and it may be edited, customized or even changed to show a highway or compass tape.

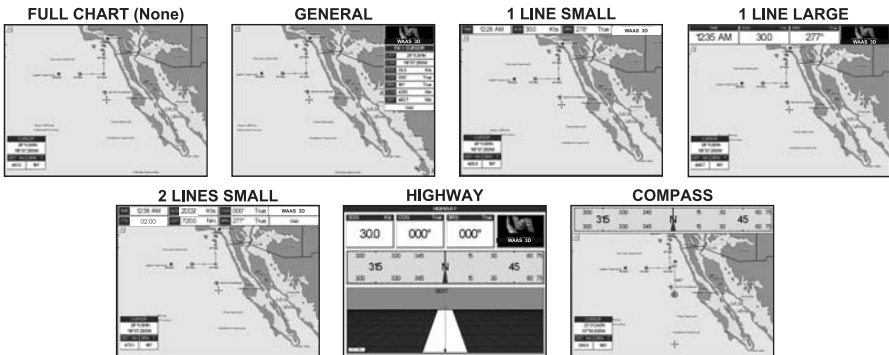

Figure 12.0.0 - Data window layout

1. To change, press **[MENU]**. Move the ShuttlePoint knob to highlight **SETUP MENU** and press **[ENT]**.
2. Move the ShuttlePoint knob to highlight **GENERAL SETUP** and press **[ENT]**.
3. Move the ShuttlePoint knob to highlight **WINDOW SETUP** and press **[ENT]**.
4. Move the ShuttlePoint knob to highlight **CHART PAGE** and press **[ENT]**.
5. Select the desired window, **HIGHWAY** or **COMPASS**, and press **[ENT]**.
6. Press **[CLR]** or move the ShuttlePoint knob to exit the menu and show the Chart page.

12.0.1 Additional Functions on Chart page

When on the Chart page, you will notice icons of Buoys, Towers, Lights, Wrecks, Tide

Stations and Port Icons. If the cursor is moved over the top of these icons a popup window will be shown with information about the icon.

12.0.2 Turning Off Information on Icon Points

The GPS Chart Plotter allows you to select to see information on points, all items or to turn this function off.

1. To change, press **[MENU]**. Move the ShuttlePoint knob to highlight **SETUP MENU** and press **[ENT]**.
2. Move the ShuttlePoint knob to highlight **GENERAL SETUP** and press **[ENT]**.
3. Move the ShuttlePoint knob to highlight **AUTO INFO** and press **[ENT]**.
4. Select the **Off**, **On Points**, or **On ALL** and press **[ENT]**.
5. Press **[CLR]** or move the ShuttlePoint knob to the left until the Chart page appears.

12.0.3 Display Mode

Selects from a pre-defined table what cartographic objects are displayed and which display options are set. Pre-programmed settings are user selectable from Full, Medium, Low, Radar (reduces the information on the display to simulate items that would be shown on a RADAR display. Please note this function is not actually showing RADAR information it is only showing what typically would be shown by a separate dedicated RADAR display) and Tides modes. Besides, the Custom mode is available as default and it is configurable by the user.

The table below shows the selections for each mode.

1. To change to one of the pre-programmed settings, press **[MENU]**. Move the ShuttlePoint knob to highlight **SETUP MENU** and press **[ENT]**.
2. Move the ShuttlePoint knob to highlight **MAP CONFIGURATIONS** and press **[ENT]**.
3. Move the ShuttlePoint knob to highlight **DISPLAY MODE** and press **[ENT]**.
4. Move the ShuttlePoint knob up or down to select the preset and press **[ENT]**.
5. Press **[CLR]** until the Chart page is shown.

Setting	Full	Medium	Low	RADAR	Tides	Custom (Default values)
Place Names	On	On	On	On	On	On
Name Tags	On	Off	Off	Off	Off	On
Nav-Aids & Light Sectors	On	No Sector	No Sector	No Sector	Off	On
Attention Areas	On	On	Off	Off	Off	Off
Tides & Currents	On	Off	Off	Off	On	On
Seabed Type	On	Off	Off	Off	Off	On
Ports & Services	On	On	Off	On	Off	On
Tracks & Routes	On	Off	Off	Off	Off	On
Depth Range Min	0 Ft	0 Ft	0 Ft	0 Ft	0 Ft	0 Ft
Depth Range Max	32805 Ft	32805 Ft	32805 Ft	32805 Ft	32805 Ft	1000 Ft
Land Elevations	On	On	Off	Off	Off	Off
Land Elevation Values	On	Off	Off	Off	Off	On
Roads	On	Off	Off	Off	Off	On
Points Of Interest	On	Off	Off	Off	Off	On
Lat/Lon Grid	On	Off	Off	Off	Off	Off
Chart Boundaries	On	Auto	Off	Off	Off	Off
Value-Added Data	On	Off	Off	Off	Off	On
Chart Lock	On	On	On	On	On	On
Mixing Levels	On	On	On	On	On	On
Underwater Ob. Limit	1000Ft	32Ft	32Ft	32Ft	32Ft	10Ft
Rocks	Icon + Depth	Icon	Icon	Icon	Icon	Icon
Obstructions	Icon + Depth	Icon	Icon	Icon	Icon	Icon
Diffusers	Icon + Depth	Icon	Icon	Icon	Icon	Icon
Wrecks	Icon + Depth	Icon	Icon	Icon	Icon	Icon

12.0.3.0 MARINE Settings

To control the display on the map of the marine features.

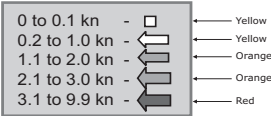
Place Names	: Turns the Local area names On or Off.
Names Tags	: Turns On or Off a tag for particular chart objects that either includes the Name of the chart object or the Depth of an Underwater chart object.
Nav Aids & Light Sectors:	Turns the presentation of Lights, Signals, Buoys and Beacons On (Nav-Aids & Light Sectors are shown), Off (Nav-Aids & Light Sectors are not shown) or No Sector (Nav-Aids are shown, Light Sectors are hidden).
Attention Areas	: Turns the displaying of Attention Areas (areas in which special attention by the mariner is required because of natural or man-made hazards sailing regulations and restrictions) On or Off.
Tides & Currents	: Turns the displaying of Tides and Currents On or Off. When data/time is available, Tidal stream arrows are shown on the charts, indicating the direction and strength of the Tide. If no data/time is available from the GPS or the GPS Chart Plotter is not in Simulation mode, the icon on the map is generic one. The color of the arrow denotes the strength of the current as follows: 
Seabed Type	: Turns the displaying of the Seabed type On or Off.
Ports & Services	: Turns the displaying of Ports and Service icons On or Off. Areas along the shore with facilities for mooring, downloading and uploading of ships, generally sheltered from waves and winds. Port installations are piers, wharves, pontoons, dry docks, cranes....
Tracks & Routes	: Turns displaying of underwater objects On or Off. Objects are obstructions, wrecks, cable etc.

12.0.3.1 DEPTH Settings

To control the display on the map of the depth informations.

Depth Range Min	: Sets the minimum depth limit to show Depth Sounding, Bathymetric Lines and Depth Area.
Depth Range Max	: Sets the max depth limit to show Depth Sounding, Bathymetric Lines and Depth Area.

12.0.3.2 LAND Settings

To control the display on the map of the terrestrial features.

Land Elevations	: Turns the displaying of Land Elevations On or Off.
Land Elevation Values	: Turns the displaying of Land Elevation Values On or Off.
Roads	: Turns the displaying to roads On or Off.
Points of interest	: Turns the displaying of Points of Information On or Off.

12.0.3.3 CHART Settings

Settings that control how the chart features will be shown on the Chart page of the GPS Chart Plotter.

Lat/Lon Grid	: Turns the displaying of the Latitude and Longitude grid lines on or off on the chart page.
Chart Boundaries	: Turns the displaying of Chart Boundaries on, off or auto mode which shows the chart boundaries of the two charts below the current scale. The chart boundaries are only show when a C-MAP NT, NT+ or MAX card is inserted into the GPS Chart Plotter.
Value Added Data	: Turns the displaying of Value added data On or Off. The Value Added Data (VAD) is a collection of additional cartographic objects which are not present on the original paper chart (from which the electronic chart derives). These objects have been obtained from other sources (that C-MAP believes to be reliable) and then merged to the electronic charts in order to provide more information useful for the navigation. VAD object can be any cartographic objects and it can be distinguished from the official-chart-objects from the Quick Info. A dedicated icon is shown on the Quick Info window to indicate that the object queried is a VAD. The same icon is also shown on the Full Info page and in addition the extended text Value Added Data is shown on the details of the VAD object.

Chart Lock (*)	: Turns the chart function On/Off. When Chart Lock is On, the available zoom scales are only the ones containing cartographic data. Instead when Chart Lock is Off, it is possible to zoom down into zoom scales not covered by cartographic data after the last available zoom scale covered by cartographic data. The DSI (Data Safety Indicator) window, if present, will show "NO CHART", when an empty level is entered in the location of map expansion mode.
Mixing Levels	: When the map coverage at the current chart scale does not fill the entire display, the GPS Chart Plotter draws the rest of the map using charts from above and below the current scale. When this function is turned on you will notice the display may redraw 2 to 3 times to show all the details.

NOTE(*)

When an empty level is entered, the message "No cartographic coverage" is shown on a window in a corner of the map display. The warning message is always displayed as long as the current zoom has no data coverage.

12.0.3.4 UNDERWATER OBJECT Settings

To control the display on the map of the Underwater Objects features.

Underwater Object Limit	: Selects the max depth value to display Underwater Objects. If value is set to 0 Feet, the Underwater Objects are not shown on the charts. Menu options are grayed out. If value is more than 0 Feet (i.e. 10 Feet), in the Range from 0 Feet to the selected value the Underwater Objects are displayed according to their setting below.
Rocks	: Sets Off/Icon/Icon+Depth* the displaying of the Rocks.
Obstructions	: Sets Off/Icon/Icon+Depth* the displaying of the Obstructions.
Diffusers	: Sets Off/Icon/Icon+Depth* the displaying of Diffusers.
Wrecks	: Sets Off/Icon/Icon+Depth* the displaying of Wrecks.

NOTE(*)

Choose the options: OFF (the object is not visible independently of the selected "Underwater Object Depth Value"); ICON (the object icon is visible without tags, in the range selected from "Underwater Object Depth Value" option); ICON+DEPTH (the object icon and tag is visible, in the range selected from "Underwater Object Depth Value" option).

12.0.4 Customizing the Map Configurations

1. Press **[MENU]**. Move the ShuttlePoint knob to highlight **SETUP MENU** and press **[ENT]**.
2. Move the ShuttlePoint knob to highlight **MAP CONFIGURATIONS** and press **[ENT]** or move the ShuttlePoint knob to the right.
3. Move the ShuttlePoint knob up or down to select the desired item within the groups Marine Settings, Depth Settings, Land Settings, Chart Settings or Underwater Object Settings and press **[ENT]**. See the previous sections for details on selections.

12.0.5 Customizing the Data Windows

The data fields contained on the General, 1 Line Small/Large and 2 Line Small data windows can be changed.

1. To change a data window field, press and hold **[MENU]** until the field is highlighted.
2. Move the ShuttlePoint knob to the desired data field and press **[ENT]**. The popup window will be shown.
3. Move the ShuttlePoint knob up/down or left/right to choose the desired setting and press **[ENT]** to select and press **[CLR]** to store and exit the editing mode.

NOTE

Data window field on the NAVIGATION, HIGHWAY, GPS STATUS, and NMEA pages may be customized in the above manner.

12.1 NAVIGATION PAGE

This page is useful to show information when heading to a destination. The default page is shown with a Compass Rose, however this can be customized to show a Compass Tape.

1. To change to show the COMPASS TAPE, select the Chart page, press **[MENU]**. Move the ShuttlePoint knob to highlight **SETUP MENU** and press **[ENT]**.
2. Move the ShuttlePoint knob to highlight **GENERAL SETUP** and press **[ENT]** or move the ShuttlePoint knob to the right.
3. Move the ShuttlePoint knob to highlight **WINDOW SETUP** and press **[ENT]** and press **[ENT]** or move the ShuttlePoint knob to the right.
4. Move the ShuttlePoint knob to highlight **NAVIGATION PAGE** and press **[ENT]** and press **[ENT]** or move the ShuttlePoint knob to the right.
5. Move the ShuttlePoint up or down to select **COMPASS TAPE** and press **[ENT]**.
6. Press **[CLR]** or move the ShuttlePoint knob to the right until the Chart page is shown.

① Fix position

② Time

③ Speed Over Ground

④ Course Over Ground

⑤ Bearing to Destination

⑥ Compass Rose

⑦ Time To Go

⑧ Distance to Destination

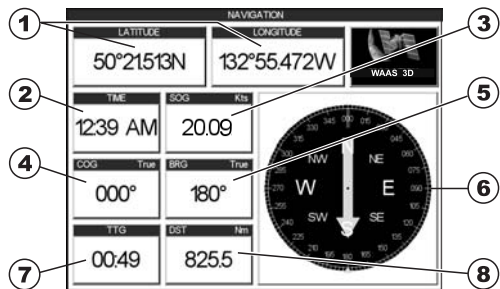

Figure 12.1 - Navigation Data page with Compass Rose

① Fix position

② Compass Tape

③ Time

④ Speed Over Ground

⑤ Time To Go

⑥ Course Over Ground

⑦ Distance to Destination

⑧ Bearing to Destination

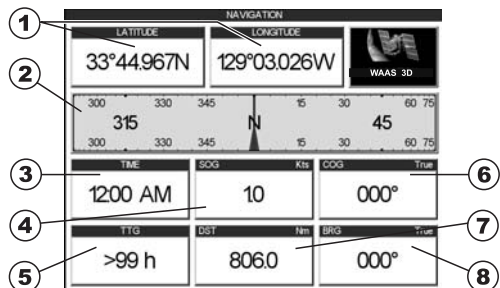

Figure 12.1a - Navigation Data page with Compass Tape

12.2 HIGHWAY PAGE

Shows a 3D view of the vessel travelling through the water when Navigating to a destination point, Mark or following a Route. Press **[ZOOM IN]** or **[ZOOM OUT]** to change the highway scale.

- ① Speed Over Ground
- ② Course Over Ground
- ③ Bearing
- ④ Compass Tape
- ⑤ Highway Display
- ⑥ Highway Scale

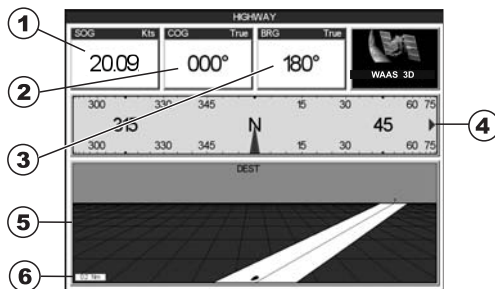

Figure 12.2 - Highway page

12.3 CELESTIAL PAGE

This page is useful for boaters that are concerned about the height of the water under a bridge or by fisherman that wish to know the tide and moon phase of a specific date.

Changing date

1. Press [ENT] and a popup window will be shown.
2. Moving the ShuttlePoint knob up/down changes the digits and left/right selects the month, day and year.
3. Press [ENT] to exit and view the information.

Changing to and from Daylight Savings time

1. Press [MARK] to toggle between Standard and Daylight Savings time.

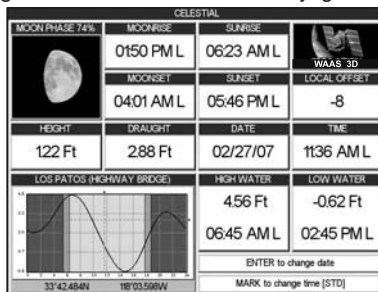

Figure 12.3 - Celestial page

12.4 GPS STATUS PAGE

This page is used as a reference to see how well the GPS is receiving satellites.

- ① Ship's Coordinates
- ② Date and Time
- ③ Horizontal Dilution of Precision
- ④ Vertical Dilution of Precision
- ⑤ Tracked, but not used, Satellite
- ⑥ Used Satellite

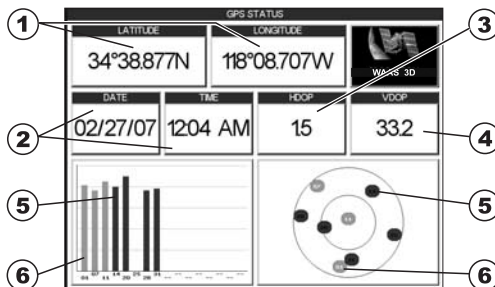

Figure 12.4 - GPS Status page

The WAAS/GPS Icon area may change due to the satellite reception:

ACQUIRING : the GPS is trying to receive a valid position fix.

GPS2D : The GPS is receiving at least 2 valid Satellites

GPS3D : the GPS is receiving at least 3 Satellites.

WAAS 2D/3D : the GPS is receiving a 2D or 3D position and the correction from the WAAS Satellite.

HDOP : Horizontal Dilution of Precision

VDOP : Vertical Dilution of Precision

From this page it is possible to disable the WAAS function following this procedure:

1. Press **[MENU]**. Move the ShuttlePoint knob to enter **GPS STATUS** page and press **[ENT]**.
2. Press **[ENT]**. The GPS SETUP menu appears on the screen.
3. Move the ShuttlePoint knob to highlight **DIFF CORRECTION SOURCE** and press **[ENT]**.
4. Move the ShuttlePoint knob to highlight **None** (to disable) and press **[ENT]**.
5. Press **[CLR]** until the menu disappears or an easier method is to move the ShuttlePoint knob to the left until the menu disappears.

12.5 NMEA DISPLAY PAGE

The GPS Chart Plotter is capable of displaying information in the customizable data windows from external NMEA devices. Depth sounder, Speed Log with temp, Wind speed and direction, Flux gate compass, and GPS information can be shown in any of the boxes. The default NMEA Display shows 3 windows. When going to a destination, this screen is useful to navigate as to get to the destination keep the Course Over Ground (COG) and Bearing (BRG) figures the same.

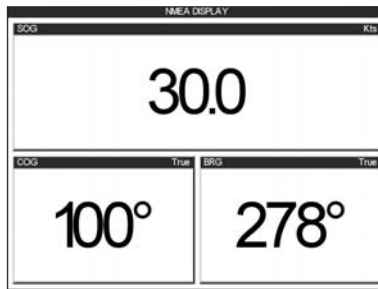

Figure 12.5 - NMEA Display page

The NMEA sentences read from external devices are: BWC, DSC, DSE, GGA, GLL, GSA, GSV, HDG, HDM, HDT, RMC, VHW, VTG, DPT, DBT, MTW, VWR, VWT, TLL, WPL, RTE.

CHANGING the NMEA PAGE Windows

1. Press **[MENU]**. Move the ShuttlePoint knob to highlight **NMEA DISPLAY** and press **[ENT]**. Move the ShuttlePoint knob to highlight **DISPLAY** and press **[ENT]**. Press the right most Soft Key twice to show the NMEA Display page (for details refer to previous 3.0.0 paragraph).
2. To see the 5 different and available pages move the ShuttlePoint knob to the left or right.

12.6 NMEA DATA PAGE

The NMEA Data Page is very useful to see if a External device (example: Depth Sounder) is transmitting NMEA sentences to the GPS Chart Plotter. This page can also be used to see if the GPS Chart Plotter NMEA output is being loaded down by a external NMEA device the GPS Chart Plotter is connected to.

Scenario: VHF Radio connected but the Radio is not receiving a GPS Position.

Usually the VHF Radio will be connected to the Green and Brown wires. To check to see if the GPS Chart Plotter is transmitting the sentences:

1. Press **[MENU]**. Move the ShuttlePoint knob to highlight **NMEA DISPLAY** and press **[ENT]**.
2. Move the ShuttlePoint knob to highlight **DATA** and press **[ENT]**.
3. Connect the BLUE Wire on the GPS Chart Plotter to the junction of the Brown wire and the VHF wire. The display should look similar to the picture below.



```
NMEA DATA
#IIRMC,002558,A,3407.643,N,07702.028,W,003.2,000.0
,190404,9.3,M#61
$PCMPN,0,1,,,,,M#6D
#TGLL,3407.643,N,07702.028,W,002558,0M#2C
#IUTG,000.0,T,009.3,M,003.2,N,005.9,K#SE
#IXTE,A,R,,,#65
#IRMB,A,,,,,U#66
#IIRMC,002559,A,3407.644,N,07702.028,W,003.2,000.0
,190404,9.3,M#67
#IRMB,A,,,,,U#66
#IIRMC,002556,A,3407.641,N,07702.028,W,003.2,000.0
,190404,9.3,M#6D
$PCMPN,0,1,,,,,M#6D
#IRPB,A,R,,,,,M#53
#TGLL,3407.642,N,07702.028,W,002557,0M#22
#IUTG,000.0,T,009.3,M,003.2,N,005.9,K#SE
#IXTE,A,R,,,#65
ZOOM IN TO CHANGE PORT          PORT PORT1
```

Figure 12.6 - NMEA Data page

12.7 NMEA DEPTH, WIND SPEED, TEMP AND SOG TREND PAGES

When the GPS Chart Plotter is connected to the Optional FF520 50/200kHz BLACK BOX FISH FINDER or a Digital Depth Sounder, Wind Speed/Direction, Speed Log with Temp with NMEA output the GPS Chart Plotter is capable of show Trends in the data from the device. To select a NMEA Trend Page:

- 1a. Press **[MENU]**. Move the ShuttlePoint knob to highlight **NMEA DISPLAY** and press **[ENT]**. Move the ShuttlePoint knob to highlight **DEPTH TREND/WIND SPEED TREND/TEMP TREND/SOG TREND** and press **[ENT]**.

12.8 VHF DIGITAL SELECTIVE CALLING

Digital Selective Calling is a semi-automated method of establishing a VHF radio call. DSC had also been designated as part of the Global Maritime Distress and Safety System (GMDSS). It is planned that DSC will eventually replace aural watches on distress frequencies and will be used to announce routine and urgent maritime safety information broadcasts.

This new system allow mariners to instantly send a distress call with GPS position (when connected to the transceiver) to the US Coast Guard and other vessels within range of the transmission. DSC will also allow mariners to initiate POSITION Request, POSITION Send calls to or from another vessel equipped with a DSC transceiver.

STANDARD HORIZON VHF Marine Radios with Digital Selective Calling are able to be interfaced with the GPS Chart Plotter which feeds GPS data to the VHF and listens for DSC calls from the VHF. By connecting a few wires between the STANDARD HORIZON VHF and the GPS Chart Plotter it will receive:

1. a vessel that has transmitted a DSC Distress call
2. a vessel that has transmitted a DSC Position Send Call
3. The position of a vessel that transmitted a DSC Position Request Call

12.8.0 DSC Distress Call

During a Distress situation, a vessel that is equipped with a DSC VHF and connected to a GPS, has the capability to transmit a DSC Distress Call with GPS Position.

When the STANDARD HORIZON VHF receives a DSC Distress Call, DSC/Position information of the vessel in Distress is transferred to the GPS Chart Plotter. The GPS Chart Plotter Logs the Distress call into the **DSC DISTRESS LOG** and also prompts the user to see the location of the Vessel in Distress and also allows for easy navigation to the vessel.

12.8.1 Position Request

STANDARD HORIZON VHF radios can transmit a DSC call to other equipped Vessels with a DSC VHF or request this radio transmit the GPS position. When this position is received the STANDARD HORIZON VHF radio sends the information to the GPS Chart Plotter which displays the GPS position of the vessel on the Chart page. This is a great feature for anyone wanting to know the position of another vessel for example you buddy that is catching fish, or finding the location of a person you are cruising with.

13. ADVANCED SETTINGS

The Advanced Setup menu allows customization of many GPS functions, Alarms and NMEA interfacing.

1. Press **[MENU]**. Move the ShuttlePoint knob to highlight **SETUP MENU** and press **[ENT]**.
2. Move the ShuttlePoint knob to highlight **ADVANCED SETUP** and press **[ENT]** or move the ShuttlePoint knob to the right.

While in this menu you will see many selections which are described in the next sections.

13.0 INPUT/OUTPUT (NMEA) CONNECTION

The CP500 has 4 NMEA inputs and 5 NMEA outputs. The NMEA outputs can be configured to send specific NMEA messages.

NOTE

After a software upgrade the RAM is cleared and then the GPS Chart Plotter starts with the default settings.
After reset is performed the Input/Out Connections menu must be configured to allow AIS and FF520 operation.

13.1 NAVIGATE

The Navigate Menu allows customization of the Coordinate System (Loran TD's), Map Datum, Map Orientation Resolution (angle the vessel has to change before the chart is redrawn) and Static Navigation. See the following table:

Coordinate System	: Selections are: a. TD: Loran TD b. UTM: Universal Transverse Mercator Grid c. ddd mm.mmm: Degrees Minutes and Thousands of Minutes d. ddd mm.mm: Degrees Minutes and Hundredths of Minutes e. ddd mm.ss: Degrees Minutes and Seconds
Map Datum	: Allows selection of Map Datums. The default Datum is WGS84 as C-MAP cartography has been compiled using the WGS84 Datum.
Map Orientation Resolution:	Sets the angle the vessel has to change before the chart is redrawn. The default setting is 30 degrees. Example: if the vessel is heading 000T at a speed of 25 Knots, the display will redraw: a. In Home mode the GPS Chart Plotter centers the location of the vessel in the center of the display. To keep the vessel in the center of the display the GPS Chart Plotter will occasionally redraw. b. If the vessel changes course greater than 330T or more than 30T the chart will be redrawn.
Static Navigation	: Sets up a threshold for the speed. When the speed received from the positioning device is under that threshold, the GPS Chart Plotter displays zero.

The Loran TD selection allows the GPS Chart Plotter to be set up so the user can enter in LORAN TD's directly into the GPS Chart Plotter. After the TD's have been entered, and the user changes to ddd mm.sss (Degrees Minutes and Seconds) the TD's will be converted to Lat / Lon coordinates.

To use the TD Coordinate System the user must setup the Chain and Pair information of the TD's. If you do not know this information, refer to paper charts that show the Chain and Pair information.

ASF1/2	: Additional Secondary phase Factor (TD Coordinate System) Correction to TD1/2 values which can be inserted by the user to take in account the additional signal propagation delay over a mixed land/seawater path compared to on all-seawater path. The user should enter delay values to fine adjust the position calculated.
Alter	: Alternate Solution (TD Coordinate System) Parameter selected by the user that is applied in the conversion of geographical coordinates Lat/Lon to TD values. To be used if the position displayed is roughly not correct.

13.2 COMPASS

The GPS Chart Plotter computes compass direction from the constellation of GPS Satellites. For the GPS Chart Plotter to compute direction the vessel must be moving through the water. This menu allows the GPS Chart Plotter to customize the following selections:

Bearings	: Selects between True and Magnetic. When Magnetic bearings is enabled, the GPS Chart Plotter applies the selected Magnetic Variation (Auto or Manual, see next paragraph) to compute True bearing.
Variation	: Allows the user to select Auto or Manual. When Auto mode is selected the GPS Chart Plotter computes the offset by the current GPS fixed location. Manual mode allows the user to enter in a magnetic variation that is applied in the True conversion.
Calibration	: This function allows a user to enter in the offset for areas that the vessel may cruise instead of entering in a manual offset for one location. This offset is useful for cruising vessels or vessels that travel internationally often.

N	N/E	E	S/E	S	S/W	W	N/W
+01°	+02°	+00°	-01°	-01°	+01°	+03°	+02°

Figure 13.2 - Compass Table

13.3 ALARMS

This menu is used to select and setup audible and visual Alarms. Available alarms are Arrival, XTE, Depth, Anchor and Grounding Alarm.

Arrival Alarm	: Alerts when the vessel is approaching a single destination point or when arriving at a leg in a Route. Available selections: 0.00 to 9.99NM.
XTE Alarm	: Alerts when the vessel is deviating from a defined course. Available selections: 0.00 to 9.99NM.
Depth Alarm	: Alerts when the received depth Value from the optional FF520 50/200kHz BLACK BOX FISH FINDER or Depth Finder inputting NMEA data into the GPS Chart Plotter is lower than the selected value. Available selections: 0000 to 3000 FT.
Anchor Alarm	: Alerts when the ships moves off a selected locations by a selected distance. Available selections: 0.00 to 9.99NM.
Audible Alarm	: Enables or disables the alarm beep.
Grounding Alarm	: This function looks ahead of the vessels heading to see if a potential danger exists. When the Grounding Alarm is enabled the GPS Chart Plotter will draw a triangle in front of the vessel on the Chart page showing the area that is being searched as shown below. The depth and range (distance) of the area the GPS Chart Plotter looks ahead for a shallow area can be set using this function.
Grounding Alarm Range	: This function allows setting the distance of the grounding alarm zone (the length of the sector to be detected) among the 0.25, 0.5, 1.0 Nm selections. When a depth or any of the searched objects is found in the scanned area, a tick marker is printed on the relative box in the Grounding Alarm Report page to identify which dangerous objects have been currently detected.
Grounding Alarm Report	: This function allows displaying a report of the dangerous objects currently detected.

NOTES

The Grounding Alarm function only operates with the new NT*/MAX C-CARDS. It also affects the

speed of the redraw of the screen. If this function is not used it may be disabled.

When any of the objects checked are found for the first time, the GPS Chart Plotter shows a pop up window to alert the user of the possible danger. The name of each new dangerous object found is reported in the warning window. In the Grounding Alarm Report page the relative item has a tick marker next to it, to identify the dangerous object currently detected. If in the next search cycle the same objects are found again, the alarm window will not be shown. Instead, if in the next searches the objects found before are no longer detected, their relevant item in the Grounding Alarm Report page is cleared (note that in this case, if the same object type is found again later, the Alarm will be shown). The GPS Chart Plotter shows an icon on the charts that identifies when a Grounding Alarm is detected.

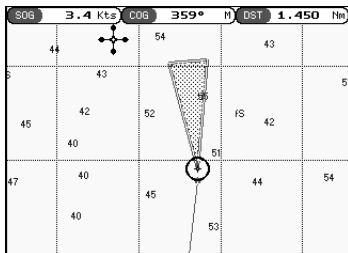

Figure 13.3 - Grounding Alarm

14. AIS

AIS is an Automatic Identification System. It has been introduced to improve the safety of navigation by assisting in the efficient operation of ship-to-ship location reporting and VTS applications. The system should enable operators to obtain information from the ship automatically, requiring a minimum of involvement of ship's personnel, and should have a high level of availability. AIS transponders installed on IMO vessels use VHF frequencies to:

- Transmit details of their own vessel
- Receive details from other vessels or navigation aids within VHF range.

Information being transmitted from vessels over 300 tons that, due to recent worldwide legislation, are required to fit Class "A" AIS transponders.

Connecting to the GPS Chart Plotter an AIS receiver (please contact your local dealer), will display vessels with AIS transponder within VHF range on screen giving the skipper or navigator a visual interpretation of the data of nearby vessels. This improves safety, and specifically for collision avoidance reasons.

14.0 AIS SYSTEM DEFINITIONS

- **Target:** It is a vessel equipped with AIS. Information about the targets is being received by AIS Receiver and displayed on the screen.
- **CPA:** Closest Point of Approach is the closest distance that will be achieved between your vessel and the tracked target, based on your vessel's speed and direction and the target's speed and direction.
- **CPA Limit:** This is the distance from your vessel that a target may reach before a target is deemed a threat.
- **CPA Alarm:** Occurs if CPA is less or equal to CPA Limit. This test is done for active targets only.
- **TCPA:** Time to closest Point of Approach is the time remaining until the CPA will occur.
- **TCPA Limit:** This is the time remaining before the CPA is reached.
- **TCPA Alarm:** Occurs if TCPA is less or equal to TCPA Limit. This test is done for active targets only and if CPA value is less or equal to CPA Limit.
- **Radio Call Sign:** International call sign assigned to vessel, often used on voice radio.
- **Name:** Name of ship, 20 characters.
- **MMSI:** Maritime Mobile Service Identity.
- **MMSI number:** A unique 9 digit number that is assigned to a DSC radio station. It primarily registers the boat information in the U.S. Coast Guard's national distress database for use in emergency situations.
- **Active Target:** Target located within the Activation Range. Active target is represented by oriented triangle with COG and Heading vectors. Rate of turn may also be displayed.
- **Dangerous Target:** Target detected by CPA or TCPA Alarm. Dangerous target is Active Target by definition. For better visibility Dangerous Target symbol is flashing.
- **Sleeping Target:** Target located outside the Activation Range. Sleeping target is represented by a small oriented triangle.
- **Lost Target:** When the AIS info is not received from that vessel for 3.5 minutes. The presentation will be a flashing black triangle with a cross through.
- **Activation Range:** Range around your boat where targets become active. AIS target become active within this range. Activation Range should be greater than CPA Limit by definition.

NOTE

A target is removed from the screen if data is not received for 10 minutes.
The maximum number of tracked targets is 100.
Depending on the scale the presentation of the targets change to remove clutter on the screen. This information is updated every 3 seconds to 6 minutes depending on speed and rate of turn, enabling the track of the vessels in range to be plotted.





TARGET STATUS	DESCRIPTION	SYMBOL
ACTIVE TARGET	Target located within the Activation Range.	
DANGEROUS TARGET	Target detected by CPA or TCPA Alarm. Dangerous Target is Active Target by definition.	
SLEEPING TARGET	Target located outside the Activation Range.	
LOST TARGET	Ais info is not received from that vessel for 3.5 minutes.	

Figure 14.0 - AIS Symbols

14.1 AIS MENU

To configure the GPS Chart Plotter to receive AIS data, follow the procedure:

1. Press **[MENU]**. Move the ShuttlePoint knob to highlight **SETUP MENU** and press **[ENT]**.
2. Move the ShuttlePoint knob to highlight **AIS SETUP** and press **[ENT]** or move the ShuttlePoint knob to the right. The new AIS menu appears on the screen. The available functions are described in the following table.

Display	: Turns the display of AIS Targets overlay on the cartography On or Off.
Activation Range	: Defines the range from the fix within which the AIS Target becomes active. The values allowed are from 0.1 to 20 Nm.
CPA Alarm	: Turns On or Off the alarm.
CPA Limit	: The values allowed are from 0.1 to 10 Nm.
TCPA Alarm	: Turns On or Off the alarm.
TCPA Limit	: The values allowed are from 1 to 30 Min.

14.2 TO SET THE CHART PLOTTER FOR RECEIVING AIS

Refer to Connections/PWR AUX 1 NMEA connections section on page 16.

14.3 QUICK INFO ON AIS TARGET

By placing the cursor over a AIS Target icon using the ShuttlePoint knob, the following information is displayed:

- Vessel Name
- MMSI number
- Radio Call Sign
- SOG
- COG
- CPA and TCPA values

NOTE

The selected AIS Target icon is surrounded by a square frame when user places the cursor over the icon.

15. C-MAP WEATHER SERVICE

C-MAP Weather Service is an innovative meteorological forecasting system with the ability to visualize the weather forecast, overlaying it on cartography. The weather data is held on C-MAP's weather server, which can be accessed via a C-COM modem connected to the GPS Chart Plotter or by using the C-MAP personal Suite saving the weather data on a User C-CARD. The weather data are overlaid on a map page as layers.

NOTE

For availability of this service, contact your local C-MAP office or dealer.

The Weather format data available are:







Data Type	Display
WIND (Speed & Dir)	- 0 ➔
WAVE (Height & Dir)	- 1 ➔
TEMPERATURE (C°)	18°
HUMIDITY (%)	30
VISIBILITY (m)	20
WEATHER TYPE: Sun	
WEATHER TYPE: Rain	
WEATHER TYPE: Fog	
WEATHER TYPE: Snow	
WEATHER TYPE: Clouds	
WEATHER TYPE: Partly Cloudy	
WEATHER TYPE: Thunderstorm	

Figure 15 - Weather data package

WARNING

Please check with Local C-MAP Office for the actual C-WEATHER coverage of your area.

15.0 C-MAP WEATHER SERVICE MENU

To select the menu:

1. Press **[MENU]**. Move the ShuttlePoint knob to highlight **SETUP MENU** and press **[ENT]**.
2. Move the ShuttlePoint knob to highlight **C-MAP WEATHER SERVICE** and press **[ENT]** or move the ShuttlePoint knob to the right.

The C-MAP Weather menu is shown on the screen, the items are described in the following paragraphs.

15.0.0 Load From File

Allows the whole data package C-Weather loading from the User C-CARD.

15.0.1 Forecast

Allows selecting the Layer of specific weather data to be displayed on the screen and to change date and time of the forecast preview. The following functions are available:

- **Panning:** default usage of the cursor key is the normal panning function.
- **Zoom in/out:** zoom in/out functions are allowed as usual by using **[ZOOM IN]/[ZOOM OUT]**.
- **Set of date and time:** to modify date and time. Press **[DATE/TIME]**.
- **Data Type:** to cycle of the weather data among the following layers: Wind, Wave Data, Wheater, Humidity, Temperature, Visibility. Press **[TYPE]**.
- **Exit:** to exit the Weather mode. Press the **[EXIT]**.

15.0.2 Real Time View

The following selections are available:

- **Real Time View On:** the data is shown (the area of the download) at the current date and time (received from the GPS).
- **Real Time View Off:** the Weather data is not displayed.

The layer displayed is the one selected into the previous menu item.

15.0.3 Type of Data

Allows selecting the type of data among: Wind, Wave Data, Wheater, Humidity, Temperature, Visibility.

16. TROUBLESHOOTING

The GPS Chart Plotter does not turn On. The voltage or the polarity may not be correct. Make sure that the correct voltage (10-35 volt dc) is present. Check also that the polarity is correct.

The GPS Chart Plotter does not get a valid fix. The GPS WAAS Smart Antenna may not be in an open sky position or the antenna cable may not be properly connected. Make sure that no metal obstacle is placed around the antenna acting as a shield for the antenna and disconnect and connect again the antenna cable to the GPS Chart Plotter. If, after 15 minutes, the GPS Chart Plotter does not get the fix, turn it Off and On again.

The GPS Chart Plotter does not turn Off. Pressing [PWR] (for at least 3 seconds) the GPS Chart Plotter does not turn Off, turn Off the voltage. Perform RAM clear. Refer to section 17.0.0 RAM Menu (reset).

The GPS Chart Plotter screen becomes very dark after a long exposure to direct sunlight. The internal temperature is very high. Control the contrast. Protect the GPS Chart Plotter from direct sunlight.

The GPS Chart Plotter does not respond to any command. Try to turn Off, and then turn On. If the problem persists, reset the RAM (refer to section 17.0.0 RAM Menu (reset)) or remove power from the battery.

The location of my fix is not shown correctly on the Chart page. This is usually caused when C-MAP Geo-References a nautical chart. Contact C-MAP with the Latitude & Longitude of your vessels position, the position where you think your vessels should be and with details of the cartography areas, which can be seen by selecting the Chart page, press [INFO], move the ShuttlePoint knob to **Data Source** and press [ENT]. Write down the "Compilation scale", "Notice to mariners" and "Horizontal datum". Next contact C-MAP USA at 508/477-8010 and advise the problem.

After storing the Chart Plotter over the winter, it takes a long time to receive a fix. This is usually caused by the internal rechargeable memory battery from becoming low which could cause the Internal RAM memory to become corrupted. To solve this issue, perform a RAM clear (refer to Section 17).

NOTE

After performing a RAM Clear all Marks, Routes and tracks will be erased. To back up these points refer to Section 11 for details.

17. TECHNICAL TESTS

17.0 SYSTEM TEST

If you have connected your GPS Chart Plotter according to the instructions, and chosen the proper menu selection for your device, and are still having problems with your GPS Chart Plotter, the extended auto-test should help determine the problem. Make sure the GPS Chart Plotter is turned Off. While pressing and holding **[CLR]**, turn the GPS Chart Plotter On. A new menu will appear on the display:

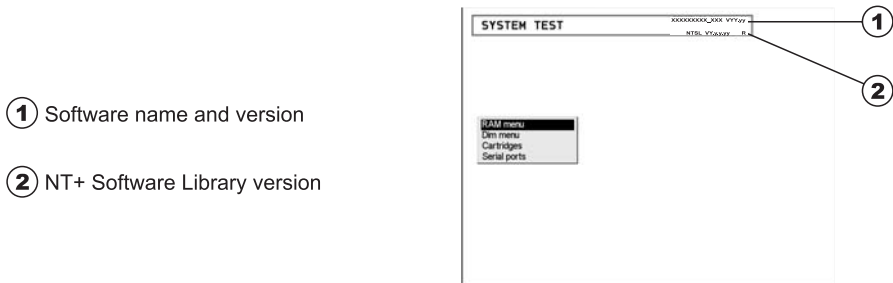

Figure 17.0 - System Test

Use the ShuttlePoint knob to select the desired test. Choose the test, press **[ENT]**. To exit from any submenu press **[CLR]**. To exit from the System Test turn Off the GPS Chart Plotter.

17.0.0 RAM Menu (reset)

NOTE

After performing a RAM Clear all Marks, Routes and tracks will be erased. To back up these points refer to Section 11 for details.

This test verifies the integrity of the memories and if desired during this test all the internal memory can be erased and the default setting restored.

RAM Clear

To clear internal memory. If the GPS Chart Plotter exhibits unusual operations, or appears to be malfunctioning, it may be possible to correct the problem by clearing RAM. This operation will erase all Marks, Routes, stored Track plots and Destinations. It will also return all selections (Input Data Format, Autopilot selection, etc.) to original default values. To confirm clear RAM press **[ENT]** again (but if at this time you do not wish to clear RAM press **[CLR]**).

17.0.1 DIM Menu

To select the desired value for brightness and keypad light.

Contrast

Each time you move the ShuttlePoint knob to right, the screen will decrease brightness, move it to the left to increase brightness.

Backlight

The second option allows to set the backlight. Operates in similar mode as Contrast.

17.0.2 Cartridges (used by Standard Horizon Technicians)

To check the C-CARD and its connector.

Internal Data Base Test

To test the WorldWideBackground.

C-CARD Test

To test the C-CARD. There are the possible situations:

1. if there is a C-CARD inserted in the slot and there is not a malfunction, the name of the C-CARD zone and the message "OK" are shown.
2. if there is a C-CARD inserted in the slot, but it is a defective C-CARD, the name of the C-CARD zone and the message "Faulty" are shown.
3. if there is not any C-CARD inserted in the slot, the message "not present" is shown.
4. if there is a User C-CARD inserted in the slot, the message **USER C-CARD** is shown.

C-CARD Connector

Indicates if there is a malfunction in the connector.

17.0.3 Serial Ports (used by Standard Horizon Technicians)

If you are having problems receiving data from the position-finding instrument, this test should help determine the problem.

Change Parameters

To change the parameters of the serial interface. This menu allows to select the **Port** (Signal Source) between PORT 1, PORT 2, PORT 3; the **Baud Rate** between 300, 1200, 2400, 4800, 9600, 38400, 115200; the **Data Bits** (Word Length) between 7 or 8, the **Parity** between even, odd or none, the **Stop Bits** between 1 or 2. Default settings are: Port = PORT 2, Baud Rate = 4800, Data Bits = 8, Parity = none, Stop Bits = 1.

Input Data Display

To allow the GPS Chart Plotter to act as a computer terminal and display the incoming data exactly as it is received.

If the data displayed on the screen is unrecognizable, you may have selected the wrong input parameters for your particular receiver, for example, Baud Rate 9600 instead of Baud Rate 4800. Check your receiver manual to be sure that you have selected the proper parameter. If the screen is blank, you may have a broken connection, and no data is being received or you may have connected the device to the other input port.

Use **[ZOOM IN]** to stop (or continue after pause) data displaying, **[ENT]** to show data in hex or ASCII mode (normal or small) and **[CLR]** to exit.

Loop-Back Test

This is a special test done during the production phase to check the serial ports integrity. A special connector is required.

18. SPECIFICATIONS

Power Consumption	: 1.5A max @12V WITH EXTERNAL GPS and TWO VIDEOCAM CONNECTED
Power supply	: 10-35 Volt DC
Interface	: Input/Output Interface NMEA-0183
Display	: TFT Color LCD (<i>active area 12"</i>) sunviewable technology
Display Resolution	: 800 x 600 pixels
Cartography	: C-MAP NT*/MAX C-CARD
Operating temperature range	: 32°F/+131°F (0°C/+55°C)
Storage temperature	: -4°F/+158°F (-20°C/+70°C)
Keyboard	: Silicon rubber, backlight
Weight (without bracket)	: 6,6 lbs (3000 gr)
User Points (Marks/Waypoints)	: 3000
Routes	: 50 (max 50 Waypoints each)
Track Points	: 3000 (recordable in 5 Tracks)
NMEA Output sentences	: GLL, VTG, BWC, WCV, APA, APB, HDG, BOD, XTE, RMA, RMB, RMC, GGA, HSC, DBT, DPT, MTW, VHW.
NMEA Input sentences	: BWC, DBT, DPT, DSC, DSE, GGA, GLL, GSA, GSV, HDG, HDM, HDT, MTW, MWD, MWV, PCMPA, PCMPD, PJRCD, PJRCF, PKODG, RMC, RTE, TLL, VDM, VHW, VTG, VWR, VWT, WPL

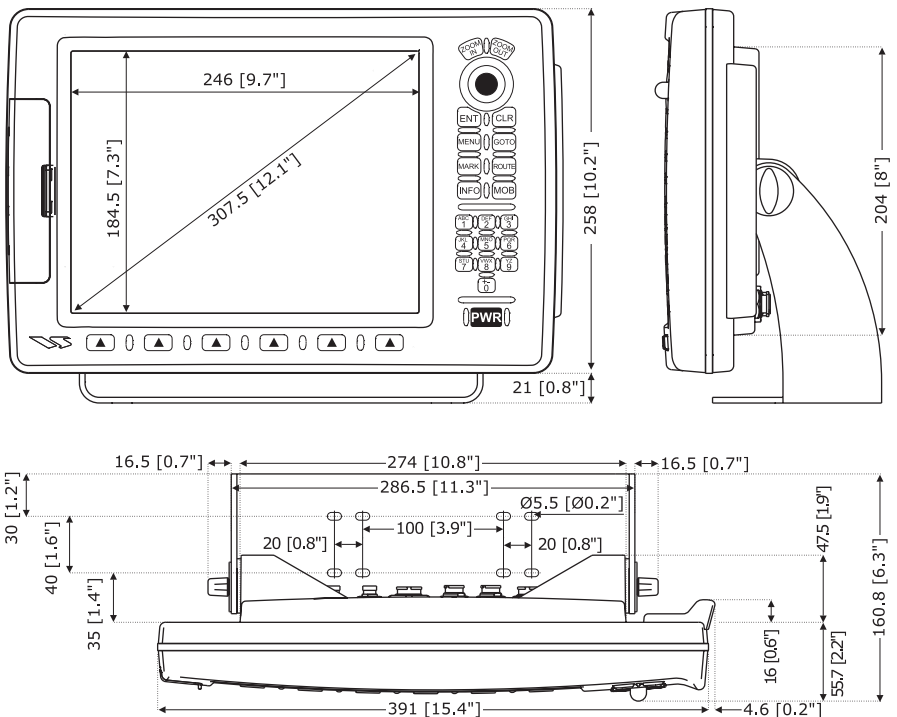

Figure 18 - CP500 Dimensions [mm/inch]

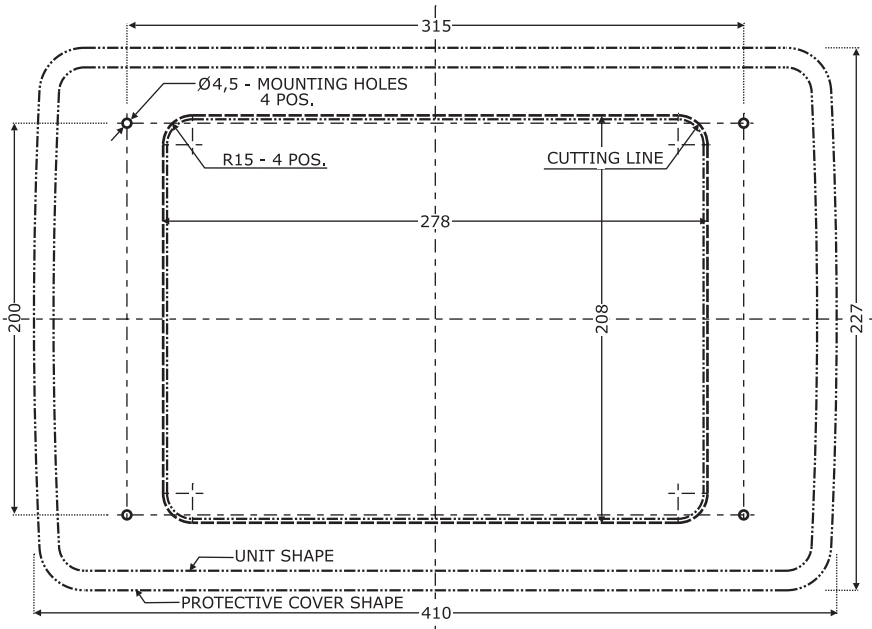

Figure 18a - CP500 Flush Mount cutout (Dimensions are in mm)

18.0 GPS WAAS SMART RECEIVER SPECIFICATIONS

This GPS WAAS Smart Receiver is based on a ultimate GPS engine that delivers accuracy better than three meters by decoding the GPS correction signals from the satellite-based WAAS (*Wide Area Augmentation System*). The GPS engine, interface electronics and the passive antenna are enclosed inside the water-proof plastic housing. This provides advanced state of the art GPS performance in an easy to use package.

Physical Characteristics

Color	Ivory white
Dimensions	97mm in diameter x 32mm in height (flush mounted) or 61,5mm on flag-pole mount
Weight (without cable)	0,35 lb (160 g)
Cable	white 15 meter 8x28AWG cable with 6 pins female connector

Electrical Characteristics

Input Voltage	10 Vdc to 35 Vdc unregulated
Input Current	0.8 Wmax
GPS Receiver Sensitivity	-143 dBm (typical)

GPS Performance

Receiver	WAAS (North America), EGNOS (Europe), MSAS (Asia)
Geodetic Datum	WGS84
Channels	16
Frequency	1575.42MHz (L1, C/A code)

Acquisition Time

Reacquisition	< 1 second
Hot Start	< 3.5 seconds
Warm Start	< 33 seconds
Cold Start	< 40 seconds

Accuracy

GPS	< 2.5m
DGPS	< 2.0m

NMEA Output

Messages	GGA, RMC, GSA, GSV, TXT
----------	-------------------------

19. APPENDIX: TERMS

ALT (Altitude) – Shows the Altitude of the vessel.

APP Wind DIR SPD (Apparent Wind Direction) – Shows the Apparent Wind Direction when an external wind instrument with NMEA is connected.

APP Wind SPD (Apparent Wind Speed) – Shows the Apparent Wind Speed when an external wind instrument with NMEA is connected.

BRG (Bearing) – The direction from your current position to a Destination point.

COG (Course Over Ground) – The course your vessel is heading.

DATE – Shows the current date received by the GPS.

DEPTH – Shows the water depth when the optional FF520 50/200kHz BLACK BOX FISH FINDER or Digital Depth Sounder is connected.

DEPTH AREAS – Depth Areas are the sea areas included in the user selectable range of minimum and maximum depth limits. The sea area that is **beyond** the selected range is filled by an uniform white color, the sea area that is **inside** the selected range is filled by ordinary multicolor shading. The Spot Soundings and Depth Contours are displayed on the range only.

DRAUGHT – Tide height value referred to Horizontal cursor.

DSC (Digital Selective Calling) – Digital Selective Calling is a semi-automated method of establishing a VHF Radio call. DSC had also been designated as part of the Global Maritime Distress and Safety System (GMDSS). It is planned that DSC will eventually replace aural watches on distress frequencies and will be used to announce routine and urgent maritime safety information broadcasts.

DST (Distance) – The distance from your current position to a Destination point.

ETA – Estimated Time of Arrival

GPS Constellation – The Global Positioning System (GPS) is a space-based radio-navigation system consisting of a constellation of satellites and a network of ground stations used for monitoring and control. A minimum of 24 GPS satellites orbit the Earth at an altitude of approximately 11,000 miles providing users with accurate information on position, velocity and time anywhere in the world and in all weather conditions.

GPS2D – The GPS is receiving at least 2 valid satellites.

GPS3D – The GPS is receiving at least 3 Satellites.

HDG (Heading) – Shows heading from an External Flux Gate Compass when connected.

HDOP/VDOP – Horizontal/Vertical Dilution of Precision. It is a parameter indicating the precision of the positioning system (GPS). The smaller the HDOP/VDOP value, the more accurately the position fix is provided.

HEIGHT – The current tide height referred to the vertical cursor.

HIGH WATER – The maximum level of the tide height in 24 hours.

LOW WATER – The minimum level of the tide height in 24 hours.

Position Request – Marine DSC VHF Function of transmitting a GPS position to another Marine DSC VHF. When GPS Chart Plotter is connected to STANDARD HORIZON GPS the position of another vessel is shown on the Chart page.

SPEED – Shows the Speed Thru the Water when a Digital Speed Log is connected.

SOG (Speed Over Ground) – The speed you vessel is travelling at.

STEER – Heading to steer to destination Waypoint.

TIME – Shows the current time received by the GPS.

TRIP LOG – Shows the distance the vessel has travelled since the trip log was reset.

TRU Wind DIR SPD (Apparent Wind Direction) – Shows the True Wind Direction when a external wind instrument with NMEA is connected.

TRU Wind SPD (Apparent Wind Speed) – Shows the True Wind Speed when a external wind instrument with NMEA is connected.

TTG (Time To Go) – Shows time to go to reach a Destination point.

UNITS

Nm Nautical Mile (1 NM = 1.15 Sm or 1.85Km)

Sm Statue Mile (1Sm = 0.87Nm or 1.61Km)

Km Kilometer (1 Kilometer = 0062 Sm or 0.54Nm)

FT Feet. (1 Foot = 0.167 Fathoms or 0.305 Meters)

FA Fathom (1 Fathom = 6 Feet or 1.83 Meters)

Mt Meter (1 Meter = 3.28 Feet or 0.55 Fathoms)

Kts Knot (1 Knot = 1.15 MPH or 1.85 KPH)

MPH Miles Per Hour (1 MPH = 0.87 Knots or 1.61 KPH)

Kmh Kilometer Per Hour (1 KPH = 0.54 Knots or 0.62 MPH)

VMG – It is the destination closing Velocity. The VMG is calculated using the current speed of the vessel (SOG) and the difference between the current vessel course and the bearing to the Destination.

WAAS 2D/3D – The GPS is receiving a 2D or 3D position and the correction from the WAAS Satellite. WAAS consists of approximately 25 ground reference stations positioned across the United States that monitor GPS satellite data. Two master stations, located on either coast, collect data from the reference stations and create a GPS correction message. This correction accounts for GPS satellite orbit and clock drift plus signal delays caused by the atmosphere and ionosphere. The corrected differential message is then broadcast through one of two gestational satellites, or satellites with a fixed position over the equator. The information is compatible with the basic GPS signal structure, which means any WAAS-enabled GPS receiver can read the signal.

WATER TEMP – Shows the sea water temperature when the FF520 50/200kHz BLACK BOX FISH FINDER or a Digital Speed Log/Temp instrument with NMEA is connected.

XTE (Cross Track Error) – The distance your vessel is off course (left or right) to a Destination point.

ANALYTICAL INDEX

A			
Adjusting Time	26	Display	83
AIS	75	Distance	29
Alarms	71, 72	Distance Units	55
ALT	87	DRAUGHT	87
Altitude	29, 87	DSC	69, 87
Anchor Alarm	72	DST	87
ANTENNA	14	Dynamic Elevation Data	35
APP Wind DIR SPD	87	Dynamic Nav-Aids	35, 38
APP Wind SPD	87		
Arrival Alarm	72	E	
Attention Areas	64	Edit	45
Audible Alarm	72	Enhanced Port Info	35, 42
AUTO INFO	30	ETA	87
Automatic Identification System	75		
		F	
B		features	11
backlight	25	file	60
Bearings	72	Find	45
BRACKET MOUNTING	13	Fishes	39
BRG	87	Flexi-Zoom	35
Buoys ID	64	FLUSH MOUNTING	14
		Flush Mounting Antenna	14
		Fonts & Symbols	37
C			
C-CARD	35	G	
Calibration	72	Goto Cursor	46, 47
Cartography	83	GPS	23, 87
Cartridges	82	GPS Status	23
Celestial Page	67	Greenwich England Mean Time	26
Chart	23, 24, 62	Grounding Alarm	72
Chart Boundaries	64		
Chart Lock	65	H	
Chart page	62	HDG	87
Clear Info	35	HDOP	87
COG	87	HEIGHT	87
Compass Menu	72	HIGH WATER	87
Compass Rose	66	Home Mode	24
Compass Tape	66		
contrast	25	I	
Coordinate System	71	Icon Points	63
Coordinates	31	Information page	30
Course Up	25	Interface	83
CP180	14		
Creating a Route	51	K	
Currents Prediction	40	Keyboard	83
Cursor Mode	24		
CURSOR WINDOW	30	L	
Cursor/Menu Speed	24	Land Elevation Values	64
Customizing Soft Keys	28	LANGUAGE	29
		Lat/Lon Grid	64
		Latitude/Longitude	27
		Loading a file	60
		Locate	45
		Loran TD	27, 71
		LOW WATER	87
D		M	
Data Safety Indicator	39	Map Datum	71
Data window layout	62	MAP FUNCTIONS	37
DATE	87	Map Orientation Resolution	71
Daylight Savings	26, 67	Mark	43, 51
Depth	29, 87	Mark creation	43
Depth Alarm	72	Marks/Waypoints list	45
DEPTH AREAS	87		
Depth Range	64		
Diffusers	65		
Digital Selective Callin	69		
Digital Selective Calling	87		
DIM Menu	81		

MAX OVERVIEW	35	SOG	88
MEASURE DST & BRG	30	Speed	29, 88
MIXING LEVELS	39	Starting Waypoint	51
MOB	49	startup page	23
MOUNTING	13	Static Navigation	71
Multimedia Object	41	STEER	88
		Structure	40
		Surface Clutter	40
N			
Names	64	T	
Names Tags	64	TD	71
Nav-Aids	64	temperature	83
Navigate Menu	25, 71	text area	62
night vision	27	Tide Station	31
NMEA	68, 71	Tides and Currents	35, 64
NMEA Display Page	68	Time	26, 88
NMEA input	71	TIME LINE	30
NMEA interfacing	71	Time Units	55
NMEA Trend Page	69	Track	55
North Up	25, 29	Track menu	56
		Track Points	55, 83
O		Tracks + Routes	64
Obstructions	31, 65	TRIP LOG	56, 88
		TROUBLESHOOTING	79
P		TRU Wind DIR SPD	88
pages	28	TRU Wind SPD	88
PC	45	TTG	88
Personal Computer	45		
Perspective View	35, 38	U	
PICTURES & DIAGRAMS	41	UNITS	88
POIs	31, 64	UNITS OF MEASURE	29
PORT BY DISTANCE	31	Universal Time Coordinates	26
PORT BY NAME	31	User C-CARD	59
Port Services	31	User Points	31, 83
Ports + Services	64	UTC	26
Position Request	70, 88	UTM	27
Position Send	70		
Power supply	83	V	
		Value Added Data	35, 64
R		Variation	72
RADAR	12, 29	VDOP	87
RAM Menu	81	VMG	88
Receive	45		
record a Track point	55	W	
Resolution	83	WAAS	68, 88
Reverse Route	53	WATER TEMP	88
Roads	65	Waypoint	43
Rocks	65	Weight	83
Route	43, 83	World Background Charts	35
Route Report	52	WPL	45
		Wrecks	31
S			
Safety Status Bar	39	X	
Screen display pages	28, 61	XTE	88
Seabed Type	64	XTE Alarm	72
Serial Ports	82		
Ships Icon	24	Z	
Smart, GPS WAAS	85	Zoom Type	37
Soft Keys	28		

PLEASE NOTE

The following "Limited Warranty" is for customers that have purchased products in the United States. For Limited Warranty details outside the United States, contact the dealer in your country.

STANDARD HORIZON LIMITED WARRANTY

STANDARD HORIZON (a division of Vertex Standard USA) warrants, to the original purchaser only, each new Marine Product ("Product") manufactured and/or supplied by STANDARD HORIZON against defects in materials and workmanship under normal use and service for a period of 3 years from the date of purchase.

In the event of a defect, malfunction or failure of the Product during the warranty period, Standard Horizon's liability for any breach of contract or any breach of express or implied warranties in connection with the sale of Products shall be limited solely to repair or replacement, at its option, of the Product or part(s) therein which, upon examination by STANDARD HORIZON, appear to be defective or not up to factory specifications. STANDARD HORIZON may, at its option, repair or replace parts or subassemblies with or reconditioned parts and subassemblies.

To receive warranty service, the purchaser must deliver the Product, transportation and Insurance prepaid, to STANDARD HORIZON (Marine Division of Vertex Standard) - Attention Factory Service - 10900 Walker Street - Cypress, CA 90630, include proof of purchase indicating model, serial number and date of purchase.

STANDARD HORIZON will not warrant installation, maintenance or service of the Products. In all instances, STANDARD HORIZON's liability for damages shall not exceed the purchase price of the defective Product. This warranty only extends to Products sold within the 50 States of the United States of America and the District of Columbia.

STANDARD HORIZON will pay all labor and replacement parts charges incurred in providing the warranty repair service except where purchaser abuse or other qualifying exceptions exist. The purchaser must pay any transportation expenses incurred in returning the Product to STANDARD HORIZON for service.

This limited warranty does not extend to any Product which has been subjected to misuse, neglect, accident, incorrect wiring by anyone other than STANDARD HORIZON, improper installation, or subjected to use in violation of instructions furnished by STANDARD HORIZON, nor does this warranty extend to Products on which the serial number has been removed, defaced, or changed. STANDARD HORIZON cannot be responsible in any way for ancillary equipment not furnished by STANDARD HORIZON which is attached to or used in connection with Products, or for the operation of the Product with any ancillary equipment, and all such equipment is expressly excluded from this warranty. STANDARD HORIZON disclaims liability for range, coverage, or operation of the Product and ancillary equipment as a whole under this warranty.

STANDARD HORIZON reserves the right to make changes or improvements in Products, during subsequent production, without incurring the obligation to install such changes or improvements on previously manufactured Products. The implied warranties which the law imposes on the sale of this Product are expressly LIMITED, in duration, to the time period specified above. STANDARD HORIZON shall not be liable under any circumstances for consequential damages resulting from the use and operation of this Product, or from the breach of this LIMITED WARRANTY, any implied warranties, or any contract with STANDARD HORIZON. IN CONNECTION WITH THE SALE OF ITS PRODUCTS, STANDARD HORIZON MAKES NO WARRANTIES, EXPRESS OR IMPLIED AS TO THE MERCHANTABILITY OR FITNESS FOR A PARTICULAR PURPOSE OR OTHERWISE, EXCEPT AS EXPRESSLY SET FORTH HEREIN.

Some states do not allow the exclusion or limitation of incidental or consequential damages, or limitation on how an implied warranty lasts, so the above limitation or exclusions may not apply. This warranty gives specific legal right, and there may be other right which may vary from state to state.