

**STANLEY®**



# Commercial Hardware

**PRICE LIST 67CH**

EFFECTIVE: APRIL 2, 2018

dormakaba 

# STANLEY Commercial Hardware

## Table of Contents

### General Information

Terms & Conditions	3-4
Limited Warranty	5
BEST Masterkey Code and Master Key Service Policy	7-9
Return Order Request	109
Return Authorizations	110-111
Fulfillment Issues	111
Quoting & Ordering	107-108
Purchase Order	112-113
Keying System Summary	114-115

### Cylinders Keys & Keying

Keying Options	10
Key Blanks	11
Cut Keys	12
Uncombined SFIC Cores & Key Blanks	13
Cylinder Options	14
Cylinder Parts	15-16

### Mortise Locksets - Grade 1

QMS100/QME100 Series	17-24
QML100 Series	25-27

### Cylindrical Locksets - Grade 1

QCL100 Series	28-33
---------------	-------

### Cylindrical Locksets - Grade 2

QCL200 Series	34-38
---------------	-------

### Interconnected Levers

QCI200 Series	39-44
---------------	-------

### Tubular Locksets

QTL200 Series	45-49
---------------	-------

### Auxiliary Deadbolts - Grade 1

QDB100 Series	50-54
---------------	-------

### Auxiliary Deadbolts - Grade 2

QDB200 Series	55-61
---------------	-------

### Exit Devices & Trims - Heavy Duty

QED100 Series	62-64, 67-70
QRM100 Series	71-72
QET100 Series	73-74, 77

### Exit Devices & Trims - Narrow Stile

QED200 Series	65-70
QET200 Series	75-77

### Exit Devices & Trims - Standard Duty

QED300 Series	78-83
QRM300 Series	84-85
QET300 Series	86-87
QRT300 Series	88-91

### Door Closers - Extra Heavy Duty

QDC100 Series	92-95
---------------	-------

### Door Closers - Heavy Duty

QDC200 Series	96-98
---------------	-------

### Door Closers - Standard Duty

QDC300 Series	99-101
---------------	--------

### Index

Weights & Measurements	102-106
------------------------	---------

# STANLEY Commercial Hardware

## TERMS AND CONDITIONS OF SALE

The terms and conditions contained herein shall govern the sale of all Best products located in the Best price catalog and/or offered for sale by BEST Access Solutions, Inc. ("Best"), except for those products as set forth under separate Best Value Added Reseller Agreements. The acceptance of any order is expressly made conditional upon your assent to these Terms and Conditions of Sale.

**PRICES:** Best reserves the right, in its sole discretion, to change or amend its price list (including, but not limited to, adding or removing Products from the price list), and standard terms and conditions of sale as contained in its catalogs, price list or published sales policies, without incurring any liability whatsoever to its Customer or others. All orders will be filled at the Best List Price in effect at the time of order placement. All prices are subject to change without notice and are not guaranteed.

**TAXES:** List prices do not include federal, state or local taxes.

**ORDERS:** No order for Products shall be deemed to have been accepted by Best until written notice of its acceptance is received by the Customer from Best via an order acknowledgement. Best reserves the right, in its sole discretion, to decline to accept any order. Purchase Orders will bind Best only to the extent accepted by Best's written confirmation or delivery.

Best will attempt to fill orders in the order in which they are received, subject to prior orders. However, Best reserves the right to allocate orders or fill an order or orders ahead of prior orders, if, in its judgment, the facts warrant such a change.

Any additional provisions in a Purchase Order, including any pre-printed terms, shall be void and not binding on Best, unless expressly accepted by Best. For greater certainty, the acceptance by Best of a Purchase Order shall not be deemed acceptance of the additional terms of such Purchase Order.

Best will accept orders via phone, email, fax or courier. Best will send out an order acknowledgement for all orders received via email, phone or fax.

NOTE: Receipt or possession of this price catalog does not grant approval to quote or purchase Best products. Please contact your Best Sales Representative for further details.

**KEYING SYSTEM ORDERS:** All orders of keying systems specifying delayed fulfillment must be fulfilled within twelve (12) months of the order date. Said request for fulfillment must include complete keying instructions for the order to be acknowledged with an estimated delivery date. Failure to properly request fulfillment of the order within twelve (12) months of the order date will make the order void and nonrefundable.

**SPECIAL ORDERS:** Any modification to a standard product configuration is considered a special order. No credits will be issued for returned special orders unless authorized by Best Customer Service.

**INCOMPLETE ORDERS:** An incomplete order is one that is not fully specified according to the appropriate nomenclature required for that product. Any incomplete order will not be entered and will be referred to the appropriate Best Sales Representative for resolution.

**SAMPLES:** Please contact your local Best Sales Representative for sample requests.

**MINIMUM CHARGE:** The expense of handling an order necessitates a minimum charge of \$50.00 net per invoice.

**CREDIT LIMITS:** Best's policy is to extend Net 30-day terms/open account combined with a credit line based on financial capacity. For all accounts Best

requires a Credit Application and Sales Tax Exempt Certificate (if applicable). Best evaluates traditional sources of credit information: D&B, trade and bank references, financial information, and business plans. The supply of credit herein shall be at the discretion of Best. If available information and/or financial circumstances will not support open accounts terms, Best offers Cash in Advance and Credit Card (MasterCard or VISA) terms. Best performs periodic reviews of credit lines and terms of payment and may request updated financial information.

Best reserves the right to withhold delivery of Product if Customer does not meet Best's credit requirements for the amount of Product ordered, or the amount of Product which remains unpaid (whether or not overdue) exceeds the limit established by Best for Customer. Customer shall provide, at Best's request, an acceptable letter of credit or guarantee or security in a form and amount determined by Best.

If Customer shall become overdue on its account or otherwise defaults in any payment to Best or if its financial condition shall at any time appear inadequate to warranty further shipment on an open account basis, Best shall have the right, without liability, to refuse to accept any or all orders, to cancel any and all orders, to delay shipments, or to require advance payment before accepting or shipping any orders. All orders and all shipments are subject to approval by the Best Credit Department.

**PAYMENT TERMS:** Best standard payment terms are 2% 15, net 30 days from date of invoice.

Effective September 28, 2014, a \$45.00 convenience fee will apply to all payments made by Credit Card towards open invoices on your account. You may choose to pay by credit card by reaching out to your Credit Analyst directly in order to process payment. You can avoid paying the \$45.00 convenience fee by enrolling and paying open invoices via Billtrust Invoice Gateway (<https://secure.billtrust.com/stanleymechnical/ig/signin>) with an ACH Payment (bank transfer from checking or savings account) free of charge. Payments by check, or money order should continue to be sent directly to the remit-to address noted on invoices.

Best shall be entitled to charge and Customer shall pay interest on overdue invoices at the rate of two percent (2%) per month calculated from the date of the invoice to the date of payment, including any attorney fees incurred by Best resulting from the collection of such overdue payment. Customer shall pay all sums owing to Best without any deduction or abatement and Customer shall have no right of set-off.

In the event that Customer disputes any portion of the payment due, Customer shall be obligated to pay the balance which is not the subject of dispute.

Without limiting any other rights it may have under these terms of sale and applicable law, all of Best's obligations under this Agreement, including obligations of supply, or any Purchase Order, can be suspended or cancelled should Customer be delinquent in making payment for previously shipped Products.

### INTERNATIONAL SALES:

International Resellers located outside of the United States of America who place orders are subject to and must pay by (1) Cash in Advance, (2) Confirmed Irrevocable Letter of Credit, (3) Standby Letter of Credit.

All international shipments shall be FCA (Incoterms 2010) from Best's facility in Indianapolis, Indiana USA. Best shall be deemed to have delivered all Products and related goods when such are put in the custody of a carrier at Best's plant or warehouse above, at which time all title and risk of loss or damage shall pass to Customer.

February 2018

# STANLEY Commercial Hardware

## TERMS AND CONDITIONS OF SALE (continued)

**SHIPPING/FREIGHT:** All Products shall be shipped FOB Origin domestic or FCA International (INCOTERMS 2010) from Best's facility in Indianapolis, Indiana USA. Best shall be deemed to have delivered all Products and related goods when such are put in the custody of a carrier at Best's plant or warehouse above, at which time all title, risk of loss or damage shall pass to Customer. All shipments will be made in accordance with the preferred routing, carrier assignments, and operational guidelines of Best. Customer shall bear all costs of freight, insurance and associated costs and shall make all arrangements for same.

Single or combined shipments including Best lock sets, exit devices, hinges and door closers will be considered for free freight with orders at or above \$5000 net (product combination must be on same purchase order). Orders less than \$5,000 will be shipped freight prepaid with shipping cost added to the invoice, including a nominal freight charge to be determined by Best at time of shipping.

Hinge only orders will be considered for free freight with orders at or above \$750 net. Orders less than \$750 will be shipped freight prepaid with shipping cost added to the invoice, including a nominal freight charge to be determined by Best at time of shipping.

These freight terms apply only to a single destination within the contiguous United States.

Should a shipment qualify for one of Best's free freight programs, the Products shall be shipped FOB Origin domestic (with exception to prepaid freight) or FCA International (INCOTERMS 2010) (with exception to prepaid freight) from Best's facility in Indianapolis, Indiana USA.

**DELIVERY:** Orders shall be acknowledged and given a scheduled delivery date based on Orders shall be acknowledged and given a scheduled delivery date based on estimated manufacturing lead times. Manufacturing lead time will begin once all information is received to process an order. Delivery dates given by Best as part of order acknowledgment for accepted orders for Products or related goods will be honored by Best on a best effort basis. Shipping dates shown on order acknowledgments are based upon Best's estimate and cannot be guaranteed. Best will not be liable for any loss or damage resulting from delay in filling orders, including any direct or consequential loss or damage. Best reserves the right to make partial shipments unless the order specifies otherwise.

**CHANGES/CANCELLATIONS:** After orders are entered for manufacturing, changes or cancellations cannot be accepted without Best written permission, and may be subject to a change or cancellation charge equivalent to 30% of the purchase price.

Orders for special and/or custom designed goods not immediately saleable to another customer are not changeable, cancelable, or returnable.

**RETURNED GOODS:** Best Customer Service MUST authorize all returns. All goods must be returned in original packaging and be in resalable condition except for warranty returns. Use fax number 888-214-1918 for returned goods authorization only. Only goods with an invoice date of less than one (1) year will be considered for a Return Goods Authorization (RGA). All material returned to Best, regardless of the reason, must have a correct RGA number applied to the outside of the shipping carton. A restocking charge of 30% of the purchase price will be applied to the Customer's account except for warranty returns. Transportation charges of returned goods must be prepaid by Customer. All goods must be returned within sixty (60) calendar days of RGA issue date. All goods must be returned in original packaging and be in resalable condition except for warranty returns. Product not returned in salable condition or after sixty (60) days of the RGA issue date is subject to disposal by Best with no credit issued.

Best cannot authorize the return of discontinued product. Under no circumstances will special order items be accepted for return, unless covered by warranty.

**EXPORT REGULATIONS:** Customer agrees to conform to, and abide by, the export laws and regulations of the US, including, but not limited to, the Export Administration Act of 1979 as amended and its implementing regulations. Diversion contrary to US laws and regulations is prohibited.

**MASTERKEYING:** Best Masterkey Code and Masterkey Service Policy can be found at [www.bestaccess.com](http://www.bestaccess.com).

**LIMITATION OF LIABILITY:** EXCEPT AS OTHERWISE REQUIRED BY APPLICABLE LAW, BEST SHALL HAVE NO LIABILITY FOR ANY CONSEQUENTIAL, SPECIAL, INCIDENTAL, INDIRECT, EXEMPLARY, LIQUIDATED OR PUNITIVE DAMAGES, INCLUDING, WITHOUT LIMITATION, LOST PROFITS, COSTS OF DELAY, ANY FAILURE OF DELIVERY, OR BUSINESS INTERRUPTION, REGARDLESS OF WHETHER THE CLAIM GIVING RISE TO SUCH DAMAGES IS BASED UPON BREACH OF WARRANTY, BREACH OF CONTRACT, TORT (INCLUDING NEGLIGENCE OR STRICT LIABILITY), PRODUCT LIABILITY, OR OTHERWISE, EVEN IF BEST HAS BEEN ADVISED OF THE POSSIBILITY THEREOF. TO THE MAXIMUM EXTENT PERMITTED BY APPLICABLE LAW, IN NO EVENT WILL BEST'S TOTAL AGGREGATE LIABILITY TO CUSTOMER, UNDER ANY LEGAL THEORY, WHETHER IN CONTRACT, TORT (INCLUDING NEGLIGENCE OR STRICT LIABILITY), PRODUCT LIABILITY, INFRINGEMENT OF OR DAMAGE TO ANY PATENT, COPYRIGHT, TRADEMARK, OR OTHER INTELLECTUAL PROPERTY RIGHTS OF ANY PERSON OR ENTITY, OR OTHERWISE IN RELATION TO THE SALE OF BEST PRODUCTS TO CUSTOMER, EXCEED THE AGGREGATE OF THE AMOUNT PAID OR PAYABLE TO BEST BY CUSTOMER FOR THE ORDER GIVING RISE TO THE ALLEGED LIABILITY.

**LIMITED WARRANTY:** The terms and conditions outlined above are subject to Best's Limited Warranty, which is included in the Best Price Catalog and is incorporated herein by reference. Upon return of a defective product, Best shall either repair or replace the product, in its sole discretion, in accordance with our standard warranty.

EXCEPT AS SET FORTH HEREIN, BEST MAKES NO WARRANTIES, EXPRESSED OR IMPLIED, AND BUYER ACKNOWLEDGES THAT NO REPRESENTATIONS, WARRANTIES, PROMISES OR STATEMENTS HAVE BEEN MADE BY BEST, WITH RESPECT TO THIS PRODUCT, OR ANY PART OR PORTION THEREOF. IN ADDITION, BEST MAKES NO WARRANTY OF MERCHANTABILITY OR FITNESS FOR A PARTICULAR PURPOSE OF THIS PRODUCT OR ANY PART OR PORTION THEREOF, FOR ANY PURPOSE, NOR ANY WARRANTY WHICH EXTENDS BEYOND THE DESCRIPTION ON THE FACE HEREOF. BEST SHALL NOT, IN ANY EVENT, BE LIABLE FOR ANY CONSEQUENTIAL OR INCIDENTAL DAMAGES SUFFERED BY BUYER OR ANYONE CLAIMING BY, THROUGH OR UNDER BUYER, AS A RESULT OF THE CONDITION OF THIS PRODUCT, OR ANY PART OR PORTION THEREOF, AND THERE ARE NO ORAL OR WRITTEN UNDERTAKINGS OR AGREEMENTS OF ANY TYPE PROVIDED BY BEST EXCEPT AS EXPRESSLY SET FORTH HEREIN. SOME STATES DO NOT ALLOW LIMITATIONS ON HOW LONG AN IMPLIED WARRANTY LASTS OR PROHIBIT THE EXCLUSION OR LIMITATION OF INCIDENTAL OR CONSEQUENTIAL DAMAGES, SO THE ABOVE LIMITATION AND EXCLUSIONS MAY NOT APPLY IN YOUR STATE.

**GOVERNING LAW:** These Terms and Conditions of Sale and any subsequent sales agreements between Best and Customer shall be construed in accordance with the laws of the State of Indiana. The United Nations Convention on Contracts for the International Sale of Goods shall not apply to this Agreement.

February 2018

# STANLEY Commercial Hardware

## LIMITED WARRANTY

**What is Covered:** Best Access Solutions, Inc. ("Best") warrants that the Products manufactured by Best, identified below, and sold under its trade name "STANLEY COMMERCIAL HARDWARE" are free of defects in materials and workmanship as outlined below. The sole and exclusive liability of Best under this warranty is limited to the repair or replacement of any Product or component part covered by the warranty at the sole discretion of Best.

**Who is Covered:** This warranty is extended only to Best's distributors of products and the end user who purchases products for purposes other than resale (collectively, "Purchaser").

**Hardware Warranty Period:**

QCL Cylindrical Lock, QTL Tubular Lock, QMS/QME/QML Mortise Lock, QCI Inter connected Lock, QDB Auxiliary Deadbolt, QDC Door Closers, QED Exit Devices, QET/QRT Exit Trim, QGI Inter connected Lock, QGT Tubular Lock, QGD Deadbolt and QRM Mullions shall have the following warranty periods:

- **Mechanical products** warranty term shall be limited lifetime for a period of the useful life of the building in which the products are originally installed.
- **Electrical products** shall be warranted for one (1) year from the date of sale.

6CS and 7CS products shall have the following warranty period:

- Three (3) years from the date of sale.

Finishes shall be warranted for three (3) years from the date of sale excluding US10B/613 "Oil Rubbed Bronze" finish.

**Warranty Claims:** Any Products believed to be defective as covered by this warranty may not be returned without prior written Returned Materials Authorization (RMA) from Best Product Support (855) 365-2407 covering specific items and quantities within thirty (30) days from the discovery of the alleged defect(s). Best will inform the purchaser where to ship said Product(s), shipping charges prepaid by you, for examination. In the event such examination reveals a defect covered by this warranty; Best will, at its sole option, repair or replace the Product, and return it or its replacement to the purchaser, with charges only for shipping.

**Exclusions:** This warranty specifically excludes, and Best shall not be held responsible for the following:

- COSTS ASSOCIATED WITH INSTALLING, REMOVING OR REINSTALLATION OF THE PRODUCT.**
- Damage caused by Product malfunction or failure attributable to acts of God.
- Improper use or installation.
- Poor or no maintenance.
- Work performed by someone other than an Authorized Best technician.
- Failure to follow Best's operating instructions or environmental specifications.
- Incorrect application, modification, vandalism, erosion or corrosion, shipping and/or handling, improper storage, accident, misuse, abuse or any other cause not within the control of Best.
- This warranty is void if any modification is made to the warranted product, regardless of whether the modification causes or contributes to the alleged defect. All modifications are made at the risk and expense of the party making the modifications.
- Best shall not be liable for any repairs, replacements, or adjustments to the product or any costs of labor performed by the Purchaser or others without Best's prior written approval.
- Best provides no warranty or guarantee that its cores and/or cylinders will function properly or be mechanically compatible with products not manufactured by Best.
- The US10B/613 finish is considered to be a living finish that will change over time with use and age and is expressly excluded from this warranty. The finish changes that occur are indicative of normal wear and tear and reflect the essence of a living finish. The finish changes are not considered manufacturing defects and are not covered by this warranty.

# STANLEY Commercial Hardware

## LIMITED WARRANTY (continued)

**Third Party Warranty:** Except as otherwise provided above, Best makes no warranty, express or implied, with regard to third party hardware or software and expressly disclaims the implied warranties or conditions of merchantability or merchantable quality, fitness for a particular purpose, title, infringement and those arising by statute or otherwise in law. Customer's sole recourse for warranty claims is with the manufacturer of the Product. However, Best agrees to pass through any third party warranty that Best receives from the manufacturer of the Products to Purchaser. The extent of any third party warranty details, terms and conditions, remedies and procedures may be expressly stated on, or packaged with, or otherwise accompanying the Products.

**LIMITATION OF WARRANTIES:** THIS WARRANTY IS GIVEN EXPRESSLY AND IN PLACE OF ALL OTHER WARRANTIES, EXPRESS OR IMPLIED, INCLUDING ANY IMPLIED WARRANTIES OF MERCHANTABILITY OR FITNESS FOR PARTICULAR PURPOSE. THERE ARE NO UNDERSTANDINGS, AGREEMENTS, REPRESENTATIONS, OR WARRANTIES NOT SPECIFIED HEREIN OTHER THAN THOSE INCLUDED IN THE CURRENT SUPPLIER AGREEMENT BY AND BETWEEN GRAINGER AND BEST.

BEST SHALL NOT, IN ANY EVENT, BE LIABLE FOR ANY CONSEQUENTIAL, INCIDENTAL, INDIRECT, SPECIAL OR PUNITIVE DAMAGES SUFFERED BY PURCHASER OR ANYONE CLAIMING BY, THROUGH OR UNDER PURCHASER, AS A RESULT OF THE CONDITION OF THIS PRODUCT, OR ANY PART OR PORTION THEREOF.

SOME STATES DO NOT ALLOW LIMITATIONS ON HOW LONG AN IMPLIED WARRANTY LASTS OR PROHIBIT THE EXCLUSION OR LIMITATION OF INCIDENTAL OR CONSEQUENTIAL DAMAGES, SO THE ABOVE LIMITATION AND EXCLUSIONS MAY NOT APPLY IN YOUR STATE.

THIS WARRANTY IS GOVERNED BY THE LAW OF THE STATE OF INDIANA WITHOUT REGARD TO ITS CONFLICTS OF LAW PRINCIPLES. BEST AND PURCHASER AGREE THAT THE UNITED NATIONS CONVENTION ON CONTRACTS FOR THE INTERNATIONAL SALE OF GOODS SHALL NOT APPLY TO SALE OF THE PRODUCTS COVERED BY THIS WARRANTY.

February 2018

# STANLEY Commercial Hardware

## BEST MASTERKEY CODE AND MASTERKEY SERVICE POLICY

### I. DISTRIBUTOR MASTERKEY SERVICES

All Best Access Solutions, Inc. ("Best") Authorized Distributors, Aftermarket Wholesalers, and Locksmiths ("Authorized Distributors") can create, modify or extend masterkey codes for the benefit of their end user customers ("End Users") for Best non-patented masterkey systems; provided, however, the services must be performed in line with industry standards. With the express written permission of Best, select Authorized Distributors can create, modify or extend masterkey codes for the benefit of End Users for a Best Patented Masterkey System (pursuant to the terms and conditions of Section C below). Authorized Distributor's failure to comply with the terms of this policy could result in Best's termination of its Distributor Agreement as well as Best's pursuit of any remedies available at law.

#### A. END USER INFORMATION AND CODE RELEASE:

All masterkey codes (both patented and non-patented) previously generated by Best are available for distribution to End Users (and/or their designated Authorized Distributor, if applicable) via the End User Web Portal at <http://masterkeycodeportal.bestaccess.com/Login.aspx>. For a hard copy of the End User Information and Code Release Form, please contact your Best End User Consultant. End user codes will be distributed solely to those Authorized Distributors (a) identified by the End User on a fully executed End User Information and Code Release Form received by Best, and (b) for the release of Best Patented Masterkey Codes, the Authorized Distributor is authorized by Best to receive and process Best Patented Masterkey Codes (as more fully described in Section C below.) No exceptions will be made to this policy.

#### B. BEST NON-PATENTED MASTERKEY SYSTEM

As of September 4, 2012, Best no longer requires a Security Authorization Form to be signed by the End User prior to Best and/or its Authorized Distributor accepting core and key orders for non-patented keying systems. All valid End User communications for orders related to non-patented keying systems will be fulfilled at the End User's liability.

#### C. BEST PATENTED MASTERKEY SYSTEM

The Best Patented Masterkey System provides a higher level of protection against unauthorized key duplication and crossovers and, in order to maintain the quality of a Best Patented Masterkey System, the following terms and conditions of this policy shall apply to any and all Authorized Distributors with access to Best Patented Masterkey Systems. For the purpose of this policy, "Best Patented Product" shall mean the Best Cormax (including cores and keys), as well as any and all future product Best designates as patented product for the purpose of this policy. "Best Patented Masterkey Systems" and "Best Patented Masterkey Codes" shall mean the respective masterkey system or codes of any Best Patented Masterkey Product.

**Sale of Best Patented Product:** As further described in this [Section C](#), only those Authorized Distributors meeting certain necessary qualifications and standards shall be selected by Best to sell Best Patented Product. Selection shall be at the sole discretion of Best and shall be evidenced in writing via the Distributor Agreement or its select addendums.

**Best Patented Security Authorization Form:** It is a responsibility of the Authorized Distributor to ensure that Best Patented Product does not end up in the possession of unauthorized individuals or entities. The Authorized Distributor must ensure that the End User completes a Best Patented Masterkey System Security Authorization Form (the "[Security Authorization Form](#)") as outlined in this [Section C](#). The [Security Authorization Form](#) designates those individuals within the End User's organization that are authorized to place orders with the Authorized Distributor for Best Patented Product. The [Security Authorization Form](#) must be completed and signed by the End User.

It is the Authorized Distributor's full responsibility to validate the End User's signature as identified on the [Security Authorization Form](#) prior to accepting any orders for Best Patented Product.

In certain circumstances the Authorized Distributor selling the Best Patented Product will not contract directly with the End User. In these circumstances, the Authorized Distributor is required to work with its reseller to ultimately ensure that the End User submits a signed [Security Authorization Form](#) to Best.

Best shall have the right to audit all [Security Authorization Forms](#) maintained by the Authorized Distributors for completeness, accuracy and compliance with this Policy.

**Sale of Combined Best Patented Product through Distributor:** Best may authorize select Authorized Distributor to purchase and resell to an End User Best Patented Product that has been combined by Best Personnel. In this instance, a [Security Authorization Form](#) must be completed and signed by the End User and provided by the Authorized Distributor to Best with each Best Patented Product order.

**Stocking of Best Patented Product:** Best may authorize select Authorized Distributors to purchase and stock Best Patented Product and have access to Best Patented Masterkey Codes by entering into a [Best Patented Masterkey System Distributor Agreement Addendum](#) (the "Authorized Stocking Distributor") As a condition to the Authorized Stocking Distributor's continued access to Best Patented Masterkey Codes, it must comply at all times with the [Best Patented Key Systems Security Procedure](#). In addition, it is the responsibility of the Authorized Stocking Distributor to ensure that they have a completed [Security Authorization Form](#) on file for each End User that places an order with the Authorized Stocking Distributor for Best Patented product and that the Authorized Stocking Distributor authenticates the signature of each Best Patented Product order utilizing the [Security Authorization Form](#).

February 2018

# STANLEY Commercial Hardware

## BEST MASTERKEY CODE AND MASTERKEY SERVICE POLICY (continued)

**Best Patented Masterkey Code Generation:** To assist in reducing the possibility of duplication within a keying system and ensure security, all Best Patented Masterkey Codes must be created, modified and/or extended by Best's masterkey personnel and/or an Authorized Stocking Distributor. The unauthorized duplication or release of Best Patented Masterkey Codes to non-authorized people or organizations, including, but not limited to, unauthorized distributors, wholesalers, private locksmiths, other lock manufacturers, architects, or contractors, is a violation of this policy as well as the infringement of patent rights and other intellectual property rights of Best. In addition to any other recourse available under law, the unauthorized release of Best Patented Masterkey Codes by any Authorized Stocking Distributor shall result in immediate termination.

**Best Patented Masterkey System Exclusive Keyways:** Upon request from an End User to release Best Patented Masterkey Codes previously generated by Best that are on an exclusive keyway, Best will send a notification to the End User reminding them that their patented codes are on an exclusive keyway. Best will provide a copy of this notice to the Authorized Stocking Distributor. To assist in reducing the possibility of duplication within an End User exclusive keying system and ensure security, all exclusive Best Patented Masterkey Codes must be created, modified and/or extended and recorded in Best's BESTCode masterkey code management tool.

Should Best approve an Authorized Stocking Distributor to establish a Best Patented Masterkey System on an exclusive keyway, the Authorized Stocking Distributor shall be required to sign a Best Patented Masterkey System Exclusive Keyway Addendum. To assist in reducing the possibility of duplication within a Distributor exclusive keying system and ensure security, all exclusive Best Patented Masterkey Codes must be created, modified and/or extended and recorded in Best's BESTCode masterkey code management tool.

**Copies of Best Patented Masterkey Codes:** Best shall have a right to a copy of all Best Patented Masterkey Codes that have been originated, modified, extended or otherwise maintained by the Authorized Stocking Distributor in the Best BESTCode system in order for Best to be able to provide continued support either directly, or indirectly, to the End User.

## II. BEST MASTERKEY SERVICES

### A. BEST MASTERKEY SERVICES PROVIDED TO DISTRIBUTOR:

Best, upon request and at its sole discretion, may provide select masterkey services to an Authorized Distributor for both non-patented masterkey systems and Best Patented Masterkey Systems. In order for an Authorized Distributor to place an order for the extension of, or modification to, a masterkey system previously created or maintained by Best, the End User must have selected that Authorized Distributor as its authorized designee in the End User Information & Code Release Form received by Best. Complete keying instructions must be given before a Best order can be properly acknowledged with an estimated delivery date. Best reserves the right to charge for the service of a customized masterkey security solution with the purchase of a Best product. A masterkey service charge will be assessed for each order for cylinders or cores for use in non-Best manufactured locks for which Best has an equivalent product. Best Patented Masterkey System products shall not be provided without the associated masterkey services being provided by Best. All Masterkey Services provided by Best shall be subject to the terms and conditions of the Best Masterkey Service Order Acknowledgment which shall be provided upon acceptance of the order for Masterkey Services.

### B. BEST BESTCODE:

Best may, in its sole discretion, make available its BESTCode masterkey code management tool to select Authorized Distributors that meet certain training and certification requirements. If offered, BESTCode will be made available for an annual subscription fee as outlined in the Best pricing catalog. All codes made available to Authorized Distributors in the BESTCode system shall be subject to the BESTCode User License Agreement and will be provided in accordance with this Policy. The BESTCode masterkey code management tool is not available for use with Stanley Commercial Hardware products.

February 2018



# STANLEY Commercial Hardware

## BEST MASTERKEY CODE AND MASTERKEY SERVICE POLICY

### III. FORMS

For a copy of the following forms please contact the Best End User Consultant.

- End User Information and Code Release Agreement
- Best Patented Masterkey System Distributor Agreement Addendum (Exhibit B)
- Best Patented Masterkey System Security Authorization Form
- Best Patented Key Systems Security Procedure
- Best Patented Masterkey System Exclusive Keyway Addendum
- Best Patented Masterkey System End User Specific Distributor Agreement Addendum (Exhibit D)

Best reserves the right to change, modify or update this Policy at any time, in its sole discretion.

February 2018

# STANLEY Commercial Hardware

## Keying Guide | Keying Options | Key Stamping

### KEYING OPTIONS

Order	Description	Qty	List Price
KD	Keyed Different	1	NC
KA	Keyed Alike	1	NC
MK	Master Keyed (One Level Only)	1	16.00
CK	Construction Keyed (AKA as Protecto Keying)	1	16.00
CMK	Construction & Master Keyed	1	16.00
MAIS	Maison Keyed / Cross Keyed	1	16.00
GMK	Grand Master Keyed	1	16.00
GGMK	Great Grand Master Keyed	1	16.00

### KEY STAMPING OPTIONS

Order	Description	Qty	List Price
VCK0	No bitting or keyset stamping on keys	1	NC
VCK1	Visual Key Stamping (Keys Only)	1	NC
VCK2	Special Key Stamping (Other than standard symbols)	1	6.30
VCK3	Visual Key Control (Cylinder Face Only - Levers and Deadbolts)	1	6.30
VCK4	Visual Key Control (Keys & Cylinder Face)	1	11.00
DND	Keys stamped with "Do Not Duplicate"	1	NC
CKC2	Concealed Key Control (Cylinders & VKC Keys)	1	11.00
CKC3	Concealed Key Control (Cylinders Only)	1	11.00

- Maximum Characters: Keys - 6  
 Cylinder Face - 4  
 CKC Cylinders - 6

# STANLEY Commercial Hardware

## Keying Guide | Key Blanks

### KEY BLANKS (SOLD IN QUANTITIES OF 50)

Description	Each	Service Part #	List Price
<b>6-PIN KEY BLANKS</b>			
Kwikset KW 6-Pin Blank (STANLEY Bow, Embossed One Side)	1	6AQ1KW16	2.40
Weiser WE 6-Pin Blank (STANLEY Bow, Embossed One Side)	1	6AQ1WE16	2.40
Schlage SC 6-Pin Blank (STANLEY Bow, Embossed One Side)	1	6AQ1SC16	2.40
Sargent LA 6-Pin Blank (Ilco Standard Bow)	1	6AQ1LA16	2.40
Yale GA 6-Pin Blank (Ilco Standard Bow)	1	6AQ1GA16	2.40
STANLEY BF 6-Pin Blank (Ilco Bow, Do Not Duplicate)	1	6AQ1BF16DND	2.40
Kwikset KW 6-Pin Blank (STANLEY Bow, Embossed One Side, Do Not Duplicate)	1	6AQ1KW16DND	2.40
Weiser WE 6-Pin Blank (STANLEY Bow, Embossed One Side, Do Not Duplicate)	1	6AQ1WE16DND	2.40
Schlage SC 6-Pin Blank (STANLEY Bow, Embossed One Side, Do Not Duplicate)	1	6AQ1SC16DND	2.40
<b>5-PIN KEY BLANKS</b>			
Kwikset KW 5-Pin Blank (STANLEY Bow, Embossed One Side)	1	6AQ1KW15	2.40
Kwikset KW 5-Pin Blank for QDB288 Control Cylinder	1	6AQ2KW15	2.40
Weiser WE 5-Pin Blank (STANLEY Bow, Embossed One Side)	1	6AQ1WE15	2.40
Schlage SC 5-Pin Blank (STANLEY Bow, Embossed One Side)	1	6AQ1SC15	2.40
Kwikset KW 5-Pin Blank (STANLEY Bow, Embossed One Side, Do Not Duplicate)	1	6AQ1KW15DND	2.40
Weiser WE 5-Pin Blank (STANLEY Bow, Embossed One Side, Do Not Duplicate)	1	6AQ1WE15DND	2.40
Schlage SC 5-Pin Blank (STANLEY Bow, Embossed One Side, Do Not Duplicate)	1	6AQ1SC15DND	2.40

\*Key blanks sold in quantities of 50.

# STANLEY Commercial Hardware

## Keying Guide | Cut Keys

### CUT KEYS

Description	Qty	Part #	List Price
<b>6-PIN CUT KEYS</b>			
STANLEY BF 6-Pin Cut Key (STANLEY Bow, Embossed One Side)	1	6AQ1BF26	5.80
STANLEY BF 6-Pin Cut Key (STANLEY Bow, Embossed One Side, Master Key)	1	6AQ3BF26	5.80
Kwikset KW 6-Pin Cut Key (STANLEY Bow, Embossed One Side)	1	6AQ1KW26	5.80
Kwikset KW 6-Pin Cut Key (STANLEY Bow, Embossed One Side, Master Key)	1	6AQ3KW26	5.80
Weiser WE 6-Pin Cut Key (STANLEY Bow, Embossed One Side)	1	6AQ1WE26	5.80
Weiser WE 6-Pin Cut Key (STANLEY Bow, Embossed One Side, Master Key)	1	6AQ3WE26	5.80
Schlage SC 6-Pin Cut Key (STANLEY Bow, Embossed One Side)	1	6AQ1SC26	5.80
Schlage SC 6-Pin Cut Key (STANLEY Bow, Embossed One Side, Master Key)	1	6AQ3SC26	5.80
Sargent LA 6-Pin Cut Key (Ilco Standard Bow)	1	6AQ1LA26	5.80
Sargent LA 6-Pin Cut Key (Ilco Standard Bow, Master Key)	1	6AQ3LA26	5.80
Yale GA 6-Pin Cut Key (Ilco Standard Bow)	1	6AQ1GA26	5.80
Yale GA 6-Pin Cut Key (Ilco Standard Bow, Master Key)	1	6AQ3GA26	5.80
STANLEY BF 6-Pin Cut Key (STANLEY Bow, Embossed One Side, Do Not Duplicate)	1	6AQ1BF26DND	5.80
Kwikset KW 6-Pin Cut Key (STANLEY Bow, Embossed One Side, Do Not Duplicate)	1	6AQ1KW26DND	5.80
Weiser WE 6-Pin Cut Key (STANLEY Bow, Embossed One Side, Do Not Duplicate)	1	6AQ1WE26DND	5.80
Schlage SC 6-Pin Cut Key (STANLEY Bow, Embossed One Side, Do Not Duplicate)	1	6AQ1SC26DND	5.80
<b>5-PIN CUT KEYS</b>			
Kwikset KW 5-Pin Cut Key (STANLEY Bow, Embossed One Side)	1	6AQ1KW25	5.80
Kwikset KW 5-Pin Cut Key (STANLEY Bow, Embossed One Side, Master Key)	1	6AQ3KW25	5.80
Kwikset KW 5-Pin Cut Key for QDB288 Control Cylinder	1	6AQ2KW25	5.80
Weiser WE 5-Pin Cut Key (STANLEY Bow, Embossed One Side)	1	6AQ1WE25	5.80
Weiser WE 5-Pin Cut Key (STANLEY Bow, Embossed One Side, Master Key)	1	6AQ3WE25	5.80
Schlage SC 5-Pin Cut Key (STANLEY Bow, Embossed One Side)	1	6AQ1SC25	5.80
Schlage SC 5-Pin Cut Key (STANLEY Bow, Embossed One Side, Master Key)	1	6AQ3SC25	5.80

\* All cut keys require specification of keyway and key combination.

\* When being ordered separate from product Master Keys, Top Level Masters, and Do Not Duplicate Keys require Signature Authority.

\* Builder key orders get 10 builder keys at no charge.

\* Master key orders get 1 master key at no charge.

# STANLEY Commercial Hardware

## Keying Guide | Key Blanks

### Uncombined Cores (SFIC)

How To Order					
7CS	7	A	1	626	
Core Type	Lock Body	Keyway	Combining Code	Finish	Price
7CS - SFIC	6 - 6-pin 7 - 7-pin	Designate specific keyway (A, D, E, etc.)	1 - Uncombined	626 - Satin Chrome 606 - Satin Brass 613 - Oil Rubbed Bronze	\$28.00

### Combined Cores (SFIC)

How To Order - SFIC Cores					
6CS	7	BF	2	626	
Core Type	Lock Body	Keyway	Combining Code	Finish	List Price
6CS - SFIC	6 - 6-pin 7 - 7-pin	BF - BEST F	2 - Combined	605 626 690	\$44.00

### 6-7 PIN SFIC Key Blanks

How To Order					
7AS	1	A	1		
Series	Key Type	Keyway	Cut Code	Key Stamp	Price
7AS - Standard	1 - Blank	Designate specific keyway (A, D, E, etc.)	1 - Blank	KS915 x KS800 - " DUPLICATION PROHIBITED" with stars on Front and a blank back - Standard	\$2.30

**NOTES:**

Consult factory for lead times.

7CS packaged in multiples of 50 cores and 7AS packaged in multiples of 100 keys. A 10% broken box service fee applies unless total order exceeds \$5,000.

# STANLEY Commercial Hardware

## Cylinder Guide

### Key-in-Lever and Deadbolt Cylinders

How To Order							
6EQ	D	6	BF	2	626	QDB180	CC
Cylinder Type	Cylinder Type	Lock Body	Keyway	Combining Code	Finish	Tailpiece	Options
6EQ - Standard Cylinder	L - Key in Lever D - Deadbolt	5 - 5-pin 6 - 6-pin	KW - Kwikset WE - Weiser SC - Schlage C GA - Yale LA - Sargent	2 - Combined 5 - Zero Bitted	606 626	Must specify Series/Function	CC - Construction

Keyway	Price with Lock	Service Part List Price
KW - Kwikset	NC	\$25.00
WE - Weiser		
SC - Schlage C		
GA - Yale		
LA - Sargent	NC	\$53.00

### Mortise and Rim Cylinders

How To Order								
6EQ	M	6	KW	2	626	E	118	CC
Cylinder Type	Cylinder Type	Lock Body	Keyway	Combining Code	Finish	Cam	Length	Options
6EQ - Standard Cylinder	M - Mortise R - Rim	5 - 5-pin 6 - 6-pin	KW - Kwikset WE - Weiser SC - Schlage C GA - Yale LA - Sargent	2 - Combined 5 - Zero Bitted	606 613 626	For Mortise Cylinders: M - Cloverleaf Cam E - Straight Cam A - Adams Rite Cam	118 - 1-1/8" 138 - 1-3/8"	CC - Construction

Keyway	Price with Lock	Service Part List Price
KW - Kwikset	NC	\$55.00
WE - Weiser		
SC - Schlage C		
GA - Yale		
LA - Sargent		

**NOTES:**

M - Cloverleaf Cam 1 - 1/8" is standard for QMS/QME/QML mortise locks. 1 - 3/8" is available for thick doors.

E - Straight Cam 1 - 1/8" is standard for QED exit devices and QET trims that use mortise cylinders.

Refer to BEST Cylinders (1E) when SFIC mortise cylinders are required.

For all cylinders, consult factory for lead times.

# STANLEY Commercial Hardware

## Cylinder Guide | Parts











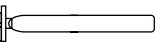

### CYLINDER PARTS

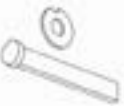
	Description	Series	Service Part #	List Price
	Cylinder Locking Pin	All	8Q00209	1.20
	Cylinder Locking Cap	All	8Q00210	1.80
	Cylinder Locking Spring	All	8Q00211	1.20
	Tailpiece QCL1 50/QCL1 70 - Entry/Storeroom	QCL100	8Q00069	2.50
	Tailpiece QCL160 - Classroom (all keyways except KW)	QCL100	8Q00070	2.50
	Tailpiece QCL160 - Classroom (KW keyway only)	QCL100	8Q00071	2.50
	Cylinder Plug Holder QCL100 Series	QCL100	8Q00065	1.80
	Tailpiece QCL250/QCL270/QCI250 - Entry/Storeroom/Interconnect	QCL200/ QCI200	8Q00072	2.50
	Tailpiece QCL260 - Classroom	QCL200	8Q00074	2.50
	SFIC Tailpiece QCL200 Series	QCL200	8Q00302	2.40
	Cylinder Plug Holder QCL200 Series	QCL200	8Q00066	1.80
	Tailpiece QCI200 Series Interconnect Deadbolt	QCI200	8Q00076	2.50

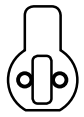
# STANLEY Commercial Hardware

## Cylinder Guide | Parts

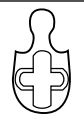
### CYLINDER PARTS (CONTINUED)

	Description	Series	Service Part #	List Price
	Tailpiece QTL200/QRT300 Series	QTL200/QRT300	8Q00073	2.50
	Cylinder Plug Holder for QTL200 Series - Summit Style	QTL200	8Q00067	2.00
	Cylinder Plug Holder for QTL200 Series - Sierra Style	QTL200	8Q00068	2.00
	Tailpiece QDB100/QDB200 Series Single Cylinder	QDB100/QDB200	8Q00083	2.50
	Tailpiece QDB100/QDB200 Series Double Cylinder (QTY 2)	QDB100/QDB200	8Q00085	2.50
	Thick door kit - Tailpiece for QDB100/QDB200 Series Single Cylinder (1-3/4" - 2-1/4")	QDB100/QDB200	8Q00084	2.50
	Cylinder Screw QDB100/QDB200 Series	QDB100/QDB200	8Q00086	2.50
	Standard Cam for Mortise Cylinder	Mortise Cylinders	8Q00119	4.60
	Cam Mounting Screws for Mortise Cylinders (QTY 2)	Mortise Cylinders	8Q00118	1.50
	Rim Cylinder Tailpiece	RimCylinders	8Q00140	2.50
	Rim Cylinder Tailpiece For Thick Doors	RimCylinders	8Q00480	2.50
	Cloverleaf Mortise Cam for QME/QMS/QML	QME, QMS, QML	8Q01084	1.80
	Adams Rite Cam	---	8Q00571	1.80



# STANLEY Commercial Hardware

## QMS/QME100 Series | Grade 1 | Heavy Duty Mortise Locks

20	Single Dummy
22	Full Dummy
30	Passage
40	Privacy
45	Privacy w/ Deadbolt
50	Entry
52	Exit
54	Corridor
58	Dormitory
60	Classroom
62	Classroom Security
64	Apartment
70	Storeroom
72	Institutional
74	Store Door

E	Sierra
M	Summit
A	Slate

KD	Keyed Different
KA	Keyed Alike
SK	Special Keying
	-Construction Keyed
	-Construction Master Keyed
	-Maison Keyed
	-Master Keyed
	-Grand Master Keyed
	-Great Grand Master Keyed
ZB	Zero Bitted

Base Part Number						
Series	Function	Design	Finish	Keyway	# of Pins	Keying
<b>QME1</b>	<b>60</b>	<b>E</b>	<b>626</b>	<b>BF</b>	<b>6</b>	<b>KD</b>

Escutcheon Trim	QME1
Sectional Trim	QMS1

605	Bright Brass
613	Oil Rubbed Bronze
619	Satin Nickel
625	Bright Chrome
626	Satin Chrome

BF	BEST "F" SFIC
KW	Kwikset "KW"
WE	Weiser "E"
SC	Schlage "C"
GA	Yale "GA"
LA	Sargent "LA"
LC	Less Cylinder

### Example

If you ordered: QME160 E626 BF6 KD

You would get: Grade 1 Classroom Mortise Lock, Sierra Lever Escutcheon Trim, Satin Chrome, SFIC "F" Keyway, Keyed Different.

# STANLEY Commercial Hardware

## QMS/QME100 Series | Grade 1 | Heavy Duty Mortise Locks

### Sierra (E)

Available in: 605, 613, 619,  
625, 626



### Summit (M)

Available in: 605, 613, 619,  
625, 626



Model/Series	Functions	Style	Cylinders	Case Qty	List Price	
					626	605, 613, 619, 625
QMS120	Single Dummy	E / M / A		4	140.00	155.00
QMS122	Full Dummy	E / M / A		4	278.00	293.00
QMS130	Passage	E / M / A		4	425.00	440.00
QMS140	Privacy	E / M / A		4	430.00	445.00
QMS145	Privacy w/ Dead bolt	E / M / A		4	456.00	471.00
QMS150	Entry	E / M / A	Sgl	4	499.00	514.00
QMS152	Exit	E / M / A	Sgl	4	499.00	514.00
QMS154	Corridor	E / M / A	Sgl	4	499.00	514.00
QMS158	Dormitory	E / M / A	Dbl	4	547.00	562.00
QMS160	Classroom	E / M / A	Sgl	4	499.00	514.00
QMS162	Classroom Security	E / M / A	Dbl	4	547.00	562.00
QMS164	Apartment	E / M / A	Dbl	4	547.00	562.00
QMS170	Storeroom	E / M / A	Sgl	4	499.00	514.00
QMS172	Institutional	E / M / A	Dbl	4	547.00	562.00
QMS174	Store Door	E / M / A	Dbl	4	547.00	562.00

Less Cylinder		List Price
LC	Less Cylinder	Deduct 47.00

**NOTES:**

Consult factory for lead times on 605 & 625 finishes.

Prices include standard cylinders. Reference cylinder options for complete listing.

# STANLEY Commercial Hardware

## QMS/QME100 Series | Grade 1 | Heavy Duty Mortise Locks

### Sierra (E)

Available in: 605, 613, 619,  
625, 626



### Summit (M)

Available in: 605, 613, 619,  
625, 626



Model/Series	Functions	Style	Cylinders	Case Qty	List Price	
					626	605, 613, 619, 625
QME120	Single Dummy	E / M / A		4	171.00	186.00
QME122	Full Dummy	E / M / A		4	340.00	356.00
QME130	Passage	E / M / A		4	483.00	499.00
QME140	Privacy	E / M / A		4	488.00	502.00
QME145	Privacy w/ Dead bolt	E / M / A		4	514.00	530.00
QME150	Entry	E / M / A	Sgl	4	555.00	571.00
QME152	Exit	E / M / A	Sgl	4	555.00	571.00
QME154	Corridor	E / M / A	Sgl	4	555.00	571.00
QME158	Dormitory	E / M / A	Dbl	4	602.00	617.00
QME160	Classroom	E / M / A	Sgl	4	555.00	571.00
QME162	Classroom Security	E / M / A	Dbl	4	602.00	617.00
QME164	Apartment	E / M / A	Dbl	4	602.00	617.00
QME170	Storeroom	E / M / A	Sgl	4	555.00	571.00
QME172	Institutional	E / M / A	Dbl	4	602.00	617.00
QME174	Store Door	E / M / A	Dbl	4	602.00	617.00

Less Cylinder		List Price
LC	Less Cylinder	Deduct 47.00

**NOTES:**

Consult factory for lead times on 605 & 625 finishes.

Prices include standard cylinders. Reference cylinder options for complete listing.

# STANLEY Commercial Hardware

## QMS/QME100 Series | Grade 1 | Heavy Duty Mortise Locks

### CYLINDER RING CHART - ESCUTCHEON TRIMS

Model #	Door Thickness	Cylinder Length	Guard Dimension	Part Number	Qty*	List Price Single	Model #	Door Thickness	Cylinder Length	Guard Dimension	Part Number	Qty*	List Price Double
Escutcheon Single Cylinder QME150, QME152, QME154, QME160, QME170	1-3/4"	1"		-			Escutcheon Double Cylinder QME158, QME162, QME164, QME172, QME174	1-3/4"	1"		-		
		1-1/8"		-					1-1/8"		N/A		
		1-1/4"		-					1-1/4"		N/A		
		1-3/8"	1/2"	8Q01086	1	24.00			1-3/8"	1/2"	8Q01086	1	24.00
		1-1/2"	1/2"	8Q01086	1	24.00			1-1/2"	5/8"	8Q01087	1	28.00
	2"	1"		N/A				1"		N/A			
		1-1/8"		-				1-1/8"		-			
		1-1/4"		-				1-1/4"		N/A			
		1-3/8"		-				1-3/8"		N/A			
		1-1/2"	1/2"	8Q01086	1	24.00		1-1/2"	1/2"	8Q01086	1	24.00	
	2-1/4"	1"		N/A				1"		N/A			
		1-1/8"		N/A				1-1/8"		N/A			
		1-1/4"		-				1-1/4"		-			
		1-3/8"		-				1-3/8"		-			
		1-1/2"		-				1-1/2"		N/A			

**NOTES:**

"-" Additional cylinder spacers not required.

"N/A" Cylinder length not compatible with door thickness.

### CYLINDER RING CHART - SECTIONAL TRIMS

Model #	Door Thickness	Cylinder Length	Guard Dimension	Part Number	Qty*	List Price Single	Model #	Door Thickness	Cylinder Length	Guard Dimension	Part Number	Qty*	List Price Double
Sectional Single Cylinder QMS150, QMS152, QMS154, QMS160, QMS170	1-3/4"	1"		-			Sectional Double Cylinder QMS158, QMS162, QMS164, QMS172, QMS174	1-3/4"	1"		-		
		1-1/8"		-					1-1/8"	1/16"	8Q01088	1	16.00
		1-1/4"		-					1-1/4"	3/16"	8Q01089	1	20.00
		1-3/8"	3/16"	8Q01089	1	20.00			1-3/8"	5/16"	8Q01090	1	24.00
		1-1/2"	5/16"	8Q01090	1	24.00			1-1/2"	7/16"	8Q01091	1	28.00
	2"	1"		N/A				1"		N/A			
		1-1/8"		-				1-1/8"		-			
		1-1/4"		-				1-1/4"	1/16"	8Q01088	1	16.00	
		1-3/8"		-				1-3/8"	3/16"	8Q01089	1	20.00	
		1-1/2"	1/16"	8Q01088	1	16.00		1-1/2"	5/16"	8Q01090	1	24.00	
	2-1/4"	1"		N/A				1"		N/A			
		1-1/8"		N/A				1-1/8"		N/A			
		1-1/4"		-				1-1/4"		-			
		1-3/8"		-				1-3/8"	1/16"	8Q01088	1	16.00	
		1-1/2"		-				1-1/2"	3/16"	8Q01089	1	20.00	

**NOTES:**

"-" Additional cylinder spacers not required.

"N/A" Cylinder length not compatible with door thickness.

# STANLEY Commercial Hardware

## QMS/QME100 Series | Grade 1 | Heavy Duty Mortise Locks

### SECTIONAL TRIM KITS (SPECIFY FINISH WHEN ORDERING)

Sectional trim kits include interior and exterior trims, screw pack for trim installation and strike dust box. Trim kits are shipped in the standard mortise packaging allowing mortise cases to be configured for a complete lock.

Model #	Trim Description			Order Part #	Qty	Master Carton	List Price					
	Exterior (Secure)	Interior	Lever Style				626	603, 613, 625, 626				
QMS130	Lever	Lever	E	8Q01093	1	4	280.00	292.00				
			M	8Q01094								
QMS 140	Lever, emergency access plate	Lever, turnpiece	E	8Q01066								
QMS 145			M	8Q01067								
QMS150	Lever, cylinder collar	Lever	E	8Q01072								
QMS 160												
QMS 170									M	8Q01073		
QMS152	Lever, cylinder collar	Lever, turnpiece	E	8Q01070								
QMS 154			M	8Q01071								
QMS158	Lever, cylinder, collar	Lever, cylinder, collar	E	8Q01068								
QMS 162												
QMS 164												
QMS 172												
QMS 174			M	8Q01069								
ALL	Cylinder collar kit (Includes standard cylinder guard, wave washer and gap washer)			8Q01016					1	1	35.00	41.00
ALL	Turnpiece assembly (Requires screw pack 8Q01030)			8Q01014					1	1	40.00	45.00

# STANLEY Commercial Hardware

## QMS/QME100 Series | Grade 1 | Heavy Duty Mortise Locks

### ESCUTCHEON TRIM KITS (SPECIFY FINISH WHEN ORDERING)

Escutcheon trim kits include interior and exterior trims, screw pack for trim installation and strike dust box. Trim kits are shipped in the standard mortise packaging allowing mortise cases to be configured for a complete lock.

Model #	Trim Description			Order Part #	Qty	Master Carton	List Price	
	Exterior (Secure)	Interior	Lever Style				626	605, 613, 619, 625
QME130	Lever	Lever	E	8Q01074	1	4	354.00	354.00
			M	8Q01075				
QME140	Lever, Emergency Access Hole	Lever, Turnpiece	E	8Q01076				
QME145			M	8Q01077				
QME150			E	8Q01082				
QME160	Lever, Cylinder Hole	Lever	M	8Q01083				
QME170								
QME152	Lever, Cylinder Hole	Lever, Turnpiece	E	8Q01080				
QME154			M	8Q01081				
QME158	Lever, Cylinder Hole	Lever, Cylinder Hole	E	8Q01078				
QME162								
QME164			M	8Q01079				
QME172								
QME174								

# STANLEY Commercial Hardware

## QMS/QME100 Series | Grade 1 | Heavy Duty Mortise Locks

### MORTISE CASE KITS

Mortise case kits include case, instruction sheets & template, and case mounting screws.

Model #	Case Description		Order Part #	QTY	List Price
QMS/QME130	F1	Passage	8Q01059	1	141.00
QMS/QME140	F22	Privacy	8Q01054	1	147.00
QMS/QME145	F19	Privacy with Deadbolt	8Q01061	1	170.00
QMS/QME150	F4	Entry	8Q01058		
QMS/QME152	F13	Exit	8Q01063		
QMS/QME154	F20	Corridor	8Q01060		
QMS/QME158	F11	Dormitory	8Q01064		
QMS/QME160	F5	Classroom	8Q01057		
QMS/QME162	F32	Classroom Security	8Q01052		
QMS/QME164	F9	Apartment	8Q01055		
QMS/QME170	F7	Storeroom	8Q01056		
QMS/QME172	F30	Institutional	8Q01053		
QMS/QME174	F14	Store Door	8Q01062		

### ARMOR FRONT KITS (SPECIFY FINISH WHEN ORDERING)

Armor front kits include a finished armor front and installation screws.

Model #	Description				Order Part #	Qty	List Price
	Latch	Deadbolt	Auxiliary	Toggle			
QMS/QME120					8Q01040	1	16.00
QMS/QME130	x				8Q01033		
QMS/QME140	x						
QMS/QME145					8Q01043		
QMS/QME152	x						
QMS/QME174							
QMS/QME150	x		x	x	8Q01042		
QMS/QME154	x	x		x	8Q01032		
QMS/QME158							
QMS/QME160							
QMS/QME162							
QMS/QME164	x		x		8Q01031		
QMS/QME170							
QMS/QME172							

# STANLEY Commercial Hardware

## QMS/QME100 Series | Grade 1 | Heavy Duty Mortise Locks

### STRIKE KITS (SPECIFY FINISH WHEN ORDERING)

Strike kits include finished strike and installation screws.

Model #	Strike Description	Order Part #	Qty	List Price
QMS/QME130	Strike for locks with latch bolt only or latch bolt with auxiliary.	8Q01035	1	15.00
QMS/QME140				
QMS/QME150				
QMS/QME160				
QMS/QME162				
QMS/QME164				
QMS/QME170				
QMS/QME172				
QMS/QME145	Strike for locks with latch bolt with dead bolt.	8Q01036		
QMS/QME152				
QMS/QME154				
QMS/QME158				
QMS/QME174				
ALL	Strike dust box, black plastic	8Q01045	1	6.30

### SCREW PACKS AND OTHER PARTS

Part Description	Order Part #	QTY	List Price
Mortise case front bracket (bracket that connects armor front to lock case)	8Q01028	1	14.00
Screw pack - Trim only. Specify finish. (2 - M4x0.7 x 35mm flat head machine screws)	8Q01029	1	6.00
Screw pack - Turnpiece / Sectional Emergency Plate. Specify finish. (2 - M4 x 19mm flat head machine screws and 2 - #8-32 x 3/4" flat head wood screws)	8Q01030	1	6.00
Sectional Thick Door Kit - interior lever assembly for 2" - 2-1/4" doors	8Q01044	1	32.00
Spanner wrench for sectional lever installation	8Q01046	1	6.00
Screw pack - Armor Front. Specify finish. (2 - 0.7 x 5mm flat head machine screws)	8Q01047	1	5.40
Screw pack - Mortise Case.	8Q01048	1	6.00
Screw pack - Escutcheon Trims (for installation of trims, armor front and strike). Specify finish. (2 - M4 x 0.7 x 35mm flat head machine screws; 2 - #12 x 3/4" dual purpose screws; 2 - M4 x 0.7 x 5mm flat head machine screws)	8Q01049	1	14.00
Screw pack - Sectional Trims (for installation of trims, armor front and strike). Specify finish. (2 - M4 x 0.7 x 35mm flat head machine screws; 2 - #12 x 3/4" dual purpose screws; 2 - M4 x 0.7 x 5mm flat head machine screws; 2 - #8-32 x 3/4" flat head wood screws; 2 - M4 x 19mm flat head machine screws; 1 1/8" allen wrench)	8Q01050	1	16.00
Mortise cam - Cloverleaf (All STANLEY Commercial Hardware Mortise Locks & Deadlocks)	8Q01084	1	1.80



# STANLEY Commercial Hardware

## QML100 Series | Grade 1 | Heavy Duty Mortise Locks

<b>80</b>	Single Cylinder
<b>82</b>	Double Cylinder
<b>84</b>	Cylinder Only
<b>86</b>	Classroom

<b>KD</b>	Keyed Different
<b>KA</b>	Keyed Alike
<b>SK</b>	Special Keying
	-Construction Keyed
	-Construction Master Keyed
	-Maison Keyed
	-Master Keyed
	-Grand Master Keyed
	-Great Grand Master Keyed
<b>ZB</b>	Zero Bitted

Base Part Number						
Series	Function	Finish	Handing*	Keyway	# of Pins	Keying
<b>QML1</b>	<b>86</b>	<b>626</b>	<b>RH</b>	<b>BF</b>	<b>6</b>	<b>KD</b>

<b>605</b>	Bright Brass
<b>613</b>	Oil Rubbed Bronze
<b>619</b>	Satin Nickel
<b>625</b>	Bright Chrome
<b>626</b>	Satin Chrome

<b>BF</b>	BEST "F" SFIC
<b>KW</b>	Kwikset "KW"
<b>WE</b>	Weiser "E"
<b>SC</b>	Schlage "C"
<b>GA</b>	Yale "GA"
<b>LA</b>	Sargent "LA"
<b>LC</b>	Less Cylinder

QML186 Only*	
<b>RH</b>	Right Hand
<b>LH</b>	Left Hand

### Example

If you ordered: QML186 626 RH BF6 KD

You would get: Grade 1 Classroom Mortise Lock, Satin Chrome, Right-Hand, SFIC "F" Keyway, Keyed Different.

#### NOTES:

\*Classroom function requires handed cylinder turn. Specify handing when ordering.

# STANLEY Commercial Hardware

## QML100 Series | Grade 1 | Heavy Duty Mortise Locks



QML 180

Model/Series	Functions	Case Qty	List Price	
			626	605, 613, 619, 625
QML180	Single Cylinder	10	241.00	252.00
QML182	Double Cylinder	10	271.00	282.00
QML184	Cylinder Only	10	204.00	204.00
QML186*	Classroom	10	247.00	256.00

**NOTES:**

\*QML100 are special order, consult factory for lead times.

\*Classroom function requires handed cylinder turn. Specify handing when ordering. Prices include standard cylinders. Reference cylinder options for complete listing.

# STANLEY Commercial Hardware

## QML100 Series | Grade 1 | Heavy Duty Mortise Locks

### MORTISE DEADLOCK KITS

Mortise deadlock kits include case, instruction sheets & template, and case mounting screws.

Model #	Description	Order Part #	Qty	List Price
ALL QML	Mortise deadlock case	8Q01051	1	134.00

### ARMOR FRONT KITS (SPECIFY FINISH WHEN ORDERING)

Armor front kits include a finished armor front and installation screws.

Model #	Description	Order Part #	Qty	List Price
ALL QML	Mortise deadlock armor front	8Q01039	1	11.00

### STRIKE KITS (SPECIFY FINISH WHEN ORDERING)

Strike kits include finished strike and installation screws.

Model #	Description	Order Part #	Qty	List Price
ALL QML	Mortise deadlock strike	8Q01034	1	9.10
ALL QML	Deadlock strike dust box, black plastic	8Q01085	1	5.80

### DEADLOCK TRIM KITS (SPECIFY FINISH WHEN ORDERING)

Description	Order Part #	Qty	List Price	
			626	605, 613, 619, 625
Cylinder guard kit (Includes standard cylinder guard, wave washer and gap washer)	8Q01016	1	35.00	41.00
Turnpiece assembly (Requires screw pack 8Q01030)	8Q01014	1	40.00	45.00

### MISC.

Model #	Description	Order Part #	Qty	List Price
QML 186	Left hand mortise cylinder thumbturn	8Q01005	1	50.00
QML 186	Right hand mortise cylinder thumbturn	8Q01006	1	50.00

# STANLEY Commercial Hardware

## QCL100 Series | Grade 1 | Heavy Duty Cylindrical Locks

20	Single Dummy	<b>ADDED FUNCTIONS</b>	
30	Passage	92	Electronically Locked (fail safe)
35	Communicating	93	Electronically Locked SFIC (fail safe)
40	Privacy	94	Electronically Unlocked (fail secure)
50	Entry/Office	95	Electronically Unlocked SFIC (fail secure)
51	Entry/Office SFIC		
54	Corridor		
55	Corridor SFIC		
60	Classroom		
61	Classroom SFIC	605	Bright Brass
68	Classroom Security	613	Oil Rubbed Bronze
69	Classroom Security SFIC	619	Satin Nickel
70	Storeroom	625	Bright Chrome
71	Storeroom SFIC	626	Satin Chrome

BF	BEST "F" SFIC
KW	Kwikset "KW"
WE	Weiser "E"
SC	Schlage "C"
GA	Yale "GA"
LA	Sargent "LA"
LC	Less Cylinder

24V	24 Volt AC/DC
12V	12 Volt AC/DC

Base Part Number								
Series	Function	Design	Finish	Latch	Strike	Keyway	# Of Pins	Keying
QCL1	71	E	626	S4	478S	BF	6	KA

Additional Options			
Hurricane Compliant	Power	Request To Exit	2nd Finish
H	—	—	—

E	Sierra
M	Summit
A	Slate

478S	ANSI 4 7/8" x 1 1/4" Strike
118F	ANSI 1 1/8" x 2 3/4" Strike
NOS	No Strike

625	Bright Chrome
-----	---------------

QCL1 LATCH TABLE	
FR4	Radius 2-3/4 with 3/4 throw
FS4	Square 2-3/4 with 3/4 throw
NOL	No Latch
R4	Radius 2-3/4
R8	Radius 2-3/8
S4	Square 2-3/4
S5	Square 5
S8	Square 2-3/8

KD	Keyed Different
KA	Keyed Alike
SK	Special Keying
	-Construction Keyed
	-Construction Master Keyed
	-Maison Keyed
	-Master Keyed
	-Grand Master Keyed
	-Great Grand Master Keyed
ZB	Zero Bitted

### Example

If you ordered: QCL171 E626 S4 478S BF6 KA H

You would get: Grade 1 Hurricane Compliant Cylindrical Storeroom Lock, Sierra Lock, Satin Chrome, 2 3/4" Deadlatch Square, ANSI 4 7/8" x 1 1/4" Strike, BEST "F" Keyway, Keyed Alike.

# STANLEY Commercial Hardware

## QCL100 Series | Grade 1 | Heavy Duty Cylindrical Locks

### Sierra (E)

Available in: 605, 613, 619, 625, 626  
Privacy Split Available in: 626x625\*



### Summit (M)

Available in: 605, 613, 619, 625, 626  
Privacy Split Available in: 626x625\*



### Slate (A)

Available in: 605, 613, 619, 625, 626  
Privacy Split Available in: 626x625\*



Model/Series	Functions	Style	Case Qty	List Price	
				626	605, 613, 619, 625
QCL120	Half Dummy	E / M / A	12	123.00	128.00
QCL130	Passage	E / M / A	6	241.00	251.00
QCL135	Communicating	E / M / A	6	272.00	282.00
QCL140*	Privacy	E / M / A	6	291.00	301.00
QCL150	Entrance/Office	E / M / A	6	333.00	343.00
QCL151	Entrance/Office SFIC	E / M / A	6	377.00	387.00
QCL154	Corridor	E / M / A	6	333.00	343.00
QCL155	Corridor SFIC	E / M / A	6	377.00	387.00
QCL160	Classroom	E / M / A	6	333.00	343.00
QCL161	Classroom SFIC	E / M / A	6	377.00	387.00
QCL168	Classroom Security	E / M / A	6	360.00	370.00
QCL169	Classroom Security SFIC	E / M / A	6	404.00	414.00
QCL170	Storeroom	E / M / A	6	333.00	343.00
QCL171	Storeroom SFIC	E / M / A	6	377.00	387.00

Options		Add
H	Hurricane Compliant	5.20

NOTES:

\*Privacy split finishes are priced at the highest finish price.

# STANLEY Commercial Hardware

## QCL100 Series | Grade 1 | Heavy Duty Cylindrical Locks

### ELECTRIFIED OPTIONS (CONSULT FACTORY FOR LEAD TIMES)



Model #	Description	List Price	
		626	605/613/625
QCL192	Electronically locked (fail safe). Outside lever continuously locked electrically. Unlocked by key outside, by switch, or by power failure. Inside always free for immediate egress.	680.00	691.00
QCL193 (SFIC)		731.00	743.00
QCL194	Electronically unlocked (fail secure). Outside lever continuously locked until unlocked by key or electric current. Inside always free for immediate egress.	680.00	691.00
QCL195(SFIC)		731.00	743.00
QCL170---X	Request to exit. Switch monitors inside lever rotation. Incorporates into alarm systems or in conjunction with an electromagnet.	633.00	646.00
QCL171---X(SFIC)		686.00	698.00
QCL192---X	Electronically locked (fail safe) with request to exit. Outside lever continuously locked electrically. Unlocked by key outside, by switch, or by power failure. Inside always free for immediate egress. Ability to tie into alarm systems.	929.00	942.00
QCL193---X(SFIC)		980.00	994.00
QCL194---X	Electronically unlocked (fail secure) with request to exit. Outside lever continuously locked until unlocked by key or electric current. Inside always free for immediate egress. Ability to tie into alarm systems.	929.00	942.00
QCL195---X(SFIC)		980.00	994.00
8Q00314	Fail Safe / Fail Secure 24VDC Power Supply	822.00	822.00

#### Electrified Product Specifications

- Consult Factory for lead times.
- Electrification prices should be added to list price of lock.
- Standard door prep.
- Deadlocking latch.
- Key override allows key to retract latchbolt momentarily on electronically locked models.
- Inside lever always free for immediate egress.
- Continuous duty solenoids.
- Tie into alarm systems and electromagnetic locks.
- 12V AC/DC with .250 amp current.
- 24V AC/DC with .150 amp current.
- **Specify voltage when ordering.**
- Lifetime warranty on lock body; 1 year warranty on electric components.
- Uses power supply 8Q00314.
- Warranty: 1 Year Electrical.



#### Power Supply Specifications

- Consult Factory for lead times.
- Provides power for fail safe or fail secure locking devices.
- UL listed, US & Canada, Class 2.
- Filtered and regulated 24DC constant voltage.
- 2 AMP load capacity.
- Over voltage/short circuit protection.
- Surge suppression for locking devices.
- Interface relay to isolate the locking device current from the control switch.
- Auxilliary 24VDC constant voltage for powering stand alone devices such as keypads, motion detectors, status indicators, etc.
- Field terminal block set at 45° for ease of installation.
- Can power up to 12 24V Cylindrical fail safe/ fail secure levers - refer to installation manual for additional details.

# STANLEY Commercial Hardware

## QCL100 Series | Grade 1 | Heavy Duty Cylindrical Locks

### LATCH OPTIONS (SPECIFY FINISH)

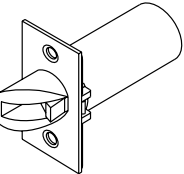
Order # With Lock	Description	Service Part #	Price With Lock	Service Part List Price	
<b>1 - 1/8" X 2 - 1/4" FACE PLATE, 1" HOUSING DIAMETER, GRADE 1, UL (WIDE FACE)</b>					
 <p>Grade 1 - Deadlatch</p>	S4	2 3/4" dead latch - square corner	8Q00172	NC	13.00
		2 3/4" dead latch - square corner - corridor function	8Q00574	NC	13.00
	R4	2 3/4" dead latch - radius corner	8Q00171	NC	13.00
		2 3/4" dead latch - radius corner - corridor function	8Q00573	NC	13.00
	S8	2 3/8" dead latch - square corner	8Q00174	NC	13.00
		2 3/8" dead latch - square corner - corridor function	8Q00576	NC	13.00
	R8	2 3/8" dead latch - radius corner	8Q00173	NC	13.00
		2 3/8" dead latch - radius corner - corridor function	8Q00575	NC	13.00
	S5	5" dead latch - square corner	8Q00175	Add 22.00	37.00
	 <p>Grade 1 - Springlatch</p>	S4	2 3/4" spring latch privacy - square corner	8Q00177	NC
2 3/4" spring latch passage - square corner			8Q00182	NC	13.00
R4		2 3/4" spring latch privacy - radius corner	8Q00176	NC	13.00
		2 3/4" spring latch passage - radius corner	8Q00181	NC	13.00
S8		2 3/8" spring latch privacy - square corner	8Q00179	NC	13.00
		2 3/8" spring latch passage - square corner	8Q00184	NC	13.00
R8		2 3/8" spring latch privacy - radius corner	8Q00178	NC	13.00
		2 3/8" spring latch passage - radius corner	8Q00183	NC	13.00
S5		5" spring latch privacy - square corner	8Q00180	Add 22.00	34.00
		5" spring latch passage - square corner	8Q00185	Add 22.00	34.00
<b>1 - 1/8" X 2 - 1/4" FACE PLATE, 1" HOUSING DIAMETER, GRADE 1, 3/4" THROW, 3 HR UL</b>					
	FS4	2 3/4" dead latch - square corner, 3/4" throw	8Q00438	Add 99.00	111.00
	FR4	2 3/4" dead latch - radius corner, 3/4" throw	8Q00437	Add 99.00	111.00
<b>NO LATCH</b>					
NOL	No Latch		Deduct 11.70		

# STANLEY Commercial Hardware

QCL100 Series | Grade 1 | Heavy Duty Cylindrical Locks

## STRIKE OPTIONS (SPECIFY FINISH)

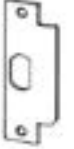
Order # With Lock		Description	Service Part #	Price With Lock	Service Part List Price
	118 F	1 1/8" x 2 3/4" T-Strike (Does not include screws. Screwpack 8Q00058)	8Q00165	NC	4.80
	478S	4 7/8" x 1 1/4" ANSI Strike (Does not include screws. Screwpack 8Q00058)	8Q00166	NC	7.60







Less Cylinder		List Price
LC	Less Cylinder	Deduct 21.00
	Less SFIC Cylinder	Deduct 44.00

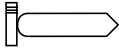
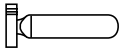
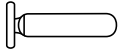

# STANLEY Commercial Hardware

## QCL100 Series | Grade 1 | Heavy Duty Cylindrical Locks

### OTHER PARTS & SCREW PACKS

	Description	Service Part #	Service Part List Price
	Installation Jig for Cylindrical Levers	8Q00075	12.00
	Tailpiece QCL150/QCL170 - Entry/Storeroom	8Q00069	2.50
	Tailpiece QCL160 - Classroom (all keyways except KW)	8Q00070	2.50
	Tailpiece QCL160 - Classroom (KW keyway only)	8Q00071	2.50
	Cylinder Plug Holder QCL100 Series	8Q00065	1.80
	Screw Pack for QCL100 Series Dummy (Specify finish)	8Q00056	1.80
	Screw Pack for QCL100 Series (Specify finish)	8Q00057	2.50
	Screw Pack for T-Strike (Specify finish)	8Q00058	1.90
	Trim Ring for Cylindrical Locks (Shims Lock off door approximately 1/8") (Available in 605, 613, 619, 626)	8Q00221	23.00

# STANLEY Commercial Hardware

## QCL200 Series | Grade 2 | Standard Duty Cylindrical Locks

20	Single Dummy
30	Passage
35	Communicating
40	Privacy
50	Entry/Office
51	Entry/Office SFIC
54	Corridor
55	Corridor SFIC
60	Classroom
61	Classroom SFIC
70	Storeroom
71	Storeroom SFIC

605	Bright Brass
613	Oil Rubbed Bronze
619	Satin Nickel
625	Bright Chrome
626	Satin Chrome

BF	BEST "F" SFIC
KW	Kwikset "KW"
WE	Weiser "E"
SC	Schlage "C"
GA	Yale "GA"
LA	Sargent "LA"
LC	Less Cylinder

Base Part Number									Additional Options	
Series	Function	Design	Finish	Latch	Strike	Keyway	# of Pins	Keying	Hurricane Compliant	2nd Finish
<b>QCL2</b>	<b>71</b>	<b>E</b>	<b>626</b>	<b>S4</b>	<b>478S</b>	<b>BF</b>	<b>6</b>	<b>KA</b>	<b>H</b>	<b>625</b>

E	Sierra
M	Summit
A	Slate

478S	ANSI 4 7/8" x 1 1/4" Strike
118F	ANSI 1 1/8" x 2 3/4" Strike
FLS	Full Lip Square Corner Strike
FLR	Full Lip 1/4" Radius Corner Strike
NOS	No Strike

613	Oil Rubbed Bronze
625	Bright Chrome

QCL2 LATCH TABLE	
FR4	Radius 2-3/4 with 3/4 throw
FS4	Square 2-3/4 with 3/4 throw
NOL	No Latch
NR4	Narrow Radius 2-3/4
NR8	Narrow Radius 2-3/8
NS4	Narrow Square 2-3/4
NS8	Narrow Square 2-3/8
R4	Radius 2-3/4
R8	Radius 2-3/8
S3	Square 3-3/4
S4	Square 2-3/4
S5	Square 5
S8	Square 2-3/8

KD	Keyed Different
KA	Keyed Alike
SK	Special Keying
	-Construction Keyed
	-Construction Master Keyed
	-Maison Keyed
	-Master Keyed
	-Grand Master Keyed
	-Great Grand Master Keyed
ZB	Zero Bitted

### Example

If you ordered: QCL271 E626 S4 478S BF6 KA H 625

You would get: Grade 2 Hurricane Compliant Cylindrical Storeroom Lock, Sierra Lever, Satin Chrome x Bright Chrome, 2 3/4" Deadlatch Square, ANSI 4 7/8" x 1 1/4" Strike, BEST "F" SFIC Keyway, Keyed Alike.

# STANLEY Commercial Hardware

## QCL200 Series | Grade 2 | Standard Duty Cylindrical Locks

### Sierra (E)

Available in: 605, 613, 619, 625, 626  
Privacy Split Available in: 626x625, 626x613\*



### Summit (M)

Available in: 605, 613, 619, 625, 626  
Privacy Split Available in: 626x625, 626x613\*



### Slate (A)

Available in: 605, 613, 619, 625, 626  
Privacy Split Available in: 626x625, 626x613\*



Model / Series	Functions	Style	Case Qty	List Price	
				626	605, 613, 619, 625
QCL220	Half Dummy	E / M / A	12	66.00	71.00
QCL230	Passage	E / M / A	6	134.00	144.00
QCL235	Communicating	E / M / A	6	143.00	153.00
QCL240*	Privacy	E / M / A	6	143.00	153.00
QCL250	Entrance/Office	E / M / A	6	169.00	179.00
QCL251	Entrance/Office SFIC	E / M / A	6	213.00	223.00
QCL254	Corridor	E / M / A	6	169.00	179.00
QCL255	Corridor SFIC	E / M / A	6	213.00	223.00
QCL260	Classroom	E / M / A	6	169.00	179.00
QCL261	Classroom SFIC	E / M / A	6	213.00	223.00
QCL270	Storeroom	E / M / A	6	169.00	179.00
QCL271	Storeroom SFIC	E / M / A	6	213.00	223.00

Less Cylinder		List Price
LC	Less Cylinder	Deduct 21.00
	Less SFIC Cylinder	Deduct 44.00

Options		Add
H	Hurricane Compliant	5.00

**NOTES:**

\* Privacy split finishes are priced at the highest finish price.

# STANLEY Commercial Hardware

## QCL200 Series | Grade 2 | Standard Duty Cylindrical Locks





### LATCH OPTIONS (SPECIFY FINISH)

Order # With Lock		Description	Service Part #	Price With Lock	Service Part List Price
<b>1 1/8" X 2 1/4" FACE PLATE, 7/8" HOUSING DIAMETER, GRADE 2, UL (WIDE FACE)</b>					
 Grade 2 - Deadlatch	S4	2 3/4" dead latch - square corner	8Q00187	NC	8.60
		2 3/4" dead latch - square corner - corridor function	8Q00578	NC	8.60
	R4	2 3/4" dead latch - radius corner	8Q00186	NC	8.60
		2 3/4" dead latch - radius corner- corridor function	8Q00577	NC	8.60
	S8	2 3/8" dead latch - square corner	8Q00189	NC	8.60
		2 3/8" dead latch - square corner - corridor function	8Q00580	NC	8.60
	R8	2 3/8" dead latch - radius corner	8Q00188	NC	8.60
		2 3/8" dead latch - radius corner - corridor function	8Q00579	NC	8.60
S3	3 3/4" dead latch - square corner	8Q00190	Add 16.00	24.00	
S5	5" dead latch - square corner	8Q00191	Add 18.00	30.00	
 Grade 2 - Springlatch	S4	2 3/4" spring latch privacy - square corner	8Q00193	NC	9.50
		2 3/4" spring latch passage - square corner	8Q00199	NC	8.60
	R4	2 3/4" spring latch privacy - radius corner	8Q00192	NC	8.60
		2 3/4" spring latch passage - radius corner	8Q00198	NC	8.60
	S8	2 3/8" spring latch privacy - square corner	8Q00195	NC	8.60
		2 3/8" spring latch passage - square corner	8Q00201	NC	8.60
	R8	2 3/8" spring latch privacy - radius corner	8Q00194	NC	8.60
		2 3/8" spring latch passage - radius corner	8Q00200	NC	8.60
	S3	3 3/4" spring latch privacy - square corner	8Q00196	Add 16.00	24.00
		3 3/4" spring latch passage - square corner	8Q00202	Add 16.00	24.00
	S5	5" spring latch privacy - square corner	8Q00197	Add 18.00	30.00
		5" spring latch passage - square corner	8Q00203	Add 18.00	30.00
<b>1" X 2 1/4" FACE PLATE, 7/8" HOUSING DIAMETER, GRADE 2, UL (NARROW FACE)</b>					
 Grade 2 - Deadlatch	NS4	2 3/4" dead latch - square corner	8Q00231	NC	8.60
	NR4	2 3/4" dead latch - radius corner	8Q00230	NC	8.60
	NS8	2 3/8" dead latch - square corner	8Q00233	NC	8.60
	NR8	2 3/8" dead latch - radius corner	8Q00232	NC	8.60
 Grade 2 - Springlatch	NS4	2 3/4" spring latch privacy - square corner	8Q00227	NC	8.60
		2 3/4" spring latch passage - square corner	8Q00223	NC	8.60
	NR4	2 3/4" spring latch privacy - radius corner	8Q00226	NC	8.60
		2 3/4" spring latch passage - radius corner	8Q00222	NC	8.60
	NS8	2 3/8" spring latch privacy - square corner	8Q00229	NC	8.60
		2 3/8" spring latch passage - square corner	8Q00225	NC	8.60
NR8	2 3/8" spring latch privacy - radius corner	8Q00228	NC	8.60	
	2 3/8" spring latch passage - radius corner	8Q00224	NC	8.60	
<b>1 1/8" X 2 1/4" FACE PLATE, 1" HOUSING DIAMETER, GRADE 1, 3/4" THROW, 3 HR UL</b>					
	FS4	2 3/4" dead latch, square corner, 3/4" throw	8Q00438	Add 99.00	111.00
	FR4	2 3/4" dead latch, radius corner, 3/4" throw	8Q00437	Add 99.00	111.00
<b>WIDE FACE LATCH FILLER</b>					
		Wide face latch adaptor plate (converts 1" latch face plate to 1 1/8")	8Q00217		1.40
<b>NO LATCH</b>					
NOL		No Latch		Deduct 7.80	

# STANLEY Commercial Hardware

## QCL200 Series | Grade 2 | Standard Duty Cylindrical Locks







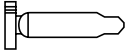
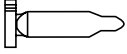

### STRIKE OPTIONS (SPECIFY FINISH)

Order # With Lock		Description	Service Part #	Price With Lock	Service Part List Price
	118 F	2 3/4" x 1 1/8" T-Strike (Does not include screws. Screwpack 8Q00058)	8Q00165	NC	4.80
	478S	4 7/8" x 1 1/4" ANSI Strike (Does not include screws. Screwpack 8Q00058)	8Q00166	NC	7.60
	FLR	2 1/4" Full Lip Round Corner Strike UL	8Q00241	NC	4.50
	FLS	2 1/4" Full Lip Square Corner Strike UL	8Q00240	NC	4.50
<b>NO STRIKE</b>					
NOS	No Strike			Deduct 4.10	

# STANLEY Commercial Hardware

## QCL200 Series | Grade 2 | Standard Duty Cylindrical Locks

### OTHER PARTS & SCREW PACKS

	Description	Service Part #	Service Part List Price
	Installation Jig for Cylindrical Levers	8Q00075	12.00
	Tailpiece QCL250/QCL270 - Entry/Storeroom	8Q00072	2.50
	Tailpiece QCL260 - Classroom	8Q00074	2.50
	SFIC Tailpiece for QCL200 Series	8Q00302	2.40
	Cylinder Plug Holder QCL200 Series	8Q00066	1.80
	Screw Pack & Tailpiece SFIC for QCL200 Series (Specify finish)	8Q00064	3.70
	Screw Pack for QCL200 Series Dummy (Specify finish)	8Q00059	1.90
	Screw Pack for QCL200 Series (Specify finish)	8Q00061	2.50
	Screw Pack for T-Strike (Specify finish)	8Q00058	1.90
	Trim Ring for Cylindrical Locks (Shims Lock off door approximately 1/8") (Available in 605, 613, 619, 626)	8Q00221	23.00

# STANLEY Commercial Hardware

## QCI200 Series | Grade 2 | Standard Duty Interconnected Locks

30	Single-Locking (Passage Lever)
31	Single-Locking SFIC (Passage Lever)
50	Double-Locking (Entry Lever)
51	Double-Locking SFIC (Entry Lever)
85	Indicator (Passage Lever)

605	Bright Brass
613	Oil Rubbed Bronze
619	Satin Nickel
626	Satin Chrome

BF	BEST "F" SFIC
SMT	Re-Key*
KW	Kwikset "KW"
WE	Weiser "E"
SC	Schlage "C"
GA	Yale "GA"
LA	Sargent "LA"
LC	Less Cylinder

Base Part Number								
Series	Function	Design	Finish	Latch	Strike	Keyway	# Of Pins	Keying
QCI2	31	E	626	NR4	118F	BF	6	KD

E	Sierra
M	Summit
A	Slate

KD	Keyed Different
KA	Keyed Alike
SK	Special Keying
	-Construction Keyed
	-Construction Master Keyed
	-Maison Keyed
	-Master Keyed
	-Grand Master Keyed
	-Great Grand Master Keyed
ZB	Zero Bitted

Order w/Lock	Lever & Deadbolt Latch
NR4	Narrow Radius 2-3/4
NS4	Narrow Square 2-3/4
NS8	Narrow Square 2-3/8
R4	Radius 2-3/4
S4	Square 2-3/4
S8	Square 2-3/8

Order w/Lock	Lever Latch	Deadbolt Latch
NR8	Narrow Radius 2-3/8	Narrow Radius 2-3/4
R8	Radius 2-3/8	Radius 2-3/4

Order w/Lock	Lever Strike	Deadbolt Strike
118F	118F	DBS
478S	478S	DBS
FLS	FLS	DBS
FLR	FLR	DBS
FLS2	FLS	FLS
FLR2	FLR	FLR
NOS	No Strikes	

**NOTES:**

\* Re-key available on QCI230 function only

**Example**

If you ordered: QCI231 E626 NR4 118F BF6 KD

You would get: Grade 2 Interconnect Single SFIC Lock, Sierra Lever, Satin Chrome, 2 3/8" Narrow Radius Latches, "T" Strike with Standard Deadbolt Strike, BEST "F" SFIC Keyway, Keyed Different.

# STANLEY Commercial Hardware

## QCI200 Series | Grade 2 | Standard Duty Interconnected Locks

### Sierra (E)

Available in: 605, 613, 619, 626



### Summit (M)

Available in: 605, 613, 619, 626



### Slate (A)

Available in: 605, 613, 619, 626



Model/Series	Functions	Style	Case Qty	List Price	
				626	605, 613, 619
QCI230	Single Locking (Passage Lever)	E / M / A	6	308.00	320.00
QCI231	Single Locking SFIC (Passage Lever)	E / M / A	6	334.00	347.00
QCI250	Double Locking (Entry Lever)	E / M / A	6	342.00	354.00
QCI251	Double Locking SFIC	E / M / A	6	436.00	450.00
QCI285	Indicator	E / M / A	6	345.00	360.00

Less Cylinder		List Price
LC	Less Cylinder	Deduct 21.00
	Less SFIC Cylinder	Deduct 44.00

Order w/ Lock	Description	w/ Lock
FT	QCI200 Exterior Escutcheon Trim	Add 24.00

**NOTES:**

Re-Key Available on QCI230 Functions only.

Consult factory for lead times on 605 finish.







# STANLEY Commercial Hardware

## QCI200 Series | Grade 2 | Standard Duty Interconnected Locks

### LATCH COMBINATIONS (SPECIFY FINISH)

Order # With Lock	Lever Latch	Deadbolt Latch	Price With Lock	
QCI230/231	S4	2 3/4" spring latch, square corner, 1 1/8" Face	2 3/4" bolt latch, square corner, 1 1/8" Face	NC
	R4	2 3/4" spring latch, radius corner, 1 1/8" Face	2 3/4" bolt latch, radius corner, 1 1/8" Face	NC
	S8	2 3/8" spring latch, square corner, 1 1/8" Face	2 3/8" bolt latch, square corner, 1 1/8" Face	NC
	R8	2 3/8" spring latch, radius corner, 1 1/8" Face	2 3/8" bolt latch, radius corner, 1 1/8" Face	NC
	NS4	2 3/4" spring latch, square corner, 1" Face	2 3/4" bolt latch, square corner, 1" Face	NC
	NR4	2 3/4" spring latch, radius corner, 1" Face	2 3/4" bolt latch, radius corner, 1" Face	NC
	NS8	2 3/8" spring latch, square corner, 1" Face	2 3/8" bolt latch, square corner, 1" Face	NC
	NR8	2 3/8" spring latch, radius corner, 1" Face	2 3/8" bolt latch, radius corner, 1" Face	NC
QCI250/251	S4	2 3/4" dead latch, square corner, 1 1/8" Face	2 3/4" bolt latch, square corner, 1 1/8" Face	NC
	R4	2 3/4" dead latch, radius corner, 1 1/8" Face	2 3/4" bolt latch, radius corner, 1 1/8" Face	NC
	S8	2 3/8" dead latch, square corner, 1 1/8" Face	2 3/8" bolt latch, square corner, 1 1/8" Face	NC
	R8	2 3/8" dead latch, radius corner, 1 1/8" Face	2 3/8" bolt latch, radius corner, 1 1/8" Face	NC
	NS4	2 3/4" dead latch, square corner, 1" Face	2 3/4" bolt latch, square corner, 1" Face	NC
	NR4	2 3/4" dead latch, radius corner, 1" Face	2 3/4" bolt latch, radius corner, 1" Face	NC
	NS8	2 3/8" dead latch, square corner, 1" Face	2 3/8" bolt latch, square corner, 1" Face	NC
	NR8	2 3/8" dead latch, radius corner, 1" Face	2 3/8" bolt latch, radius corner, 1" Face	NC
<b>NO LATCH</b>				
NOL	No Latch (Lever & Deadbolt)		Deduct 23.00	



### LATCH OPTIONS (SPECIFY FINISH)

Order as parts only	Description	Service Part #	Service Part List Price	
	<b>1 - 1/8" X 2 - 1/4" FACE PLATE, 7/8" HOUSING DIAMETER, GRADE 2, UL (WIDE FACE)</b>			
	S4	2 3/4" spring latch passage - square corner	8Q00199	8.60
	R4	2 3/4" spring latch passage - radius corner	8Q00198	8.60
	S8	2 3/8" spring latch passage - square corner	8Q00201	8.60
	S4	2 3/4" dead latch - square corner	8Q00187	8.60
	R4	2 3/4" dead latch - radius corner	8Q00186	8.60
	S8	2 3/8" dead latch - square corner	8Q00189	8.60
	R8	2 3/8" dead latch - radius corner	8Q00188	8.60
	<b>1" X 2 - 1/4" NARROW FACE PLATE, 7/8" HOUSING DIAMETER, GRADE 2, UL (NARROW FACE)</b>			
	NS4	2 3/4" spring latch passage - square corner	8Q00223	8.60
	NR4	2 3/4" spring latch passage - radius corner	8Q00222	8.60
	NS8	2 3/8" spring latch passage - square corner	8Q00225	8.60
	NR8	2 3/8" spring latch passage - radius corner	8Q00224	8.60
	NS4	2 3/4" dead latch - square corner	8Q00231	8.60
	NR4	2 3/4" dead latch - radius corner	8Q00230	8.60
	NS8	2 3/8" dead latch - square corner	8Q00233	8.60
	NR8	2 3/8" dead latch - radius corner	8Q00232	8.60

# STANLEY Commercial Hardware

QCI200 Series | Grade 2 | Standard Duty Interconnected Locks

## DEADBOLT OPTIONS (SPECIFY FINISH)

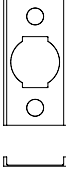
Order as parts only		Description	Service Part #	Service Part List Price
 <p>Grade 2 - Boltlatch</p>	<b>DEADBOLT: 1 -1/8" X 2 -1/4" FACE PLATE, DEADBOLT, UL (WIDE FACE)</b>			
	S4	2 3/4" deadbolt - square corner	8Q00321	16.00
	R4	2 3/4" deadbolt - radius corner	8Q00320	16.00
	S8	2 3/8" deadbolt - square corner	8Q00319	16.00
	R8	2 3/8" deadbolt - radius corner	8Q00318	16.00
 <p>Grade 2 - Boltlatch</p>	<b>DEADBOLT: 1" X 2 -1/4" FACE PLATE, DEADBOLT, UL (NARROW FACE)</b>			
	NS4	2 3/4" deadbolt - square corner	8Q00442	16.00
	NR4	2 3/4" deadbolt - radius corner	8Q00441	16.00
	NS8	2 3/8" deadbolt - square corner	8Q00440	16.00
	NR8	2 3/8" deadbolt - radius corner	8Q00439	16.00
	<b>WIDE FACE LATCH FILLER</b>			
		Wide face latch adaptor plate (converts 1" latch face plate to 1 1/8")	8Q00217	1.40

# STANLEY Commercial Hardware

## QCI200 Series | Grade 2 | Standard Duty Interconnected Locks

### STRIKE COMBINATIONS (SPECIFY FINISH)

Order # With Lock	Lever Latch	Deadbolt Latch	Service Part List Price
118F	2 3/4" x 1 1/8" T-Strike	Standard Deadbolt Strike	NC
478S	ANSI 4 7/8" x 1 1/4" Strike	Standard Deadbolt Strike	Add 2.80
FLS	Full Lip Square Corner Strike	Standard Deadbolt Strike	NC
FLR	Full Lip Radius Corner Strike	Standard Deadbolt Strike	NC
FLS2	Full Lip Square Corner Strike	Full Lip Square Corner Strike	NC
FLR2	Full Lip Radius Corner Strike	Full Lip Radius Corner Strike	NC
<b>NO STRIKE</b>			
NOS	No Strike		Deduct 8.20







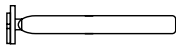
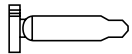
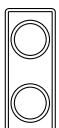

Order as parts only		Description	Service Part #	Service Part List Price
<b>LEVER</b>				
	118 F	2 3/4" x 1 1/8" T-Strike	8Q00165	4.80
	478S	ANSI 4 7/8" x 1 1/4" Strike	8Q00166	7.60
	FLS	Full Lip Square Corner Strike	8Q00240	4.50
	FLR	Full Lip Radius Corner Strike	8Q00241	4.50
<b>DEADBOLT</b>				
	DBS	2 3/4" x 1 1/8" Deadbolt Strike - Square	8Q00164	4.60
	DBR	2 3/4" x 1 1/8" Deadbolt Strike - Radius	8Q00530	4.60
	478DS	ANSI 4 7/8" x 1 1/4" Deadbolt Strike	8Q00244	7.60
	FLS	2 1/4" Full Lip Square Corner Deadbolt Strike	8Q00317	4.60
	FLR	2 1/4" Full Lip Radius Corner Deadbolt Strike	8Q00316	4.60

Less Cylinder			List Price
LC	Less Cylinder		Deduct 21.00
	Less SFIC Cylinder		Deduct 44.00

# STANLEY Commercial Hardware

## QCI200 Series | Grade 2 | Standard Duty Interconnected Locks

### OTHER PARTS & SCREW PACKS

	Description	Service Part #	Service Part List Price
	QCI200 Series deadbolt tailpiece	8Q00083	2.50
	Tailpiece QCI200 Series	8Q00072	2.50
	QCI200 Series outside escutcheon trim - 4" center to center (Specify finish)	8Q00303	23.00
	QCI200 Series Screw Pack	8Q00304	2.50
	QCI251 Screw Pack	8Q00305	2.50
	QCI231 Screw Pack	8Q00306	2.50
	QCI200 Series Door Thickness Adjustment Gauge	8Q00307	1.90
	QCI200 Series IC Core Tailpiece	8Q00308	2.50
	Indicator Emergency Key	8Q00531	2.30
	Re-Key Learn Tool	8Q00555	4.60

# STANLEY Commercial Hardware

## QTL200 Series | Grade 2 | Standard Duty Tubular Locks

20	Single Dummy
30	Passage
40	Privacy
50	Entry/Office
51	Entry/Office SFIC
60	Classroom
61	Classroom SFIC
70	Storeroom
71	Storeroom SFIC

605	Bright Brass
613	Oil Rubbed Bronze
619	Satin Nickel
625	Bright Chrome
626	Satin Chrome

BF	BEST "F" SFIC
KW	Kwikset "KW"
WE	Weiser "E"
SC	Schlage "C"
GA	Yale "GA"
LA	Sargent "LA"
LC	Less Cylinder

Base Part Number									Additional Options	
Series	Function	Design	Finish	Latch	Strike	Keyway	# of Pins	Keying	Hurricane Compliant	2nd Finish
QTL2	71	E	626	SA	FLR	BF	6	KA	H	625

E	Sierra
M	Summit
A	Slate

478S	ANSI 4 $\frac{7}{8}$ " x 1 $\frac{1}{4}$ " Strike
118F	ANSI 1 $\frac{1}{8}$ " x 2 $\frac{3}{4}$ " Strike
FLS	Full Lip Square Corner Strike
FLR	Full Lip $\frac{1}{4}$ " Radius Corner Strike
NOS	No Strike

625	Bright Chrome
-----	---------------

QTL2 LATCH TABLE (New)	
RA	Adjustable Radius
SA	Adjustable Square
NOL	No Latch

KD	Keyed Different
KA	Keyed Alike
SK	Special Keying
	-Construction Keyed
	-Construction Master Keyed
	-Maison Keyed
	-Master Keyed
	-Grand Master Keyed
	-Great Grand Master Keyed
ZB	Zero Bitted

### Example

If you ordered: QTL271 E 626 SA FLR BF 6 KA H 625

You would get: Grade 2 Hurricane Compliant Tubular Storeroom SFIC Lock, Sierra Lever, Satin Chrome x Bright Chrome, Adjustable Square Latch, Full Lip  $\frac{1}{4}$ " Radius Corner Strike, Standard "F" Keyway, Keyed Alike.

# STANLEY Commercial Hardware

## QTL200 Series | Grade 2 | Standard Duty Tubular Locks

### Sierra (E)

Available in: 605, 613, 619, 625, 626  
Privacy Split Available in: 626x625\*



### Summit (M)

Available in: 605, 613, 619, 625, 626  
Privacy Split Available in: 626x625\*



### Slate (A)

Available in: 605, 613, 619, 625, 626  
Privacy Split Available in: 626x625\*



Model/Series	Functions	Style	Case Qty	List Price	
				626	605, 613, 619, 625
QTL220	Half Dummy	E / M / A	12	52.00	59.00
QTL230	Passage	E / M / A	10	104.00	118.00
QTL240*	Privacy	E / M / A	10	112.00	125.00
QTL250	Entry/Office	E / M / A	10	126.00	139.00
QTL251	Entry/Office SFIC	E / M / A	10	174.00	188.00
QTL260	Classroom	E / M / A	10	126.00	139.00
QTL261	Classroom SFIC	E / M / A	10	174.00	188.00
QTL270	Storeroom	E / M / A	10	126.00	139.00
QTL271	Storeroom SFIC	E / M / A	10	174.00	188.00

Less Cylinder		List Price
LC	Less Cylinder	Deduct 21.00
	Less SFIC Cylinder	Deduct 44.00

Options		Add
H	Hurricane Compliant	5.00





**NOTES:**

\*Privacy split finishes are priced at the highest finish price.

# STANLEY Commercial Hardware

## QTL200 Series | Grade 2 | Standard Duty Tubular Locks



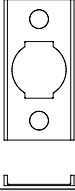

### LATCH OPTIONS (SPECIFY FINISH)

Order # With Lock	Description	Service Part #	Price With Lock	Service Part List Price
<b>1" X 2 -1/4" FACE PLATE, GRADE 2 TUBULAR, UL (NARROW FACE)</b>				
	SA Adjustable tubular dead latch, 1" square corner face plate G2 UL	8Q00162	NC	9.90
	RA Adjustable tubular dead latch, 1" radius corner face plate G2 UL	8Q00204	NC	9.90
	SA Adjustable tubular spring latch, 1" square corner face plate G2 UL	8Q00163	NC	9.90
	RA Adjustable tubular spring latch, 1" radius corner face plate G2 UL	8Q00205	NC	9.90
<b>WIDE FACE LATCH FILLER</b>				
	Wide face latch adaptor plate (converts 1" latch face plate to 1 1/8")	8Q00217	N/A	1.40
<b>NO LATCH</b>				
NOL	No Latch		Deduct 9.00	

# STANLEY Commercial Hardware

QTL200 Series | Grade 2 | Standard Duty Tubular Locks

## STRIKE OPTIONS (SPECIFY FINISH)







Order # With Lock		Description	Service Part #	Price With Lock	Service Part List Price
	118 F	2 3/4" x 1 1/8" T-Strike (Does not include screws. Screwpack 8Q00058)	8Q00165	NC	4.80
	478S	4 7/8" x 1 1/4" ANSI Strike (Does not include screws. Screwpack 8Q00058)	8Q00166	NC	7.60
	FLR	2 1/4" Full Lip Round Corner Strike UL	8Q00241	NC	4.50
	FLS	2 1/4" Full Lip Square Corner Strike UL	8Q00240	NC	4.50
<b>NO STRIKE</b>					
NOS	No Strike			Deduct 4.10	



# STANLEY Commercial Hardware

## QTL200 Series | Grade 2 | Standard Duty Tubular Locks

### OTHER PARTS & SCREW PACKS

	Description	Service Part #	Service Part List Price
	Tailpiece QTL200 & QRT300 Series	8Q00073	2.50
	Cylinder Plug Holder QTL200 Series - Summit Style	8Q00067	2.00
	Cylinder Plug Holder QTL200 Series - Sierra Style	8Q00068	2.00
	Screw Pack for QTL200 Series (Specify Finish)	8Q00062	2.00
	Screw Pack for T-Strike (Specify Finish)	8Q00058	1.90
	Thick Door Pack for QTL200 Series (1 3/4" - 2") (Specify Finish)	8Q00063	2.00

# STANLEY Commercial Hardware

## QDB100 Series | Grade 1 | Heavy Duty Auxiliary Deadbolts

80	Single Cylinder			BF	BEST "F" SFIC
81	Single Cylinder SFIC	605	Bright Brass	KW	Kwikset "KW"
82	Double Cylinder	613	Oil Rubbed Bronze	WE	Weiser "E"
83	Double Cylinder SFIC	619	Satin Nickel	SC	Schlage "C"
86	Classroom	625	Bright Chrome	GA	Yale "GA"
87	Classroom SFIC	626	Satin Chrome	LA	Sargent "LA"
				LC	Less Cylinder

Base Part Number								Additional Options
Series	Function	Finish	Deadbolt	Strike	Keyway	# of Pins	Keying	Hurricane compliant
QDB1	81	626	S8	DBS	BF	6	KD	H

QDB1 DEADBOLT TABLE (New)	
NOL	No Latch
NR4	Narrow Radius 2-3/4
NR8	Narrow Radius 2-3/8
NS4	Narrow Square 2-3/4
NS8	Narrow Square 2-3/8
R4	Radius 2-3/4
R8	Radius 2-3/8
S4	Square 2-3/4
S8	Square 2-3/8

KD	Keyed Different
KA	Keyed Alike
SK	Special Keying
	-Construction Keyed
	-Construction Master Keyed
	-Maison Keyed
	-Master Keyed
	-Grand Master Keyed
	-Great Grand Master Keyed
ZB	Zero Bitted

478S	ANSI 4 7/8" x 1 1/4" Strike
DBS	Deadbolt Strike 1 1/8" x 2 3/4" Square
FLS	Full Lip Square Corner Strike
FLR	Full Lip 1/4" Radius Corner Strike
NOS	No Strike

### Example

If you ordered: QDB281 626 S8 DBS BF 6 KD H

You would get: Grade 1 Single Cylinder SFIC Auxiliary Deadbolt, Satin Chrome, 2 3/8" Deadbolt Latch Square, Standard Deadbolt Strike, BEST "F" SFIC Keyway, Keyed Different, Hurricane Compliant.

# STANLEY Commercial Hardware

## QDB100 Series | Grade 1 | Heavy Duty Auxiliary Deadbolts

### Single Cylinder

Available in: 605, 613, 619, 625, 626



### Double Cylinder

Available in: 605, 613, 619, 625, 626



Model/Series	Functions	Case Qty	List Price	
			626	605, 613, 619, 625
QDB180	Single Cylinder	12	123.00	128.00
QDB181	Single Cylinder SFIC	12	167.00	172.00
QDB182	Double Cylinder	12	158.00	163.00
QDB183	Double Cylinder SFIC	12	246.00	251.00
QDB186	Classroom	12	129.00	134.00
QDB187	Classroom SFIC	12	173.00	178.00

Less Cylinder		List Price
LC	Less Cylinder	Deduct 21.00
	Less SFIC Cylinder	Deduct 44.00



Options		Add
H	Hurricane Compliant	5.00

NOTES:  
Consult factory for lead times on 605, 625 finishes.

# STANLEY Commercial Hardware

## QDB100 Series | Grade 1 | Heavy Duty Auxiliary Deadbolts



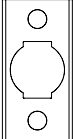

### DEADBOLT OPTIONS (SPECIFY FINISH)

Order # With Lock		Description	Service Part #	Price With Lock	Service Part List Price
<b>1 -1/8" X 2 -1/4" FACE PLATE, DEADBOLT, UL (WIDE FACE)</b>					
	S4	2 3/4" deadbolt - square corner	8Q00170	NC	15.00
	R4	2 3/4" deadbolt - radius corner	8Q00169	NC	15.00
	S8	2 3/8" deadbolt - square corner	8Q00168	NC	15.00
	R8	2 3/8" deadbolt - radius corner	8Q00167	NC	15.00
<b>1" X 2 -1/4" FACE PLATE, DEADBOLT, UL (NARROW FACE)</b>					
	NS4	2 3/4" deadbolt - square corner	8Q00237	NC	15.00
	NR4	2 3/4" deadbolt - radius corner	8Q00236	NC	15.00
	NS8	2 3/8" deadbolt - square corner	8Q00235	NC	15.00
	NR8	2 3/8" deadbolt - radius corner	8Q00234	NC	15.00
<b>WIDE FACE LATCH FILLER</b>					
		Wide face latch adaptor plate (converts 1" latch face plate to 1-1/8")	8Q00217		1.40
<b>NO LATCH</b>					
NOL		No Latch		Deduct 14.00	

# STANLEY Commercial Hardware

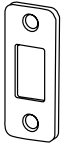
## QDB100 Series | Grade 1 | Heavy Duty Auxiliary Deadbolts







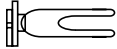
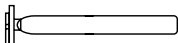

### STRIKE OPTIONS (SPECIFY FINISH)

Order # With Lock		Description	Service Part #	Price With Lock	Service Part List Price
	DBS	23/4" x 11/8" Standard Deadbolt Strike and Reinforcer	8Q00164	NC	4.60
	DBR	23/4" x 11/8" Standard Radius Deadbolt Strike and Reinforcer	8Q00530	NC	4.60
	478S	4 7/8" x 11/4" ANSI Strike	8Q00244	Add 3.20	7.60
	FLR	21/4" Full Lip Round Corner Strike UL	8Q00316	NC	4.60
	FLS	2 1/4" Full Lip Square Corner Strike UL	8Q00317	NC	4.60
		Plastic Strike Box for QDB100 & QDB200 Series (DBS Strike only)	8Q00161	N/A	2.50
<b>NO STRIKE</b>					
NOS		No Strike		Deduct 4.20	

# STANLEY Commercial Hardware

## QDB100 Series | Grade 1 | Heavy Duty Auxiliary Deadbolts

### OTHER PARTS & SCREW PACKS

	Description	Service Part #	Service Part List Price
	Tailpiece for QDB100 & QDB200 Series Double Cylinder (Qty 2)	8Q00085	2.50
	Tailpiece and washer for Single Cylinder QDB100 & QDB200 Series	8Q00083	2.50
	Spacer for Double Cylinder Deadbolt SFIC QDB100 & QDB200 Series (Specify finish)	8Q00082	2.50
	Thick Door Pack for QDB100 Series Single Cylinder (1 3/4" - 2 1/4") (Specify finish)	8Q00077	2.50
	Thick Door Pack for QDB100 & QDB200 Series Double Cylinder (1 3/4" - 2 1/4") (Specify finish)	8Q00079	2.50
	Thick Door Kit - Tailpiece and washer for Single Cylinder QDB100 & QDB200 Series (1 3/4" - 2 1/4")	8Q00084	2.50
	Cylinder Screw QDB100 & QDB200 Series	8Q00086	2.50
	Screw Pack for T-Strike (Specify finish)	8Q00058	1.90
	Screw Pack for QDB100 Series Single Cylinder (Specify finish)	8Q00076	2.50
	Screw Pack for QDB100 & QDB200 Series Double Cylinder (Specify finish)	8Q00078	2.50

# STANLEY Commercial Hardware

## QDB200 Series | Grade 2 | Standard Duty Auxiliary Deadbolts

80	Single Cylinder
81	Single Cylinder SFIC
82	Double Cylinder
83	Double Cylinder SFIC
84	Inside Turnbolt
85	Indicator
86	Classroom
87	Classroom SFIC
88	Key Control†

605	Bright Brass
613	Oil Rubbed Bronze
619	Satin Nickel
625	Bright Chrome
626	Satin Chrome

BF	BEST "F" SFIC
SMT	Re-Key*
KW	Kwikset "KW"
WE	Weiser "E"
SC	Schlage "C"
GA	Yale "GA"
LA	Sargent "LA"
LC	Less Cylinder

Base Part Number								Additional Options
Series	Function	Finish	Deadbolt	Strike	Keyway	# of Pins	Keying	
<b>QDB2</b>	<b>81</b>	<b>626</b>	<b>S8</b>	<b>DBS</b>	<b>BF</b>	<b>6</b>	<b>KD</b>	
								<b>H</b>

QDB2 DEADBOLT TABLE (New)	
6A	6-Way Adjustable
NOL	No Latch
NR4	Narrow Radius 2-3/4
NR8	Narrow Radius 2-3/8
NS4	Narrow Square 2-3/4
NS8	Narrow Square 2-3/8
RA	Adjustable Radius*
R4	Radius 2-3/4
R8	Radius 2-3/8
SA	Adjustable Square*
S4	Square 2-3/4
S8	Square 2-3/8

KD	Keyed Different
KA	Keyed Alike
SK	Special Keying
	-Construction Keyed
	-Construction Master Keyed
	-Maison Keyed
	-Master Keyed
	-Grand Master Keyed
	-Great Grand Master Keyed
ZB	Zero Bitted

478S	ANSI 4 7/8" x 1 1/4" Strike
DBS	Deadbolt Strike 1 1/8" x 2 3/4" Square
DBR	Deadbolt Strike 1 1/8" x 2 3/4" Radius
FLS	Full Lip Square Corner Strike
FLR	Full Lip 1/4" Radius Corner Strike
NOS	No Strike

### NOTES:

† Key control deadbolt only available with Re-Key cylinders.

\* Re-Key available on QDB280. QDB288 is only available to order with Re-Key and either SA or RA latches. SA and RA latches are not available on other deadbolts.

### Example

If you ordered: QDB281 626 S8 DBS BF6 KD H

You would get: Grade 2 Single Cylinder SFIC Auxiliary Deadbolt, Satin Chrome, 2 3/8" Deadbolt Latch Square, Standard Deadbolt Strike, BEST "F" SFIC Keyway, Keyed Different, Hurricane Compliant.

# STANLEY Commercial Hardware

## QDB200 Series | Grade 2 | Standard Duty Auxiliary Deadbolts

### Single Cylinder

Available in: 605, 613,  
619, 625, 626



### Double Cylinder

Available in: 605, 613,  
619, 625, 626



### QDB285 Indicator

Available in: 605, 613,  
619, 625, 626\*



### QDB288 Key Control

Available in: 605, 619, 626



Model/Series	Functions	Case Qty	List Price	
			626	605, 613, 619, 625
QDB280	Single Cylinder	12	76.00	82.00
QDB281	Single Cylinder SFIC	12	98.00	103.00
QDB282	Double Cylinder	12	95.00	100.00
QDB283	Double Cylinder SFIC	12	141.00	146.00
QDB284	Inside Turnbolt	20	38.00	43.00
QDB285	Indicator	12	62.00	67.00
QDB286	Classroom	12	81.00	86.00
QDB287	Classroom SFIC	12	102.00	109.00
QDB288†	Key Control	12	89.00	95.00

Options		Add
H	Hurricane Compliant	5.00

**NOTES:**

† Key Control Deadbolt available with Re-key Cylinders only.



Consult factory for lead times on 605, 625 finishes.



# STANLEY Commercial Hardware

## QDB200 Series | Grade 2 | Standard Duty Auxiliary Deadbolts



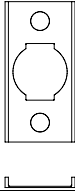

### DEADBOLT OPTIONS (SPECIFY FINISH)

Order # With Lock	Description	Service Part #	Price With Lock	Service Part List Price	
<b>1 1/8" X 2 1/4" FACE PLATE, DEADBOLT, UL (WIDE FACE)</b>					
	S4	2 3/4" deadbolt - square corner	8Q00170	NC	15.00
	R4	2 3/4" deadbolt - radius corner	8Q00169	NC	15.00
	S8	2 3/8" deadbolt - square corner	8Q00168	NC	15.00
	R8	2 3/8" deadbolt - radius corner	8Q00167	NC	15.00
<b>1" X 2 1/4" FACE PLATE, DEADBOLT, UL (NARROW FACE)</b>					
	NS4	2 3/4" deadbolt - square corner	8Q00237	NC	15.00
	NR4	2 3/4" deadbolt - radius corner	8Q00236	NC	15.00
	NS8	2 3/8" deadbolt - square corner	8Q00235	NC	15.00
	NR8	2 3/8" deadbolt - radius corner	8Q00234	NC	15.00
<b>6 WAY ADJUSTABLE LATCHES, DEADBOLT, UL (NARROW)</b>					
6A	1" square corner, 1" round corner and drive-in	8Q00482	Add 2.40	16.00	
<b>QDB288 KEY CONTROL LATCHES, 1" X 2 1/4" FACE PLATE, ADJUSTABLE BACKSET, UL</b>					
	SA	Square corner adjustable deadbolt	8Q00451	NC	15.00
	RA	Round corner adjustable deadbolt	8Q00450	NC	15.00
<b>WIDE FACE LATCH FILLER</b>					
		Wide face latch adaptor plate (converts 1" latch face plate to 1 1/8")	8Q00217	N/A	1.40
<b>NO LATCH</b>					
NOL	No Latch		Deduct 14.00		

# STANLEY Commercial Hardware

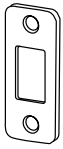
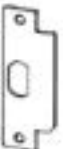
## QDB200 Series | Grade 2 | Standard Duty Auxiliary Deadbolts

### STRIKE OPTIONS (SPECIFY FINISH)

Order # With Lock		Description	Service Part #	Price With Lock	Service Part List Price
	DBS	2 3/4" x 1 1/8" Standard Deadbolt Strike and Reinforcer	8Q00164	NC	4.60
	DBR	2 3/4" x 1 1/8" Standard Radius Deadbolt Strike and Reinforcer	8Q00530	NC	4.60
	478S	4 7/8" x 1 1/4" ANSI Strike	8Q00244	Add 3.20	7.60
	FLR	2 1/4" Full Lip Round Corner Strike UL	8Q00316	NC	4.60
	FLS	2 1/4" Full Lip Square Corner Strike UL	8Q00317	NC	4.60
		Plastic Strike Box for QDB100 & QDB200 Series (DBS Strike only)	8Q00161	N/A	2.50
<b>NO STRIKE</b>					
NOS		No Strike		Deduct 4.20	

# STANLEY Commercial Hardware

QDB200 Series | Grade 2 | Standard Duty Auxiliary Deadbolts











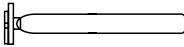

## CYLINDER OPTIONS (SPECIFY FINISH)

Order # With Lock	Description	Service Part #	Price With Lock	Service Part List Price
<b>RE-KEY CYLINDERS</b>				
SMT	Re-Key Cylinder - QDB280	9Q0009-096	NC	20.00
	Re-Key Cylinder - QDB288 Tenant Cylinder (Bottom)	9Q0009-117	NC	20.00
	Re-Key Cylinder - QDB288 Control Cylinder (Top)	9Q0009-098	NC	20.00
<b>LESS CYLINDER</b>				
LC	Less Cylinder		Deduct 23.00	
	Less SFIC Cylinder		Deduct 45.00	

# STANLEY Commercial Hardware

QDB200 Series | Grade 2 | Standard Duty Auxiliary Deadbolts







## OTHER PARTS & SCREW PACKS

	Description	Service Part #	Service Part List Price
	Tailpiece for QDB100 & QDB200 Series Double Cylinder (Qty 2)	8Q00085	2.50
	Tailpiece and washer for Single Cylinder QDB100 & QDB200 Series	8Q00083	2.50
	Spacer for Double Cylinder Deadbolt SFIC QDB100 & QDB200 Series (Specify finish)	8Q00082	2.50
	Thick Door Pack for QDB200 Series Single Cylinder (1 3/4" - 2 1/4") (Specify finish)	8Q00081	2.50
	Thick Door Pack for QDB100 & QDB200 Series Double Cylinder (1 3/4" - 2 1/4") (Specify finish)	8Q00079	2.50
	Thick Door Kit - Tailpiece and washer for Single Cylinder (1 3/4" - 2 1/4")	8Q00084	2.50
	Thick Door Kit - Tailpiece and washer for Single SFIC Cylinder (1 3/4" - 2 1/4")	8Q00588	2.50
	Cylinder Screw QDB100 & QDB200 Series	8Q00086	2.50
	Screw Pack for T-Strike (Specify finish)	8Q00058	1.90
	Screw Pack for QDB200 Series Single Cylinder (Specify finish)	8Q00080	2.50
	Screw Pack for QDB100 & QDB200 Series Double Cylinder (Specify finish)	8Q00078	2.50
	Indicator Emergency Key	8Q00531	2.30
	Re-Key Learn Tool	8Q00555	4.60

# STANLEY Commercial Hardware

QDB200 Series | Grade 2 | Standard Duty Auxiliary Deadbolts

## OTHER PARTS & SCREW PACKS

	Description	Service Part #	Service Part List Price
	Cylinder Cover for QDB288 Key Control	8Q00453	2.80
	Mounting screws for QDB288 Key Control	8Q00477	1.80
	Torque blade for QDB288 Key Control	8Q00476	1.80
	Gear assembly for QDB288 Key Control	8Q00474	6.60
	Screws for gear assembly for QDB288 Key Control	8Q00475	1.60
	Reset Cradle for Re-Key cylinders	8Q00484	43.00

# STANLEY Commercial Hardware

## QED100 Series | Grade 1 | Heavy Duty Exit Devices

QED1xx	Grade 1 Architectural Exit Device	LR	Electrified Latch Retraction	36" Device	36	7FT	7 ft Rod	BF	BEST "F" SFIC	Keyway**	Keying**	Notes			
		LRX	Electrified Latch Retraction with Request to Exit		48" Device		48		8FT				8 ft Rod	KW	Kwikset "KW"
		ED	Electrified Dogging											WE	Weiser "E"
		EDX	Electrified Dogging with Request to Exit											SC	Schlage "C"
		X	Request to Exit											GA	Yale "GA"
		HC	Hurricane Compliant†											LA	Sargent "LA"
								LC	Less Cylinder						
Series	Function	Options	Size	Door Height*	Finish	Keyway**	Keying**	Notes							
<b>QED1</b>	<b>15</b>	<b>LR</b>	<b>36"</b>	<b>7FT</b>	<b>313AN</b>	<b>BF</b>	<b>KD</b>	<b>XXXX</b>							
11	Rim Hex Dog	24	CVR - Hex Dog	605	Bright Brass	KD	Keyed Different								
12	Rim Cylinder Dog	25	CVR - Cylinder Dog	313AN	Anodized Duranodic Bronze	KA	Keyed Alike								
13	Rim Fire Rated	26	CVR - Fire Rated		626	Satin Chrome	SK	Special Keying							
14	SVR - Hex Dog	27	CVR - LBR - Hex Dog					-Construction Keyed							
15	SVR - Cylinder Dog	28	CVR - LBR - Cylinder Dog				-Construction Master Keyed								
16	SVR - Fire Rated	29	CVR - LBR - Fire Rated				-Maison Keyed								
17	SVR - LBR - Hex Dog						-Master Keyed								
18	SVR - LBR - Cylinder Dog						-Grand Master Keyed								
19	SVR - LBR - Fire Rated						-Great Grand Master Keyed								
						ZB	Zero Bitted								

\* Applies to Vertical Rods only.

\*\* Applies to Cylinder Dogged only.

† HC is only available for QED111-QED116.

### Example

If you ordered: QED115 36" 7FT 313AN BF KD

You would get: Grade 1 Heavy Duty Architectural Surface Vertical Rod Exit Device with Cylinder Dogging for a 7 Foot Door, in Anodized Duranodic Bronze finish. SFIC "F" Keyway, Keyed Different.

# STANLEY Commercial Hardware

## QED100 Series | Grade 1 | Heavy Duty Exit Devices



### Architectural Exit Device

Available in: 605, 313AN, 626

Model/Series	Functions	Style	Case Qty	List Price	
				626	605, 313AN
QED111	Rim - Hex Dog		1	914.00	948.00
QED112	Rim - Cylinder Dog		1	970.00	1004.00
QED113	Rim - Fire Rated		1	977.00	1011.00
QED114	SVR - Hex Dog	7FT	1	1203.00	1237.00
QED115	SVR - Cylinder Dog	7FT	1	1259.00	1293.00
QED116	SVR - Fire Rated	7FT	1	1265.00	1299.00
QED117	SVR Less Bottom Rod - Hex Dog	7FT	1	1166.00	1200.00
QED118	SVR Less Bottom Rod - Cylinder Dog	7FT	1	1222.00	1256.00
QED119	SVR Less Bottom Rod - Fire Rated	7FT	1	1228.00	1262.00
QED124	CVR - Hex Dog	7FT	1	1265.00	1299.00
QED125	CVR - Cylinder Dog	7FT	1	1320.00	1354.00
QED126	CVR - Fire Rated	7FT	1	1330.00	1364.00
QED127	CVR - LBR - Hex Dog	7FT	1	1247.00	1281.00
QED128	CVR - LBR - Cylinder Dog	7FT	1	1302.00	1336.00
QED129	CVR - LBR - Fire Rated	7FT	1	1309.00	1343.00

Less Cylinder		List Price
LC	Less Cylinder	Deduct 47.00

Options		Add
8FT	Vertical rod kit for 8FT door application	41.00
48"	48" Device (Consult factory for lead-time)	47.00
HC	Hurricane Compliant Rim	97.00
	Hurricane Compliant SVR	21.00

**NOTES:**

All LBR fire rated devices include a bottom fire bolt.  
Consult factory for lead times on 605 finish.

# STANLEY Commercial Hardware

QED100 Series | Grade 1 | Heavy Duty Exit Devices

## ELECTRIFIED OPTIONS (CONSULT FACTORY FOR LEAD TIMES)



QED 100 Series

Model #	Description	List Price Adder
QED__LR	Electrified Latch Retraction (LR) allows for the remote unlatching of exit devices. Continuous duty solenoids retract latches momentarily or for extended periods of time. Requires the use of power supply 8Q00312 or 8Q00313.	910.00
QED__ED	Electrified Dogging (ED) allows continuous latch retraction and dogging simultaneously. ED requires first time mechanical activation after which the push bar will continuously hold the push bar and latch retracted. When power is removed or interrupted from the device, the latch bolt will extend and push bar will release. Uses power supply 8Q00314 (on page 50)	785.00
QED __X	Request to Exit (X) is an SPDT (Single Pole Double Throw) switch which monitors the push bar of the exit device. The X switch can be used to activate a door alarm, control a magnetic locking device, shunt a door alarm or signal a control console when the push bar is depressed.	292.00
QED__LRX	Electrified Latch Retraction (LR) device with a Request to Exit (X) switch. Requires the use of power supply 8Q00312 or 8Q00313.	1130.00
QED__EDX	Electrified Dogging (ED) device with a Request to Exit (X) switch. Uses power supply 8Q00314 (on page 50)	1006.00

## POWER SUPPLY OPTIONS (CONSULT FACTORY FOR LEAD TIMES)

Model #	Description	List Price Adder
8Q00312	Power supply for Electronic Latch Retraction Devices (LR/LRX)	930.00
8Q00313	Power supply with Day/Night mode for Electronic Latch Retraction Devices (LR/LRX)	1058.00

### Electrified Product Specifications

- Consult Factory for lead times
- Electrification prices should be added to price of device
- Continuous duty solenoids
- Lifetime warranty on exit device; 1 year warranty on electronic components
- LR or LRX requires power supply 8Q00312 or 8Q00313
- Minimum door width 36"
- LR and ED requires the removal of mechanical dogging mechanism
- Options can be used in any Hex Dog or Fire Rated QED 100 Series Device (How to order example: QED111LR 36" 626)

### Power Supply Specifications (10" x 10" x 4.25")

- 8Q00312**
  - Provides power for up to two LR or LRX devices
  - Supplied with wiring diagram in detailed instructions
  - Automatic door operator interface
  - Independent control of single exit devices (one or two single doors) or sequential operation of two devices (pair of doors) field adjustable latch retraction time delay
  - 24VDC or 12 VDC auxiliary power, unfiltered & unregulated
- 8Q00313**
  - Same as 8Q00312 with the addition of a day/night mode
  - Provides separate input for retracting one exit device or two exit devices sequentially without activating the auto door operator. While the latches are held retracted auto operator can be activated independently from a different output.



# STANLEY Commercial Hardware

## QED200 Series | Grade 1 | Heavy Duty Narrow Stile Exit Devices

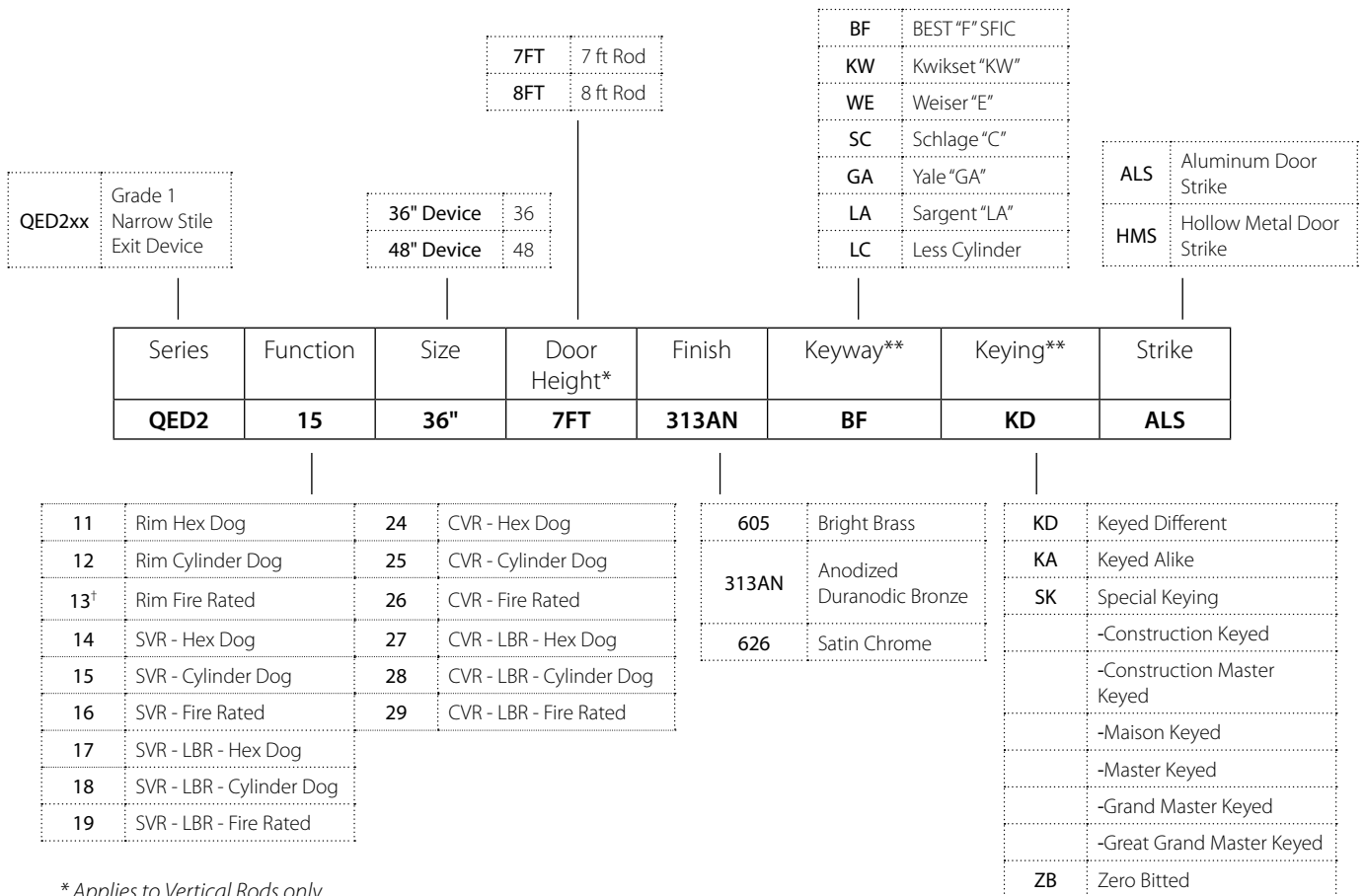

\* Applies to Vertical Rods only.

\*\* Applies to Cylinder Dogged only.

† QED213 available with HMS strike only.

### NOTES:

Rim devices with ALS Strike and SVR devices require minimum stile width of 2".

Rim devices with HMS and CVR devices require minimum stile wide of 3.5".

### Example

If you ordered: QED215 36" 7FT 626 BF KD

You would get: Grade 1 Heavy Duty Narrow Stile Surface Vertical Rod Exit Device with Cylinder Dogging for a 7 Foot Door, in Brushed Chrome finish, SFIC "F" Keyway, Keyed Different.

# STANLEY Commercial Hardware

## QED200 Series | Grade 1 | Heavy Duty Narrow Stile Exit Devices



### Narrow Stile Exit Device

Available in: 605, 313AN, 626

Model/Series	Functions	Style	Case Qty	List Price	
				626	605, 313AN
QED211	Rim - Hex Dog		1	1076.00	1115.00
QED212	Rim - Cylinder Dog		1	1129.00	1168.00
QED213	Rim - Fire Rated		1	1138.00	1177.00
QED214	SVR - Hex Dog	7FT	1	1453.00	1493.00
QED215	SVR - Cylinder Dog	7FT	1	1505.00	1545.00
QED216	SVR - Fire Rated	7FT	1	1514.00	1553.00
QED217	SVR Less Bottom Rod - Hex Dog	7FT	1	1415.00	1453.00
QED218	SVR Less Bottom Rod - Cylinder Dog	7FT	1	1467.00	1505.00
QED219	SVR Less Bottom Rod - Fire Rated	7FT	1	1475.00	1514.00
QED224	CVR - Hex Dog	7FT	1	1506.00	1546.00
QED225	CVR - Cylinder Dog	7FT	1	1558.00	1598.00
QED226	CVR - Fire Rated	7FT	1	1568.00	1607.00
QED227	CVR - LBR - Hex Dog	7FT	1	1473.00	1512.00
QED228	CVR - LBR - Cylinder Dog	7FT	1	1526.00	1565.00
QED229	CVR - LBR - Fire Rated	7FT	1	1534.00	1574.00

Less Cylinder	
LC	Less Cylinder

List Price
Deduct 47.00

Options		Add
8FT	Vertical rod kit for 8FT door application	38.00
48"	48" Device (Consult factory for lead-time)	45.00





\*QED213 available with HMS strike only.

NOTES:  
 All LBR fire rated devices include a bottom fire bolt.  
 Consult factory for lead times on 605 finish.  
 Rim devices with ALS Strike and SVR devices require minimum stile width of 2".  
 Rim devices with HMS and CVR devices require minimum stile wide of 3.5".

# STANLEY Commercial Hardware

## QED100/200 Series | Grade 1 | Heavy Duty Exit Devices



### LATCH & ROD PARTS (SPECIFY FINISH)

	Description	Service Part #	List Price
	Top Rod Latch for SVR & LBR - QED100/200 (requires screw pack 8Q00268 - see QED100/200 Other Parts & Screw Packs)	8Q00256	144.00
	Top Rod Latch for CVR - QED100 (requires screw pack 8Q00278 - see QED100/200 Other Parts & Screw Packs)	8Q00271	144.00
	Top Rod Latch for CVR - QED200 (requires screw pack 8Q00278 - see QED100/200 Other Parts & Screw Packs)	8Q00584	109.00
	Bottom Rod Latch for SVR - QED100/200 (requires screw pack 8Q00268 - see QED100/200 Other Parts & Screw Packs)	8Q00257	144.00
	Bottom Rod Latch for CVR - QED100 (requires screw pack 8Q00278 - see QED100/200 Other Parts & Screw Packs)	8Q00272	144.00
	Bottom Rod Latch for CVR - QED200 (requires screw pack 8Q00278 - see QED100/200 Other Parts & Screw Packs)	8Q00585	109.00
	Fire Latch for QED100/200 LBR Fire Rated * Can only be used with fire rated LBR devices.	8Q00279	76.00
NO IMAGE	Bottom Rod for SVR - QED100/200 (requires screw pack 8Q00268 - see QED100/200 Other Parts & Screw Packs)	8Q00258	35.00
NO IMAGE	Bottom Rod for CVR - QED100/200	8Q00280	35.00
NO IMAGE	7' Top Rod for SVR & LBR - QED100/200	8Q00259	35.00
NO IMAGE	7' Top Rod for CVR - QED100/200	8Q00281	35.00
NO IMAGE	8' Top Rod for SVR & LBR - QED100/200	8Q00260	41.00
NO IMAGE	8' Top Rod for CVR - QED100/200	8Q00282	41.00
NO IMAGE	QED100/200 Series SVR & LBR, 7' Top Rod Cover Set (includes top rod and base plate) (requires screw pack 8Q00261 - see QED100/200 Other Parts & Screw Packs)	8Q00249	67.00
NO IMAGE	QED100/200 Series SVR & LBR, 8' Top Rod Cover Set (includes cover and base plate) (requires screw pack 8Q00261 - see QED100/200 Other Parts & Screw Packs)	8Q00250	72.00
NO IMAGE	QED100/200 Series SVR, Bottom Rod Cover Set (includes cover and base plate) (requires screw pack 8Q00261 - see QED100/200 Other Parts & Screw Packs)	8Q00251	61.00

# STANLEY Commercial Hardware

QED100/200 Series | Grade 1 | Heavy Duty Exit Devices















## STRIKE PARTS

	Description	Service Part #	List Price
	Strike Kit for Rim Panic - QED100/200 (includes mounting hardware)	8Q00254	35.00
	Strike Kit for Rim Fire Rated - QED100/200 (includes mounting hardware)	8Q00255	41.00
	Double Door Strike Kit for Rim - QED111 & QED112 (includes mounting hardware)	8Q00269	61.00
	Strike Kit for Top Latch for SVR Panic - QED100/200 (includes mounting hardware)	8Q00247	47.00
	Strike Kit for Top Latch for CVR Panic - QED100/200	8Q00273	47.00
	Strike Kit for Top Latch for SVR Fire - QED100/200 (includes mounting hardware)	8Q00248	55.00
	Strike Kit for Top Latch for CVR Fire - QED100/200	8Q00274	55.00
	Strike Kit for Bottom Latch for SVR/CVR Panic - QED100/200 (includes mounting hardware)	8Q00265	47.00
	Strike Kit for Bottom Latch for SVR/CVR Fire - QED100/200 (includes mounting hardware)	8Q00266	47.00
	Strike Shim Kit for QED100/200 Series Rim Devices - 1 Piece	8Q00285	6.90
	Blade Stop Strike For Aluminum Door Application - QED200	S988	88.00

# STANLEY Commercial Hardware

## QED100/200 Series | Grade 1 | Heavy Duty Exit Devices

### OTHER PARTS & SCREW PACKS

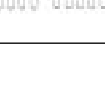
	Description	Service Part #	Qty	List Price
	QED100/200 Series End Cap (Specify finish)	8Q00264	1	35.00
	QED100/200 Series End Cap Bracket and Screw Pack	8Q00246	1	16.00
	QED100/200 Series SVR & LBR, Top & Bottom Latch Screw Pack (Specify finish)	8Q00268	1	21.00
	QED100/200 Series SVR & LBR, Rod Cover Screw Pack	8Q00261	1	19.00
	QED100/200 Series SVR & LBR, Latch Cover Screw Pack (Specify finish)	8Q00262	1	7.50
	QED100/200 Series SVR, Rod Connector Kit (connects top & bottom rod to exit device))	8Q00263	1	21.00
	QED100/200 Series Sex Bolts (Qty 4) (Specify finish)	8Q00267	1	23.00
	QED100/200 Series LBR, Head Cap Plug (black)	8Q00270	1	7.50
	QED100/200 Series Cylinder Mounting Kit for Cylinder Dog Devices (Specify finish)	8Q00252	1	35.00
	QED100/200 Series Hex Wrench for Hex Dog Devices	8Q00253	1	6.40
	Standard Cam for Mortise Cylinder	8Q00119	1	4.60
	Cam Mounting Screws for Mortise Cylinders (Qty 2)	8Q00118	1	1.50
	QED100/200 Series CVR Rod Connector	8Q00275	1	21.00
	QED100/200 Series CVR-LBR Rod Connector	8Q00276	1	21.00
	QED100/200 Series CVR Installation Jig	8Q00277	1	8.90
	QED100/200 Series CVR Latch Screw Pack	8Q00278	1	21.00

# STANLEY Commercial Hardware

## QED100/200 Series | Grade 1 | Heavy Duty Exit Devices

### THICK DOOR KITS (TDK's)

Thick door kits (TDK's) are used to extend the length of the exit trim spindle for non-standard (1 3/4") thick doors. These kits include appropriate length exit trim spindles and fasteners.



Trim	Door Thickness				List Price
	2"	2 1/4"	2 1/2"	2 3/4"	
QET130	8Q00427	8Q00428	8Q00429	8Q00430	23.00
QET160					
QET180					
QET165	8Q00431	8Q00432	8Q00433	8Q00434	

### GLASS BEAD KITS (GBK's) (SPECIFY FINISH)

- Glass bead kits (GBK's) are used to shim exit devices off the face of a door with raised glass beads. Each kit contains (2) 1/8" shims (total clearance of 1/4") and fasteners.
- Requires the use of a thick door kit (TDK) if using an exit device trim.
- Available finishes: 605, 313, 626

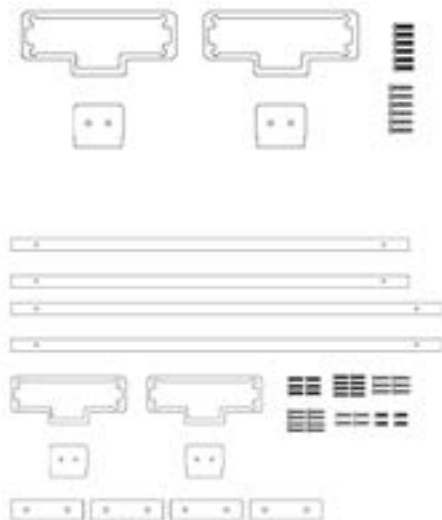

Part #	Model	Finishes	List Price
8Q00414	QED100 Rim and CVR Devices	605, 313AN, 626	72.00
8Q00415	QED100 SVR 7FT Device	605, 313AN, 626	182.00
8Q00416	QED100 SVR 8FT Device	605, 313AN, 626	188.00
8Q00586	QED200 Rim and CVR Device	605	72.00
8Q00546	QED200 Rim and CVR Device	313AN	
8Q00547	QED200 Rim and CVR Device	626	
8Q00548	QED200 SVR 7FT Device	605	182.00
8Q00549	QED200 SVR 7FT Device	313AN	
8Q00550	QED200 SVR 7FT Device	626	
8Q00551	QED200 SVR 8FT Device	605	188.00
8Q00552	QED200 SVR 8FT Device	313AN	
8Q00553	QED200 SVR 8FT Device	626	

# STANLEY Commercial Hardware

## QRM100 Series | Grade 1 | Mullions

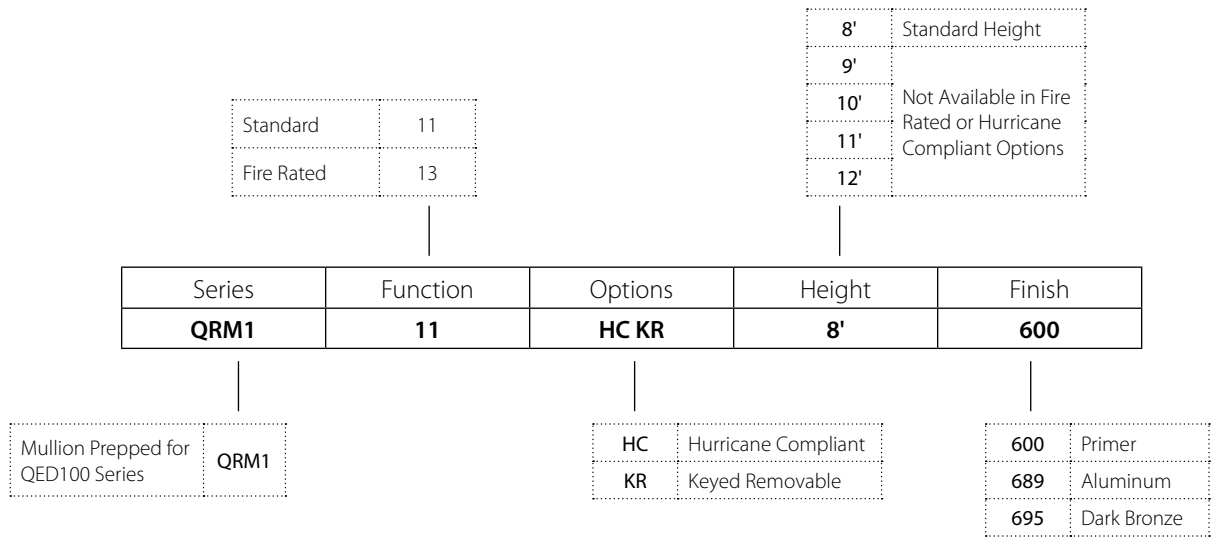

### Example

If you ordered: QRM111 HC KR 8' 600

You would get: Keyed Removable, Hurricane Compliant mullion, 8' height, with Primer finish. Prepped for QED100 Series strike.

# STANLEY Commercial Hardware

## QRM100 Series | Grade 1 | Mullions

### Applications

Use with Rim Exit Devices on pairs of doors.

### Hurricane Compliant

QRM111 HC KR OR QRM113 HC KR

### Product Specifications

- 2" x 3" (51 mm x 76 mm) steel mullion tube. 1/8" wall thickness.
- Hurricane: 2" x 3" steel mullion tube. 5/16" wall thickness.
- Size: Standard for openings 8'0" high, field sizeable for openings less than 8'0", 9', 10', 11' & 12' also available and are field sizeable.
- Mullion is pre-prepped for QED100 Series Exit Devices
- **Fire and Hurricane Rating 8' 0" high max.**
- Available Finishes: Primer (600), Aluminum (689) and Dark Bronze (695)



## KEYED REMOVEABLE MULLIONS (CONSULT FACTORY FOR LEAD TIMES)

Order #	Description	List Price	
		600	689, 695
Mullions include: Mullion Tube, Cap, Base, Fasteners. Cylinder not included. Keyed Removable Mullions utilize Standard Rim Cylinders. Reference Cylinders, Keys & Keying section for more details.			
QRM111 KR*	Keyed Removable Mullion	1038.00	1166.00
QRM111 HC KR	Hurricane Compliant, Keyed Removable Mullion	1338.00	1425.00
QRM113 KR	Fire Rated, Keyed Removable Mullion	1249.00	1338.00
QRM113 HC KR	Fire Rated, Hurricane Compliant, Keyed Removable Mullion	1510.00	1458.00
*NOTE: For heights greater than 8', add \$19 for each additional 12".			

## REMOVEABLE MULLIONS (CONSULT FACTORY FOR LEAD TIMES)

Order #	Description	List Price	
		600	689, 695
Mullions include: Mullion Tube, Cap, Base, Fasteners			
QRM111 *	Removable Mullion	605.00	691.00
QRM111 HC	Hurricane Compliant, Removable Mullion	862.00	949.00
QRM113	Fire Rated, Removable Mullion	779.00	862.00
QRM113 HC	Fire Rated, Hurricane Compliant, Removable Mullion	1038.00	1122.00
*NOTE: For heights greater than 8', add \$19 for each additional 12".			



# STANLEY Commercial Hardware

## QET100 Series | Grade 1 | Heavy Duty Exit Trims

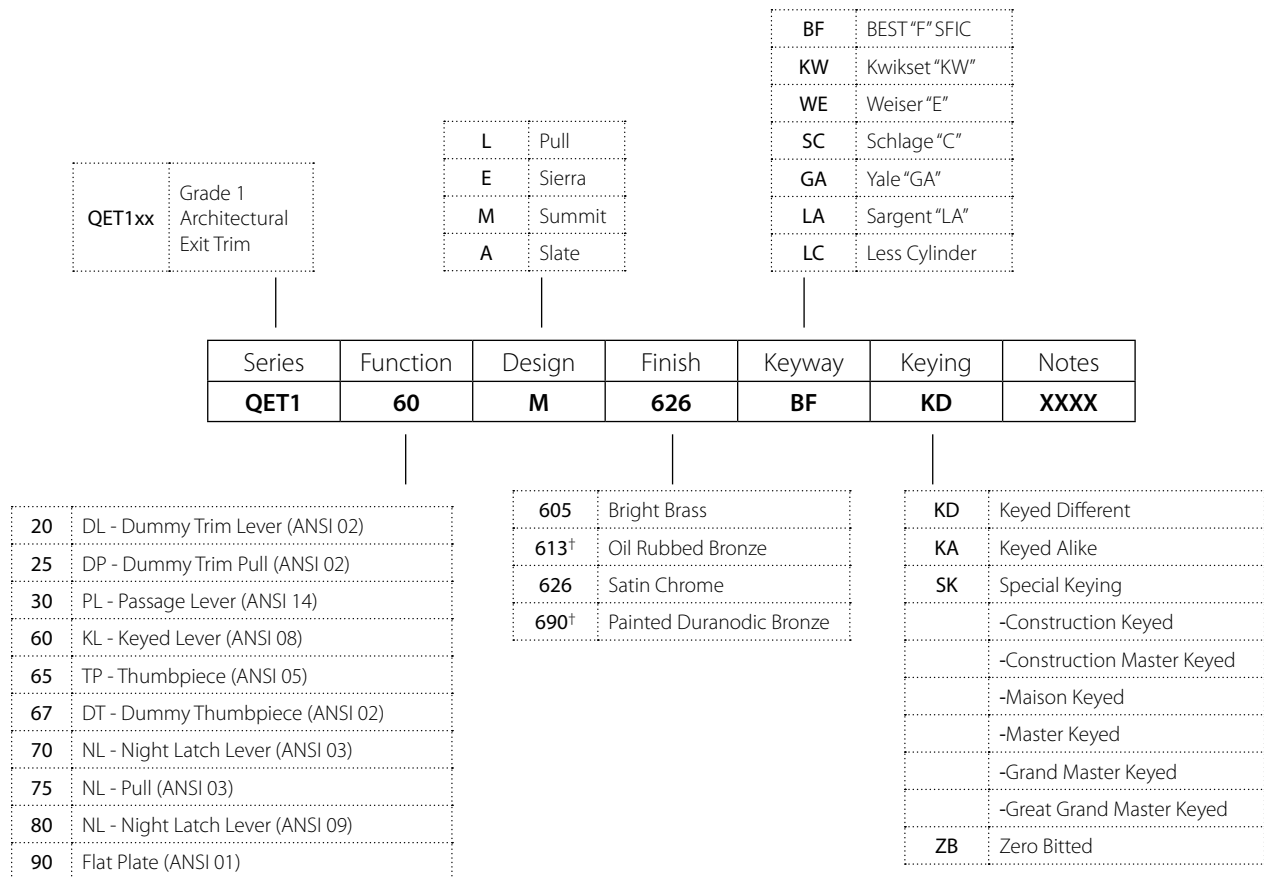

<sup>†</sup> 613 Finish available for lever escutcheon trims; 690 finish available for escutcheon pull trims

### Example

**If you ordered:** QET160 M 626 BF KD

**You would get:** Grade 1 Escutcheon Trim Lever, Summit design, Satin Chrome Finish SFIC "F" Keyway, Keyed Different. This Trim Matches to the QED100 Series Exit Devices

# STANLEY Commercial Hardware

## QET100 Series | Grade 1 | Heavy Duty Exit Trims



### Escutcheon Trims Sierra (E)

Available in: 605, 613\*\*, 626



### Escutcheon Trims Summit (M)

Available in: 605, 613\*\*, 626

Model/Series	Functions	Style	Cylinder Type	Case Qty	List Price
					605, 613, 626
QET120	Dummy Escutcheon Lever - ANSI 02	E/M/A	-	6	401.00
QET130	Passage Escutcheon Lever - ANSI 14	E/M/A	-	6	401.00
QET160	Keyed Escutcheon Lever (Classroom) - ANSI 08	E/M/A	Mortise	6	453.00
QET170*	Night Escutcheon Latch (Storeroom) - ANSI 03	E/M/A	Rim	6	453.00
QET180	Night Latch Escutcheon Latch (Storeroom) - ANSI 09	E/M/A	Mortise	6	453.00

**NOTES:**

\* Not recommended for use on exit devices with vertical rods.

\*\* 613 Finish trims match 313 finish exit devices.

Consult factory for lead times on 605 finish.

### Escutcheon Trims Pull & Flat Plates

Available in: 605, 626, 690



Dummy Pull  
QET125



Thumb Piece  
QET165



Dummy Thumb Piece  
QET167



Night Latch Pull  
QET175



Flat Plate  
QET190

Model/Series	Functions	Style	Cylinder Type	Case Qty	List Price
					605, 626, 690
QET125	Dummy Escutcheon Pull - ANSI 02	L	-	6	129.00
QET165*	Thumbpiece Escutcheon Pull - ANSI 05	L	Mortise	6	298.00
QET167	Dummy Thumbpiece Escutcheon Pull - ANSI 02	L	-	6	129.00
QET175*	Night Latch Escutcheon Pull - ANSI 03	L	Rim	6	181.00
QET190	Flat Escutcheon Plate - ANSI 01	L	-	6	77.00

Less Cylinder				List Price
LC	Less Cylinder			Deduct 47.00

**NOTES:**

\* Not recommended for use on exit devices with vertical rods.

\*\* 613 Finish trims match 313 finish exit devices.

Consult factory for lead times on 605 finish.

# STANLEY Commercial Hardware

## QET200 Series | Grade 1 | Heavy Duty Narrow Stile Exit Trims

QET2xx		Grade 1 Narrow Stile Exit Trim		L Pull		E Sierra		M Summit		A Slate		BF BEST "F" SFIC		KW Kwikset "KW"		WE Weiser "E"		SC Schlage "C"		GA Yale "GA"		LA Sargent "LA"		LC Less Cylinder			
Series	Function	Design	Finish	Keyway	Keying	Notes																					
<b>QET2</b>	<b>60</b>	<b>M</b>	<b>626</b>	<b>BF</b>	<b>KD</b>	<b>XXXX</b>																					
20	DL - Dummy Trim Lever (ANSI 02)			605	Bright Brass			KD	Keyed Different																		
25	DP - Dummy Trim Pull for Rim/SVR (ANSI 02)			613 <sup>†</sup>	Oil Rubbed Bronze			KA	Keyed Alike																		
26	DP - Dummy Trim Pull for CVR (ANSI 02)			626	Satin Chrome			SK	Special Keying																		
30	PL - Passage Lever (ANSI 14)			690 <sup>†</sup>	Painted Duranodic Bronze				-Construction Keyed																		
60	KL - Keyed Lever (ANSI 08)								-Construction Master Keyed																		
70	NL - Night Latch Lever (ANSI 03)								-Maison Keyed																		
75	NL - Pull (ANSI 03)								-Master Keyed																		
80	NL - Night Latch Lever (ANSI 09)								-Grand Master Keyed																		
90	Flat Plate for Rim/SVR (ANSI 01)								-Great Grand Master Keyed																		
91	Flat Plate for CVR (ANSI 01)							ZB	Zero Bitted																		

<sup>†</sup> 613 Finish available for lever escutcheon trims; 690 finish available for escutcheon pull trims

### Example

If you ordered: QET260 M 626 BF KD

You would get: Grade 1 Escutcheon Trim Lever, Summit design, Satin Chrome Finish SFIC "F" Keyway, Keyed Different. This Trim Matches to the QED200 Series Exit Devices

# STANLEY Commercial Hardware

## QET200 Series | Grade 1 | Heavy Duty Narrow Stile Exit Trims



**Escutcheon Trims  
Sierra (E)**

Available in: 605, 613\*\*, 626



**Escutcheon Trims  
Summit (M)**

Available in: 605, 613\*\*, 626



**Escutcheon Trims  
Slate (A)**

Available in: 605, 613\*\*, 626

Model/Series	Functions	Style	Cylinder Type	Case Qty	List Price
					605, 613, 626
QET220	Dummy Escutcheon Lever - ANSI 02	E/M/A	-	6	404.00
QET230	Passage Escutcheon Lever - ANSI 14	E/M/A	-	6	404.00
QET260	Keyed Escutcheon Lever (Classroom) - ANSI 08	E/M/A	Mortise	6	457.00
QET270*	Night Escutcheon Latch (Storeroom) - ANSI 03	E/M/A	Rim	6	457.00
QET280	Night Latch Escutcheon Latch (Storeroom) - ANSI 09	E/M/A	Mortise	6	457.00

**NOTES:**

\* Not recommended for use on exit devices with vertical rods.

\*\* 613 Finish trims match 313 finish exit devices.

Consult factory for lead times on 605 finish.

### Escutcheon Trims Pull & Flat Plates

Available in: 605, 626, 690



Dummy Pull  
QET225



Night Latch Pull  
QET275



Flat Plate  
QET290

Model/Series	Functions	Style	Cylinder Type	Case Qty	List Price
					605, 626, 690
QET225	Dummy Escutcheon Pull for Rim/SVR - ANSI 02	L	-	6	130.00
QET226	Dummy Escutcheon Pull for CVR - ANSI 02	L	-	6	130.00
QET275*	Night Latch Escutcheon Pull - ANSI 03	L	Rim	6	182.00
QET290	Flat Escutcheon Plate for Rim/SVR - ANSI 01	L	-	6	77.00
QET291	Flat Escutcheon Plate for CVR - ANSI 01	L	-	6	77.00

Less Cylinder					List Price
LC	Less Cylinder				Deduct 47.00

**NOTES:**

\* Not recommended for use on exit devices with vertical rods.









\*\* 613 Finish trims match 313 finish exit devices.

Consult factory for lead times on 605 finish.

# STANLEY Commercial Hardware

QET100/200 Series | Grade 1 | Heavy Duty Exit Trims

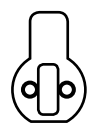
## OTHER PARTS & SCREW PACKS

	Description	Service Part #	Qty	List Price
	QET100/200 Series Screw Pack and Square Pin for Escutcheon Trims	8Q00132	1	4.60
	QET100/200 Series Screw Pack for Pull Plates	8Q00134	1	1.30
	QET100/200 Series Cylinder Mounting Kit (Specify finish)	8Q00135	1	23.00
	QET100/200 Series Cylinder Lock and Screw Pack for Thumb Piece Pulls - (Specify finish)	8Q00136	1	5.80
	QET100/200 Series Sex Nuts for Flat Plate - (Qty 2) (Specify finish)	8Q00139	1	5.80
	Rim Cylinder Tailpiece	8Q00140	1	2.50
	Rim Cylinder Tailpiece- Thick Door (Measures 2-3/8")	8Q00480	1	2.50
	Standard Cam for Mortise Cylinder	8Q00119	1	4.60
	Cam Mounting Screws for Mortise Cylinders (Qty 2)	8Q00118	1	1.50
	Rim Cylinder Retaining Cup	8Q00529	1	5.80

# STANLEY Commercial Hardware

## QED300 Series | Grade 1 | Standard Duty Exit Devices

11	Rim Hex Dog
12	Rim Cylinder Dog
13	Rim Fire Rated
14	SVR Hex Dog
15	SVR - Cylinder Dog
16	SVR - Fire Rated
17	SVR - LBR - Hex Dog
18	SVR - LBR - Cylinder Dog
19	SVR - LBR - Fire Rated

7FT	7 ft Rod
8FT	8 ft Rod

BF	BEST "F" SFIC
KW	Kwikset "KW"
WE	Weiser "E"
SC	Schlage "C"
GA	Yale "GA"
LA	Sargent "LA"
LC	Less Cylinder

Series	Function	Size	Door Height*	Finish	Keyway**	Keying**	Notes
<b>QED3</b>	<b>15</b>	<b>36"</b>	<b>7FT</b>	<b>689</b>	<b>BF</b>	<b>KD</b>	<b>XXXX</b>

<b>QED3xx</b>	Grade 1 Standard Duty Exit Device
---------------	-----------------------------------

<b>36"</b>	36" Device
<b>48"</b>	48" Device

<b>689</b>	Painted Aluminum
<b>690</b>	Painted Duranodic Bronze

<b>KD</b>	Keyed Different
<b>KA</b>	Keyed Alike
<b>SK</b>	Special Keying
	-Construction Keyed
	-Construction Master Keyed
	-Maison Keyed
	-Master Keyed
	-Grand Master Keyed
	-Great Grand Master Keyed
<b>ZB</b>	Zero Bitted

\* Applies to Surface Vertical Rods only  
 \*\* Applies to Cylinder Dogged only

### Example

If you ordered: QED315 36" 7FT 689 BF KD

You would get: Grade 1 Standard Duty Surface Vertical Rod Exit Device 36", with Cylinder Dogging for a 7 Foot Door, in Painted Aluminum finish. SFIC "F" Keyway, Keyed Different.

# STANLEY Commercial Hardware

## QED300 Series | Grade 1 | Standard Duty Exit Devices

### Standard Duty Exit Device

Available in: 689 & 690



Model/Series	Functions	Style	Case Qty	List Price
				689, 690
QED311	Rim - Hex Dog		4	275.00
QED312	Rim - Cylinder Dog		4	328.00
QED313	Rim - Fire Rated		4	372.00
QED314	Surface Vertical Rod - Hex Dog	7FT	4	452.00
QED315	Surface Vertical Rod - Cylinder Dog	7FT	4	506.00
QED316	Surface Vertical Rod - Fire Rated	7FT	4	575.00
QED317	Surface Vertical Rod Less Bottom Rod - Hex Dog	7FT	4	438.00
QED318	Surface Vertical Rod Less Bottom Rod - Cylinder Dog	7FT	4	492.00
QED319*	Surface Vertical Rod Less Bottom Rod - Fired Rated	7FT	4	575.00

Less Cylinder		List Price
LC	Less Cylinder	Deduct 47.00

Trim Options		List Price
8FT	Vertical rod kit for 8FT door application	Add 15.00
48"	48" Device	Add 21.00

**NOTES:**

\*QED319 Includes Bottom Fire Latch.

# STANLEY Commercial Hardware

## QED300 Series | Grade 1 | Standard Duty Exit Devices

### LATCH & ROD PARTS (SPECIFY FINISH)

	Description	Service Part #	List Price
	Top Rod Latch for SVR & LBR - QED314-QED319 (requires screw pack 8Q00130 - see QED300 Other Parts & Screw Packs)	8Q00111	95.00
	Bottom Rod Latch for SVR - QED314 & QED315 (requires screw pack 8Q00130 - see QED300 Other Parts & Screw Packs)	8Q00112	95.00
	Bottom Rod Latch for SVR Fire Rated - QED316 (requires screw pack 8Q00130 - see QED300 Other Parts & Screw Packs)	8Q00113	95.00
	Fire Latch for QED319 SVR-LBR-Fire Rated *Can only be used with Fire Rated LBR devices.	8Q00279	76.00
	Top Rod for SVR & LBR - QED314 - QED319 (7 Foot)	8Q00114	34.00
	Top Rod for SVR & LBR - QED314 - QED319 (8 Foot)	8Q00115	39.00
	Bottom Rod for SVR - QED314, QED315, QED316	8Q00116	34.00



# STANLEY Commercial Hardware

QED300 Series | Grade 1 | Standard Duty Exit Devices



## STRIKE PARTS

	Description	Service Part #	List Price
	Strike for Rim Panic - QED311 & QED312 (includes mounting hardware)	8Q00120	24.00
	Strike for Rim Fire Rated - QED313 (includes mounting hardware)	8Q00121	24.00
	Double Door Strike for Rim Panic - QED311 & QED312 (includes mounting hardware)	8Q00208	58.00
	Strike for Top Latch for SVR & LBR - QED314 - QED319 (includes mounting hardware)	8Q00128	24.00
	Strike for Bottom Latch for SVR - QED314, QED315 & QED316 (includes mounting hardware)	8Q00127	24.00
	Strike Shim Kit for Rim Devices - 1 piece (2 3/8" Backset for QED300 series)	8Q00285	6.90
	Strike Shim Kit for Rim Devices - 4 piece (2 3/4" Backset for QED300 series)	8Q00286	21.00

# STANLEY Commercial Hardware

## QED300 Series | Grade 1 | Standard Duty Exit Devices

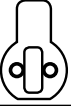
### OTHER PARTS & SCREW PACKS

	Description	Service Part #	Qty	List Price
	QED300 Series Rim, Head Cap (Specify finish)	8Q00109	1	46.00
	QED300 Series SVR, Head Cap (Specify finish)	8Q00110	1	46.00
	Standard Cam for Mortise Cylinder	8Q00119	1	4.60
	Cam Mounting Screws for Mortise Cylinders (Qty 2)	8Q00118	1	1.50
	QED300 Series Cylinder Mounting Kit for Cylinder Dog Device - QED312, QED315 & QED318 (Specify finish)	8Q00122	1	23.00
	QED300 Series LBR, Head Cap Plug (black)	8Q00117	1	1.50
	QED300 Series Hex Wrench for Hex Dog Devices - QED311, QED314 & QED317	8Q00124	1	1.50
	QED300 Series Device Mounting Screw Pack	8Q00125	1	5.00
	QED300 Series SVR & LBR, Rod Holder Brackets and Screw Pac- QED314 - QED319 (Specify finish)	8Q00126	1	5.00
	QED300 Series SVR & LBR, Top & Bottom Latch Screw Pac (Specify finish)	8Q00130	1	5.00
	QED300 Series Sex Bolts (Qty 4) (Specify finish)	8Q00131	1	6.30
	QED300 Series End Cap (Specify finish)	8Q00123	1	23.00

# STANLEY Commercial Hardware

## QED300 Series | Grade 1 | Standard Duty Exit Devices

### THICK DOOR KITS (TDK'S)

Thick door kits (TDK's) are used to extend the length of the exit trim spindle for non-standard (1 3/4") thick doors. These kits include appropriate length exit trim spindles and fasteners.



Trim	Door Thickness				List Price
	2"	2 1/4"	2 1/2"	2 3/4"	
QET330	8Q00419	8Q00420	8Q00421	8Q00422	20.00
QET360					
QET370					
QET365	8Q00423	8Q00424	8Q00425	8Q00426	

### GLASS BEAD KITS (GBK'S) (SPECIFY FINISH)

- Glass bead kits (GBK's) are used to shim exit devices off the face of a door with raised glass beads. Each kit contains (2) 1/8" shims (total clearance of 1/4") and fasteners.
- Requires the use of a thick door kit (TDK) if using an exit device trim.
- Available finishes: 689, 690

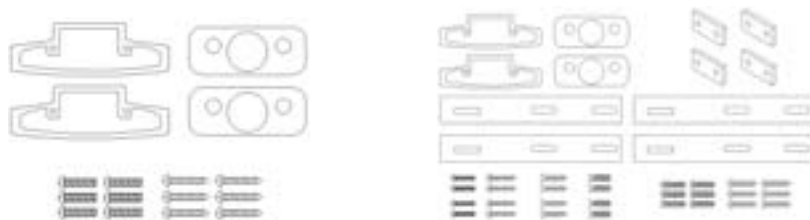

Part #	Device Type	Model	Finishes	List Price
8Q00411	RIM	QED311, QED312, QED313	689 & 690	44.00
8Q00412	SVR	QED314, QED315, QED316		58.00

# STANLEY Commercial Hardware

## QRM300 Series | Grade 1 | Mullions

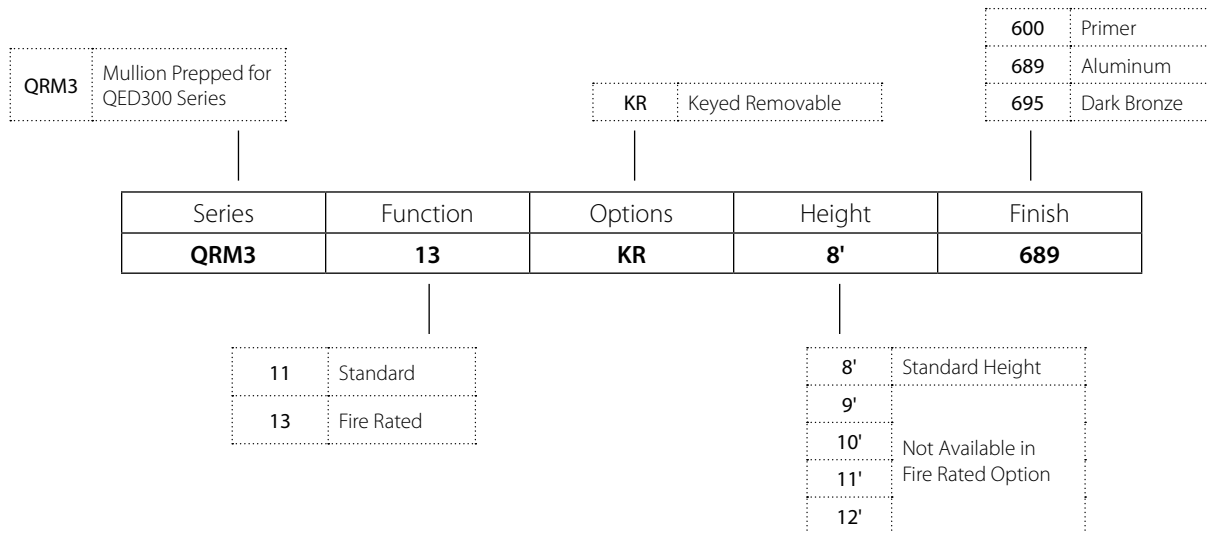

### Example

If you ordered: QRM313 KR 8' 689

You would get: Keyed Removable, Fire Rated mullion, 8' height, with Aluminum finish. Prepped for QED300 Series strike.

# STANLEY Commercial Hardware

## QRM300 Series | Grade 1 | Mullions

### Applications

Use with Rim Exit Devices on pairs of doors.

### Product Specifications

- 2"x 3" (51 mm x 76 mm) steel mullion tube. 1/8" wall thickness.
- Size: Standard for openings 8'0" high, field sizeable for openings less than 8'0". 9', 10', 11' & 12' also available and are field sizeable.
- Mullion is pre-prepped for QED300 Series Exit Devices.
- **Fire Rating 8' 0" high max.**
- Available Finishes: Primer (600), Aluminum (689) and Dark Bronze (695)

### Removable Keyed Mullion

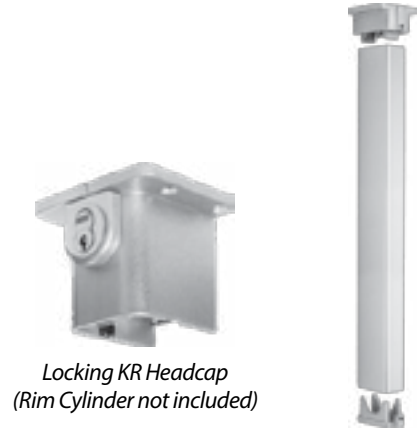

Locking KR Headcap  
(Rim Cylinder not included)

## KEYED REMOVABLE MULLIONS (CONSULT FACTORY FOR LEAD TIMES)

Order #	Description	List Price	
		600	689,695
Mullions include: Mullion Tube, Cap, Base, Fasteners. Cylinder not included. Keyed Removable Mullions utilize Standard Rim Cylinders. Reference Cylinders, Keys & Keying section for more details.			
QRM311 KR*	Keyed Removable Mullion	1029.00	1154.00
QRM313 KR	Fire Rated, Keyed Removable Mullion	1237.00	1324.00
*NOTE: For heights greater than 8'; add \$19 for each additional 12".			

## REMOVABLE MULLIONS (CONSULT FACTORY FOR LEAD TIMES)

Order #	Description	List Price	
		600	689,695
Mullions include: Mullion Tube, Cap, Base, Fasteners.			
QRM311 *	Removable Mullion	599.00	682.00
QRM313	Fire Rated, Removable Mullion	772.00	855.00
*NOTE: For heights greater than 8'; add \$19 for each additional 12".			

# STANLEY Commercial Hardware

## QET300 Series | Grade 1 | Standard Duty Exit Trims

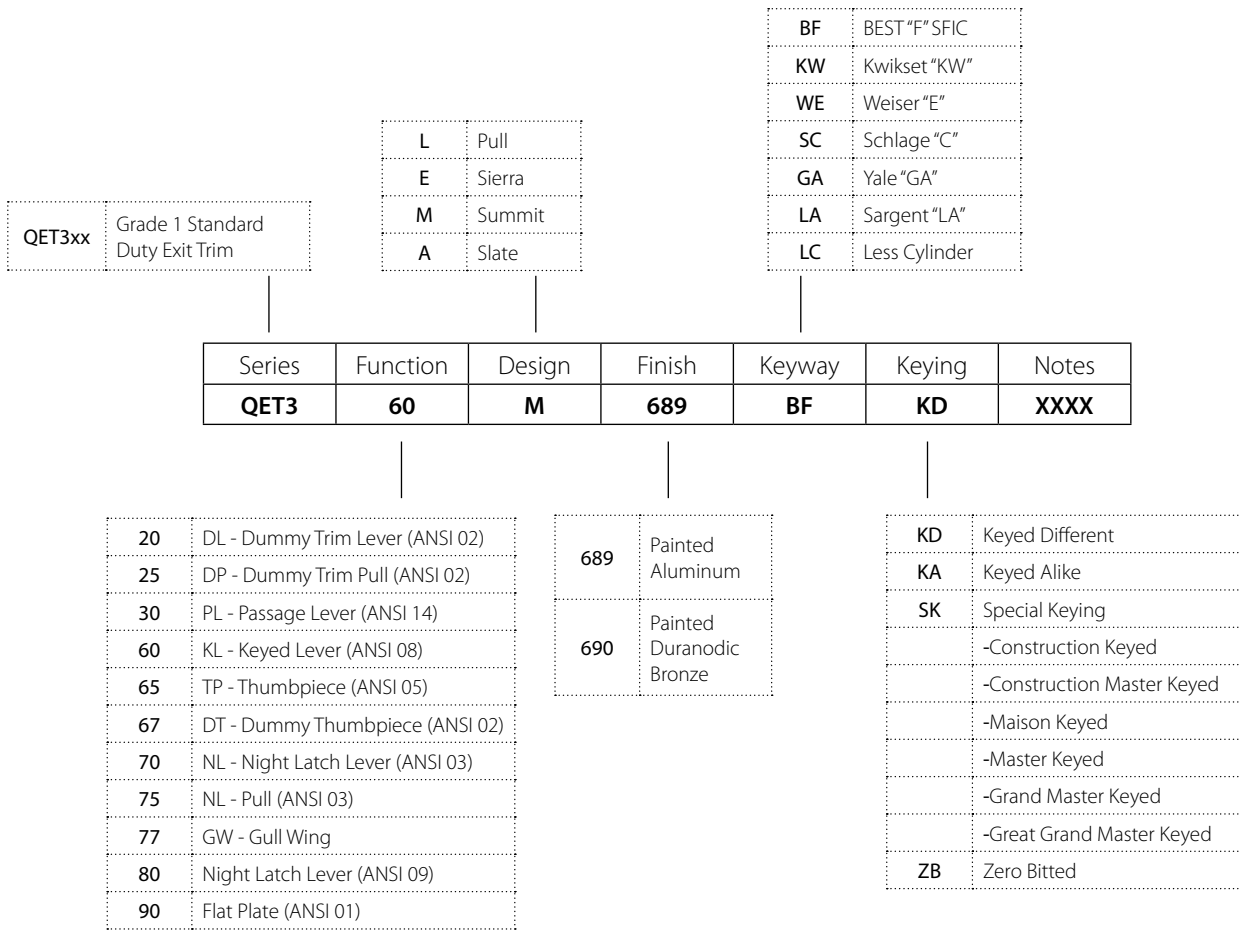

### Example

If you ordered: QET360 M 689 BF KD

You would get: Grade 1 Escutcheon Trim Lever, Summit design, Aluminum Finish SFIC "F" Keyway, Keyed Different. This Trim Matches to the QED300 Series Exit Devices

# STANLEY Commercial Hardware

## QET300 Series | Grade 1 | Standard Duty Exit Trims



### Escutcheon Trims Sierra (E)

Available in: 689, 690



### Escutcheon Trims Summit (M)

Available in: 689, 690

Model/Series	Functions	Style	Cylinder Type	Case Qty	List Price
					689, 690
QET320	Dummy Escutcheon Lever - ANSI 02	E/M/A	-	12	179.00
QET330	Passage Escutcheon Lever - ANSI 14	E/M/A	-	12	179.00
QET360	Keyed Escutcheon Lever (Classroom) - ANSI 08	E/M/A	Mortise	12	232.00
QET370*	Night Latch Escutcheon Latch (Storeroom) - ANSI 03	E/M/A	Mortise	12	232.00
QET380	Night Latch Escutcheon Latch (Storeroom) - ANSI 09	E/M/A	Mortise	12	232.00

**NOTES:**

\* Not recommended for use on exit devices with vertical rods.

### Escutcheon Trims Pull & Flat Plates

Available in: 689, 690



Dummy Pull  
QET325



Thumb Piece  
QET365



Dummy Thumb Piece  
QET367



Night Latch Pull  
QET375



Gull Wing Pull  
QET377



Flat Plate  
QET390

Model/Series	Functions	Style	Cylinder Type	Case Qty	List Price
					689, 690
QET325	Dummy Escutcheon Pull - ANSI 02	L	---	12	85.00
QET365*	Thumb Piece Escutcheon Pull - ANSI 05	L	Mortise	12	251.00
QET367	Dummy Thumb Piece Escutcheon Pull - ANSI 02	L	---	12	85.00
QET375*	Night Latch Escutcheon Pull - ANSI 03	L	Rim	12	136.00
QET377	Gull Wing Escutcheon Pull	L	Rim	12	87.00
QET390	Flat Escutcheon Plate - ANSI 01	L	---	12	46.00

**NOTES:**





\* Not recommended for use on exit devices with vertical rods.

Less Cylinder		List Price
LC	Less Cylinder	Deduct 47.00

# STANLEY Commercial Hardware

QET300 Series | Grade 1 | Standard Duty Exit Trims

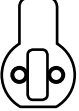
## OTHER PARTS & SCREW PACKS

	Description	Service Part #	Qty	List Price
	QET300 Series Screw Pack for Pull Plates - QET325 & QET375	8Q00134	1	1.30
	QET300 Series Cylinder Lock and Screw Pack for Thumb Piece Pulls - QET365	8Q00136	1	5.80
	QET300 Series Screw Pack, Cylinder Mounting Hardware & Square Pin for Escutcheon Trims - QET360, QET370, QET380	8Q00137	1	9.20
	QET300 Series Screw Pack & Square Pin for Escutcheon Trims - QET320 & QET330	8Q00206	1	4.60
	QET300 Series Cylinder Collar (Specify finish)	8Q00138	1	24.00
	QET300 Series Sex Nuts for Flat Plate - QET390 (Qty 2) (Specify finish)	8Q00139	1	5.80
	Rim Cylinder Tailpiece	8Q00140	1	2.50
	Rim Cylinder Tailpiece– Thick Door (Measures 2-3/8")	8Q00480	1	2.50
	Standard Cam for Mortise Cylinder	8Q00119	1	4.60
	Cam Mounting Screws for Mortise Cylinders (Qty 2)	8Q00118	1	1.50
	Rim Cylinder Retaining Cup	8Q00529	1	5.80



# STANLEY Commercial Hardware

## QRT300 Series | Grade 1 | Standard Duty Round Rose Exit Trims

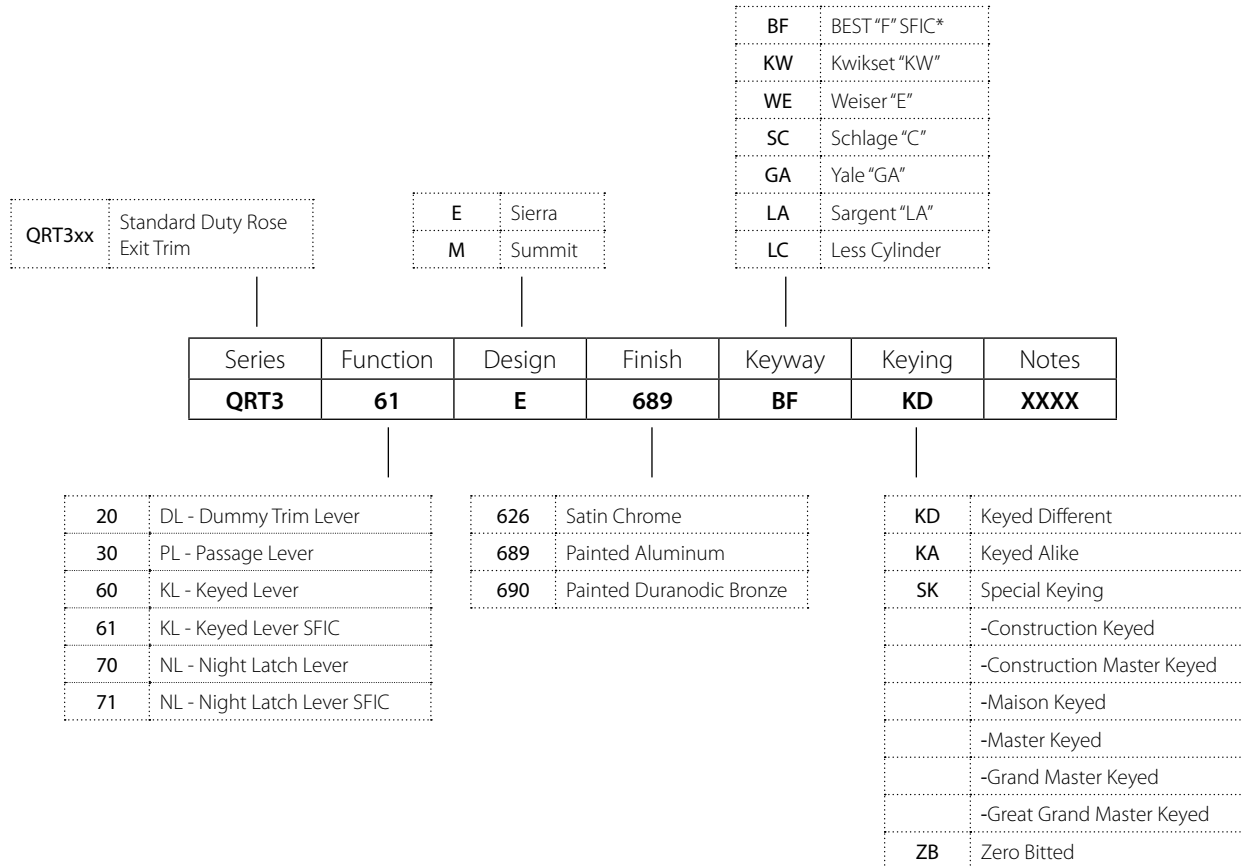

\*BEST "F" SFIC only on QRT 361 and QRT 371.

### Example

If you ordered: QRT361 E 689 BF KD

You would get: Standard Duty Keyed Lever Round Rose Trim, Sierra Lever, Painted Aluminum Finish, SFIC "F" Keyway, Keyed Different. This Trim Matches to the QED300 Series Exit Devices

# STANLEY Commercial Hardware

## QRT300 Series | Grade 1 | Standard Duty Round Rose Exit Trims

### Round Rose Trims Sierra (E)

Available in: 689, 690



### Round Rose Trims Summit (M)

Available in: 689, 690







Model / Series	Functions	Style	Case Qty	List Price	List Price
				626	689, 690
QRT320	Dummy Lever	E/M	12	148.00	117.00
QRT330	Passage Lever	E/M	12	148.00	117.00
QRT360	Keyed Lever (Classroom)	E/M	12	187.00	156.00
QRT361	Keyed Lever SFIC (Classroom)	E/M	12	210.00	179.00
QRT370	Night Latch Lever (Storeroom)	E/M	12	187.00	156.00
QRT371	Night Latch Lever SFIC (Storeroom)	E/M	12	210.00	179.00

# STANLEY Commercial Hardware

**QRT300 Series | Grade 1 | Standard Duty Round Rose Exit Trims**

## OTHER PARTS & SCREW PACKS

	Description	Service Part #	Qty	List Price
	Tailpiece QRT300 Series	8Q00073	1	2.50
	Screw pack for QRT300 series trims (Specify finish)	8Q00219	1	2.30
	Strike shim kit for rim devices- 1 piece (2 3/8" Backset for QED300 series)	8Q00285	1	6.90
	Strike shim kit for rim devices - 4 piece (2 3/4" Backset for QED300 series)	8Q00286	1	21.00

Less Cylinder		List Price
LC	Less Cylinder	Deduct 21.00
	Less SFIC Cylinder	Deduct 44.00

# STANLEY Commercial Hardware

## QDC100 Series | Grade 1 | Extra Duty Door Closers

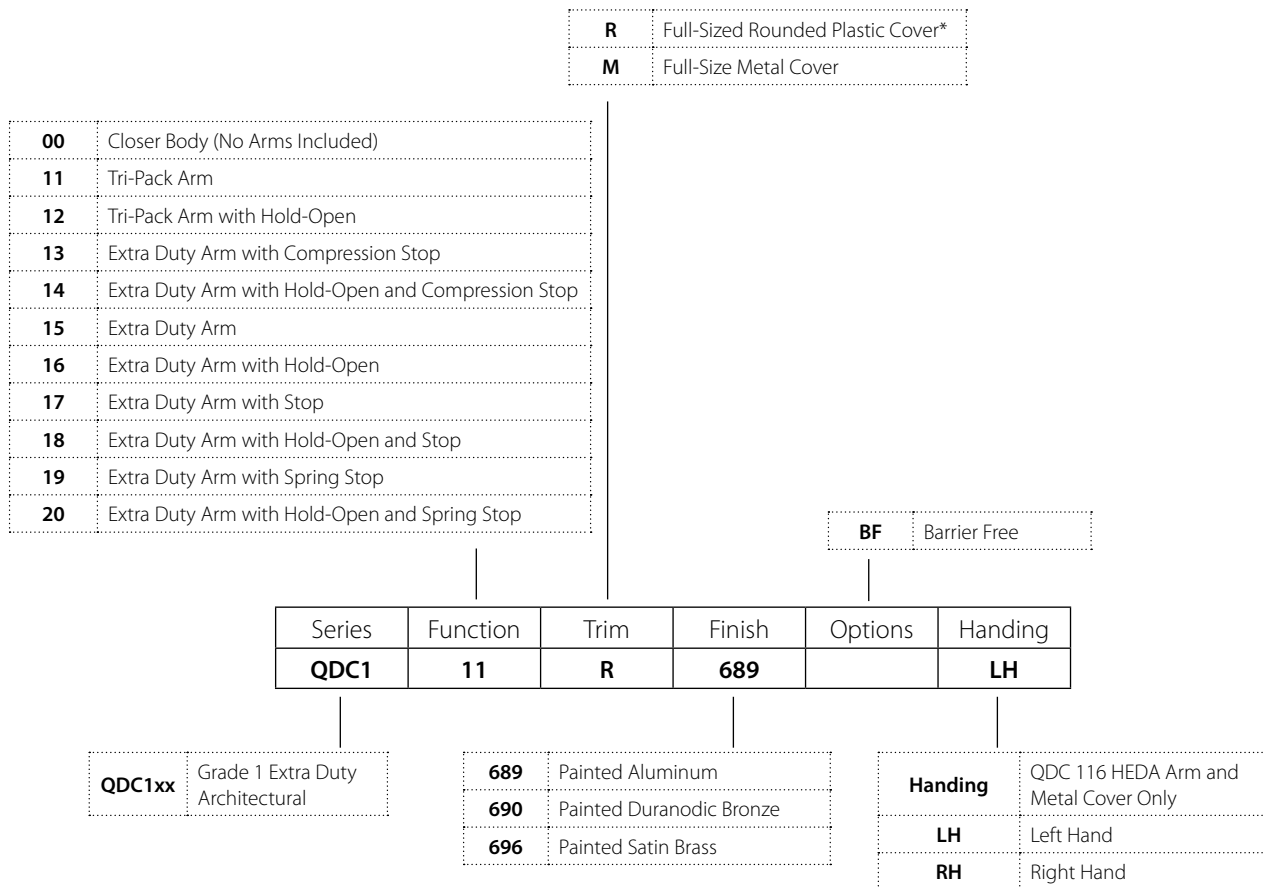

\* R - Ships standard

**NOTES:**

Sex nuts and self tapping screws come standard with QDC100 series door closers.

### Example

If you ordered: QDC111 R 689

You would get: Grade 1 Extra Duty Closer - Full Adjustable (Sized 1-6),

Tri-pack Arm with Both Delayed Action & Back Check

Standard, Round Plastic Cover, Sex Nuts, Self Tapping Screws, Painted Aluminum finish

# STANLEY Commercial Hardware

## QDC100 Series | Grade 1 | Extra Duty Door Closers

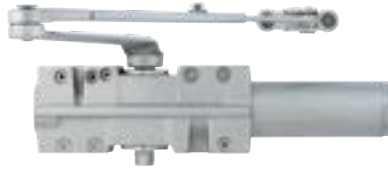

**Tri-Pack Arm**

Available in: 689, 690 & 696

Model/Series	Functions	Case Qty	List Price
			689, 690 & 696
QDC100	Closer Body (Includes Rounded Cover, Screws & Sex Bolt)	3	286.00
QDC100BF	Closer Body w/Barrier Free Option (Includes Rounded Cover, Screws & Sex Bolts)	3	286.00
QDC111	Tri-Pack Arm	3	350.00
QDC112	Tri-Pack Arm with Hold-Open	1	396.00
QDC113	Extra Duty Arm with Compression Stop	1	410.00
QDC114	Extra Duty Arm with Hold-Open and Compression Stop	1	433.00
QDC115	Extra Duty Arm	1	379.00
QDC116	Extra Duty Arm with Hold-Open	1	401.00
QDC117	Extra Duty Arm with Stop	1	390.00
QDC118	Extra Duty Arm with Hold-Open and Stop	1	412.00
QDC119	Extra Duty Arm with Spring Stop	1	481.00
QDC120	Extra Duty Arm with Hold Open and Spring Stop	1	503.00

	Order With Closer	Description	With Closer	Service Part #	List Price
	SN	Sex Nuts (Qty 4) (Specify finish)	NC	8Q00097	6.30
	S/TAP	Self Tapping Screws (Specify Finish)	NC	8Q00436	15.00
	M	QDC100 Series Metal Cover - RH	Add 57.00	8Q01140	57.00
	M	QDC100 Series Metal Cover - LH	Add 57.00	8Q01141	57.00
	R	Rounded Plastic Cover 689	NC	8Q00540	29.00
		Rounded Plastic Cover 690		8Q00541	
		Rounded Plastic Cover 696		8Q00542	

**NOTES:**

Consult factory for lead times on Barrier Free (BF) closers and on 696 finish.

# STANLEY Commercial Hardware

## QDC100 Series | Grade 1 | Extra Duty Door Closers

### OTHER PARTS & SCREW PACKS (SPECIFY FINISH)

	Description	Service Part #	Qty	List Price
	Tri-Pack Arm (requires screw pack 8Q00457)	8Q00462	1	64.00
	Tri-Pack Arm with Hold-Open (requires screw pack 8Q00458)	8Q00463	1	122.00
	Extra Duty Arm with Compression Stop (requires screw pack 8Q00459)	8Q00464	1	137.00
	Extra Duty Arm with Hold-Open and Compression Stop (requires screw pack 8Q00459)	8Q00465	1	151.00
	Extra Duty Arm (requires screw pack 8Q00460)	8Q00466	1	126.00
	Extra Duty Arm with Hold-Open - Right Hand (requires screw pack 8Q00460)	8Q00467	1	140.00
	Extra Duty Arm with Hold-Open - Left Hand (requires screw pack 8Q00460)	8Q00468	1	140.00
	Extra Duty Arm with Stop (requires screw pack 8Q00459)	8Q01142	1	130.00
	Extra Duty Arm with Hold-Open and Stop (requires screw pack 8Q00459)	8Q01143	1	144.00
	QDC100 Series Plastic Cover	8Q00461	1	32.00
	Mounting Screw Pack for QDC100 Series	8Q00456	1	25.00
	Screw Pack for QDC111 Tri-Pack Arm	8Q00587	1	15.00
	Screw Pack for QDC112 Tri-Pack Arm with Hold-Open	8Q00458	1	14.00
	Screw Pack for QDC113 Extra Duty Arm with Hold-Open & QDC114 Extra Duty Arm with Hold-Open and Compression Stop	8Q00459	1	14.00
	Screw Pack for QDC115 Extra Duty Arm & QDC116 Extra Duty Arm with Hold-Open	8Q00460	1	14.00
	QDC100 Drop Plate Kit - Pull Side, Regular Arm (requires screw pack 8Q00473)	8Q00469	1	47.00
	QDC100 Drop Plate Kit - Push Side, Top Jamb (requires screw pack 8Q00473)	8Q00470	1	47.00
	QDC100 Drop Plate Kit - Push Side, Parallel Arm (requires screw pack 8Q00473)	8Q00471	1	47.00
	QDC100 Drop Plate Kit - Push Side, Top Jamb (requires screw pack 8Q00473)	8Q00472	1	47.00
	Screw Pack for QDC100 Drop Plates	8Q00473	1	2.90

# STANLEY Commercial Hardware

QDC100 Series | Grade 1 | Extra Duty Door Closers

## OTHER PARTS & SCREW PACKS (SPECIFY FINISH)

	Description	Service Part #	Qty	List Price
NO IMAGE	Spring Stop Only for Retrofit on QDC113, 114, 117, 118 in Finish 689	8Q00584	1	109.00
NO IMAGE	Spring Stop Only for Retrofit on QDC113, 114, 117, 118 in Finish 690	8Q00585	1	109.00
NO IMAGE	Spring Stop Only for Retrofit on QDC113, 114, 117, 118 in Finish 696	8Q00586	1	72.00
NO IMAGE	Extra Duty Arm with Spring Stop in Finish 689	8Q00534	1	221.00
NO IMAGE	Extra Duty Arm with Spring Stop in Finish 690	8Q00535	1	221.00
NO IMAGE	Extra Duty Arm with Spring Stop in Finish 696	8Q00536	1	221.00
NO IMAGE	Extra Duty Arm with Hold-Open and Spring Stop in Finish 689	8Q00537	1	236.00
NO IMAGE	Extra Duty Arm with Hold-Open and Spring Stop in Finish 690	8Q00538	1	236.00
NO IMAGE	Extra Duty Arm with Hold-Open and Spring Stop in Finish 696	8Q00539	1	236.00

# STANLEY Commercial Hardware

## QDC200 Series | Grade 1 | Heavy Duty Door Closers

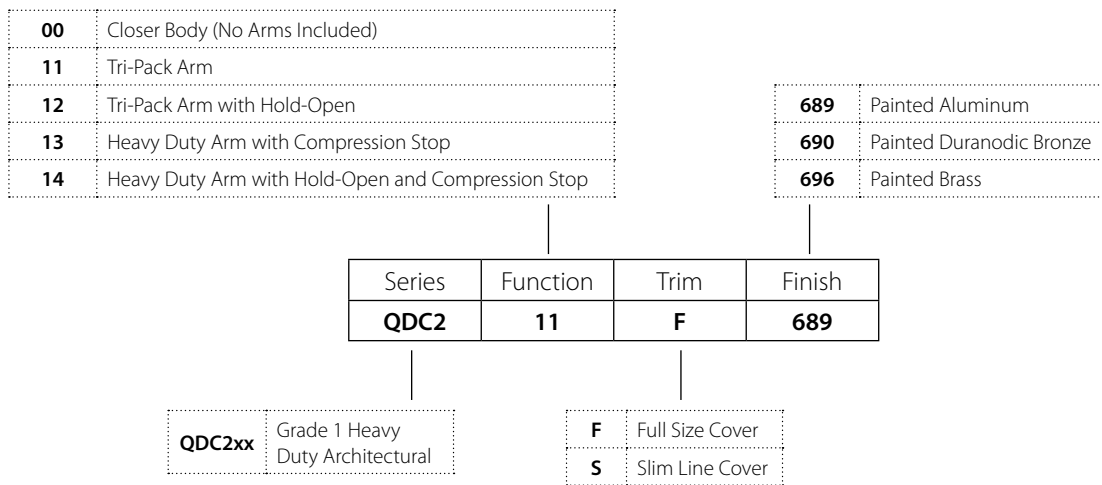

**NOTES:**

Sex nuts and self tapping screws come standard with QDC200 series door closers.

**Example**

If you ordered: QDC211 F 689

You would get: Grade 1 Heavy Duty Slim line Non-Hold Open Door Closer - Full Adjustable (Sized 1-6), Tri-packed Arms with Both Delayed Action & Back Check Standard, Full Sized cover, Painted Aluminum finish, Sex Nuts and Self Tapping Screws



# STANLEY Commercial Hardware

## QDC200 Series | Grade 1 | Heavy Duty Door Closers

### Tri-Pack Arm

Available in: 689, 690 & 696



### Tri-Pack Arm with Hold-Open

Available in: 689, 690 & 696



### Heavy Duty Arm with Compression Stop

Available in: 689, 690 & 696







### Heavy Duty Arm with Hold-Open and Compression Stop

Available in: 689, 690 & 696



Model / Series	Functions	Case Qty	List Price
			689, 690 & 696
QDC200	Closer Body (Includes Closer Body, Cover, Screws & Sex Bolts)	6	197.00
QDC211	Tri-Pack Arm	6	241.00
QDC212	Tri-Pack Arm with Hold-Open	6	280.00
QDC213	Heavy Duty Arm with Compression Stop	3	349.00
QDC214	Heavy Duty Arm with Hold-Open and Compression Stop	3	369.00

	Order with Closer	Description	With Closer	Service Part #	List Price
			689, 690 & 696		689, 690 & 696
	F	Full Size Cover (Specify Finish)	NC	8Q00094	22.00
	S	Slim Cover (Specify Finish)	NC	8Q00096	22.00
	SN	Sex Nuts (Qty 4) (Specify Finish)	NC	8Q00097	6.30
	S/TAP	Self Tapping Screws (Qty 8) (Specify Finish)	NC	8Q00436	15.00















**NOTES:**

Consult factory for lead times on 696 finish.

# STANLEY Commercial Hardware

## QDC200 Series | Grade 1 | Heavy Duty Door Closers

### OTHER PARTS & SCREW PACKS (SPECIFY FINISH)

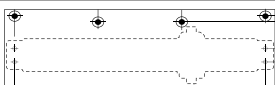
	Description	Service Part #	Qty	List Price
	QDC200 Series Plastic Installation Template	8Q00454	1	41.00
	Tri-Pack Arm (requires screw pack 8Q00100)	8Q00087	1	44.00
	Tri-Pack Arm with Hold-Open (requires screw pack 8Q00099)	8Q00088	1	85.00
	Heavy Duty Arm with Compression Stop (requires screw pack 8Q00098)	8Q00089	1	98.00
	Heavy Duty Arm with Hold-Open and Compression Stop (requires screw pack 8Q00098)	8Q00090	1	109.00
	Pinion Cap - QDC200 Series	8Q00092	1	6.30
	Parallel Arm Bracket (requires screw pack 8Q00102)	8Q00093	1	8.90
	Screw Pack for QDC213 Heavy Duty Arm with Compression Stop & QDC214 Heavy Duty Arm with Hold-Open and Compression Stop	8Q00098	1	2.80
	Screw Pack for QDC212 Tri-Pack Arm with Hold Open	8Q00099	1	2.80
	Mounting Screw Pack for QDC200 Series	8Q00100	1	2.80
	Screw Pack for Parallel Arm Bracket	8Q00102	1	2.80
	Self Tapping Screw Pack (Qty 8)	8Q00436	1	15.00
	Small Drop Plate Kit for QDC200 Series, Pull & Push (2.44" x 12.97") Top Jamb & Regular Arm	8Q00105	1	41.00
	Large Drop Plate Kit for QDC200 Series, Pull & Push (3.47" x 12.97") Top Jamb & Regular Arm	8Q00106	1	41.00
	Small Drop Plate Kit for QDC200 Series, Push (2.94" x 12.97") Parallel Arm	8Q00107	1	41.00
	Large Drop Plate Kit for QDC200 Series, Push Parallel Arm	8Q00108	1	41.00

# STANLEY Commercial Hardware

## QDC300 Series | Grade 1 | Standard Duty Door Closers

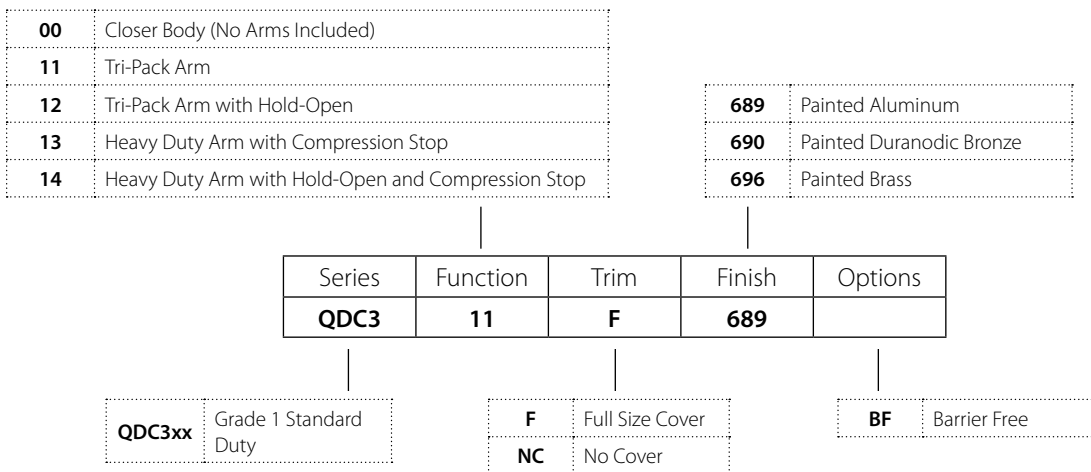

**NOTES:**

Sex nuts and self tapping screws come standard with QDC300 series door closers.

### Example

If you ordered: QDC311 F 689

You would get: Grade 1 Standard Duty Non-Hold Open Door Closer - Full Adjustable (Sized 1-6), Tri-packed Arms with Both Delayed Action & Back Check Standard, Full Sized cover, Painted Aluminum finish, Sex Nuts and Self Tapping Screws

# STANLEY Commercial Hardware

## QDC300 Series | Grade 1 | Standard Duty Door Closers

### Tri-Pack Arm

Available in: 689, 690 & 696



### Tri-Pack Arm with Open Arm

Available in: 689, 690 & 696



### Heavy Duty Arm with Compression Stop

Available in: 689, 690 & 696





### Heavy Duty Arm with Hold Open and Compression Stop

Available in: 689, 690 & 696



Model / Series	Functions	Case Qty	List Price
			689, 690 & 696
QDC300	Closer Body (Includes Closer Body, Cover, Screws & Sex Bolts)	6	128.00
QDC311	Tri-Pack Arm	6	194.00
QDC312	Tri-Pack Arm with Hold-Open	6	230.00
QDC313	Heavy Duty Arm with Compression Stop	3	298.00
QDC314	Heavy Duty Arm with Hold-Open and Compression Stop	3	316.00

Order With Closer		Description	With Closer	Service Part #	List Price
	F	Full Size Cover (Specify finish)	Add 22.00	8Q00095	22.00
	SN	Sex Nuts (Qty 4) (Specify finish)	NC	8Q00097	6.30
	S/TAP	Self Tapping Screws (Qty 8)	NC	8Q00436	15.00









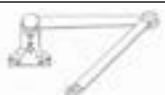

**NOTES:**

Consult factory for lead times on Barrier Free (BF) closers and on 696 finish.

# STANLEY Commercial Hardware

QDC300 Series | Grade 1 | Standard Duty Door Closers

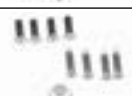
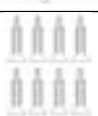
## OTHER PARTS & SCREW PACKS (SPECIFY FINISH)

	Description	Service Part #	Qty	List Price
	QDC300 Series Plastic Installation Template	8Q00455	1	39.00
	Tri-Pack Arm (requires screw pack 8Q00100)	8Q00087	1	44.00
	Tri-Pack Arm with Hold-Open (requires screw pack 8Q00099)	8Q00088	1	85.00
	Heavy Duty Arm with Compression Stop (requires screw pack 8Q00098)	8Q00089	1	98.00
	Heavy Duty Arm with Hold-Open and Compression Stop (requires screw pack 8Q00098)	8Q00090	1	109.00
	Pinion Cap - QDC300 Series	8Q00092	1	6.30
	Parallel Arm Bracket (requires screw pack 8Q00102)	8Q00093	1	8.90
	Screw Pack for QDC313 Dead Stop (Cush) Arm & QDC314 Dead Stop (Cush) Arm Hold-Open	8Q00098	1	2.80
	Screw Pack for QDC312 Hold-Open Arm	8Q00099	1	2.80
	Mounting Screw Pack for QDC300 Series	8Q00100	1	2.80
	Screw Pack for Parallel Arm Bracket	8Q00102	1	2.80
	Self tapping screw pack (Qty 8)	8Q00436	1	15.00
	Small Drop Plate Kit for QDC300 Series, (2.38" x 9.76")	8Q00103	1	39.00
	Large Drop Plate Kit for QDC300 Series, (3.27" x 9.76")	8Q00104	1	39.00

# STANLEY Commercial Hardware

## Weights & Measurements

Product	Function	Unit Weight	Case Qty	Pallet Qty	Case Box			Unit Box		
					Length	Width	Height	Length	Width	Height
<b>QMS/QME/QML SERIES - GRADE 1 MORTISE LOCKS</b>										
<b>Sectional Trims</b>										
QMS120	Single Dummy Sectional	1.23	4	96	17	14.25	10	13.38	8.63	4
QMS122	Full Dummy Sectional	1.8	4	96	17	14.25	10	13.38	8.63	4
QMS130	Passage Sectional	4.83	4	96	17	14.25	10	13.38	8.63	4
QMS140	Privacy Sectional	5.75	4	96	17	14.25	10	13.38	8.63	4
QMS145	Privacy w/ Deadbolt Sectional	6	4	96	17	14.25	10	13.38	8.63	4
QMS150	Entry Sectional	5.85	4	96	17	14.25	10	13.38	8.63	4
QMS152	Exit Sectional	6.50	4	96	17	14.25	10	13.38	8.63	4
QMS154	Corridor Sectional	6.56	4	96	17	14.25	10	13.38	8.63	4
QMS158	Dormitory Sectional	6.64	4	96	17	14.25	10	13.38	8.63	4
QMS160	Classroom Sectional	5.79	4	96	17	14.25	10	13.38	8.63	4
QMS162	Classroom Security Sectional	6.42	4	96	17	14.25	10	13.38	8.63	4
QMS164	Apartment Sectional	6.42	4	96	17	14.25	10	13.38	8.63	4
QMS170	Storeroom Sectional	5.61	4	96	17	14.25	10	13.38	8.63	4
QMS172	Institutional Sectional	6.20	4	96	17	14.25	10	13.38	8.63	4
QMS174	Store Door Sectional	6.53	4	96	17	14.25	10	13.38	8.63	4
<b>Escutcheon Trims</b>										
QME120	Single Dummy Escutcheon	2.30	4	96	17	14.25	10	13.38	8.63	4
QME122	Full Dummy Escutcheon	3.80	4	96	17	14.25	10	13.38	8.63	4
QME130	Passage Escutcheon	6.04	4	96	17	14.25	10	13.38	8.63	4
QME140	Privacy Escutcheon	6.44	4	96	17	14.25	10	13.38	8.63	4
QME145	Privacy w/ Deadbolt Escutcheon	6.68	4	96	17	14.25	10	13.38	8.63	4
QME150	Entry Escutcheon	6.93	4	96	17	14.25	10	13.38	8.63	4
QME152	Exit Escutcheon	7.45	4	96	17	14.25	10	13.38	8.63	4
QME154	Corridor Escutcheon	7.51	4	96	17	14.25	10	13.38	8.63	4
QME158	Dormitory Escutcheon	7.65	4	96	17	14.25	10	13.38	8.63	4
QME160	Classroom Escutcheon	6.78	4	96	17	14.25	10	13.38	8.63	4
QME162	Classroom Security Escutcheon	7.41	4	96	17	14.25	10	13.38	8.63	4
QME164	Apartment Escutcheon	7.41	4	96	17	14.25	10	13.38	8.63	4
QME170	Storeroom Escutcheon	6.58	4	96	17	14.25	10	13.38	8.63	4
QME172	Institutional Escutcheon	7.18	4	96	17	14.25	10	13.38	8.63	4
QME174	Store Door Escutcheon	7.52	4	96	17	14.25	10	13.38	8.63	4
<b>Deadlocks</b>										
QML180	Single Cylinder Deadlock	2.68	10	300	20.87	13.39	7.09	10	5.9	2.36
QML182	Double Cylinder Deadlock	2.95	10	300	20.87	13.39	7.09	10	5.9	2.36
QML184	Single Sided Deadlock	2.28	10	300	20.87	13.39	7.09	10	5.9	2.36
QML186	Classroom Deadlock	2.68	10	300	20.87	13.39	7.09	10	5.9	2.36

## Weights & Measurements

Product	Function	Unit Weight	Case Qty	Pallet Qty	Case Box			Unit Box		
					Length	Width	Height	Length	Width	Height
<b>QCL100 SERIES - GRADE 1 CYLINDRICAL LOCKS</b>										
QCL120	Dummy	1.55	12	432	14	11.75	7.5	6.75	3.75	3.25
QCL130	Passage	4.7	6	192	15.5	12.5	10.25	7.5	9.75	4
QCL135	Communicating	4.8	6	192	15.5	12.5	10.25	7.5	9.75	4
QCL140	Privacy	4.8	6	192	15.5	12.5	10.25	7.5	9.75	4
QCL150	Entry	5	6	192	15.5	12.5	10.25	7.5	9.75	4
QCL151	Entry SFIC	5	6	192	15.5	12.5	10.25	7.5	9.75	4
QCL160	Classroom	5	6	192	15.5	12.5	10.25	7.5	9.75	4
QCL161	Classroom SFIC	5	6	192	15.5	12.5	10.25	7.5	9.75	4
QCL170	Storeroom	5	6	192	15.5	12.5	10.25	7.5	9.75	4
QCL171	Storeroom SFIC	5	6	192	15.5	12.5	10.25	7.5	9.75	4
<b>QCL200 SERIES - GRADE 2 CYLINDRICAL LOCKS</b>										
QCL220	Dummy	1.2	12	432	14	11.75	7.5	6.75	3.75	3.25
QCL230	Passage	4	6	192	15.5	12.5	10.25	7.5	9.75	4
QCL235	Communicating	4	6	192	15.5	12.5	10.25	7.5	9.75	4
QCL240	Privacy	4.75	6	192	15.5	12.5	10.25	7.5	9.75	4
QCL250	Entry	4.5	6	192	15.5	12.5	10.25	7.5	9.75	4
QCL251	Entry SFIC	4.5	6	192	15.5	12.5	10.25	7.5	9.75	4
QCL260	Classroom	4.5	6	192	15.5	12.5	10.25	7.5	9.75	4
QCL261	Classroom SFIC	4.5	6	192	15.5	12.5	10.25	7.5	9.75	4
QCL270	Storeroom	4.5	6	192	15.5	12.5	10.25	7.5	9.75	4
QCL271	Storeroom SFIC	4.5	6	192	15.5	12.5	10.25	7.5	9.75	4
<b>QCI200 SERIES - GRADE 2 INTERCONNECT LOCKS</b>										
QCI230	Single Locking	5.5	6	192	15.5	12.25	10.63	9.63	7.5	4
QCI231	Single Locking SFIC	5.5	6	192	15.5	12.25	10.63	9.63	7.5	4
QCI250	Double Locking	5.5	6	192	15.5	12.25	10.63	9.63	7.5	4
QCI251	Double Locking SFIC	5.5	6	192	15.5	12.25	10.63	9.63	7.5	4
<b>QTL200 SERIES - GRADE 2 TUBULAR LOCKS</b>										
QTL220	Dummy	1.2	12	432	13.75	12.5	7	6	3.75	3.25
QTL230	Passage	2.3	10	320	17	13.25	8.75	8	6	3.25
QTL235	Communicating	2.5	10	320	17	13.25	8.75	8	6	3.25
QTL240	Privacy	2.8	10	320	17	13.25	8.75	8	6	3.25
QTL250	Entry	2.8	10	320	17	13.25	8.75	8	6	3.25
QTL251	Entry SFIC	2.8	10	320	17	13.25	8.75	8	6	3.25
QTL260	Classroom	2.8	10	320	17	13.25	8.75	8	6	3.25
QTL261	Classroom SFIC	2.8	10	320	17	13.25	8.75	8	6	3.25
QTL270	Storeroom	2.8	10	320	17	13.25	8.75	8	6	3.25
QTL271	Storeroom SFIC	2.8	10	320	17	13.25	8.75	8	6	3.25
<b>QDB100 SERIES - GRADE 1 DEADBOLTS</b>										
QDB180	Single Cylinder	2.5	12	384	15.75	13.5	6.5	3	4	5
QDB181	Single Cylinder SFIC	2.5	12	384	15.75	13.5	6.5	3	4	5
QDB182	Double Cylinder	2.8	12	384	15.75	13.5	6.5	3	4	5
QDB183	Double Cylinder SFIC	2.8	12	384	15.75	13.5	6.5	3	4	5
QDB186	Classroom	2.5	12	384	15.75	13.5	6.5	3	4	5
QDB187	Classroom SFIC	2.5	12	384	15.75	13.5	6.5	3	4	5

# STANLEY Commercial Hardware

## Weights & Measurements

Product	Function	Unit Weight	Case Qty	Pallet Qty	Case Box			Unit Box		
					Length	Width	Height	Length	Width	Height
<b>QDB200 SERIES - GRADE 2 DEADBOLTS</b>										
QDB280	Single Cylinder	2.3	12	384	15.75	13.5	6.5	3	4	5
QDB281	Single Cylinder SFIC	2.3	12	384	15.75	13.5	6.5	3	4	5
QDB282	Double Cylinder	2.7	12	384	15.75	13.5	6.5	3	4	5
QDB283	Double Cylinder SFIC	2.7	12	384	15.75	13.5	6.5	3	4	5
QDB284	Inside Turnbolt	2	12	384	15.75	13.5	6.5	3	4	5
QDB285	Indicator	1.27	12	384	15.75	13.5	6.5	3	4	5
QDB286	Classroom	2.3	12	384	15.75	13.5	6.5	3	4	5
QDB287	Classroom SFIC	2.3	12	384	15.75	13.5	6.5	3	4	5
QDB288	Key Control	2.25	12	384	15.75	13.5	6.5	3	4	5
<b>QED100 SERIES - GRADE 1 HEAVY DUTY EXIT DEVICES &amp; TRIMS</b>										
QED111 36"	Rim Hex Dogging	11.7	1	40	36	10.25	5	36	10.25	5
QED112 36"	Rim Cylinder Dogging	11.7	1	40	36	10.25	5	36	10.25	5
QED113 36"	Rim Fire Rated	11.5	1	40	36	10.25	5	36	10.25	5
QED114 36" 7'	Surface Vertical Rod - Hex Dogging	14.7	1	40	36	10.25	5	36	10.25	5
QED114 36" 8'	Surface Vertical Rod - Hex Dogging	14.9	1	40	48	10.25	5	48	10.25	5
QED115 36" 7'	Surface Vertical Rod - Cylinder Dogging	14.7	1	40	36	10.25	5	36	10.25	5
QED115 36" 8'	Surface Vertical Rod - Cylinder Dogging	14.9	1	40	48	10.25	5	48	10.25	5
QED116 36" 7'	Surface Vertical Rod - Fire Rated	14.5	1	40	36	10.25	5	36	10.25	5
QED116 36" 8'	Surface Vertical Rod - Fire Rated	14.7	1	40	48	10.25	5	48	10.25	5
QED117 36" 7'	SVR - Less Bottom Rod - Hex Dogging	14.2	1	40	36	10.25	5	36	10.25	5
QED117 36" 8'	SVR - Less Bottom Rod - Hex Dogging	14.4	1	40	48	10.25	5	48	10.25	5
QED118 36" 7'	SVR - Less Bottom Rod - Cylinder Dogging	14.2	1	40	36	10.25	5	36	10.25	5
QED118 36" 8'	SVR - Less Bottom Rod - Cylinder Dogging	14.4	1	40	48	10.25	5	48	10.25	5
QED119 36" 7'	SVR - Less Bottom Rod - Fire Rated	14.7	1	40	36	10.25	5	36	10.25	5
QED119 36" 8'	SVR - Less Bottom Rod - Fire Rated	14.9	1	40	48	10.25	5	48	10.25	5
QED124 36" 7'	Concealed Vertical Rod - Hex Dogging	14.7	1	40	36	10.25	5	36	10.25	5
QED124 36" 8'	Concealed Vertical Rod - Hex Dogging	14.9	1	40	48	10.25	5	48	10.25	5
QED125 36" 7'	Concealed Vertical Rod - Cylinder Dogging	14.7	1	40	36	10.25	5	36	10.25	5
QED125 36" 8'	Concealed Vertical Rod - Cylinder Dogging	14.9	1	40	48	10.25	5	48	10.25	5
QED126 36" 7'	Concealed Vertical Rod - Fire Rated	14.5	1	40	36	10.25	5	36	10.25	5
QED126 36" 8'	Concealed Vertical Rod - Fire Rated	14.7	1	40	48	10.25	5	48	10.25	5
QED127 36" 7'	CVR - Less Bottom Rod - Hex Dogging	14.2	1	40	36	10.25	5	36	10.25	5
QED127 36" 8'	CVR - Less Bottom Rod - Hex Dogging	14.4	1	40	48	10.25	5	48	10.25	5
QED128 36" 7'	CVR - Less Bottom Rod - Cylinder Dogging	14.2	1	40	36	10.25	5	36	10.25	5
QED128 36" 8'	CVR - Less Bottom Rod - Cylinder Dogging	14.4	1	40	48	10.25	5	48	10.25	5
QED129 36" 7'	CVR - Less Bottom Rod - Fire Rated	14.7	1	40	36	10.25	5	36	10.25	5
QED129 36" 8'	CVR - Less Bottom Rod - Fire Rated	14.9	1	40	48	10.25	5	48	10.25	5
QED111 48"	Rim Hex Dogging	11.9	1	40	48	10.25	5	48	10.25	5
QED112 48"	Rim Cylinder Dogging	11.9	1	40	48	10.25	5	48	10.25	5
QED113 48"	Rim Fire Rated	11.7	1	40	48	10.25	5	48	10.25	5
QED114 48" 7'	Surface Vertical Rod - Hex Dogging	14.9	1	40	48	10.25	5	48	10.25	5
QED114 48" 8'	Surface Vertical Rod - Hex Dogging	15.1	1	40	48	10.25	5	48	10.25	5
QED115 48" 7'	Surface Vertical Rod - Cylinder Dogging	14.9	1	40	48	10.25	5	48	10.25	5
QED115 48" 8'	Surface Vertical Rod - Cylinder Dogging	15.1	1	40	48	10.25	5	48	10.25	5



## Weights & Measurements

Product	Function	Unit Weight	Case Qty	Pallet Qty	Case Box			Unit Box		
					Length	Width	Height	Length	Width	Height
QED116 48" 7'	Surface Vertical Rod - Fire Rated	14.7	1	40	48	10.25	5	48	10.25	5
QED116 48" 8'	Surface Vertical Rod - Fire Rated	14.9	1	40	48	10.25	5	48	10.25	5
QED117 48" 7'	SVR - Less Bottom Rod - Hex Dogging	14.4	1	40	48	10.25	5	48	10.25	5
QED117 48" 8'	SVR - Less Bottom Rod - Hex Dogging	14.6	1	40	48	10.25	5	48	10.25	5
QED118 48" 7'	SVR - Less Bottom Rod - Cylinder Dogging	14.4	1	40	48	10.25	5	48	10.25	5
QED118 48" 8'	SVR - Less Bottom Rod - Cylinder Dogging	14.6	1	40	48	10.25	5	48	10.25	5
QED119 48" 7'	SVR - Less Bottom Rod - Fire Rated	14.9	1	40	48	10.25	5	48	10.25	5
QED119 48" 8'	SVR - Less Bottom Rod - Fire Rated	15.1	1	40	48	10.25	5	48	10.25	5
QED124 48" 7'	Concealed Vertical Rod - Hex Dogging	14.9	1	40	48	10.25	5	48	10.25	5
QED124 48" 8'	Concealed Vertical Rod - Hex Dogging	15.1	1	40	48	10.25	5	48	10.25	5
QED125 48" 7'	Concealed Vertical Rod - Cylinder Dogging	14.9	1	40	48	10.25	5	48	10.25	5
QED125 48" 8'	Concealed Vertical Rod - Cylinder Dogging	15.1	1	40	48	10.25	5	48	10.25	5
QED126 48" 7'	Concealed Vertical Rod - Fire Rated	14.7	1	40	48	10.25	5	48	10.25	5
QED126 48" 8'	Concealed Vertical Rod - Fire Rated	14.9	1	40	48	10.25	5	48	10.25	5
QED127 48" 7'	CVR - Less Bottom Rod - Hex Dogging	14.4	1	40	48	10.25	5	48	10.25	5
QED127 48" 8'	CVR - Less Bottom Rod - Hex Dogging	14.6	1	40	48	10.25	5	48	10.25	5
QED128 48" 7'	CVR - Less Bottom Rod - Cylinder Dogging	14.4	1	40	48	10.25	5	48	10.25	5
QED128 48" 8'	CVR - Less Bottom Rod - Cylinder Dogging	14.4	1	40	48	10.25	5	48	10.25	5
QED129 48" 7'	CVR - Less Bottom Rod - Fire Rated	14.9	1	40	48	10.25	5	48	10.25	5
QED129 48" 8'	CVR - Less Bottom Rod - Fire Rated	15.1	1	40	48	10.25	5	48	10.25	5
<b>QET100 Series - Heavy Duty Escutcheon Exit Trim</b>										
QET120	Dummy Escutcheon Lever	2.2	6	288	16.81	14.25	9.13	8.27	5.34	3.34
QET125	Dummy Escutcheon Pull	1.9	6	162	14.9	10.35	8.7	14.37	3.15	3.86
QET130	Passage Escutcheon Lever	2.2	6	288	16.81	14.25	9.13	8.27	5.34	3.34
QET160	Keyed Escutcheon Lever (Classroom)	2.9	6	288	16.81	14.25	9.13	8.27	5.34	3.34
QET165	Thumbpiece Escutcheon Pull	3.1	6	162	14.9	10.35	8.7	14.37	3.15	3.86
QET167	Thumbpiece Dummy Escutcheon Pull	1.9	6	162	14.9	10.35	8.7	14.37	3.15	3.86
QET170	Night Latch Escutcheon Lever (Storeroom)	2.8	6	288	16.81	14.25	9.13	8.27	5.34	3.34
QET175	Night Latch Pull (Storeroom)	1.9	6	162	14.9	10.35	8.7	14.37	3.15	3.86
QET190	Flat/Blank Escutcheon Plate	1.4	6	162	14.9	10.35	8.7	14.37	3.15	3.86
<b>QED300 SERIES - GRADE 1 STANDARD DUTY EXIT DEVICES &amp; TRIMS</b>										
QED311 36"	Rim Hex Dogging	6.2	4	48	36.5	16	8.2	36.5	7.25	3.75
QED312 36"	Rim Cylinder Dogging	6.2	4	48	36.5	16	8.2	36.5	7.25	3.75
QED313 36"	Rim Fire Rated	6	4	48	36.5	16	8.2	36.5	7.25	3.75
QED314 36" 7'	Surface Vertical Rod - Hex Dogging	8.2	4	48	36.5	16	8.2	36.5	7.25	3.75
QED314 36" 8'	Surface Vertical Rod - Hex Dogging	8.4	4	48	36.5	16	8.2	36.5	7.25	3.75
QED315 36" 7'	Surface Vertical Rod - Cylinder Dogging	8.2	4	48	36.5	16	8.2	36.5	7.25	3.75
QED315 36" 8'	Surface Vertical Rod - Cylinder Dogging	8.4	4	48	36.5	16	8.2	36.5	7.25	3.75
QED316 36" 7'	Surface Vertical Rod - Fire Rated	8	4	48	36.5	16	8.2	36.5	7.25	3.75
QED316 36" 8'	Surface Vertical Rod - Fire Rated	8.2	4	48	36.5	16	8.2	36.5	7.25	3.75
QED317 36" 7'	SVR - Less Bottom Rod - Hex Dogging	8	4	48	36.5	16	8.2	36.5	7.25	3.75
QED317 36" 8'	SVR - Less Bottom Rod - Hex Dogging	8.2	4	48	36.5	16	8.2	36.5	7.25	3.75
QED318 36" 7'	SVR - Less Bottom Rod - Cylinder Dogging	8	4	48	36.5	16	8.2	36.5	7.25	3.75
QED318 36" 8'	SVR - Less Bottom Rod - Cylinder Dogging	8.2	4	48	36.5	16	8.2	36.5	7.25	3.75
QED319 36" 7'	SVR - Less Bottom Rod - Fire Rated	8.2	4	48	36.5	16	8.2	36.5	7.25	3.75

# Weights & Measurements

Product	Function	Unit Weight	Case Qty	Pallet Qty	Case Box			Unit Box		
					Length	Width	Height	Length	Width	Height
QED319 36"8'	SVR - Less Bottom Rod - Fire Rated	8.4	4	48	36.5	16	8.2	36.5	7.25	3.75
QED311 48"	Rim Hex Dogging	6.4	4	48	48.5	16	8.2	48.5	7.25	3.75
QED312 48"	Rim Cylinder Dogging	6.4	4	48	48.5	16	8.2	48.5	7.25	3.75
QED313 48"	Rim Fire Rated	6.2	4	48	48.5	16	8.2	48.5	7.25	3.75
QED314 48"7'	Surface Vertical Rod - Hex Dogging	8.4	4	48	48.5	16	8.2	48.5	7.25	3.75
QED314 48"8'	Surface Vertical Rod - Hex Dogging	8.6	4	48	48.5	16	8.2	48.5	7.25	3.75
QED315 48"7'	Surface Vertical Rod - Cylinder Dogging	8.4	4	48	48.5	16	8.2	48.5	7.25	3.75
QED315 48"8'	Surface Vertical Rod - Cylinder Dogging	8.6	4	48	48.5	16	8.2	48.5	7.25	3.75
QED316 48"7'	Surface Vertical Rod - Fire Rated	8.2	4	48	48.5	16	8.2	48.5	7.25	3.75
QED316 48"8'	Surface Vertical Rod - Fire Rated	8.4	4	48	48.5	16	8.2	48.5	7.25	3.75
QED317 48"7'	SVR - Less Bottom Rod - Hex Dogging	8.2	4	48	48.5	16	8.2	48.5	7.25	3.75
QED317 48"8'	SVR - Less Bottom Rod - Hex Dogging	8.4	4	48	48.5	16	8.2	48.5	7.25	3.75
QED318 48"7'	SVR - Less Bottom Rod - Cylinder Dogging	8.2	4	48	48.5	16	8.2	48.5	7.25	3.75
QED318 48"8'	SVR - Less Bottom Rod - Cylinder Dogging	8.4	4	48	48.5	16	8.2	48.5	7.25	3.75
QED319 48"7'	SVR - Less Bottom Rod - Fire Rated	8.4	4	48	48.5	16	8.2	48.5	7.25	3.75
QED319 48"8'	SVR - Less Bottom Rod - Fire Rated	8.6	4	48	48.5	16	8.2	48.5	7.25	3.75
<b>QET300 Series - Standard Duty Escutcheon Exit Trim</b>										
QET320	Dummy Escutcheon Lever	2.25	12	324	16.81	14.25	9.13	8.27	5.34	3.34
QET325	Dummy Escutcheon Pull	1.9	6	162	14.9	10.35	8.7	14.37	3.15	3.86
QET330	Passage Escutcheon Lever	2.8	12	324	16.81	14.25	9.13	8.27	5.34	3.34
QET360	Keyed Escutcheon Lever (Classroom)	2.8	12	324	16.81	14.25	9.13	8.27	5.34	3.34
QET365	Thumbpiece Escutcheon Pull	3.1	6	162	14.9	10.35	8.7	14.37	3.15	3.86
QET367	Thumbpiece Dummy Escutcheon Pull	1.9	6	162	14.9	10.35	8.7	14.37	3.15	3.86
QET370	Night Latch Escutcheon Lever (Storeroom)	2.8	12	324	16.81	14.25	9.13	8.27	5.34	3.34
QET375	Night Latch Pull (Storeroom)	1.9	6	162	14.9	10.35	8.7	14.37	3.15	3.86
QET377	Gull Wing Trim (Storeroom)	1.7	12	324	16.81	14.25	9.13	8.27	5.34	3.34
QET390	Flat/Blank Escutcheon Plate	1.4	6	162	14.9	10.35	8.7	14.37	3.15	3.86
<b>QRT300 Series - Standard Duty Round Rose Trim</b>										
QRT320	Dummy Round Rose	2.07	12	432	14	11.75	7.5	7.5	6.75	3.75
QRT330	Passage Round Rose	2.07	12	432	14	11.75	7.5	7.5	6.75	3.75
QRT360	Entry Round Rose (Classroom)	2.8	12	432	14	11.75	7.5	7.5	6.75	3.75
QRT361	Entry Round Rose SFIC (Classroom)	2.8	12	432	14	11.75	7.5	7.5	6.75	3.75
QRT370	Night Latch Round Rose (Storeroom)	2.8	12	432	14	11.75	7.5	7.5	6.75	3.75
QRT371	Night Latch Round Rose SFIC (Storeroom)	2.8	12	432	14	11.75	7.5	7.5	6.75	3.75
<b>DOOR CLOSERS</b>										
<b>Extra Duty</b>										
QDC111	Tri-pack	12.3	3	126	14.25	16.5	6	14.25	5.5	6
QDC112	Tri-pack with Hold Open	13.3	1	138	14.25	5.5	7	14.25	5.5	7
QDC113	Extra Duty Arm with Compression Stop	14	1	138	14.25	5.5	7	14.25	5.5	7
QDC114	Extra Duty Arm with Hold Open and Compression Stop	14	1	115	14.25	5.5	8	14.25	5.5	8
QDC115	Extra Duty Arm	13.6	1	138	14.25	5.5	7	14.25	5.5	7
QDC116	Extra Duty Arm with Hold Open	13.8	1	138	14.25	5.5	7	14.25	5.5	7
<b>Heavy Duty</b>										
QDC211	Tri-pack	6.6	6	180	14.25	15.75	7.5	13.5	4.875	3.25
QDC212	Tri-pack with Hold Open	8	6	180	14.25	15.75	7.5	13.5	4.875	3.25
QDC213	Heavy Duty Arm with Compression Stop	8.5	3	216	14.25	15.75	7.5	13.375	7.875	3.25
QDC214	Heavy Duty Arm with Hold Open and Compression Stop	8.7	3	216	14.25	15.75	7.5	13.375	7.875	3.25
<b>Standard Duty</b>										
QDC311	Tri-pack	6.3	6	180	14.25	15.75	7.5	13.5	4.875	3.25
QDC312	Tri-pack with Hold Open	7.7	6	180	14.25	15.75	7.5	13.5	4.875	3.25
QDC313	Heavy Duty Arm with Compression Stop	8.2	3	216	14.25	15.75	7.5	13.375	7.875	3.25
QDC314	Heavy Duty Arm with Hold Open and Compression Stop	8.4	3	216	14.25	15.75	7.5	13.375	7.875	3.25

# STANLEY Commercial Hardware

## QUOTING & ORDERING

Price quotations are based on one (1) shipment to one (1) location, and are valid as identified in the quote but in no case longer than one year from the date of the quote. All exceptions will be evaluated on an individual basis.

All quotation requests will be provided by the Best Access Solutions, Inc. ("Best") Representative where the project is located.

**QUOTING PROCESS AND PROCEDURES:** The following information is necessary to secure a price quotation from Best.

- Distributor Name
- Distributor Location
- Distributor Contact Name & Phone Number
- Distributor e-mail contact
- Project Name
- Project Location
- Bid Date
- Architects Name, Phone Number, and Architects Location
- Specification Writer Name, Phone Number and Location
- Competitive Influence / Specification
- List of materials to be quoted

Every attempt will be made by Best to provide the price quotation in a timely manner. Upon completion, you will receive a copy of the quotation which will also include a valid quotation number. Once the project is secured, a copy of the quotation must accompany your purchase order and be forwarded to Best Customer Service Department in Indianapolis for processing.

**NON-STANDARD PRODUCT REQUEST:** Please contact your Best Representative to complete a Non-Standard Product Request Form. All requests should be submitted to the following email address:

**Email:** [product.request.us@dormakaba.com](mailto:product.request.us@dormakaba.com)

Upon receipt of a special order request, Best will review the configuration and determine if Best is capable of making the special order product and will provide a response to the customer. If Best is able to make the special order product, Best will provide a specific sku/configuration to the customer for the special order product. This sku/configuration must be identified on all Purchase Orders. In addition, the Purchase Order must be marked as a "Special Order".

**ORDERING:** The following information is required for Best to successfully process any order:

- Itemized Purchase Order (PO)
- Best Approved Quote

Please send all orders to [BAS-orderentry.us@dormakaba.com](mailto:BAS-orderentry.us@dormakaba.com) or by fax to 877-835-1030

**NOTE:** For detailed information on how to place an order for Best products as well as BEST masterkey services please see the detailed section regarding "Best Ordering".

**ADD ON ORDERS FOR QUOTED PROJECTS:** To place an add-on order from a quoted project the Distributor must include the original quote, PO number and/or Best's original order number. Add-On orders will be accepted for a period one (1) year from the original order date. Add-On orders received that are outside of the aforementioned period will be forwarded to the Best Representative for re-quote.

**STOCKING ORDERS:** All orders for stock replenishment should be marked as "Stock" and indicate a "Ship To" address that coincides with the stocking Distributor warehouse location.

**INCOMPLETE ORDER PROCESS:** All orders are screened upon receipt for complete information. If an order is received incomplete, Best Customer Service will make one (1) attempt to contact a Distributor directly for the missing requirements. If the information is not made available to Best at that time the order will be referred to the local Best Representative for resolution. All incomplete orders will be cancelled if not resolved after fourteen (14) calendar days.

**PRICE DISCREPANCY PROCESS:** All entered orders are reviewed by Best Customer Service for accuracy and pricing consistency between the Distributor and Best. Any order determined by Best, in its sole and absolute discretion, to have a value greater than the Total Price shown on the Distributor purchase order will be held by Best for a Price Discrepancy. Best quotes are also reviewed to ensure that they are complete, approved, and match the PO. Due to pricing sensitivity, all price discrepancies must be resolved exclusively by your Best Representative.

**ORDER CANCELLATION/CHANGES:** All requests for Order Cancellations and Changes (Quantity, Shipping, Finish, Function, etc) should be sent directly to Best Customer Service. Requests via phone will be accepted, but must be accompanied by a written request. Factory Order Number, PO Number, Account Info, and Detailed Changes must be clearly indicated. Change requests can be submitted via the following methods:

**Email:** [BAS-cshelp.us@dormakaba.com](mailto:BAS-cshelp.us@dormakaba.com)  
**Fax:** 1-877-835-1030

All order cancellations or changes will be subject to a cancellation fee as defined in Best's Terms and Conditions of Sale.

**PRODUCTION SCHEDULING AND "DO NOT SHIP BEFORE" REQUESTS:** All orders are scheduled for production and shipping based on current production lead times and availability. Scheduling is completed only when an order is released from both credit and pricing review.

Exceptions to this policy are made only when the PO is clearly marked: "Do Not Ship Before" followed by the date. (*Required Date, Expected Date, etc. do not apply*) These orders will be scheduled to ship on or after the date listed.

Changes to "Do Not Ship Before" dates are required in writing and should be sent to: [BAS-cshelp.us@dormakaba.com](mailto:BAS-cshelp.us@dormakaba.com).

Be advised orders not clearly marked with a "Do Not Ship Before" designation will be payable within normal terms from the actual shipment date.

# STANLEY Commercial Hardware

## QUOTING & ORDERING (continued)

### **EXPEDITE REQUESTS:**

- Expedite requests will be reviewed and accommodated by Best based on production lead times and availability.  
**Email:** [BAS-expediterequest.us@dormakaba.com](mailto:BAS-expediterequest.us@dormakaba.com)
- See the then current BEST Quick Ship Program for details.

**WHOLESALE PURCHASE:** Distributors are also free to utilize Best's Authorized Wholesalers to purchase product. Best does not make any guarantee of availability or pricing for purchases from an Authorized Wholesaler and the discounts afforded to Distributor by Best shall not apply to purchases from an Authorized Wholesaler. The terms and conditions and price of product shall be as mutually agreed between Distributor and Wholesaler.



# STANLEY Commercial Hardware

## RETURNED AUTHORIZATION (RA)

**RA REQUESTS:** A Return Authorization Form ("RA") must be utilized to return defective products **still under warranty** or products deemed repairable by Best Access Solutions, Inc. ("Best"). All products returned to Best must have a correct Return Authorization (RA) number applied to the outside of the shipping carton. All products must be returned within sixty (60) calendar days of RA issue date. This process can take up to seven (7) days after product is received at Best's factory. If a defective product presents a security risk, an advance replacement may be requested.

**RA PROCESS:** Requests for warranty related returns can be initiated by submitting an email to **BAS-rgacreditgrp.us@dormakaba.com**.

The RA Request Form must be completed entirely to process an RA. The following information will be needed:

- End User Name
- Account Number
- Contact Name
- Phone Number
- Purchaser Order Number
- Sales Order Number
- Item Number
- Item Quantity
- Description of the Problem

1. Upon review and approval of the submitted RA request, a claim number is logged and provided back to the requestor by a Best Team member.
2. Once a claim number is issued, this number should be noted on all references and communications regarding the applicable situation to ensure a claim is easily identified.
3. Defective product should be returned to the address below. The shipment must be marked with the approved RA claim number to ensure prompt processing and attention. All shipping charges prepaid by customer.

BEST Access Solutions, Inc.  
Attn: Returns Department  
6161 East 75th Street  
Indianapolis, IN 46250

4. When material is received at Best's factory, Best will assess and determine the nature of the defect.
5. Defective goods are replaced upon Best's determination.
6. Credit for material and freight is issued only if deemed appropriate by Best. If approved, credit is initiated and a credit memo is mailed to the Distributor within fifteen (15) business days.

### **PURCHASE ORDERS:**

A Purchase Order (PO) will be required if the Product is:

1. Defective and not under warranty, or
2. An advance replacement is required without verification of whether the product is defective and under warranty.

Please send Purchase Orders to the following:

- Preferred Method Email:  
**BAS-rgacreditgrp.us@dormakaba.com**
- Fax: 1-877-835-1030

February 2018

# STANLEY Commercial Hardware

## RETURNED AUTHORIZATION (RA) NON-WARRANTY

**RA POLICY:** A Return Authorization Form ("RA") must be utilized to return products that are not defective and otherwise in a resalable condition. Only goods with an invoice date of less than one (1) year will be considered for a non-warranty related return. All materials returned to Best Access Solutions, Inc. ("Best") for any reason (other than warranty), must have a correct RA number applied to the outside of the shipping carton. A thirty percent (30%) re-stocking charge (of the purchase price) will be applied to the Distributor's account for orders returned, including orders that were placed by customer in error. Transportation charges of returned goods must be prepaid by the Distributor. All goods must be returned within sixty (60) calendar days of RA issue date. All goods must be returned in original packaging and be in resalable condition. Product not returned in saleable condition is subject to disposal by Best with no credit issued. Commercial Hardware items that are special made to order items will not be returned under any circumstances.

**RA PROCESS:** Requests for non-warranty related returns can be initiated by submitting an email to **BAS-rgacreditgrp.us@dormakaba.com**.

The RA Request Form must be completed entirely to process an RA. The following information will be needed:

- Company Name
- Account Number
- Contact Name
- Phone Number
- Purchaser Order Number
- Sales Order Number
- Item Number
- Item Quantity
- Description of the Problem

1. Upon review and approval of the submitted RA request, a claim number is logged and provided back to the requestor by a Best Team member:
2. Once a claim number is issued, this number should be noted on all references and communications concerning said RA.
3. Product should be returned to the address below. The shipment must be marked with the approved RA claim number to ensure prompt processing and attention. All shipping charges prepaid by customer.

BEST Access Solutions, Inc.  
Attn: Returns Department  
6161 East 75th Street  
Indianapolis, IN 46250

4. The RA will be processed once material is received at Best's factory provided it is received in its original packaging and is in saleable condition.
5. Credit is issued to the Distributor account and a credit memo is mailed to the Distributor.

## FULFILLMENT ISSUES

Any quality issues (missing parts, wrong parts, handling, finish, etc) should be submitted electronically to: [BAS-rgacreditgrp.us@dormakaba.com](mailto:BAS-rgacreditgrp.us@dormakaba.com) or your Local Best Representative.

Please reference your original Purchase Order (PO) Number, Factory Order Number, Distributor Account, Contact Information (E-mail/Fax), and include a detailed description of the issue.

**1) ITEMS MISSING FROM A SHIPMENT:** If you have signed your shipment short, Best Customer Service will promptly issue a No Charge replacement order for the missing products.

If the shipment was not signed short but after review, Best Customer Service determines (based on shipping weights, packing lists, etc) that the order was indeed shipped short, a No Charge replacement will be issued.

If Best Customer Service cannot verify a shipping error, an advance replacement order will be entered, charged, and expedited to the Distributor. The quality issue will be forwarded to the Return Authorization Credit Group for resolution.

If it is determined that the item was omitted from the order due to a Best order entry error, a change order will be entered and expedited for the missing products.

Please see Best's price book for further detail.

**2) WRONG ITEMS RECEIVED** (parts, handling, function, finish, etc):

Advanced replacements will be issued for any wrong items received. **Such orders will be charged based on pricing/ discounts from the original order.** The issue will be forwarded to Best's Return Authorization Credit Group for resolution.

Any quality issue that is determined to be either a Best order entry and/or manufacturing error will have an advanced replacement order entered and will be expedited. An RA will be issued to return the incorrect products. No re-stock fee will apply for Best order entry and/or manufacturing errors.

February 2018







# STANLEY Commercial Hardware

## Keying System Summary

SHEET	DATE:	PURCHASE ORDER #:	SALES ORDER #:
1 of 2			

**SOLD TO:**

---



---



---

**SHIP TO:**

---



---



---

**1. JOB NAME & ADDRESS**

---



---



---

**5. KEY QUANTITY**

MASTER LEVEL	STAMP	QTY
<input type="checkbox"/> GGM	.....	.....
<input type="checkbox"/> GM	.....	.....
<input type="checkbox"/> .....	.....	.....
<input type="checkbox"/> MK/GROUP	.....	.....
<input type="checkbox"/> .....	.....	.....
<input type="checkbox"/> OTHER	.....	.....
<input type="checkbox"/> OTHER	.....	.....
<input type="checkbox"/> OTHER	.....	.....

CHANGE KEYS*	QTY
PER CYLINDER/LOCKSET	.....
PER KEYED ALIKE GROUP	.....

\*Two cut change keys are standard per lockset/cylinder.  
Key blanks cannot be substituted for cut keys

**2. SYSTEM STATUS**

NEW       EXISTING

**3. SYSTEM TYPE**

SKD       Maison (Cross Keying)

MK       CK (Construction Keying)

GMK

GGМК

**4. KEYS**

**KEYWAY SELECTION**

KWIKSET       YALE - GA

WEISER       SARGENT - LA

SCHLAGE - C       SFIC - F (IC CORE)

---

**KEY & CYL STAMPING**

<input type="checkbox"/> VKC0 <small>No Bitting or Key Set Stamping on Keys</small>	<input type="checkbox"/> CKC2 <small>Concealed Key Control Cylinders &amp; VKC Keys</small>
<input type="checkbox"/> VKC1 <small>Visual Key Stamping (Keys Only)</small>	<input type="checkbox"/> CKC3 <small>Concealed Key Control Cylinders Only</small>
<input type="checkbox"/> VKC2 <small>Special Stamping (other than standard symbols)</small>	<input type="checkbox"/> DND <small>Do Not Duplicate (Keys Stamped)</small>
<input type="checkbox"/> VKC3 <small>Visual Key Control (Cylinder face only - levers &amp; deadbolts)</small>	- Keys: up to 6 characters
<input type="checkbox"/> VKC4 <small>Visual Key Control (Keys &amp; Cylinder face)</small>	- Cylinder face: Up to 4 characters
	- Cylinder side: Up to 6 characters

**6. CROSS KEYING**

KEY SYMBOL	TO BE OPERATED BY (OBY)
.....	.....
.....	.....
.....	.....
.....	.....
.....	.....
.....	.....
.....	.....
.....	.....
.....	.....
.....	.....

# Keying System Summary

SHEET	DATE:	PURCHASE ORDER #:	SALES ORDER #:
2 of 2			

**SOLD TO:**

.....

.....

.....

**7. PACKAGING & MARKINGS**

PACK CHANGE KEYS WITH LOCKS/CYLINDERS (STANDARD)

PACK CHANGE KEYS SEPARATELY

**LABEL ENVELOPES:**

KEY SYMBOL       DOOR NUMBER

JOB NAME       OTHER\*

\*MARKINGS FOR OTHER:

**SHIP CHANGE KEYS TO:**

.....

.....

ATTENTION: .....

**8. SHIPPING INSTRUCTIONS FOR MASTER KEYS**

**SHIP MASTER KEYS TO:**

.....

.....

ATTENTION: .....

**9. SHIPPING INSTRUCTIONS FOR CONSTRUCTION KEYS**

**SHIP CONSTRUCTION KEYS TO:**

.....

.....

ATTENTION: .....

**10. BITTING LIST**

**PROVIDE BITTING LIST FOR THIS ORDER:**

YES       NO

**LETTER OF AUTHORIZATION:**

ATTACHED

**MAIL BITTING LIST TO:**

.....

.....

ATTENTION: .....

**11. CONTACT**

NAME OF INDIVIDUAL IN YOUR ORGANIZATION WHO IS KNOWLEDGEABLE ABOUT THIS PROJECT, SHOULD ANY CLARIFICATION BY NECESSARY (Please Print):

NAME: .....

FAX #: .....

PHONE #: .....

THIS FORM HAS BEEN COMPLETED BY (Please Print):

NAME: .....

**ADDITIONAL INFORMATION (ATTACH)**

.....

.....

.....

.....

# STANLEY®

6161 East 75th Street  
Indianapolis, IN 46250 USA

Phone 855-365-2407

[stanleyhardwarefordoors.com](http://stanleyhardwarefordoors.com)

PL67CH • 04/18

© 2018 dormakaba Holding. All rights reserved.

© 2018 Stanley Black & Decker, Inc. STANLEY® and the STANLEY® Notched Rectangle logo are registered trademarks of Stanley Black & Decker Inc. or one of its affiliates, and are used under license

**dormakaba** 

[dormakaba.com](http://dormakaba.com)