

SIBERIA 840

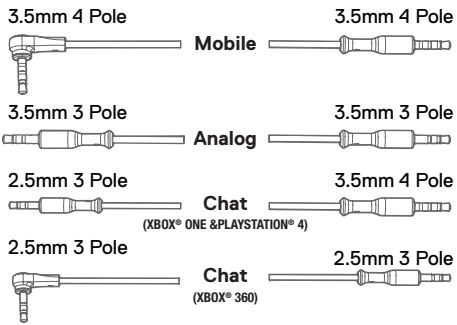

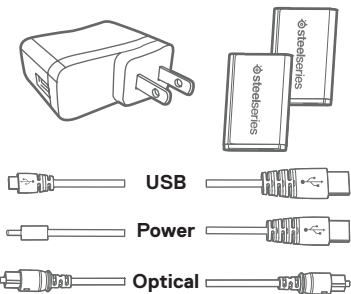

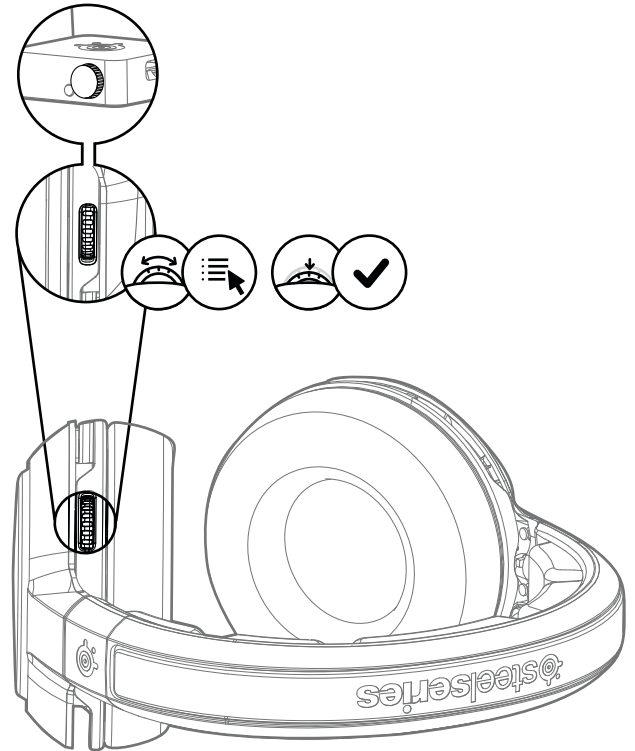
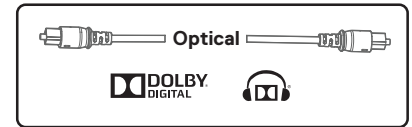
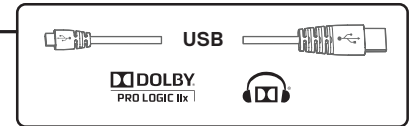
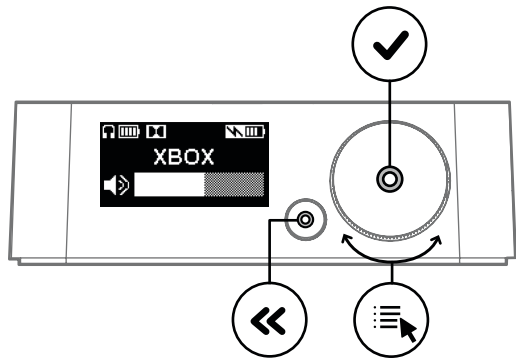

→ [STEELSERIES.COM/SIBERIA840](https://steelseries.com/siberia840)

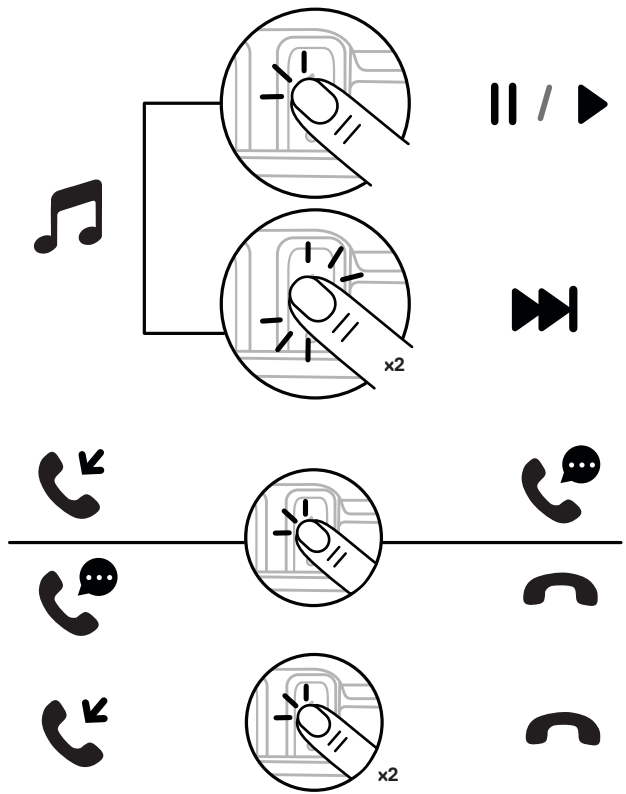
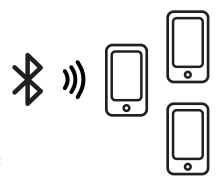
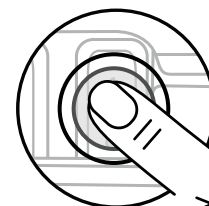
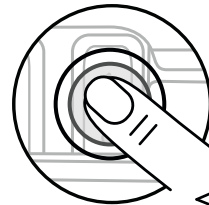
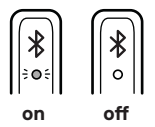
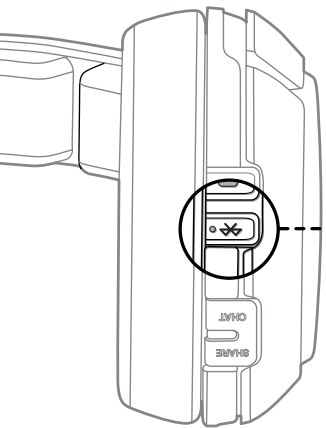

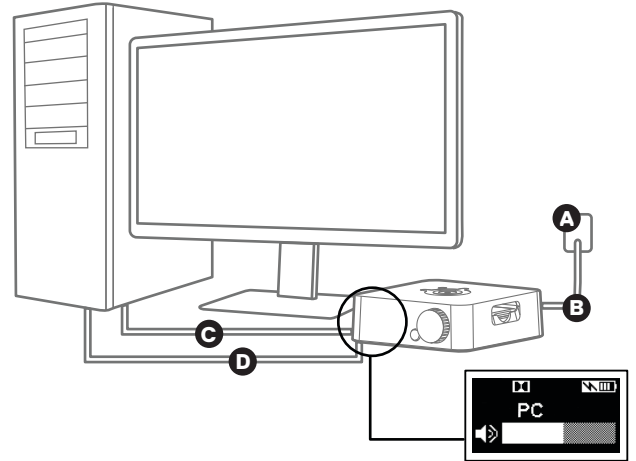
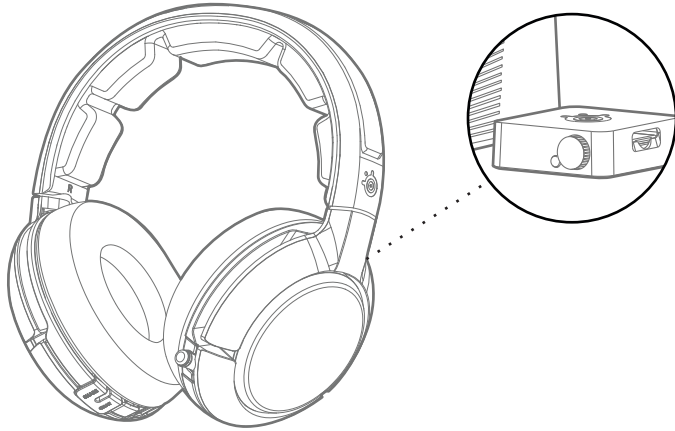
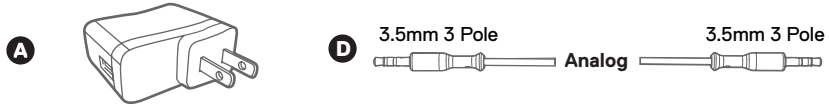

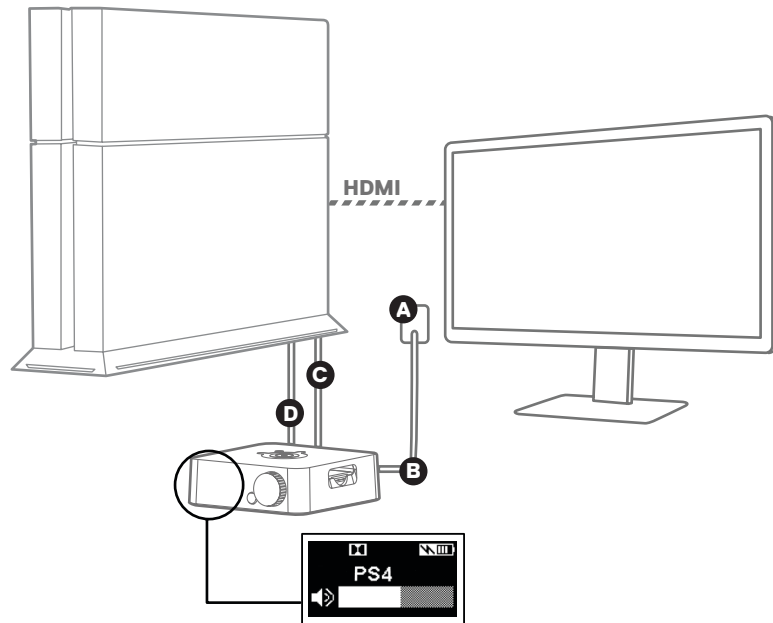
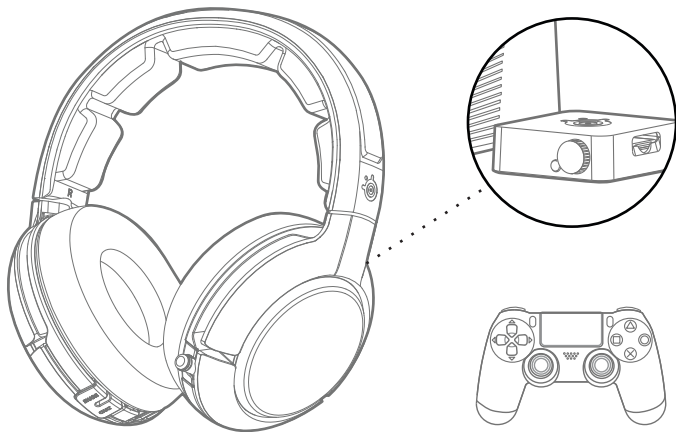
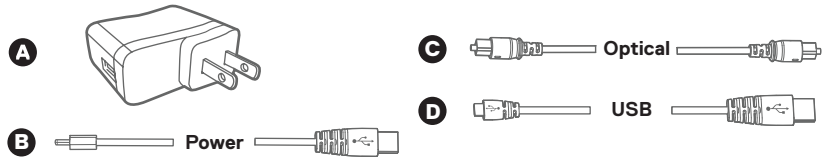

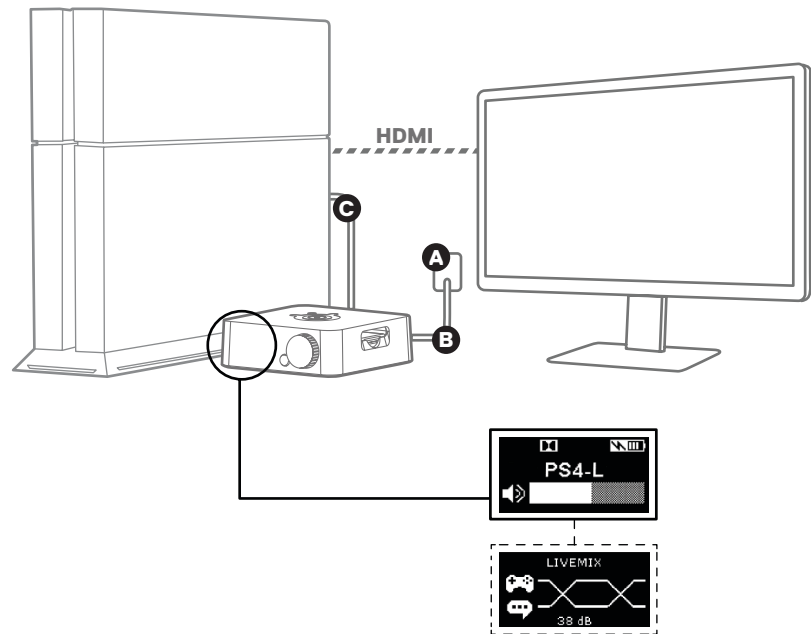
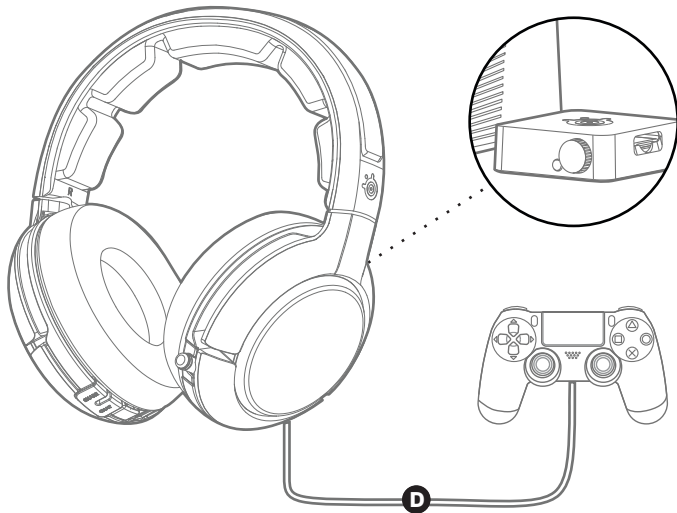
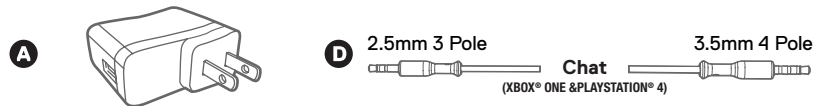

A

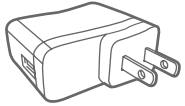

B



Power

C



Optical

D

3.5mm 3 Pole



Analog



3.5mm 3 Pole

E

2.5mm 3 Pole



Chat

(XBOX® 360)

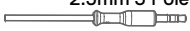

2.5mm 3 Pole

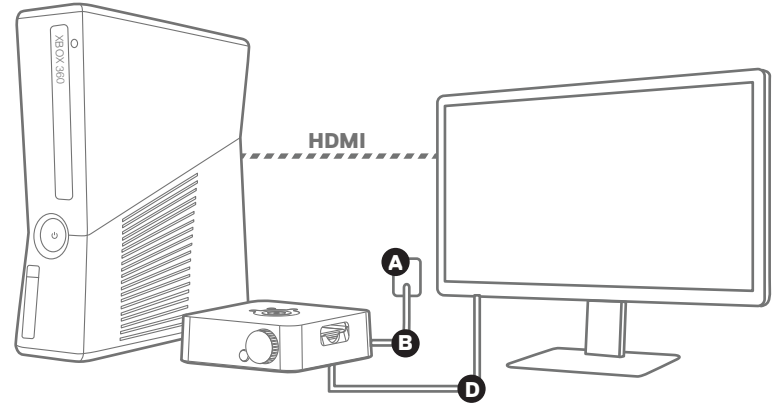
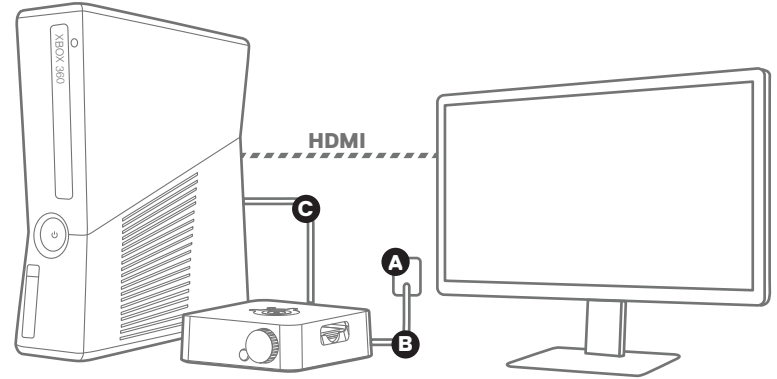
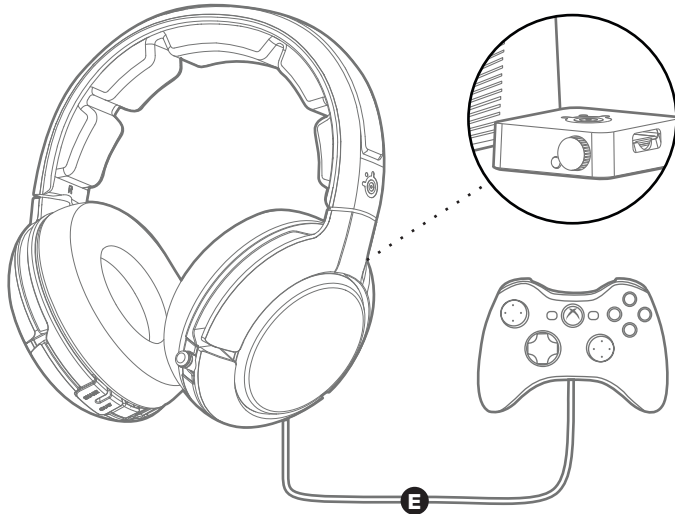

FCC Regulations:

• This device complies with Part 15 of the FCC Rules. Operation is subject to the following two conditions: (1) This device may not cause harmful interference, and (2) this device must accept any interference received, including interference that may cause undesired operation.

• This equipment has been tested and found to comply with the limits for a Class B digital device, pursuant to Part 15 of the FCC Rules. These limits are designed to provide reasonable protection against harmful interference in a residential installation. This equipment generates, uses and can radiate radio frequency energy and, if not installed and used in accordance with the instructions, may cause harmful interference to radio communications. However, there is no guarantee that interference will not occur in a particular installation. If this equipment does cause harmful interference to radio or television reception, which can be determined by turning the equipment off and on, the user is encouraged to try to correct the interference by one of the following measures:

- Reorient or relocate the receiving antenna.
- Increase the separation between the equipment and receiver.
- Connect the equipment into an outlet on a circuit different from that to which the receiver is connected.
- Consult the dealer or an experienced radio/TV technician for help.

• FCC Caution: Any changes or modifications not expressly approved by the party responsible for compliance could void the user's authority to operate this equipment.

• This transmitter must not be co-located or operating in conjunction with any other antenna or transmitter.

Radiation Exposure Statement:

The product comply with the FCC portable RF exposure limit set forth for an uncontrolled environment and are safe for intended operation as described in this manual. The further RF exposure reduction can be achieved if the product can be kept as far as possible from the user body or set the device to lower output power if such function is available.

Note: The country code selection is for non-US model only and is not available to all US model. Per FCC regulation, all WiFi product marketed in US must fixed to US operation channels only.

この装置は、情報処理装置等電波障害自主規制協議会(VCCI)の基準に基づくクラスB情報技術装置です。この装置、家庭環境で使用することを目的としていますが、この装置がラジオやテレビジョン受信機に近接して使用されると、受信障害を引き起こすことがあります。取扱説明書に従って正しい取り扱いをしてください。VCCI-B

この機器の使用周波数帯では、電子レンジ等の産業・科学・医療用機器のほか工場の製造ライン等で使用されている移動体識別用の構内無線局（免許を要する無線局）及び特定小電力無線局（免許を要しない無線局）並びにアマチュア無線局（免許を要する無線局）が運用されています。

1 この機器を使用する前に、近くで移動体識別用の構内無線局及び特定小電力無線局並びにアマチュア無線局が運用されていないことを確認して下さい。

2 万一、この機器から移動体識別用の構内無線局に対して有害な電波干渉の事例が発生した場合には、速やかに使用周波数を変更するか又は電波の発射を停止した上、下記連絡先にご連絡頂き、混信回避のための処置等（例えば、パーティションの設置など）についてご相談して下さい。

3 その他、この機器から移動体識別用の特定小電力無線局あるいはアマチュア無線局に対して有害な電波干渉の事例が発生した場合など何かお困りのことが起きたときは、次の連絡先へお問い合わせ下さい。

IC Regulations:

• This device complies with Industry Canada license-exempt RSS standard(s). Operation is subject to the following two conditions: (1) this device may not cause interference, and (2) this device must accept any interference, including interference that may cause undesired operation of the device.

Le présent appareil est conforme aux CNR d'Industrie Canada applicables aux appareils radio exempts de licence. L'exploitation est autorisée aux deux conditions suivantes: (1) l'appareil ne doit pas produire de brouillage, et (2) l'utilisateur de l'appareil doit accepter tout brouillage radioélectrique subi, même si le brouillage est susceptible d'en compromettre le fonctionnement."

• This Class B digital apparatus complies with Canadian ICES-003.

Cet appareil numérique de la classe B est conforme à la norme NMB-003 du Canada.

• This device and its antenna(s) must not be co-located or operating in conjunction with any other antenna or transmitter, except tested built-in radios. The Country Code Selection feature is disabled for products marketed in the US/ Canada.

Cet appareil et son antenne ne doivent pas être situés ou fonctionner en conjonction avec une autre antenne ou un autre émetteur, exception faites des radios intégrées qui ont été testées. La fonction de sélection de l'indicatif du pays est désactivée pour les produits commercialisés aux États-Unis et au Canada.

Radiation Exposure Statement:

The product comply with the Canada portable RF exposure limit set forth for an uncontrolled environment and are safe for intended operation as described in this manual. The further RF exposure reduction can be achieved if the product can be kept as far as possible from the user body or set the device to lower output power if such function is available.

Déclaration d'exposition aux radiations:

Le produit est conforme aux limites d'exposition pour les appareils portables RF pour les États-Unis et le Canada établies pour un environnement non contrôlé. Le produit est sûr pour un fonctionnement tel que décrit dans ce manuel. La réduction aux expositions RF peut être augmentée si l'appareil peut être conservé aussi loin que possible du corps de l'utilisateur ou que le dispositif est réglé sur la puissance de sortie la plus faible si une telle fonction est disponible.

CE Regulations:

• Products with CE marking complies with the R&TTE Directive (99/5/EC) and R.E.D (2014/53/EU), the EMC Directive (2004/108/EC; 2014/30/EU), and the Low Voltage Directive(2006/95/EC;2014/35/EU) issued by the Commission of the European Community.

• *For the device which tests accordance to EN60950-1:2006+A11:2009+A1:2010+A12:2011, it is mandatory to perform audio tests for EN50332.

• This device have been tested to comply with the Sound Pressure Level requirement laid down in the applicable EN 50332-1and/or EN 50332-2 standards.

• Prevention of hearing loss



CAUTION: Permanent hearing loss may occur if earphones or headphones are used at high volume for prolonged periods of time.

Excessive sound pressure from earphones and headphones can cause hearing loss.

NOTE: For France, Earphone (listed below) for this device have been tested to comply with the Sound Pressure Level requirement laid down in the applicable NF EN 50332-1:2000 and/or NF EN 50332-2:2003 standards as required by French Article L. 5232-1..



RISK OF EXPLOSION IF BATTERY IS REPLACED BY AN INCORRECT TYPE. DISPOSE OF USED BATTERIES ACCORDING TO THE INSTRUCTIONS.



This product, battery and accessories must not be disposed of with your other household waste. For more information about where you can drop off your waste equipment for recycling, please contact your local city office, your household waste disposal service or the shop where you purchased the product.

NCC Regulations:

- 經型式認證合格之低功率射頻電機，非經許可，公司、商號或使用者均不得擅自變更頻率、加大功率或變更原設計之特性及功能。
- 低功率射頻電機之使用不得影響飛航安全及干擾合法通信；經發現有干擾現象時，應立即停用，並改善至無干擾時方得繼續使用。前項合法通信，指依電信法規定作業之無線電通信。低功率射頻電機須忍受合法通信或工業、科學及醫療用電波輻射性電機設備之干擾。

PlayStation is a registered trademark of Sony Computer Entertainment Inc.

Mac is a trademark of Apple Inc., registered in the U.S. and other countries.

Xbox is a registered trademark of Microsoft Corporation in the United States and other countries.

Dolby, Dolby Headphone, Dolby Pro Logic, Dolby Digital and the double-D symbol are registered trademarks of Dolby Laboratories, Inc.



SteelSeries ApS
Dirch Passers Allé 27, 5. Sal
2000 Frederiksberg, Denmark



Product name (產品名稱): Headset (耳機)

Model No. (型號): HS-00009

Rated Voltage (額定直流電壓): 3.7V =

Rated Current (額定電流): 1000mA

Made in China 中國製造

公司: 丹麥商賽睿有限公司台灣分公司

地址: 新北市中和區建一路150號16樓

TEL: + 886-2-8226-3858

SteelSeries ApS.

656 W Randolph St., Suite 3E

Chicago, IL 60661, USA

TEL: +1-312-258-9467

Accessories information (配件資訊)

Product Name (產品名稱): Lithium Ion Battery (鋰電池)

Type(型號規格): 160240

Rated Voltage (額定直流電壓): 3.7V =

Rated Current (額定電流): 1000mAh

Product name(產品名稱): Transceiver (收發器)

Model No. (型號): HS-00007TX

Rated Voltage (額定直流電壓): 5V =

Rated Current (額定電流): 1.0A



[SUPPORT.STEELSERIES.COM](https://support.steelseries.com)



[FAQ.STEELSERIES.COM](https://faq.steelseries.com)



[SHOP.STEELSERIES.COM](https://shop.steelseries.com)