

\$30.⁰⁰



Operation and Installation Manual

Royal Series Water Temperature Control Units

Important! Read Carefully Before Attempting to Install or Operate Equipment

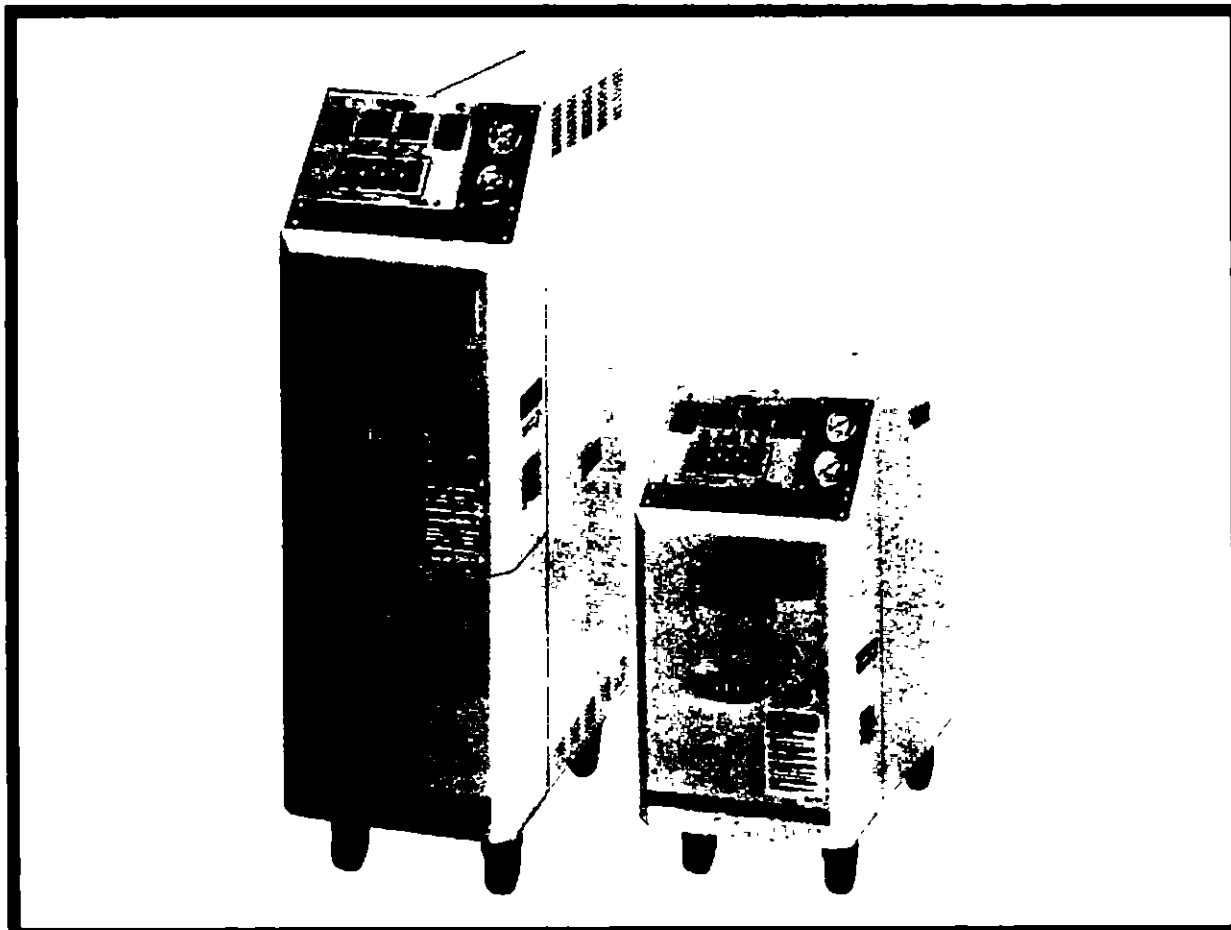

Part No. 682.88105.00

Revision D

Bulletin No. SC1-610.4

Write down your unit serial number(s)

here for future reference

_____	_____
_____	_____
_____	_____
_____	_____

Sterling/Sterco is committed
to a continuing program of product improvement.
Specifications, appearance, and dimensions described in this manual
are subject to change without notice.

© Copyright Sterling/Sterco and Sterling, Inc. 2002		
All rights reserved.		Effective 8/26/02
Part No. 682.88105.00	Revision D	Bulletin No. SC1-610.4

Safety Considerations

Sterling, Inc. Royal Series temperature control units are designed to provide safe and reliable operation when installed and operated within design specifications, following national and local safety codes.

To avoid possible personnel injury or equipment damage when installing, operating, or maintaining this equipment, use good judgment and follow these safe practices:

- ☑ Only **PROPERLY TRAINED** personnel familiar with the information within this manual should work on this equipment.
- ☑ Follow all local **SAFETY CODES**.
- ☑ Royal Series cabinets and piping are hot and are a **BURN HAZARD**.
- ☑ Do not operate a Royal Series system without all outer panels installed. Pressurized hot water leaks can cause serious injury.
- ☑ Wear **SAFETY GLASSES** and **WORK GLOVES**.
- ☑ Use care when **LOADING, UNLOADING, RIGGING, or MOVING** this equipment.
- ☑ Operate this equipment within design specifications.
- ☑ **OPEN, TAG, and LOCK ALL DISCONNECTS** before working on equipment. Sterling, Inc. recommends following OSHA Lock-Out/Tag-Out Standard 29 CFR 1910.147.
- ☑ Make sure the unit is properly **GROUNDED** before switching power on.
- ☑ When welding or brazing in or around this equipment, be sure **VENTILATION** is **ADEQUATE**. **PROTECT** adjacent materials from flame or sparks by shielding with sheet metal. An approved **FIRE EXTINGUISHER** should be close at hand and ready for use if needed.
- ☑ Do not jump or bypass any electrical safety control.
- ☑ Do not restore power until all tools, test equipment, etc. have been removed and the panels replaced.

Table of Contents

1	General Information	7
1-1	Introduction	7
1-2	Necessary Documents	8
1-3	Models Covered	8
1-4	Standard TCU Features	8
1-5	Available Options	9
2	Shipping Information	13
2-1	Unpacking and Inspection	13
2-2	In the Event of Shipping Damages	13
2-3	If the Shipment is Not Complete	14
2-4	If the Shipment is Not Correct	14
2-5	Returns	14
2-6	Uncrating Your New Royal Series System	15
3	Installation	17
3-1	Installation Location Considerations	17
3-2	Process Approach Temperature Considerations	17
3-3	External Piping Sizing Considerations	17
3-4	Piping Considerations for Permanent Installations	18
3-5	Piping Considerations for High Mobility Installations	19
3-6	Process Water Considerations	19
3-7	Making Process Water Connections	20
3-8	Making Cooling Water Connections	21
3-9	Making System Purge Connections	22
3-10	Making Electrical Connections	25
4	Identifying Controls and Features	30
4-1	Identifying Mechanical Controls and Features	30
4-2	The Microprocessor Controller	34
4-3	Identifying M2B Controller Panel Components	35

Table of Contents

4	Identifying Controls and Features	Cont'd.
4-4	Using M2B Controller Keys	38
4-5	Using Graphic Panel Buttons	40
4-6	Alarms	41
4-7	Controller Factory Setup	41
4-8	Auto-Tuning the M2B Controller	42
4-9	Operating the Unit with the Controller	43
4-10	Communications	43
5	Startup and Operation	44
5-1	Introduction	44
5-2	Startup Checklist	44
5-3	Starting the Temperature Control Unit	45
5-4	Operating the Unit with the M2B Controller	46
5-5	Sequence of Operation	47
5-6	Checking Motor Rotation Direction	48
5-7	Shutting Down the Temperature Control Unit	48
6	Unit Maintenance	50
6-1	Preventive Maintenance	50
6-2	Corrective Maintenance	51
6-3	Restoring the Controller to Factory Setup	53
6-4	Electrical Connections	53
6-5	Safety Devices	54
6-6	Cleaning and Storage	56
7	Troubleshooting	64
I	Index	68

Charts and Figures

1	Typical Royal Series Water Temperature Control Unit and Specifications	11
2	Typical Royal Upright Series Water Temperature Control Unit and Specifications	12
3	Typical Piping Schematic	23
4	Pump Curves; 60 Hz and 50 Hz	24
5	Pressure Drops	24
6	Typical Electrical Wiring Schematic, Drawings 1 and 2	27-28
7	Typical Electrical Subpanel Layout	29
8	Typical M2B Graphic and Button Control Panels	35
9	Pressure Switch; Side View and Top View	55
10	Customer-Recommended Spare Parts Lists	56-62

1-1 Introduction

Sterling/Sterlco Royal Series water temperature control units are reliable, accurate, and easy-to-use process temperature control units. They are self-contained, portable, and shipped ready to use.

The Royal Series water temperature control unit is designed to circulate water through your process and to precisely, automatically, and reliably maintain it at a specified temperature. Standard unit operating range is from 0°F (-17°C) to 250°F (121°C), or up to 300°F (149°C) as an option. The unit is suited for use with city water, water from portable or central chillers or towers, or well water.

These units are designed for rapid recirculation of a relatively small amount of water to provide close and uniform temperature relation between To Process and From Process lines. This performance, of course, depends on the configuration of your process and any restrictions within the mold. The recirculation, combined with the large immersion heater and cooling capability, gives fast and accurate response to bring the water up to temperature or to changes in the settings when needed.

The 2010 Series water temperature control unit is a self-contained system consisting of a centrifugal pump, electric immersion heater, cool/vent solenoid valve, and electrical control, including a PID microprocessor controller and thermocouple. It is designed for use in process temperature control applications using water or a water/glycol mix. Any other use or fluid is **prohibited**.

Some standard safety devices include a mechanical overtemperature safety thermostat, a pressure relief valve, motor overload protection, a low pressure cutout switch, branch fusing, and non-fused lockable rotary disconnect.

A properly installed, operated, and maintained Royal Series system provides years of reliable operation. Please read and follow the instructions in this manual to get the most satisfaction from your Royal Series system.

1-2 Necessary Documents

The following documents are necessary for the operation, installation, and maintenance of Sterling/Sterlco Royal Series water temperature control units. Additional copies are available from Sterling, Inc.

Familiarize the appropriate personnel with these documents:

- This manual.
- The controller operation manual.
- The electrical schematic and connection diagram placed inside the control enclosure.
- The operation and installation manuals for accessories and options selected by the customer.
- The Customer Parts List included in the information packet.

1-3 Models Covered

This manual provides operation, installation, and maintenance instructions for the Royal Series water temperature control unit.

Model numbers are listed on the serial tag. A model number followed by **Q** indicates a specially constructed unit, and not all information in this manual may apply. Make sure that you know the model number, serial number, and operating voltage of your temperature control unit if you contact Sterling, Inc.

1-4 Standard Royal Series Features

- Compact, rugged cabinet with easy-access side panels
- Cast-and-flange design to reduce connection points
- Half- and full-heat automatic switching capability
- Dual stage Incoloy™ immersion heater with IEC contactors
- NEMA 12 electrical enclosure
- M2B microprocessor controller with fuzzy logic; includes diagnostics features with indicator and warning status lights; CE and cUL

- Forward-facing liquid-filled To and From Process pressure gauges
- Independent high temperature safety thermostat
- Non-fused lockable rotary disconnect
- Branch fusing
- ¼" cooling solenoid valve on ¼ to 3 hp (0.56 to 2.24 kW) models; ½" slow-close cooling solenoid valve on 5, 7½, & 10 hp (3.73, 5.60, & 7.46 kW) models
- EPDM/NI-Resist pump seal
- Adjustable low supply water pressure switch; factory-set at 16 psig (110 kPa/1.1 bars)
- 150 psig (1,034 kPa/10.3 bars) pressure relief valve
- Choice of 230 or 460 operating voltages
- ¾" water supply and drain connections; 1½" process connections
- Automatic vent sequence
- 3" (76 mm) casters
- Operating range of 0°F to 250°F (-17°C to 121°C)
- Three (3) -year parts and labor warranty at the factory; five (5) -year controller warranty, and limited lifetime warranty on wetted pump components and pump seal; subject to factory review

1-5 Available Options

Royal Series systems are available with options to tailor the unit to your requirements. Some are factory installed; some can be retro-fitted in the field. Consult your Sterling, Inc. sales representative for more information. Available Royal Series options include:

- M2B controller with integral flow meter; with:
 - Up to 30 gpm (114 lpm) flow indicator
 - or -
 - 30 to 75 gpm (114 to 284 lpm) flow indicator
 - 0-20 mA and 4-20 mA current control output

- Remote set point and retransmission; 0-20 mA and 4-20 mA
 - RS-232 or RS-485 communications
 - Remote sensor; 10 ft. (3 m)
- Remote controller enclosure
- Heaters available in 12 kW, 18 kW, 24 kW, 36 kW, and 48 kW on direct-injection compact models; 36 kW and 48 kW heaters available on direct-injection upright models
- Closed-loop heat exchanger available in 3.7 sq. ft. (0.344 sq. m) on compact models; 3.7, 7.4, 11.2, 18.1, and 27.0 sq. ft. (0.135, 0.688, 1.042, 1.683, and 2.511 sq. m) on upright models
- Quick Cool function
- Auto system water purge (mold purge)
- Y-strainer
- Hammer arrestor (water hammer shock stop)
- Remote start/stop control
- Rubber feet; available in lieu of casters
- Non-ferrous brass construction
- Slow-close cooling solenoid valves available in 1/2" x 3/8" ($C_v = 3.5$) and 1/4" x 1/4" ($C_v = 5.5$)
- Modulating valves available in 1/2" ($C_v = 0.4, 1.3, 2.2,$ or 4.4), 3/4" ($C_v = 5.5$ or 7.5), 1" ($C_v = 10$ or 14), and 1 1/4" ($C_v = 20$)
- Two-zone stack rack with casters, common wiring and piping available; compact units only
- 300°F (149°C) operation; includes graphite-impregnated silicon carbide seal
- Audible and visual general fault alarm
- Electrical operation available in 208, 230, 460, and 575 volts, 60 Hz; 200, 380, and 415 volts, 50 Hz
- UL/cUL-listed electrical subpanel

Figure 1
Typical Royal Series Water Temperature Control Unit and Specifications

Direct Injection

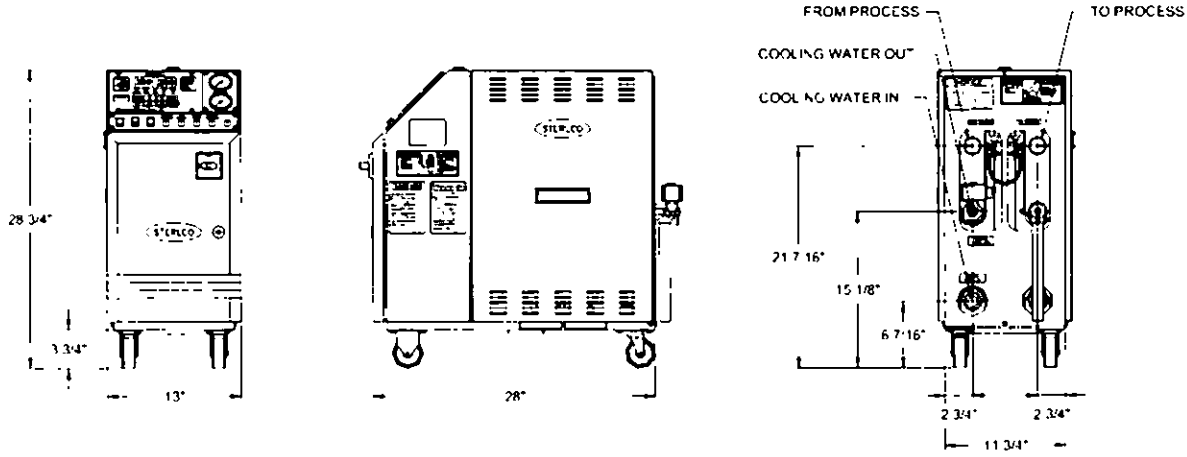

Closed Circuit

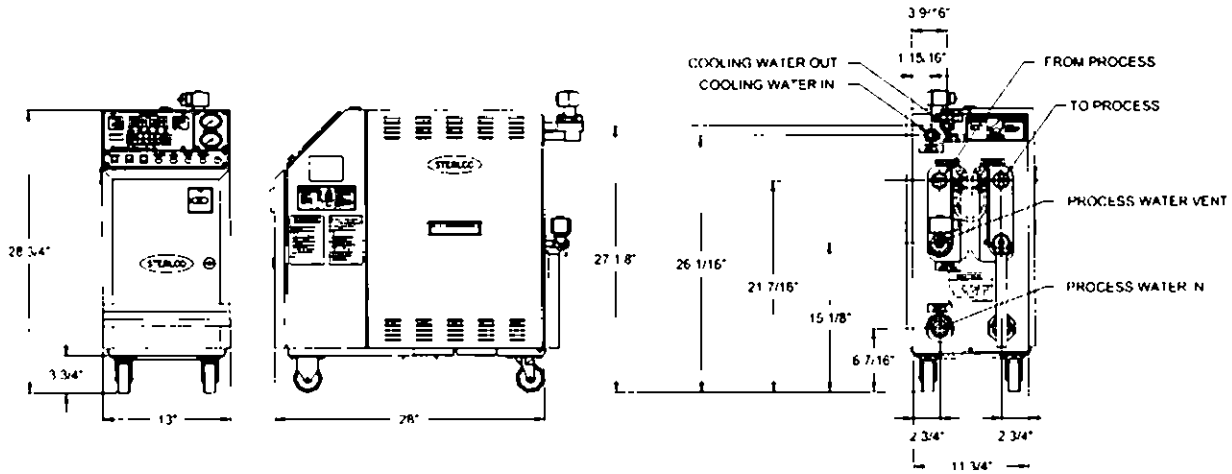

Model number	Pump						Dimensions						Shipping weight	
	hp	kW	gpm	lpm	psig	kPa	H in.	H cm	W in.	W cm	D in.	D cm	lbs.	Kg
460 / 230	3/4	0.56	30	113.6	25	172.4								
2010, 9 kW heater	1	0.75	35	132.5	30	206.9	28 3/4"	73.0	13"	33	28"	71.1	210	96
	2	1.50	50	189.3	30	206.9								
	3	2.24	60	227.1	35	241.3								
	5	3.73	75	283.9	54	372.3								
	7 1/2	5.60	90	454.2	63	434.4							240	109

Figure 2
 Typical Royal Upright Series Water Temperature Control Unit and Specifications

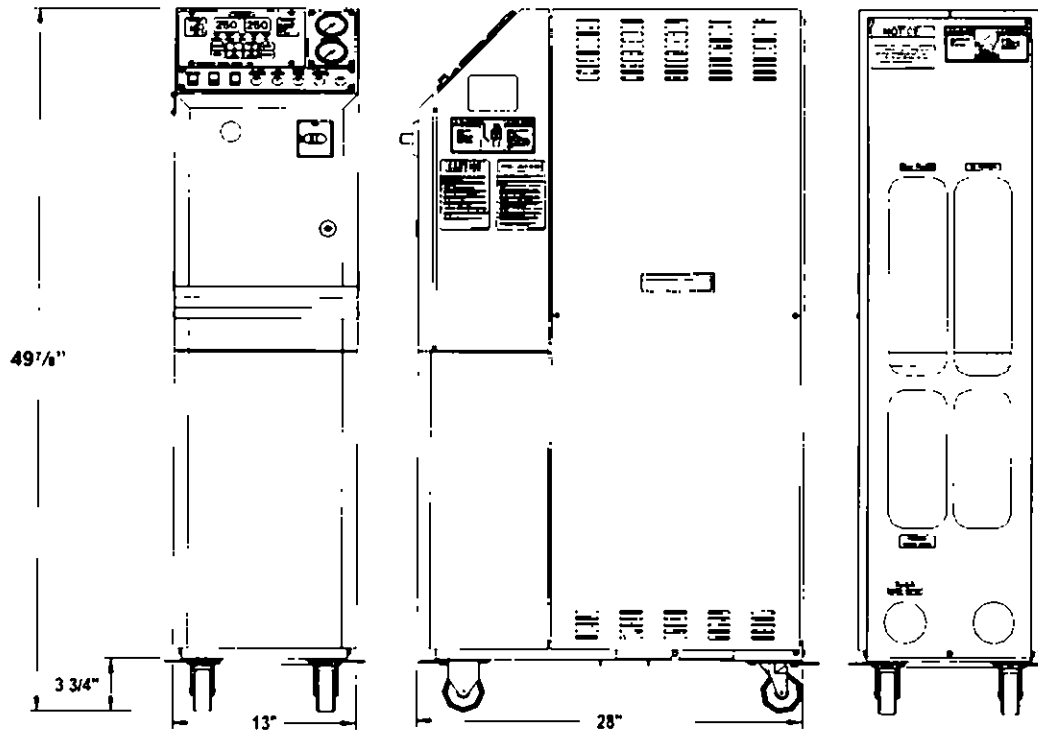

Model number 460 230	Pump								Dimensions						Shipping weight	
	letter	hp	kW	gpm	lpm	psig	kPa	H in.	H cm	W in.	W cm	D in.	D cm	lbs.	Kg	
2012, 9 kW heater	C	1/4	0.56	30	113.6	25	172.4	48	122	13	33	28	71.1	210	96	
	D	1	0.75	35	132.5	30	206.9									
	F	2	1.50	50	189.3	30	206.9									
	G	3	2.24	60	227.1	35	241.3							240	109	
	H	5	3.73	75	283.9	54	372.3									
	J	7 1/2	5.60	90	340.7	63	434.4									
K	10	7.46	120	454.2	55	379.2	270	123								

Figure 3
 Royal Series Unit Full-Load Amps

Model		Full-load amps at 460 volts					
hp	kW	9 kW heater	12 kW heater	18 kW heater	24 kW heater	36 kW heater	48 kW heater
0.75 hp	0.56 kW	12.7 amps	16.5 amps	24.0 amps	31.6 amps	47.4 amps	62.4 amps
1.00 hp	0.75 kW	13.1 amps	16.9 amps	24.4 amps	32.0 amps	47.8 amps	62.8 amps
2.00 hp	1.50 kW	14.7 amps	18.5 amps	26.0 amps	33.6 amps	49.4 amps	64.4 amps
3.00 hp	2.24 kW	16.1 amps	19.9 amps	27.4 amps	35.0 amps	50.8 amps	65.8 amps
5.00 hp	3.73 kW	18.9 amps	22.7 amps	30.2 amps	37.8 amps	56.6 amps	71.6 amps
7.50 hp	5.60 kW	22.3 amps	26.1 amps	33.6 amps	41.2 amps	57.0 amps	72.0 amps
10.00 hp	7.46 kW	26.0 amps	30.0 amps	37.0 amps	45.0 amps	60.0 amps	75.0 amps

2-1 Unpacking and Inspection

You should inspect your Sterling/Sterlco Royal Series temperature control unit for possible shipping damage. If the container and packing materials are in re-usable condition, save them for reshipment if necessary.

Thoroughly check the equipment for any damage that might have occurred in transit, such as broken or loose wiring and components, loose hardware and mounting screws, etc. In case of breakage, damage, shortage, or incorrect shipment, refer to the following sections.

2-2 In the Event of Shipping Damages

Important!

According to the contract terms and conditions of the Carrier, the responsibility of the Shipper ends at the time and place of shipment.

- Notify the transportation company's local agent if you discover damage.
- Hold the damaged goods and packing material for the examining agent's inspection. **Do not return any goods to Sterling, Inc. before the transportation company inspection and authorization.**
- File a claim against the transportation company. Substantiate the claim by referring to the agent's report. A certified copy of our invoice is available upon request. The original Bill of Lading is attached to our original invoice. If the shipment was prepaid, contact Sterling at (414) 354-0970 for a receipted transportation bill.
- Advise Sterling, Inc. regarding your request for assistance and to obtain an RGA (return goods authorization) number.**

2-3 If the Shipment is Not Complete

Check the packing list. The apparent shortage may be intentional. Back-ordered items are noted on the packing list. You should have:

- Sterling/Sterlco Royal Series water temperature control unit
- Bill of lading
- Packing list
- Operating and Installation packet
- Electrical schematic and panel layout drawings
- Component instruction manuals

Re-inspect the container and packing material to see if you missed any smaller items during unpacking. Determine that the item was not inadvertently taken from the area before you checked in the shipment. Notify Sterling, Inc. immediately of the shortage.

2-4 If the Shipment is Not Correct

If the shipment is not what you ordered, **contact Sterling, Inc. immediately**. Include the order number and item. *Hold the items until you receive shipping instructions.*

2-5 Returns

Important!

Do not return any damaged or incorrect items until you receive shipping instructions from Sterling, Inc.

2-6 Uncrating Your New Royal Series System

- ☑ Royal Series water temperature control units are shipped fastened to a skid and covered with a cardboard box.
- ☑ Carefully remove the staples on the bottom of the box, lift off the box, and remove the bolts holding the unit to the skid.

Caution!

Be careful when cutting straps.

Straps may spring back and cause injury!

- ☑ From the side, slip two lifting straps between the skid and temperature control unit. Spread the straps from the center line so it is balanced.
- ☑ Loop the straps over a fork truck fork. Lift slowly and only high enough to clear the skid. Use a pry bar if necessary to remove the skid from the unit.
- ☑ Carefully slide the skid from beneath the unit and lower the unit. Lower slowly. The unit should land on its casters and can be rolled into position.
- ☑ Retain the crating in case reshipment is necessary due to hidden shipping damage.

- Notes -

3-1 Installation Location Considerations

Royal Series systems are portable and can be installed almost anywhere. As with all equipment installations, follow all applicable codes and regulations.

- ☑ The recommended ambient temperature range for Royal Series installations is from +14°F (-10°C) to a maximum operating ambient temperature of 131°F (55°C). Recommended ambient storage temperature range is from -13°F to 149°F (-25°C to 65°C). If storing the unit below freezing temperatures, make sure the unit has an antifreeze mixture circulated inside.
- ☑ Provide a minimum of twelve inches (12" or about 30 cm) clearance on all sides of the cabinet to allow circulation of cooling air.
- ☑ Locate the unit as close to the process as is practical.

3-2 Process Approach Temperature Considerations

If the differential (Δ) between **COOLING WATER IN** and **TO PROCESS** temperatures is less than 10°F (7°C), consult our Sales Department for advice on how to control low approach applications.

3-3 External Piping Sizing Considerations

- ☑ All external hose and piping should be adequately sized to assure minimum external pressure drop.
- ☑ Low external piping pressure drop is needed for best operation.

Note: Use a backup wrench to support Royal Series system piping when making process piping connections.

⚠ CAUTION

All external valves, fittings, and hoses must be rated at a minimum of 150 psig and 250°F (1,034.25 kPa/10.34 bars and 121°C).

The exception is when the temperature control unit is optionally rated for 300°F (149°C) operation; external valves fittings and hoses must then be rated at a minimum of 150 psig and 300°F (1,034.25 kPa/10.34 bars and 121°C).

3-4 Piping Considerations for Permanent Installations

Sterling, Inc. recommends an optional (or customer-installed) strainer on the **COOLING WATER IN** inlet.

The unit must have at least 16 psig (110.32 kPa/1.1 bars) water supply pressure to prevent pump cavitation that can be caused by the water “flashing” to steam. To avoid damage to the pump or other components, make sure that maximum supply pressure does not exceed 55 psig (379.2 kPa/3.79 bars).

Keep restrictions to a minimum by using proper inlet pipe sizing. If the water supply piping is larger than ¼”, reduce the size at the unit. The table below contains the pipe sizes that are used in the unit.

Pipe sizes for ¾ hp to 10 hp (0.56 kW to 7.46 kW) units	
Location	Size in inches NPT
To Process	1½”
From Process	1½”
Cooling Water In	¾”
Cooling Water Out	- depends on solenoid used -

Common black pipe is recommended for permanent installations. Royal Series water circuit piping is primarily ferrous (iron) and reacts electro-chemically with non-ferrous metallic materials such as copper. Some water contains dissolved minerals that greatly accelerates the reaction between dissimilar metals.

Ferrous piping is recommended to minimize galvanic action. If piping must be copper, use dielectric unions at the unit.

3-5 Piping Considerations for High Mobility Installations

Mobile Royal Series systems must use high quality hose rated for **at least** 150 psig and 250°F (1,034.25 kPa/10.34 bars and 121°C). Special 300°F (149°C) high temperature Royal Series systems must use hosing rated at 150 psig and 300°F (1,034.25 kPa/10.34 bars and 149°C) or greater.

Quick disconnects may be used for mobility, although **they cause a drop in pressure**. If used, they must be sized carefully to minimize pressure drop. Don't use quick disconnects with check valves *unless absolutely necessary*.

CAUTION

Non-relieving quick connect fittings or check valves on the water supply must have a pressure relief piped to the drain.

Failure to do so could result in a dangerous over-pressure condition!

3-6 Process Water Considerations

Raw Water

Water treatment is vital in any piping system. In some cases, raw water may be used in the system without problems; in other cases, it can result in large deposits of scale and corrosion.

Sterling, Inc. offers a complete line of water treatment equipment. Contact your Sterling, Inc. sales representative for water testing and treatment options.

Distilled Water

Non-ferrous (brass, copper, or high-temperature plastic) piping is recommended for distilled water processes.

Deionized Water

Stainless steel (316 SS minimum) or PVC plastic components must be used with deionized water. Sterling, Inc. recommends stainless steel because of the temperature constraints with plastic.

3-7 Making Process Water Connections

Closed Circuit/Direct Injection

On the back of each unit, the connections are labeled appropriately. For Direct Injection units connect the **TO PROCESS** hookup to the entrance of the process and the **FROM PROCESS** hookup to the exit of the process. Connect the **COOLING WATER IN** to your plant water supply. Connect the **COOLING WATER OUT** line to an open drain, or to the return line of your central water system.

For Closed Circuit units make the connections as stated above, and if there is a separate supply for the process and cooling make the following connections. Connect the **PROCESS WATER SUPPLY** hookup to the water source for the process. Connect the **PROCESS WATER VENT** hookup to return the water back to the process source.

Make sure you carefully select the connecting lines and connectors between the temperature control unit and the process to suit the needs and requirements of your application.

If your unit has a maximum operating temperature of 250°F (121°C), the connecting lines and connectors should have a service rating of at least 250°F (121°C) and 150 psig (1,034.25 kPa/10.34 bars). If it has a maximum temperature of 300°F (149°C), the lines and connectors should have a service rating of at least 300°F (149°C) and 150 psig (1,034.25 kPa/10.34 bars).

TO PROCESS — 1½" NPT

This is the outlet for the tempered water leading to the process being controlled.

FROM PROCESS — 1½" NPT

Water from the process re-enters the Royal Series system to be tempered and re-circulated back into the process.

3-8 Making Cooling Water Connections

WATER IN — ¾"

The cooling water supply inlet from a cooling tower, a chiller, or a city water supply.

CAUTION

If a non-relieving device such as a regulator, ball valve, or check valve is installed on the WATER IN line, you **MUST** install an expansion tank of at least ½ gallon (about 2 liters) capacity.

Failure to do so can result in system overpressure from thermal expansion. Install the tank configured as shown below:

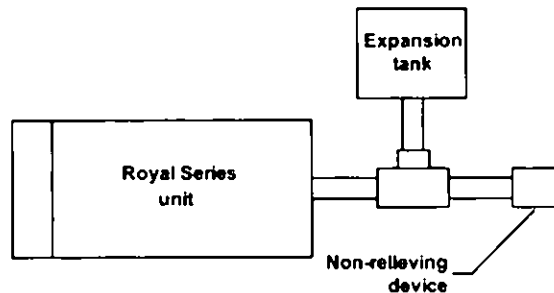

Check the expansion tank frequently to make sure it is not flooded.

Water Out

Size Depends on Solenoid Used

The cooling water outlet leading back to the cooling tower, chiller, or drain.

Net supply pressure must be between 25 psig and 55 psig (172.38 kPa/1.72 bars and 379.2 kPa/3.79 bars). Net supply below 15 psig (103.43 kPa/1.03 bars) may allow water to flash to steam, cavitate the impeller, and **damage the pump**, which prevents the unit from cooling properly. Operation above 55 psig (379.2 kPa/3.79 bars) may cause premature opening of the relief valve from pump pressure and pressure surges.

PRESSURE RELIEF — 3/4"

The pressure relief valve, located at the back of the unit, is pre-piped to approximately four inches (4" or 10 cm) above the floor. This piping reduces the chance of scalding nearby personnel if the relief valve should trip.

3-9 Making System Purge Connections

Royal Series systems equipped with the System Purge option have a compressed air inlet marked **MOLD PURGE**. Connect to a clean, dry 100 psig (689.50 kPa/6.90 bars) air line. Install your own shutoff valve to prevent process liquid from backing up into the plant air piping if the compressed air is turned off and the check valve fails. **Don't depend on the solenoid valve to hold water pressure in the temperature control unit.**

Figure 3
Typical Piping Schematic

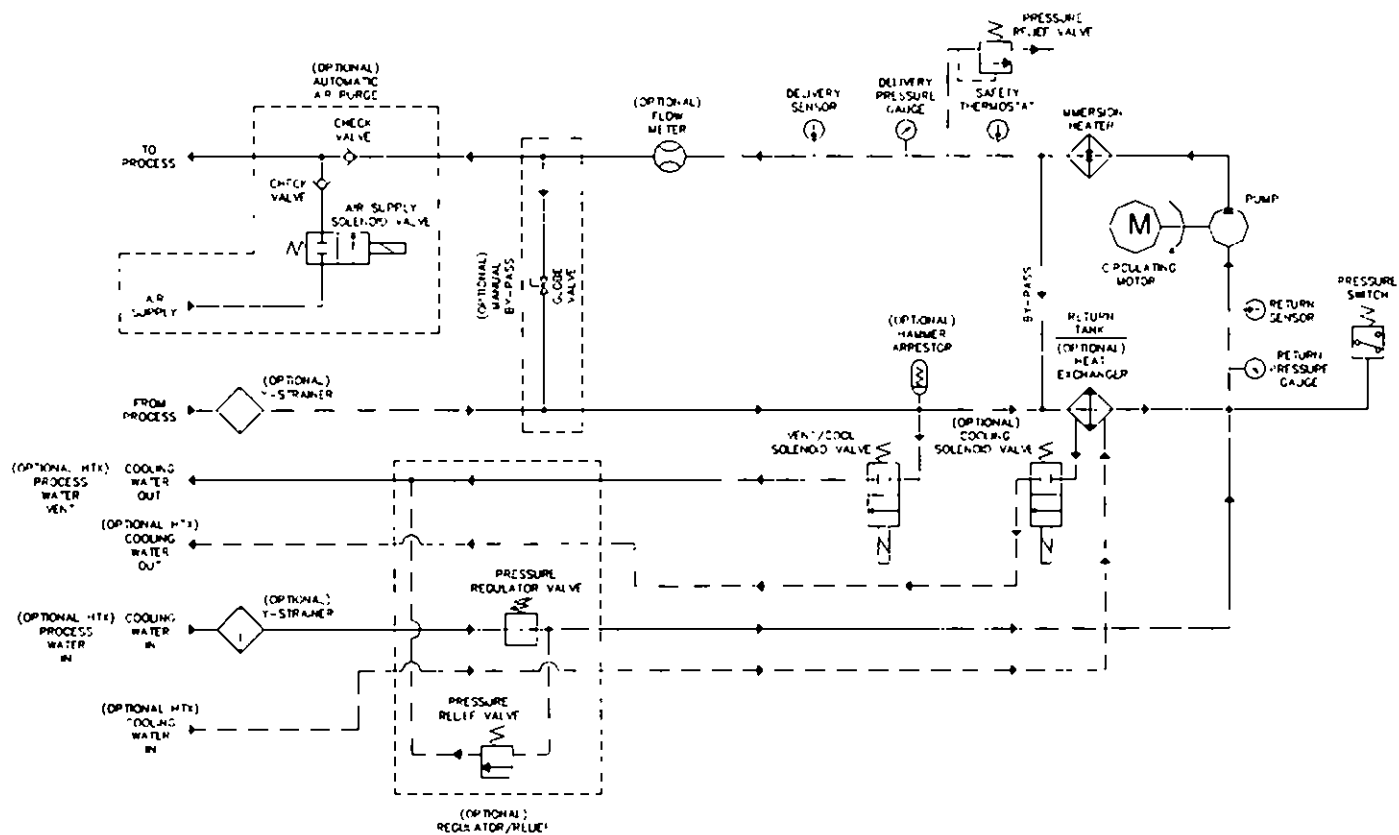
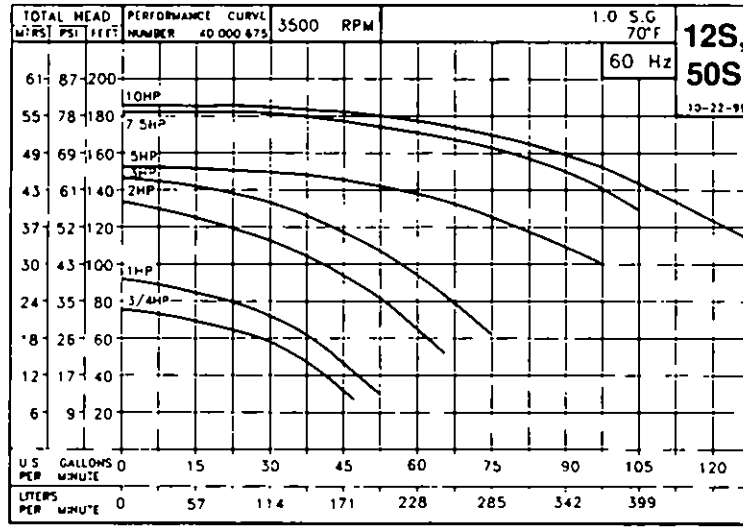

Figure 4
Pump Curves; 60 Hz



Pump Curves; 50 Hz • Consult Factory for 10 hp Curves

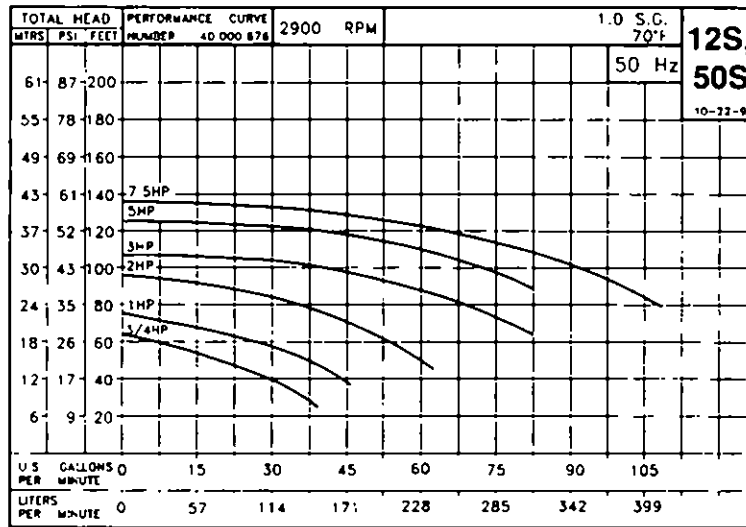

Figure 5
Pressure Drops

Model		Pressure drop flow and loss				
hp	kW	9 kW htr	flow gpm	flow lpm	loss psi	loss kPa
0.75 hp	0.56 kW	12.7 amps	30.0 gpm	113.6 lpm	0.0 psi	0.0 kPa
1.00 hp	0.75 kW	13.1 amps	35.0 gpm	132.5 lpm	1.0 psi	6.9 kPa
2.00 hp	1.50 kW	14.7 amps	50.0 gpm	189.3 lpm	1.5 psi	10.3 kPa
3.00 hp	2.24 kW	16.1 amps	60.0 gpm	227.1 lpm	2.0 psi	13.8 kPa
5.00 hp	3.73 kW	18.9 amps	75.0 gpm	283.9 lpm	2.5 psi	17.2 kPa
7.50 hp	5.60 kW	22.3 amps	90.0 gpm	340.7 lpm	5.0 psi	34.4 kPa
10.00 hp	7.46 kW	26.0 amps	120.0 gpm	454.2 lpm	5.0 psi	34.4 kPa

3-10 Making Electrical Connections

Royal Series systems are designed for three-phase voltage operation. Refer to the unit nameplate for proper voltage and amperage requirements.

Make sure you provide a correctly sized and protected supply of electrical power to the unit.

Important!

Refer to National Electric Code (NEC) Article 430-24 through 430-26 for proper feeder conductor and supply disconnect sizing.

Maintain a safe ground and disconnect the power supply before servicing the unit. A qualified electrician should make electrical connections, and disconnect and lock out electricity using OSHA 29CFR 1910.147 standards when you need a service call.

Check serial tag voltage and amperage requirements and make sure your electrical service conforms *before* making any electrical connections. Total running amps for Royal Series systems are listed on the nameplate. Customer connections can be run to the supply terminals from either side of the unit. Make sure that all three phases are wired correctly. If not wired properly, the unit will run *backwards*. **Again, check the unit nameplate for correct voltage and amperage.**

 **DANGER**



Improper electrical connections can damage the unit and cause serious operator injury or death!

Bring properly sized power leads and ground from a fused disconnect (installed by your electrician) to the unit. Provide external overcurrent protection to the unit, using circuit breakers or fuses. If you use fuses, make sure that they are dual-element time-delay fuses, sized according to your electrical code. Make sure that all electrical connections are *tight*.

Important!

- 1. Electrical connections must comply with all applicable electrical codes.**
- 2. The temperature control unit must be grounded in accordance with NEC Article 250.**
- 3. Voltage must be within plus or minus ten percent ($\pm 10\%$) of the nameplate rating.**
- 4. Make sure your installer provides external protection.**

Figure 6 Typical Electrical Wiring Schematic, Drawing 1

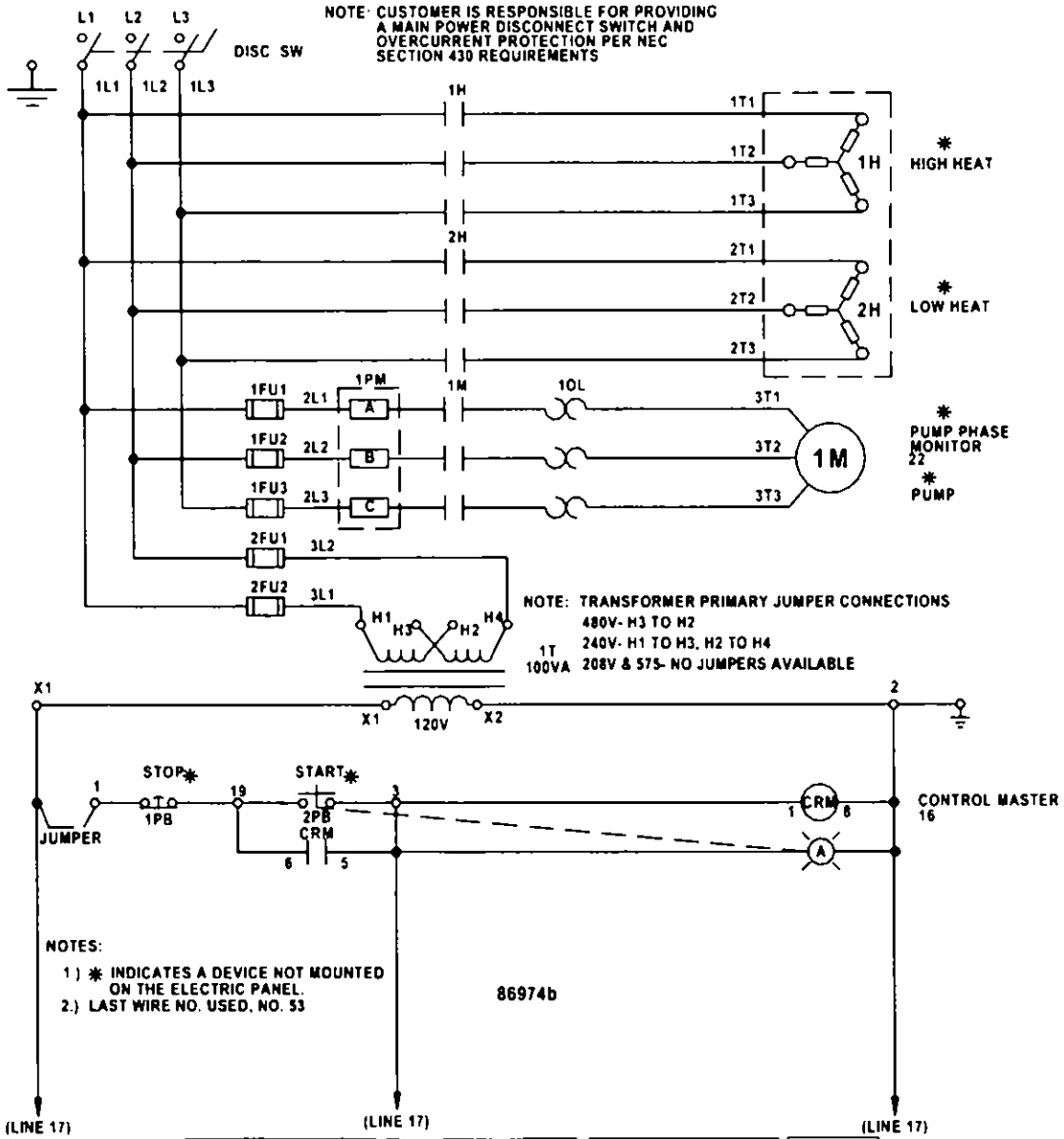

- NOTES:**
- 1) * INDICATES A DEVICE NOT MOUNTED ON THE ELECTRIC PANEL.
 - 2.) LAST WIRE NO. USED, NO. 53

PUMP MOTOR AMPS @ VOLTAGE 240V/3PH						MOTOR FUSE SIZE 3 PH						CLASS 'CC' FUSE						SECONDARY FUSE	
HP	200	240	288	415	480	HP	200	240	288	415	480	TRANS PRIMARY FUSE SIZE	100	150	200	250	300	1.5 AMP	2.0 AMP
1/2	1.7	1.8	2.0	2.2	2.4	1/2	1	1	1	1	1.5	1/2	1.0	1.0	1.0	1.0	1.0	1.5 AMP	1.5 AMP
3/4	2.5	2.6	2.8	3.0	3.2	3/4	1.5	1.5	1.5	1.5	2.0	3/4	1.5	1.5	1.5	1.5	1.5	1.5 AMP	1.5 AMP
1	3.2	3.3	3.5	3.7	3.9	1	2	2	2	2	2.5	1	2.0	2.0	2.0	2.0	2.0	1.5 AMP	1.5 AMP
1 1/2	4.1	4.2	4.4	4.6	4.8	1 1/2	3	3	3	3	3.5	1 1/2	3.0	3.0	3.0	3.0	3.0	1.5 AMP	1.5 AMP
2	5.0	5.1	5.3	5.5	5.7	2	4	4	4	4	4.5	2	4.0	4.0	4.0	4.0	4.0	1.5 AMP	1.5 AMP
3	6.0	6.1	6.3	6.5	6.7	3	6	6	6	6	7	3	6.0	6.0	6.0	6.0	6.0	1.5 AMP	1.5 AMP
4	7.0	7.1	7.3	7.5	7.7	4	8	8	8	8	9	4	8.0	8.0	8.0	8.0	8.0	1.5 AMP	1.5 AMP
5	8.0	8.1	8.3	8.5	8.7	5	10	10	10	10	11	5	10.0	10.0	10.0	10.0	10.0	1.5 AMP	1.5 AMP
7 1/2	11.0	11.1	11.3	11.5	11.7	7 1/2	15	15	15	15	16	7 1/2	15.0	15.0	15.0	15.0	15.0	1.5 AMP	1.5 AMP

COMPONENT WATT RATINGS					
HEAT EXCHANGERS	CONTACTORS	RELAYS	SOLENOIDS	LAMPS	OTHER
HEAT EXCHANGERS	CONTACTORS	RELAYS	SOLENOIDS	LAMPS	OTHER
HEAT EXCHANGERS	CONTACTORS	RELAYS	SOLENOIDS	LAMPS	OTHER

Figure 6
Typical Electrical Wiring Schematic, Drawing 2

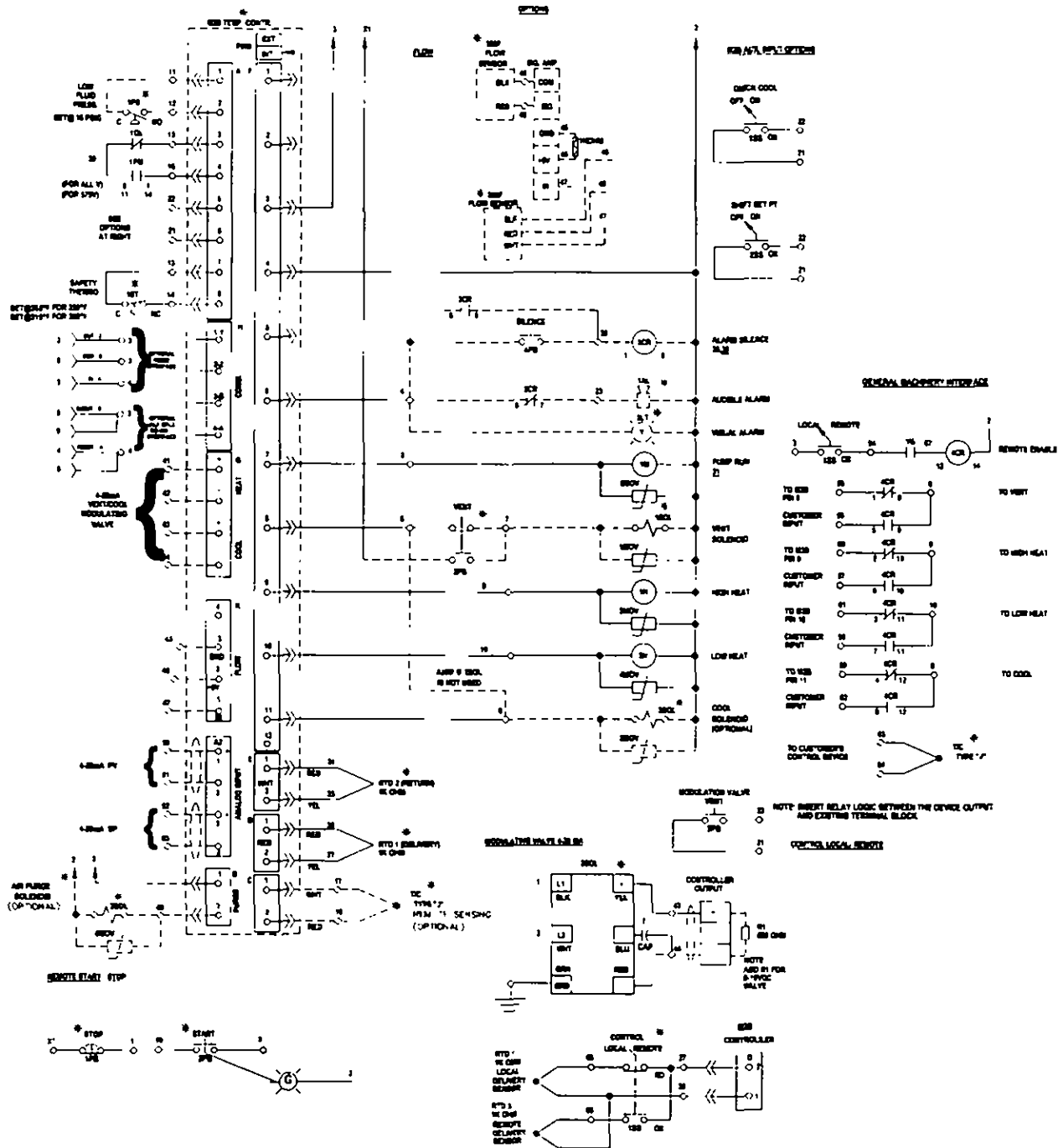

Check the electrical wiring schematic
in your Customer Information packet
for more information.

Figure 7
 Typical Electrical Subpanel Layout

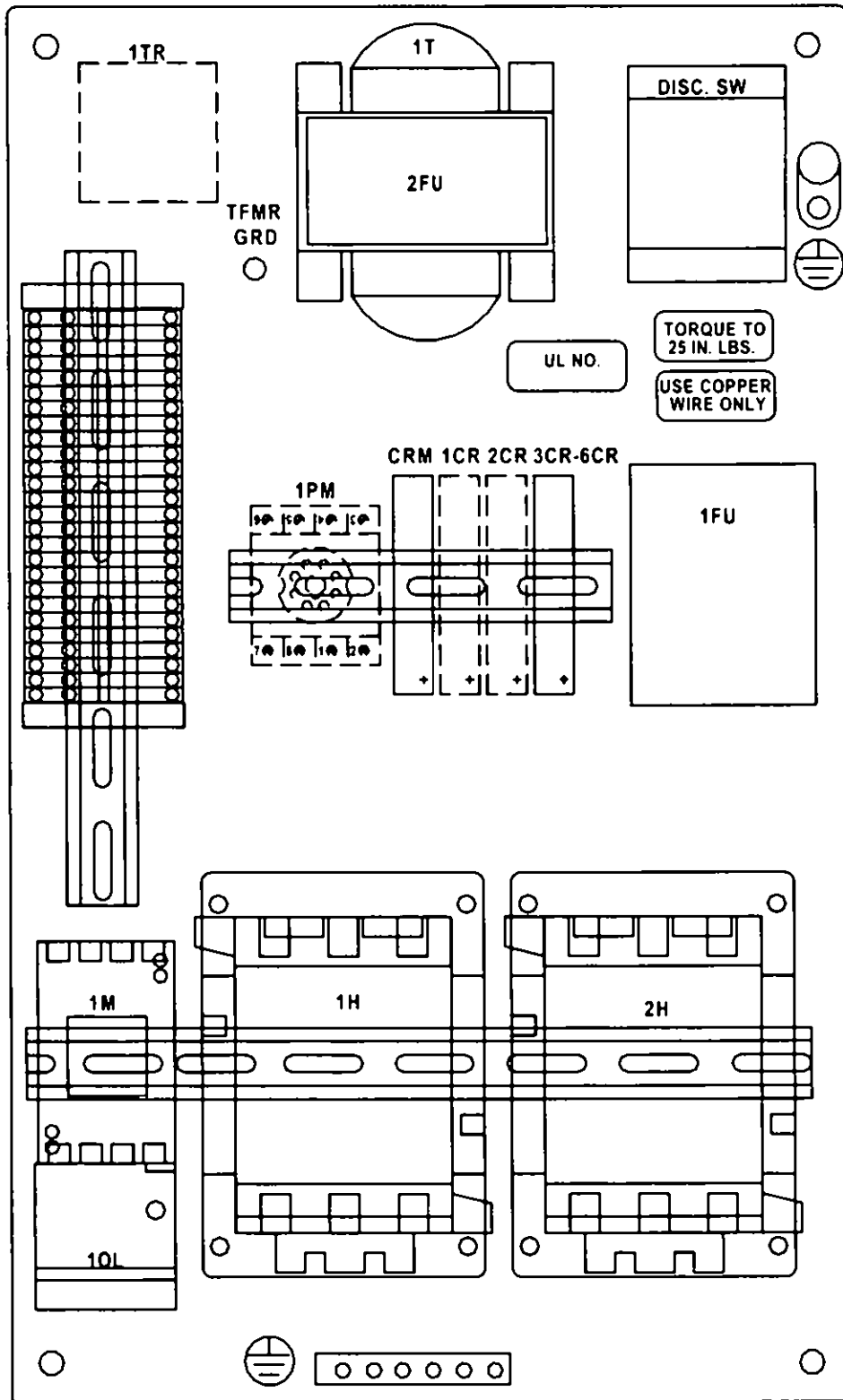

4 Identifying Controls and Features

4-1 Identifying Mechanical Controls and Features

To and From Process Probes

Two (2) 1,000-ohm (1 K Ω) platinum RTD probes are included with your Royal temperature control unit. One is located downstream from the heater to sense To Process temperature; the other probe is located upstream from the pump to sense From Process temperature.

Safety Thermostat

The safety thermostat mounted on the side of the heater tank protects against thermal runaway. The thermostat guards against the unlikely event of “runaway” heating. If overheating occurs, the safety thermostat shuts down heater outputs. The unit continues to pump water through the system to prevent heater damage. Sterling recommends that you install an audible or visual alarm to the terminals provided. Factory installed alarms are available; see the electrical schematics in Figure 6 on Pages 26 and 27 for more information.

Pressure Relief Valve

If the combined pressure of the cooling supply water and pump discharge exceeds 150 psig (1,034.25 kPa/10.34 bars), the pressure relief valve opens and relieves the pressure. This is a non-adjustable ASME construction valve with a stainless steel spring.

Important!

Route a pipe from the pressure relief valve to a suitable drain to reduce potential scalding hazard.

The drain line must not have any restrictions or back pressure.

Low Pressure Cutout Switch

This switch, set at 16 psig with a 2 psig differential (110.3 kPa/1.10 bars with a 13.79 kPa/0.14 bars differential) shuts down the unit if the **COOLING WATER IN** or **MAKEUP** water pressure drops below 16 psig (110.3 kPa/1.10 bars).

Pumps

Pumps range in power from ¾ hp to 10 hp (0.56 kW to 7.46 kW) and are equipped with 3-phase ODP motors and seal flush lines as standard.

The pump is a bronze-fitted close-coupled centrifugal type. It features a split case design to facilitate replacement of the seal. It has a high output capacity with excellent discharge pressure helping it facilitate turbulence to maximize heat transfer, and is well suited for the conditions under which it was designed to operate.

Heaters

The specially designed 9 kW three-phase low watt density electrical immersion heater heats the water, and the controller regulates the temperature. The standard heater has an incolloy sheath for best heat transfer and low fouling properties.

Low watt density immersion heaters at 12 kW, 18, 24 kW, 36 kW, and 48 kW are available options for these models, depending upon the heating needs of the process. All models are built to provide full or partial heat as required by the process and determined by the controller, providing more precise temperature control.

Solenoid Valves

Royal Series systems use rugged, industrial design solenoids with replaceable coils and/or internal components. Depending on required cooling capacity, solenoid valves are available in sizes ranging from ¼" to ¾"; ½" x ¼" and ¾" x ¾" solenoid valves are slow-closing.

Motorized Modulating Valves

Optional

Optional motorized modulating valves are recommended for large cooling applications where the process temperature is very near the cooling water supply temperature and the temperature controller unit pump is used as a booster. The gradual shutoff they provide also eliminates water hammer. The option includes a complete valve and motor package in place of a long-life solenoid valve.

The motorized modulating valve has infinite positioning. It fully opens in one (1) minute and fully closes in 15 seconds.

Water Hammer Arrestor (Shock Stop)

Optional

Shock waves from fast-operating solenoid valves may damage some process systems. For these applications, a welded metal bellows-type shock stop with a pre-charged and sealed nitrogen blanket can be installed in the cooling piping.

Pump Starter

Royal Series high quality IEC-rated pump motor starters are industrial grade motor controls with overload protection and manual reset.

Transformer

High quality industrial design transformers are specified to suit incoming voltage on the application and provide 115 VAC control voltage. The 115 VAC circuit is protected by primary fusing and secondary grounding.

Heater Contactor

Your Royal Series unit uses high-quality IEC-rated industrial-grade electromechanical contactors for heater controls.

Cooling

The controller automatically regulates cooling by opening and closing the solenoid valve or modulating valve. For direct injection, the unit cools by removing the required amount of warm water from the system. This process permits an equal amount of cool plant water to enter the system well ahead of the pump, allowing it to blend with the system water. The water supply temperature governs the minimum operating temperature of the unit.

For closed circuit operation, the unit cools by automatically releasing cooling water through the tubes of the specially designed tube bundle heat exchanger in each zone. The process fluid, such as water, glycol, or other similar fluid, is circulated through the shell of the heat exchanger.

Note: The plant water supply temperature governs the minimum operating temperature of the unit.

Electricals

The pump motor and the immersion heater operate on three-phase 50/60 cycle nominal voltages with the control circuit operating at 115V single phase. The control circuit voltage is provided by a single phase machine tool transformer with a grounded secondary.

The 115V control circuit and controller outputs are fuse protected. The pump motor is controlled by a full voltage magnetic non-reversing motor starter, with fused branch circuit overcurrent and thermal overload protection.

Automatic Vent

This feature automatically triggers the purging of air from the system before you start the unit. The vent actuates the solenoid valve, and forces trapped air and water out through the drain, properly filling and priming the unit prior to startup. ***Complete venting is necessary to prevent damage to the pump and heater.***

The vent process is controlled through a timer. If you have a large process, you may need to complete the venting process by pressing the **VENT** button on the front-mounted switch panel.

Pressure Switch

A pressure switch built into each unit keeps the system from starting until the water supply is turned **On** and subjected to the minimum water supply pressure. This feature protects the pump seal and the heater from damage through attempted operation without water. The pressure switch is set at approximately 16 psig (110.32 kPa/1.10 bars) for 250°F (121°C) units or 55 psig (379.23 kPa/3.79 bars) for 300°F (149°C) units prior to leaving the factory.

4-2 The Microprocessor Controller

The M2B controller is an easy-to-operate microprocessor-based PID control device. When the process reaches the set point, the PID control cycles the cooling valve and/or immersion heater to maintain the proper leaving water temperature.

The controller is fully factory tested. Set the process temperature set point you want and the controller does the rest.

Built-in range of operation on the controller is 0°F to 250°F (-18°C to 121°C).

Figure 8
Typical M2B Graphic and Button Control Panels

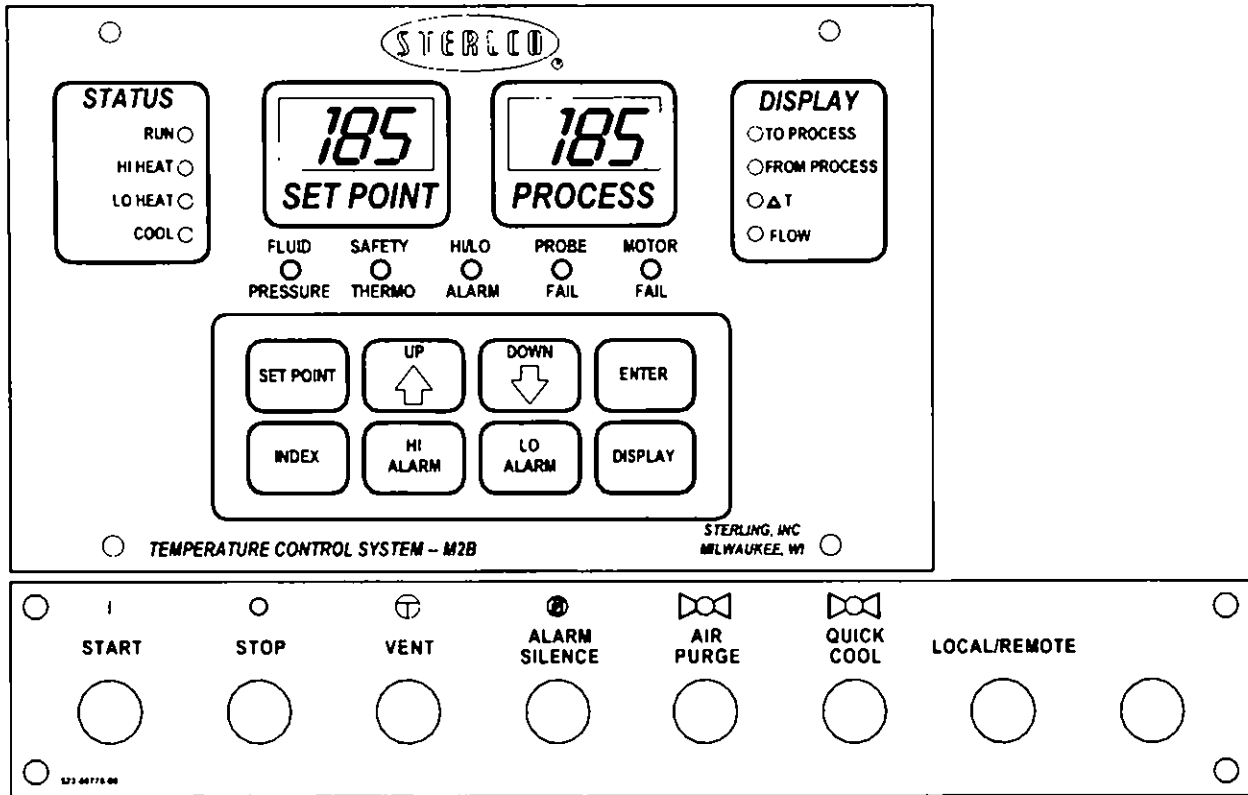

4-3 Identifying M2B Controller Panel Components

Screen Displays

SET POINT Numeric LED

During normal operation, the **SET POINT** LED on the controller displays the process set point you want the unit to maintain. It also displays parameter and pre-set function values during setup.

PROCESS Numeric LED

During normal operation, the **PROCESS** LED on the controller displays the actual process temperature at the To Process thermocouple. It also lists parameter symbols during setup and error messages if an error occurs.

Status Indicators

RUN Indicator

The **RUN** indicator is on during normal operation and flashes during the auto-tuning sequence.

HI HEAT Indicator

The **HI HEAT** indicator is on when fluid heaters are at 100% capacity to rapidly raise fluid temperature.

LO HEAT Indicator

The **LO HEAT** indicator is on when fluid heaters are at 50 percent capacity.

COOL Indicator

The **COOL** indicator is on when fluid temperature is above the set point and is being cooled.

Display Indicators

TO PROCESS Indicator

The **TO PROCESS** indicator is on when the **PROCESS LED** screen on the controller displays the temperature of the outgoing fluid.

FROM PROCESS Indicator

The **FROM PROCESS** indicator is on when the **PROCESS LED** screen on the controller displays the temperature of the incoming fluid.

ΔT Indicator

The ΔT indicator is on when the **PROCESS LED** screen on the controller displays the difference in temperature between the To Process fluid and the From Process fluid.

FLOW Indicator

The **FLOW** indicator is on when the **PROCESS LED** screen on the controller displays the flow of fluid in liters per minute; this function requires the optional flow sensor.

Alarm Indicators

FLUID PRESSURE Indicator

The **FLUID PRESSURE** indicator goes on when fluid pressure is low. The TCU shuts down and resumes operation only when a proper level of fluid pressure is restored.

SAFETY THERMO Indicator

The **SAFETY THERMO** indicator is on when an over-temperature condition occurs. The heater outputs are then disabled, the pump continues to operate, and the **COOL** solenoid energizes. This is a **fatal fault condition**, requiring that main power be disconnected to reset the M2B controller.

HI/LO ALARM Indicator

The **HI/LO ALARM** indicator is on when an individually-set alarm condition occurs. The **HI** deviation is +200°F (about +93°C) above the set point. The **LO** deviation is -100°F (about -37°C) below the set point. **Alarms reset automatically.**

PROBE FAIL Indicator

The **PROBE FAIL** indicator is on when a temperature sensing probe fails. A To Process probe failure displays *DEL* on the screen, and a From Process probe failure displays *RET* on the screen. The alarm resets after the failed probe is replaced.



MOTOR FAIL Indicator

The **MOTOR FAIL** indicator is on during improper pump rotation, motor out of phase, or thermal motor overload conditions. This is a **fatal fault condition**, requiring that main power be disconnected to reset the M2B controller.

4-4 Using M2B Controller Keys



SET POINT Key

Press and hold the  SET POINT key, then press the  UP Arrow key to increase the set point value or press the  DOWN Arrow key to decrease the set point value displayed on the SET POINT LED screen.



UP Arrow Key

Press the  UP Arrow key to increment or advance the values or settings on the LED screens.



DOWN Arrow Key

Press the  DOWN Arrow key to decrement or reduce the values or settings on the LED screens.



Important!

**Do not change any of the control settings
without consulting the Sterling/Sterlco Service Department.**

***The Sterling, Inc. warranty does not cover TCU failures
from tampering with controller settings!***



ENTER Key

The  ENTER key is used with the  INDEX key menu to store the value or the item that was changed. If this key is not pressed, the previously-stored value or item is retained.



INDEX Key



Each press of the **INDEX** key advances the screen to the next menu item. Refer to your Sterling/Sterlco M2B Temperature Control Owner's Manual for a list of functions available using this key.



HI ALARM Key



Press and hold the **HI ALARM** key, then press the **UP Arrow** key to increase the alarm high limit value or press the



DOWN Arrow key to decrease the alarm high limit value on the **SET POINT** LED screen. Refer to your Sterling/Sterlco M2B Temperature Control Owner's Manual for a list of functions available using this key.



LO ALARM Key



Press and hold the **LO ALARM** key, then press the **UP Arrow** key to increase the alarm low limit value or press the



DOWN Arrow key to decrease the alarm low limit value on the **SET POINT** LED screen. Refer to your Sterling/Sterlco M2B Temperature Control Owner's Manual for a list of functions available using this key.



DISPLAY Key



Press the **DISPLAY** key to advance through the display menu. Each key press increments to the next available function. The screen returns to To Process temperature after thirty (30) seconds of inactivity. Refer to your Sterling/Sterlco M2B Temperature Control Owner's Manual for a list of menus available using this key.

Digital Flow Screen

Optional

The optional digital flow screen displays process flow in gallons per minute (gpm). No customer-usable control is necessary. Depending on option level and setup, flows can be measured at rates reaching and exceeding 75 gallons per minute (284 lpm).

4-5 Using Graphic Panel Buttons

Figure 7

START Button

Push the **START** button to energize the unit and begin the temperature control cycle.

STOP Button

Push the **STOP** button to de-energize the unit and stop the temperature control cycle.

VENT Button

Push the **VENT** button for additional manual venting. The **VENT CYCLE** indicator lights during the vent cycle.



ALARM SILENCE Button

Optional

Push the **ALARM SILENCE** button to silence the alarm. You should investigate the alarm condition and restore the unit to normal operation before continuing with the temperature control cycle.

AIR PURGE

Optional

Press the  **UP Arrow** key and the  **DOWN Arrow** key on the M2B controller to purge the system of air. The **PURGE VALVE ON** indicator lights during the air purge cycle.

QUICK COOL Button

Optional

Press the **QUICK COOL** button to open the cooling valve and quickly cool the process.

LOCAL/REMOTE Switch

Optional

Press the **LOCAL/REMOTE** switch to toggle between local and remote temperature sensor probe operation.

4-6 Alarms

Audible/Visual General Fault Alarm

Optional

The audible/visual general fault alarm sounds if any fault triggers, such as low water pressure, over-temperature, or pump overload. A signal from any of the safety devices activates a horn and flashing strobe.

- Push the **ALARM SILENCE** button to silence the alarm.

The optional mechanical high temperature safety alarm is interlocked with the heater. When triggered, the heater cuts out and the pump continues to run.

4-7 Controller Factory Setup

The controller is set up and tested at the factory for optimum operation, and doesn't need to be adjusted. If the controller does not work properly, or you suspect someone has accidentally changed some settings, you can do two things. First, perform the Auto-Tune Procedure described in the following section. If that doesn't work, restore the controller to the original factory settings as described in your Sterling/Sterlco M2B Temperature Control Owner's Manual.



4-8 Auto-Tuning the M2B Controller

The Auto-Tune function lets you fine-tune the M2B controller to process requirements. Activate the Auto-Tune function whenever the process under control changes. The controller automatically evaluates the process, and selects the **P**, **I**, **D**, and fuzzy logic values. It's best to do auto-tuning *before* you run any product.



For best results, start this procedure with a stabilized process temperature, with no rapid rises or drops in temperature.

To auto-tune the M2B controller:

- Switch on the controller.



- Press and hold the  **SET POINT** key, then press the  **UP Arrow** key to **increase** the set point value

- *OR* -

- Press and hold the  **SET POINT** key, then press the  **DOWN Arrow** key to *decrease* the set point value.

Allow the Autovent cycle to be completed; the screen displays the *VNT* message.



- Repeatedly press the  **INDEX** key until the screen displays the *TUN* message.

- Press the  **UP Arrow** key or the  **DOWN Arrow** key until the screen displays the *SLF* message.

- Press the  **ENTER** key.

The Auto-Tune cycle executes.





The **RUN** indicator flashes during the Auto-Tune cycle.

- Repeatedly press the  **INDEX** key until the screens display the *LRN* and *YES* messages.
- Press the  **ENTER** key.

Do not attempt to reprogram the M2B controller or press any keys while the **RUN** indicator flashes during the Auto-Tune cycle. Doing so cancels the Auto-Tune cycle.

4-9 Operating the Unit with the Controller

To change the process temperature set point:

- Press and hold the  **SET POINT** key, then press the  **UP Arrow** key to increase the set point value of the temperature you want.
- Press and hold the  **SET POINT** key, then press the  **DOWN Arrow** key to decrease the set point value of the temperature you want.

The set point automatically updates.

4-10 Communications

A connection port on the electrical cabinet permits easy hook-up to the host computer for RS-232C and RS-485 communications. The connection port is a direct pin-to-pin extension from the back of the controller. For pin outs, consult the Sterling/Sterlco M2B Temperature Control Owner's Manual.

5-1 Introduction

The checklist below outlines start-up procedures for Royal Series water temperature control units. This list assumes that installation information located in this manual has been read and followed.

5-2 Startup Checklist

- Check the shipping papers against the serial tag to make sure that system size, type, and voltage is correct for the process under control.
- Check the transformer primary voltage connections to be sure they are configured for the electrical power you are using. The voltage at the main power connection must be within plus or minus ten percent ($\pm 10\%$) of the voltage listed on the serial tag. Electrical connections must conform to all applicable codes. Make sure that a qualified electrician checks all electrical connections.
- The safety thermostat is preset at the factory to 250°F or 300°F (121°C or 149°C), depending on configuration. It trips at 265°F or 315°F (129°C or 157°C), depending on configuration.
- The relief valve should be piped to an open, unrestricted drain.
- TO PROCESS, FROM PROCESS, WATER IN, WATER OUT, and MOLD PURGE** connections should be complete.

CAUTION

Only use components rated at a minimum of 150 psig and 250°F (1,034.25 kPa/10.34 bars and 121°C).



- All outer panels must be in place.
- All external process valving should be set for proper operation of the unit.
- Cooling and/or makeup water between 16 psig and 55 psig (110.32 kPa/1.1 bars and 379.2 kPa/3.79 bars) must be available for the unit to operate properly.

- ☑ Connect the main power to the unit disconnect switch, and press the **START** switch to check for proper pump rotation direction as described in Section 5-6 on Page 47. Pump rotation should be clockwise, viewed from the **motor** end.
- ☑ Check your work and proceed to the **Startup Procedure** section on the following page.

5-3 Starting the Temperature Control Unit

- ☑ Turn **ON** the water supply, turn the rotary disconnect to the **ON** position, and push the **START** button.
- ☑ The unit automatically executes a one-minute venting sequence to expel air trapped in the process piping. Sterling, Inc. recommends a longer venting sequence on larger process systems. Press and hold the **VENT** button to force the cooling/vent valve open and eliminate air trapped in the process piping in larger process systems.

The controller is **OFF** and the **Vent Cycle** indicator is lighted during the vent sequence.

- ☑ Set the microprocessor controller to the process temperature you want by pressing and holding the  **SET POINT** key, then pressing the  **UP Arrow** key or the  **DOWN Arrow** key until the **SET POINT** screen displays the set point temperature you want.
- ☑ Allow your process to reach the set point temperature, then auto-tune the controller. See Section 4-8 on Pages 41-42 for more information.
- ☑ Watch the drain for any bubbles or erratic flow, which indicates if the system has been properly vented. If the stream is steady, the unit was properly vented and all air is out of the system.
- ☑ Operate the unit, checking for anything unusual that could indicate improper operation.





Note: You can stop the Royal Series temperature control unit at any time by pressing the **STOP** button.

CAUTION

- 1) Your Royal Series system operates with hot water under pressure. To reduce the risk of scalding:
 - Always wear work gloves and safety glasses when operating the unit.
 - Never operate the unit with panels or shields removed.
 - Pipe the relief valve to an open drain.
 - Never install a fitting or hose that is rated less than 150 psig and 250°F (1,034.25 kPa/10.34 bars and 121°C).
- 2) To reduce the risk of electrical shock:
 - All electrical installation and repairs should be done by a qualified electrician.
 - Ground the unit in accordance with electrical codes.
 - Never attempt any repairs without first opening and locking out the main disconnect.
 - Never deactivate or neutralize any safety device.

5-4 Operating the Unit with the M2B Controller

To change the process temperature set point:

- Press and hold the  **SET POINT** key, then press the  **UP Arrow** key to **increase** the set point value of the temperature you want.
- Press and hold the  **SET POINT** key, then press the  **DOWN Arrow** key to *decrease* the set point value of the temperature you want.

The set point automatically updates.

5-5 Sequence of Operation

The simplicity of design and the highly engineered controller make this unit almost self-operating. The **START**, **STOP**, and **VENT** buttons and the temperature controller buttons are all that is required to operate this unit.

After you complete all connections, turn the water supply **ON**, then turn control power **ON**. The unit automatically vents for a preset time of one (1) minute. If you need additional vent time, press the **VENT** button on the control panel.

As the water comes in the water supply line, the water must enter the pump, up through the tank and out through the **TO PROCESS** line, through the process, back through the **FROM PROCESS** line, and through the solenoid line and out the drain line.

At this time, watching the drain for bubbles or erratic flow will indicate whether or not the system has been properly vented. If a steady stream flows from the drain line, it is certain that all the air is out of the system. If you have the unit connected to a central system, watch the pressure gauges for erratic pressure changes. If the gauge is steady, all the air is out of the system.

- ☑ TCU systems provide temperature control on processes by directly heating the process water and injecting cooling water into the process water.
- ☑ When the unit is energized, the pump starts and a one minute vent sequence opens the cooling/vent valve to remove any air trapped in the process piping.
- ☑ If the cooling water supply pressure is insufficient, the low cooling water pressure cutout switch (set at 16 psig, 10 psig differential [110.32 kPa/1.10 bars, 68.95 kPa/0.69 bars differential]) opens, the **LOW WATER PRESSURE** indicator lights, and the unit does not operate until the pressure is 16 psig (110.32 kPa/1.10 bars) or more. **You need at least 16 psig (110.32 kPa/1.10 bars) for the best cooling capacity and to prevent water boiling in the process circuit at high temperatures, particularly at the pump suction.**
- ☑ After venting, the microprocessor controller monitors the **TO PROCESS** RTD probe, cycling open the cooling/vent valve to discharge warm water or energizing the immersion heater to maintain the process set temperature.

5-6 Checking Motor Rotation Direction

Check for correct pump rotation direction by looking at the top of the motor. Press the **START** button and the **STOP** button, and note the direction that the motor turns. Rotation should be **clockwise** when viewed from the motor end.

Note: Make sure that a qualified electrician performs the following steps.

To change rotation direction:

1. Disconnect and lock out power at the fused disconnect.
2. Reverse any two incoming leads at the power terminal blocks.
3. Do not switch leads at the motor or motor starters.

5-7 Shutting Down the Temperature Control Unit

Cool the unit down by selecting a set point of zero (0). Let the unit stabilize at one temperature close to the incoming water temperature, then press the **STOP** button. Now press the **VENT** button to relieve any remaining pressure in the system.

- Notes -

⚠ CAUTION

Never attempt to service a unit until a qualified electrician has opened and locked out the main disconnect using OSHA 1910.147 standards.

The water supply should be turned off and internal pressure should be relieved before you remove panels.

All electrical connections must be done by a qualified electrician.

⚠ WARNING

Disconnect all power to the unit, let the unit cool down, and turn off the water *prior to any servicing.*

*Failure to do so can result in **SERIOUS INJURY OR DEATH!***

6-1 Preventive Maintenance**Draining**

Drain the unit thoroughly if you are taking it out of service for a long period of time, or you expose it to freezing. Drain plugs are provided at the base of the heater tank and at the base of the pump.

Periodic Checks

Every Six Months

Inspect all electrical connections for secure attachment and for safe and secure ground connections. Inspect the power cable, especially at the entrance point to the unit. This inspection should be made by a qualified electrician. Check for leaks, especially under the pump, as it may indicate a worn pump seal.

6-2 Corrective Maintenance

Pumps and Seals

Before leaving our factory, we test each unit extensively, then we calibrate each unit. Afterwards, the unit is drained and blown out with air to remove water from piping systems. If the unit is allowed to stand idle for a long time before being installed in your factory, the housing gasket at the pump can dry out and can possibly leak when the unit is started. In most cases these gaskets will soon swell and form a tight seal. In other cases, it may be necessary for you to tighten the pump bolts to stop a leaking condition.

Pump seal surfaces can separate slightly because of rough handling or from vibration during transit. This could cause a leak at the pump seal when the pump is started, but in most cases the surfaces will mate again after the pump is allowed to run for a short period of time. If they do not reseal, you may need to open the pump and free the seal by hand. It is seldom necessary to install a replacement seal in a new unit unless the seal has been damaged because the unit was started without water.

Our pump seals have a long period of service life. Some conditions, of course, can shorten seal life, including the presence of grit, operation of the unit without water, sustained high water temperature, or presence of certain chemicals in the water. Our pump seal assembly has been developed to resist abrasive particles that are present in many water systems. This is done by a special flushing system that uses water exiting the pump to constantly wash the seal area.

It is also fitted with high temperature flexible components for maximum heat resistance. These same components remain flexible even at low temperatures. Thus, the standard seal is a fine combination of heat resistant and wear resistant components. Unfortunately, even under normal use, the seal will eventually wear and require replacement.

A small puddle underneath the unit is a sign of rotary seal wear, and if investigation confirms the pump as the source, the seal should be replaced as soon as practical. The water slinger is intended to provide temporary protection against this, but a continued and substantial leak will ruin the motor bearing and cause further damage.

After the unit has been in service for a period of years where abrasive conditions are present, you may find that the pump bracket (the top half of the pump casting), can be eroded away in the area around the seat of the rotary seal. This area should provide a straight, smooth bearing surface for the cup seal. Should your casting show signs of erosion in this area, the casting needs to be replaced. The replacement cost of the casting is very modest compared to the down time and maintenance cost for frequently replacing the seal.

Under some conditions, the pump may not start. After turning off the power supply, check the motor shaft to be certain it is free to turn. By removing the drip cover on top of the motor, you'll have access to the end of the shaft. It has been slotted to make it easy to turn with a screwdriver. If the shaft is free to turn, next check that the motor overloads are set, check for blown fuses, and finally check the power supply on each leg to the motor. A qualified electrician should check the motor and its circuit.

Important!

If the pump motor wiring is disconnected for removal from the unit, make sure that you check the actual rotation direction when the motor is rewired to the unit.

A phase sensor does not always indicate proper rotation if motor wire leads are reversed at installation.

Consult the elementary wiring diagram for more information.

Heaters

Heaters may need to be cleaned chemically or mechanically to remove deposits and dirt that reduce heat transfer and cause hot spots. Hot spots cause premature heater failure. Install a new gasket when reassembling. Make sure a qualified electrician disconnects and reconnects heater wires.

Solenoid Valves

- ☑ Clean annually, more often if using high mineral content water or on high service level units.
- ☑ Sluggish operation, excessive leakage, and/or noise indicate cleaning is necessary. Inspect the components for excessive wear while the valve is disassembled.
- ☑ Rebuild kits are available from the Sterling, Inc. Parts Department.

6-3 Restoring the Controller to Factory Setup

If the preset parameters on the controller have been tampered with and it no longer properly controls temperature, you can restore the controller to factory setup parameters. For more information on controller restoration, consult the Sterling/Sterlco M2B Temperature Control Owner's Manual.

6-4 Electrical Connections

Make sure that a qualified electrician inspects all electrical components and connections every six (6) months for secure attachment and ground connections. Inspect all wiring for fraying or damage, especially power lines where they enter the unit. **All wiring connections must be *tight*.**

6-5 Safety Devices

Caution!

Make sure that only qualified electricians test safety devices!

Safety devices should be tested for function **every six (6) months**. Perform the following procedures for testing:

Motor Overload

Disconnect main power. Open the electrical enclosure and rotate the manual **TEST** button on the motor overload to the tripped position. Close the enclosure and reconnect main power. Push the **START** button. The unit should **not** start and the **Pump Overload** indicator should illuminate.

Press the **RESET** button. The unit is now ready for operation.

Pressure Switch

With the unit running, program a set point of 30°F (-1°C). Allow the process temperature to drop under 100°F (38°C). When the process temperature reaches that point, turn off the water supply. The pump should stop and the Low Water Pressure indicator should illuminate. Turn the water supply on to reset the pressure switch.

Adjusting the Pressure Switch

The pressure switch used in your Royal Series water temperature control unit is factory set at 16 psig (110.3 kPa/1.1 bars). However, if the process does not require the unit to operate at 250°F (121°C), you can adjust the switch to meet your process needs.

Tools Required

- Small flat blade screwdriver
- #2 Phillips head screwdriver

⚠ CAUTION



HAZARDOUS ELECTRICAL CURRENT PRESENT.

Maintain a safe ground and disconnect the power supply before servicing the unit.

Make sure a qualified electrician makes electrical connections; disconnect/lock out electricity using OSHA 29CFR 1910.147 standards when servicing the unit.

To adjust the pressure switch:

- Using a small, flat-blade screwdriver, carefully remove the plug at the top of the switch.

Figure 9
Pressure Switch
Side View and Top View

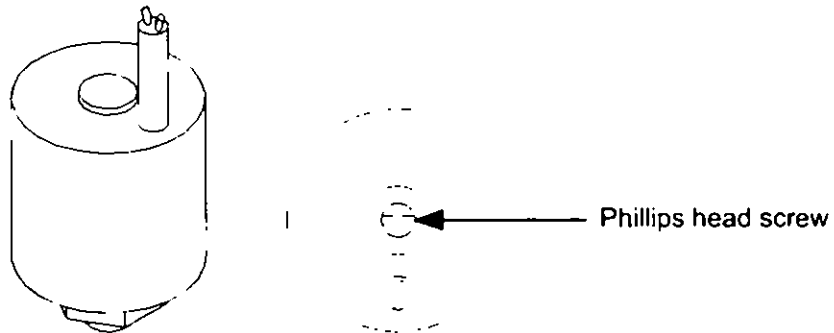

Under the plug is a Phillips-head adjusting screw:

- Turn the screw **counterclockwise** to **reduce** the pressure.

- or -

- Turn the screw **clockwise** to **increase** the pressure.

A quarter turn (90° rotation) approximates 15 psi (103.4 kPa/ 1.0 bars).

- Replace the plug on the top of the switch.

If the plug gets damaged, the switch is still sealed internally.

Make sure that the high limit on the controller is set to the values listed in the following table, based on the switch adjustment. This prevents the pump from cavitating and damaging the seal, the switch, and heater element(s).

psig	kPa	Max. temp. °F	Max. temp. °C
5 psig	34.4 kPa	227°F	108°C
10 psig	68.9 kPa	240°F	116°C
15 psig	103.4 kPa	250°F	121°C

Safety Thermostat

Disconnect main power. Open the electrical enclosure and disconnect the neutral lead on the safety thermostat from the terminal strip. Protect the stripped lead to prevent short circuits. Close the enclosure, reconnect main power, and push the **START** button. The heater should **not** turn on and the **Over Temperature** indicator should illuminate. **Disconnect main power before reconnecting the thermostat lead.**

6-6 Cleaning and Storage

- **Inspect the unit daily for leaks.** Wipe down the unit periodically to remove dirt and dust buildup, especially the motor casing.
- Drain and flush the unit every six (6) months to remove sediment buildup.
- Completely drain the unit and **carefully** blow out the piping with pressurized air before placing the unit in storage.

Figure 10
Customer-Recommended Spare Parts Lists
Immersion Heaters, Compact Models

Part number	Voltage	Kilowatts	Part number	Voltage	Kilowatts
722-00137-07	208 V	9 kW	722-00137-12	415 V	9 kW
722-00137-18	208 V	12 kW	722-00137-24	415 V	12 kW
722-00137-02	230 V	9 kW	722-00137-01	460 V	9 kW
722-00137-03	230 V	12 kW	722-00137-04	460 V	12 kW
722-00137-23	380 V	9 kW	722-00137-08	575 V	9 kW
722-00137-14	380 V	12 kW	722-00137-22	575 V	12 kW

Figure 10
Customer-Recommended Spare Parts Lists (cont'd.)

Immersion Heaters, Upright Models

Part number	Voltage	Kilowatts	Part number	Voltage	Kilowatts
722-00137-15	208 V	18 kW	722-00137-41	415 V	18 kW
722-00137-39	208 V	24 kW	722-00137-30	415 V	24 kW
722-00137-11	240 V	18 kW	722-00137-10	480 V	18 kW
722-00137-05	240 V	24 kW	722-00137-06	480 V	24 kW
722-00137-40	380 V	18 kW	722-00137-17	575 V	18 kW
722-00137-38	380 V	24 kW	722-00137-19	575 V	24 kW

Heater Contactors

Heater kW	Unit operating voltage					
	208 V	240 V	380 V	415 V	480 V	575 V
9 kW	726-00269-02	726-00268-02	726-00267-02	726-00267-02	726-00267-02	726-00267-02
12 kW	726-00270-02	726-00270-02	726-00268-02	726-00268-02	726-00265-02	726-00265-02
18 kW	726-00271-02	726-00271-02	726-00270-02	726-00269-02	726-00269-02	726-00268-02
24 kW	726-00272-02	726-00272-02	726-00271-02	726-00270-02	726-00270-02	726-00269-02
36 kW	726-00238-02	726-00273-02	726-00272-02	726-00271-02	726-00271-02	726-00271-02
48 kW	726-00238-02	726-00238-02	726-00273-02	726-00273-02	726-00272-02	726-00271-02

Note: Add the -02 suffix to part numbers for Allen-Bradley contactors.

Heater Gaskets

Part number	Description
542-00007-08	Heater gasket

Tanks

Part number	Description
615-86192-00	Iron tank; 9 kW and 12 kW models

Thermostats

Part number	Description
724-00665-00	Safety thermostat, auto-reset

Figure 10
Customer-Recommended Spare Parts Lists (cont'd.)

Gauges

Part number	Description
037-00158-00	To and From Process pressure gauge, 0-160 psig (0-1,103 kPa / 0-11 bars)

MI Pumps

Part number	Description
075-00708-00	¼ hp, 208, 230, 460/3/60 voltage, 250°F (121°C)
075-00709-00	1 hp, 208, 230, 460/3/60 voltage, 250°F (121°C)
075-00710-00	2 hp, 208, 230, 460/3/60 voltage, 250°F (121°C)
075-00711-00	3 hp, 208, 230, 460/3/60 voltage, 250°F (121°C)
075-00712-00	5 hp, 208, 230, 460/3/60 voltage, 250°F (121°C)
075-00713-00	7½ hp, 208, 230, 460/3/60 voltage, 250°F (121°C)
075-00841-00	10 hp, 208, 230, 460/3/60 voltage, 250°F (121°C)

Seal Repair Kits

Part number	Description
162-00024-104	Repair kit for ¼ hp to 3 hp pumps; EPDM/NBR Resist
162-00024-105	Repair kit for 5 hp and 7½ hp pumps; EPDM/NBR Resist

Pilot Lights

Part number	Description
715-10074-00	Red pilot light
715-10075-00	Amber pilot light
715-10076-00	Green pilot light
715-10078-00	White pilot light

Control Board

Part number	Description
522-87728-01	Control board for 1/16 DIN controllers

Figure 10
Customer-Recommended Spare Parts Lists (cont'd.)

Rotation Sensor Relays

Part number	Description
701-00066-00	Rotation sensor relay, 208 V to 575 V

Casters

Part number	Description
042-00016-00	3" (76.2 mm) swivel caster
042-00017-00	3" (76.2 mm) stationary caster

Push Buttons

Part number	Description
721-03009-00	VENT push button
721-03010-00	STOP push button
721-03011-00	Illuminated amber START push button
717-02004-00	2-position selector switch

Pressure Switches

Part number	Description
733-00045-00	Water supply pressure switch

Transformers

Part number	Description
704-00178-00	Primary transformer, 208 V with primary fuse block
704-00179-00	Primary transformer, 380 / 415 V with primary fuse block
704-00180-00	Primary transformer, 575 V with primary fuse block
704-00181-00	Primary transformer, 230 / 460 V with primary fuse block

Figure 10
Customer-Recommended Spare Parts Lists (cont'd.)

Motor Contactors

Part number	Description
726-00264-02	Motor contactor, ½ hp to 5 hp (0.373 kW to 3.73 kW), 208 V, 230 V, 460 V, 575 V (except as follows), 7.5 hp (5.60 kW) 575 V
726-00266-02	Motor contactor, 3 hp (2.24 kW), 208 V and 230 V; 5 hp (3.73 kW), 380 V and 415 V; 7.5 hp (5.60 kW), 480 V
726-00267-02	Motor contactor, 5 hp (3.73 kW), 208 V and 230 V
726-00267-02	Motor contactor, 7.5 hp (5.60 kW), 380 V and 415 V, 10 hp (7.46 kW) 480 V and 575 V
726-00265-02	Motor contactor, 7.5 hp (5.60 kW), 230 V, 10 hp (7.46 kW) 380 V and 415 V
726-00268-02	Motor contactor, 7.5 hp (5.60 kW), 208 V, 10 hp (7.46 kW) 208 V and 230 V

Motor Overload Elements

Part number	Description
731-00370-02	Motor overload element, 1.0 to 2.9 FLA (full load amps)
731-00372-02	Motor overload element, 1.6 to 5.0 FLA (full load amps)
731-00375-02	Motor overload element, 3.7 to 12.0 FLA (full load amps)
731-00376-02	Motor overload element, 12.0 to 32.0 FLA (full load amps)

Solenoid Valves

Part number	Description
732-00024-02	¼" (approx. 6.35 mm) valve with ⅝" (approx. 3.97 mm) orifice, 115 V coil (0-150 psig, 300°F [0-1,034 kPa/10.34 bars, 149°C])
732-00095-02	½" (approx. 12.7 mm) valve with ⅞" (approx. 14.29 mm) orifice 115 V coil (slow close, 150 psig, 300°F [1,034 kPa/10.34 bars, 149°C])
732-00093-02	¾" (approx. 19.05 mm) valve with ¾" (approx. 19.05 mm) orifice 115 V coil (slow close, 150 psig, 300°F [1,034 kPa/10.34 bars, 149°C]); C _v = 5.5
718-00383-00	72" lg (183 cm) 18 mm DIN cable

Coil Only for Solenoid Valves

Part number	Description
162-00001-89	115 V coil; used on valve, part no. 732-00024-02
162-00001-88	115 V coil; used on valve, part no. 732-00007-02
162-00001-90	115 V coil; used on valves, part nos. 732-00093-02 and 732-00095-02

Figure 10
Customer-Recommended Spare Parts Lists (cont'd.)

Sensing Probes

Part number	Description
692-07369-25	Heating and cooling sensing probe; 1 KOhm, 0.0385 coefficient
701-00110-00	Heating and cooling sensing probe; type J remote thermocouple

Spare Parts Kit for Solenoid Valves

Part number	Description
162-00001-55	Spare parts kit; used on ¼" (approx. 6.35 mm) solenoid valve w/Teflon seats; special applications only
162-00001-49	Spare parts kit; used on all ¼" (approx. 6.35 mm) valves at 300°F (149°C) maximum temperature, 732-000241
162-00001-07	Spare parts kit; used on ½" (approx. 12.70 mm) valve, part no. 732-00012-00, at 300°F (149°C) maximum temperature
162-00001-60	Spare parts kit; used on ½" and ¾" (approx. 12.70 mm and 19.05 mm) slow-close solenoid valves

Modulating Valve Replacement Parts

Part number	Description
044-00510-03	½" (approx. 12.70 mm) valve body with booster spring
044-00510-05	¾" (approx. 19.05 mm) valve body with booster spring
044-00509-01	Actuator with ½" (approx. 12.70 mm) conduit fitting; ½" to 1¼" (approx. 12.70 mm to 31.75 mm)

Pressure Relief Valves

Part number	Description
044-00138-00	¾" (approx. 19.05 mm) pressure relief valve, rated at 150 psig (1,034.25 kPa/10.34 bars)

Transformer Primary Fuses

Part number	Description
725-00751-00	Transformer primary fuse, 0.5 amp
725-00753-00	Transformer primary fuse, 1.0 amp

Figure 10
Customer-Recommended Spare Parts Lists (cont'd.)

Controller and Communications Components

Part number	Description
714-00167-00	Controller output: relay/relay
714-00163-00	Controller output: relay/current
714-00164-00	RS232 communications
714-00165-00	RS485 communications
714-00166-00	Event input
714-00153-00	4 - 20 mA Re-XMIT

Motor Fuses

Note: Values in this table are the amperages of the fuses used for the correct sized motor running at the correct voltage.

Motor hp	Motor fuse amperage ratings					
	Operating voltage					
	208	230	380	415	460	575
¾	7	7	4	4	4	2.5
1	7	7	4	4	4	2.5
2	12	12	7	7	6	5
3	15	15	10	10	9	7
5	25	20	15	12	10	10
7½	40	30	20	20	20	15
10	50	45	30	25	25	20

Part number	Fuse amps	Fuse voltage	Part number	Fuse amps	Fuse voltage
725-00756-00	2 amps	600 V	725-00812-00	10 amps	600 V
725-00757-00	2.5 amps	600 V	725-00813-00	12 amps	600 V
725-00758-00	3 amps	600 V	725-00814-00	15 amps	600 V
725-00759-00	4 amps	600 V	725-00815-00	20 amps	600 V
725-00760-00	5 amps	600 V	725-00816-00	25 amps	600 V
725-00761-00	6 amps	600 V	725-00877-00	30 amps	600 V
725-00762-00	7 amps	600 V	725-00882-00	40 amps	600 V
725-00810-00	8 amps	600 V	725-00784-00	50 amps	600 V
725-00811-00	9 amps	600 V	725-00785-00	60 amps	600 V

- Notes -

Condition	Possible cause	Solution
Unit does not turn on.	No power.	Check main disconnect, fuses, wiring, and power lead to unit.
	Wrong voltage supplied to unit.	Voltage must be within plus or minus 10% of nameplate rating.
	Defective on/off switch.	Replace.
	Control circuit fuse blown.	Replace.
	Defective control transformer.	Check transformer.
Unit does not run.	Broken or loose wire in pump motor control circuit.	Locate and repair.
	Pump motor contactor holding coil is open.	Repair or replace.
	Low water pressure light on.	Check for at least 16 psig (110.32 kPa/1.1 bars) water pressure on WATER IN or CITY WATER MAKEUP .
	Water supply to unit is turned off.	Open water supply.
	Pump overload light on.	Reset and test each leg for balanced amp draws.
Low pump pressure.	Pump running in reverse.	Verify proper rotation. If not clockwise, reverse any two incoming power leads.
	Foreign matter in the system.	Clean the system.
	System has minimal back pressure, and is operating at the far end of the pump curve.	As long as there is satisfactory process temperature control there is no problem.
High pump pressure.	Foreign matter obstructing system.	Clean the system.
	Restricted water flow.	Check for closed valves etc. Be sure all lines are properly sized.
	System has high back pressure, and is operating at the near end of the pump curve; a low flow condition.	As long as there is satisfactory process temperature control there is no problem.
Pressure switch circuit is open.	Insufficient cooling or makeup water pressure.	Check for 25 psig (172.38 kPa/1.72 bars) water pressure on WATER IN or CITY WATER MAKEUP .
	Switch is broken.	Jump power across switch and see if unit starts. Replace switch if needed.

Condition	Possible cause	Solution
Temperature fluctuations/ rapid cycling from hot to cold.	Undersized connectors/ water lines.	Increase size of connectors/ water lines.
	Long connecting lines between unit and mold.	Move the unit closer to the mold and shorten connecting lines.
	Serpentine flow through mold.	Connect lines for parallel flow instead of series flow.
	Blocked water line in mold.	Check mold for metal chips or lime buildup. Clean mold.
	Quick disconnect fitting with check valve.	Remove and replace fitting or valve.
	Lime buildup in unit piping.	Clean or replace.
	Faulty TCU.	Check unit by connecting ¾" line directly from To Process to From Process line. Run unit to determine if TCU controls set point temperature.
	Reversed probes.	Switch To and From Process probes.
Unit overheats or does not cool.	Drain is plugged or excessive back pressure is in drain line.	Clear drain line or eliminate back pressure condition.
	Faulty solenoid valve.	Test solenoid valve by pressing VENT button and listen for valve operation. Replace if faulty.
	Controller Cool output relay open.	Replace output relay.
	Solenoid valve is not operating, but COOL LED is on.	Set process temperature to minimum and check for magnetism on solenoid coil top.
	Solenoid coil circuit is open.	Check coil resistance. If MΩ range, replace solenoid coil.
	Modulating valve is not operating, but OUT2 LED is on.	Set process temperature to minimum and check for complete travel of valve.
	Insufficient pressure differential between cooling WATER IN and OUT lines.	Find a means to get less back pressure in the WATER OUT line.
	Cooling valve is undersize.	Replace cooling valve with a larger valve.
Relief valve leaks.	Foreign material under valve seat.	Manually open valve to clear seat of material.
	High system pressure.	Reduce WATER IN or MAKEUP water pressure.
Unit runs continuously cooling or heating, and cannot attain set point.	Unit under-sized for application.	Call sales representative.

Condition	Possible cause	Solution
Unit does not heat/cannot achieve set point.	Defective heater contactor.	Visually inspect coil and contacts; repair/replace defective contactors.
	Defective immersion heater.	Check resistance on all three (3) legs of the heater with an ohm meter. If not all equal, contact factory for replacement heater.
	Controller heat output open.	Check the heater output with an ohm meter to ground. It should read in the mega-ohm range. Infinite or zero readings indicate a defective output.
	Heater contactor is not energizing, but HEAT LED is on.	Set process temperature to maximum and check for control voltage at heater contactor.
	Immersion heater elements dirty.	Remove heater and clean elements.
	Immersion heater element is burned out.	Check heater tank for scorched/discolored paint. Check resistance on all three (3) legs of the heater with an ohm meter. Replace heater as required. Check for balanced amp draws, and supply voltage. If not present replace immersion heater.
	OUT1 indicator is on, but no voltage on heater contact.	Replace relay board on controller.
	Cooling valve is leaking.	Dismantle valve and clean out.
	Solenoid valve is not operating, but COOL LED is on.	Set process temperature to minimum and check for magnetism on top of solenoid coil.
	Magnetism on coil.	Clean coil.
Faulty/dirty solenoid valve.	Press VENT button several times to flush the valve.	

- ΔT indicator, 35
- Air Purge button, 39
- Alarm indicators, 35–36
 - Fluid Pressure indicator, 36
 - Hi/Lo Alarm indicator, 36
 - Motor Fail indicator, 36
 - Probe Fail indicator, 36
 - Safety Thermo indicator, 36
- Alarm Silence button, 39
- Alarms, 40
- Audible/visual general fault alarm, 40
- Automatic vent, 32
- Auto-tuning the controller, 41
- Available options, 9–10
- Button panel, 34
- Checking motor rotation direction, 47
- Cleaning and storage, 55
- Closed circuit/direct injection connections, 20
- Communications, 42
- Controller factory setup, 40
- Controller keys, 36–39, 36–39
 - Display key, 38
 - Down arrow key, 37
 - Enter key, 37
 - Hi Alarm key, 38
 - Index key, 38
 - Lo Alarm key, 38
 - Set Point key, 37
 - Up arrow key, 37
- Controller operation, 42
- Cool indicator, 35
- Cooling regulation, 32
- Cooling water connections, 21
- Copyright information, 2
- Corrective maintenance, 50–52
- Cutout switch, low pressure, 30
- Deionized water applications, 20
- Delivery indicator, 35
- Digital flow meter, 39
- Disclaimer information, 2
- Display indicators, 35
 - ΔT indicator, 35
 - Delivery indicator, 35
 - °C flow indicator, 35
 - Return indicator, 35
- Display key, 38
- Distilled water applications, 19
- Down arrow key, 37
- Draining, 49
- Electrical connections, 24, 52
- Electrical subpanel, 28
- Electrical wiring schematics, 26–27
- Electricals, 32
- Enter key, 37
- Expansion tank, 21
- External piping sizing considerations, 17
- Fluid Pressure indicator, 36
- General information
 - Available options, 9–10
 - Models covered, 8
 - Necessary documents, 7–8
 - Standard features, 9
- Graphic and button panels, 34
- Graphic panel, 34
- Graphic panel buttons, 39
- Heater contactor, 31
- Heaters, 30
- Hi Alarm key, 38
- Hi Heat indicator, 35
- Hi/Lo Alarm indicator, 36
- High-mobility piping considerations, 19
- Identifying controls and features, 29–42
 - Alarms, 40
 - Auto-tuning the controller, 41
 - Communications, 42
 - Controller factory setup, 40
 - Controller keys, 36–39
 - Controller operation, 42
 - Graphic panel buttons, 39
 - Identifying mechanical controls and features, 29–33
 - Microprocessor controller, 33
- Identifying mechanical controls and features, 29–33
- Incomplete shipment, 14
- Incorrect shipment, 14
- Index key, 38
- Installation information, 17–28
 - Cooling water connections, 21
 - Electrical connections, 24
 - External piping sizing considerations, 17
 - High-mobility piping considerations, 19
 - Location considerations, 17
 - Permanent piping considerations, 18
 - Process approach temperature considerations, 17
 - Process water connections, 20
 - Process water considerations, 19
 - System purge connections, 22
- Lo Alarm key, 38
- Lo Heat indicator, 35
- Local/Remote button, 40
- Location considerations, 17
- Low pressure cutout switch, 30
- M2B control panel, 34
- M2B Controller Keys, 36–39
- M2B controller panel components, 34–36
- Maintenance
 - Cleaning and storage, 55
 - Corrective maintenance, 50–52
 - Draining, 49
 - Electrical connections, 52
 - Heaters, 52
 - Motor overload, 53
 - Parts lists, 55–61
 - Periodic checks, 50
 - Pressure switch, 53
 - Preventive maintenance, 49
 - Pumps and seals, 50
 - Safety devices, 53, 52–55
 - Safety thermostat, 55
 - Solenoid valves, 52
- Microprocessor controller, 33
- Models covered, 8
- Motor Fail indicator, 36
- Motorized modulating valves, 31
- Necessary documents, 7–8
- °C flow indicator, 35
- Operation, 45
- Options, 9–10

Parts lists, 55–61
 Periodic checks, 50
 Permanent piping considerations, 18
 Pipe sizes for ¾ hp to 7½ hp units, 18
 Pressure drops, 23
 Pressure relief valve, 29
 Pressure switch, 33
 Preventive maintenance, 49
 Probe Fail indicator, 36
 Process approach temperature considerations, 17
 Process screen, 34
 Process water connections, 20
 Process water considerations, 19
 Pump curves
 50 Hz pump curves, 23
 60 Hz pump curves, 23
 Pump starter, 31
 Pumps, 30
 Pumps and seals, 50

 Quick Cool button, 40

 Raw water treatment, 19
 Return indicator, 35
 Returns, 14
 Run indicator, 35

 Safety considerations, 3
 Safety devices, 52–55
 Safety Thermo indicator, 36
 Safety thermostat, 29
 Screen displays, 34
 Process screen, 34
 Set Point screen, 34
 Sequence of operation, 46
 Set Point key, 37
 Set Point screen, 34
 Shipping damages, 13
 Shipping information
 Incomplete shipment, 14
 Incorrect shipment, 14
 Returns, 14
 Shipping damages, 13
 Uncrating, 15
 Unpacking and inspection, 13
 Shock stop, 31
 Shutting down the unit, 47
 Solenoid valves, 30
 Specifications, 12
 Standard features, 8–9
 Start button, 39
 Starting the unit, 44
 Startup and operation
 Checking motor rotation direction, 47
 Operation, 45
 Sequence of operation, 46
 Shutting down the unit, 47

 Starting the unit, 44
 Startup checklist, 43
 Startup checklist, 43
 Status indicators, 35
 Cool indicator, 35
 Hi Heat indicator, 35
 Lo Heat indicator, 35
 Run indicator, 35
 Stop button, 39
 Subpanel, 28
 System purge connections, 22

 TCU drawing, 11
 TCU specifications, 12
 TCU Upright drawing, 12
 Thermocouple, 29
 Thermostat, 29
 To Process thermocouple, 29
 Transformer, 31
 Troubleshooting, 63–65
 Typical piping schematic, 22

 Uncrating, 15
 Unit drawing, 11, 12
 Unpacking and inspection, 13
 Up arrow key, 37

 Vent button, 39

 Water hammer arrestor, 31



Parts Department

Call toll-free 7am–6pm CST [800] 783-7835 or call [414] 354-0970

The Sterling/Sterlco Parts Department at Sterling, Inc. is ready to provide the parts to keep your systems up and running. Sterling/Sterlco replacement parts ensure operation at design specifications. Please have the model and serial number of your equipment when you call. Consult the Customer Parts List included in your information packet for replacement part numbers.



Service Department

Call toll-free 8am–5pm CST [800] 783-7835 or call [414] 354-0970

Sterling/Sterlco has a qualified service department ready to help. Service contracts are available for most Sterling/Sterlco products



Sales Department

Call [414] 354-0970 Monday–Friday, 8am–5pm CST

Sterling/Sterlco products are sold by a network of independent sales representatives. Contact our Sales Department for the name of the sales representative nearest you.

Sterling, Inc.

Sterling/Sterlco
5200 West Clinton Avenue
Milwaukee, WI 53224-9518
[414] 354-0970 • Fax [414] 354-6421



Sterling, Inc. warrants all equipment manufactured by it to be free from defects in workmanship and material when used under recommended conditions. The Company's obligation is limited to repair or replace FOB the factory any parts that are returned prepaid within three (3) years of equipment shipment to the original purchaser, and which, in the Company's opinion, are defective. Any replacement part assumes the unused portion of this warranty. Your Sterling unit is also provided with a five (5) year controller warranty and a lifetime warranty on wetted pump components and pump seal; subject to factory review.

This warranty does not apply to any equipment which, in the Company's opinion, has been subjected to misuse, negligence, or operation in excess of recommended limits or which has been repaired or altered without the Company's express authorization. If the serial number has been defaced or removed from the component, the warranty on that component is void. Defective parts become the property of the warrantor and are to be returned.

The Company is not liable for any incidental, consequential, or special damages or expenses. The Company's obligation for parts not furnished as components of its manufactured equipment is limited to the warranty of the manufacturers of said parts.

Any sales, use, excise, or other tax incident to the replacement of parts under this warranty is the responsibility of the purchaser.

The company neither assumes nor authorizes any other persons to assume for it any liability in connection with the sale of its equipment not expressed in this warranty.

Many types of Sterling, Inc. equipment carry an additional one-year service policy. Consult your Sterling/Sterlco sales representative for specific details.

Sterling, Inc.

PO Box 245018 • 5200 W. Clinton Avenue • Milwaukee, WI 53224-9518 USA
Phone (414) 354-0970 • Fax (414) 354-6421
<http://www.sterlco.com>

STERLCO Service Department

Call Toll Free

(800) 783-7835

Sterling, Inc.

Auxiliary Equipment for the Process Industries

PO Box 245018

5200 West Clinton Avenue • Milwaukee, WI 53224-9518

(414) 354-0970 • Fax (414) 354-6421



**Scrap
Recovery Systems**



**Process Heating/
Cooling**



**Automated
Parts Removal**