

# STIHL 066

Instruction Manual  
Owner's Manual

Assembling  
Safety Precautions  
Operating Instructions  
Maintenance



## Warning!

This saw is capable of severe kickback which may cause serious or fatal injury. Only for users with extraordinary cutting needs and experience and training dealing with kickback. Saws with reduced kickback potential are available.

Read and follow all safety precautions in Owner's Manual – improper use can cause serious or fatal injury. STIHL recommends the use of STIHL reduced kickback bar and low kickback chain.

© Andreas Stihl 1985.

# Important Safety Precautions for Chain Saw Users

## A. Kickback Safety Precautions



### Warning!

Kickback may occur when the nose or tip of the guide bar touches an object, or when the wood closes in and pinches the saw chain in the cut. Tip contact in some cases may cause a lightning fast reverse reaction, kicking the guide bar up and back towards the operator. Pinching the saw chain along the top of the guide bar may push the guide bar rapidly back towards the operator. Either of these reactions may cause you to lose control of the saw which could result in serious personal injury.

Section 5.12 of ANSI B 175.1-1991 sets certain performance and design criteria related to chainsaw kickback. STIHL has developed a color code system using green and yellow to help you select a powerhead, bar and chain combination that complies with the kickback requirements of the ANSI Standard. See the sections entitled "Safety Precautions" and "Specifications" of this manual.

Do not rely exclusively upon the safety devices built into your saw. As a chainsaw user, you should

take several steps to keep your cutting jobs free from accident or injury.

1. With a basic understanding of kickback, you can reduce or eliminate the element of surprise. Sudden surprise contributes to accidents.
2. Keep a good firm grip on the saw with both hands, the right hand on the rear handle, and the left hand on the front handle, when the engine is running. Use a firm grip with thumbs and fingers encircling the chainsaw handles. A firm grip will help you reduce kickback and maintain control of the saw. Don't let go.
3. Make sure the area in which you are cutting is free from obstructions. Do not let the nose of the guide bar contact a log, branch, or any other obstruction while you are operating the saw.
4. Cut at high engine speeds.
5. Do not overreach or cut above shoulder height.

6. Follow manufacturer's sharpening and maintenance instructions for the saw chain.
7. Only use replacement bars and chains specified by the manufacturer or the equivalent.
8. Reduced kickback bars and low kickback chains are designed to reduce the risk of kickback injury. Ask your STIHL dealer about these devices.

## B. Other Safety Precautions

1. Do *not* operate a chainsaw with one hand! Serious injury to the operator, helpers, bystanders, or any combination of these persons may result from one-handed operation. A chainsaw is intended to be used with two hands.
2. Do not operate a chainsaw when you are fatigued.
3. Use safety footwear; snug-fitting clothing; protective gloves; and eye, hearing, and head protection devices.

continued on the back inside cover →

## Contents

Main Parts of Saw	2	Winter Operation	37
Definitions	3	Electric Handle Heating	37
Safety Precautions	4	Take Care of Guide Bar	38
- The Operator	4	Adjusting Carburetor	38
- The Saw	5	Motor management	38
- The Use of the Saw	5	Spark Arresting Screen in Muffler	40
- Maintenance, Repair and Storing	21	Checking Spark Plug	40
Mounting the Bar and Chain	25	Replacing Starter Rope and Rewind Spring	41
Tensioning the Saw Chain	26	Checking and Replacing Chain Sprocket	42
Checking Chain Tension	26	Ordering Spare Parts	43
Fuel Mix	26	Maintaining and Sharpening Saw Chain	44
Fueling	27	Maintenance Chart	47
Chain Lubricant	28	Specifications	48
Filling Chain Oil Tank	28	Stihl Incorporated Limited Warranty	48
Checking Chain Lubrication	28	Federal Emission Control Systems	49
Chain Brake	29	Utility Engines	49
Information Before You Start	30		
Starting	30		
Oil Quantity Control	33		
During Break-in Period	34		
During Operation	34		
After Finishing Work	34		
Storing the Machine	34		
Air Filter System	35		
Cleaning Standard Filter	35		
Cleaning HD Filter	36		

This Manual contains operating and safety instructions for all STIHL 066 series power saws. Pay special attention to the safety precautions outlined on the inside cover and on pages 4 to 24. Allow only persons who understand this Manual to operate your chainsaw. To receive maximum performance and satisfaction from your STIHL chainsaw, it is important that you read and understand the maintenance and safety precautions before using your saw. Contact your STIHL dealer or the STIHL distributor for your area if you do not understand any of the instructions in this Manual.

### **Warning!**

Because a chainsaw is a high-speed wood-cutting tool, some special safety precautions must be observed as with any other power saw to reduce the risk of personal injury. Careless or improper use may cause serious or even fatal injury.

STIHL's philosophy is to continually improve all of its products. As a result, engineering changes and improvements are made from time-to-time. If the operating characteristics or the appearance of your saw differ from those described in this Manual, please contact your STIHL dealer for informations and assistance.

**STIHL®**

Printed on chlorine-free paper

Printing inks contain vegetable oils,  
paper is recyclable

2000 Andreas Stihl AG & Co., Waiblingen

0458 134 3021. M5. E0. T. Printed in Germany

## Main Parts of Saw

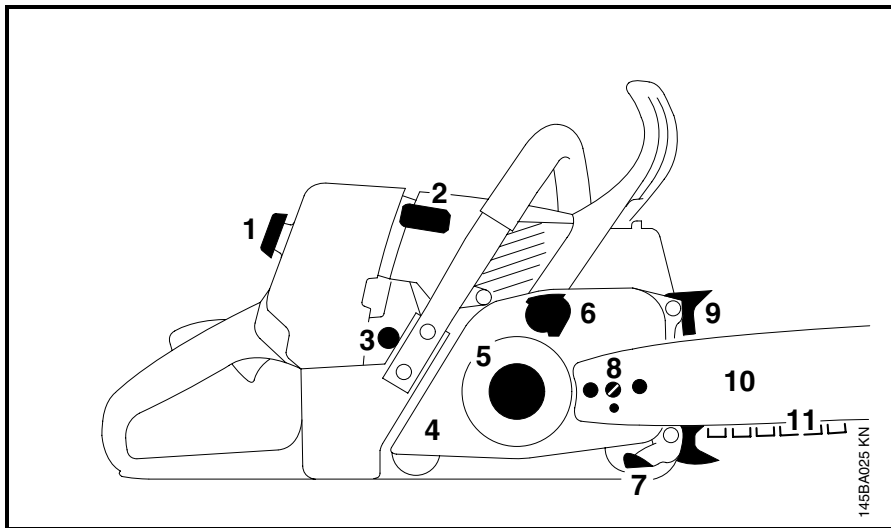

- 1 = Carburetor box cover twist lock
- 2 = Spark plug boot
- 3 = Handle Heating Switch
- 4 = Chain sprocket cover
- 5 = Chain sprocket
- 6 = Chain brake
- 7 = Chain catcher
- 8 = Chain tensioner
- 9 = Bumper spike
- 10 = Guide bar
- 11 = Oilomatic saw chain

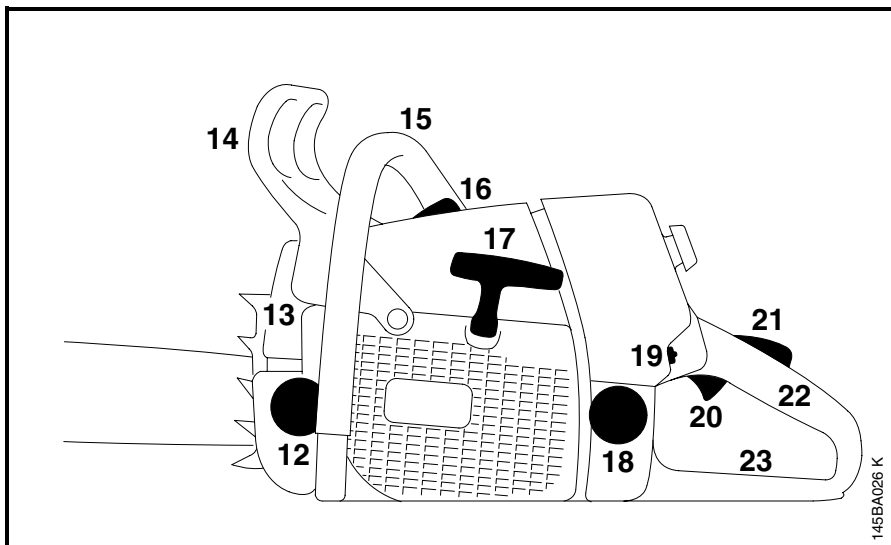

- 12 = Oil filler cap
- 13 = Muffler
- 14 = Front hand guard
- 15 = Front handle (handlebar)
- 16 = Decompression valve
- 17 = Starter grip
- 18 = Fuel filler cap
- 19 = Master Control lever
- 20 = Throttle trigger
- 21 = Throttle trigger interlock
- 22 = Rear handle
- 23 = Rear hand guard

## Definitions

- 1. Carburetor Box Cover Twist Lock**  
Lock for carburetor box cover.
- 2. Spark Plug Boot**  
Connects the spark plug with the ignition wire.
- 3. Handle Heating Switch**  
For switching the electric handle heating on and off
- 4. Chain Sprocket Cover**  
Covers the clutch and the sprocket.
- 5. Chain Sprocket**  
The toothed wheel that drives the saw chain.
- 6. Chain Brake**  
A device to stop the rotation of the chain if activated in a kickback situation by the operator's hand or by inertia.
- 7. Chain Catcher**  
Helps to reduce the risk of operator contact by a chain when it breaks or comes off the bar.
- 8. Chain Tensioner**  
Permits precise adjustment of chain tension.
- 9. Bumper Spike**  
Toothed stop for holding saw steady against wood.
- 10. Guide Bar**  
Supports and guides the saw chain.
- 11. Oilomatic Saw Chain**  
A loop consisting of cutters, tie straps and drive links.
- 12. Oil Filler Cap**  
For closing the oil tank.
- 13. Muffler**  
Reduces engine exhaust noise and directs the exhaust gases.
- 14. Front Hand Guard**  
Provides protection against projecting branches and helps prevent left hand from touching the chain if it slips off the handle bar.
- 15. Front Handle**  
Handle bar for the left hand at front of saw.
- 16. Decompression Valve**  
Makes starting easier
- 17. Starter Grip**  
The grip of the starter, for starting the engine.
- 18. Fuel Filler Cap**  
For closing the fuel tank.
- 19. Master Control Lever**  
Lever for choke control, starting throttle, run and stop switch position.
- 20. Throttle Trigger**  
Controls the speed of the engine.
- 21. Throttle Trigger Interlock**  
Must be depressed before the throttle trigger can be activated.
- 22. Rear Handle**  
The support handle for the right hand, located at or toward the rear of the saw.
- 23. Rear Hand Guard**  
Gives added protection to operator's right hand.

### **Guide Bar Nose**

The exposed end of the guide bar. (not illustrated, see chapter "Tensioning the Saw Chain".

### **Clutch**

Couples engine to chain sprocket when engine is accelerated beyond idle speed. (not illustrated).

### **Anti-Vibration System**

The anti-vibration system includes a number of buffers designed to reduce the transmission of vibrations created by the engine and cutting attachment to the operator's hands. (not illustrated).

## Safety Precautions



The use of any chainsaw may be hazardous. The saw chain has many sharp cutters. If the cutters contact your flesh, they will cut you, even if the chain is not moving. At full throttle, the chain speed can reach 45 mph (20 m/s). It is important that you read, fully understand and observe the following safety precautions and warnings. Read the Owner's Manual **and** the safety instructions periodically.

Pay special attention to the section on reactive forces.



**Warning!** Reactive forces, including kickback, can be dangerous. Careless or improper use of any chainsaw may cause serious or fatal injury.

All safety precautions that are generally observed when working with an ax or a hand saw also apply to the operation of chainsaws. However, because a chainsaw is a high-speed, fast-cutting power tool, special safety precautions must be observed to reduce the risk of personal injury.

Have your STIHL dealer show you how to operate your chainsaw. Observe all applicable local safety regulations, standards and ordinances.



**Warning!** Minors should never be allowed to use a chainsaw. Bystanders, especially children, and animals should not be allowed in the area where a chainsaw is in use. Never let the saw run unattended. Store it in a locked place away from children and empty the fuel tank before storing for longer than a few days.



Do not lend or rent your chainsaw without the Owner's Manual. Be sure that anyone using your saw reads and understands the information contained in this manual.

These safety precautions and warnings apply to the use of all STIHL chainsaws. Different models may have different parts and controls. See the appropriate section of your Owner's Manual for a description of the controls and function of the parts of your model saw.

Safe use of a chainsaw involves

1. the operator
2. the saw
3. the use of the saw.

### THE OPERATOR

#### Physical Condition

You must be in good physical condition and mental health and not under the influence of any substance (drugs, alcohol) which might impair vision, dexterity or judgment.

Do not operate a chainsaw when you are fatigued. Be alert – If you get tired while operating your chainsaw, take a break. Tiredness may result in loss of control. Working with any chainsaw can be strenuous. If you have any condition that might be aggravated by strenuous work, check with your doctor before operating a chainsaw.



**Warning!** Prolonged use of chainsaws (or other machines) exposing the operator to vibrations may produce whitefinger disease (Raynaud's phenomenon) or carpal tunnel syndrome. These conditions

reduce the hand's ability to feel and regulate temperature, produce numbness and burning sensations and may cause nerve and circulation damage and tissue necrosis.

All factors which contribute to whitefinger disease are not known, but cold weather, smoking and diseases or physical conditions that affect blood vessels and blood transport, as well as high vibration levels and long periods of exposure to vibration are mentioned as factors in the development of whitefinger disease. In order to reduce the risk of whitefinger disease and carpal tunnel syndrome, please note the following:

- Many STIHL models are available with an anti-vibration (“AV”) system designed to reduce the transmission of vibrations created by the engine and cutting attachment to the operator's hands. An AV system is recommended for those persons using chainsaws on a regular or sustained basis.
- Wear gloves and keep your hands warm. Heated handles, which are available on most STIHL powerheads, are recommended for cold weather use.

- Keep the saw chain sharp and the saw, including the AV system, well maintained. A dull chain will increase cutting time, and pressing a dull chain through wood will increase the vibrations transmitted to your hands. A saw with loose components or with damaged or worn AV buffers will also tend to have higher vibration levels.
- Maintain a firm grip at all times, but do not squeeze the handles with constant, excessive pressures. Take frequent breaks.

All the above mentioned precautions do not guarantee that you will not sustain whitefinger disease or carpal tunnel syndrome. Therefore, continual and regular users should monitor closely the condition of their hands and fingers. If any of the above symptoms appear, seek medical advice immediately.

### Proper Clothing



#### **Warning!**

To reduce the risk of injury, the operator should wear proper protective apparel.



Clothing must be sturdy and snug-fitting, but allow complete freedom of movement. Avoid loose-fitting jackets, scarfs, neckties, jewelry, flared or cuffed pants, unconfined long hair or anything that could become entangled with the saw or brush. Wear overalls or jeans with a reinforced cut retardant insert or cut retardant chaps.



Protect your hands with gloves when handling saw and saw chain. Heavyduty, nonslip gloves improve your grip and protect your hands.



Good footing is most important in chainsaw work. Wear sturdy boots with nonslip soles. Steel-toed safety boots are recommended.

To reduce the risk of injury to your eyes never operate a chainsaw unless wearing goggles or properly fitted safety glasses with adequate top and side protection complying with your national standard.



Wear an approved safety hard hat to protect your head. Chainsaw noise may damage your hearing. Always wear sound barriers (ear plugs or ear muffers) to protect your hearing. Continual and regular users should have their hearing checked regularly.

## THE SAW

Parts of the chainsaw; for illustrations and definitions of the parts see the chapter on “Main Parts of Saw”.



**Warning!**  
Never modify a chainsaw in any way. Only attachments and parts supplied by STIHL or expressly approved by STIHL for use with the specific STIHL saw models are authorized. Although certain unauthorized attachments are useable with the STIHL powerhead, their use may, in fact, be extremely dangerous.

## THE USE OF THE SAW

### Transporting the chainsaw



**Warning!**  
Always stop the engine before putting a chainsaw down or carrying it. Carrying a chainsaw with the engine running is extremely dangerous.

Accidental acceleration of the engine can cause the chain to rotate. During operation, the powerhead muffler and the material around it reach extremely high temperatures. Avoid touching the hot muffler, you could receive serious burns.

**By hand:** When carrying your saw by hand, the engine must be stopped and the saw must be in the proper position.

Grip the front handle and place the muffler away from the body.

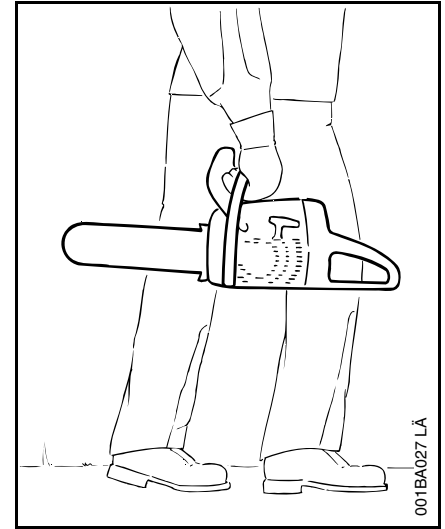

The chain guard (scabbard) should be over the chain and the guide bar, which should point backwards. When carrying your saw, the bar should be behind you.

**By vehicle:** When transporting in a vehicle, keep chain and bar covered with the chain guard. Properly secure your saw to prevent turnover, fuel spillage and damage to the saw.



## Preparation for the use of the saw

Take off the chain guard and inspect for safety in operation. For assembly, follow the procedure described in the chapter "Mounting the Bar and Chain" of your Owner's Manual.

STIHL Oilomatic chain, guide bar and sprocket must match each other in gauge and pitch.

Before replacing any bar and chain, see the sections on "Specifications", "Kickback" and the "ANSI B 175.1-1991 chainsaw kickback standard" in this manual.



### Warning!

Proper tension of the chain is extremely important. In order to avoid improper setting, the tensioning procedure must be followed as described in your manual. Always make sure the hexagonal nut(s) for the sprocket cover is (are) tightened securely after tensioning the chain. Never start the saw with the sprocket cover loose. Check chain tension once more after having tightened the nut(s)

and thereafter at regular intervals (when- ever the saw is shut off). If the chain becomes loose while cutting, shut off the engine and then tighten. Never try to tighten the chain while the engine is running!

## Fueling

Your STIHL chainsaw uses an oil-gasoline mixture for fuel (see chapter "Fuel" of your Owner's Manual).



### Warning!

Gasoline is an extremely flammable fuel. If spilled or ignited by a spark or other ignition source, it can cause fire and serious burn injury or property damage. Use extreme caution when handling gasoline or fuel mix.



Do not smoke or bring any fire or flame near the fuel or the chainsaw. Note that combustible fuel vapors may be vented from the fuel system.

## Fueling Instructions



### Warning!

Fuel your chainsaw in well-ventilated areas, outdoors only. Always shut off the engine and allow it to cool before refueling. Gasoline vapor pressure may build up inside the gas tank of a two cycle engine depending on the fuel used, the weather conditions, and the venting system of the tank. In order to reduce the risk of burns or other personal injury from escaping gas vapor and fumes, remove the fuel filler cap on the STIHL product carefully so as to allow any pressure build-up in the tank to release slowly. Never remove fuel filler cap while engine is running.

Select bare ground for fueling and move at least 10 feet (3 m) from fueling spot before starting the engine. Wipe off any spilled fuel before starting your saw, and check for leakage.



### Warning!

Check for fuel leakage while refueling and during operation. If fuel or oil leakage is found, do not start or run the engine until leak is fixed and spilled fuel has been wiped away. Take care not to get fuel on your clothing. If this happens, change your clothing immediately.

### **Warning!**

Unit vibrations can cause an improperly tightened fuel filler cap to loosen or come off and spill quantities of fuel. In order to reduce the risk of fuel spillage and fire, tighten fuel filler cap by hand with as much force as possible.

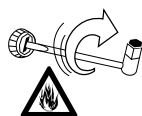

The screwdriver end of the STIHL combination wrench or other similar tool can be used as an aid in tightening slotted fuel filler caps.

### **Starting**

The chain brake must be engaged when starting the saw.

### **Warning!**

Your chainsaw is a one-person saw. Do not allow other persons to be near the running chainsaw. Start and operate your saw without assistance. For specific starting instructions, see the appropriate section of the Owner's Manual. Proper starting methods reduce the risk of injury. Do not drop start. This method is very dangerous because you may lose control of the saw.

There are two recommended methods for starting your chainsaw.

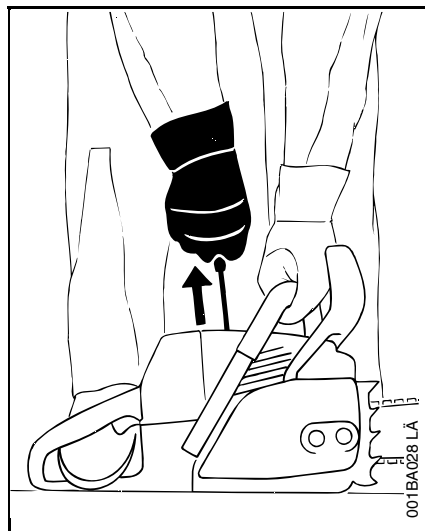

With the **first method**, the chainsaw is started on the ground. Make sure the chain brake is engaged (see “Chain Brake” chapter in your Owner's Manual) and place the chainsaw on firm ground or other solid surface in an open area. Maintain good balance and secure footing.

Grip the front handlebar of the saw firmly with your left hand and press down. For saws with a rear handle level with the ground, put the toe of your right foot into the rear handle and press down. With your right hand pull out the starter grip slowly until you feel a definite resistance and then give it a brisk, strong pull.

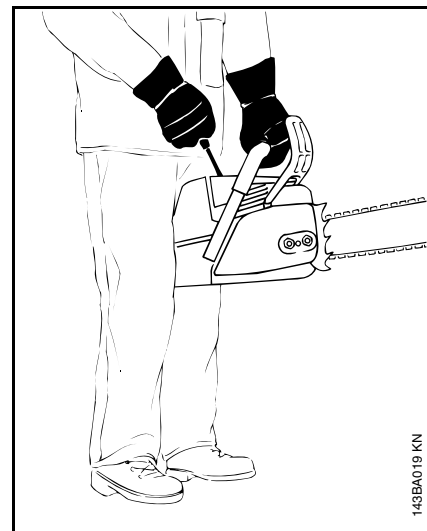

The **second** recommended **method** for starting your chainsaw allows you to start the saw without placing it on the ground. Make sure the chain brake is engaged, grip the front handle of the chainsaw firmly with your left hand. Keep your arm on the front handle in a locked (straight) position. Hold the rear handle of the saw tightly between your legs just above the knees. Maintain good balance and secure footing. Pull the starting grip slowly with your right hand until you feel a definite resistance and then give it a brisk, strong pull.



### **Warning!**

Be sure that the guide bar and chain are clear of you and all other obstructions and objects, including the ground. When the engine is started, the engine speed with the starting throttle lock engaged will be fast enough for the clutch to engage the sprocket and, if the chain-brake is not activated, turn the chain. If the upper quadrant of the tip of the bar touches any object, it may cause kick-back to occur (see section on reactive forces). To reduce this risk, always engage the chain brake before starting. Never attempt to start the chainsaw when the guide bar is in a cut or kerf.



### **Warning!**

When you pull the starter grip, do not wrap the starting rope around your hands. Do not allow the grip to snap back, but guide the starter rope slowly back to permit the rope to rewind properly. Failure to follow this procedure may result in injury to hand or fingers and may damage the starter mechanism.

## **Important adjustments**



### **Warning!**

To reduce the risk of personal injury from loss of control or contact with the running chain, do not use a saw with incorrect idle adjustment. At correct idle speed, the chain should not rotate. For directions to adjust idle speed, see the appropriate section of your Owner's Manual. If you cannot set the correct idle speed, have your STIHL dealer check your saw and make proper adjustments or repairs.

After adjusting a chain, start the saw, let the engine run for a while, then switch engine off and recheck chain tension. Proper chain tension is very important at all times.

## **Working Conditions**

Operate the chainsaw under good visibility and daylight conditions only.



### **Warning!**



Your chainsaw produces poisonous exhaust fumes as soon as the combustible engine is running.

These gases (e.g. carbon monoxide) may be colorless and odorless.

To reduce the risk of serious or fatal injury from breathing toxic fumes, never run the chainsaw indoors or in poorly ventilated locations. Ensure proper ventilation when working in trenches or other confined areas.



### **Warning!**

Use of this product (including sharpening the saw chain) can generate dust, mists and fumes containing chemicals known to cause respiratory disease, cancer, birth defects, or other reproductive harm. If you are unfamiliar with the risks associated with the particular dust, mist or fume at issue, consult your employer, governmental agencies such as OSHA and NIOSH and other sources on hazardous materials. California and some other authorities, for instance, have published lists of substances known to cause cancer, reproductive toxicity, etc.

Control dust (such as sawdust), mists (such as oli mist from chain lubrication) and fumes at the source where possible. In this regard use good work practices and follow the recommendations of OSHA / NIOSH and occupational and trade associations. When the inhalation of toxic dust, mists and fumes cannot be

eliminated, the operator and any bystanders should always wear a respirator approved by NIOSH / MSHA for the type substance at issue.



### **Warning!**

Breathing asbestos dust is dangerous and can cause severe or fatal injury, respiratory illness or cancer. The use and disposal of asbestos containing products have been strictly regulated by OSHA and the Environmental Protection Agency. Do not cut or disturb asbestos, asbestos containing products (e.g. asbestos containing drywall or other construction products), or products such as pipes which are wrapped or covered with asbestos insulation. If you have any reason to believe that you might be cutting asbestos, immediately contact your employer or a local OSHA representative.

The muffler and other parts of the engine (e.g. fins of the cylinder, spark plug) become hot during operation and remain hot for a while after stopping the engine. To reduce risk of burns do not touch the muffler and other parts while they are

hot. Don't work alone. Keep within calling distance of others in case help is needed.

Your chainsaw is equipped with a chain catcher. It is designed to reduce the risk of personal injury in the event of a thrown or broken chain. From time to time the catcher may be damaged or removed. To reduce the risk of personal injury, do not operate a chainsaw with a damaged or missing catcher.

Inspect buffers periodically. Replace damaged, broken or excessively worn buffers immediately, since they may result in loss of control of the saw.

A "sponginess" in the feel of the saw, increased vibration or increased "bottoming" during normal operation may indicate damage, breakage or excessive wear. Buffers should always be replaced in sets. If you have any questions as to whether the buffers should be replaced, consult your STIHL servicing dealer.



### **Warning!**

Take extreme care in wet and freezing weather (rain, snow, ice). Put off the work when the weather is windy, stormy or rainfall is heavy.



### **Warning!**

Avoid stumbling on obstacles such as stumps, roots or rocks and watch out for holes or ditches. Clear the area where you are working. Be extremely cautious when working on slopes or uneven ground. There is increased danger of slipping on freshly debarked logs.



### **Warning!**



To reduce the risk of serious or fatal injury to the operator or bystanders, never use the saw with one hand.

You cannot control reactive forces and you may lose control of the saw, which can result in the skating or bouncing of the bar and chain along the limb or log.

Even for those compact saws designed for use in confined spaces, one-handed operation is dangerous because the operator may lose control.

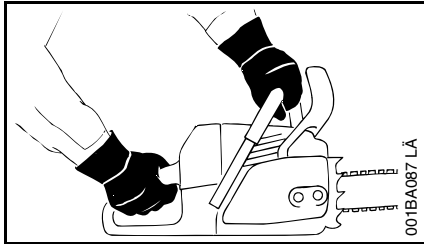

### Cutting Instructions

**Grip:** Always hold the saw firmly with both hands when the engine is running. Place your left hand on front handle bar and your right hand on rear handle and throttle trigger. Left-handers should follow these instructions too.

Wrap your fingers tightly around the handles, keeping the handles cradled between your thumb and forefinger. With your hands in this position, you can best oppose and absorb the push, pull and kickback forces of your saw without losing control (see section on reactive forces). Make sure your chainsaw handles and grip are in good condition and free of moisture, pitch, oil or grease.



#### Warning!

Do not operate your chainsaw with the starting throttle lock engaged. Cutting with the starting throttle lock engaged does not permit the operator proper control of the saw or chain speed.

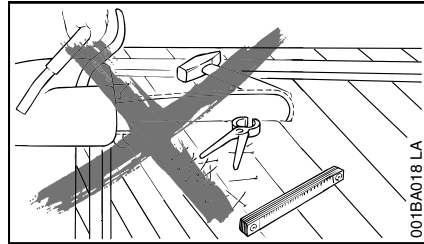

#### Warning!

Never touch a chain with your hand or any part of your body when the engine is running, even when the chain is not rotating. The chain continues to rotate for a short period after the throttle trigger is released.



#### Warning!

Do not cut any material other than wood or wooden objects. Use your chainsaw for cutting only. It is not designed for prying or shoveling away limbs, roots or other objects. When sawing, make sure that the saw chain does not touch any foreign materials such as rocks, fences, nails and the like.

Such objects may be flung off, damage the saw chain or cause the saw to kickback.



#### Warning!

In order to keep control of your saw, always maintain a firm foothold.

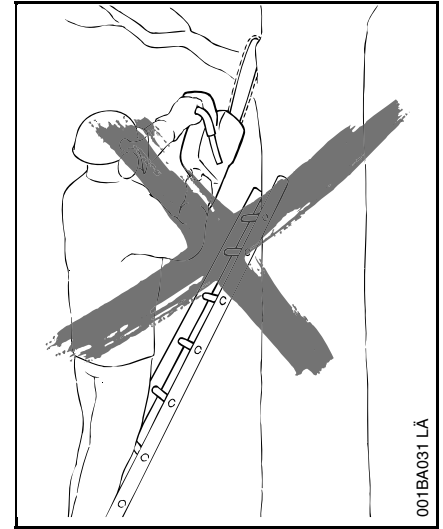

Never work on a ladder, or on any other insecure support. Never use the saw above shoulder height.



#### Warning!

Never work in a tree unless you have received specific, professional training for such work, are properly secured (such as tackle and harness system or a lift bucket), have both hands free for operating the chainsaw in a cramped environment and have taken proper precautions to avoid injury from falling limbs or branches.

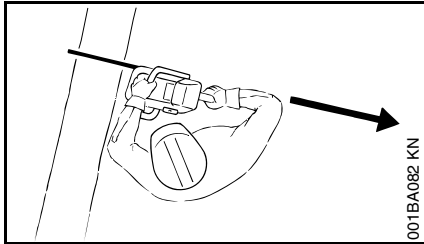

001BA082 KN

Position the chainsaw in such a way that your body is clear of the cutting attachment whenever the engine is running. Stand to the left of cut while bucking.

Don't put pressure on the saw when reaching the end of a cut. The pressure may cause the bar and rotating chain to pop out of the cut or kerf, go out of control and strike the operator or some other object. If the rotating chain strikes some other object, a reactive force may cause the moving chain to strike the operator.

### Reactive forces including kickback



#### Warning!

Reactive forces may occur any time the chain is rotating. Reactive forces can be dangerous! In any chainsaw, the

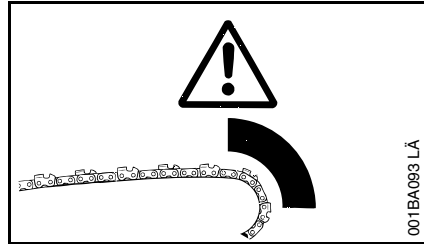

001BA093 LÄ

powerful force used to cut wood can be reversed (and work against the operator). If the rotating chain is suddenly stopped by contact with any solid object like a log or branch or is pinched, the reactive forces may occur instantly. These reactive forces may result in loss of control which may, in turn, cause serious or fatal injury. An understanding of the causes of these reactive forces may help you avoid loss of control.

The most common reactive forces are

- kickback,
- pushback,
- pull-in.

### Kickback:



Kickback may occur when the moving saw chain near the upper quadrant of the bar nose contacts a solid object or is pinched.

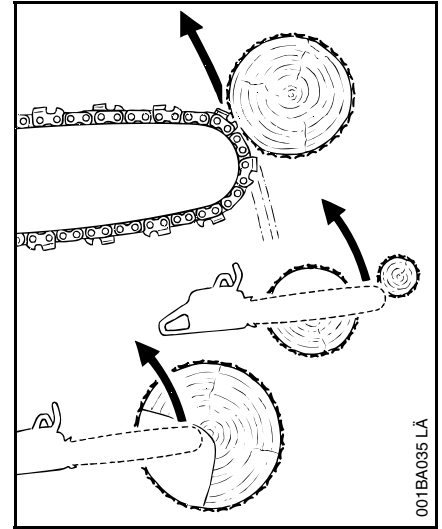

001BA035 LÄ

The reaction of the cutting force of the chain causes a rotational force on the chainsaw in the direction opposite to the chain movement. This may fling the bar up and back in an uncontrolled arc mainly in the plane of the bar. Under some cutting circumstances the bar moves towards the operator, who may suffer severe or fatal injury.

Kickback may occur when the nose of the guide bar is pinched unexpectedly, unintentionally contacts solid material in the wood or is incorrectly used to begin a plunge or boring cut.

It may also occur during limbing. The greater the force of the kickback reaction, the more difficult it becomes for the operator to control the saw. Many factors influence the occurrence and force of the kickback reaction. These include chain speed, the speed at which the bar and chain contact the object, the angle of contact, the condition of the chain and other factors.

The type of bar and saw chain you use is an important factor in the occurrence and force of the kickback reaction. Some STIHL bar and chain types are designed to reduce kickback forces. STIHL recommends the use of reduced kickback bars and low kickback chains.

### **ANSI B 175.1-1991 chainsaw kickback standard**

Section 5.12 of ANSI standard B 175.1-1991, sets certain performance and design criteria related to chainsaw kickback.

To comply with section 5.12 of ANSI B 175.1-1991:

- a) saws with a displacement of less than 3.8 cubic inches
  - must, in their original condition, meet a 45° computer derived kickback angle when equipped with certain cutting attachments.
  - and must be equipped with at least two devices to reduce the risk of kickback injury, such as a chain brake, low kickback chain, reduced kickback bar, etc.
- b) saws with a displacement of 3.8 cubic inches and above
  - must be equipped with at least one device designed to reduce the risk of kickback injury such as a chain brake, low kickback chain, reduced kickback bar, etc.

The computer derived angles for saws below 3.8 cubic inch displacement are measured by applying a computer program to test results from a kickback test machine.



**Warning!**  
The computer derived angles of § 5.12 of ANSI B 175.1-1991 may bear no relationship to actual kickback bar rotation

angles that may occur in real life cutting situations. Compliance with § 5.12 of ANSI B 175.1-1991 does not automatically mean that in a real life kickback the bar and chain will rotate at most 45°.



**Warning!**  
In order for powerheads below 3.8 cubic inch displacement to comply with the computed kickback angle requirements of § 5.12 of ANSI B 175.1-1991 use only the following cutting attachments:

- bar and chain combinations listed as complying in the “Specifications” section of the Owner’s Manual or
  - other replacement bar and chain combinations marked in accordance with the standard for use on the powerhead or
  - replacement chain designated “low kickback saw chain”.
- See the section on “Low kickback saw chain and reduced kickback bars”

## Devices for reducing the risk of kickback injury

STIHL recommends the use of the STIHL Quickstop chain brake on your power-head with green labeled reduced kickback bars and low kickback chains.

### Warning!

To reduce the risk of injury, stop using the saw immediately if the chain brake does not function properly. Take the saw to your local STIHL Service Centre! Do not use the saw until the problem has been rectified (see the section “Chain Brake”).

### Quickstop chain brake

STIHL has developed a chain stopping system designed to reduce the risk of injury in certain kickback situations. It is called a Quickstop chain brake. The Quickstop is available as standard equipment on your STIHL chainsaw and is available for installation on most older STIHL saws. Ask your dealer to retrofit your older model saw with a chain brake.

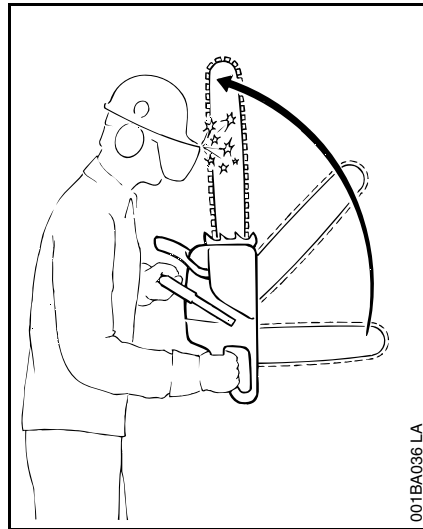

When a kickback occurs, the guide bar may rotate around the front handle. If the cutting position is such that the operator's left hand is gripping the front handle behind the hand guard, and if the left hand rotates around the front handle and makes a sufficiently forceful contact with the front hand guard, which is the Quickstop activating lever, this contact will activate the Quickstop. The chain brake on most new model STIHL chainsaws can also be activated by inertia. See the chapter entitled “Chain Brake” of your Owner's Manual.

### Warning!

Never operate your chainsaw without a front hand guard. In a kickback situation this guard helps protect your left hand or other parts of your body. In addition, removal of the hand guard on a saw equipped with a chain brake will deactivate the chain brake.

### Warning!

No Quickstop or other chain brake device prevents kickback. These devices are designed to reduce the risk of kickback injury, if activated, in certain kickback situations. In order for the Quickstop to reduce the risk of kickback injury, it must be properly maintained and in good working order. See the chapter entitled “Chain Brake” and “Maintenance, Repair and Storing” of your Owner's Manual. In addition, there must be enough distance between the bar and the operator to ensure that the Quickstop has sufficient time to activate and stop the chain before potential contact with the operator.



**Warning!**

An improperly maintained chain brake may increase the time needed to stop the chain after activation, or may not activate at all.

**Warning!**

Never run the chainsaw above idle speed for more than 3 seconds when the chain brake is engaged or the chain is pinched or otherwise caught in the cut. Clutch slippage can cause excessive heat, leading to severe damage of the motor housing, clutch and oiler component and may interfere with the operation of the chain brake. If clutch slippage in excess of 3 seconds has occurred, allow the motor housing to cool before proceeding and check the operation of your chain brake as described in the chapter entitled "Chain Brake". Also make sure that the chain is not turning at idle speed (see above "Important Adjustments").

**Low kickback saw chain and reduced kickback bars"**

STIHL offers a variety of bars and chains. STIHL reduced kickback bars and low kickback chains are designed to

reduce the risk of kickback injury. Other chains are designed to obtain higher cutting efficiency or sharpening ease but may result in higher kickback tendency.

STIHL has developed a color code system to help you identify the STIHL reduced kickback bars and low kickback chains. Cutting attachments with green warning decals or green labels on the packaging are designed to reduce the risk of kickback injury. The matching of green decalated powerheads under 3.8 cubic inch displacement with green labeled bars and green labeled chains gives compliance with the computed kickback angle requirements of ANSI B 175.1-1991 when the products are in their original condition. Products with yellow decals or labels are for users with extraordinary cutting needs and experience and specialized training for dealing with kickback.

**STIHL recommends the use of its green labeled reduced kickback bars, green labeled low kickback chains and a STIHL Quickstop chain brake for both experienced and inexperienced chainsaw users.**

Please ask your STIHL dealer to properly match your powerhead with the appropriate bar/chain combinations to reduce the risk of kickback injury. Green labeled bars and chains are recommended for all powerheads. See your "STIHL Bar and Chain Information" leaflet for details.

**Warning!**

Use of other, non-listed bar/chain combinations may increase kickback forces and increase the risk of kickback injury. New bar/chain combinations may be developed after publication of this literature, which will, in combination with certain powerheads, comply with § 5.12 of ANSI B 175.1-1991. Check with your STIHL dealer for such combinations.

**Warning!**

Reduced kickback bars and low kickback chains do not prevent kickback, but they are designed to reduce the risk of kickback injury. They are available from your STIHL dealer.

**Warning!**

Even if your saw is equipped with a Quickstop, a reduced kickback bar and/or low kickback chain, this does not eliminate the risk of injury by kickback. Therefore, always observe all safety precautions to avoid kickback situations.

## Low kickback chain

Some types of saw chain have specially designed components to reduce the force of nose contact kickback. STIHL has developed low kickback chain for your powerhead.

“Low kickback saw chain” is a chain which has met the kickback performance requirements of § 5.12.2.4 of ANSI B 175.1-1991 (Safety Requirements for Gasoline-Powered Chain-Saws) when tested on a selected representative sample of chainsaws below 3.8 cubic inch displacement specified in ANSI B 175.1-1991.



### Warning!

There are potential powerhead and bar combinations with which low kickback saw chains can be used which have not been specifically certified to comply with the 45° computer derived kickback angle of § 5.12 of ANSI B 175.1-1991. Some low kickback chains have not been tested with all powerhead and bar combinations.



### Warning!

A dull or improperly sharpened chain may reduce or negate the effects of the design features intended to reduce

kickback energy. Improper lowering or sharpening of the depth gauges or shaping of the cutters may increase the chance and the potential energy of a kickback. Always cut with a properly sharpened chain.

## Reduced kickback bar

STIHL green labeled reduced kickback bars are designed to reduce the risk of kickback injury when used with STIHL green labeled low kickback chains.



### Warning!

When used with other, more aggressive chains, these bars may be less effective in reducing kickback, and may result in higher kickback forces.

## Bow Guides



### Warning!

Do not mount a bow guide on any STIHL chainsaw. Any chainsaw equipped with a bow guide is potentially very dangerous. The risk of kickback is increased with a bow guide because of the increased kickback contact area. Low kickback chain will not significantly reduce the risk of kickback injury when used on a bow guide.

## To avoid kickback

The best protection from personal injury that may result from kickback is to avoid kickback situations:

1. Hold the chainsaw firmly with both hands and maintain a secure grip.
2. Be aware of the location of the guide bar nose at all times.
3. Never let the nose of the guide bar contact any object. Do not cut limbs with the nose of the guide bar. Be especially careful when cutting small, tough limbs, small size brush and saplings which may easily catch the chain.
4. Don't overreach.
5. Don't cut above shoulder height.
6. Begin cutting and continue at full throttle.
7. Cut only one log at a time.
8. Use extreme caution when reentering a previous cut.
9. Do not attempt to plunge cut if you are not experienced with these cutting techniques.
10. Be alert for shifting of the log or other forces that may cause the cut to close and pinch the chain.
11. Maintain saw chain properly. Cut with a correctly sharpened, properly tensioned chain at all times.
12. Stand to the side of the cutting path of the chainsaw.

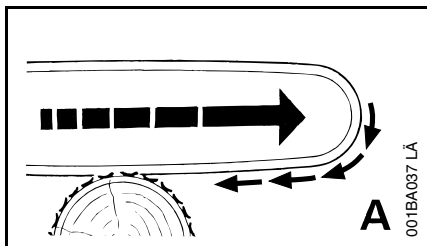

#### A = Pull-in:

Pull-in occurs when the chain on the bottom of the bar is suddenly stopped when it is pinched, caught or encounters a foreign object in the wood. The reaction of the chain pulls the saw forward and may cause the operator to lose control.

Pull-in frequently occurs when the bumper spike of the saw is not held securely against the tree or limb and when the chain is not rotating at full speed before it contacts the wood.



#### Warning!

Use extreme caution when cutting small size brush and saplings which may easily catch the chain and pull you off balance.

#### To avoid pull-in

1. Always start a cut with the chain rotating at full speed and the bumper spike in contact with the wood.
2. Pull-in may also be prevented by using wedges to open the kerf or cut.

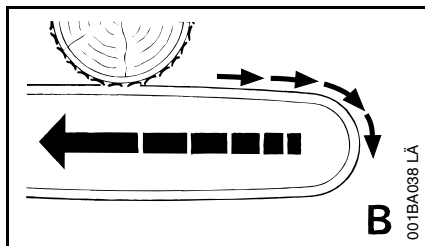

#### B = Pushback:

Pushback occurs when the chain on the top of the bar is suddenly stopped when it is pinched, caught or encounters a foreign object in the wood. The reaction of the chain drives the saw straight back toward the operator and may cause loss of saw control. Pushback frequently occurs when the top of the bar is used for cutting.

#### To avoid pushback

1. Be alert to forces or situations that may cause material to pinch the top of the chain.
2. Do not cut more than one log at a time.
3. Do not twist the saw when withdrawing the bar from a plunge cut or underbuck cut because the chain can pinch.

## Cutting Techniques

### Felling

Felling is cutting down a tree.

Before felling a tree, consider carefully all conditions which may affect the direction of fall, including:

The intended direction of the fall.

The natural lean of the tree.

Any unusually heavy limb structure.

Surrounding trees and obstacles.

The wind direction and speed.



#### Warning!

Always observe the general condition of the tree. Inexperienced users should never attempt to cut trees which are decayed or rotted inside or which are leaning or otherwise under tension. There is an increased risk that such trees could snap or split while being cut and cause serious or fatal injury to the operator or bystanders. Also look for broken or dead branches which could vibrate loose and fall on the operator. When felling on a slope, the operator should stand on the uphill side if possible.

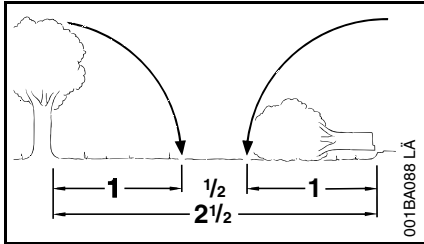

### Felling Instructions:

When felling, maintain a distance of at least  $2\frac{1}{2}$  tree lengths from the nearest person.

When felling in the vicinity of roads, railways and power lines, etc., take extra precautions. Inform the police, utility company or railway authority before beginning to cut.



#### Warning!

The noise of your engine may drown any warning call.



#### Warning!

There are a number of factors that may affect and change the intended direction of fall, e.g. wind, lean of tree, sloping ground, one-sided limb structure, wood structure, decay, snow load, etc. To reduce the risk of severe or fatal injury to yourself or others, look for these conditions prior to beginning the cut, and be alert for a change in direction during fall.

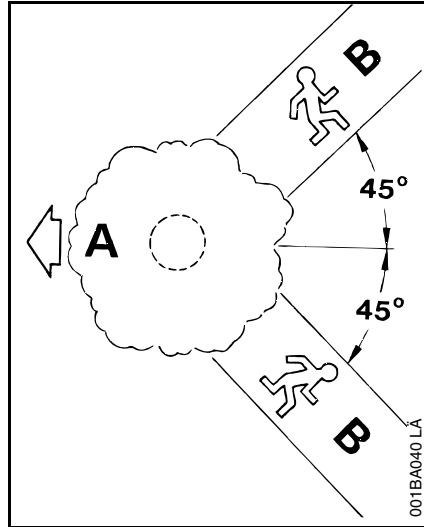

### Escape path

First clear the tree base and work area from interfering limbs and brush and clean its lower portion with an ax.

Then, establish two paths of escape (**B**) and remove all obstacles. These paths should be generally opposite to the planned direction of the fall of the tree (**A**) and about at a  $45^\circ$  angle. Place all tools and equipment a safe distance away from the tree, but not on the escape paths.

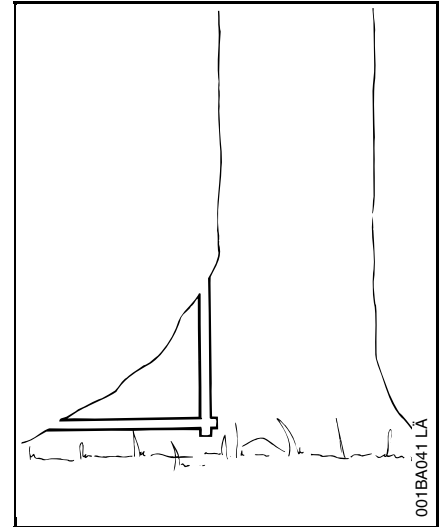

### Buttress roots

If the tree has large buttress roots, cut into the largest buttress vertically first (horizontally next) and remove the resulting piece.

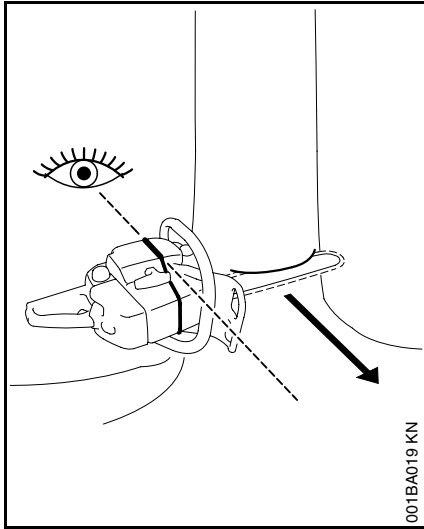

### Gunning sight

When making the felling notch, use the gunning sight on the shroud and housing to check the required direction of fall:

- Position the saw so that the gunning sight points exactly in the direction you want the tree to fall.

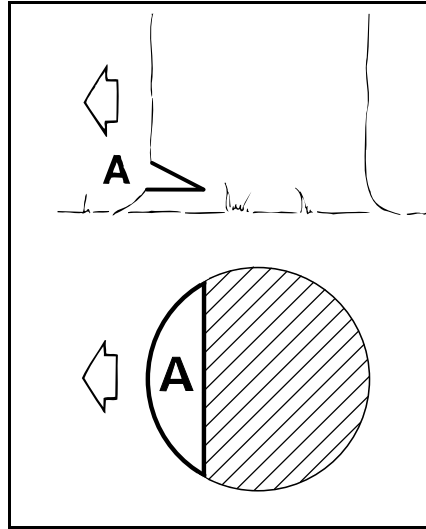

### Conventional cut

**A** = felling notch - determines the direction of the fall

For a conventional cut:

- Properly place felling notch perpendicular to the line of fall, close to the ground
- Cut down at app. 45-degree angle to a depth of about 1/5 to 1/4 of the trunk diameter
- Make second cut horizontal
- Remove resulting 45-degree piece

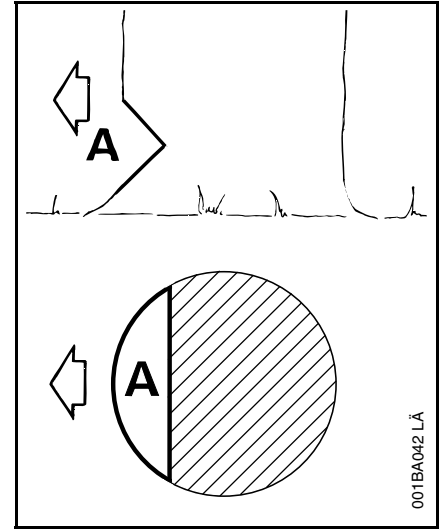

### Open-face technique

**A** = felling notch - determines the direction of the fall

For an open-face cut:

- Properly place felling notch perpendicular to the line of fall, close to the ground
- Cut down at app. 50-degree angle to a depth of app. 1/5 to 1/4 of the trunk diameter
- Make second cut from below at app. 40 degree angle
- Remove resulting 90-degree piece

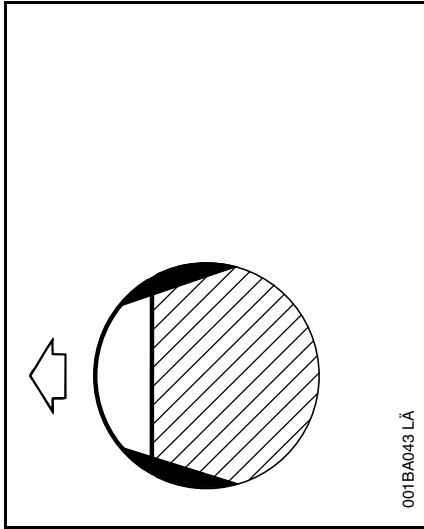

### Making sapwood cuts

- For medium sized or larger trees make cuts at both sides of the trunk, at same height as subsequent felling cut.
- Cut to no more than width of guide bar.

This is especially important in soft wood in summer - it helps prevent sapwood splintering when the tree falls.

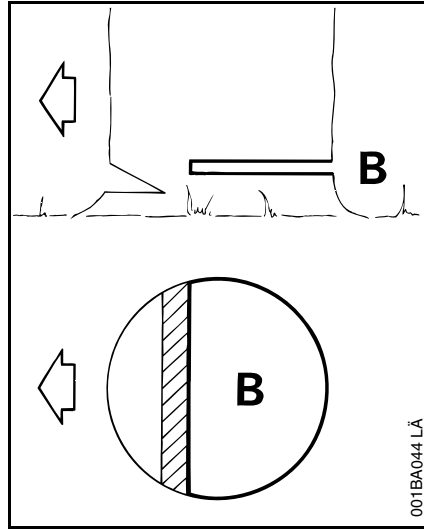

### B = Felling cut

Conventional and open-face technique:

- Begin 1 to 2 inches higher than center of felling notch
- Cut horizontally towards the felling notch
- Leave approx.  $\frac{1}{10}$  of diameter uncut. This is the hinge
- Do not cut through the hinge – you could lose control of the direction of the fall

Drive wedges into the felling cut where necessary to control the fall.



### Warning!

If the tip of the bar contacts a wedge, it may cause kickback. Wedges should be of wood or plastic – never steel, which can damage the chain.

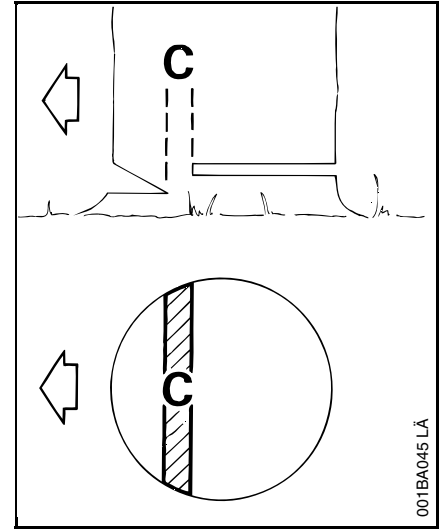

### C = Hinge

- Helps control the falling tree
- Do not cut through the hinge - you could lose control of the direction of the fall



### Warning!

In order to reduce the risk of personal injury, never stand directly behind the tree when it is about to fall, since part of the trunk may split and come back towards the operator (barber-chairing), or the tree may jump backwards off the stump. Always keep to the side of the falling tree. When the tree starts to fall, withdraw the bar, shut off the engine and walk away on the preplanned escape path. Watch out for falling limbs.

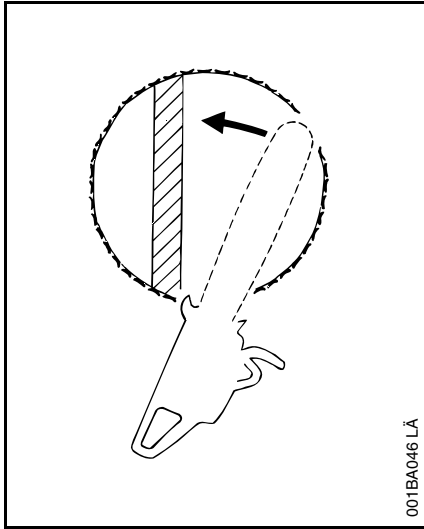

001BA046 LÄ



### Warning!

Be extremely careful with partially fallen trees which are poorly supported. When the tree hangs or for some other reason does not fall completely, set the saw aside and pull the tree down with a cable winch, block and tackle or tractor. If you try to cut it down with your saw, you may be injured.

### Felling cut for small diameter trees: simple fan cut

Engage the bumper spikes of the chain-saw directly behind the location of the intended hinge and pivot the saw around this point only as far as the hinge. The bumper spike rolls against the trunk.

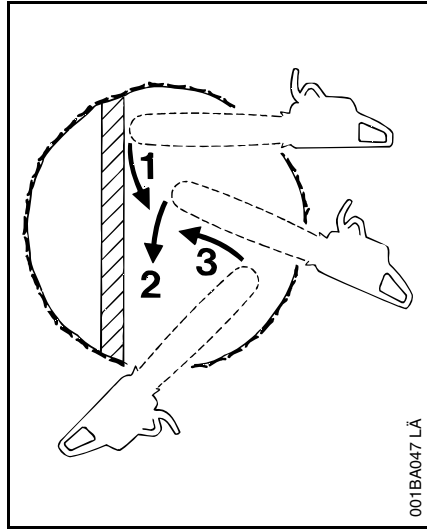

001BA047 LÄ

### Felling cut for large diameter trees:



### Warning!

Felling a tree that has a diameter greater than the length of the guide bar requires use of either the sectioning felling cut or plunge-cut method. These methods are extremely dangerous because they involve the use of the nose of the guide bar and can result in kickback. Only properly trained professionals should attempt these techniques.

### Sectioning method

For the sectioning method make the first part of the felling cut with the guide bar fanning in toward the hinge. Then, using the bumper spike as a pivot, reposition the saw for the next cut.

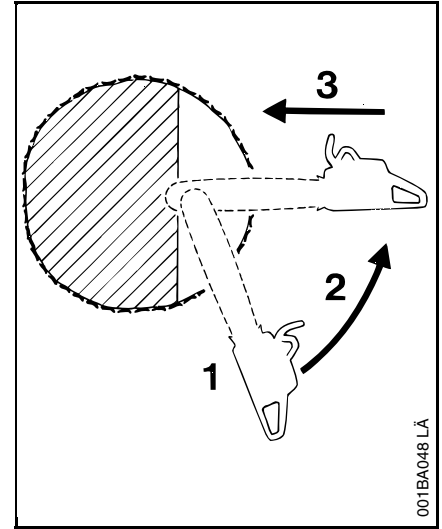

001BA048 LÄ

Avoid repositioning the saw more than necessary. When repositioning for the next cut, keep the guide bar fully engaged in the kerf to keep the felling cut straight. If the saw begins to pinch, insert a wedge to open the cut. On the last cut, do not cut the hinge.

### Plunge-cut method

Timber having a diameter more than twice the length of the guide bar requires the use of the plunge-cut method before making the felling cut.

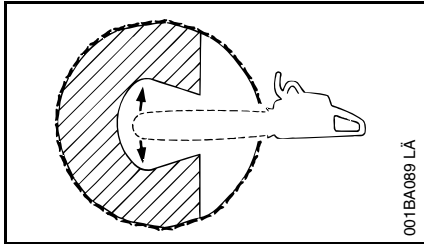

First, cut a large, wide felling notch. Make a plunge cut in the center of the notch.

The plunge cut is made with the guide bar nose. Begin the plunge cut by applying the lower portion of the guide bar nose to the tree at an angle. Cut until the depth of the kerf is about the same as the width of the guide bar. Next, align the saw in the direction in which the recess is to be cut.

With the saw at full throttle, insert the guide bar in the trunk.

Enlarge the plunge cut as shown in illustration.

### **Warning!**

There is an extreme danger of kickback at this point. Extra caution must be taken to maintain control of the saw. To make the felling cut, follow the sectioning method described previously.

If you are inexperienced with a chainsaw, plunge-cutting should not be attempted. Seek the help of a professional.

### **Limbing**

Limbing is removing the branches from a fallen tree.

### **Warning!**

There is an extreme danger of kickback during the limbing operation. Do not work with the nose of the bar. Be extremely cautious and avoid contacting the log or other limbs with the nose of the guide bar.

Do not stand on a log while limbing it – you may slip or the log may roll.

Start limbing by leaving the lower limbs to support the log off the ground. When underbucking freely hanging limbs, a pinch may result or the limb may fall, causing loss of control. If a pinch occurs, stop the engine and remove the saw, by lifting the limb.

### **Warning!**

Be extremely cautious when cutting limbs or logs under tension (spring poles). The limbs or logs could spring back toward the operator and cause loss of control of the saw and severe or fatal injury to the operator.



### **Bucking**

Bucking is cutting a log into sections.

### **Warnings!**

1. When bucking, do not stand on the log. Make sure the log will not roll downhill. If on a slope, stand on the uphill side of the log. Watch out for rolling logs.



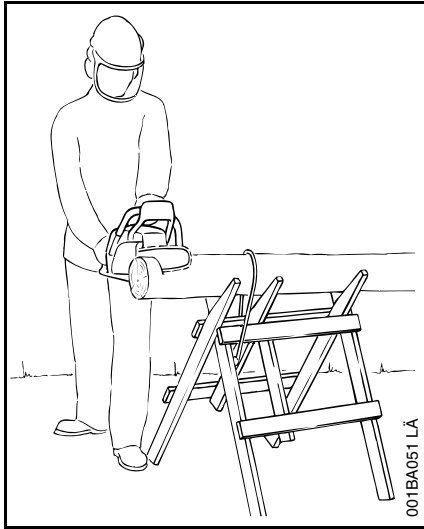

2. Cut only one log at a time.
3. Shattered wood should be cut very carefully. Sharp slivers of wood may be caught and flung in the direction of the operator of the saw.
4. When cutting small logs, place log through "V" - shaped supports on top of a sawhorse. Never permit another person to hold the log. Never hold the log with your leg or foot.

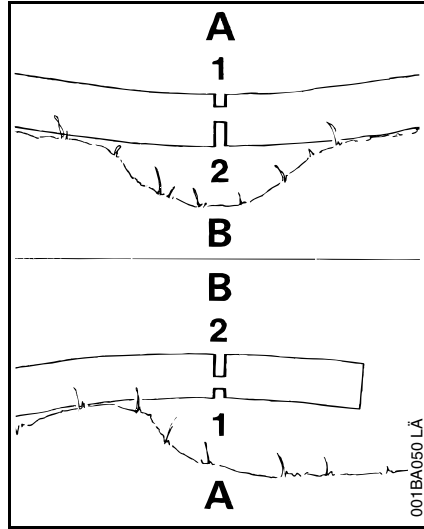

5. Logs under strain: Risk of pinching! Always start relieving cut (1) at compression side (A). Then make bucking cut (2) at tension side (B). If the saw pinches, stop the engine and remove it from the log.
6. Only properly trained professionals should work in an area where the logs, limbs and roots are tangled. Working in blowdown areas is extremely hazardous.
7. Drag the logs into a clear area before cutting. Pull out exposed and cleared logs first.

## MAINTENANCE, REPAIR AND STORING

Maintenance, replacement, or repair of the emission control devices and systems may be performed by any nonroad engine repair establishment or individual. However if you claim warranty for a component which has not been serviced or maintained properly or if nonapproved replacement parts were used, STIHL may deny warranty.

Never operate a chainsaw that is damaged, improperly adjusted or not completely or securely assembled. Follow the maintenance and repair instructions in the appropriate section of your Owner's Manual, especially those in the chapters "Mounting the Bar and Chain", "Maintaining and Sharpening" and "Chain Brake".

### **Warning!**

Use only STIHL replacement parts for maintenance and repair. Use of parts manufactured by others may cause serious or fatal injury.

### **Warning!**

Always stop the engine and ensure that the chain is stopped before making any adjustments, maintenance or repair work,

changing the saw chain or cleaning the saw. Do not attempt any maintenance or repair work not described in your Owner's Manual. Have such work performed at your STIHL service shop only.

 **Warning!**

Never test the ignition system with ignition wire terminal removed from spark plug or with unseated spark plug, since uncontained sparking may cause a fire.

 **Warning!**

To reduce the risk of fire and burn injury, use only spark plugs authorized by STIHL. Always press spark plug boot snugly onto spark plug terminal of the proper size. (Note: If terminal has detachable SAE adapter nut, it must be attached.) A loose connection between spark plug terminal and ignition wire connector in the boot may create arcing that could ignite combustible fumes and cause a fire. Keep spark plug clean, and make sure ignition lead is in good condition.

 **Warning!**

Do not operate your chainsaw if the muffler is damaged, missing or modified. An improperly maintained muffler will increase the risk of fire and hearing loss. Never touch a hot muffler or burn will

result. If your muffler was equipped with a spark-arresting screen to reduce the risk of fire (e. g. in the USA, Canada and Australia), never operate your saw if the screen is missing or damaged. Remember that the risk of forest fires is greater in hot or dry weather.

Keep the chain, bar and sprocket clean; replace worn sprockets or chains.

Keep the chain sharp.

You can spot a dull chain when easy-to-cut wood becomes hard to cut and burn marks appear on the wood.

Keep the chain at proper tension. Tighten all nuts, bolts and screws except the carburetor adjustment screws after each use.

 **Warning!**

In order for the chain brake on your STIHL chainsaw to properly perform its function of reducing the risk of kickback and other injuries, it must be properly maintained. Like an automobile brake, a chainsaw chain brake incurs wear each time it is engaged.

The amount of wear will vary depending upon usage, conditions under which the saw is used and other factors. Excessive wear will reduce the effectiveness of the chain brake and can render it inoperable.

For the proper and effective operation of the chain brake the brake band and clutch drum must be kept free of dirt, grease and other foreign matter which may reduce friction of the band on the drum.

For these reasons, each STIHL chainsaw should be returned to trained personnel such as your STIHL servicing dealer for periodic inspection and servicing of the brake system according to the following schedule:  
Heavy usage - every three months,  
Moderate usage - twice a year,  
Occasional usage - annually.

The chainsaw should also be returned immediately for maintenance whenever the brake system cannot be thoroughly cleaned or there is a change in its operating characteristics.

For any maintenance please refer to the maintenance chart **and to the warranty statement** near the end of this manual.

Additionally, the daily maintenance schedule for your chainsaw set forth in your STIHL Owner's Manual should be strictly followed.

Store chainsaw in a dry place and away from children. Before storing for longer than a few days, always empty the fuel tank (see chapter "Storing the Machine" in this manual).

## Mounting the Bar and Chain

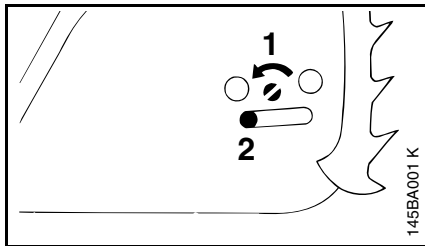
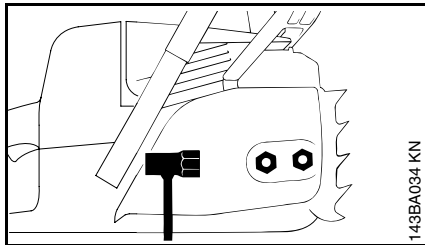

You can run chains of different pitches on this chainsaw - depending on the chain sprocket (see "Specifications")

The chain pitch must match the guide bar. In addition, the drive link gauge must match the guide bar groove width.

- Turn tensioning screw (1) counter-clockwise until the tensioner slide (2) butts against left end of housing slot.

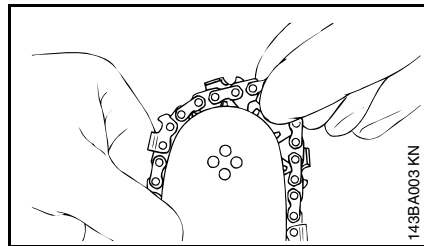
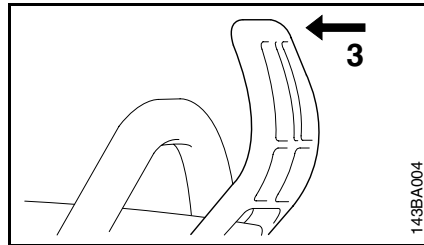

Disengage the chain brake:  
Pull hand guard (3) toward the front handle.

- Wear work gloves to protect hands
- Fit the chain - start at the bar nose.

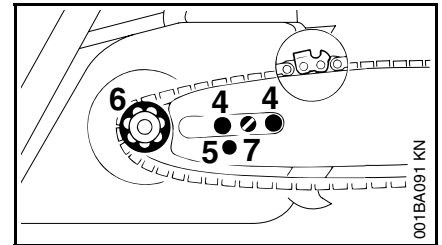

Fit the guide bar over the studs (4) - cutting edges on top of bar must point to right - and engage the peg of the tensioner slide in locating hole (5) - place the chain over sprocket (6) at the same time - Now turn tensioning screw (7) clockwise until there is very little chain sag on the underside of the bar - and the drive link tangs are located in the bar groove.

- Refit the sprocket cover - and screw on the nuts only finger-tight.
- Tensioning the chain - see section "Tensioning the Saw Chain".

## Tensioning the Saw Chain

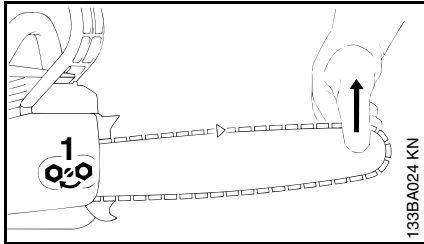

Retensioning during cutting work:

- Turn off the engine - and then slacken the nuts.
- Hold the bar nose up - and use screwdriver to turn tensioning screw **(1)** clockwise until chain fits snugly against the underside of the bar - while still holding bar nose up, tighten down the nuts **firmly**.

A new chain has to be retensioned more often than one that has been in use for some time -  
check chain tension frequently -  
see section "During Operation".

## Checking Chain Tension

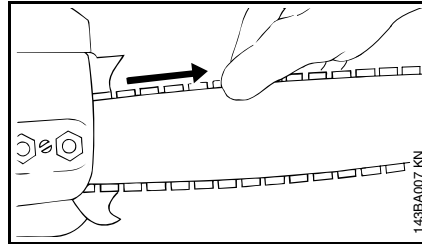

- Turn off the engine -
- Wear work gloves.

Chain must fit snugly against the underside of the bar - and, with the chain brake disengaged, it must still be possible to pull the chain along the bar by hand.

- If necessary, retension the chain.

A new chain has to be retensioned more often than one that has been in use for some time -  
check chain tension frequently -  
see section "During Operation".

## Fuel Mix

This engine is certified to operate on unleaded gasoline and oil with the mix ratio 50:1.

Your two-stroke engine requires a mixture of brand-name gasoline and quality two-stroke engine oil with the **classification TC**.

Use regular branded unleaded gasoline with a minimum octane rating of 90 ROZ (U.S.A./Canada: pump octane min. 89!). If the octane number of the regular grade gasoline in your area is lower, use premium unleaded fuel. Fuel with a lower octane rating may result in preignition (causing "pinging") which is accompanied by an increase in engine temperature. This, in turn, increases the risk of piston seizure and damage to the engine.

The chemical composition of the fuel is also important. Some fuel additives not only detrimentally affect elastomers (carburetor diaphragms, oil seals, fuel lines etc.), but magnesium castings as well. This could cause running problems or even damage the engine. For this reason it is essential that you use only branded fuels!

Use only STIHL two-stroke engine oil or equivalent branded two-stroke air-cooled engine oils with the classification TC for mixing.

## Fueling



We recommend STIHL 50:1 two-stroke engine oil since it is specially formulated for use in STIHL engines. Do not use BIA or TCW (two-stroke water cooled) mix oils!

Take care when handling gasoline. Avoid direct contact with the skin and avoid inhaling fuel vapour (see “Safety Precautions”).

The canister should be kept tightly closed in order to avoid any moisture getting into the mixture.

The fuel tank and the canister in which fuel mix is stored should be cleaned from time to time.

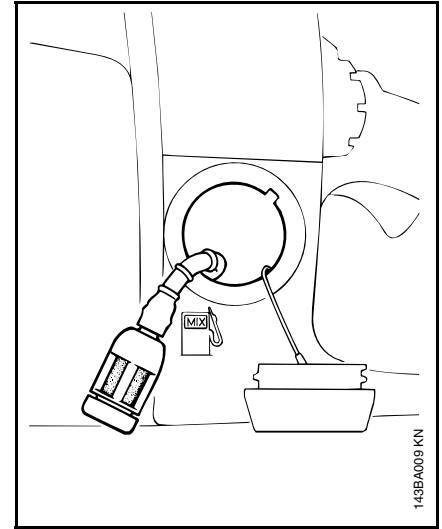
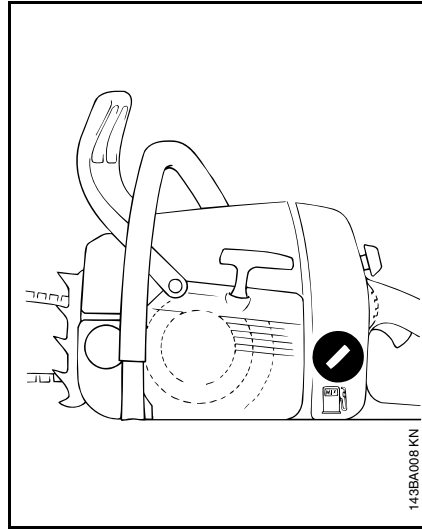

### Fuel mix ages:

Only mix sufficient fuel for a few days work, not to exceed 3 months of storage. Store in approved safety fuel-canisters only. When mixing, pour oil into the canister first, and then add gasoline.

Gasoline            Oil (STIHL 50:1 or equivalent branded TC oils)

US gal.            US fl.oz

1	2.6
2 1/2	6.4
5	12.8

Dispose empty mixing-oil canisters only at authorized disposal locations.

Before fueling, clean the fuel filler cap and the area around it to ensure that no dirt falls into the tank. Always thoroughly shake the mixture in the canister before fueling your machine.



### Warning!

In order to reduce the risk of burns or other personal injury from escaping gas vapor and fumes, remove the fuel filler cap carefully so as to allow any pressure build-up in the tank to release slowly.



### Warning!

After fueling, tighten fuel cap **as securely as possible** by hand. Use a suitable tool (e.g. screwdriver end of combination wrench) to tighten slotted fuel caps.

Change the fuel pick up body every year.

Before storing your machine for a long period, drain and clean the fuel tank and run engine until carburetor is dry.

## Chain lubricant

For automatic and reliable lubrication of the chain and guide bar:

**Use only a quality, environmentally compatible chain and bar lubricant. STIHL chain lubricant with non-fling additive or the rapidly biodegradable STIHL Bioplus is recommended.**

**Important:** Biological chain oil must be resistant to aging (e.g. STIHL Bioplus) since it will otherwise quickly turn to resin. This results in hard deposits that are difficult to remove, especially in the area of the chain drive, clutch and chain. It may even cause the oil pump to seize.

The service life of the chain and guide bar depends on the quality of the lubricant. It is therefore essential to use only a specially formulated chain lubricant.

If special chain lubricant is not available, you may - in an emergency - use an HD single grade or multigrade engine oil with a viscosity that suits the prevailing outside temperature.



### Warning!

Medical studies have shown that renewed contact with waste oil can cause skin cancer. Avoid direct contact with waste oil. If waste oil does get on your skin, wash with soap and water. **Do not use** waste oil for any purpose, and dispose of it only at authorized disposal locations.

## Filling Chain Oil Tank

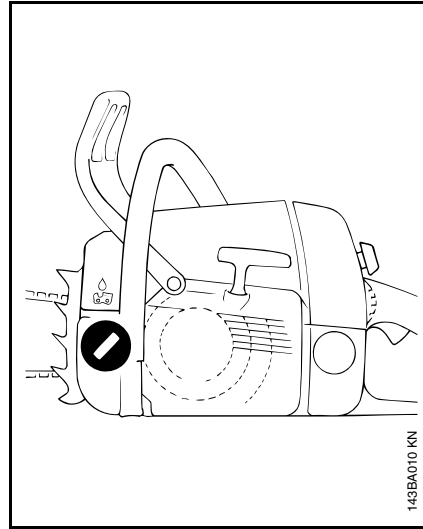

- Thoroughly clean the oil filler cap and the area around it to ensure that no dirt falls into the tank.
- Refill the chain oil tank every time you refuel.

There must still be a small amount of oil in the oil tank when the fuel tank is empty.

If the oil tank is still partly full, the reason may be a problem in the oil supply system:

Check chain lubrication, clean the oil passages, contact your STIHL dealer for assistance if necessary.

## Checking Chain Lubrication

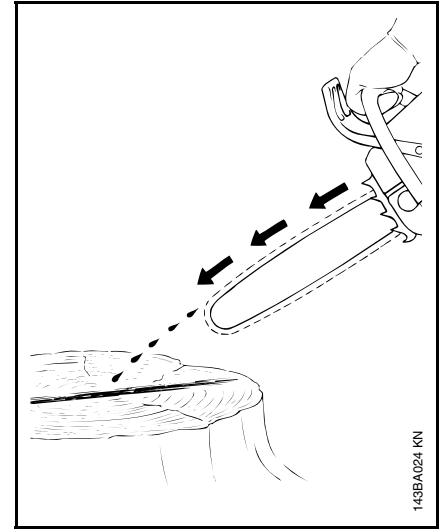

The saw chain must always throw off a small amount of oil.

- Never operate your saw without chain lubrication. If the chain is run dry, the whole cutting attachment will be irretrievably damaged within a very short time. Always check chain lubrication and oil level in tank before starting work.
- Every new chain has to be broken in for about 2 to 3 minutes.

After breaking in chain, check chain tension and adjust if necessary - see section "Checking Chain Tension".

## Chain Brake

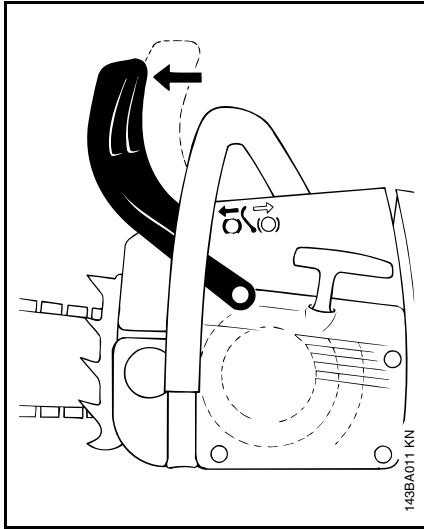
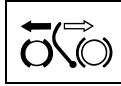

### Locking chain with chain brake

- in an emergency
  - when starting
  - at idling speed.
- The chain is stopped and locked when the hand guard is pushed toward the bar nose by the left hand - or when brake is activated by inertia in certain kickback situations.

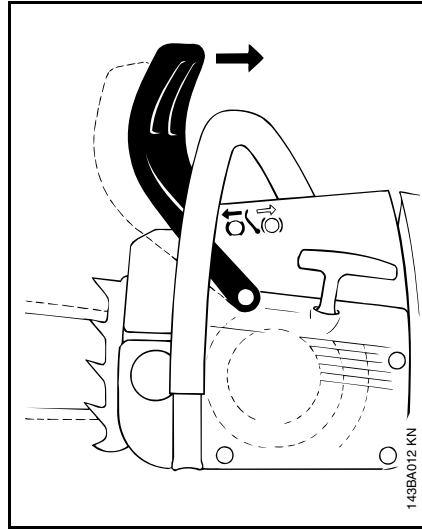

### Releasing the chain brake

- Pull the hand guard back toward the front handle.

**Note:** Always disengage chain brake before accelerating engine and before starting cutting work. The only exception to this rule is when you check operation of the chain brake. High revs with the chain brake engaged (chain locked) will quickly damage the powerhead and chain drive (clutch, chain brake).

**The chain brake is also activated by the inertia of the front hand guard** if the kickback force of the saw is high enough:

The hand guard is accelerated toward the bar nose - even if your left hand is not behind the hand guard, e.g. during felling cut.

The chain brake will operate only if the hand guard has not been modified in any way.

### Check operation of chain brake

Before starting work: Run engine at idle speed, engage the chain brake (push hand guard toward bar nose). Accelerate up to full throttle for no more than 3 seconds - the chain must not rotate. The hand guard must be free of dirt and move freely.

### Chain brake maintenance

The chain brake is subject to normal wear and tear. It must therefore be checked and serviced regularly by trained personnel (e.g. STIHL dealer) at the following intervals:

Full-time professional users:	every 3 months
Semi-professional users:	every 6 months
Occasional users:	every 12 months

## Information Before You Start - don't start the engine yet! -

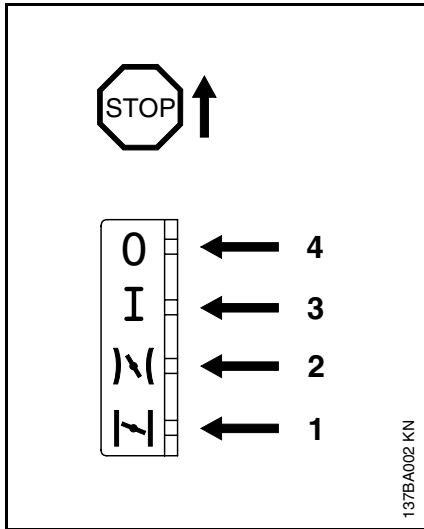

### The four positions of the Master Control lever

To start the engine, move the lever to "Cold Start" position (1) - do not use force.

If the Master Control lever is on "Run" (3): Press down the throttle trigger interlock - and move the Master Control lever downward.

"Cold Start" position: Choke shutter is closed - throttle trigger is in starting-throttle position. A cold engine should be started in this position.

As soon as engine begins to fire, move the Master Control lever to "Warm Start" position (2):

Move the Master Control lever one notch upward.

"Warm Start" position:

Choke shutter is open - throttle trigger is in starting-throttle position.

If you leave the Master Control lever in the "Cold Start" position, the combustion chamber will flood and stall the engine.

The Master Control lever must be in "Warm Start" position (2) to start a warm engine. Also select this position if engine has been running but is still cold.

The Master Control lever should not be forced to "Run" position (3) - it will move to "Run" as soon as the throttle trigger is activated. In the "Warm Start" position, continue cranking after engine begins to fire. As soon as the engine runs, **immediately** blip the throttle trigger so that the Master Control lever moves to "Run" - idling position - normal operating position (3).

### To shut down the engine:

Move the Master Control lever upward to "STOP" position (4):

The stop contact should engage the contact spring - this cuts off the ignition system.

## Starting

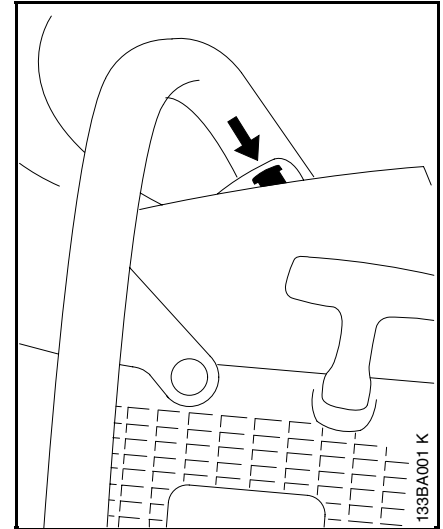

### Only machines with decompression valve:

- Press in the button (arrow) to open the decompression valve.

The valve closes automatically as soon as the engine begins to fire.

- For this reason the button should be pressed in before each starting attempt.



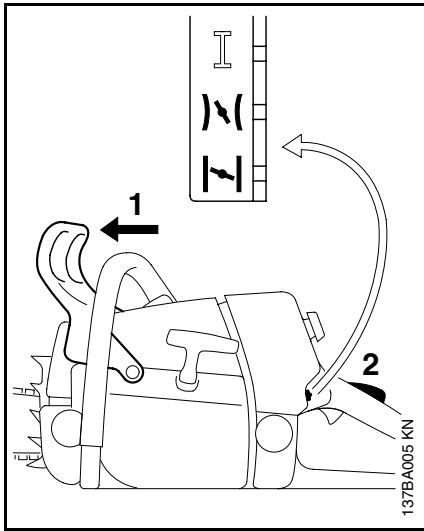

### All other versions

- Observe safety precautions - see section "Safety Precautions". Push hand guard forward (1): The chain is now locked - Press throttle trigger interlock (2)
- Master Control lever to:

For cold start 

For warm start 

(even if engine has been running but is still cold)

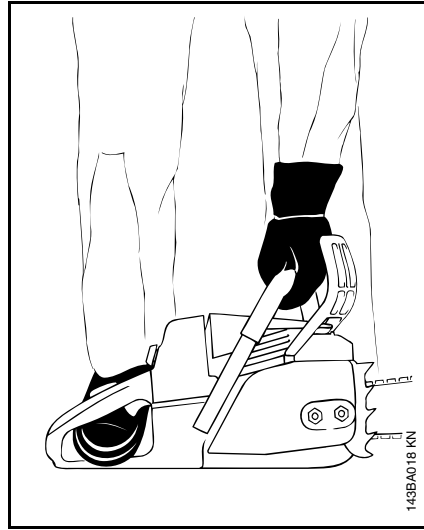

- Place your saw on the ground - make sure you have a firm footing - check that chain is not touching any object or the ground - bystanders must be well clear of general work area of the saw -
- Hold the saw firmly on the ground with your left hand on the front handle - your thumb should be under the handle -
- put your right foot into the rear handle and press down.

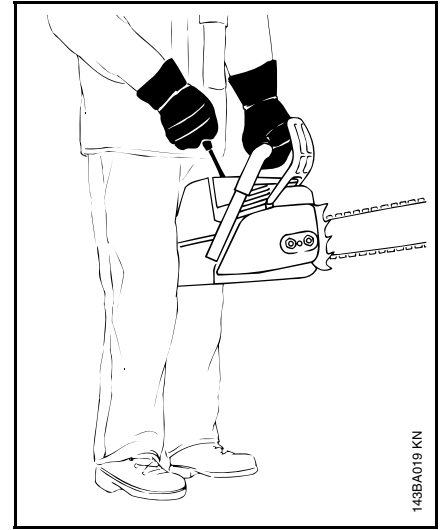

- Alternative method of starting:
- Hold the rear handle tightly between your legs, just above the knees -
- grip the front handle firmly with your left hand - your thumb should be under the handle -

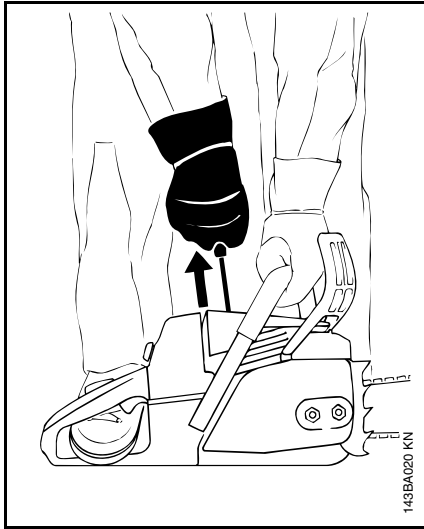

- Pull the starter grip slowly with your right hand until you feel it engage - then give the grip a brisk strong pull and push down the front handle at the same time - do not pull out starter rope more than 70 cm (about 28 in) - it might otherwise break. Do not let the starter grip snap back - guide it slowly into the housing so that the starter rope can rewind properly. If engine is new, pull starter grip several times to prime the fuel line.

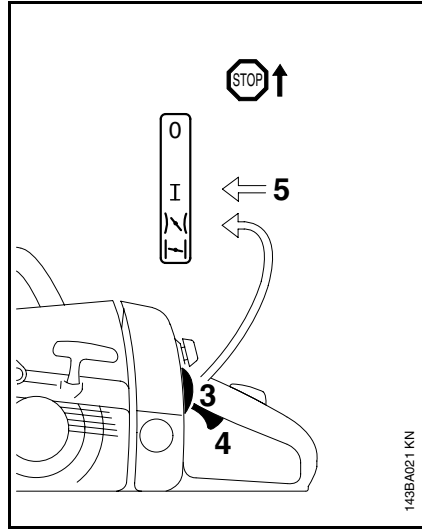

When engine begins to fire:  
Move Master Control lever (3) to 

and continue cranking -  
**as soon as engine runs, immediately** blip the throttle trigger (4) - the Master Control lever (3) will move to "Run" position (5)  and the engine settles down to idle speed.

As the chain brake is still engaged, the engine must be returned to idle speed **immediately** to avoid damage to the engine and chain drive (clutch, chain brake).

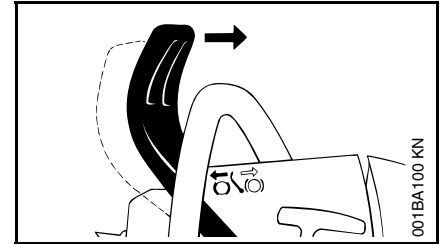

- Pull the hand guard back toward the front handle :  
The chain brake is now disengaged - your saw is ready for operation.

Always disengage chain brake before accelerating engine and before starting cutting work. High revs with the chain brake engaged (chain locked) will quickly damage the powerhead and chain drive (clutch, chain brake).

- Observe safety precautions.
- Always check operation of chain lubrication before starting work.

To turn off engine:

- Move Master Control lever to "Stop" position 

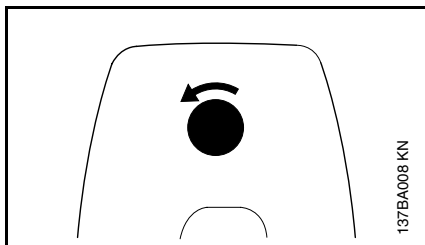

**At very low outside temperatures:  
Allow engine to warm up**

As soon as the engine runs:

- Blip the throttle trigger to disengage it from starting throttle position - Master Control lever will move to normal operating position - engine settles down to idle speed.
- Disengage chain brake:  
Pull hand guard toward front handle - as shown in illustration -
- Open throttle slightly - warm up engine for short period.
- Change over to winter operation if necessary - see section "Winter Operation".

**If engine doesn't start:**

If you did not move the Master Control lever to "Warm Start" quickly enough after the engine began to fire, the combustion chamber has flooded.

- Turn the knob above the rear handle counterclockwise -

- Pull off the spark plug boot.
- Unscrew and dry off the spark plug.-
- Set the Master Control lever to  t
- Press down the throttle trigger interlock, open the throttle fully and, at the same time, crank the engine several times with the starter to clear the combustion chamber.
- Refit the spark plug and connect the spark plug boot - reassemble all other parts
- Set Master Control lever to "Warm Start" even if engine is cold.
- Press in decompression valve again.
- Now start the engine.

**Fuel tank run until dry and then refueled**

- Press in decompression valve again.
- Pull starter rope several times until fuel line is primed.

**Oil Quantity Control**

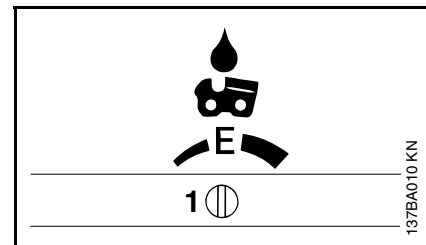
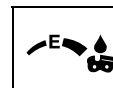

Different quantities of oil are required for different bar lengths, types of wood and cutting techniques.

Use the adjusting screw (1) to vary the oil feed rate as required.

- Most economic setting - turn adjusting screw to "E" (*E*matic position).
- To increase oil feed - turn adjusting screw clockwise.  
To reduce oil feed - turn adjusting screw counterclockwise.

## During Break-in Period

A factory new machine should not be run at high revs (full throttle off load) for the first three tank fillings. This avoids unnecessary high loads during the break-in period.

As all moving parts have to bed in during the break-in period, the frictional resistances in the engine are greater during this period. The engine develops its maximum power after about 5 to 15 tank fillings.

**Do not make the mixture leaner to achieve an apparent increase in power - this could damage the engine - see section "Adjusting Carburetor".**

**Note:** Always disengage chain brake before accelerating engine and before starting cutting work. High revs with the chain brake engaged (chain locked) will quickly damage the powerhead and chain drive (clutch, chain brake).

## During Operation

### **Check chain tension frequently.**

A new chain has to be retensioned more often than one that has been in use for some time.

### **Chain cold:**

Tension is correct when chain fits snugly against the underside of the bar and can still be pulled along the bar by hand.

Retension if necessary - see section "Tensioning the Saw Chain".

### **Chain at operating temperature:**

The chain stretches and begins to sag. The drive links must not come out of the bar groove - the chain may otherwise jump off the bar.

Retension the chain - see section "Tensioning the Saw Chain".

Always slacken off the chain after finishing work.

The chain contracts as it cools down. If it is not slackened off, it can damage the crankshaft and bearings.

### **After long period of full-throttle operation**

Allow engine to run for a short while at idling speed so that engine heat can be dissipated by flow of cooling air. This protects engine-mounted components (ignition, carburetor) from thermal overload.

## After Finishing Work

### **Slacken off the chain**

if you have retensioned it at operating temperature during cutting work.

The chain contracts as it cools down. If it is not slackened off, it could damage the crankshaft and bearings.

### **Before storing your saw for a long period -**

- Drain and clean the fuel tank
- Run engine until carburetor is dry

## Storing the Machine

For periods of about 3 months or longer:

- Drain and clean the fuel tank in a well ventilated area.
- Run engine until carburetor is dry - this helps prevent the carburetor diaphragms sticking together.
- Remove the saw chain and guide bar, clean them and protect with corrosion inhibiting oil.
- Thoroughly clean the machine - pay special attention to the cylinder fins and air filter.
- If you use a biological chain lubricant (e.g. STIHL Bioplus), fill the chain oil tank.
- Store the machine in a dry and high or locked location - out of the reach of children and other unauthorized persons.

## Air Filter System

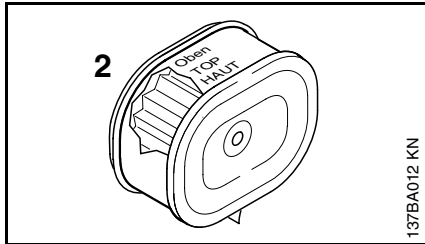
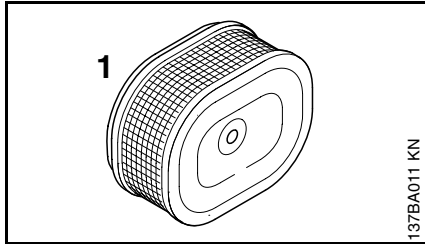

Dirty air filters reduce engine power, increase fuel consumption and make starting more difficult.

The air filter system can be adapted to suit different operating conditions by simply installing a choice of filters.

**Standard** wire mesh filter **(1)** (green) for normal operating conditions and winter operation.

**HD filter (2)** (black) for dry and very dusty work areas.

### Note:

STIHL standard and HD filters have a long wear life when used in a **dry condition**. Therefore, always use and keep STIHL filters dry.

## Remove the Filter

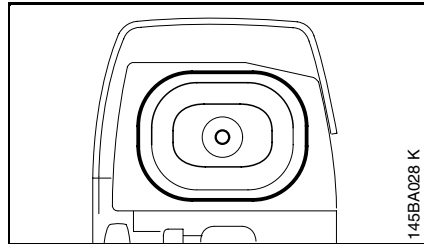
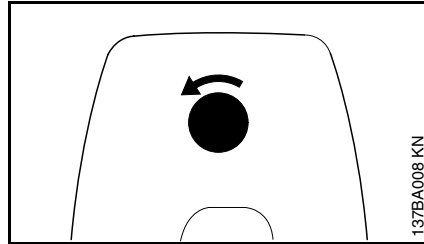

- Undo the knob above the rear handle in direction of arrow and remove the carburetor box cover.
- Pull off the filter.

## Cleaning Standard Filter

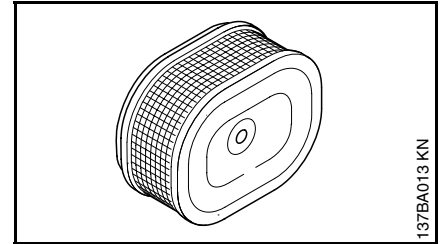

### When there is a noticeable loss of engine power

- Knock the filter out on the palm of your hand or blow it out with compressed air from the inside outward.

In case of stubborn dirt or sticky filter fabric:

- Wash the filter in a fresh, non-flammable solution (e.g. warm soapy water) and then dry.
- **Do not** impregnate standard wire mesh filter with oil.

Always replace a damaged filter element.

- Refit the filter.

## Cleaning HD Filter

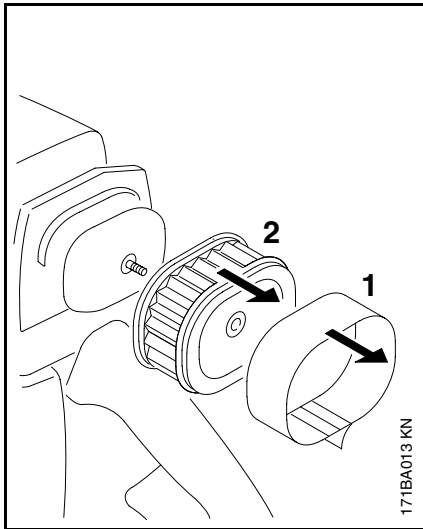

Clean the felt prefilter (1) when there is a noticeable loss of engine power

After cleaning prefilter several times:

- Separate the filter components
- Knock out the HD-filter (2) on the palm of your hand or blow it out with compressed air from the inside outward.

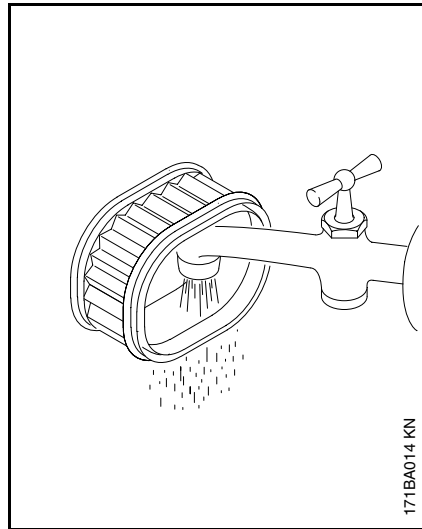

In case of stubborn dirt or sticky filter fabric:

- Wash with STIHL universal cleaner or in a clean, non-flammable cleaning solution (e.g. warm soapy water). Rinse the filter, from the inside outward, under a low-pressure water jet. **Do not use** a high-pressure washer.
- Dry all parts of the filter. **Do not expose** to high temperatures.

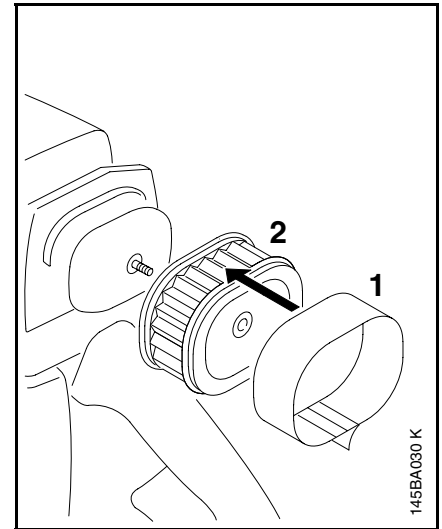

- Fit the felt prefilter (1) over the HD filter (2)
  - note correct installed position
- Install HD filter (with felt prefilter) and carburetor box cover.
- Check carburetor setting and readjust if necessary.

The felt prefilter helps protect the HD filter and thus extends its useful life. For this reason the felt prefilter should be replaced at more frequent intervals than the HD filter.

Always replace a damaged filter.

## Winter Operation

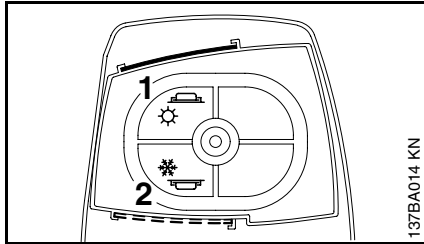

**At temperatures below +10 °C/+50°F - preheat carburetor as follows:**

- Remove the carburetor box cover.

Inside the carburetor box cover:

Move shutter (1) from **summer** position to **winter** position (2).

Heated air is now drawn in from around the cylinder and mixed with cold air - this helps prevent carburetor icing.

**At temperatures above +20 °C/+70°F:**

Return shutter to **summer** position.

This is essential to avoid engine running problems and overheating.

### Machines with HD filter:

- Install a standard filter element in place of the HD filter.
- Refit the carburetor box cover and tighten down the knob.

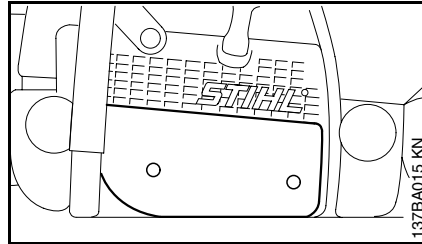

**At temperatures below -10°C (+14°F):**

It is advisable to fit the cover plate\* on the fan housing if you use your saw in extremely cold conditions (temperatures below -10°C/+14°F, in powder or drifting snow).

The cover plate blanks off the lower slots in the fan housing to help prevent snow being sucked into the machine.

When the cover plate is fitted, the shutter in the carburetor box cover must be moved to the winter position.

- If your saw is very cold (frost or ice on machine), start the engine and keep it at a high idle speed (with chain brake disengaged) until it reaches normal operating temperature.
- In the event of engine running problems, first check that conditions for use of intake air preheating still apply.

\*Special accessory

## Electric Handle Heating

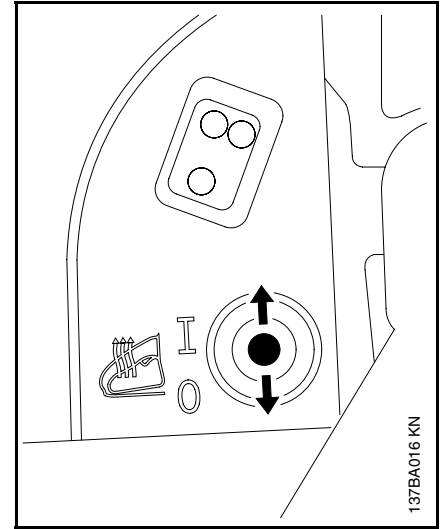

Switching on electric handle heating

- Move switch on front handle to **I**
- Move switch back to **O** to switch off heating.

There is no risk of overheating during long periods of operation. The whole heating system is maintenance-free.

\*Special accessory

## Take Care of Guide Bar

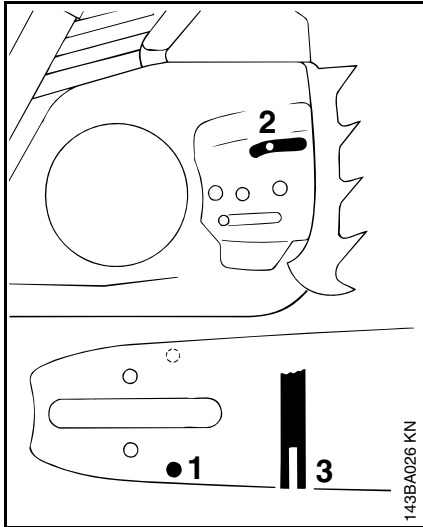

Chain type	Pitch	Minimum groove depth
Rapid	3/8"	6.0 mm (0.24")
Rapid	0.404"	7.0 mm (0.27")

If groove depth is less than specified:  
**Replace the guide bar.**

The drive link tangs will otherwise scrape along the bottom of the groove -  
 the cutters and tie straps will not ride on the bar rails.

- Turn the bar over - every time you sharpen the chain - and every time you replace the chain - this avoids one-sided wear, especially at nose and underside of the bar.

Regularly clean

- 1 = oil inlet hole
- 2 = oilway
- 3 = bar groove.

- **Measure groove depth** - with scale on filing gauge\* - at nose of Duromatic bars - in area used most for cutting on Rollomatic bars -

\*Special accessory



# Adjusting Carburetor

## Motor management

Exhaust emissions are controlled by the design of the fundamental engine parameters and components (e.g. carburetion, ignition, timing and valve or port timing) without the addition of any major hardware.

The carburetor is set at the factory to provide an optimum fuel-air mixture under all operating conditions.

It enables your machine to run smoothly, be fuel efficient, operate reliably and produce low emissions.

## Standard setting and explanation of setting pictograms

- Check the air filter and clean or replace it if necessary
- Check the spark arresting screen and clean or replace it if necessary

 Turn the high speed adjusting screw (**H**) counterclockwise up to the stop, i.e. 3/4 turn from max. lean setting

 Turn the low speed adjusting screw (**L**) clockwise up to the stop - then back off the screw one quarter of a turn

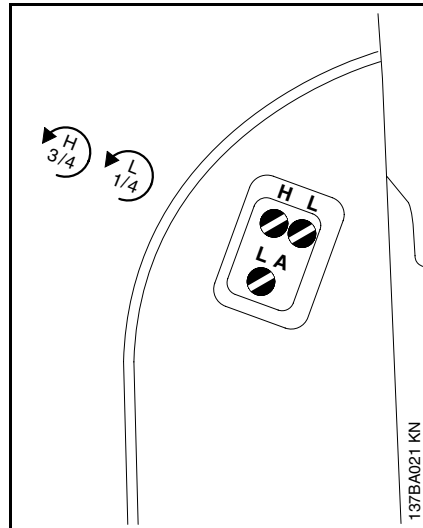

## Correction of carburetor setting for higher altitudes

If the engine runs unsatisfactorily, slight readjustment may be necessary:

- Check standard setting
- warm up the engine

Turn the high speed adjusting screw (**H**) and low speed adjusting screw (**L**) clockwise (leaner) -

## Warning!

If you make the setting too lean, the maximum permissible engine speed will be exceeded - risk of engine damage.

## Setting idle speed

It is usually necessary to change the setting of the idle speed adjusting screw (**LA**) after every correction to the low speed adjusting screw (**L**).

## Engine stops while idling

- Turn the idle speed adjusting screw (**LA**) clockwise until chain begins to run - then back off the screw one quarter of a turn

## Chain runs when engine is idling

- Turn the idle speed adjusting screw (**LA**) counterclockwise until chain stops running - then turn screw another quarter turn in the same direction

## Erratic idling behavior, poor acceleration

Idle setting is too lean

- Turn the low speed adjusting screw (**L**) counterclockwise - no further than stop - until engine runs and accelerates smoothly -

## Spark Arresting Screen in Muffler

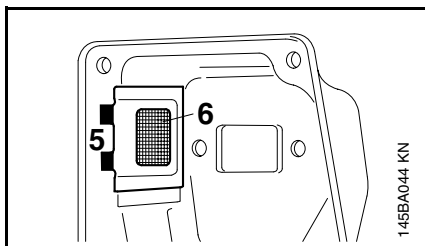
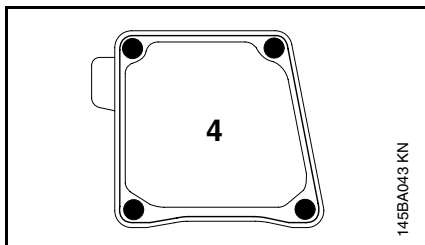

If engine is down on power, check the spark arresting screen in the muffler:

- Allow muffler to cool down.
- Take out the four screws.
- Remove the muffler upper casing (4).
- Bend back the retaining tabs (5).
- Pull out the spark arresting screen (6).
- Clean spark arresting screen if necessary. If screen is damaged or coked up, fit a new one.
- Refit the spark arresting screen in the reverse sequence.

## Checking Spark Plug

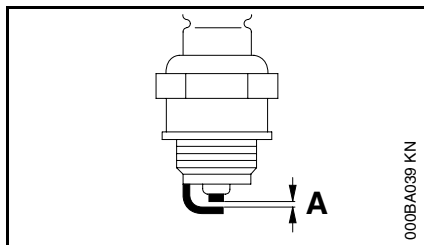

Wrong fuel mix (too much engine oil in the gasoline), a dirty air filter and unfavorable running conditions (mostly at part throttle etc.) affect the condition of the spark plug. These factors cause deposits to form on the insulator nose which may result in trouble in operation.

If engine is down on power, difficult to start or runs poorly at idling speed, first check the spark plug.

- Remove spark plug - see chapter "Starting":
- Clean dirty spark plug.
- Check electrode gap - it should be 0.5mm/0.02" (A) - readjust if necessary.
- Use only resistor type spark plugs of the approved range.

Rectify problems which have caused fouling of spark plug:  
 Incorrect carburetor setting, too much oil in fuel mix, dirty air filter, unfavorable running conditions, e.g. operating at part load.

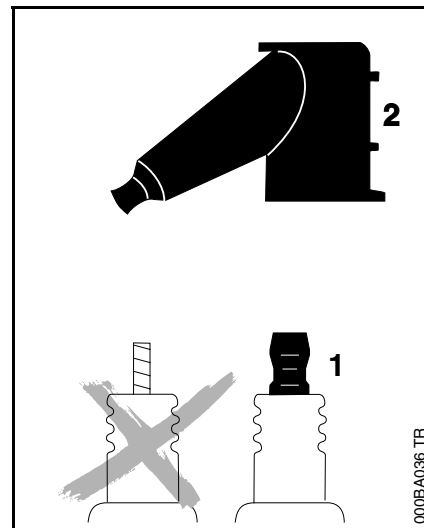

- Fit a new spark plug after approx. 100 operating hours - or earlier if the electrodes are badly eroded.

### **Warning!**

To reduce the risk of fire and burn injury, use only spark plugs authorized by STIHL (see "Specifications"). Always press spark plug boot (2) snugly onto spark plug terminal (1) of the proper size. (Note: If terminal has detachable SAE adapter nut, it must be attached.) A loose connection between spark plug terminal and ignition wire connector in the boot may create arcing that could ignite combustible fumes and cause a fire.

## Replacing Starter Rope and Rewind Spring

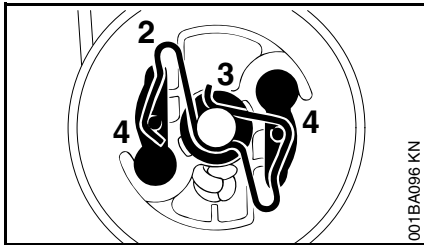
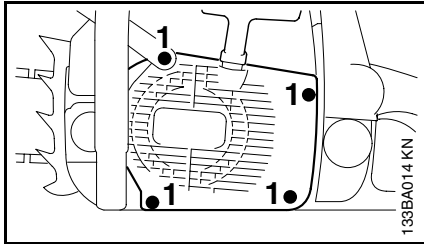

- Remove screws (1) -
- push the hand guard upward - pull underside of fan housing away from crankcase and remove it downward
- Use screwdriver or suitable pliers to carefully remove the spring clip (2) from the starter post -
- Now remove the rope rotor with washer (3) and pawls (4) .

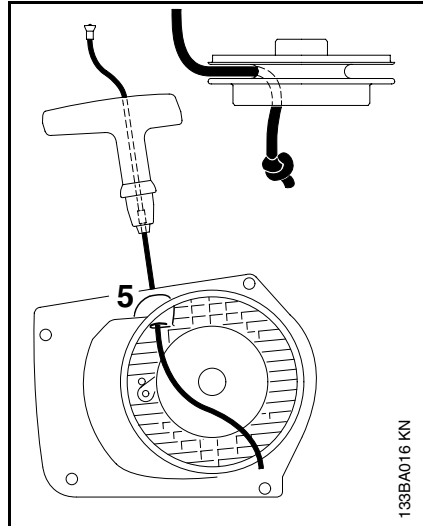

- Use a screwdriver to pry the rope out of the starter grip
- Remove remaining rope from the rotor and starter grip  
Thread the new rope - Part No. 1122 190 2900 - through the top of the starter grip and then pull through the rope guide bush (5).
- Thread the rope through the rotor and secure it with a simple over-hand knot.
- Coat rope rotor bearing bore with non-resinous oil.
- Slide rotor onto starter post - turn it back and forth so that anchor loop of rewind spring engages -

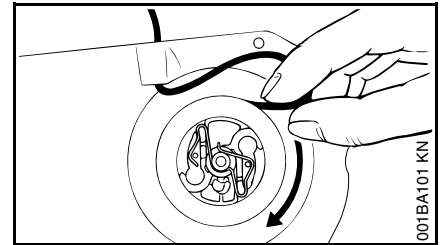
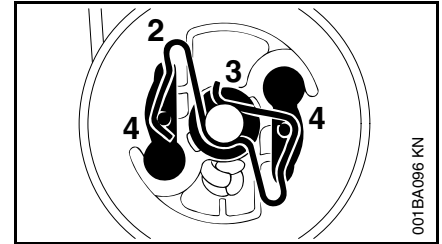

- Refit the pawls (4) in the rotor -
- Fit the washer (3) on the starter post
- Use screwdriver or suitable pliers to install spring clip (2) on starter post and over the pawl pegs - the spring clip must point in clockwise direction - see illustration.

### Tensioning rewind spring

- Make a loop in the starter rope and use it to turn the rope rotor six full revolutions in the direction of the arrow
- Hold the rotor steady - straighten the twisted rope -

## Checking and Replacing Chain Sprocket

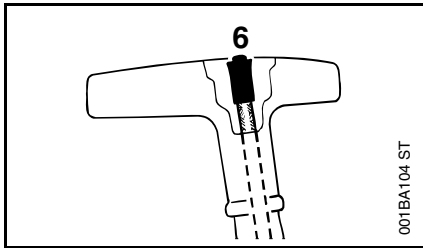

- Release the rotor -
- Let go of rope slowly so that it winds onto the rotor.
- The starter grip must sit firmly in the rope guide bush. If the grip droops to one side: Increase spring tension by one additional turn.
- When starter rope is fully extended it must be possible to rotate the rotor at least another half turn. If this is not the possible, the spring is over-tensioned and could break. Take off one turn of the rope.
- Fit the fan housing on the crankcase.
- Set the Master Control lever to Push the remaining rope into the starter grip so that the nipple (6) is flush with the grip.

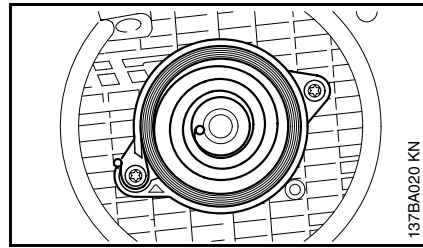

### Replacing a broken rewind spring

- Lubricate the new spring with a few drops of non-resinous oil -
- Remove the rope rotor - see "Replacing Starter Rope" -

The bits of spring in the fan housing might still be under tension and could fly apart when you take them out of the housing. To avoid risk of injury, wear eye and face protection and work gloves.

- Remove the spring housing and parts of spring.
- Fit the new spring housing - bottom plate must face upward - slip outer spring loop over lug -
- Reinstall the rope rotor, tension the rewind spring, fit the fan housing and secure it in position. If the spring pops out of its housing during installation: refit it in the counterclockwise direction, starting outside and working inward.

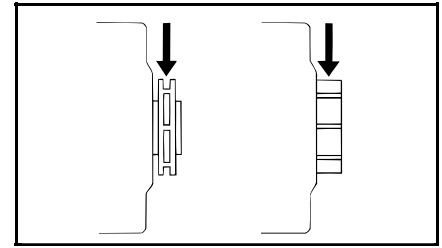

### Replace the chain sprocket after using two Oilomatic chains

or sooner if the wear marks on the sprocket are deeper than approx. 0.5 mm ( $\frac{1}{64}$ " ) since this would reduce the life of the chain.

Check wear marks:

Left: on webs of rim sprockets -  
Right: on teeth of spur sprockets.

You can use gauge\* 0000 893 4101 to check the depth of the wear marks on spur and rim sprockets. It is best to use two chains in rotation with one sprocket.

### Before removing chain sprocket

Remove chain sprocket cover, chain and guide bar. Disengage the chain brake: Pull hand guard toward front handle.

\*Special accessory



## Maintaining and Sharpening Saw Chain

### Correctly sharpened chain

A properly sharpened chain slices through wood effortlessly and requires very little feed pressure.

Do not work with a dull or damaged chain as it will increase the physical effort required, produce unsatisfactory results and a higher rate of wear.

### Clean and check your chain

for cracks in the links and damaged rivets -  
replace any damaged or worn parts of the chain and match the new parts to the shape and size of the original parts.

**Important:** It is absolutely imperative to comply with the angles and dimensions specified below. If the **saw chain is incorrectly sharpened** - and in particular if the depth gauge is set too low - there is a risk of increased kickback of the chainsaw, with resulting **danger of injury**.

### Select the appropriate sharpening tools for the chain pitch.

See "Technical Data" for the permitted chain pitches.

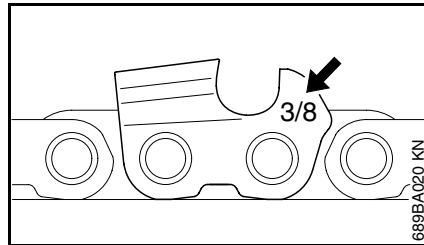

The chain pitch (e.g. 3/8) is marked on the depth gauge side of each cutter.

### Use only special saw chain files

Other files have the wrong shape and cut.

Select file diameter according to chain pitch - see table at the end of this chapter.

You must observe certain angles when sharpening the chain cutters

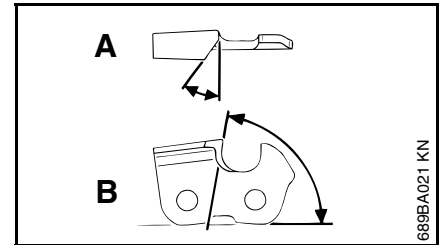

**A** = Filing angle

**B** = Side plate angle

Chain type	Angle (°)	
	A	B
Rapid-Micro (RM)	30	85
Rapid-Super (RS)	30	60
Picco-Micro (PM/PMN)	30	85

Cutter shapes:

Micro = Semi-chisel

Super = Full chisel

**Specified angles A and B are obtained automatically if recommended files or sharpening tools and correct settings are used.**

Furthermore, the angles must be the same on all cutters.

If angles are uneven:

Chain will run roughly, not in a straight line, wear quickly and finally break.

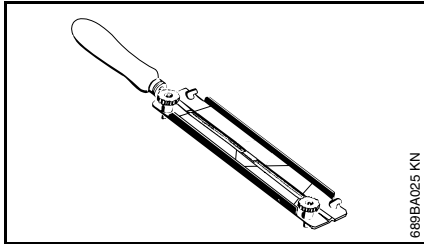

As these requirements can be met only after sufficient and constant practice:

#### Use a file holder.\*

A file holder must be used for manual sharpening of Super chain. The correct filing angle is marked on the file holder.

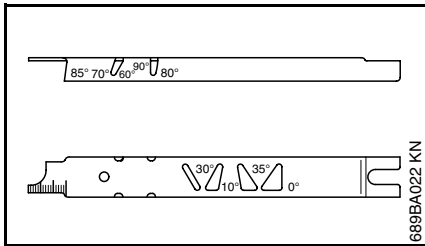

#### For checking angles

STIHL filing gauge\* (see table)

A universal tool for checking the filing and side plate angles, depth gauge setting and cutter length. Also cleans the guide bar groove and oil inlet hole.

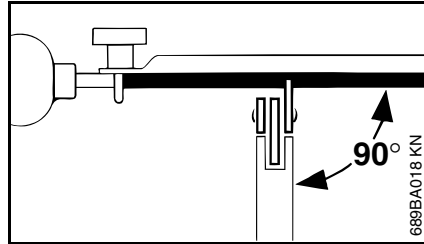

#### File correctly

- If you use a file holder or the FG 1: Leave the chain on the bar.
- Clamp the bar in a vise if necessary.
- Lock the chain - push hand guard forward
- To rotate the chain - pull hand guard against front handle
- Sharpen chain frequently, take away as little metal as possible - two or three strokes of the file are usually enough
- Always file from the inside to the outside of the cutter.
- The file only sharpens on the forward stroke - lift the file off the cutter on the back-stroke.
- Hold the file **horizontally** for all chain types (at right angle to side of guide bar) and file according to the angles marked on the filing tool.

- Avoid touching the tie straps and drive links with the file.
- Rotate the file at regular intervals while filing - this avoids one-sided wear.
- Use a piece of hardwood to remove burrs from cutting edge.
- Check angles with the filing gauge.

#### All cutters must be the same length

If the cutters are not the same length, they will have different heights. This makes the chain run roughly and can cause it to break.

Find the shortest cutter and then file all other cutters back to the same length. This can be very time consuming - it is best to have it done in the workshop on an electric grinder.

\* Special accessory

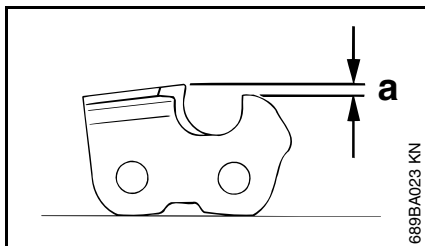

### Depth gauge setting

The depth gauge determines the height at which the cutter enters the wood and thus the thickness of the chip removed.

Distance between depth gauge and cutting edge = a:

Chain pitch		Depth gauge distance "a"	
Inch	(mm)	mm	(Inch)
1/4	(6.35)	0.65	(0.026)
3/8-PM	(9.32)	0.65	(0.018)
3/8-PMN	(9.32)	0.45	(0.026)
0.325	(8.25)	0.65	(0.026)
3/8	(9.32)	0.65	(0.026)
0.404	(10.26)	0.80	(0.031)

This setting may be increased by 0.2 mm (0.008") for cutting softwood in mild weather season - no frost.

### Lowering depth gauges

The depth gauge setting is reduced when the chain is sharpened. Use filing gauge to check the setting every time you sharpen the chain and, if necessary, lower the depth gauge with a flat or triangular file so that it is level with the filing gauge.

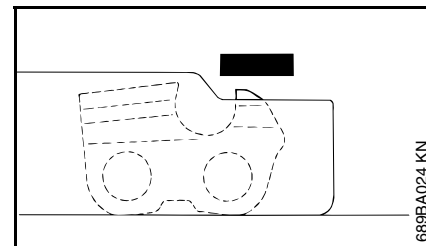

Round off depth gauges parallel to the stamped marking.

### After sharpening

Clean the chain thoroughly, remove filings or grinding dust - lubricate the chain by immersing it in an oil bath.

### Before long out-of-service period

Clean the chain with a brush and immerse it in an oil bath.

### Sharpening tools

Chain pitch		Round file Ø		Round file	File holder	Filing gauge	Flat file	Sharpening kit*
Inch	(mm)	mm	(Inch)	Part No.	Part No.	Part No.	Part No.	Part No.
1/4	(6.35)	4.0	(5/32)	5605 772 4006	5605 750 4327	1110 893 4000	0814 353 3356	5605 007 1027
3/8 PMN	(9.32)	4.0	(5/32)	5605 772 4006	5605 750 4327	0000 893 4000	0814 353 3356	5605 007 1026
3/8 P	(9.32)	4.0	(5/32)	5605 772 4006	5605 750 4327	1110 893 4000	0814 353 3356	5605 007 1027
0.325	(8.25)	4.8	(3/16)	5605 772 4806	5605 750 4328	1110 893 4000	0814 353 3356	5605 007 1028
3/8	(9.32)	5.2	(13/64)	5605 772 5206	5605 750 4329	1110 893 4000	0814 353 3356	5605 007 1029
0.404	(10.26)	5.5	(7/32)	5605 772 5506	5605 750 4330	1106 893 4000	0814 353 3356	5605 007 1030

\* consisting of file holder with round file, flat file and filing gauge.



## Maintenance Chart

Please note that the following maintenance intervals apply for normal operating conditions only. If your daily working time is longer than normal or cutting conditions are difficult (very dusty work area tropical wood etc.) shorten the specified intervals accordingly.		before starting work	after finishing work or daily	after each refueling stop	weekly	monthly	if faulty	if damaged	as required	see page:
Complete machine	Visual inspection (condition leaks)		x		x					
	Clean		x							
Throttle trigger , trigger interlock, Master Control	Check operation		x		x					
Chain brake	Check operation	x		x						29
	Check by STIHL dealer								x	29
Filter in fuel tank	Check					x				27
	Clean, Replace filter element									
	Replace pick-up body						x	x		
Fuel tank	Clean					x				28
Chain oil tank	Clean					x				
Chain lubrication	Check	x								28
Saw chain	Inspect, also check sharpness	x		x						44
	Check chain tension	x		x						26, 34
	Sharpen								x	44
Guide bar	Check (wear, damage)	x								38
	Clean and turn over				x		x			
	Deburr				x					
	Replace							x	x	
Chain sprocket	Check			x						42
Air filter	Clean	x					x			35
	Replace							x		35
Cooling inlets	Clean		x							
Cylinder fins	Clean					x				
Carburetor	Check idle adjustment – chain must not turn	x		x						39
	Readjust idle								x	39
Spark plug	Readjust electrode gap						x			40
All accessible screws and nuts (not adjusting screws)*	Retighten								x	
Rubber vibration buffers	Have replaced by STIHL dealer							x		
Spark arrestor screen in muffler	Inspect						x			
	Clean or replace							x	x	
Chain catcher	Check	x								
	Replace									

\* Tighten down the cylinder base screws firmly after the first 10 to 20 hours of operation

## Specifications

### Engine

STIHL single cylinder two-stroke engine

Displacement:	91.6 cm <sup>3</sup>
Bore:	54 mm
Stroke:	40 mm
Idle speed:	2,500 <sup>1</sup> /min
Maximum engine speed (cut-off speed):	13,000 <sup>1</sup> /min

### Electronic magneto ignition

(breakerless)

Spark plug (suppressed):

Bosch WSR 6 F or NGK BPMR 7 A

Electrode gap 0.5 mm (0.02 in)

### Fuel/Oil System

Carburetor:

All position diaphragm carburetor  
with integral fuel pump

Air filter:

Prefilter and bisectonal box filter

Special accessory:

Heavy-duty (HD) air filter

Fuel tank capacity: 0.825 l (1.74 US pt)

Fuel mix: see chapter "Fuel"

Chain lubrication:

Fully automatic, speed-controlled  
reciprocating oil pump.

Additional manual oil flow control

Oil tank capacity: 0.315 l (0.67 US pt)

### Weight

without bar and chain:

7.3 kg (16.1 lb)

---

### Cutting Attachment

Recommended cutting attachments  
for compliance with § 4.12 of ANSI  
Standard B 175.1-1985

(see page 12 of this Manual):

STIHL reduced kickback bar

(with green label): for 3/8" pitch:

Rollomatic with sprocket nose  
40, 45 or 50 cm (16, 18 or 20 in)

STIHL low kickback chain\*

(with green label):

9.32 mm (3/8") Rapid-Micro 2

(33 RM 2, 36 RM 2)

Chain sprocket:

8-tooth 3/8" pitch rim sprocket

---

Since new bar/chain combinations may  
be developed after publication of this  
Manual, ask your STIHL dealer for the  
latest STIHL recommendations.

Other bars and chains available for this  
powerhead are:

STIHL yellow-labeled bars: for 3/8" pitch:

Rollomatic "S" with sprocket nose

40, 45, 50, 63, 70, 75, 80 or 90 cm  
(16, 18, 20, 24, 28, 30, 32 or 36 in)

for 0.404" pitch: Rollomatic "S" with  
sprocket nose

50, 70, 80, 90 or 105 cm

(20, 28, 32, 36 or 42 in)

Duromatic with stellite tipped nose

40, 45, 50 or 60 cm (16, 18, 20 or 24 in)

STIHL yellow-labeled chains:

for 3/8" pitch: Rapid Micro

(33 RM, 36 RM, 33 RMF),

Rapid-Super (33 RS, 36 RS, 33 RSL,

36 RSL, 33 RSF, 33 RSLF, 36 RSLF,

33 RSLH, 36 RSLH),

Rapid-Duro (33 RD, 36 RD)

for 0.404" pitch:

Rapid-Micro (46 RM, 46 RMF),

Rapid-Super (46 RS, 46 RSF, 46 RSL,

46 RSLF, 46 RSLH),

Rapid-Standard (46 RCX)

\* See definition of "low kickback chain"  
on page 12.

# STIHL Incorporated Federal Emission Control Warranty Statement

## Your Warranty Rights and Obligations

The U.S. Environmental Protection Agency (EPA) and STIHL Incorporated are pleased to explain the Emission Control System Warranty on your equipment type engine. In the U.S. new 1997 and later model year small off-road equipment engines must be designed, built and equipped, at the time of sale, to meet the U.S. EPA regulations for small non road engines. The equipment engine must be free from defects in materials and workmanship which cause it to fail to conform with U.S. EPA standards for the first two years of engine use from the date of sale to the ultimate purchaser.

STIHL Incorporated must warrant the emission control system on your small off-road engine for the period of time listed below provided there has been no abuse, neglect or improper maintenance of your small off-road equipment engine.

Your emission control system includes parts such as the carburetor and the ignition system. Also included may be hoses, and connectors and other emission related assemblies.

Where a warrantable condition exists, STIHL Incorporated will repair your small off-road equipment engine at no cost to

you, including diagnosis (if the diagnostic work is performed at an authorized dealer), parts, and labor.

## Manufacturer's Warranty Coverage:

In the U.S., 1997 and later model year small off-road equipment engines are warranted for two years. If any emission-related part on your engine is defective, the part will be repaired or replaced by STIHL Incorporated free of charge.

## Owner's Warranty Responsibilities:

As the small off-road equipment engine owner, you are responsible for the performance of the required maintenance listed in your owner's manual. STIHL Incorporated recommends that you retain all receipts covering maintenance on your small off-road equipment engine, but STIHL Incorporated cannot deny warranty solely for the lack of receipts or for your failure to ensure the performance of all scheduled maintenance.

Any replacement part or service that is equivalent in performance and durability may be used in non-warranty maintenance or repairs, and shall not reduce the warranty obligations of the engine manufacturer.

As the small off-road equipment engine owner, you should be aware, however, that STIHL Incorporated may deny you warranty coverage if your small off-road equipment engine or a part has failed due to abuse, neglect, improper maintenance or unapproved modifications.

You are responsible for presenting your small off-road equipment engine to a STIHL service center as soon as a problem exists. The warranty repairs will be completed in a reasonable amount of time, not to exceed 30 days.

If you have any questions regarding your warranty rights and responsibilities, please contact a STIHL customer service representative at 1-800-467-8445 or you can write to

STIHL Inc.,  
536 Viking Drive, P.O. Box 2015,  
Virginia Beach, VA 23450-2015.

## Coverage by STIHL Incorporated

STIHL Incorporated warrants to the ultimate purchaser and each subsequent purchaser that your small off-road equipment engine will be designed, built and equipped, at the time of sale, to meet all applicable regulations. STIHL Incorporated also warrants to the initial purchaser and each subsequent

purchaser that your engine is free from defects in materials and workmanship which cause the engine to fail to conform with applicable regulations for a period of two years.

### **Warranty Period**

The warranty period will begin on the date the utility equipment engine is purchased by the initial purchaser and you have signed and sent back the warranty card to STIHL. If any emission related part on your engine is defective, the part will be replaced by STIHL Incorporated at no cost to the owner. Any warranted part which is not scheduled for replacement as required maintenance, or which is scheduled only for regular inspection to the effect of "repair or replace as necessary" will be warranted for the warranty period. Any warranted part which is scheduled for replacement as required maintenance will be warranted for the period of time up to the first scheduled replacement point for that part.

### **Diagnosis**

You, as the owner, shall not be charged for diagnostic labor which leads to the determination that a warranted part is defective. However, if you claim warranty for a component and the machine is tested as non-defective, STIHL Incorporated will charge you for the cost of the emission test.

Mechanical diagnostic work will be performed at an authorized STIHL servicing dealer. Emission test may be performed either at STIHL Incorporated or at any independent test laboratory.

### **Warranty Work**

STIHL Incorporated shall remedy warranty defects at any authorized STIHL servicing dealer or warranty station. Any such work shall be free of charge to the owner if it is determined that a warranted part is defective. Any manufacturer-approved or equivalent replacement part may be used for any warranty maintenance or repairs on emission-related parts and must be provided without charge to the owner. STIHL Incorporated is liable for damages to other engine components caused by the failure of a warranted part still under warranty.

The following list specifically defines the emission-related warranted parts:

Carburetor  
Choke (Cold start enrichment system)  
Intake manifold  
Air filter  
Spark plug  
Magneto or electronic ignition system (ignition module)  
Catalytic converter (if applicable)  
Fasteners

### **Where to make a claim for Warranty Service**

Bring the product to any authorized STIHL servicing dealer and present the signed warranty card.

### **Maintenance Requirements**

The maintenance instructions in this manual are based on the application of the recommended 2-stroke fuel-oil mixture (see also instruction "Fuel"). Deviations from this recommendation regarding quality and mixing ratio of fuel and oil may require shorter maintenance intervals.

### **Limitations**

This Emission Control Systems Warranty shall not cover any of the following:

- repair or replacement required because of misuse, neglect or lack of required maintenance,
  - repairs improperly performed or replacements not conforming to STIHL Incorporated specifications that adversely affect performance and/or durability, and alterations or modifications not recommended or approved in writing by STIHL Incorporated,
- and
- replacement of parts and other services and adjustments necessary for required maintenance at and after the first scheduled replacement point.

## Continuation of Important Safety Precautions

4. Use caution when handling fuel. Move the chainsaw at least 10 feet (3 m) from the fueling point before starting the engine.
5. Do not allow other persons to be near the chainsaw when starting or cutting with the chainsaw. Keep bystanders and animals out of the work area.
6. Do not start cutting until you have a clear work area, secure footing, and a planned retreat path from the falling tree.
7. Keep all parts of your body away from the saw chain when the engine is running.
8. Before you start the engine, make sure that the saw chain is not contacting anything.
9. Carry the chainsaw with the engine stopped, the guide bar and saw chain to the rear, and the muffler away from your body.
10. Do not operate a chainsaw that is damaged, improperly adjusted, or not completely and securely assembled. Be sure that the saw chain stops moving when the throttle trigger is released.
11. Shut off the engine before setting the chainsaw down.
12. Use extreme caution when cutting small size brush and saplings because slender material may catch the saw chain and be whipped toward you or pull you off balance.
13. When cutting a limb that is under tension be alert for springback so that you will not be struck when the tension in the wood fibers is released.
14. Keep the handles dry, clean, and free of oil or fuel mixture.
15. Operate the chainsaw only in well-ventilated areas.
16. Do not operate a chainsaw in a tree unless you have been specifically trained to do so.
17. All chainsaw service, other than the items listed in the Owner's Manual maintenance instructions, should be performed by competent chainsaw service personnel.  
(For example, if improper tools are used to remove the flywheel or if an improper tool is used to hold the flywheel in order to remove the clutch, structural damage to the flywheel could occur and could be subsequently cause the flywheel to burst).
18. When transporting your chainsaw, use the appropriate chain guard (scabbard).

Other important safety precautions are contained in the body of the Owner's Manual.

### **Note:**

When using a chainsaw for logging purposes, refer to the Code of Federal Regulations, Parts 1910 and 1928.



## **WARNING!**

The engine exhaust from this product contains chemicals known to the State of California to cause cancer, birth defects or other reproductive harm.

**englisch/english U.S.A. /EPA**