

Instruction Manual/Owner's Manual

STIHL FS 160, 180

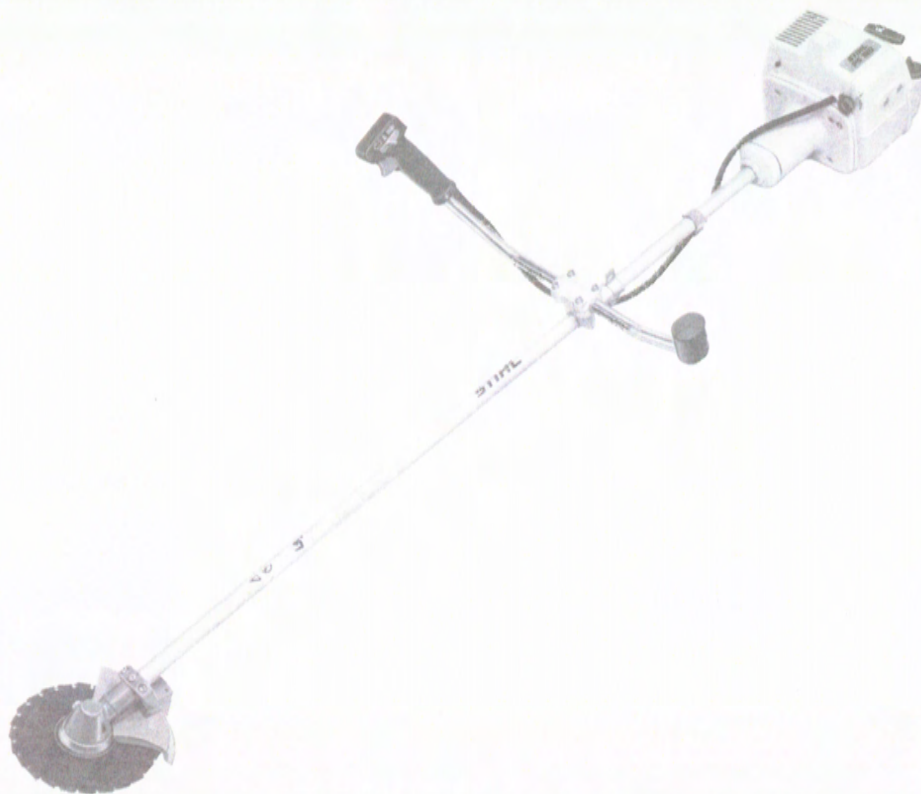

STIHL®

Warning:
Always follow safety precautions in
owner's manual – improper use
can cause serious injury!

STIHL FS 160 STIHL FS 180

This Manual contains operating and safety instructions for all STIHL FS 160 and FS 180 series Brushcutters.

Pay special attention to the safety precautions outlined on pages 6 to 13. Allow only persons who understand this Manual to operate your Brushcutter.

To receive maximum performance and satisfaction from your STIHL Brushcutter, it is important that you read and understand the maintenance and safety precautions before using your Brushcutter. Contact your STIHL dealer or the STIHL distributor for your area if you do not understand any of the instructions in this Manual.

Warning!

Because a Brushcutter is a high-speed cutting tool, some special safety precautions must be observed as with any other power tool to reduce the risk of personal injury. Careless or improper use may cause serious or even fatal injury.

STIHL's philosophy is to continually improve all of its products. As a result, engineering changes and improvements are made from time-to-time. If the operating characteristics or the appearance of your Brushcutter differ from those described in this Manual, please contact your STIHL dealer for information and assistance.

Owner's Manual

Contents

Parts and Controls of Brushcutter	2
Safety Precautions	4
– The Operator	4
– The Brushcutter	6
– The Use of the Brushcutter	6
– Maintenance, Repair and Storing	11
Assembling the Brushcutter	14
Mounting the Cutting Tools	16
STIHL-“Polycut” Head	17
STIHL-“Polymatic” Head	18
Brush Knife	19
Circular Saw Blade (Chisel Tooth)	20
Fuel	21
Fitting the Harness – balancing the Brushcutter	22
Starting	23
Carburetor	26
Air Filter	27
Gearbox Lubrication	28
Sharpening the Circular Saw Blade 200 (Chisel Tooth)	29
Sharpening the Brush Knife	29
Rewind starter	30
Maintenance Chart	33
Specifications	34
Explanation of used symbols	35

STIHL®

Andreas Stihl
Postfach 1771

D-7050 Waiblingen

Parts and Controls of Brushcutter

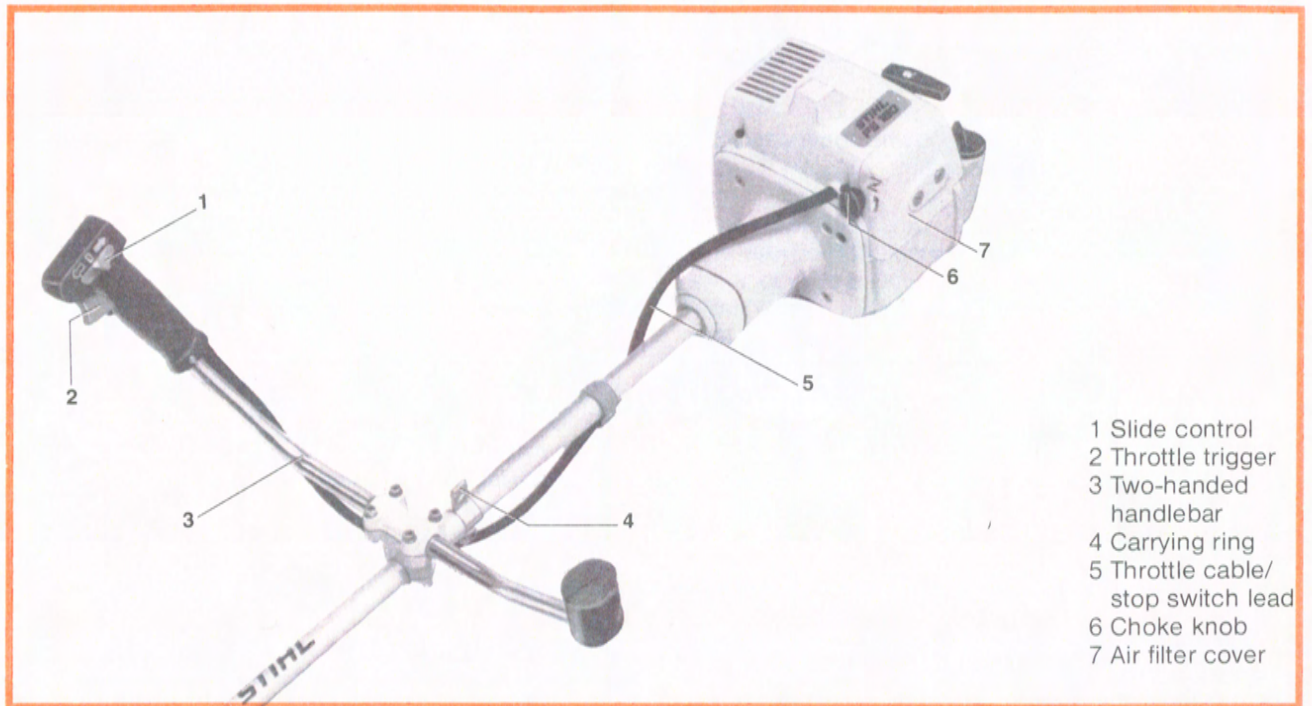

- 1 Slide control
- 2 Throttle trigger
- 3 Two-handed handlebar
- 4 Carrying ring
- 5 Throttle cable/stop switch lead
- 6 Choke knob
- 7 Air filter cover

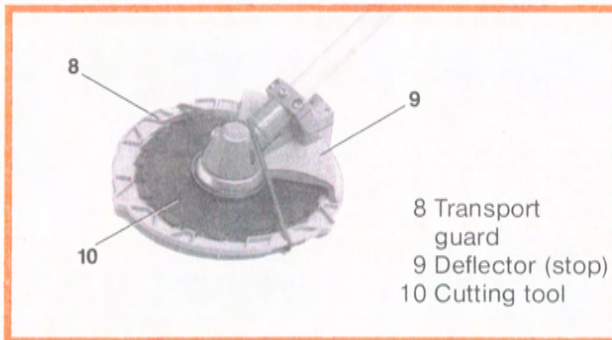

- 8 Transport guard
- 9 Deflector (stop)
- 10 Cutting tool

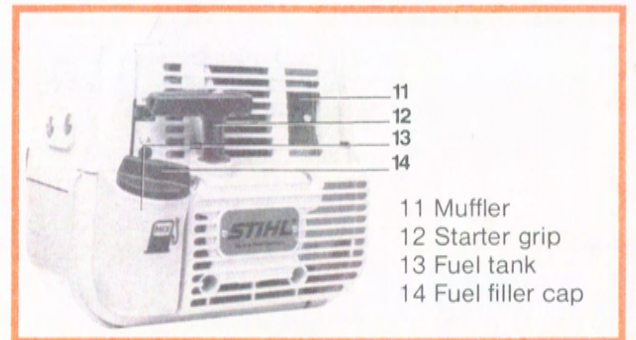

- 11 Muffler
- 12 Starter grip
- 13 Fuel tank
- 14 Fuel filler cap

Definitions

1. **Slide control.** Starting throttle lock and stop switch. Keeps the throttle partially open during starting and switches the engine's ignition off and stops the engine.
2. **Throttle trigger.** Controls the speed of the engine.
3. **Two-handed handlebar.** To hold the brushcutter with both hands.
4. **Carrying ring (loop).** The device to connect the brushcutter with the harness.
5. **Throttle cable/stop switch lead.** Connect operator's control grip with the powerhead.
6. **Choke knob.** Eases engine starting by enriching mixture.
7. **Air filter cover.** Covers the air filter element.
8. **Transport guard.** For all steel cutting tools when transporting the Brushcutter (special accessory).
9. **Stop.** Recommended when cutting down small trees with circular saw blade to help the operator keep the brushcutter positioned against the tree during the cutting process.
10. **Cutting tool.** The cutting attachment made from different materials for different purposes (special accessory).
11. **Muffler.** Attenuates exhaust noises and diverts exhaust gases in required direction.
12. **Starter grip.** The grip of the pull starter, which is the device to start the engine.
13. **Fuel tank.** For fuel and oil mixture.
14. **Fuel filler cap.** For closing the fuel tank.

Harness

To balance the weight of the Brushcutter on the shoulder to be free for a better control of the Brushcutter.
(Not illustrated.)

Deflector. The deflector is designed to reduce the risk of injury from foreign objects being thrown back towards the operator by the cutting tool or from operator contact with the cutting tool. The skirt at the bottom of the deflector must be adjusted as described in the chapters on mounting the various cutting tools.
(Not illustrated.)

Safety Precautions and Working Techniques

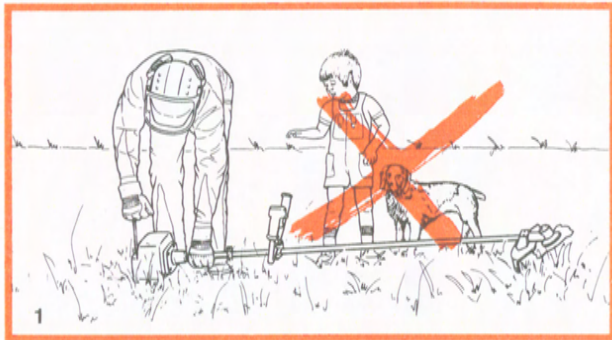

The use of any brushcutter may be hazardous. If the rotating cutting tool comes in contact with your body, it will cut you. When it comes in contact with solid foreign objects such as rocks or bits of metal, it may fling them directly or by ricochet in the direction of bystanders or the operator.

Warning!

Because a brushcutter is a highspeed, fast cutting power tool, special safety precautions must be observed to reduce the risk of personal injury.

It is important that you read, fully understand and observe the following safety precautions and warnings. Read the owner's manual **and** the safety instructions periodically. Careless or improper use of any brushcutter may cause serious or fatal injury.

Have your STIHL dealer show you how to operate your brushcutter. Observe all applicable local safety regulations, standards and ordinances.

Warning!

Minors should never be allowed to use a brushcutter. Bystanders, especially children, and animals should not be allowed in the area where a brushcutter is in use (ill. 1).

4

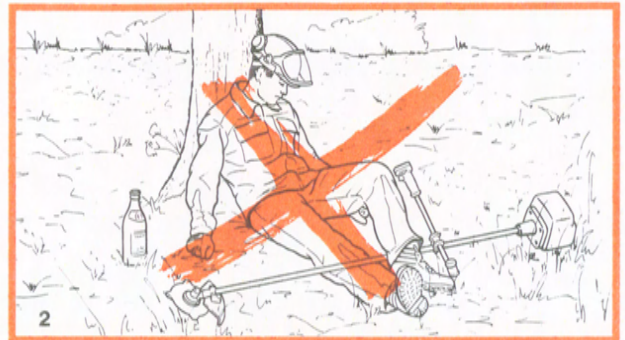

Never let the brushcutter run unattended.

Do not lend or rent your brushcutter without the owner's manual. Be sure that anyone using your brushcutter understands the information contained in this manual.

These safety precautions and warnings apply to the use of all STIHL brushcutters. Different models may have different parts and controls. See the appropriate section of your owner's manual for a description of the controls and function of the parts of your model brushcutter.

Safe use of a brushcutter involves

1. the Operator
2. the brushcutter
3. the Use of the brushcutter.

THE OPERATOR!

Physical Condition

You must be in good physical condition and mental health and not under the influence of any substance (drugs, alcohol, etc.) which might impair vision, dexterity or judgment. Do not operate a brushcutter when you are fatigued (ill. 2).

Be alert – if you get tired while operating your brushcutter, take a break. Tiredness may result in loss of control.

Working with any brushcutter can be strenuous. If you have any condition that might be aggravated by strenuous work, check with your doctor before operating a brushcutter.

Prolonged use of a brushcutter (or other machines) exposing the operator to vibrations may produce whitefinger disease (Raynaud's phenomenon). This phenomenon reduces the hand's ability to feel and regulate temperature, produces numbness and burning sensations and may cause nerve and circulation damage and tissue necrosis.

Warning!

Antivibration systems do not guarantee that you will not sustain whitefinger disease. Therefore, continual and regular users should monitor closely the condition of their hands and fingers. If any of the above symptoms appear, seek medical advice immediately.

Proper Clothing

Clothing must be sturdy and snug-fitting, but allow complete freedom of movement. Avoid loose-fitting jackets, scarfs, neckties, jewelry, flared or cuffed pants or anything that could become caught on branches, brush or moving parts of the unit. Wear long pants made of heavy material to protect your legs (ill. 3). Do not wear shorts.

Warning!

Never use a brushcutter without safety goggles or face screen. The deflector provided with your brushcutter may not protect the operator from all foreign objects (gravel, glass, wire, etc.) thrown by the cutting attachment. Foreign

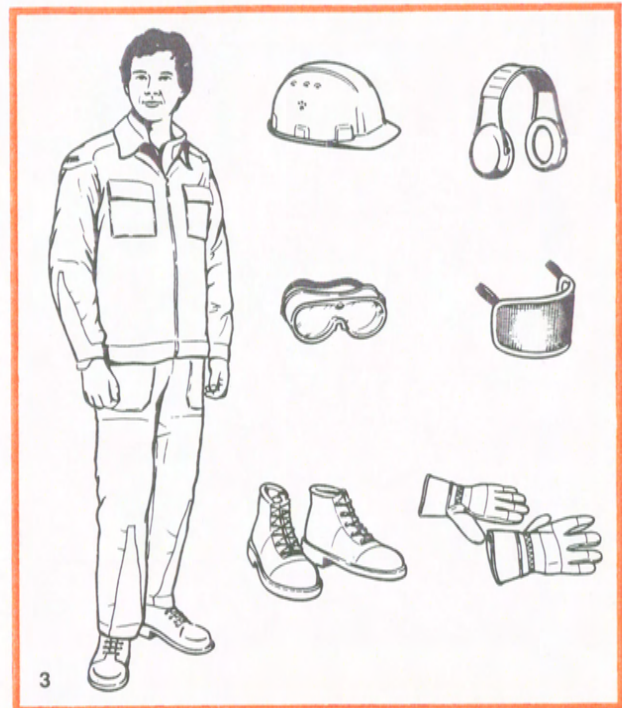

objects may also ricochet and strike the operator. Therefore, to reduce the risk of injury, the operator must wear protective clothing including eye protection.

Warning!

Protect your hands with gloves when handling the brushcutter and the cutting tool. Heavy-duty, nonslip gloves improve your grip and protect your hands.

Good footing is most important in brushcutter work. Wear sturdy boots with nonslip soles. Steel-toed safety boots are recommended.

Wear an approved safety hard hat to protect your head when there is a danger of head injuries.

Brushcutter noise may damage your hearing. Wear sound barriers (ear plugs or ear muffers) to protect your hearing. Continual and regular users should have their hearing checked regularly.

THE BRUSHCUTTER

For illustrations and definitions of the brushcutter parts see chapter "Parts and Controls of brushcutter"!

Warning!

Never modify a brushcutter in any way. Only attachments supplied by STIHL or expressly approved by STIHL for use with the specific STIHL brushcutter models are authorized. Although certain unauthorized attachments are useable for the STIHL brushcutter, their use may, in fact, be extremely dangerous.

THE USE OF THE BRUSHCUTTER

Transporting the brushcutter

Warning!

Always stop the engine before putting a brushcutter down.

When transporting your brushcutter in a vehicle, properly secure it to prevent turnover, fuel spillage and damage to the brushcutter. Keep the cutting tool covered with the transport guard (optional accessory).

Preparation for the use of the brushcutter

6

Adjust harness and hand grip to suit your size before starting work. The machine should be properly balanced



as specified in this owner's manual for proper control and less fatigue in operation.

Always check your brushcutter for proper condition and operation before starting, particularly the throttle lever, stop switch, cutting tool, deflector and harness.

The throttle lever must move freely and always spring back to the idle position. The cutting tool must be properly tightened and in safe operation condition. Inspect for loose parts (nuts, screws, etc.) and for cracked, bent, warped or damaged blades.

Fueling

Your STIHL brushcutter uses an oil-gasoline mixture for fuel (see chapter "Fuel" of this owner's manual).

Warning!

Gasoline is an extremely flammable fuel. Use extreme caution when handling gasoline or fuel mix. Do not smoke or bring any fire or flame near the fuel (ill. 4).

Fueling Instructions

Fuel your brushcutter in well-ventilated areas, outdoors only. Always shut off the engine and allow it to cool before

refueling. Relieve fuel tank pressure by loosening fuel cap slowly. Never remove fuel filler cap while engine is running.

Select bare ground for fueling and move at least 10 feet (3 m) from the fueling spot before starting the engine. Wipe off any spilled fuel before starting your brushcutter and check for leakage.

Check for fuel leakage while refueling and during operation. If fuel or oil leakage is found, do not start or run the engine until leak is fixed and spilled fuel has been wiped away. Take care not to get fuel on your clothing. If this happens, change your clothing immediately.

Starting

Warning!

Your brushcutter is a one-person machine. Make sure that nobody is standing within a 10 m (30 ft) radius of the brushcutter when starting or operating the unit. Start and operate your brushcutter without assistance. For specific starting instructions, see the appropriate section of this manual.

Place the brushcutter on firm ground or other solid surface in an open area. Maintain a good balance and secure footing.

Be absolutely sure that the cutting tool is clear of you and all other obstructions and objects, including the ground, because when the engine starts at starting-throttle, engine speed will be fast enough for the clutch to engage and turn the cutting tool.

When you pull the starter grip, don't wrap the starter rope around your hand. Do not allow the grip to snap back, but guide the starter rope slowly back to permit the rope to rewind properly. Failure to follow this procedure may result in injury to hand or fingers and may damage the starter mechanism.

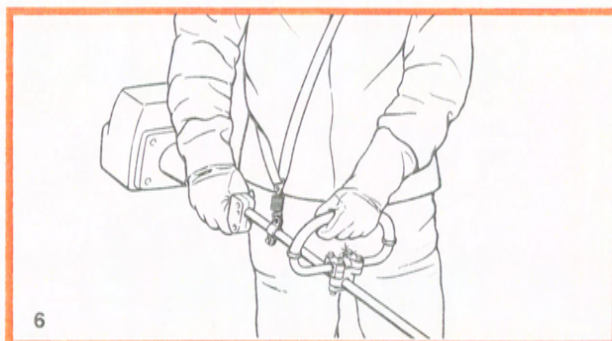
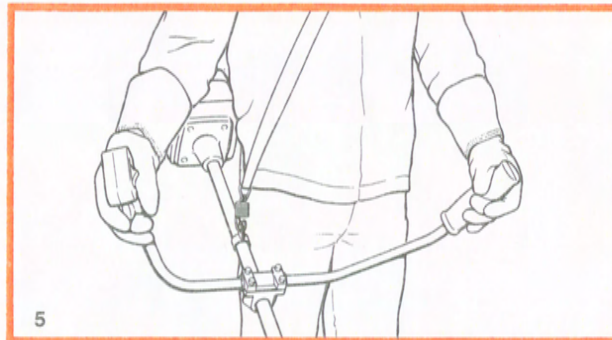

Working Conditions

Operate and start your brushcutter only outdoors in a ventilated area. Operate the brushcutter under good visibility and daylight conditions only. Work carefully.

Always hold the brushcutter firmly with both hands. Wrap your fingers tightly around the handles, keeping the handles cradled between your thumb and forefinger. Keep your hands in this position, to have your brushcutter under control at all times (ill. 5 = with handlebar, ill. 6 = with loop handle). Make sure your brushcutter handles and grip are in good condition and free of moisture, pitch, oil or grease.

Warning!

Never use the brushcutter with one hand and without harness. Loose of control of the brushcutter and serious injury may result.

Warning!

Special care must be taken in slippery conditions (wet ground, snow) and in difficult, over-grown terrain. Watch for hidden obstacles such as tree stumps, roots and ditches to avoid stumbling. Before cutting, inspect the area for stones, glass, pieces of metal, trash or other solid objects. The cutting attachment could throw objects of this kind. Striking such objects could also damage the cutting attachment and may cause blades to crack, chip or break. STIHL does not recommend the use of rigid blades when cutting in stony areas. Thrown objects or damaged blades may result in serious or fatal injury to the operator or bystanders.

To reduce the risk of injury from thrown objects, keep the skirt on the deflectors adjusted properly at all times (see chapter on mounting the various cutting tools).

Do not overreach. Keep proper footing and balance at all times.

Warning!

This tool is normally to be used on ground level with the cutting attachment parallel to the ground. Use of a brushcutter above ground level or with the cutting attachment perpendicular to the ground may increase the risk of injury, since the cutting attachment is more fully exposed and the brushcutter may be more difficult to control. Never use your brushcutter as a hedge trimmer.

8

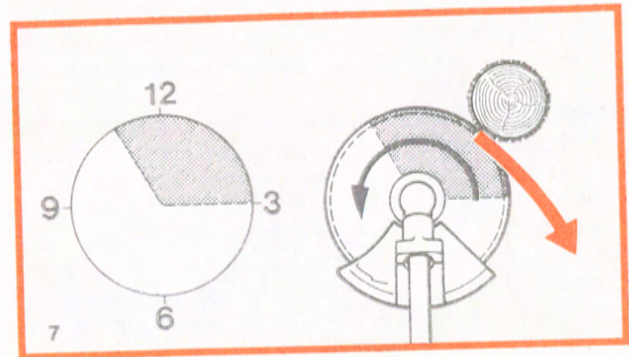

Warning!

When using rigid blades, be particularly careful when cutting with the shaded area of the blade shown in the illustration (7). Blade contact with a solid object in this area may cause the brushcutter to kick out to the right or backwards. This may cause loss of control of the brushcutter, which may result in serious injury to the operator or bystanders.

Warning!

When using rigid blades, avoid cutting close to fences, sides of buildings, tree trunks, stones or other such objects that could cause the brushcutter to kick out or could cause damage to the blade. STIHL recommends use of the Polymatic nylon line head or Polycut head for such jobs. In addition, be alert to an increased possibility of ricochets in such situations.

Warning!

Do not operate using the starting throttle lock as you do not have control of the engine speed. See chapter "Starting" of this owner's manual for the proper use of the starting throttle lock.

If the cutting tool or deflector becomes clogged or stuck, always turn off the engine before cleaning. Grass, weeds, etc. should be cleaned off the cutting tool at regular intervals.

Warning!

During cutting, check the tightness and the condition of the cutting tool at regular intervals. If the behavior of the tool changes stop the engine immediately and check the nut securing the tool for tightness and the cutting tool for cracks and damage.

Warning!

Replace cracked, bent, warped, damaged or dull cutting tools immediately. Such tools may shatter at high speed and cause serious or fatal injury.

Warning!

A loose blade may cause the blade to crack, break or come off the brushcutter, which may result in serious or fatal injury. Make sure that the blade is properly tightened. Use the wrench supplied or one of sufficient length to obtain the proper torque. If the blade loosens after being properly tightened, stop work immediately. The retaining nut may be worn or damaged and should be replaced. Never use unauthorized parts to secure the blade. If the blade continues to loosen, see your STIHL dealer. Never use a brushcutter with a loose blade.

Important adjustments

Warning!

At correct idle speed, the cutting tool should not turn. For directions to adjust idle speed, see the appropriate section of this owner's manual.

Do not use a brushcutter with incorrect idle speed adjustment. Adjust the idle speed yourself according to the instructions in this manual.

If you cannot set the correct idle speed, have your STIHL dealer check your saw and make proper adjustments or repairs.

Warning!

Never touch a rotating cutting tool with your hand or any part of your body. It continues to rotate for a short period after the throttle lever is released (flywheel effect).

Warning!

Do not cut any material other than grass, brush and wood. The cutting tools may be used only for the operations described in this manual.

Operating instructions

With the engine running, attach the brushcutter to the spring hook of your harness.

Warning!

Use STIHL brushcutters with loop handle only with Polycut, Rotocut and nylon line head cutting tools. Other plastic and metal attachments should be used only on brushcutters with handlebars to reduce the increased risk of serious injury from operator blade contact.

Brushcutter in operation



USING THE CUTTING TOOLS

For an illustration of the various cutting tools and instructions on proper mounting see chapter "mounting the cutting tools" in this manual.

Using the mowing heads

The STIHL Autocut, Polymatic and Polycut mowing heads are intended to supplement a lawn mower. They produce a clean and tidy finish.

10

Top: Lawn edging with the STIHL "Polycut", STIHL "Autocut" or STIHL "Polymatic"

Bottom: Mowing around trees with the STIHL "Polycut" (with nylon line), STIHL "Polymatic" or STIHL "Autocut"

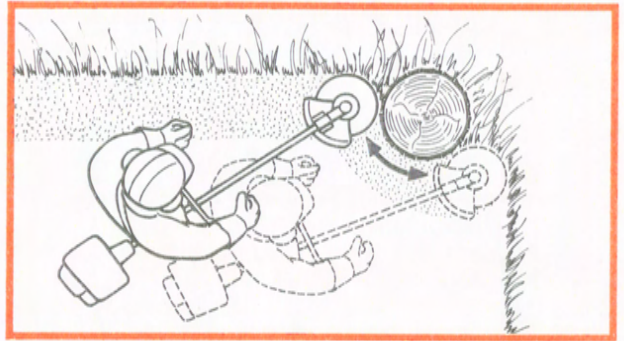
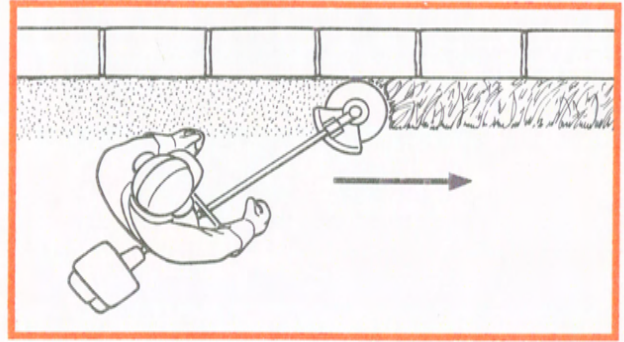

If the lawn edges are planted with trees or bordered by a fence etc., it is best to use a nylon line head. It achieves a "softer" cut with less risk of damaging tree bark than with the polymer blades.

However, the polymer bladed STIHL "Polycut" produces a better cut if there are no plants along the edge of the lawn. Sharpening is not necessary and worn cutting blades are easily replaced.

Warning!

Never use wire in place of the nylon cutting lines.

Wear limit marks on Polycut base

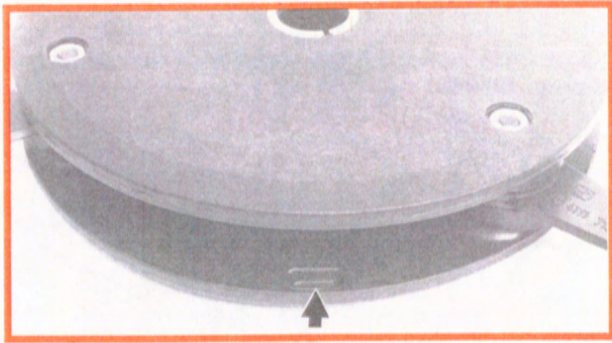

STIHL "Autocut" mowing head

The Autocut mowing head is to be used only on brushcutters equipped with a chopper blade on the deflector.

STIHL "Polymatic" mowing head

Frayed line is replaced by a simple adjustment (see instruction sheet supplied with mowing head).

STIHL "Polycut" mowing head

Important!

Three rectangular wear limit marks are applied to the base (periphery) of the Polycut. The Polycut must not be used when it has worn as far as one of these marks.

Using the STIHL "Rotocut"

The STIHL-"Rotocut" blade is made of high impact plastics and is used for cutting high growing grass, clearing shrubs and bushes (not wood). A high cutting rate is achieved by the six molded blades. When these blades become dull, the "Rotocut" is simply tuned over to produce six fresh cutting edges.

Top: Lawn edging with the STIHL "Rotocut"
Bottom: Mowing with grass cutting blade or brush knife

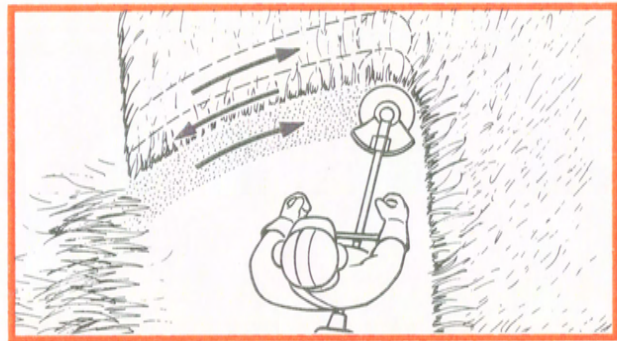
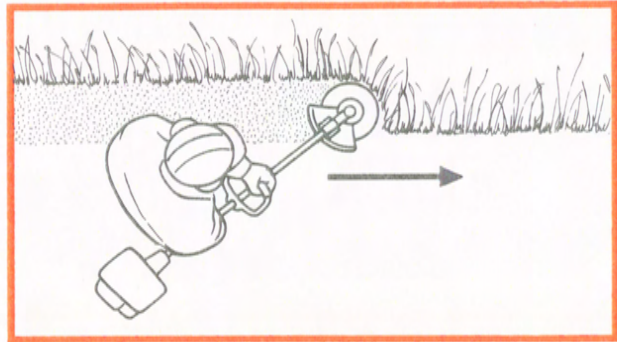

The brushcutter is swept in an arc during cutting – similar to a scythe.

Using the grass cutting blade (On brushcutters with handlebars only)

All kinds of grass, brush, weeds, shrubs, etc. can be easily cut with the grass cutting blade. The brushcutter is swept in an arc similar to a scythe.

The cutting blade has 4 cutting knives which are each

Cutting wild growth and scrub with the brush knife

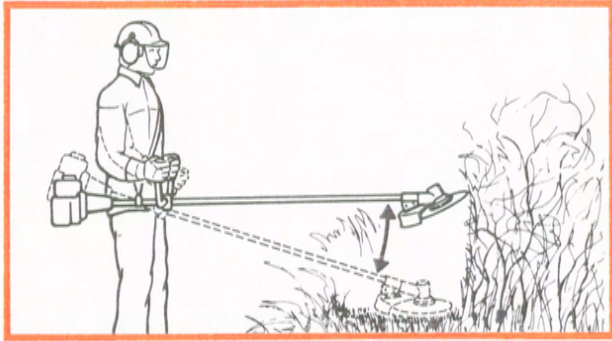

equipped with cutting edges on both sides, i.e. front and rear. When the cutting edges become dull on one side the cutting blade need only be turned over and the tool is ready to cut again with 4 fresh cutting edges.

The blade has to be resharpened when all eight cutting edges are dull.

Using the brush knife (On brushcutters with handlebars only)

When fitted to the brushcutter, the brush knife is suitable for applications ranging from cutting matted grass to clearing weeds, wild growth and scrub.

To cut wild growth and scrub, lower the rotating brush knife down onto the growth to achieve a chopping effect. Use the brushcutter like a scythe to cut grass, i.e. sweep it to and fro in an arc.

Warning!

When cutting woody materials, use the left side of the blade to avoid "kickout" situations.

12

Cutting with the circular saw blade

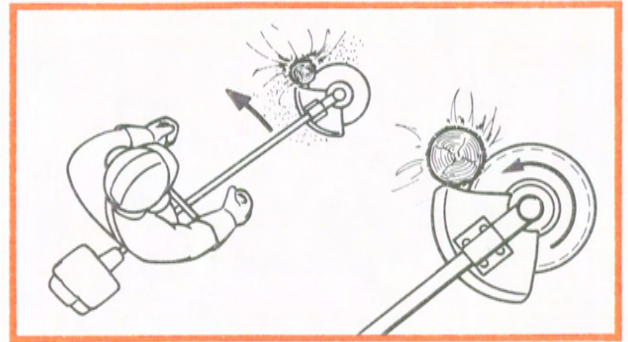

Using the circular saw blade (On brushcutters with handlebars only)

The circular saw blade is ideal for thinning brush and small trees.

STIHL recommends that the standard deflector be removed and replaced by the special "stop", for cutting down small trees (see chapter "circular saw blade" for mounting instructions). This stop helps the operator to keep the brushcutter positioned against the tree during the cutting process.

Warning!

In order to reduce the risk of injury from thrown objects or from operator contact with the cutting tool, be sure to re-mount the standard deflector for all other uses.

Warning!

Use the left side of the blade in order to avoid "kickout" situations.

Accelerate the engine up to full throttle and apply the circular saw blade to the right of the tree so that the stop is firmly against the trunk. Perform cut with uniform pressure.

MAINTENANCE, REPAIR AND STORING

Use only STIHL replacement parts for maintenance and repair. Use of parts manufactured by others may cause serious or fatal injury.

Follow the maintenance and repair instructions in the appropriate section of your owner's manual.

Warning!

Always stop the engine and make sure that the cutting tool is stopped before doing any maintenance or repair work or cleaning the brushcutter. Do not attempt any maintenance or repair work not described on your owner's manual. Have such work performed at your STIHL service shop only.

Warning!

 Never repair damaged cutting attachments by welding, straightening or modifying the shape. This may cause parts of the cutting tool to come off and result in serious or fatal injuries.

Check condition of cutting tool at regular short intervals. If behavior of tool changes, check it immediately for tightness or any signs of cracks in particular. Replace damaged or dull cutting tools immediately, even if they have only superficial cracks. If the blade loosens after being properly

tightened, the retaining nut may be worn or damaged and should be replaced. Never use unauthorized parts to secure the blade. If the blade continues to loosen, see your STIHL dealer.

Check fuel filler cap for leaks at regular intervals. Use the specified spark plug and make sure it and the ignition lead are always in good condition.

Warning!

A worn or damaged muffler is a fire hazard and may cause loss of hearing. Check to see that the muffler is in good condition. The brushcutter must not be operated if the muffler is faulty or has been removed. Remember that the risk of forest fires is greater in hot weather. Use the fire-safe muffler supplied with the unit. Never touch a hot muffler or burn will result.

Keep cutting tool sharp. Tighten all nuts, bolts and screws except the carburetor adjustment screws after each use.

Keep spark plug and wire connection tight and clean. The spark plug electrode gap should be checked with a feeler gauge at least every 50 operating hours and reset if necessary. Fit a new spark plug if the electrodes are badly pitted.

Store brushcutter in a dry place and away from children.

Before storing for longer than a few days always empty the fuel tank.

Assembling the Brushcutter

The brushcutter comes partly disassembled and must be completely reassembled before it can be used for the first time.

Attach the enclosed machine support to the underside of the engine with the two screws provided.

Warning: Because of the increased risk of accidents the engine must not be started while it is detached from the brushcutter.

Mounting the engine

First remove the protective cap from the drive tube (1) and slide the throttle cable retainers (2) about 20 cm (8 in) onto the drive tube. Unscrew the clamp sleeve's center screw, pull the cap (3) off the clutch housing and slip it over the drive tube. Now slacken off the two mounting screws (4) on the clamp sleeve (5).

Line up the engine and drive tube so that the machine support and the cutting tool seat on the gear head both face in the same direction.

Slide the drive tube through the clamp sleeve and into the clutch housing (6) so that the hole (7) in the drive tube lines up with the tapped hole (8) in the clamp sleeve.

Now insert the two mounting screws (4) and tighten them down securely. Push the cap (3) over the clamp sleeve and into the clutch housing so that the opening (9) lines up with the tapped hole (8) in the clamp sleeve. Finish off by fitting the center screw in the clamp sleeve and tightening it down firmly.

Top: Clamp sleeve mounting screws
Center: Engine positioned on drive tube, machine support fitted
Bottom: Engine fitted

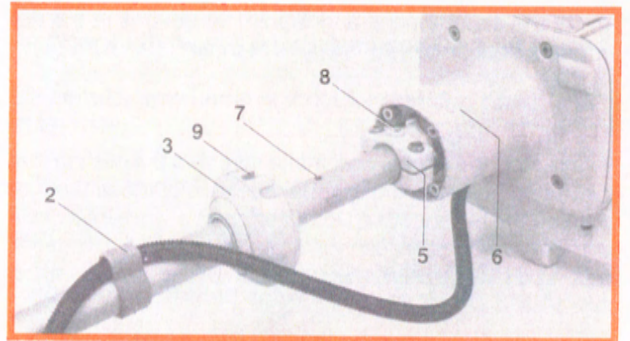
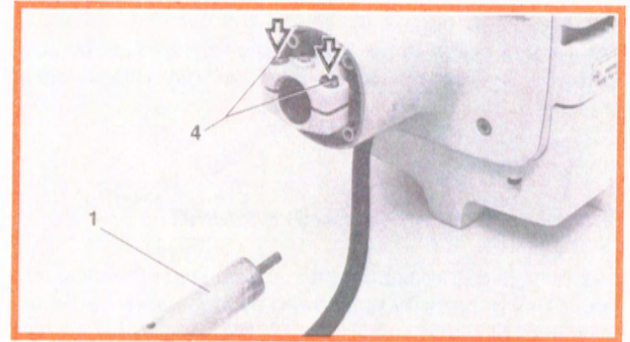

Mounting the two-handed handlebar

To fit the two-handed handlebar, first remove the screws from the clamp (1). Take off the clamp and position the handlebar (2) on the support (3) so that the handle (4) is on the left (looking from engine to handlebar). Refit the clamp and secure it with the mounting screws.

Now adjust the handlebar to the required position and tighten down all mounting screws securely.

Mounting the control grip

Important: The throttle cable with integrated stop switch wire is already connected in the control grip and at the engine. It must not be kinked during assembly of the control grip.

First release and remove the mounting screw (5). Take care not to lose the nut (6) in the grip's recess.

Position the control grip (7) on the right (free) end of the handlebar. The throttle trigger must point toward the cutting tool head. Now push the grip firmly over the handlebar tube until the hole in the grip lines up with the hole in the tube.

Fit mounting screw (5) through the grip and handlebar tube and tighten it securely with the nut (6) in the grip's recess. Finally, adjust the throttle cable retainers (8), slide or turn it on the drive tube, so that there are no tight bends in the cable.

Top: Two-handed handlebar with support
Center: Handlebar fitted
Bottom: Control grip correctly fitted

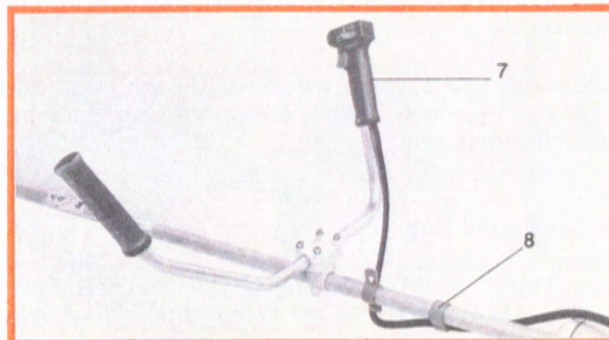
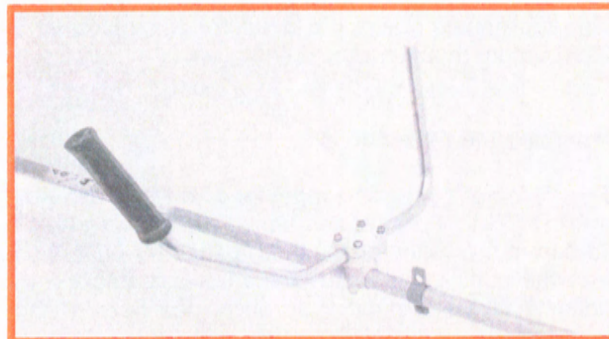
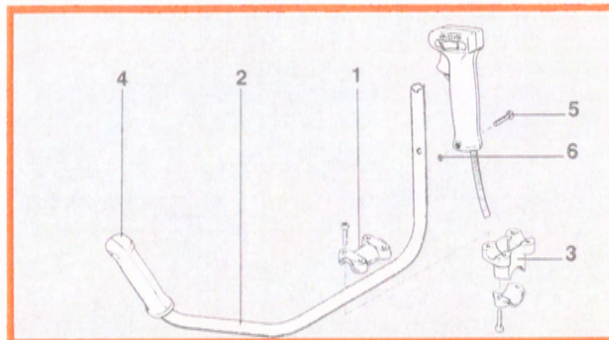

Mounting the Cutting Tools

Assembly sequence for deflector

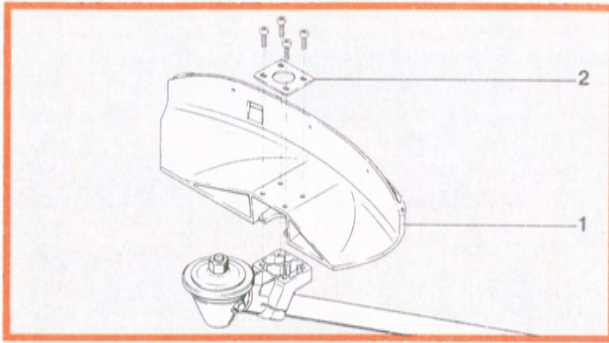

The appropriate guard, i. e. deflector or stop, must be fitted before mounting the cutting tool.

Mounting the deflector

The deflector (1) is used together with the brush knife and the STIHL "Polycut" and "Polymatic" mowing heads. To mount the deflector, lay the brushcutter on its back with the cutting tool head facing upward. Position the deflector (1), inside pointing up, on the gear head's flange face. Now fit the plate (2) on the inside of the deflector and line it up. Insert and tighten down the four M 5 x 20 screws.

The plastic skirt supplied with the deflector is necessary only when you use certain cutting tools (see following fitting instructions).

Mounting the stop

The stop (3) is used with the circular saw blade and mounted to the gear head by means of three M 5 x 20 pan head screws.

Top: Mounting points for stop
Bottom: Cutting tools for FS 160, 180

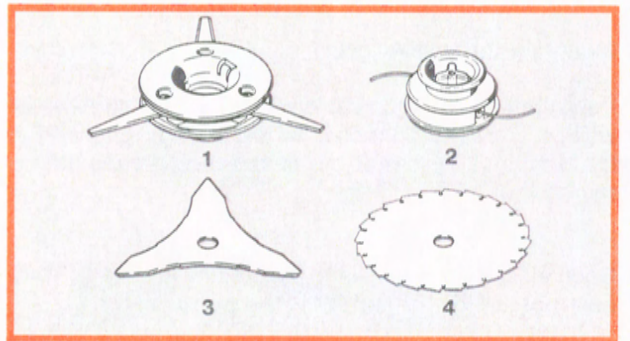
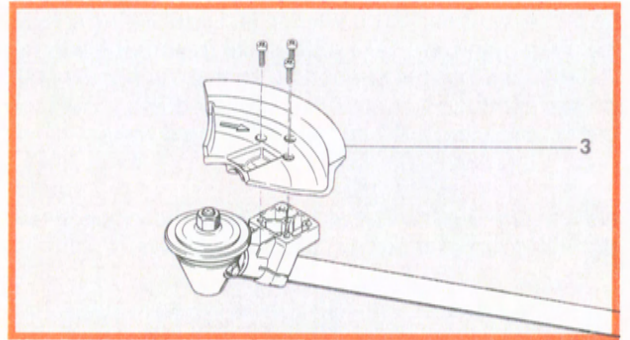

The cutting tool can now be mounted and secured in position.

The following cutting tools are approved for use with FS 160 and FS 180 brushcutters:

- 1 STIHL "Polycut" mowing head
- 2 STIHL "Polymatic" trimming head
- 3 Brush knife 300 (steel)
- 4 Chisel tooth circular saw blade 200 (steel)

STIHL-“Polycut” Mowing Head

Before fitting the mowing head it is necessary to add the skirt (2) to the deflector (1).

The skirt must be removed before using any other kind of cutting tool.

Now place the mowing head on the thrust plate (3). Slip the thrust washer (4) over the shaft (5) – the curvature of the thrust washer must face the mowing head.

Screw the mounting nut onto the shaft (5) (left-hand thread). Block the drive shaft by inserting the Allen key through the bore in the gear head and then use combination wrench (19 mm) to tighten down the mounting nut securely.

To remove the mowing head, block the drive shaft by inserting the Allen key through the bore in the gear head and then release and unscrew the mounting nut in the clockwise direction.

Top: Deflector with skirt; guide slot for Polycut
Center: Skirt correctly fitted
Bottom: Correct assembly sequence

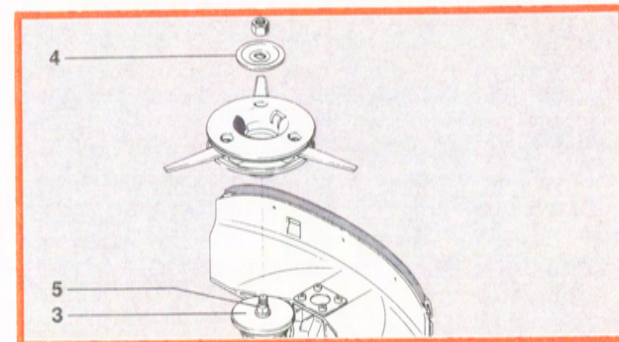
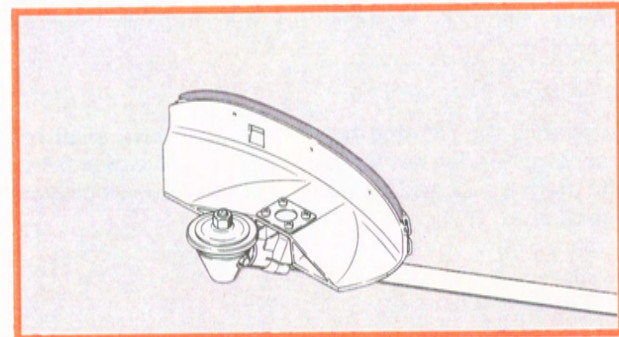
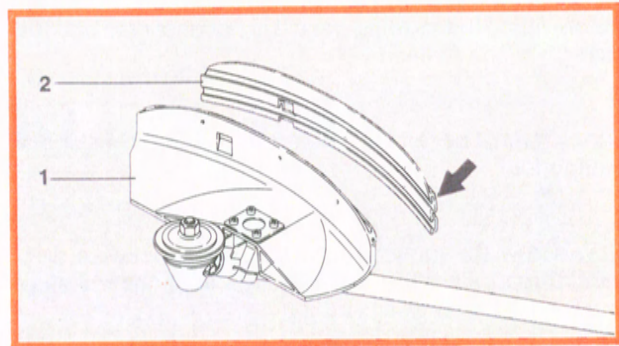

STIHL "Polymatic" Mowing Head

Before fitting the mowing head it is necessary to add the skirt (2) to the deflector (1).

The skirt must be removed before using any other kind of cutting tool.

Now screw the mowing head counter-clockwise (left-hand thread) onto the drive shaft (5) as far as the stop.

It is not necessary to tighten the mowing head any further since it tightens up automatically during operation.

To remove the mowing head, block the drive shaft by inserting the Allen key through the bore in the gear head and then release and unscrew the head in the clockwise direction.

Top: Deflector with skirt; guide slot for Polymatic
Center: Skirt correctly fitted
Bottom: Correct assembly sequence

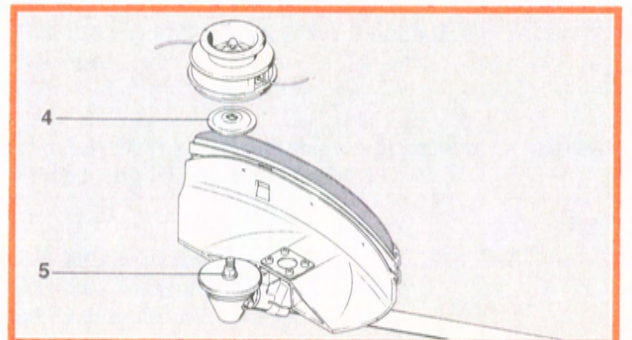
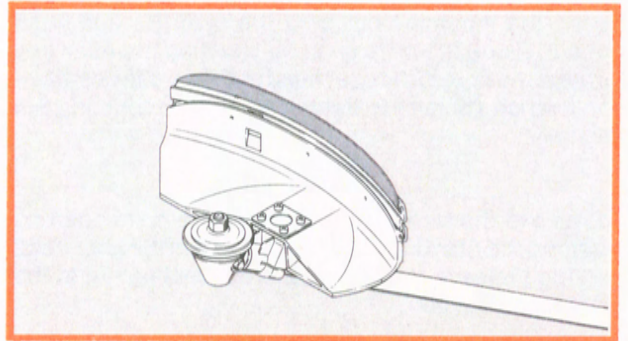
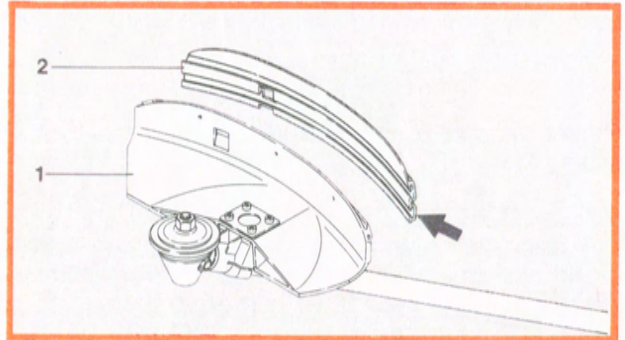

Brush Knife

Brush knife in position

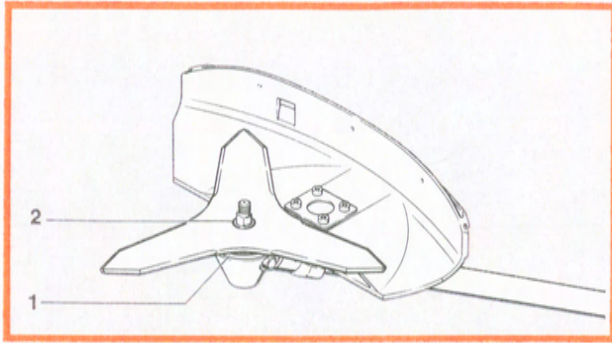

Place the tool on the guard ring (1). The tool is centered by the raised collar of the thrust plate (2).

The cutting tool may be fitted either way round.

Now fit the thrust washer (3) over the shaft (4) so that its curvature faces away from the cutting tool.

After fitting the rider plate (5) on the thrust washer (3), screw on the mounting nut (6) counter-clockwise (left-hand thread).

Block the drive shaft by inserting the Allen key through the bore in the gear head and then use combination wrench (19 mm) to tighten down the mounting nut securely.

Correct assembly sequence

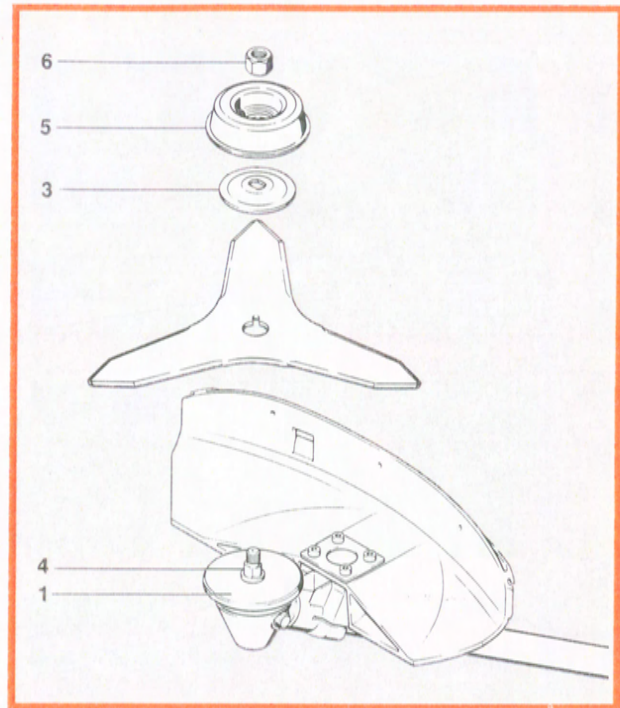

Circular Saw Blade (Chisel tooth)

Top: Mounting points for stop
Bottom: Stop fitted in position

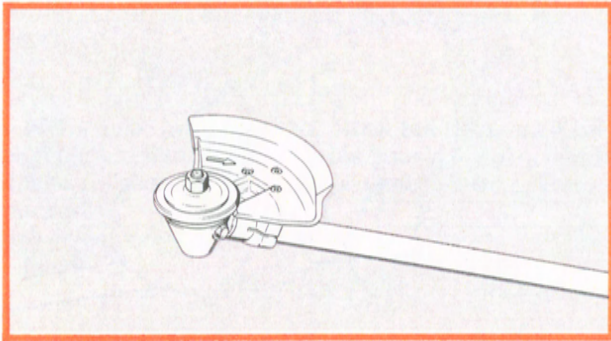
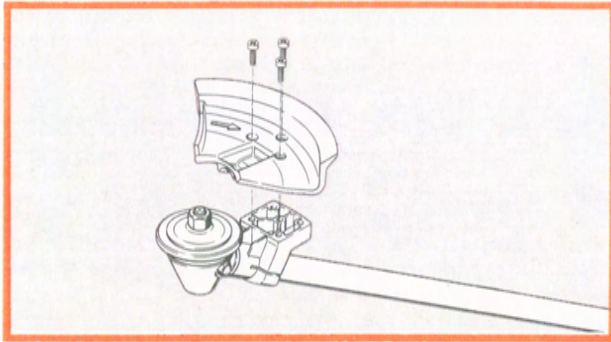

Before fitting the circular saw blade it is necessary to assemble the stop supplied in the mounting kit. To do this, remove the deflector (4 screws) and fit the stop on the gear head with the screws provided in the kit.

Note when fitting the circular saw blade on the guard ring (1) that the cutting edges must point in the clockwise direction. The blade is centered by the raised collar of the thrust plate (2).

20

Now fit the thrust washer (3) over the shaft (4) so that its curvature faces away from the cutting tool.

Correct assembly sequence

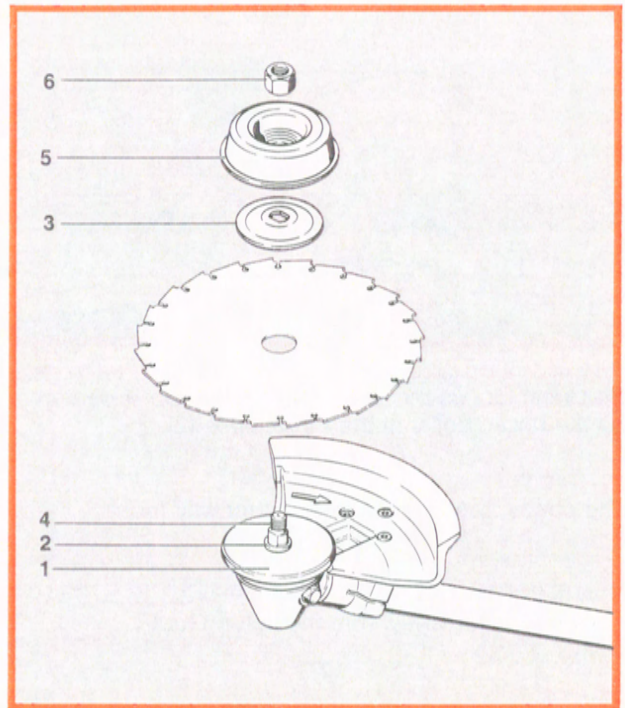

After fitting the rider plate (5) on the thrust washer (3), screw on the mounting nut (6) counter-clockwise (left-hand thread).

Block the drive shaft by inserting the Allen key through the bore in the gear head and then use combination wrench (19 mm) to tighten down the mounting nut securely.

Fuel

Fuel filler cap removed

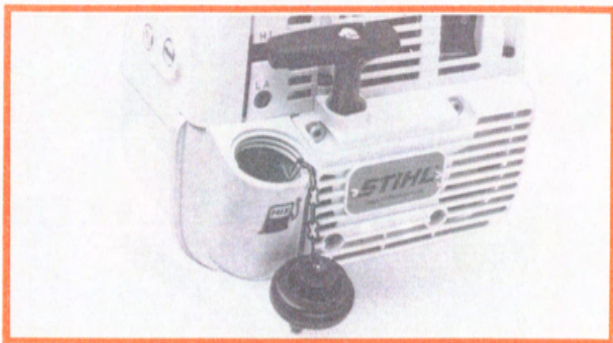

Your two-stroke engine requires a mixture of gasoline and engine oil.

Use branded regular grade leaded or unleaded gasoline with a minimum octane number of 90 ROZ. If the octane number of the regular grade gasoline available in your area is below 90 ROZ, you may, by way of an exception, use branded premium grade leaded or unleaded gasoline.

Apart from the octane number, the chemical composition of the fuel is also important. Some fuel constituents not only detrimentally affect elastomers (carburetor diaphragms, oil seals, fuel lines etc.) but magnesium castings as well. This may result in problems in operation as well as damage to the fuel tank. For this reason it is essential that you use only branded gasoline.

Avoid the use of gasohol and gasolines with alcohol extenders (methanol, ethanol) as this can cause serious damage to magnesium gas tanks, fuel lines, carburetor parts and can lead to excessive heat and piston seizure!

Only use branded two-stroke engine oils for the fuel mix. The mix ratios are listed in the following table.

Table of fuel mixes:

Gasoline Lit. (gal.)	STIHL 1:40 oil Liters (pt.)	Other two-stroke engine oils (1:25) Liters (pt.)
1 (0.5)	0.025 ($\frac{1}{10}$)	0.040 ($\frac{1}{6}$)
5 (1)	0.125 ($\frac{1}{6}$)	0.200 ($\frac{1}{3}$)
10 (2)	0.250 ($\frac{2}{5}$)	0.400 ($\frac{2}{3}$)
15 (3)	0.375 ($\frac{3}{5}$)	0.600 (1)
20 (4)	0.500 ($\frac{4}{5}$)	0.800 ($1\frac{1}{3}$)
25 (5)	0.625 (1)	1.000 ($1\frac{2}{3}$)

Important:

- A fuel mixture that has been left standing for a prolonged period will begin to separate. For this reason you should shake the mixture in the can thoroughly before fueling.
- The fuel mixture ages. Do not store large quantities. Only mix sufficient fuel for about a week and store it in approved, safety-type containers.
- The fuel tank and the containers in which fuel mix is stored should be cleaned thoroughly from time to time.
- Change the filter element in the fuel pickup body every year.

Fitting the Harness – balancing the Brushcutter

Pulling the quick release clip

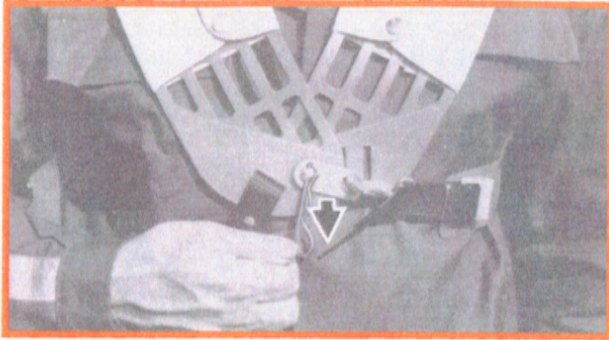

The full harness is worn over both shoulders so that the pad and spring hook hang at the right hip. The spring hook of the connecting strap is attached to the link plate at the front of the harness. The load on the shoulders can be varied by adjusting the length of the connecting strap. The shorter the strap, the greater the load on the right shoulder.

The height of the spring hook is adjusted by loosening the buckles on both straps and shortening or lengthening the straps as required. Make sure that the buckles are properly closed after making the adjustment.

The full harness has a quick release mechanism. The harness and brushcutter can be quickly thrown off in a dangerous situation by simply pulling the quick release clip.

The brushcutter must be properly balanced after you attach the spring hook to the carrying ring on the drive tube. This is done by slackening the screw (1) with a screwdriver and moving the carrying ring along the drive tube.

Top: Adjusting the clamp
Bottom: Brushcutter balanced

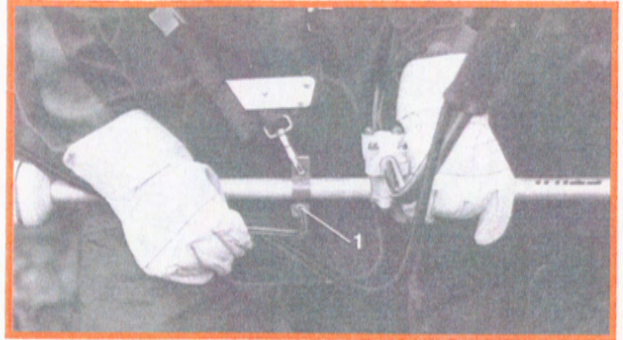

If you use a mowing head (STIHL "Polycut" or "Polymatic") or a brush knife, balance the brushcutter so that the mowing head or rider plate rests on the ground when you let go of the handles.

In the case of the circular saw blade, balance the brushcutter so that the blade stays about 30 cm (1 ft) clear of the ground when you let go of the handles.

Starting

To start the engine, place your brushcutter on a clear patch of ground so that it rests on the underside of the engine and deflector. Make sure you have a firm foothold, keep a firm grip on the machine and check that the cutting tool is clear of the ground and any other obstacles.

Starting Procedure

1. Squeeze the throttle trigger (2) and move the slide control (1) on the control grip to "START". Release the throttle trigger (2) – it will now remain in the start position.

2. Always start a cold engine with the choke closed. Turn the choke knob to \mathcal{Z} (counter-clockwise).

Start a warm engine, or one that has only been stopped for a brief period, with the choke open. Turn the choke knob (3) away from \mathcal{Z} (clockwise).

Top: Slide control on "START", throttle trigger in start position

Center: Choke knob on \mathcal{Z} (Choke)

Bottom: Choke knob away from \mathcal{Z} (Choke)

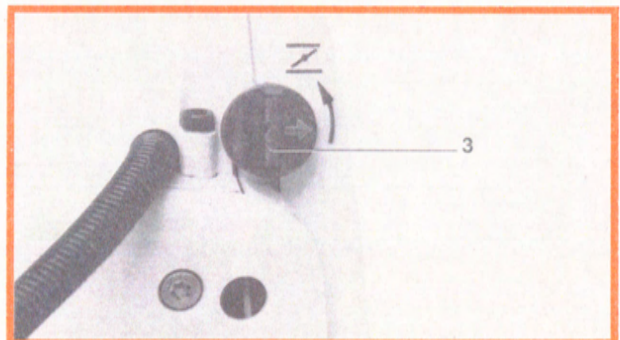
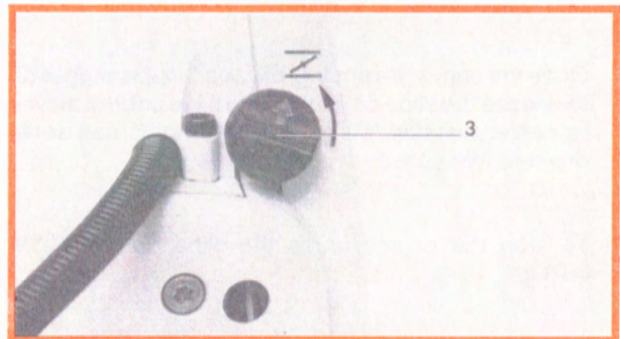

3. To start, hold the machine with your left hand on the drive tube. Pull the starter grip slowly with your right hand until you feel it engage and then give it a brisk strong pull. Do not pull the starter rope out more than about 70 cm (27") as it might otherwise break.

Do not allow the starter rope to snap back. Guide it slowly back into the housing so that it can rewind correctly.

Continue cranking the engine until it begins to fire. Then open the choke immediately (turn choke knob away from Σ) and continue cranking.

4. Once the engine is running, blip the throttle trigger (2) to release the slide control (1) (the slide control moves to center position "I") so that the engine can settle down to idle speed.
5. To stop the engine, push the slide control (1) to "STOP".

Top: Starting
Center: Throttle trigger in idle position, slide control in position "I"
Bottom: Slide control on "STOP"



Other Points to Observe when Starting the Engine:

When starting a cold engine only keep the choke closed until the engine begins to fire. Then open the choke fully (turn choke knob away from \bar{Z}), even if the engine stops and you have to continue cranking. If the choke is left closed, the combustion chamber will flood and stall the engine.

At very low outside temperatures the choke should only be opened half way (move choke lever to center position) and the engine allowed to warm up for a brief period using a little throttle. Then let go of the throttle trigger and open the choke fully.

If you have opened the choke as soon as the engine began to fire and the engine still does not run after several attempts, it is already flooded. In such a case, remove and dry off the spark plug. With the spark plug still removed, set the slide control to "STOP", open the throttle fully and then crank the engine over several times with the starter rope to clear the combustion chamber.

A new engine or one which has been run until the fuel tank is dry will not start first time after refueling because the carburetor's diaphragm pump has to be primed with fuel by cranking the engine over several times on the starter.

Carburetor

- 1 = High speed adjusting screw H
- 2 = Low speed adjusting screw L
- 3 = Idle speed adjusting screw LA

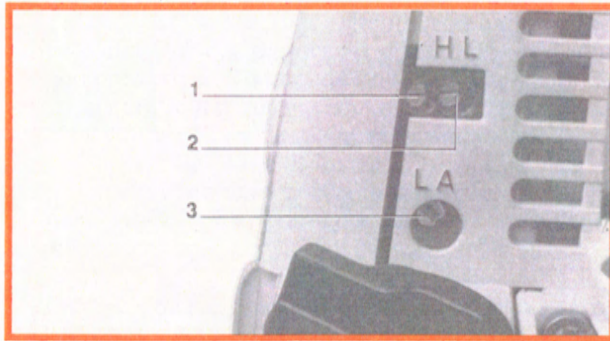

When the engine is tested at the factory the carburetor is set to obtain a slightly richer mixture to ensure that the cylinder bore and the bearings receive additional lubrication during the break-in period. This setting should be left as it is for the first three tank fillings. The high speed adjusting screw may then be turned no more than $\frac{1}{4}$ turn clockwise (leaner mixture). Caution: The engine's maximum permissible r.p.m. must not be exceeded!

If you use your Brushcutter at high altitudes (mountains) or at sea level it may be necessary to change the carburetor setting slightly. Carry out the correction at the two adjusting screws (L and H) as follows: Turn clockwise (leaner) for high altitude operation or counterclockwise (richer) for operation at sea level.

Note that even slight alterations on the adjusting screws have a noticeable effect on the engine's running behavior. Only carry out carburetor adjustments after cleaning the air filter and warming up the engine.

Caution: Adjustment of the high speed adjusting screw not only affects the power output but also the maximum off-load engine speed. If the setting is too lean (screw turned too far clockwise), the maximum permissible

engine speed will be exceeded. This can cause engine damage, brought about by lack of lubrication and overheating in particular. Corrections to the setting of the high speed adjusting screw may be carried out only if an accurate tachometer is available to check the maximum engine speed of 11500 r.p.m. (with cutting tool). Moreover, a cutting tool with a low drag coefficient (e. g. circular saw blade or brush knife) should be fitted for the adjustment.

Basic setting

If it is necessary to readjust the carburetor again from the beginning, first carry out the basic setting to obtain a starting point for fine adjustment. To do this, carefully screw the two adjusting screws down onto their seats (clockwise). Then make the following adjustment:

- High speed adjusting screw H:** back off 1 complete turn
- Low speed adjusting screw L:** back off 1 complete turn

If you have no means of checking the maximum engine speed, do not set the high speed adjusting screw any leaner by turning it beyond the basic setting.

Notes for adjusting idle speed

Engine stops while idling

Turn idle speed adjusting screw (LA) clockwise until cutting tool begins to rotate. Then back off one half turn. The cutting tool must not rotate.

Cutting tool rotates when engine is idling

Turn idle speed adjusting screw (LA) counterclockwise until cutting tool stops rotating and then turn it another one half turn.

Erratic idling behavior; poor acceleration

Idle setting too lean; turn low speed adjusting screw (L) counterclockwise until engine runs and accelerates smoothly.

Exhaust smokes at idle speed

Idle speed setting too rich; turn low speed adjusting screw (L) clockwise until engine speed drops. Then turn screw back one quarter turn and check that engine still accelerates smoothly when you open the throttle.

A correction at the low speed adjusting screw usually necessitates a change in the setting of the idle speed adjusting screw (LA).

Apart from minor readjustments, you should leave all carburetor setting and repair work to your STIHL dealer. STIHL dealers have trained staff and all the necessary servicing tools and equipment.

Air filter

Component parts in correct sequence

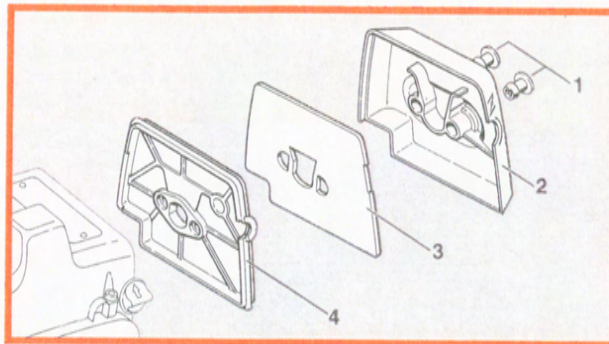

The purpose of an air filter is to prevent the dust and dirt in the intake air from entering the carburetor. It thus helps reduce wear on the engine components to a minimum.

Clogged air filters reduce engine power, increase fuel consumption and make starting more difficult.

The air filter must therefore be cleaned when engine power begins to drop off.

Before taking out the air filter, close the choke (turn choke knob to \bar{Z}) to stop dirt getting into the carburetor. Release the nuts (1) and remove the carburetor box cover (2) with filter plate (3) and air filter (4).

A natural bristle paint brush is an ideal tool for daily cleaning of the air filter and the inside of the carburetor box cover. Clean the felt element by knocking it on the palm of your hand or blowing it out with compressed air. Renew element if it is heavily loaded. However, the air filter should be washed in clean gasoline once a week and blown out with compressed air if possible.

Always replace a damaged filter.

Re-install the air filter in the reverse sequence.

Gearbox Lubrication

Applying the tube of grease

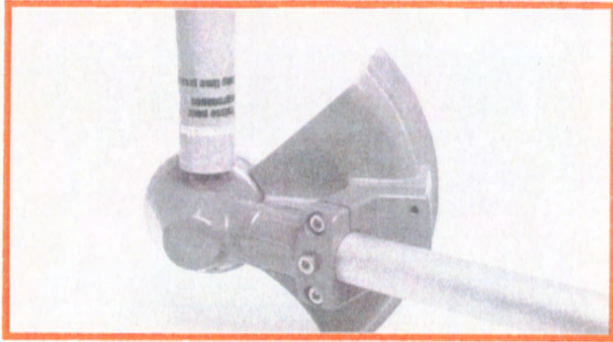

Use STIHL multipurpose grease (0781 120 1109) – a high grade longlife lubricant – for lubrication of the Brushcutter's bevel gearing.

The grease level should be checked in the event of a leak or at regular intervals (approx. every 15 to 20 hours of operation) and topped up as required.

To do this, remove the filler plug on the side of the gearbox. If no grease can be seen on the flanks of the gears, apply tube of grease to hole and force grease into the gearbox housing. **Important:** Do not completely fill the housing! It is sufficient to just cover the gears.

Refit the filler plug.

Sharpening the Brush Knife

Filing a cutting edge

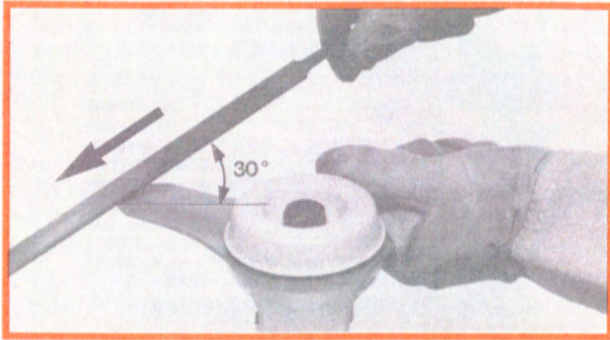

The brush knife can be sharpened either while it is still on the brushcutter or clamped in a vice.

Only sharpen the cutting edges at the pointed tips. It is not necessary to resharpen the curved cutting edges even if they are nicked in places.

A few strokes of a flat sharpening file (0814 212 3310) will be sufficient to restore the cutting edge if it is just slightly dull. If the cutting edges are blunt or chipped it will be necessary to file back all the tip cutting edges by the same amount. A grinder can also be used for this purpose. A symmetrical sharpening angle of 30° must always be maintained.

In order to avoid out-of-balance all the tips of the brush knife must have the same shape after sharpening. This can be checked with the sharpening template enclosed with the pack.

Warning! For safety reasons a bent or cracked brush knife must not be repaired!

Sharpening the Circular Saw Blade 200 (Chisel Tooth)

Top: Filing side plate of chisel tooth blade

Bottom: Filing angles on chisel tooth circular saw blade

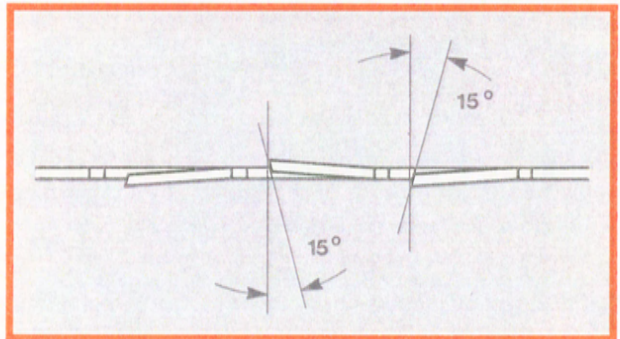
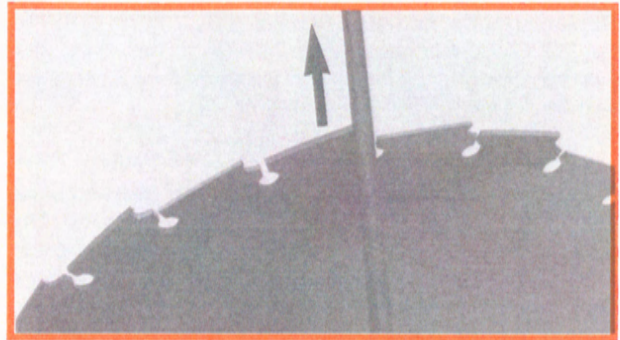

Chisel Tooth Circular Saw Blade 200

The chisel tooth circular saw blade can be resharpened with a 4.8 mm diameter round file (0811 411 8088). It is important to observe the filing angle (15°) and ensure that all the teeth have the same shape.

The blade can also be resharpened on an electric sharpener in the case of major or very uneven wear.

Your STIHL Service Shop will give full details.

Rewind Starter

Replacing a broken starter rope

First remove the mounting screws from the starter cover and lift it away.

Next, use a screwdriver or suitable pair of pliers to carefully remove the spring clip (1) from the starter post. The rope rotor (4) together with the pawl (3) and washer (2) can now be pulled off the starter post – this must be done very carefully because the inner loop of the rewind spring (5) has to slip out of the rope rotor. If you feel any resistance, turn the rope rotor slightly clockwise while pulling it.

If the rope rotor (4) is not removed carefully, there is a risk of the spring loop catching on it and popping out of the housing in the starter cover. If this happens, refit the rewind spring (5) in the spring housing as described under "Replacing a broken rewind spring".

Remove remaining rope from the rotor, thread in a new 3.5 mm dia. and 960 mm long (0.14 in dia. × 37.8 in long) starter rope (6) and secure it with a simple overhand knot at the pawl side of the rotor (4). Push the other end of the rope through the hole in the starter cover (from the inside outward) and through the underside of the starter grip (7). Secure rope with a double knot.

Top: Starter cover mounting screws
Center: Special knots used
Bottom: Component parts in correct sequence

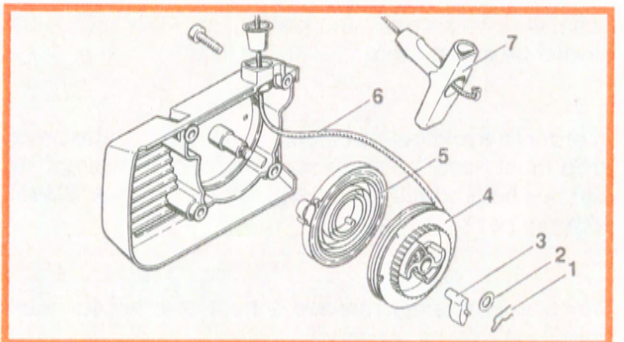
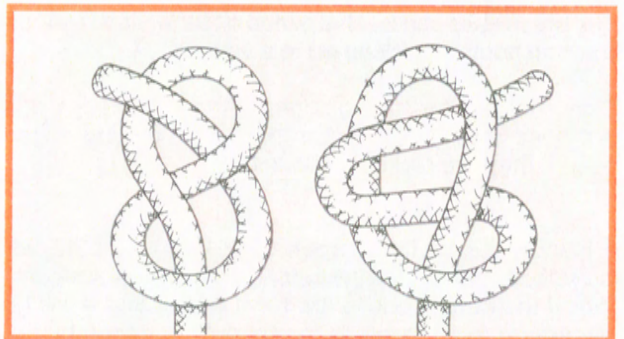
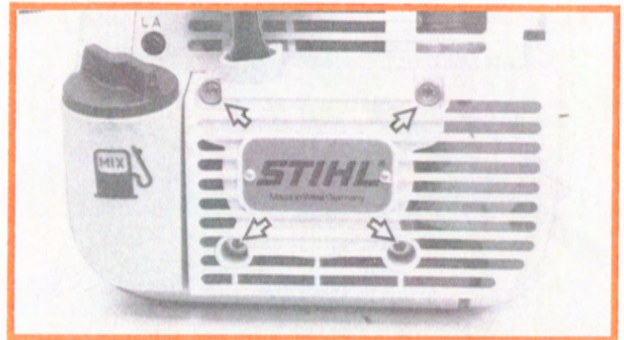

In the case of a new spring or one that has popped out of its seat it is necessary to check and correct the position of the inner spring loop before fitting the rope rotor (4).

Coat bore in rope rotor with non-resinous oil. Fit the rotor on the starter post so that the inner spring loop slides into the lug on the rotor. Position starter rope in notch on periphery of rotor at the same time. Check that spring loop has engaged by turning the rope rotor counterclockwise and letting it go – it must spring back.

Now insert pawl in rope rotor, slip the washer onto the starter post and use a screwdriver or suitable pliers to fit the spring clip, making sure that the spring clip engages on the pawl's guide pin and points it in the counterclockwise direction. Then tension the rewind spring.

Replacing a broken rewind spring

First remove the rope rotor (4). Take the spring housing and rewind spring (5) out of the starter cover.

The replacement spring and spring housing are supplied as an assembly. Lubricate the spring with a few drops of non-resinous oil before installing it.

Drop the rewind spring (5) and housing assembly (bottom plate area must face up) into the starter cover, making sure the outer spring loop engages over the cast lug on the fan housing. If the spring should pop out of its housing during installation, refit it in the counterclockwise direction, starting outside and working inwards. Reassemble the rope rotor (4) as above.

Top: Rewind spring with inner loop correctly positioned
Bottom: Fitting the spring clip

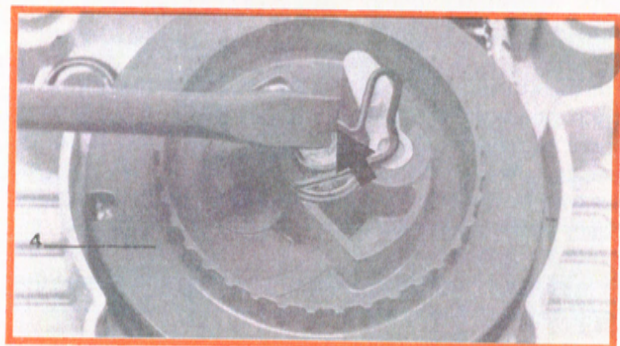
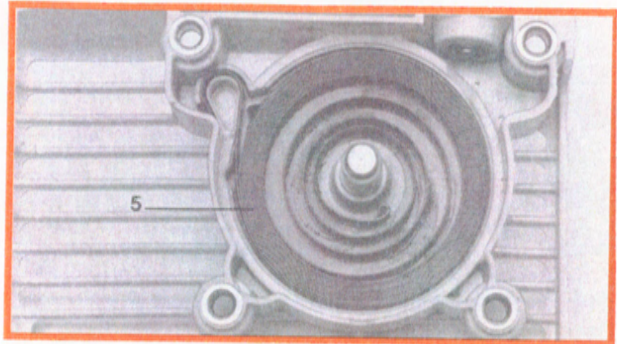

Tensioning the rewind spring

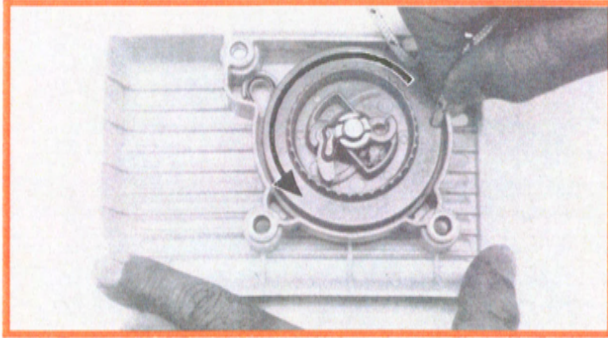

Tensioning the Rewind Spring

Pull the starter rope out as far as it will go. Make a loop in the rope between the rope rotor recess and the starter cover and use it to turn the rope rotor seven times counterclockwise. Hold the rope rotor steady, straighten out the twisted rope and pull it through the hole in the starter cover and hold firmly.

Release rope very slowly so that it can wind itself onto the rope rotor.

The rewind spring is correctly tensioned when the starter grip sits firmly on the starter cover without hanging to one side. When the starter rope is fully extended it must still be possible to rotate the rope rotor at least another half turn before maximum spring tension is reached. If this is not the case, hold the rope rotor firmly and take off one turn of the rope.

Do not overtension the rewind spring as this will cause it to break.

- 32** Finish off by refitting the starter cover. Position it on the crankcase so that the starter grip faces the fuel tank.

Maintenance Chart

		before starting work	after finishing work or daily	after each refueling stop	weekly	monthly	if faulty	if damaged	as required	see page:
Complete machine	Visual inspection (condition, leaks)	X		X						
	Clean		X							
Control grip (throttle trigger, slide control)	Check operation	X		X						15, 23
Air filter	Clean	X								27
	Replace							X		27
Filter in fuel tank	Check					X				
	Replace felt									
Fuel tank	Clean					X				
Carburetor	Check idle adjustment – cutting tool must not turn	X		X						26
	Readjust idle								X	26
Spark plug	Readjust electrode gap						X			29
Cooling inlets	Clean		X							
Cylinder fins	Clean				X				X	
Spark arrestor screen	Inspect		X							
	Clean or replace								X	
All accessible screws and nuts (not adjusting screws)	Retighten								X	
	Visual inspection	X		X						29
Steel cutting tools	Replace							X	X	19, 20
	Sharpen								X	29
	Visual inspection	X		X						
Plastic cutting blades	Replace							X	X	
	Check	X								28
Gearbox lubrication	Check	X								28
	Top up								X	28

The user of the Brushcutter may carry out only the maintenance operations described in this manual. Other repair work may be performed only by an authorized STIHL service shop.

Warranty claims following a repair will be accepted only if the repair has been carried out by an authorized STIHL servicing dealer using original STIHL parts.

Specifications

Engine

Single cylinder two-stroke engine

	FS 160	FS 180
Displacement:	29.8 cm ³ (1.82 cu. in)	35.2 cm ³ (2.15 cu. in)
Cylinder bore:	35 mm (1.38 in)	38 mm (1.50 in)
Piston stroke:	31 mm (1.22 in)	31 mm (1.22 in)

Ignition System

Type: Electronic (breakerless)
magneto ignition

Ignition timing: 2.0 . . . 2.3 mm before T.D.C.
(0.079–0.091 in)
at 8.000 r.p.m.

Spark plug
(suppressed): Bosch WSR 6 F
NGK BPMR 7 A
Heat range 200

Spark plug thread: Electrode gap 0.5 mm (0.02 in)
M 14x1.25; 9.5 mm (0.37 in) long

Fuel System

Carburetor: All position diaphragm
carburetor with integral
fuel pump

Air filter: Large area flat filter

Fuel tank capacity: 0.58 l (1.23 US pt)

Fuel mixture: See chapter "Fuel"

Gearhead

Type: Spiral toothed bevel gears

Ratio i: 1.33

Lubrication: STIHL multipurpose grease
(0781 120 1109)

34 **Weight**
without cutting tool: 7.1 kg (15.6 lb)

Special Accessories

STIHL-"Polycut 1" mowing head:

Mounting kit	4000 007 1040
Replacement cutting tool	4111 710 2100
Replacement blades (set of 12)	4111 007 1001

STIHL-"Polymatic 1" mowing head:

Mounting kit	4003 007 1060
Replacement cutting tool	4003 710 2100
Replacement nylon line (15.2 m/50 ft)	0000 930 2205

Brush knife 300:

Mounting kit	4000 007 1000
Replacement cutting tool	4119 713 4100

Circular saw blade 200 (chisel tooth):

Mounting kit	4000 007 1020
Replacement cutting tool	4119 713 4200

The mounting kits contain all the parts necessary for first-time fitting

Accessories

harness
Set of tools
Safety goggles

Explanation of used Symbols

1 = Always keep a 30 ft distance from persons while operating the brushcutter

2 = Rotating direction of cutting tool on stop
3 = Rotating direction of cutting tool on deflector

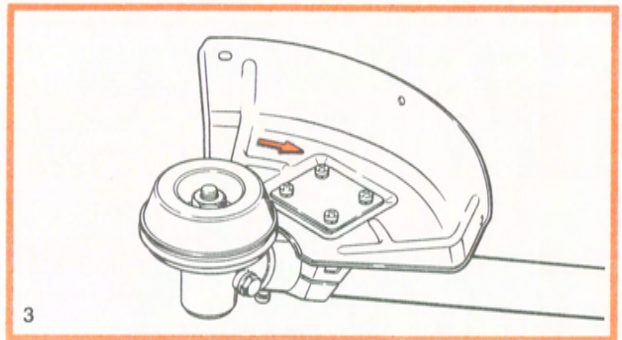
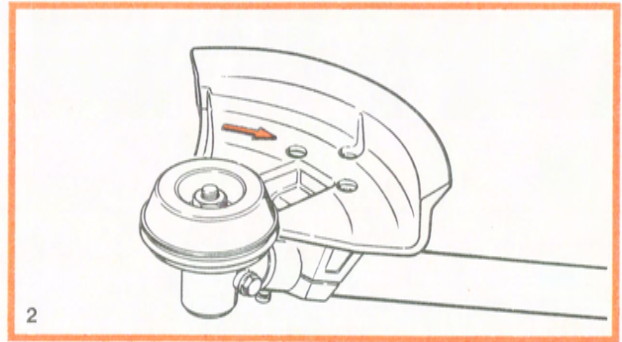
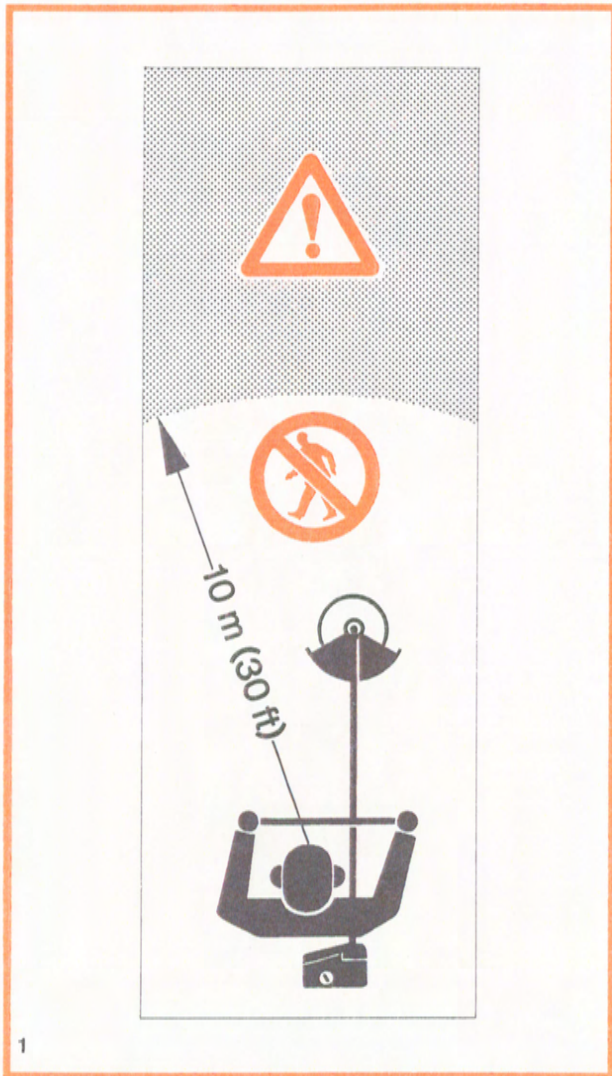

englisch/english