

STIHL TS 350

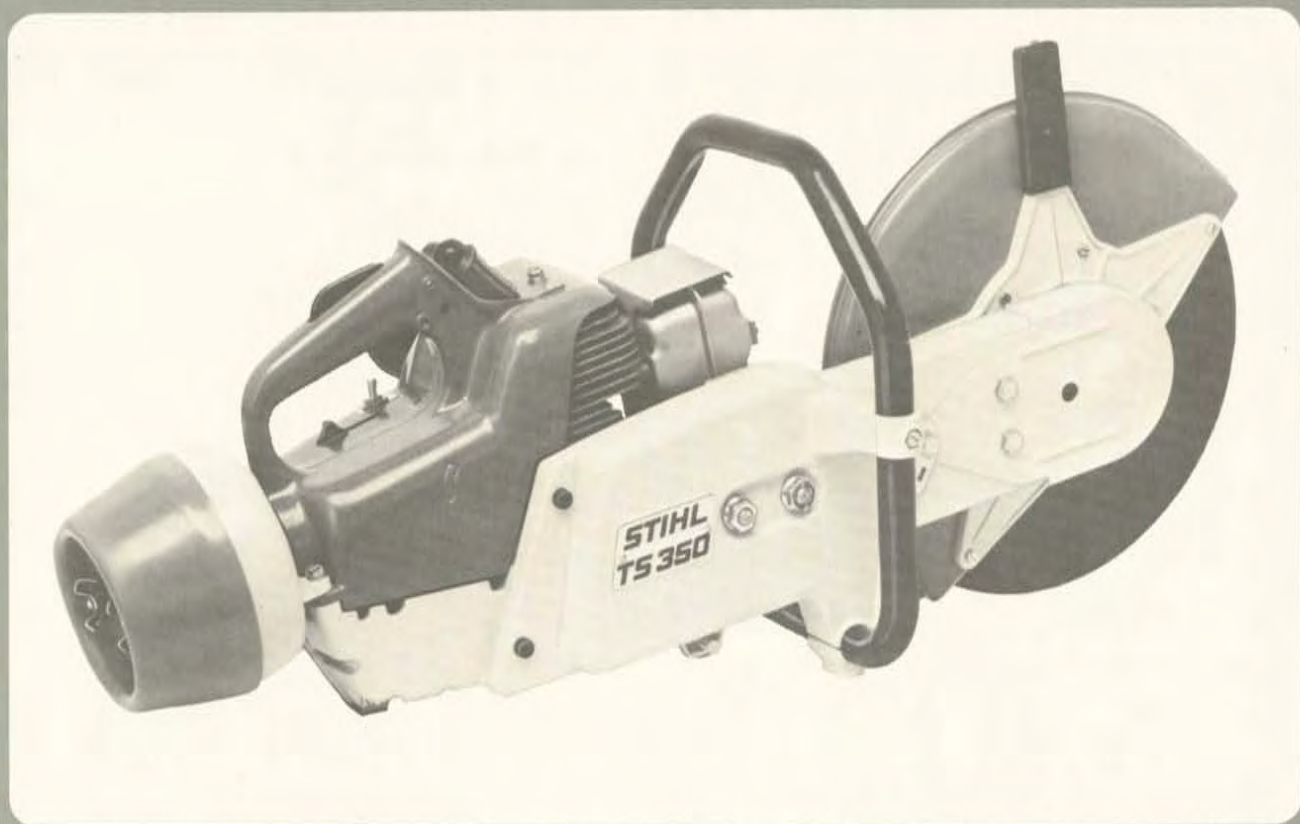

STIHL®

Contents

Main Parts of the TS 350 Cutquik™	2	Starting	20	<p>This Manual contains operating and safety instructions for your STIHL TS 350 Cutquik™. Pay special attention to the safety precautions outlined on pages 4 to 14. Allow only persons who understand this Manual to operate your cut-off machine. To receive maximum performance and satisfaction from your STIHL cut-off machine, it is important that you read and understand the maintenance and safety precautions before using your cut-off machine. Contact your STIHL dealer or the STIHL distributor for your area if you do not understand any of the instructions in this Manual.</p> <p>Because a cut-off machine is a high-speed cutting tool, some special safety precautions must be observed as with any other cut-off machine to reduce the risk of personal injury. Careless or improper use may cause serious or even fatal injury.</p> <p>STIHL's philosophy is to continually improve all of its products. As a result, engineering changes and improvements are made from time-to-time.</p> <p>If the operating characteristics or the appearance of your cut-off machine differs from those described in this Manual, please contact your STIHL dealer for information and assistance.</p>
Definitions	3	Checking Spark Plug	22	
Safety precautions	4	General Notes on Operation	22	
The operator	4	Air filter	23	
- The cut-off machine	6	Adjusting Carburetor	24	
- The use of the cut-off machine	7	Motor Management	24	
- Maintenance, repair and storing of the cut-off machine	13	Rewind Starter	25	
Storing the Machine	14	Changing the V-belt	27	
Mounting the Arbor Bearing and Guard	15	STIHL Cutquik™ Cart	28	
Tensioning the V-belt	16	Spark arresting screen in the muffler	28	
Abrasive Wheels	17	Maintenance chart	29	
Limiting Adjustment on Abrasive Wheel Guard	17	Specifications	30	
Mounting the Abrasive Wheel	18	Andreas Stihl Limited Warranty		
Fuel mix	19	Federal Emission Control Systems		
Fueling	19	Utility Engines	31	

Printed on chlorine-free paper.
 Printing inks contain vegetable oils,
 paper is recyclable

© 1999 Andreas Stihl AG & Co., Waiblingen
 0458 330 3021. M6. H9. T. Printed in Germany



Main Parts of the TS 350 Cutquik™

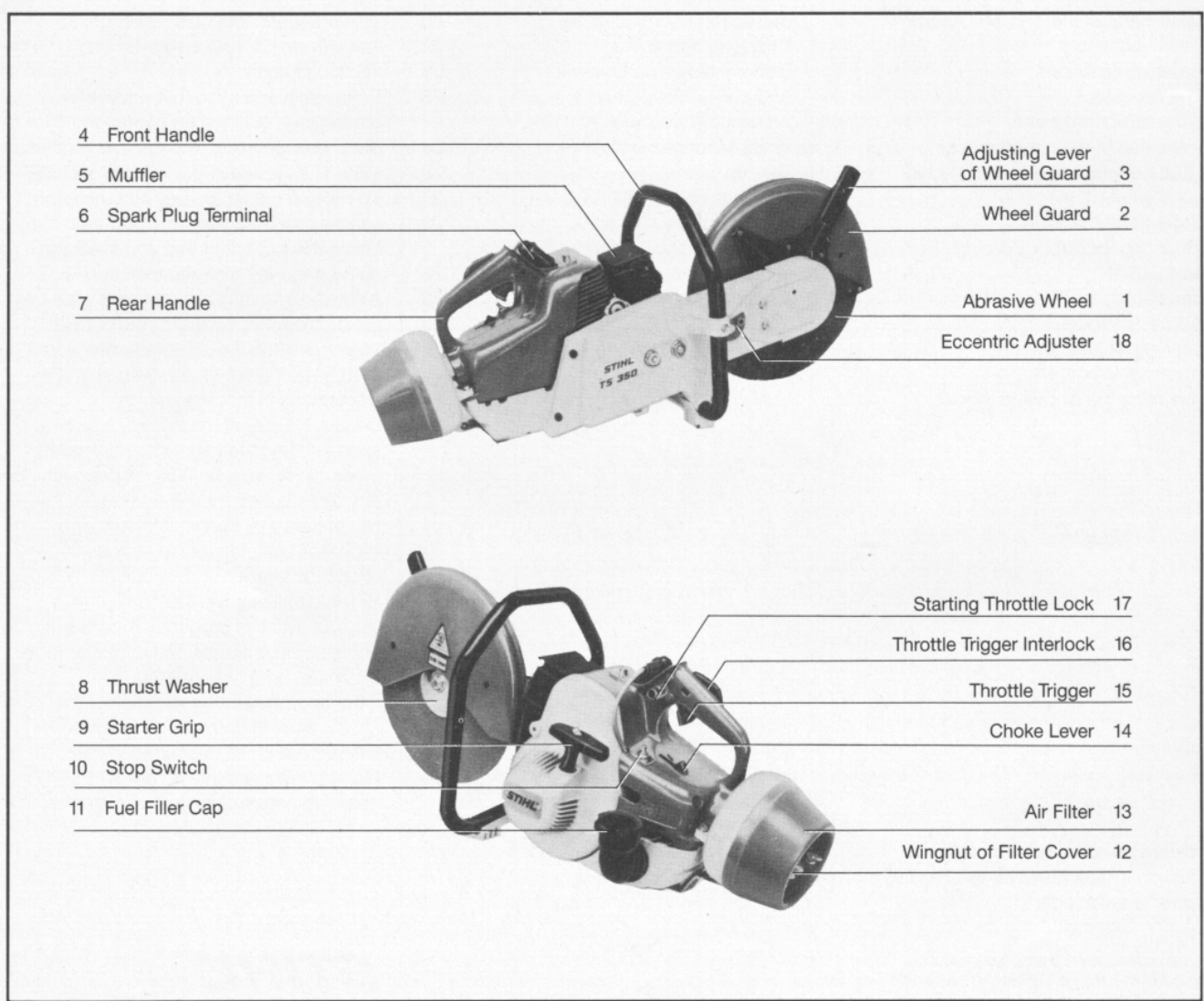

4 Front Handle

5 Muffler

6 Spark Plug Terminal

7 Rear Handle

Adjusting Lever
of Wheel Guard 3

Wheel Guard 2

Abrasive Wheel 1

Eccentric Adjuster 18

8 Thrust Washer

9 Starter Grip

10 Stop Switch

11 Fuel Filler Cap

Starting Throttle Lock 17

Throttle Trigger Interlock 16

Throttle Trigger 15

Choke Lever 14

Air Filter 13

Wingnut of Filter Cover 12

Definitions

- 1. Abrasive Wheel:**
Can either be an abrasive wheel or a diamond abrasive wheel.
 - 2. Wheel Guard:**
Guards the wheel and deflects sparks.
 - 3. Adjusting Lever of Wheel Guard:**
For adjusting the wheel guard in a way that the beam of sparks is directed away from the operator and the machine.
 - 4. Front Handle:**
Handle bar for the left hand at front of cut-off machine.
 - 5. Muffler:**
Reduces engine exhaust noise and directs the exhaust gases.
 - 6. Spark Plug Boot:**
Connects the spark plug with the ignition wire.
 - 7. Rear Handle:**
The support handle for the right hand, located at or toward the rear of the cut-off machine.
 - 8. Thrust Washer:**
Distributes clamping pressure of mounting nut evenly over abrasive wheel.
 - 9. Starter Grip:**
The grip of the pull starter which is the device to start the engine.
 - 10. Stop Switch:**
Switches the engine's ignition system off and stops the engine.
 - 11. Fuel Filler Cap:**
For closing the fuel tank. (Fits on fuel filler neck).
 - 12. Wing Nuts of Filter Cover:**
For removing filter cover to permit filter to be cleaned.
 - 13. Air Filter:**
Prevents dust and foreign matter from entering the carburetor. (Not illustrated)
 - 14. Choke Lever:**
A control used when starting cold engine.
 - 15. Throttle Trigger:**
Controls the speed of the engine.
 - 16. Throttle Trigger Interlock:**
Must be depressed before activating the throttle trigger.
 - 17. Starting Throttle Lock:**
Keeps the throttle partially open during starting.
 - 18. Eccentric Adjuster:**
For tensioning the V-belt.
- Clutch:**
Couples engine to the V-belt pulley when engine is accelerated beyond idle speed. (Not illustrated)
- V-Belt Pulley:**
The wheel that drives the V-belt and the abrasive wheel. (Not illustrated)
- Note:**
Different models may have different parts and controls.

Safety Precautions



The use of any cut-off machine may be hazardous. Because a cut-off machine is a high-speed, fast-cutting power tool, special safety precautions must be observed to reduce the risk of personal injury and fire.

It is important that you read, fully understand and observe the following safety precautions and warnings.



Read the Owner's Manual and the safety instructions periodically.

Careless or improper use of any cut-off machine may cause serious or fatal injury.

Have your STIHL dealer show you how to operate your cut-off machine. Observe all applicable local safety regulations, standards and ordinances.



Warning!

Minors should never be allowed to use a cut-off machine. Bystanders, especially children and animals should not be allowed in the area where a cut-off machine is in use. Never let the cut-off machine run unattended.

Do not lend or rent your cut-off machine without the Owner's Manual. Be sure that anyone using your cut-off machine understands the information contained

in this manual. Employers should establish a training program for operators of gasoline powered, hand held portable, cut-off machines to assure safe operation of these machines. These safety precautions and warnings apply to the use of all STIHL Cutquiks™.

Different models may have different parts and controls. See the appropriate section of your owner's manual for a description of the controls and function of the parts of your model cut-off machine.

Safe use of a cut-off machine involves

- the operator
- the cut-off machine
- the use of the cut-off machine.

THE OPERATOR

Physical Condition

You must be in good physical condition and mental health and not under the influence of any substance (drugs, alcohol, etc.) which might impair vision, dexterity or judgement. Do not operate a cut-off machine when you are fatigued. Be alert - if you get tired while operating your cut-off machine, take a break, tiredness may result in loss of control.

Working with any cut-off machine can be strenuous. If you have any condition that might be aggravated by strenuous work, check with your doctor before operating a cut-off machine.



Warning!

Prolonged use of cut-off machines (or other machines) exposing the operator to vibrations may produce whitefinger disease (Raynaud's phenomenon) or carpal tunnel syndrome. These conditions reduce the hand's ability to feel and regulate temperature, produces numbness and burning sensations and cause nerve and circulation damage and tissue necrosis. All factors which contribute to whitefinger disease are not known, but cold weather, smoking and diseases or physical conditions that affect blood vessels and blood transport, as well as high vibration levels and long periods of exposure to vibration are mentioned as factors in the development of whitefinger disease. In order to reduce the risk of whitefinger disease and carpal tunnel syndrome, please note the following:

- Most STIHL cut-off machine models are available with an anti-vibration ("AV") system designed to reduce the transmission of vibrations created by the engine to the operator's hands. An AV system is recommended for those persons using cut-off machines on a regular or sustained basis.
- Wear gloves and keep your hands warm.
- Keep the AV system well maintained. A cut-off machine with loose components or with damaged or

worn AV buffers will tend to have higher vibration levels.

- Maintain a firm grip at all times, but do not squeeze the handles with constant, excessive pressures, take frequent breaks.

All the above mentioned precautions do not guarantee that you will not sustain whitefinger disease or carpal tunnel syndrome. Therefore continual and regular users should monitor closely the condition of their hands and fingers. If any of the above symptoms appear, seek medical advice immediately.

Proper Clothing



Clothing must be sturdy and snug-fitting, but allow complete freedom of movement. Avoid loose-fitting jackets, scarfs,

neckties, jewelry, flared or cuffed pants, unconfined long hair or anything that could become caught on any obstacles or moving parts of the unit. Wear overalls or long pants to protect your legs. Do not wear shorts.



Warning!

When cutting metal, a cut-off machine generates sparks which can ignite clothing. Most fabrics used in clothing are flammable - even flame retardant fabrics will ignite at higher temperatures. To reduce the risk of burn injury STIHL recommends wearing clothing made of leather, wool, flame-retardant treated

cotton or a tightly woven, heavier cotton such as denim. Some flame-retardant synthetic fabrics are also suitable but others such as polyester, nylon, rayon and acetate can melt during fire into a tar-like matter that burns into the skin. Keep clothing free of oil, fuel, grease and other flammable substances.



Protect your hands with gloves when handling the cut-off machine.

Heavy-duty, nonslip gloves improve your grip and protect your hands.



Good footing is most important in cut-off machine work.

Wear sturdy boots with nonslip soles. Steel-toed

safety boots are recommended.



Warning!

Loose objects may be thrown toward the operator by the cutting tool.



To reduce the risk of injury to your eyes never operate a cut-off machine unless wearing goggles or properly fitted safety

glasses with adequate top and side protection complying with ANSI Z 87.1. Proper eye protection is a must.

Wear an approved safety hard hat to protect your head. cut-off machine noise may damage your hearing.

Always wear sound barriers (ear plugs or ear muffers) to protect your hearing. Regular users should have their hearing checked regularly.



Warning!



Use of this product to cut masonry, concrete, metal and other materials can generate dust, mists and fumes containing

chemicals known to cause serious or fatal injury or illness, such as respiratory disease, cancer, birth defects or other reproductive harm. If you are unfamiliar with the risks associated with the particular material being cut, review the material safety data sheet and/or consult your employer, the material manufacturer/-supplier, governmental agencies such as OSHA and NIOSH and other sources on hazardous materials. California and some other authorities, for instance, have published lists of substances known to cause cancer, reproductive toxicity, etc.

Control dust, mist and fumes at the source where possible. In this regard use good work practices and follow the recommendations of the manufacturer/-supplier, OSHA/NIOSH, and occupational and trade associations. A water attachment kit is available for your cut-off machine and should be used for dust suppression when wet cutting is feasible. When the inhalation of dust, mists and fumes cannot be eliminated, the operator

and any bystanders should always wear a respirator approved by NIOSH/MSHA for the material being cut.

 **Warning!**

Cutting masonry, concrete and other materials with silica in their composition may give off dust containing crystalline silica. Silica is a basic component of sand, quartz, brick clay, granite and numerous other minerals and rocks. Repeated and/or substantial inhalation of airborne crystalline silica can cause serious or fatal respiratory diseases, including silicosis. In addition, California and some other authorities have listed respirable crystalline silica as a substance known to cause cancer. When cutting such materials, always follow the respiratory precautions mentioned above.

 **Warning!**

Breathing asbestos dust is dangerous and can cause severe or fatal injury, respiratory illness or cancer. The use and disposal of asbestos-containing products have been strictly regulated by OSHA and the Environmental Protection Agency. Do not use your cutting-off machine to cut or disturb asbestos, asbestos-containing products, or products such as pipes which are wrapped or covered with asbestos insulation. If you have any reason to believe that you might be cutting asbestos, immediately contact your employer or a local OSHA representative.

THE CUT-OFF MACHINE

Parts of the cut-off machine, illustrations and definitions of the parts see pages 2 and 3.

 **Warning!**

Never modify a cut-off machine in any way. Only attachments supplied by STIHL or expressly approved by STIHL for use with the specific STIHL cut-off machine models are authorized. Although certain unauthorized attachments are useable with the STIHL powerhead, their use may, in fact be extremely dangerous.

 **Warning!**

Dust may collect on the powerhead, especially around the carburetor and may collect gasoline resulting in danger of fire. Clean dust from the powerhead regularly.

Abrasive wheels

 **Warning!**

Before assembling your cutting wheel make sure that the maximum operating wheel speed is above or equal to the spindle speed of your cut-off machine as provided in the Specifications of this manual.

Abrasive wheels for free-hand cutting are subjected to particularly high bending and compressive stresses.

 **Warning!**

Unauthorized wheels may shatter or break. Use only STIHL wheels or other authorized wheels with approved RPM ratings.



Inspect the abrasive wheel frequently and replace immediately if the abrasive wheel is cracked or warped. Cracked or warped wheels may shatter or break and cause serious personal injury.

Out-of-round or unbalanced abrasive wheels increase vibration and reduce the service life of the cut-off machine. Use STIHL wheels approved for this unit. Abrasive wheels are heat sensitive.

Always store your cut-off machine in a place where the cutting wheel is not exposed to direct sunlight or other sources of heat. Store spare cutting wheels in a dry place where there is no risk of frost damage. Failure to follow these directions may cause the wheel to shatter or crack in use causing serious or fatal injury.



Warning!

Never use carbide-tipped, wood-cutting or circular saw blades. They can cause severe personal injury from reactive forces, blade contact or thrown objects. Your STIHL dealer stocks a range of special abrasive wheels for the many applications of the cut-off machine.



Warning!

Use of the wrong abrasive wheel or material for which it was not designed may cause that wheel to shatter causing serious or fatal injury.

Only use the abrasive wheel approved for the type of material to be cut. There are different abrasive wheels each specially marked, for example:

1. Stone
Also can be used for concrete, masonry, reinforced concrete and brick cutting.
2. Steel
Can be used for all ferrous metal cutting.
3. Asphalt
Also can be used for aggregate concrete cutting.
4. Ductile iron
Also can be used for certain grades of cast iron (SG 17-24), bronze and copper cutting.

For cutting composite materials please ask your STIHL dealer.

Diamond abrasive wheels

Diamond abrasive wheels have a much better cutting performance than the abrasive wheels. The wheels are steel centered and diamond particles are imbedded in their cutting edges.

They can be used for concrete, asphalt, natural stone, clay pipe, brick and the like.

They are not suitable for cutting metal or other materials.

Wet or dry cutting is possible. With wet cutting you get a longer life of your wheel. Water attachments are available for your STIHL cut-off machine. See the appropriate section of your owner's manual.



Warning!

Do not remount a used diamond abrasive wheel without first inspecting for under-cutting, flatness, core fatigue, segment damage or loss, signs of overheating (discoloration) and possible arbor hole damage.

Check the wheel for cracks and make sure that no pieces have broken off the wheel before use.

Always fit the wheel so that the arrow on the wheel points in direction of the rotation of the spindle.

THE USE OF THE CUT-OFF MACHINE

Transporting the Cutquik™



Warning!

Always stop the engine before putting a cut-off machine down or carrying it. The abrasive wheel continues to rotate for a short while after the throttle trigger is released (flywheel effect). Carrying a cut-off machine with the engine running is extremely dangerous. Accidental acceleration of the engine can cause the wheel to rotate. Avoid touching the hot muffler.

By hand: When carrying your cut-off machine by hand, the engine must be stopped and the cut-off machine must be in the proper position. Grip the front handle and place the muffler at the side away from the body.



Warning!

Always protect the cutting wheel from hitting the ground or any other objects. Damaged wheels may shatter and cause serious or fatal injury.

By vehicle: Properly secure your cut-off machine to prevent turnover, fuel spillage and damage to the cut-off machine.

Never transport with cutting wheel mounted.

A wheel damaged during transportation may shatter during operation and cause serious personal injury.

Preparation for the use of the cut-off machine

For assembly, follow the procedure described at the appropriate section of your owner's manual.

Before operation of your cut-off machine be sure the controls (e.g. throttle trigger, stop switch.) and the safety devices are working properly, the carburetor idle and maximum speed are correctly adjusted, and the wheel guard is in place and securely fastened to your unit.

All wheels should be carefully inspected for good condition before mounting.



Adjust the wheel guard so that sparks, dust and cut material are deflected away from the operator, and cannot reach

flammable surroundings. See operating instructions of your owner's manual.

Never operate a cut-off machine that is damaged, improperly adjusted or not completely and securely assembled. Inspect for safety in operation.

Proper tension of the V-belt is important. In order to avoid a false setting the tensioning procedure must be followed as described in your Manual. Always

make sure the hexagonal collar nuts for the cast arm are tightened securely. Check V-belt tension after one hour of operation and correct if necessary.



(for TS 350 and TS 360 only)

The STIHL TS 350 and TS 360 Cutquik™ is supplied with a fuel filler elbow connector to facilitate easier refueling. Always keep the connector and fuel filler cap tightened and properly sealed. A loose or improperly seated connector or cap may vibrate loose during operation causing fuel spillage which may result in a fire which can cause serious or fatal injury. Never operate the unit with a cracked, broken or improperly seated or adjusted filler neck. This could permit fuel leakage and lead to fire. Do not fill tank above the threefourths level of the neck entry diameter into the tank. Do not fill tank above the "max" line on the fuel filler elbow. Overfilling reduces the room in the tank for fuel expansion and may lead to fuel spillage through the tank vent and risk of fire.

Fueling

Your STIHL cut-off machine uses an oil-gasoline mixture for fuel (see chapter "Fuel" of your owner's manual).



Warning!



Gasoline is an extremely flammable fuel. If spilled or ignited by a spark or other ignition source, it can cause fire and serious burn injury or property damage. Use extreme caution when handling gasoline or fuel mix. Do not smoke or bring any fire or flame near the fuel.

Fueling Instructions

Fuel your cut-off machine in well-ventilated areas, outdoors only. Always shut off the engine and allow it to cool before refueling. Relieve fuel tank pressure by loosening the fuel cap slowly.

Select bare ground for fueling and move at least 10 feet (3 m) from fueling spot before starting the engine. Wipe off any spilled fuel and check for leakage.



Warning!

If fuel gets spilled on clothes, especially trousers, it is very important to change clothes immediately. Do not rely upon evaporation. Flammable quantities of fuel may remain on clothes after a spill for longer than expected. Cutting metal with cut-off machine when clothes are wet or damp from gasoline is extremely dangerous as the operator's clothes

might catch fire and cause serious or fatal injury.

Always make sure that the fuel cap is tightened securely. Check for fuel leakage while refueling and during operation. If a fuel leak is suspected, do not start or run the engine until leak is fixed and spilled fuel has been wiped away.

 **Warning!**



Unit vibrations can cause an improperly tightened fuel cap to loosen or come off and spill quantities of fuel.

In order to reduce risk of fuel spillage and fire, tighten fuel cap by hand with as much force as possible. The screw driver end of the STIHL combination wrench or other similar tool can be used as an aid in tightening slotted fuel caps.

Starting

 **Warning!**

Your cut-off machine is a one-person tool. Do not allow other persons to be near the cut-off machine. Start and operate your cut-off machine without assistance. For specific starting instructions, see the appropriate section of your owner's manual.

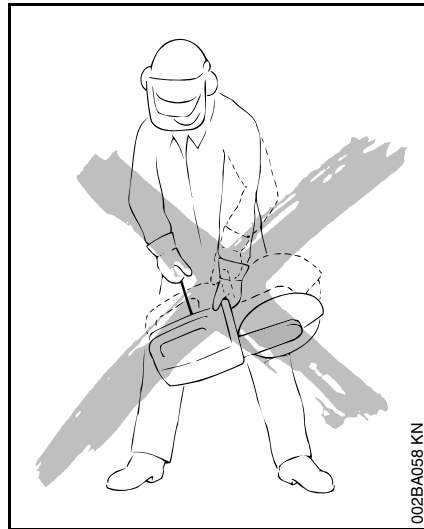

Do not drop start. This method is very dangerous because you may lose control of the cut-off machine. Place the cut-off machine on firm ground or other solid surface in an open area.

Maintain a good balance and secure footing. Be absolutely sure that the cutting wheel is clear of you and all other obstructions and objects, including the ground; because when the engine starts at starting-throttle, engine speed will be fast enough for the clutch to engage V-belt pulley and turn the wheel. Never attempt to start the cut-off machine when the abrasive wheel is in a cut. When you pull the starter grip, don't wrap the starter rope around your hands.

Do not allow the grip to snap back, but guide the starter rope slowly back to permit the rope to rewind properly. Failure to follow this procedure may result in injuries to hand or fingers and may damage the starter mechanism. Always stop the engine and be sure the wheel has stopped rotating before setting down the cut-off machine.

Working Conditions

Operate the cut-off machine under good visibility and daylight conditions only.

 **Warning!**



Your cut-off machine produces poisonous exhaust fumes as soon as the combustible engine is running. These gases (e.g. carbon monoxide) may be colorless and odorless.

To reduce the risk of serious or fatal injury from breathing toxic fumes, never run the cut-off machine indoors or in poorly ventilated locations. Ensure proper ventilation when working in trenches or other confined areas.

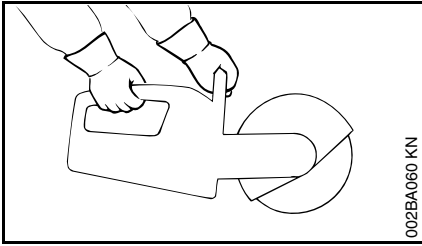

Never use the cut-off machine with one hand. Your STIHL cut-off machine is designed for hand-held use or operation on a cut-off machine cart. Cutting with your cut-off machine resting on the ground or other surface can cause excessive wear to the bracket designed to protect the bottom of the tank housing. Loss of fuel and personal injury from fire may result. Replace damaged or badly worn brackets immediately.

Grip: Always hold the cut-off machine firmly with both hands when the engine is running. Place your left hand on front handle bar and your right hand on rear handle and throttle trigger.

Left-handed users should follow this instruction too.

Wrap your fingers tightly around the handles, keeping the handles cradled between your thumbs and forefingers. Make sure your cut-off machine handles and grip are in good condition and free of moisture, pitch, oil or grease.

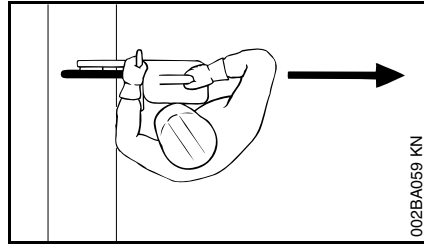

Avoid standing in direct line with the wheel.



Warning!

Take extreme care in wet and freezing weather (rain, snow, ice). Clear the area where you are working.



Warning!

Avoid stumbling on obstacles and watch out for holes or ditches. Be extremely cautious when working on slopes or uneven ground.



Warning!

Never operate the cut-off machine with the starting-throttle lock engaged as this does not permit proper control of the speed of the unit and may lead to serious injury.

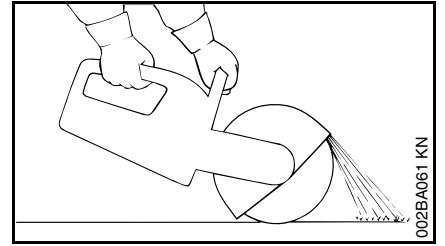

Warning!

Sparks from cutting metal can burn or cause clothing to catch fire. Don't use a cut-off machine on flammable ground. Always direct sparks away from the operator or any flammable surroundings.



Warning!

To reduce the risk of injury from fire, do not cut into any pipe, drum or other container without first insuring that it does not contain volatile or flammable substance.

Operating Instructions



Warning!

The wheel guard is adjustable. It is extremely important that the wheel guard is in place and set to suit the type of work and your stance. The guard should always be adjusted so that the user is not endangered by particles of the material being cut, sparks or pieces of damaged wheels either directly or by

ricochet. Failure to follow this instruction could result in serious or fatal injury. The ideal working speed of the cut-off machine depends on many factors, e. g., the material being cut, the type and quality of the cutting wheel.

It is essential to determine the direction of the cut exactly before applying the abrasive wheel to the work. Wheels are constructed for **radial** pressure only. **Lateral** pressure must be avoided.

Check for cracks and make sure that no pieces have broken off from the wheel when it is stopped. Check the wheel guard for cracks. If you discover any cracks, fit a new guard.



Warning!

Hold the cut-off machine steady. Do not change the direction of the cut during the cut as this may produce a high torsional load on the abrasive wheel and may cause it to break or shatter.

To achieve a clean and efficient cut, pull the abrasive wheel across the work or move it "to and fro" in the cutting direction. Do not use force to push the abrasive wheel into the work.

Insert the wheel into the material only as deep as necessary to make the cut. To reduce the amount of dust created, do not cut all the way through stone and concrete materials - leave a thin piece uncut. For most such materials, this

piece can be easily broken afterwards. Do not cock, jam or wedge the wheel in the cut.



Warning!

Do not use abrasive wheels for rough grinding. Large bending stresses occur during such work and abrasive wheels may shatter or break and could cause serious or fatal injury.

If a cut-off machine cart is used, sweep debris from the path of the wheels as such may cause flexing of the abrasive wheel. This would result in high frictional forces and thus greatly reduce the engine power available for the actual cutting work.

Always use the cart to cut in a straight line.

Wet cutting with abrasive wheels

When cutting masonry with a water attachment:

1. Make certain water does not flow on wheel that is not running, since the wheel will absorb water and that will affect wheel balance.
2. Shut water off before wheel stops so that excess water will be dissipated.

3. Be certain water is applied to both sides of wheel, since uneven distribution can cause "one sided" wear with possible wheel breakage.
4. Use these wheels up the same day. Do not store and reuse a wheel that has been used with water.

Important Adjustments

At correct idle speed, wheel should not turn. For direction to adjust idle speed, see the appropriate section of your owner's manual.

Do not use a cut-off machine with incorrect idle speed adjustment. The rotating wheel may cause injury.

Have your STIHL dealer check your cut-off machine and make proper adjustments or repairs.

Never touch a rotating wheel with your hand or any part of your body.

Reactive forces



Warning!

Reactive forces may occur at any time the cutting wheel on at cut-off machine is rotating. If the wheel is slowed or stopped by frictional contact with any solid object or by a pinch, reactive forces may occur instantly and with great force.

These reactive forces may result in the operator losing control of the cut-off machine, which may, in turn, result in serious or fatal injury.

An understanding of the causes of these reactive forces may help you avoid loss of control. Reactive forces are exerted in a direction opposite to the direction in which the wheel is moving at the point of contact or pinch.

Pull-away, climbing and rotational forces.

The most common reactive forces are pull-away and climbing. If the contact is at the bottom of the wheel, a cut-off machine will try to pull away from the operator (pull-away). If the contact is at the front of the wheel, the wheel may attempt to climb the object being cut (climbing). If the wheel is severely pinched at the front, the wheel may be instantly thrown up and back towards the operator with a great force in a rotational motion. The greater the force generated, the more difficult it will be for the operator to control the cut-off machine. Any of the reactive forces can, in some circumstances, cause the operator to lose control of a cut-off machine, allowing the rotating wheel to come into contact with the operator. Severe personal injury or death can result.

Use only cutting attachment authorized by STIHL. **Never** use chipped abrasive

wheels, circular saw blades, carbide tipped blades, rescue blades or wood-abrasive or toothed blades of any nature on a cut-off machine. The use of such wheels or blades will greatly increase the risk of loss of control and severe personal injury or death from reactive forces, since the chipped section of an abrasive wheel, or the teeth of a saw blade may catch in the material being cut and generate substantially greater reactive forces.

Cut-off machines are designed for use with abrasive wheels in good condition **only**. Machines designed for use with wood-abrasive or other toothed blades use different types of guarding systems which provide the protection necessary for those types of blades. Machines, such as a cut-off machine, which are designed for use with abrasive wheels, require a different guarding system which is not designed to provide protection against all dangers presented by circular saw blades, carbide-tipped blades, rescue blades or wood-abrasive or toothed blades of any nature.



Warning!

To reduce the risk of injury from loss of control or from the shattering of an abrasive wheel:

1. Hold the cut-off machine firmly with both hands.
2. Maintain good balance and footing at all times. Never cut while standing on a ladder.
3. Do not exceed the maximum operating speed marked on the wheel.
4. Do not use a wheel that has been dropped.
5. Never use circular saw blades, carbide-tipped blades, rescue blades, wood-abrasive blades or toothed blades of any nature. Their use increases the risk of injury from reactive forces, blade contact and thrown tips.
6. Do not cut any material for which the abrasive wheel is not authorized.
7. Position the cut-off machine in such a way that your body is clear of the abrasive attachment.
8. Begin abrasive and continue at full throttle.
9. Do not overreach.

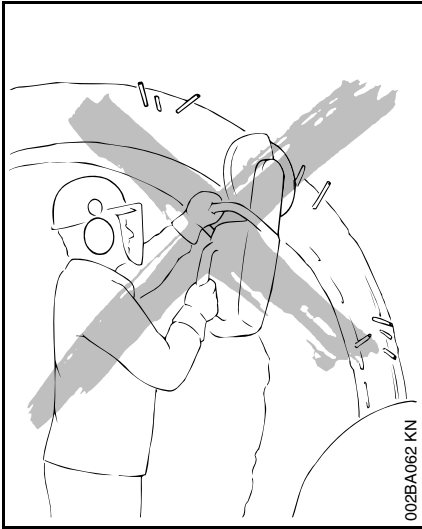

10. Do not cut above shoulder height.
11. Use your cut-off machine for abrasive only. It is not designed for prying or shoveling away any objects.
12. Do not grind on side of the abrasive wheel.
13. Do not twist, thrust, knock or drop the machine. This can cause damage to the wheel.
14. Be especially alert for reactive forces when abrasive with the front of the wheel.
15. Be alert to shifting of the work piece or anything that could cause the cut to close and pinch the wheel.
16. Release the pressure on the cut-off machine as you reach the end of the cut. Too much pressure may cause the operator to lose control of the cut-off machine when the abrasive wheel completes the cut. The abrasive wheel may contact the operator or strike some foreign object and shatter.
17. Use extreme caution when re-entering a cut and do not turn the wheel at an angle or push the wheel into the cut as this may result in a pinching of the wheel.

Maintenance, Repair and Storing of the Cut-Off Machine

Maintenance, replacement, or repair of the emission control devices and systems may be performed by any nonroad engine repair establishment or individual. However if you claim warranty for a component which has not been serviced or maintained properly or if nonapproved replacement parts were used, STIHL may deny warranty.

Never operate a cut-off machine that is damaged, improperly adjusted or not completely or securely assembled.

Follow the maintenance and repair instructions in the appropriate section of your owner's manual.

Use only STIHL replacement parts for maintenance and repair. Use of parts manufactured by others may cause serious or fatal injury.

Warning!

Always stop the engine and make sure that the wheel is stopped before doing any maintenance or repair work or cleaning the cut-off machine. Do not attempt any maintenance or repair work not described in your owner's manual. Have such work performed at your STIHL service shop only.

Clean grinding dust after finishing work. Empty the fuel tank before storing for longer than a few days.

Fuel may only be stored in correctly labeled and approved containers. Avoid direct skin contact and do not in-hale the petrol vapours.

Keep the handles dry, clean and free of oil and fuel. Tighten all nuts, bolts and screws except the carburetor adjustment screws after each use.

Storing the Machine



Warning!

Never test the ignition system with ignition wire terminal removed from spark plug or with unseated spark plug, since uncontained sparking may cause a fire.



Warning!

To reduce the risk of fire and burn injury, use only spark plugs authorized by STIHL. Always press spark plug boot snugly onto spark plug terminal of the proper size. (Note: If terminal has detachable SAE adapter nut, it must be attached.) A loose connection between spark plug terminal and ignition wire connector in the boot may create arcing that could ignite combustible fumes and cause a fire. Keep spark plug clean, and make sure ignition lead is in good condition.



Warning!

Do not operate your cut-off machine if the muffler is damaged, missing or modified. An improperly maintained muffler will increase the risk of fire and hearing loss.

Never touch a hot muffler or spill fuel or other flammable liquid over it. Burn injuries or fire will result. If your muffler was equipped with a spark-arresting screen to reduce the risk of fire (e. g. in the USA, Canada and Australia), never operate

your cut-off machine if the screen is missing or damaged.

For any maintenance please refer to the maintenance chart **and to the warranty statement** near the end of this manual.

Store spare wheels on a flat surface in a dry place preferably at a constant temperature where there is not risk of frost, preferably at a constant temperature. Store cut-off machine in a high or locked place, away from children.

Do not store a cut-off machine with a wheel mounted on the machine.

For periods of about 3 months or longer:

- Drain and clean the fuel tank.
- Run engine until carburetor is dry - this helps prevent the carburetor diaphragms sticking together.
- Remove the abrasive wheel.
- Thoroughly clean the machine - pay special attention to the cylinder fins and air filter.
- Store the machine in a dry, high or locked location - out of the reach of children and other unauthorized persons.

Mounting the Arbor Bearing and Guard

The cutting blade drive (bearing with arbor and blade guard) must be assembled before the machine is used for the first time. The arbor bearing can be mounted to the inboard or outboard side of the cast arm to suit cutting requirements. Under normal circumstances the drive should be mounted inboard of the arm because of the better balance and only mounted outboard when required.

Inboard mounting

First fit V-belt (1) on the belt pulley (2) and position the bearing plate (3) against the inside of the cast arm (4) so that the tapped holes line up with the slots in the cast arm.

Position V-belt guard (5) against the outside of the arm (4). Insert a hex. head screw (6) through one of the two front holes and screw it into the bearing plate-move V-belt guard to and fro to ease insertion. Now let go of the bearing. Fit the other two screws (6) through the holes in the V-belt guard (5) and screw them into the bearing plate - the eccentric adjuster (7) must be fitted on the rear screw.

Outboard mounting

Position the bearing plate (3) against the outside of the arm (4) and fit the V-belt (1) on the belt pulley (2). If the V-belt is new, this operation is easier if the M 10 hex. head nut (8) is turned counterclockwise with the combination wrench (17 mm), i.e. this turns the belt pulley (2). Position bearing plate (3) so that the tapped holes line up with the slots in the arm.

Top: V-belt in position for inboard mounting
Center: Tightening hex. head screw
Bottom: V-belt in position for outboard mounting

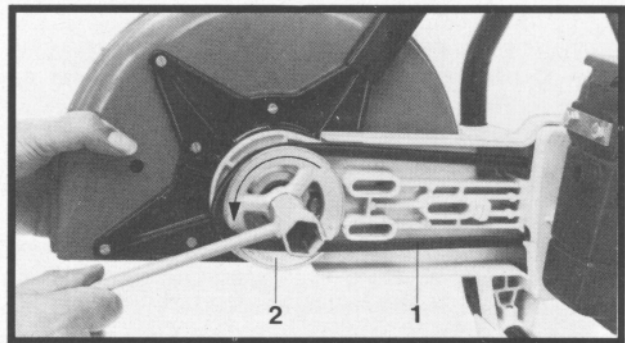
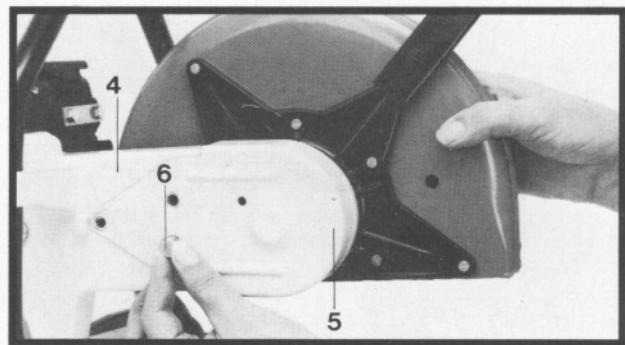
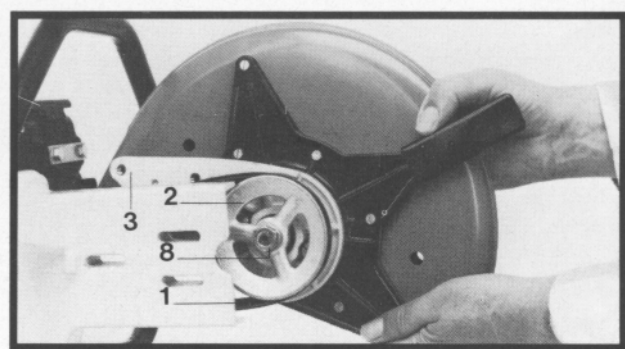

Tensioning the V-belt

Top: Inserting hex. head screw
Bottom: Bearing mounted outboard

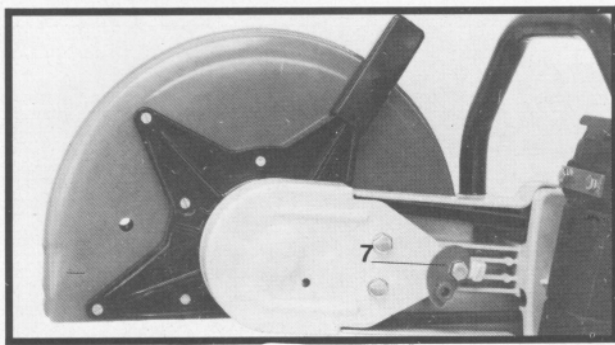
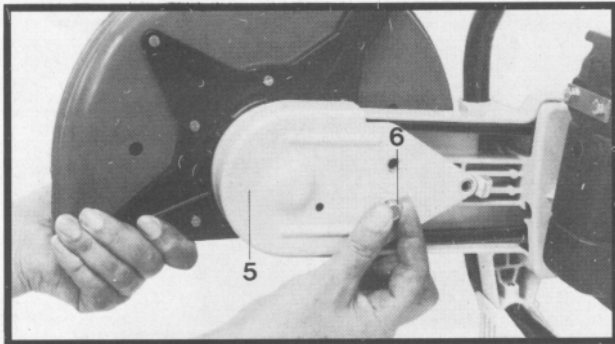

Fit the V-belt guard (5) on the inside of the arm. Insert a hex. head screw (6) through one of the two front holes and screw it into the bearing plate (3) - move V-belt guard (5) to and fro to ease insertion. The assembly sequence is otherwise as for "Inboard mounting".

When the cutting wheel is mounted outboard the wheel guard does not have the full 360° adjustment since the movement of the adjusting lever is restricted by the handlebar mounting, i. e. reduced by about 20°.

Turning eccentric adjuster to tension V-belt

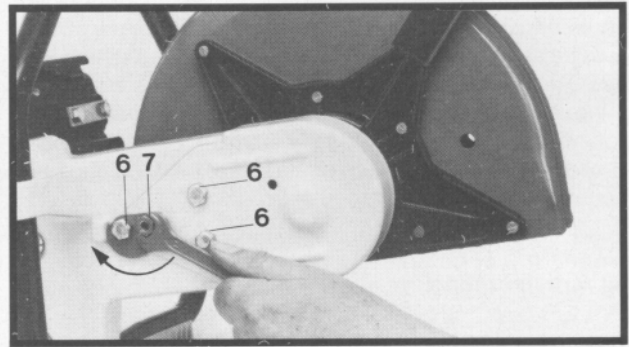

To tension the V-belt, first slacken off the two front hex. head screws (6) and moderately tighten the rear one (with eccentric adjuster). Then use a 13 mm open end wrench to turn the eccentric adjuster (7) clockwise. This causes the bearing to be shifted away from the engine and thus tension the V-belt.

Once the correct tension has been reached, release the eccentric adjuster (7) (as the rear hex. head screw has been tightened down slightly the bearing and adjuster remain in the set position). Then finally tighten down the hex. head screws (6), starting with the rear one (with eccentric adjuster).

The V-belt is correctly tensioned if it can be depressed slightly (5-10 mm/ $\frac{3}{16}$ - $\frac{3}{8}$ ") with moderate thumb pressure. Overtensioning of the V-belt will accelerate wear.

On a new machine, or if a new V-belt has been fitted, it is advisable to check V-belt tension after about 1 operating hour and correct it if necessary.

Abrasive Wheels

Cutting wheels for free-hand cutting operations are subjected to particularly high bending and compressive stresses. STIHL has therefore developed - together with leading abrasive wheel manufacturers - top quality cutting blades which exactly match the engine characteristics of the cut-off-saw. They are of a consistently high quality and perfectly balanced.

Out-of-round or poorly balanced abrasive wheels increase vibration and reduce the service life of the cut-off-saw. Good abrasive performance can only be achieved with the abrasive wheels supplied by STIHL.

Abrasive wheels are heat sensitive. Always store your cutoff-saw in a place where it is not exposed to direct sunlight or other sources of heat.

Store spare cutting wheels in a dry place where there is no risk of frost, preferably at a constant temperature.

Your STIHL dealer stocks a range of special abrasive wheels (3 and 6 mm / 0.12 and 0.24 in thick) for the manifold applications cut-off-saw. For example, wheels for abrasive bituminous material, gravel asphalt, stone, concrete, clay pipe, structural steel, highly alloyed steel, cast iron, non-ferrous metals etc.

Limiting adjustment on abrasive wheel guard

Adjustment range of abrasive wheel guard

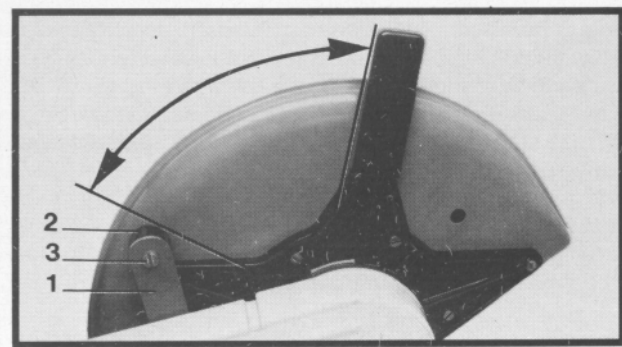

On the USA version a stop (1) is attached to the cut-off-saw's bearing plate.

The rubber buffer (2) of this stop projects through the flange of the abrasive wheel guard so that its adjustment is limited to the range shown (see illustration). This prevents the guard being turned too far.

It is necessary to take out the mounting screws (3) and remove the rubber buffer (2) to turn the guard through approx. 180° when the abrasive wheel is fitted on the out-board side of the cast arm. Then turn the guard to the required position and refit the rubber buffer on the stop.

Mounting the abrasive Wheel

The **engine must be switched off** and the arbor blocked before mounting or removing the abrasive wheel. To do this, push the locking pin squarely through the hole in the V-belt guard. If one of the V-belt pulley spokes is in the way, use the combination wrench to turn the arbor until the locking pin can be inserted.

Slacken off and remove the M 10 hex. head screw with the combination wrench (17 mm) and take it off the arbor together with the front thrust washer.

The cutting wheel can now be pulled off the arbor and taken out of the guard. This operation is made easier if the blade guard is turned so that its lower edge is vertical.

Before fitting the new abrasive wheel, check that the rear thrust washer is positioned so that the notch in its center hole engages over the lug on the arbor.

Mount the new abrasive wheel in the reverse sequence to that described above. Make sure that the locking tab on the front thrust washer engages in one of the two slots in the arbor. Use combination wrench to securely tighten the M 10 hex. head screw.

Pay attention to arrows for direction of rotation when fitting a diamond abrasive wheel.

If a wider kerf is required (e. g. for installing induction loops in road surfaces), **two diamond abrasive wheels** can be used side by side. In such a case it is essential to ensure that the segments of both wheels are positioned exactly next to one another.

Important! Two composite wheels must never be used simultaneously, for they may **break and cause injuries** as they wear down unevenly.

Top: Blocking the arbor
Center: Removing hex. head screw
Bottom: Rear thrust washer correctly positioned

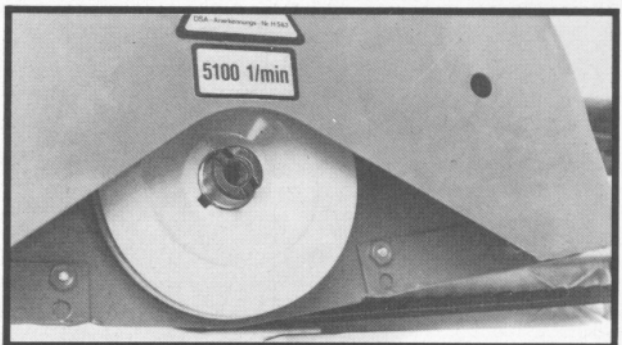
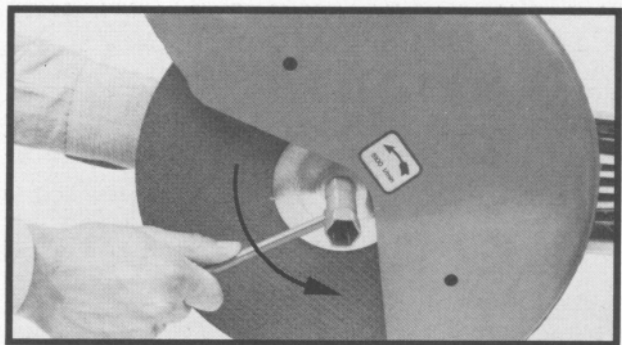
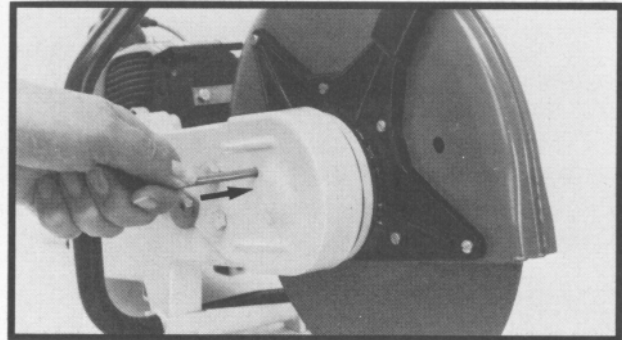

Fuel mix

This engine is certified to operate on unleaded gasoline and with the mix ratio 50:1.

Your two-stroke engine requires a mixture of brand-name gasoline and quality two-stroke engine oil with the classification TC.

Use regular branded unleaded gasoline with a minimum octane rating of 90 RON (U.S.A./Canada: pump octane min. 89!). If the octane number of the regular grade gasoline in your area is lower use premium unleaded fuel. Fuel with a lower octane rating may result in preignition (causing "pinging") which is accompanied by an increase in engine temperature. This, in turn, increases the risk of the piston seizure and damage to the engine.

The chemical composition of the fuel is also important. Some fuel additives not only detrimentally affect elastomers (carburetor diaphragms, oil seals, fuel lines etc.), but magnesium castings as well. This could cause running problems or even damage the engine. For this reason it is essential that you use only name branded fuels!

Use only STIHL two-stroke engine oil or equivalent branded two-stroke air-cooled engine oils with the classification TC for mixing.

We recommend STIHL 50:1 two-stroke engine oil since it is specially formulated for use in STIHL engines.

Do not use BIA or TCW (two-stroke water cooled) mix oils!

Take care when handling gasoline. Avoid direct contact with the skin and avoid inhaling fuel vapour.

The canister should be kept tightly closed in order to avoid any moisture getting into the mixture.

The fuel tank and the canister in which fuel mix is stored should be cleaned from time to time.

Fuel mix ages:

Only mix sufficient fuel for a few days work, not to exceed 3 months of storage. Store in approved safety fuel-canisters only. When mixing, pour oil into the canister first, and then add gasoline.

Gasoline	Oil (STIHL 50:1 or equivalent branded TC oils)
US gal.	US fl.oz
1	2.6
2 1/2	6.4
5	12.8

Dispose empty mixing-oil canisters only at authorized disposal locations.

Fueling



Before fueling, clean the filler cap and the area around it to ensure that no dirt falls into the tank.

Always thoroughly shake the mixture in the canister before fueling your machine.

Warning!

In order to reduce the risk of burns or other personal injury from escaping gas vapor and fumes, remove the fuel filler cap carefully so as to allow any pressure build-up in the tank to release slowly.

Warning!

After fueling, tighten fuel cap as securely as possible by hand.

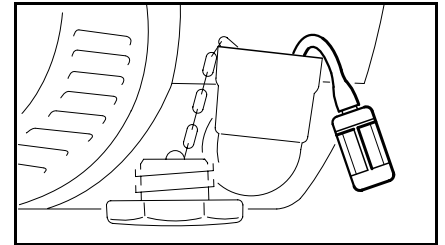

Change the fuel pick up body every year.

Before storing your machine for a long period, drain and clean the fuel tank and run engine until carburetor is dry.

Starting



To start, place cut-off-saw on ground, make sure you have a firm foothold and the cutting blade is clear of all obstructions. Nobody else should be standing within the working range of the machine.

Starting procedure

1. If the engine is cold, move choke lever (1) to "Choke". If the engine is warm, move choke lever (1) away from "Choke". This procedure also applies when the engine has been running but is still cold.
2. Move stop switch (2) away from "STOP".
3. Set throttle trigger (3) to half-throttle position by pressing in throttle trigger interlock (4), throttle trigger (3) and starting-throttle lock (5) in that order. Let go of throttle trigger (3) first and then the starting-throttle-lock (5).
4. Now hold the saw firmly on the ground with your left hand on the handlebar (6).
5. Pull starter grip (5) slowly with your right hand until you feel the starter engage. Then give starter rope a brisk, strong pull, but do not pull it out more than approx. 70 cm (27.5 in) as it might otherwise break. Continue cranking until engine begins to fire. Then, if you are starting from cold, move choke lever (1) immediately away from "Choke" (choke opens) and pull again.
6. As soon as the engine is running, disengage starting throttle lock (5) **immediately** by briefly squeezing the throttle trigger so that the engine can settle down to idle speed.
7. The engine is stopped by moving the stop switch (2) to the "STOP" position.

Top: Choke lever in "CHOKE" position (cold start)
Center: Stop switch away from "Stop"
Bottom: Starting-throttle position

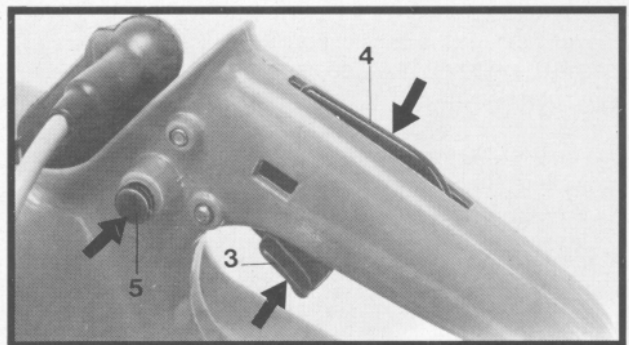
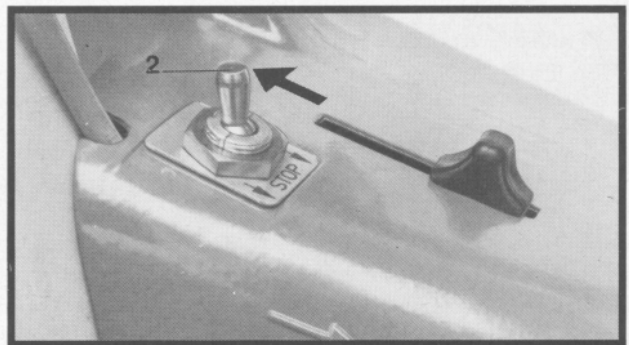
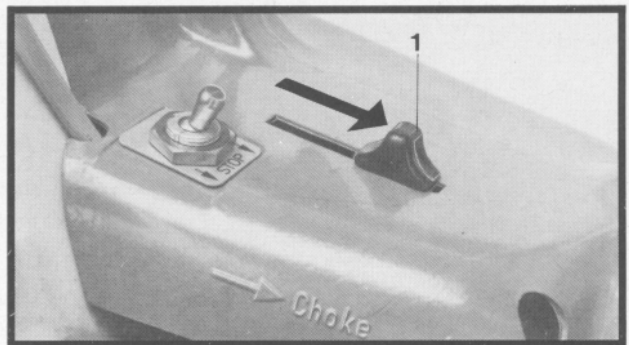

Top: Starting
Center: Throttle trigger in idle position
Bottom: Stop switch in "STOP" position

Points to observe when starting:

The choke lever is mechanically connected to the carburetor's choke valve. The choke valve is closed when the choke lever is on "Choke" and open when the choke lever is moved away from "Choke".

When starting a cold engine only keep the choke lever in the "Choke" position until the engine begins to fire. Then move the choke lever immediately, away from "Choke", even if the engine stops and you have to repeat the starting procedure. If you leave the choke lever on "Choke", the combustion chamber will flood and stall the engine.

If you have moved the choke lever away from "Choke" after the engine fired and the engine still does not run after several attempts, it is already flooded. In such a case, remove and dry off the spark plug. Clear the combustion chamber by pulling starter rope several times with the spark plug still removed and the stop switch in the "STOP" position. When you now try to start, move the choke lever away from "Choke", even if the engine is cold, and set the throttle trigger to the starting-throttle position.

In very cold weather only open the choke slightly after starting-move choke lever to center position. Allow engine to warm up for a brief period at half-throttle. Then move choke lever away from "Choke" and disengage the starting throttle lock.

A new engine or one which has been run until the fuel tank is dry will not start first time after fueling because fuel only begins to reach the carburetor when the engine has been turned over few times on the starter.

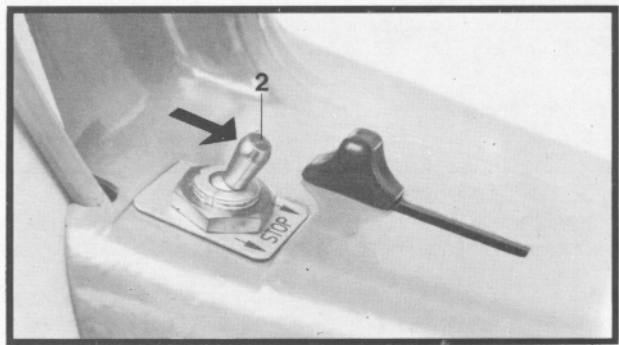
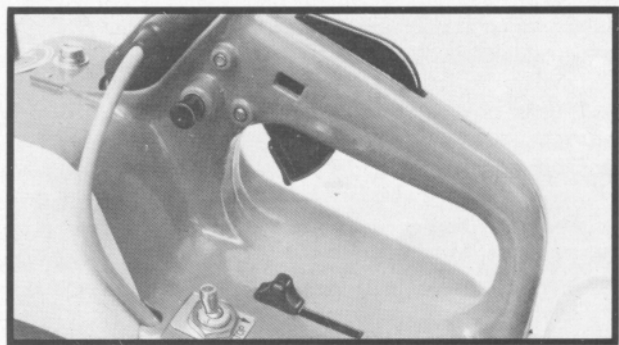
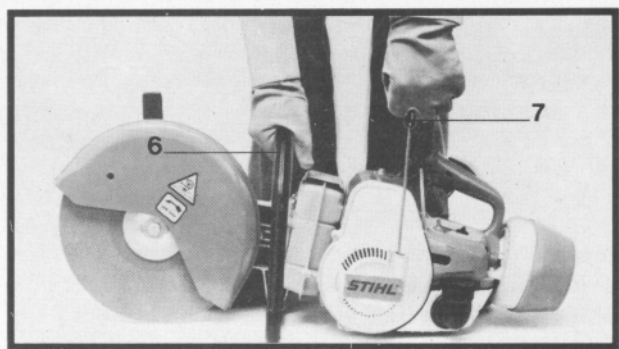

Checking Spark Plug

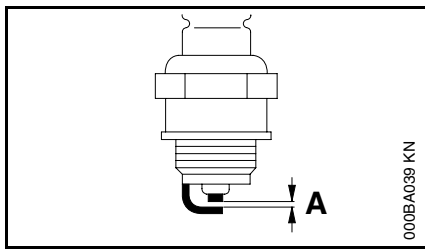

Wrong fuel mix (too much engine oil in the gasoline), a dirty air filter and unfavorable running conditions (mostly at part throttle etc.) affect the condition of the spark plug. These factors cause deposits to form on the insulator nose which may result in trouble in operation.

If engine is down on power, difficult to start or runs poorly at idling speed, first check the spark plug.

- Remove spark plug - see chapter "Starting".
- Clean dirty spark plug.
- Check electrode gap - it should be 0.5mm/0.02" (A) - readjust if necessary.
- Use only resistor type spark plugs of the approved range.

Rectify problems which have caused fouling of spark plug:
Incorrect carburetor setting, too much oil in fuel mix, dirty air filter, unfavorable running conditions, e.g. operating at part load.

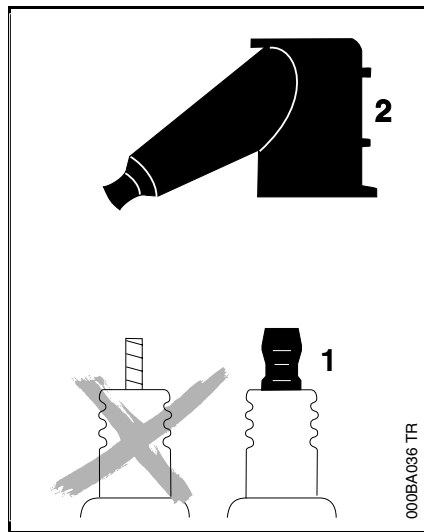

- Fit a new spark plug after approx. 100 operating hours - or earlier if the electrodes are badly eroded.

Warning!

To reduce the risk of fire and burn injury, use only spark plugs authorized by STIHL (see "Specifications"). Always press spark plug boot (2) snugly onto spark plug terminal (1) of the proper size. (Note: If terminal has detachable SAE adapter nut, it must be attached.) A loose connection between spark plug terminal and ignition wire connector in the boot may create arcing that could ignite combustible fumes and cause a fire.

General Notes on Operation

Starting for first time

A factory new machine should be run with the carburetor set slightly on the rich side for the first three tank fillings (see chapter on "Carburetor") so that the cylinder bore and the bearings receive additional lubrication during the break-in period.

As all the moving parts have to bed in during the break-in period, the frictional resistances in the engine are greater during this period. For this reason the engine only develops its maximum power after about 5 to 15 tank fillings. The carburetor setting must never be made leaner in order to achieve an apparent increase in power as this could cause the engine to exceed its maximum permissible rpm (see "Specifications" and "Carburetor").

During operation

After a long period of working at full load it is advisable not to shut off the engine immediately, but let run for a short while at idling speed. This allows the heat which has been generated in the engine during full throttle operation to be dissipated by the flow of cooling air and also protects engine-mounted components (ignition, carburetor) from thermal overload.

Air Filter

The air filter's function is to intercept dust and dirt in the combustion air and thus reduce wear on engine components.

Clogged air filters reduce engine power, increase fuel consumption and make starting more difficult.

The filter system consists of a prefilter, main filter and auxiliary filter. Always clean the prefilter first if engine power begins to drop off. It should be knocked out on the palm of your hand or blown out with compressed air. The prefilter can also be washed out in clean gasoline if it is very dirty, but must be **completely dry before** you refit it. For this reason we recommend that you use two prefilters in rotation.

Always renew a dirty main filter. We do not recommend cleaning this paper element since the results are unsatisfactory and the risk of damaging the filter paper is too great.

If the main filter should fail for any reason (e.g. damage), the **auxiliary filter** will protect the engine from damage. Failure of the main filter is indicated by a noticeable layer of dirt on the flocked wire mesh of the auxiliary filter. If this happens, clean the auxiliary filter when you change the main filter.

As long as the main filter is in good condition there is no need to clean the auxiliary filter as it is normally kept free from dirt.

Close the choke shutter - move choke lever to "Choke". Unscrew the wingnuts (1) and take off the filter cover (2) and silencer (3). Pull the prefilter (4) off the main filter (5). If necessary, also remove the auxiliary filter (6), knock it out on the palm of your hand and wash it in a non-flammable cleaning solution (warm soapy water).

Top: Removing air filter

Bottom: Component parts in correct sequence

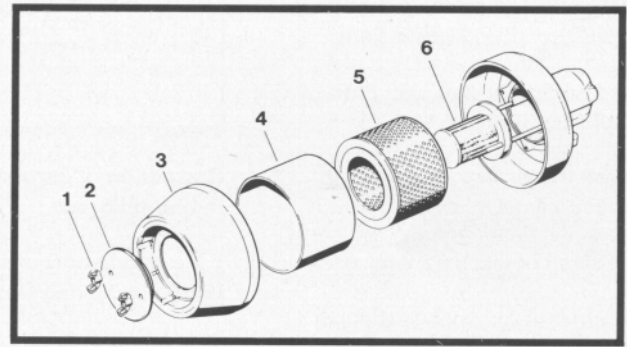
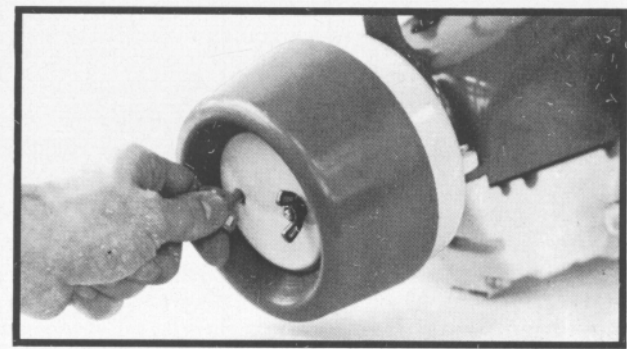

When refitting, put the auxiliary filter onto the studs so that its sealing edges over the shoulder inside the filter housing. Slip the prefilter over the main filter and install.

Place silencer and filter cover on the studs, fit wingnuts and tighten down moderately.

Adjusting Carburetor

Motor management

Exhaust emissions are controlled by the design of the fundamental engine parameters and components (e.g. carburation, ignition, timing and valve or port timing) without the addition of any major hardware.

The carburetor is set at the factory to guarantee an optimum fuel-air mixture under all operating conditions.

It ensures that your machine will run smoothly, be fuel efficient, operate reliably and produce low emissions.

Standard setting and explanation of setting pictograms

- Check the air filter and clean or replace it if necessary
- Check the spark arresting screen and clean or replace it if necessary

 Turn the high speed adjusting screw (**H**) counterclockwise as far as stop, i.e. 1/4 turn from max. lean setting

 Turn the low speed adjusting screw (**L**) clockwise as far as stop - then back off the screw one quarter of a turn

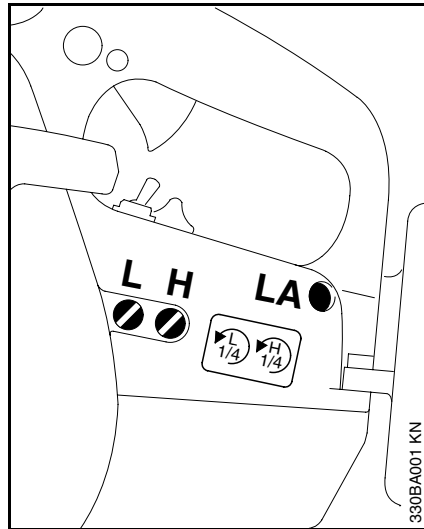

Correction of carburetor setting for higher altitudes

If the engine runs unsatisfactorily, slight readjustment may be necessary:

- Check standard setting
- warm up the engine
- Turn the high speed adjusting screw (**H**) clockwise (leaner)

Warning!

If you make the setting too lean, the engine might be damaged as a result of insufficient lubrication and overheating.

Setting idling speed

It is usually necessary to change the setting of the idle speed adjusting screw (**LA**) after every correction to the low speed adjusting screw (**L**).

Engine stops at idle speed

Set to standard setting!

- Turn the idle speed adjusting screw (**LA**) clockwise until the cutting wheel starts to run, then back off the screw one quarter of a turn

Cutting wheel runs on at idle speed

Set to standard setting!

- Turn the idle speed adjusting screw (**LA**) counterclockwise until the cutting wheel stops running, then turn screw another quarter turn in the same direction

Erratic idling behavior, poor acceleration

Idle setting is too lean (e.g. at cold ambient temp.)

- Turn the low speed adjusting screw (**L**) counterclockwise - no further than stop - until engine runs and accelerates smoothly

Rewind Starter

Removing the mounting screws

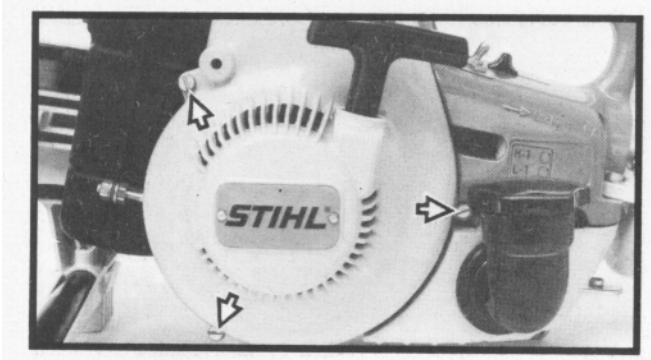

Replacing the starter rope

First remove the three screws which retain the fan housing. Then take off the fan housing.

Use a screwdriver or a suitable pair of pliers to carefully remove the spring slip (1) from the starter post. Now take off the thrust washer (2) and pawl (3) and pull the rope rotor (4) off the starter post. Remove remaining rope from the rotor and starter grip (5).

Thread the new rope - Part No. 1122 190 2900 - through the top of the starter grip and down through the guide bush (6). Pull the rope through the rotor and secure it with a simple overhand knot.

Slide rotor onto the starter post and turn it back and forth until the rewind spring's anchor loop (7) engages.

Top: Possible special knots
Bottom: Component parts of the starter assembly

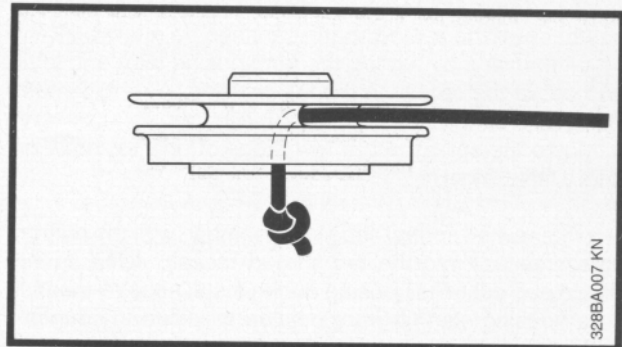
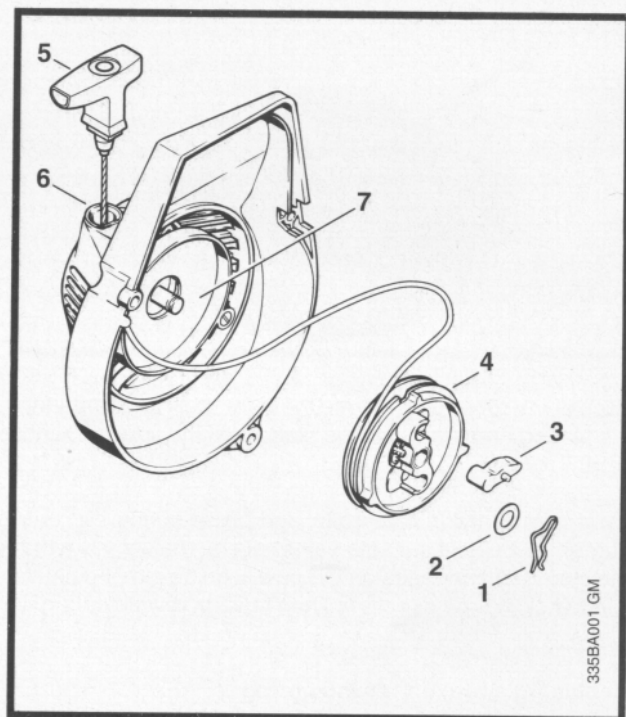

Installing the spring clip

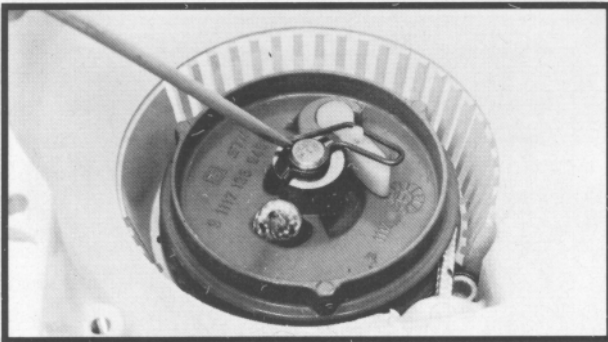

back of the rope rotor. Rotate the rotor back and forth until the slotted area engages the starter rewind spring anchor loop.

Now insert pawl in rope rotor and press spring clip onto starter post with a suitable pair of pliers, making sure that the spring clip engages on the pawl's guide pin and points it in the clockwise direction. Then tension rewind spring.

Replacing a broken rewind spring

Remove the rope rotor as above. The spring housing together with the rewind spring can then be removed from the fan housing by turning the fan housing over and let it drop out of the recess in the fan housing. A replacement spring and spring housing are supplied as an assembly. Lubricate the spring with a few drops of non-resinous oil before installing it.

Drop the rewind spring/housing assembly (with the bottom plate area up) into the fan shroud recess. If the spring should pop out of its housing during installation re-insert it in its housing starting from outside to inside in counterclockwise direction. Reassemble the rope rotor as above.

Tensioning the rewind spring

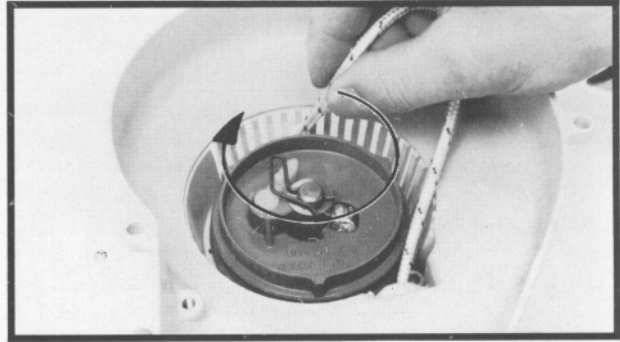

Tensioning the rewind spring

Rewind the starter rope by turning the rotor in counterclockwise direction until the starter grip has reached a distance of about 20 cm (8 in) from the fan shroud. Form a loop in the remaining rope next to the rim of the rope rotor. Use this loop to turn the rope rotor clockwise by three full revolutions and hold the rope rotor in place by hand. Pull out and straighten the twisted rope. Gradually release the rope rotor and pull in the starter rope until it is fully rewound on the rope rotor by spring force.

The rewind spring is tensioned correctly if the starter grip is held firmly in place against the starter housing by spring tension and does not droop. If more tension is required add one more turn on the rope rotor. The rope rotor should be able to be rotated by at least one-half an extra turn with the rope pulled all the way out. If spring tension is too great pull out the starter rope, hold the rotor firmly by hand, and remove one turn of the rope.

A rewind spring that is tensioned too heavily will probably break.

Re-install the fan shroud with the three retaining screws securely tightened.

Changing the V-belt

Arbor bearing and guard mounting screws

Top: Mounting screws on cast arm
Center: Removing cast arm
Bottom: Cast arm with V-belt

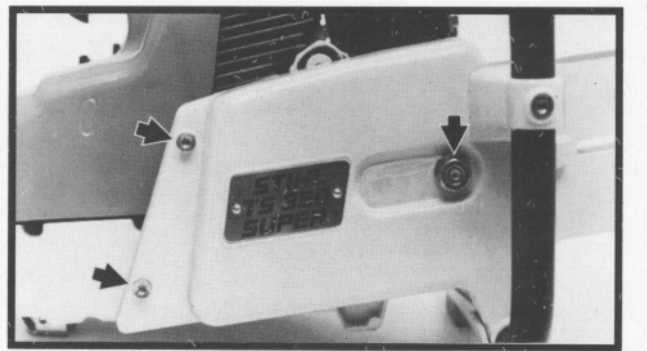
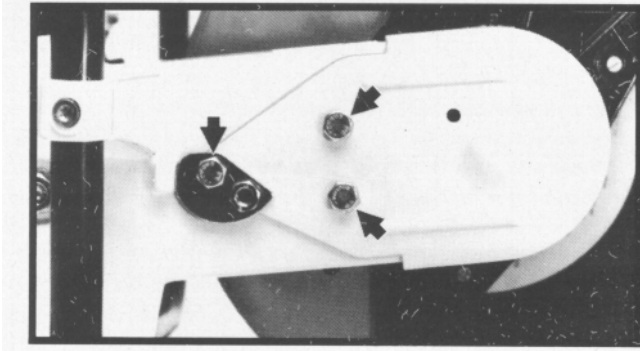

To change the V-belt, first remove the arbor bearing and abrasive wheel guard. To do this, unscrew the three mounting screws, take off the V-belt guard and lift the arbor bearing and abrasive-blade guard away from the V-belt.

Now remove the three mounting screws from the cast arm. Push the engine slightly to one side and take off the cast arm.

Place the new V-belt in the cast arm (see illustration) and reassemble. Check the position and freedom of movement of the V-belt before finally tightening the mounting screws. Refit the arbor bearing and abrasive wheel guard - refer to "Assembling the Arbor Bearing and Guard" and "Tensioning the V-belt".

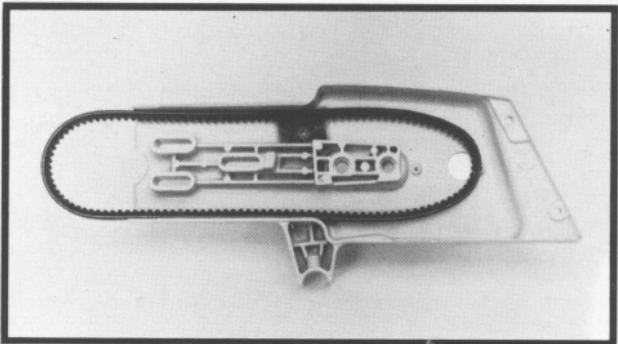
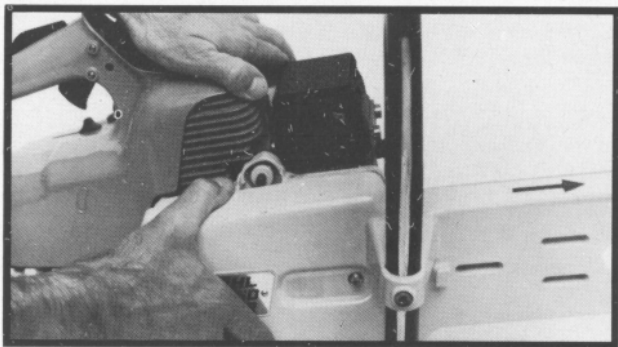

**STIHL Cutquik™ Cart 4201 710 1403
and Cutting Depth Limiter 42010071041
(special accessory)**



The TS 350 can be mounted on a cart which greatly simplifies handling of the machine and enables smooth, straight cuts to be obtained for road repairs and applying road markings as well as when abrasive joints and edges.

A abrasive depth limiter is also available as a special accessory and enables a constant depth of cut to be maintained when working with a diamond abrasive wheel.

**Spark arresting screen
in the muffler**

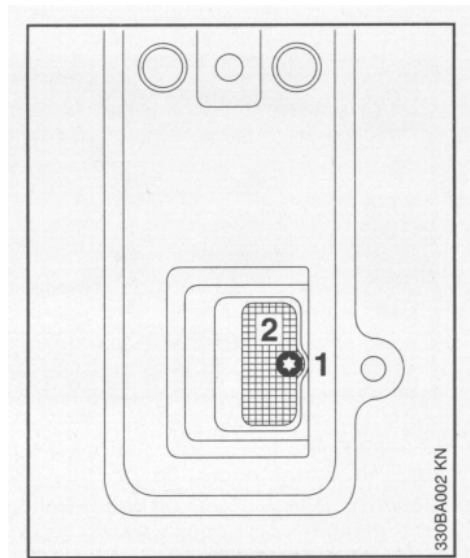

The spark arresting screen in the muffler must be checked if the engine performance deteriorates.

- Unscrew the screw **(1)**
- Remove the spark arresting screen **(2)** with suitable pliers.
- Clean the soiled spark arresting screen, do not widen the mesh
- The screen must be replaced if it is damaged or if there is a severe build-up of carbon
- Refit the spark arresting screen
- Fit the screw
- Do not operate the engine without screen in place.

Maintenance chart

The following information refers to normal operating conditions. The specified intervals must be reduced accordingly when working under aggravated conditions (severe dust formation, etc.) and with longer daily working hours.		Before starting work	After work or daily	Every time after refuelling	Weekly	Monthly	In the event of a malfunction	If damaged	As required	Refer to page
Complete machine	Visual inspection (condition, absence of leaks)	x		x						
	Clean		x							
Throttle trigger, throttle trigger interlock, slide control	Functional test	x		x						
Filter in fuel tank	Check					x				
	Replace						x			
Fuel tank	Clean					x				
V-belt	Clean					x				16
	Replace							x	x	27
Air filter (prefilter, auxiliary filter)	Clean	x					x			23
Air filter (all filter components)	Replace							x	x	23
Cooling air intake ports	Clean		x							
Cylinder fins	Clean		x							
Spark arresting screen in the muffler	Inspect		x							28
	Clean or replace								x	28
Carburetor	Check idle speed - the cutting wheel must not run on	x		x						24
	Adjust idle speed								x	24
Spark plug	Adjust electrode gap						x			22
Accessible nuts and bolts (but not adjusting screws)	Retighten								x	
Rubber buffer (AV element)	Have replaced by the STIHL customer service						x			
Abrasive wheel	Check	x		x						
	Replace							x	x	18
Support/Bracket/Rubber buffer (Bottom side of unit)	Check		x							
	Replace							x	x	

The user of this unit should carry out only the maintenance operations described in this manual. Other repair work may be performed only by an authorized STIHL Service dealer.

Warranty claims following repairs can be accepted only if the repair has been performed by an authorized STIHL Service dealer using original STIHL spare parts.

Original STIHL parts can be identified by the STIHL part number, the **STIHL** logo and the STIHL parts symbol . The symbol may appear alone on small parts.

Specifications

Engine

STIHL single-cylinder two-stroke engine
Displacement: 60.3 cm³
(3.68 cu.in)
Cylinder bore: 49 mm (1.93 in)
Piston stroke: 32 mm (1.26 in)
Power: 3.0 kW (4.1 HP)

Rated spindle speed: 5,000 r.p.m.

(make sure that the maximum operating wheel speed is above or equal to the rated spindle speed of your cut-off machine).

Ignition system

Type:
Electronically controlled
(breakerless) magneto ignition
Spark plug
(interference-suppressed): Bosch WSR 6 F
Champion RCJ 6 Y
or NGK BPMR 7 A,
Electrode gap: 0.5 mm (0.02 in)
Spark plug thread: M14 x 1.25,
9.5 mm (0.37 in)
long

Fuel system

Carburetor:
All-position diaphragm carburetor with
integrated fuel pump

Air filter:
Prefilter, large main filter (paper filter
cartridge) and flocked auxiliary filter

Fuel tank capacity:
0.55 litres (1.2 pt)

Fuel mix:
refer to the chapter " Fuel mix".

Abrasive wheels

Composite abrasive wheels for steel,
stone, asphalt, ductile cast pipes
and plastics*.
Diamond abrasive wheels for stone
and asphalt.

Dia. 300 mm (12 in) or 350 mm (14 in)
2.6 to 6 mm (0.10 to 0.24 in) thick
Cutting depth approx.
100 mm (3.9 in) with
300 mm (12 in) wheel
115 mm (4.5 in) with
350 mm (14 in) wheel

Dimensions

Length including mounted abrasive
wheel dia. 300 mm
(12 in): 760 mm (29.9 in)
Height up to guard: 330 mm (13.0 in)
Width including
handle bar: 310 mm (12.2 in)

Weight (without abrasive wheel)

with dia. 300 mm: 9.55 kg (21 lb)
with dia. 350 mm: 9.95 kg (22 lb)

Accessories

Set of tools

Special accessories

STIHL Cutquik™ cart
Attachment (TS 350) for Cutquik™ cart
Cutting depth limiter
Water attachment for wet cutting
Water container

* Not available in all countries

STIHL Incorporated Federal Emission Control Warranty Statement

Your Warranty Rights and Obligations

The U.S. Environmental Protection Agency (EPA) and STIHL Incorporated are pleased to explain the Emission Control System Warranty on your equipment type engine. In the U.S. new 1997 and later model year small off-road equipment engines must be designed, built and equipped, at the time of sale, to meet the U.S. EPA regulations for small non road engines. The equipment engine must be free from defects in materials and workmanship which cause it to fail to conform with U.S. EPA standards for the first two years of engine use from the date of sale to the ultimate purchaser.

STIHL Incorporated must warrant the emission control system on your small off-road engine for the period of time listed below provided there has been no abuse, neglect or improper maintenance of your small off-road equipment engine.

Your emission control system includes parts such as the carburetor and the ignition system. Also included may be hoses, and connectors and other emission related assemblies.

Where a warrantable condition exists, STIHL Incorporated will repair your small off-road equipment engine at no cost to

you, including diagnosis (if the diagnostic work is performed at an authorized dealer), parts, and labor.

Manufacturer's Warranty Coverage:

In the U.S., 1997 and later model year small off-road equipment engines are warranted for two years. If any emission-related part on your engine is defective, the part will be repaired or replaced by STIHL Incorporated free of charge.

Owner's Warranty Responsibilities:

As the small off-road equipment engine owner, you are responsible for the performance of the required maintenance listed in your owner's manual. STIHL Incorporated recommends that you retain all receipts covering maintenance on your small off-road equipment engine, but STIHL Incorporated cannot deny warranty solely for the lack of receipts or for your failure to ensure the performance of all scheduled maintenance.

Any replacement part or service that is equivalent in performance and durability may be used in non-warranty maintenance or repairs, and shall not reduce the warranty obligations of the engine manufacturer.

As the small off-road equipment engine owner, you should be aware, however, that STIHL Incorporated may deny you warranty coverage if your small off-road equipment engine or a part has failed due to abuse, neglect, improper maintenance or unapproved modifications.

You are responsible for presenting your small off-road equipment engine to a STIHL service center as soon as a problem exists. The warranty repairs will be completed in a reasonable amount of time, not to exceed 30 days.

If you have any questions regarding your warranty rights and responsibilities, please contact a STIHL customer service representative at 1-800-467-8445 or you can write to

STIHL Inc.,
536 Viking Drive, P.O. Box 2015,
Virginia Beach, VA 23450-2015.

Coverage by STIHL Incorporated

STIHL Incorporated warrants to the ultimate purchaser and each subsequent purchaser that your small off-road equipment engine will be designed, built and equipped, at the time of sale, to meet all applicable regulations. STIHL Incorporated also warrants to the initial purchaser and each subsequent

purchaser that your engine is free from defects in materials and workmanship which cause the engine to fail to conform with applicable regulations for a period of two years.

Warranty Period

The warranty period will begin on the date the utility equipment engine is purchased by the initial purchaser and you have signed and sent back the warranty card to STIHL. If any emission related part on your engine is defective, the part will be replaced by STIHL Incorporated at no cost to the owner. Any warranted part which is not scheduled for replacement as required maintenance, or which is scheduled only for regular inspection to the effect of "repair or replace as necessary" will be warranted for the warranty period. Any warranted part which is scheduled for replacement as required maintenance will be warranted for the period of time up to the first scheduled replacement point for that part.

Diagnosis

You, as the owner, shall not be charged for diagnostic labor which leads to the determination that a warranted part is defective. However, if you claim warranty for a component and the machine is tested as non-defective, STIHL Incorporated will charge you for the cost of the emission test.

Mechanical diagnostic work will be performed at an authorized STIHL servicing dealer. Emission test may be performed either at STIHL Incorporated or at any independent test laboratory.

Warranty Work

STIHL Incorporated shall remedy warranty defects at any authorized STIHL servicing dealer or warranty station. Any such work shall be free of charge to the owner if it is determined that a warranted part is defective. Any manufacturer-approved or equivalent replacement part may be used for any warranty maintenance or repairs on emission-related parts and must be provided without charge to the owner. STIHL Incorporated is liable for damages to other engine components caused by the failure of a warranted part still under warranty.

The following list specifically defines the emission-related warranted parts:

Carburetor
Choke (Cold start enrichment system)
Intake manifold
Air filter
Spark plug
Magneto or electronic ignition system (ignition module)
Catalytic converter (if applicable)
Fasteners

Where to make a claim for Warranty Service

Bring the product to any authorized STIHL servicing dealer and present the signed warranty card.

Maintenance Requirements

The maintenance instructions in this manual are based on the application of the recommended 2-stroke fuel-oil mixture (see also instruction "Fuel"). Deviations from this recommendation regarding quality and mixing ratio of fuel and oil may require shorter maintenance intervals.

Limitations

This Emission Control Systems Warranty shall not cover any of the following:

- repair or replacement required because of misuse, neglect or lack of required maintenance,
 - repairs improperly performed or replacements not conforming to STIHL Incorporated specifications that adversely affect performance and/or durability, and alterations or modifications not recommended or approved in writing by STIHL Incorporated,
- and
- replacement of parts and other services and adjustments necessary for required maintenance at and after the first scheduled replacement point.

englisch/english