

## PRU Installation - Classic

Use this method if you are going to use the standard installation technique.

1. **Plug in the PRU+:** Plug one end of the AC Adapter into a 110 Volt AC Outlet and the other end into the PRU+. The PRU+ will turn on, displaying the title screen. It will then display the date and time screen. The power and charge LED will be lit. The charge LED will go out when the unit is fully charged.
2. **Clear Stored Events:** Press and hold the PRU+ button on the LOCK until the PRU+ prompts "Please Wait...". When the display prompts "B=Function Mode" press B button once. The display will prompt "B=Clear Events". Press B to clear all stored events. The display will read "Events cleared".
3. **Test for RF Signal Strength:** Press "A" button twice. When the display prompts "B=Test Mode", press the "B" button to enter Test Mode. Look at the top line marked "RFStr". The display will have a value on the top line that indicates the signal strength of the last transmission of the PID.

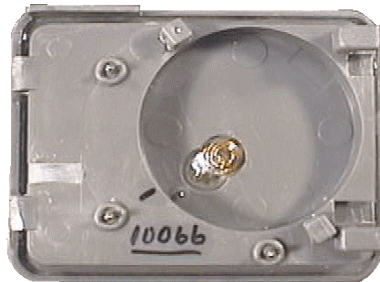

The value is a representation of the distance the PID is located away from the PRU+. To reduce the range the PRU+ will monitor the participant set the RSSI setting in Extended Special Function Mode to this value minus 15% (approx 30 points). Note: setting this value higher will reduce the size of the area of confinement..

## PID Installation

5. **Install the Battery:** Remove the PID, baseplate, one strap, one locking bar, one locking pin and the battery from the case. Simply place the battery into the PID battery well so that the alignment mark on the battery lines up with the alignment mark on the PID. Rotate the battery counterclockwise until the tabs on the battery slide under the two lock down posts. (See Figure 3 : installing the battery in the PID).

*Figure 3: Installing the battery in the PID*



6. **Size the Strap:** Attach the wide end of the strap to the PID baseplate. With the baseplate on the outside of the leg, wrap the strap around the participants leg, just above the ankle. Size the

strap so that it fits comfortably around the participant's leg. Cut off any access strap that is above the two hole positions that will fit into the other side of the strap (See Figure 4 : Strap installation)

*Figure 4 : Strap Installation*

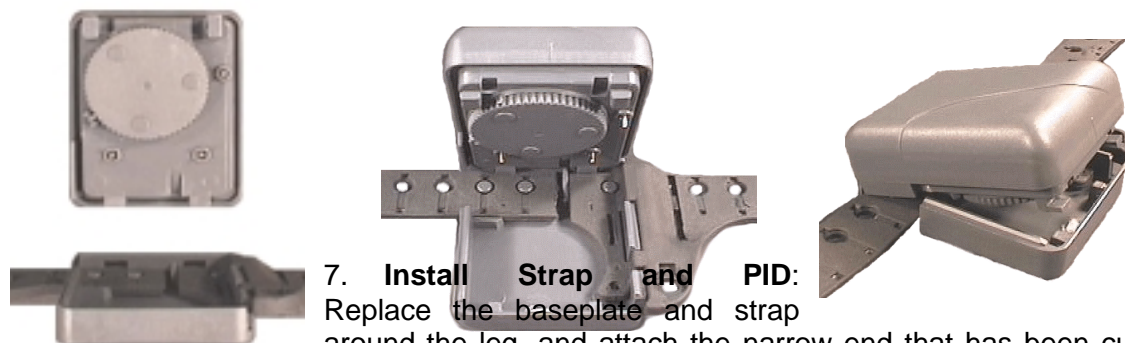

**7. Install Strap and PID:**

Replace the baseplate and strap around the leg, and attach the narrow end that has been cut to length to the baseplate. Push the PID onto the baseplate at the strap end. The PID is now hinged to the baseplate. Firmly close the PID and baseplate together by pushing down on the open end.

*Figure 5 : Attach the PID to the baseplate*

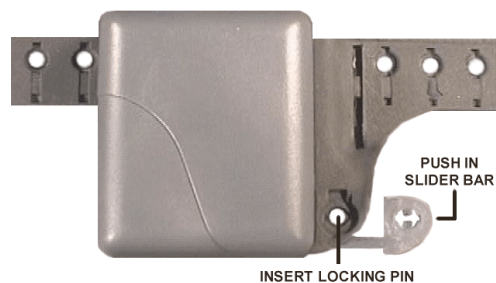

8. **Install Locking Mechanism:** Insert the slider bar under the strap into the hole in the side of the PID (See Figure 6 : Slider Bar) so the end of the slider bar is flush with the strap. Press a pin through the hole in the strap and into the slider bar. This locks the PID together.

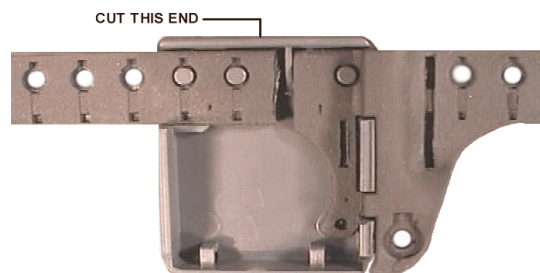

*Figure 6 : Slider Bar*

9. **Check Strap Tightness:** Check the strap tightness on the side opposite the PID. There should not be a space of more than ½ inch or 1.4 centimetres between the strap and the skin.

### Installation Completion

10. **Test the PID Signal:** Watch the PRU+ in test mode, to ensure that the signal from the PID is being received. The PID code number will be displayed and the PRU+ will beep to indicate it has received the signal from the assigned PID. Note: during the first 5 seconds after the PRU+ receives the signal there will be a "+" immediately in front of the PID number. This will disappear after 5 seconds. If the PID signal is not received within 1 minute, remove the PID and check that the battery is properly installed.
11. **Reset the PID:** When a signal has been received by the PRU+, use the LOCK's PID button to reset the alarms on the PID. Wait until the next signal from the PID. If the alarms has been properly reset, the PID number will be displayed, with no icons following it.
12. **Complete the Installation:** On the PRU+, press the A button until "B=Exit" is displayed. Press button B to exit. Connect the phone line to the wall and to the "LINE" jack on the PRU+. The PRU+ will call the Central Computer. When "Call Successful" is displayed, remove the telephone cable from the PRU+. Leave the AC Power adapter attached to the PRU+ but unplug it from the wall outlet. The PRU+ can now be placed inside the participant's home.
13. **Position the PRU+:** Remove the PRU+ and AC Adapter. Place the PRU+ in a central location, preferably closer to the participant's bedroom than their living area, elevated at least three feet / ninety centimetres from the floor. Assure that the PRU+ is plugged into AC power when it reaches the participant's home (be careful that the AC outlet that the PRU+ is plugged into cannot be switched off with a light switch).

### Downloading Information inside the PRU+

1. **Connect AC:** The information inside the PRU+ should be regularly downloaded (ie once per week / once every two weeks). Connect the AC adapter to a wall outlet.
2. **Connect Telephone:** Connect the telephone cable to the telephone outlet. The PRU+ should immediately start to call the central computer.
3. **Wait for "Call Successful":** The PRU+ should indicate "Call Successful" when the PRU+ has transferred all of the stored information. If the PRU+ does not indicate "Call Successful" the PRU+ needs to call into the CC again. This can most easily be accomplished by removing the AC plug from the wall until the PRU+ indicates "Starting Call..". Once the PRU+ indicates "Telephone In Use" plug the AC adapter back into the wall outlet.

### De-Installation / Removal

- A. **If your equipment is monitored by our Monitoring Center:-**
  - Fax the Inactivation Form to the Monitoring Center on the same day that the unit is to be removed from the participant's residence.
- B. **If you monitor your own equipment:-**
  - Assure the participant 's sentence ends on the same day that the unit is removed from the participant's residence.

1. **Connect AC Power & Telephone:** Connect AC Power to the PRU+ by plugging the AC adapter into a wall outlet. Connect the telephone into the telephone outlet. The PRU+ should immediately start to call into the central computer.
2. **Wait for "Call Successful":** When the PRU+ indicates "Call Successful" the PRU+ has transferred all of the stored information. If the PRU+ does not indicate "Call Successful" the PRU+ needs to call into the CC again. This can most easily be accomplished by removing the AC plug from the wall until the PRU+ indicates "Starting Call..". Once the PRU+ indicates "Telephone In Use" plug the AC adapter back into the wall outlet.
3. **Turn the PRU+ Off:** Press and hold the PRU+ button on the LOCK until "Please Wait..." is displayed on the PRU+. When "A=Turn PRU+ Off" is displayed, press button A on the PRU+. Disconnect the AC adapter from the wall. The PRU+ will turn off in approximately five (5) seconds.
4. **Disconnect the PRU+:** Disconnect the AC adapter from the back of the PRU+. Disconnect the telephone cord from the PRU+ and wall jack. Place the PRU+, AC Adapter and telephone cord into the carry / storage case.
5. **Remove the Pin and Slider Bar:** Using a tool such as a small screwdriver, rotate the locking pin on the PID all the way around two times (in both directions). This will break the locking pin and will enable the slider bar to be removed.
6. **Remove the PID from the Baseplate:** Remove the locking pin and slider bar. At the slider bar end, lift the PID away from the baseplate (like opening a clam shell).
7. **Remove the Battery:** Remove the battery from the PID by pulling it out of the battery well and place it in the plastic container in the carry / storage case. DO NOT TRY TO TURN THE BATTERY.
8. **Remove the Strap:** Remove the strap from the baseplate. Replace the baseplate back onto the PID and return the PID to the carry / storage case.

## **Domestic Violence**

Unfortunately, issuing restraining orders does not assure safety to domestic violence victims. Courts and law enforcement agencies enforcing stalking and domestic violence restraining orders require assistance which the Platinum Plus 400 Series can supply. The offender, wearing a transmitter, can continue to function in the community while complying to the restraining order. The Personal Identification Device (transmitter) will act as a deterrent to the offender by enforcing the realization they cannot approach the victim without activating an alarm. The victim is offered a measure of security in that if the offender comes too close to their residence a priority alarm will be sounded and there is a link to authority for immediate help.

The victim is given a Panic Alarm Pendant, and a PRU+ is installed in their place of residence. The Personal Identification Device is worn by the offender. Another PRU+ should be installed at the offender's residence to enforce compliance with a curfew schedule and ensure that the offender has not tampered or removed the transmitter. The information is entered into the central computer, and is flagged as a priority domestic violence case.

The Panic Alarm Pendant transmitter code is programmed into the spousal code in the PRU+ and the offenders PID code is programmed into the regular PID code (See Extended Special Function Mode on page 38 For more information about programming these numbers). This will enable the PRU+ to differentiate between a transmission sent by the pendant and the PID worn by the offender.

## Domestic Violence Installation

### Victims Installation

#### Pre-Installation

##### A. If your equipment is monitored by our Monitoring Center:-

- Fax the Enrollment Form to the Monitoring Center, giving as much time as possible (½ hour minimum) before the unit is to be hooked up inside the victims home. The Monitoring Center **must** be notified before the unit calls in. The form should be clearly marked indicating this unit is a domestic violence unit and is located in the victims home.

##### B. If you monitor your own equipment:-

- Assure you have entered the victims data on your system before you install the unit in the offenders home. The curfew schedule should be entered with AWAY time all day. See Page 50 For a complete listing of all events generated by the PRU+.

#### PRU+ Installation

1. **Position the PRU+:** Remove the PRU+ and AC power adapter from the case. Place the PRU+ in a central location, preferably closer to the participant's bedroom than their living area, elevated at least three feet / ninety centimetres from the floor.
2. **Plug in the PRU+:** Plug one end of the AC power adapter into a standard 110 Volt electrical outlet and the other end into the PRU+. **Note : Do not connect the telephone line.** The PRU+ will turn on, displaying the title screen. It will then display the date and time screen. The power and charge LED will be lit. The charge LED will go out when the PRU+ internal battery is fully charged.
3. **Clear Stored Events:** Press and hold the  PRU+ button on the LOCK until the PRU+ prompts "Please Wait...". When the display prompts "B=Function Mode" press "B" button once. The display will prompt "B=Clear Events". Press "B", the display will now prompt "A=\*\* Clear \*\* / B=Cancel". Press "A" to clear all events.

### Transmission Checks

#### Check the Participant's PID

At this time, the PID that will monitor the offender should also be checked. This will verify that the system operates correctly.

5. **Install the Battery:** Remove the PID , baseplate, one strap, one locking bar, one locking pin and the battery from the case. Simply place the battery into the PID battery well so that the alignment mark on the battery lines up with the alignment mark on the PID. Rotate the battery counterclockwise until the tabs on the battery slide under the two lock down posts. (See Figure 3 : installing the battery in the PID).



Figure 3: Installing the battery in the PID



6. **Check PID Transmission:** Press A twice then hit B to go into Test Mode. Hold the PID and watch the PRU+ Test Mode Screen for a transmission from the PID. When the signal is received it should indicate strap sever  symbol. The PRU+ should also beep to indicate the PID has the correct code. When the transmission is received remove the battery by lifting the battery out of the battery recess in the PID and place it in the plastic container in the offenders carry / storage case.

#### Check the Pendant

7. **Check the Pendant Transmission:** Push both pendant buttons. The Test Mode screen should indicate a new transmission (with the code matching the pendant) by placing a + to the left of the code.

#### Installation Completion

8. **Complete the Installation:** On the PRU+, press the A button until "B=Exit" is displayed. Press button B to exit. Connect the phone line to the wall and to the "LINE" jack on the PRU+. The PRU+ will call the Central Computer. When "Call Successful" is displayed, installation is complete.
9. **Install the offender's unit:** Follow the PRU+ Active Mode Installation instructions (Page 17, 44) for installing the PRU+ / PID set on the offender.

De-Installation / Removal

**A. If your equipment is monitored by our Monitoring Center:-**

- Fax the Inactivation Form to the Monitoring Center on the same day that the unit is to be removed from the offender's residence.

**B. If you monitor your own equipment:-**

- Assure the offender 's sentence ends on the same day that the unit is removed from the victim's residence.
1. **Disconnect the PRU+:** Disconnect the telephone cord from the PRU+ and wall jack. Disconnect the AC adapter from the back of the PRU+
  2. **Turn the PRU+ Off:** Press and hold the  PRU+ button on the LOCK until "Please Wait..." is displayed on the PRU+. When "A=Turn PRU+ Off" is displayed, press button A on the PRU+. Disconnect the AC adapter from the wall. The PRU+ will turn off in approximately five seconds.
  3. **Place in storage case:** Place the PRU+, Pendant, AC adapter and telephone cord into the carry / storage case.



## Special Function Mode

The PRU+'s Special Function Mode allows the installer to change various configuration settings, clear the stored events, and enter a test / diagnostic mode. To enter the Special Function Mode, you use the LOCK. Simply press the PRU+ button on the LOCK, while holding the LOCK within three feet (1 metre) of the PRU+. The front panel display will show the message "Please Wait...", and will then display two choices: "A=Turn PRU+ Off" and "B=Function Mode", as shown below.

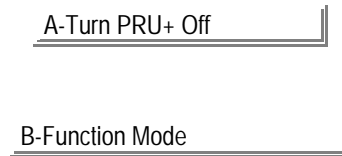

The PRU+ can be turned off by pressing the "A" button on the front display of the PRU+. Pressing the "B" button will enter function mode. The first function mode screen is displayed, as shown below.

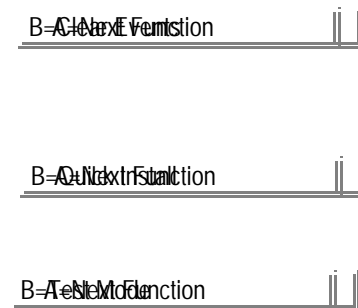

Press the "B" button to clear all stored events in the PRU+'s memory. The display will prompt "A=\*\*



Clear \*\*"; press "A" to clear events. The message "Events Cleared!" will be displayed briefly. Press the "A" button to move to the next screen.

Press "B" to enter the Quick Install function. Please refer to Quick Install on Page 44 for more information. Press "A" to move to the next screen

Press the "B" button to enter Test Mode. Please refer to the section titled "Test Mode" on page 42. Press the "A" button to move to the next screen.

This screen concludes the first set of program options. At this point, pressing the "B" button causes the PRU+ to exit Special Function Mode and begin normal operation. Pressing the "A" button returns the installer to the first screen (A=Turn PRU+ Off / B=Function Mode).

## Extended Special Function Mode

Extended Special Function Mode is used to change the internal settings inside the PRU+. The ability to change the internal settings gives the PRU+ great flexibility. The installer can now change important settings depending upon their needs.

Extended Special Function Mode can be accessed by moving to the screen "B=Exit" as shown on pages 36 and 37. To access the extended configuration settings, hold down the  PRU button on the LOCK. Once a small dot begins to flash in the right top corner of the display press the "A" button. This will cause the PRU+ to display the configuration screen, as shown in the next diagram.

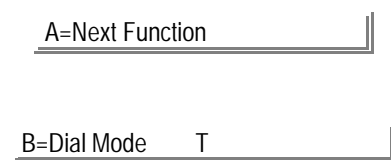

This screen allow the installer to change the way the PRU+ dials. The PRU+ can dial both pulse and tone. Select the mode that is appropriate for your telephone network. Press the "B" button to change the dial mode between "T" (tone dialling) and "P" (pulse dialling). Press the "A" button to move to the next screen.

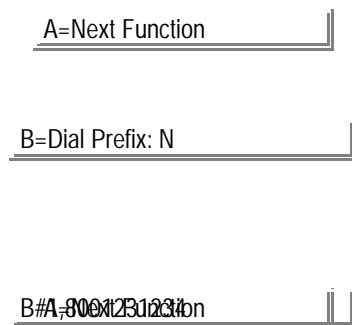

If the PRU+ is installed in an office or a hotel, the telephone system may require an additional digit to be dialled to access an outside line. Pressing the "B" button changes the prefix between "N" which indicates "No Prefix" required to a "digit" from 0 to 9. Stop pressing the "B" button when the prefix required is reached. Press "A" button to proceed to the next function.

This screen allows the installer to change the telephone number that the PRU+ will dial to call the Central Computer. When this screen is displayed, pressing the "A" button will move to the next screen. If the "B" button is pressed, a flashing cursor is displayed over the first character of the telephone number. This indicates that the display is now in "edit mode". While in edit mode, pressing the "B" button will change the character under the cursor. Pressing the "B" button repeatedly will cycle through the valid characters (0-9, a # symbol, a \* symbol, a comma - used to insert a two-second pause into the dialling sequence; or a space - to erase unnecessary characters). While in the edit mode, pressing the "A" button steps through the character positions from left to right, until the last (fourteenth) character is reached. At this point, pressing the "A" button will cause the screen to exit "edit mode" and move to the next option.

B=Set RSSI Limit 00

This screen enables the installer to limit the range the PRU+ will detect the presence of the PID. If transmissions are received from the PID with a signal strength less than the value set the transmission will be ignored. The value may be set between 0 - 255. A value of 0 indicates all transmissions will be valid. To set the value press B and a cursor will appear under the first digit of the setting. Press B to increment the current digit and press A to move to the next digit.

A=Next Function

B=Set PID# 30431

This screen allows the installer to change the number of the PID installed on the participant. This is useful for cases where the supplied PID has been lost or broken, and a replacement PID with a different code must be used. This screen operates similarly to the telephone number screen. When this screen is displayed, pressing the "A" button will move to the next screen. If the "B" button is pressed, a flashing cursor is displayed over the first character of the PID code. This indicates that the display is now in "edit mode". While in "edit mode", pressing the "B" button will change the number under the cursor. Pressing the "B" button repeatedly will cycle the digit under the cursor from 0 to 9. NOTE: code numbers such as "68" must be entered as "068". While in the edit mode, pressing the "A" button steps through the digits from left to right, until the third digit is reached. At this point, pressing the "A" button causes the screen to exit "edit mode" and move to the next option.

A=Next Function

B=Set Leave 03

This screen allows the installer to change the leave window for the PRU+. The leave window is the period of time which the PRU+ allows to elapse without receipt of any transmissions from the PID before a "Leave" message (ie .info leave or ALARM AWAY) is registered. Pressing the "B" button repeatedly steps through the possible values (3-30). Pressing the "A" button causes the next screen to be displayed.

B=Set Code# 30253

This screen allows the installer to change the code of the Domestic Violence Deterrent pendant (if

B=Set DV Deterrent Code

applicable) This setting allows the PRU+ to differentiate between the transmitter worn by the offender and the pendant used by the victim. Different Alarm indications will be reported by the PRU+ dependant on which code is received. See Individual Status Log Reports on Page 50 for detailed explanations on these events.

This screen allows the installer to change the format of the date displayed by the unit during normal operation. Pressing the "B" button repeatedly will cycle through the available options: YMD (year/month/day), MDY (month/day/year), or DMY (day/month/year). Press the "A" button to move to the next screen.

B-Select Function  
Select Year

B-Select Function  
Select Month

B-Select Function  
Select Day

B-Select Function  
Select Hour

B-Select Function  
Select Min

This screen allows the installer to change the year setting on the internal clock. Pressing the "B" button changes the year number. Pressing the "A" button causes the next screen to be displayed. NOTE: The clock is automatically updated by the Central Computer during a PRU+ call-in, to keep the PRU+ and central computer clocks synchronized.

This screen allows the installer to change the month setting on the internal clock. Pressing the "B" button changes the month number. Pressing the "A" button causes the next screen to be displayed.

This screen allows the installer to change the day setting on the internal clock. Pressing the "B" button changes the day number. Pressing the "A" button causes the next screen to be displayed.

This screen allows the installer to change the hour setting on the internal clock. (This is based on a 24 hour clock.) Pressing the "B" button changes the hour number. Pressing the "A" button causes the next screen to be displayed.

This screen allows the installer to change the minute setting on the internal clock. Pressing the "B" button changes the minute number. Pressing the "A" button causes the next screen to be displayed.

B=~~A~~Ext Function 

This final screen allows the installer to exit extended special function mode. Pressing the "A" button returns the installer to the very first screen ("A=Turn PRU+ Off / B=Function Mode"). Pressing the "B" button causes the PRU+ to exit Special Function Mode and resume normal mode. All settings are automatically saved at the time they are entered.

## Test Mode



Test Mode which is accessed from the Special Function Mode screens is useful for many diagnostic tests. Selecting test mode causes the screen shown below to be displayed.

Figure 1 : Test Mode Display

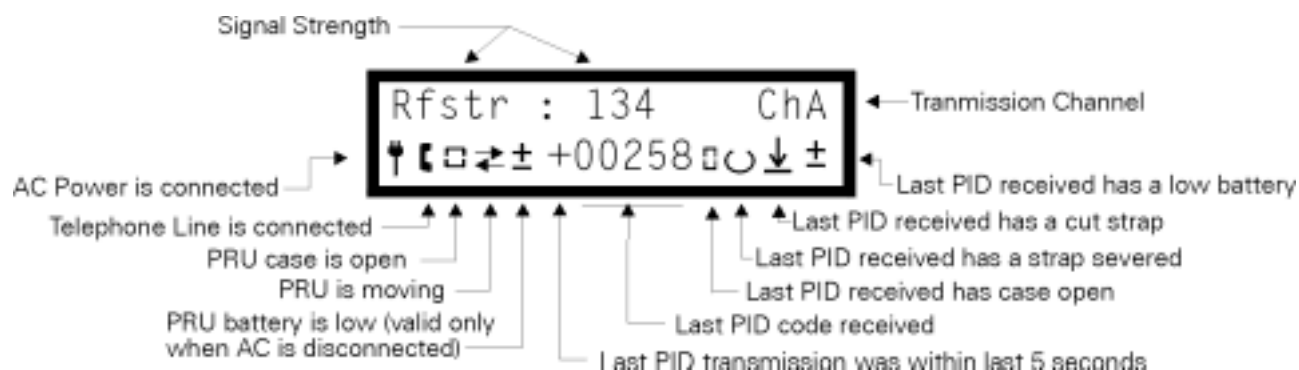

The top line of the display is the signal strength of the last transmission received from the PID along with the channel received.

The left half of the bottom line provides PRU+ status information. The two symbols at the left edge of the display are status indications:

\* AC Power - indicates the AC power adapter has been properly connected and plugged into a standard functioning 110 volt AC electrical outlet.

Telephone Line - indicates that the PRU+ has been connected to a properly functioning telephone line.

The two symbols to the right of the AC power and telephone indications represent the following alarm conditions:

☐ PRU+ Tamper - indicates the PRU+ case is open or has been seriously damaged.

PRU+ Motion - indicates the PRU+ is moving or tilted.

⚡ Low PRU+ Battery- indicates that the PRU+'s internal battery is approaching the limits of sustained operation (applicable only when AC power is not connected).

The right half of the bottom line provides information on transmissions received from PIDs. The five-digit number shown is the PID code of the last received transmission (see Note below). If a '+' is shown next to the PID serial number, this indicates that the transmission was received within the last 5 seconds. After the + symbol expires, the position on the display will indicate if the serial number is assigned to either the PID monitored by the PRU+ (a 'T' will be displayed) or the domestic violence pendant (an 'S' will be displayed). If the PRU+ button is pressed on the LOCK the serial number will change to display "LOCK".

The symbols to the right of the code number provide the following information:

- ☐ PID Case Open - indicates the last received transmission showed a case open alarm.
- Strap Sever - indicates the last received transmission showed a strap cut alarm.
- ⚡ PID Tamper - indicates the last received transmission showed a strap tamper alarm (the strap has been damaged other than being cut all the way through)
- ± Low PID Battery - indicates the battery installed in the PID which sent the last transmission is approaching the limits of its lifetime or is improperly installed.

*NOTE: The test mode will receive and display transmissions from ALL PID's within range of the PRU+. If a transmission is received from the PID which is assigned to the PRU+, the PRU+ will beep.*

