

## Strix Outdoor Wireless System (OWS)

Field Installation



*April 13th, 2006*

**210-0014-01 Rev. F**

*Copyright © 2003 – 2006 Strix Systems, Inc.*

26610 Agoura Road  
Calabasas, CA 91302  
USA

<http://www.strixsystems.com>



## Copyright Notice

Copyright © 2003 – 2006 Strix Systems, Inc. All rights reserved. This document may not be reproduced or disclosed in whole or in part by any means without the written consent of Strix Systems, Inc. Access/One Network is a registered trademark of Strix Systems, Inc. All other trademarks and brand names are marks of their respective holders.

## FCC Notice

The enclosed wireless network device complies with Part 15 of the FCC Rules. Operation is subject to the following two conditions:

1. This device may not cause harmful interference.
2. This device must accept any interference received, including interference that may cause undesired operation.

This wireless network device has been tested and found to comply with the limits for a Class B digital device, pursuant to Part 15 of the FCC Rules. These limits are designed to provide reasonable protection against harmful interference in a residential installation. This wireless network device generates, uses, and radiates radio frequency energy and, if not installed and used in accordance with the instructions, may cause harmful interference to radio communications. However, there is no guarantee that interference will not occur in a particular installation. If this wireless network device does cause harmful interference to radio or television reception, which can be determined by turning the wireless network device off and on, the user is encouraged to try to correct the interference by one or more of the following measures:

- ▶ Reorient or relocate the receiving antenna.
- ▶ Increase the separation between the wireless network device and the affected receiver.
- ▶ Connect the wireless network device into an outlet on a circuit different from that to which the receiver is connected.
- ▶ Consult the dealer or an experienced radio/TV technician for help.

## Other Notices

### *Industry Canada Notice*

This Class B digital apparatus complies with Canadian ICES-003.

Cet appareil numérique de la classe B est conforme à la norme NMB-003 du Canada.

### *VCCI Notice*

This is a Class B wireless network device based on the standard of the Voluntary Control Council for Interference from Information Technology Equipment (VCCI). If this wireless network device is used near a radio or television receiver in a domestic environment, it may cause radio interference. Install and use the wireless network device according to the instruction manual.

### *European Community (EC) Directives and Conformity*

This wireless network device is in conformity with the Essential Requirements of R&TTE Directive 1999/5/EC of the European Union.

## *Non-Modification Statement*

Unauthorized changes or modifications to Strix devices are not permitted. Modifications to Strix devices will void the warranty and may violate FCC regulations.

## *RF Exposure Requirements*

To ensure compliance with FCC RF exposure requirements, the antenna used for this wireless network device must be installed to provide a separation distance of a minimum of 2 meters (6.56 feet) or more from all persons, and must not be co-located or operated in conjunction with any other antenna or radio transmitter. Installers and end-users must follow these installation instructions.

## **Safety Warnings**

This unit must be installed by a trained professional installer only. Read the following safety warnings before commencing an installation.

### ***General Safety Warning***



#### **Always be aware of electrical power lines!**

You can be killed if any antennas come near electrical power lines. Carefully read and follow all instructions in this manual.

By performing these installation instructions, you may be exposed to hazardous environments and high voltage. Use caution when installing the Strix OWS product.

### ***Electrical Power Warning***



This unit must be installed by a trained professional installer only. Read the installation instructions before you connect the wireless network device to its power source.

### ***Lightning Activity Warning***



Do not connect or disconnect cables during periods of lightning activity.

For each antenna, a surge protective device meeting IEC 61000-4-5, Level 4 or IEEE C 62.41 A3/B3 requirements must be used to prevent potential damage from very high surges (for example, surges caused by lightning).

### ***Explosive Device Proximity Warning***



Do not operate your wireless network device near unshielded blasting caps or in an explosive environment.

## ***Antenna Placement Warning***



Do not locate any antenna near overhead power lines or other electric light or power circuits, or where the antenna can come into contact with such circuits. When installing antennas, take extreme care not to come into contact with such electrical circuits, as they can cause serious injury or death.

For the correct installation and grounding of antennas, please refer to national and local codes (for example, US:NFPA 70, National Electrical Code, Article 810; in Canada: Canadian Electrical Code, Section 54).

## ***Ground Warning***



You must ALWAYS install an external grounding wire. The ground connection must be complete before connecting power to the OWS enclosure—a simple continuity check between the enclosure and the ground termination point can confirm this. Grounding of the OWS must comply with National Electrical Code (NEC) requirements, unless local codes in your area take precedence over the NEC code.

## ***Power Cord Assembly Caution***



An assembled power cord is not supplied with the OWS. The power cord must be assembled by a professional installer, and the final assembly must comply with National Electrical Code (NEC) requirements, unless local codes in your area take precedence over the NEC code.

## ***Battery Caution***



This product contains a non-rechargeable, non-user-serviceable lithium ion battery. Exercise caution to avoid shorting the terminals of this device.

Consult local laws and regulations for the proper disposal of batteries in your area.

## ***Solar Shield***



A solar shield is **required** for **any** installation where the OWS product will receive direct exposure to sunlight. Failure to install a solar shield where required may cause damage to the product and will void its warranty. Contact your Strix authorized distributor or Strix Systems for Solar Shield model numbers and ordering information.

## Limited Warranty

Strix Systems, Inc. (“Strix”) warrants the Access/One Indoor Wireless System (“IWS”) and Outdoor Wireless System (“OWS”): (i) the hardware (“Hardware”) will be free of defects in materials and workmanship from the date of shipment as set forth below and (ii) the embedded software (“Firmware”) to the Hardware and any separately provided software product (“Software”) are provided “AS-IS” and such items will substantially conform to their respective published product documentation (collectively the “Product”) for the periods indicated below, commencing (as applicable) on the date of shipment.

Covered Product	Warranty Period
IWS products (Including but not limited to the BMEx, WM11x, NWSV-x, Antennas, AMECs, MTKIT, PSWW, SLCDT and SLCKIT)	12 months
OWS2400/OWS3600	12 months
OWS11xx (Radio Board)/OWS-NSxx (Network Servers)	12 months
Repaired or Replacement Items	90 days, or the balance of the original item warranty, whichever is the greater

This limited warranty extends only to the original user of the Product and such user's sole and exclusive remedy and the entire liability of Strix, at its option, will be to repair or replace the Hardware or component thereof and in the case of Firmware or Software Strix will make available the then available updated version of the Firmware or Software. Notwithstanding the foregoing, in no event does Strix warrant that the Product will operate with any software or hardware other than that provided by Strix or specified in the applicable Product documentation, that the Product is error free or will operate without problems or interruptions, or that the Product will be free of vulnerability to intrusion or attack, or that the Product will satisfy any party's own specific requirements. The repair or replacement of the Product does not include any labor or other costs related to the subsequent installation thereof. The obligations of Strix hereunder are conditioned upon the return of the Hardware in accordance with the Strix then-current Return Material Authorization (RMA) procedures (please contact your authorized Strix Systems reseller for return instructions). Repair or replacement of the defective Product or parts thereof shall neither extend nor decrease the warranty period.

## Exceptions

The foregoing limited warranties of the Product do not apply if the Product (i) has been altered or modified, except by Strix or its duly trained and authorized service provider, (ii) has not been installed, operated, repaired, or maintained in accordance with written instructions of Strix, (iii) has been subjected to abnormal physical or electrical stress, misuse, negligence or accident, (iv) has been operated outside of the environmental specifications for the Product or (v) is related to configuration of customer's network beyond that necessary to the use or installation of the Strix Products. The Strix limited Firmware or Software warranty does not apply to Firmware or Software corrections or upgrades. Repair of Products or the supply of updated Firmware or Software requested after the expiration of the warranty period shall be at then current Strix repair or update charges.

## **DISCLAIMER; LIMITATION OF LIABILITY**

EXCEPT FOR THE WARRANTIES SPECIFICALLY DESCRIBED HEREIN, STRIX DISCLAIMS ANY AND ALL WARRANTIES AND GUARANTEES, EXPRESS, IMPLIED OR OTHERWISE, ARISING, WITH RESPECT TO THE PRODUCTS OR SERVICES DELIVERED HEREUNDER, INCLUDING BUT NOT LIMITED TO THE WARRANTY OF MERCHANTABILITY, THE WARRANTY OF FITNESS FOR A PARTICULAR PURPOSE, AND ANY WARRANTY OF NON-INFRINGEMENT OF THE INTELLECTUAL PROPERTY RIGHTS OF ANY THIRD PARTY. LIABILITY OF STRIX FOR LOSS UNDER THIS CONTRACT IS LIMITED TO THE TOTAL AMOUNT PAID TO STRIX BY CUSTOMER DURING THE PREVIOUS CALENDAR YEAR. STRIX WILL HAVE NO OBLIGATION OR LIABILITY, WHETHER ARISING IN CONTRACT (INCLUDING WARRANTY), TORT (INCLUDING ACTIVE, PASSIVE OR IMPUTED NEGLIGENCE, STRICT LIABILITY OR PRODUCT LIABILITY) OR OTHERWISE FOR ANY SPECIAL, INCIDENTAL, CONSEQUENTIAL OR INDIRECT DAMAGES INCLUDING BUT NOT LIMITED TO LOSS OF USE, LOSS OF DATA, BUSINESS INTERRUPTION, LOSS OF REVENUE, LOSS OF BUSINESS OR OTHER FINANCIAL LOSS ARISING OUT OF OR IN CONNECTION WITH ANY OF THE PRODUCTS OR OTHER GOODS OR SERVICES FURNISHED BY STRIX UNDER THIS AGREEMENT, EVEN IF ADVISED OF THE POSSIBILITY OF SUCH DAMAGES.

STRIXSYSTEMS® (including the design) and ACCESS/ONE® are registered trademarks of [Strix Systems, Inc.](#)

# Table of Contents

Copyright Notice .....	ii
FCC Notice .....	ii
Other Notices .....	ii
Safety Warnings .....	iii
General Safety Warning .....	iii
Electrical Power Warning .....	iii
Lightning Activity Warning .....	iii
Explosive Device Proximity Warning .....	iii
Antenna Placement Warning .....	iv
Ground Warning .....	iv
Power Cord Assembly Caution .....	iv
Battery Caution .....	iv
Solar Shield .....	iv
Limited Warranty .....	v
<b>OWS Field Installation .....</b>	<b>1</b>
Theory of Operation .....	1
Important Safety Information .....	1
Planning Your Installation .....	2
Local Guidelines .....	2
Site Surveys .....	2
Power Source .....	2
Installing the OWS Enclosure .....	3
Mounting the OWS on a Vertical Pole .....	3
Mounting the OWS on a Wall .....	7
Installing Antennas .....	8
Notes About Antenna Installations .....	8
Maximum Power Settings for Antennas .....	9
Channels for IEEE 802.11b/g .....	9
Channels for IEEE 802.11a .....	10
Attaching an Omni Antenna Directly to the OWS Enclosure .....	12
Mounting a Directional Antenna on a Pole .....	14
Mounting a Sectored Antenna on a Pole .....	16
Mounting an Omni Antenna on a Pole .....	19
Antenna Connector Wiring Configurations .....	22

Physical Layout (Enclosure) .....	22
Physical Layout (Wireless Modules) .....	23
Routing the Antenna Cables .....	23
Grounding the OWS Enclosure .....	24
Configuring the Power Cord .....	25
AC Wiring Configurations .....	27
Connecting the Ethernet Cable .....	28
Powering Up the OWS .....	30
Powering Up from an AC Power Source .....	30
Powering Up from a DC Power Source .....	30
OWS Product Specifications .....	31
Appendix I: Setting the Output Power .....	32
Appendix II: Installing the Band Pass Filter .....	33
<b>Index .....</b>	<b>35</b>



# OWS Field Installation

This field installation manual provides instructions for installing the Strix OWS 2400 and OWS 3600 products safely and is intended for trained technical professionals. You must read the Safety Warnings on page iii before commencing with the installation.

## Theory of Operation

The Strix Systems, Access/One® Network OWS provides up to 3 independent channels of 802.11g support, and 3 independent channels of 802.11a support through its external connections. This configuration allows the installer to separate the client 802.11g traffic from the backhaul traffic which is carried through the 802.11a channels.

As shipped from the factory, the OWS is self-configuring and self-healing. In addition, multiple configuration options are possible and the installer should refer to the Access/One® Network User's Guide (part number 210-0007-01) for detailed information about these configurations.

## Important Safety Information

**The Federal Communications Commission (FCC) with its action in ET Docket 96-8 has adopted a safety standard for human exposure to RF electromagnetic energy emitted by FCC certified equipment. All Strix products, including the OWS, meet the uncontrolled environmental limits found in OET-65 and ANSI C95.1, 1991. The proper operation of this wireless device, according to the instructions found in this manual and the associated Access/One® Network software User's Guide, result in user exposure that is substantially below the FCC recommended limits.**

The following are guidelines to ensure safe operation of the Strix OWS product:

- ▶ Do not touch or move the antenna(s) while the unit is transmitting or receiving.
- ▶ Do not hold any component containing a radio such that the antenna is very close to or touching any exposed parts of the body—especially the face or eyes—while transmitting.
- ▶ Do not operate the OWS or attempt to transmit data unless the antenna (or a 50 ohm terminator) is connected, otherwise the wireless module(s) may be damaged.
- ▶ Usage in specific environments:
  - Do not operate any wireless equipment near unshielded blasting caps or in an explosive environment.
  - The use of wireless devices in hazardous locations is limited to the constraints posed by the safety directors or such environments.
  - The use of wireless devices on airplanes is governed by the Federal Aviation Administration (FAA).
  - The use of wireless devices in hospitals is restricted to the limits set forth by each hospital.
- ▶ The Strix OWS must only be used with Strix-approved components and antennas, or equivalent.

## Planning Your Installation

To ensure safe and durable wiring, the installation of the Strix OWS must follow the appropriate electrical and building codes. Observe the National Electrical Code (NEC) requirements, unless local codes in your area take precedence over the NEC code.

### *Local Guidelines*

The Strix OWS is a radio device and therefore susceptible to interference that can reduce throughput and range. Follow these simple guidelines to optimize product performance:

- ▶ Install the OWS in an area where trees, buildings, and large steel structures do not obstruct radio signals to and from the antenna(s). Direct line-of-sight operation is always best.
- ▶ Install the OWS away from microwave ovens or other devices operating in the 2.4 GHz range.
- ▶ Install the OWS away from other possible source of 2.4 GHz WLAN interference, such as cordless phones, home surveillance equipment, frequency-hopping (FHSS) and DSSS Local Area Network transceivers, electronic news gathering video links, radars, amateur radios, land mobile radio services, local government sties (for example, law enforcement), fixed microwave services, local TV transmission, and private fixed point transmitters.

### *Site Surveys*

Due to variations in product configuration, placement, and the physical environment, each installation is unique. Before installing the Strix OWS, we recommend that you perform a site survey to determine the optimum placement of the product to achieve the best possible range, coverage and network performance. Consider the following points:

- ▶ **Data Rates**—Sensitivity and range are inversely proportional to data bit rates. The maximum wireless range is achieved at the lowest data rate. A decrease in receiver threshold sensitivity occurs as wireless data increases.
- ▶ **Antenna Type and Placement**—Using the correct antenna configuration is a critical factor when trying to maximize wireless range. As a general rule, the range increases in proportion to the antenna height and gain.
- ▶ **Physical Environment**—Clear or open areas offer better wireless coverage than closed or filled areas. The less cluttered the operating environment, the greater the range.
- ▶ **Obstructions**—A physical obstruction, such as a building or tree, can block or hinder wireless services. Avoid placing antennas in locations where there is an obstruction between the sending and receiving antennas.
- ▶ **Building Materials**—Wireless penetration is influenced by the building materials used in construction. For example, drywall construction permits greater range than concrete blocks. Steel and alloy materials can be a barrier to wireless signals.
- ▶ **Diversity**—The Strix OWS supports RX diversity, which requires two antennas.

### *Power Source*

The Strix OWS supports both AC and DC input power.

## Installing the OWS Enclosure

This section provides instructions for mounting the OWS enclosure.

### Mounting the OWS on a Vertical Pole

#### Parts Required

- ▶ OWS enclosure.
- ▶ Pole.
- ▶ 2 vertical mounting brackets.
- ▶ 4 screws, for attaching the mounting brackets to the OWS enclosure.
- ▶ 2 U-bolt assemblies, for mounting the OWS enclosure to a standard 1 7/8 inch diameter steel pole.
- ▶ 2 straps, for mounting the OWS enclosure to a pole with a diameter greater than 1 7/8 inches.

#### Tools Required

- ▶ Flat blade screwdriver
- ▶ 5/16 inch nut driver
- ▶ 7/16 inch nut wrench

1. Attach the vertical mounting brackets (2) to the OWS enclosure.
2. Secure the vertical mounting brackets to the OWS enclosure with the four screws (2 for each bracket).  
Tighten all four screws to 10–12 lbf.ft (1.38–1.66 kgf.m).

Mounting Brackets (x2)

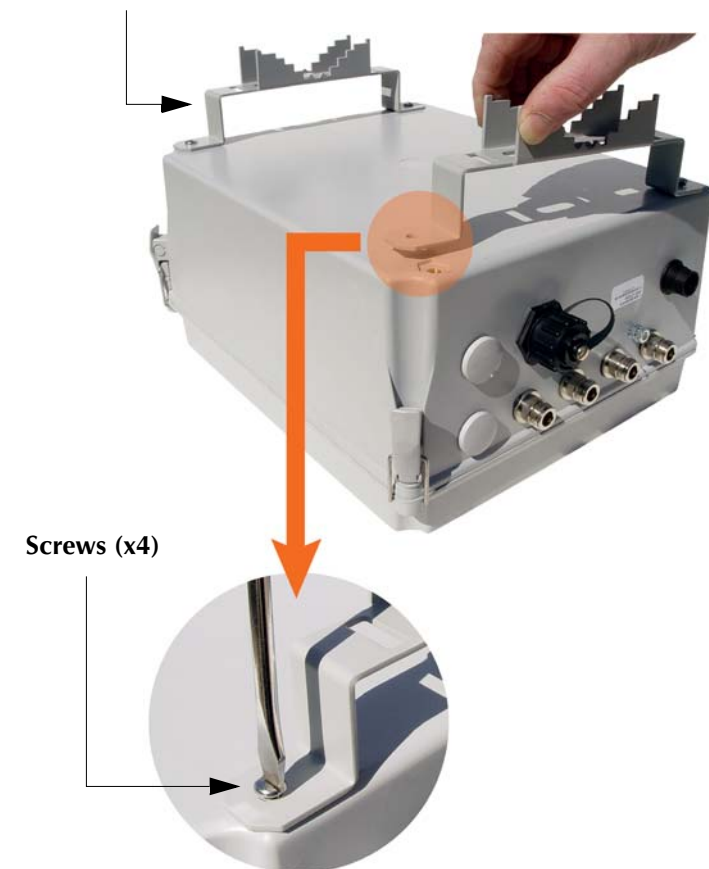

3. For a standard 1 7/8 inch diameter steel pole installation, use the 2 U-bolt assemblies to attach the enclosure to the pole via the vertical mounting brackets—*finger tighten only*.

If installing the OWS on a wider pole (for example, a utility pole), go directly to Step 7—skip Steps 3 through 6.

**Tip:** You may find it easier to loosely attach the U-bolts to the brackets, then slide the completed enclosure assembly over the pole (instead of holding the enclosure against the pole and attaching each U-bolt separately).

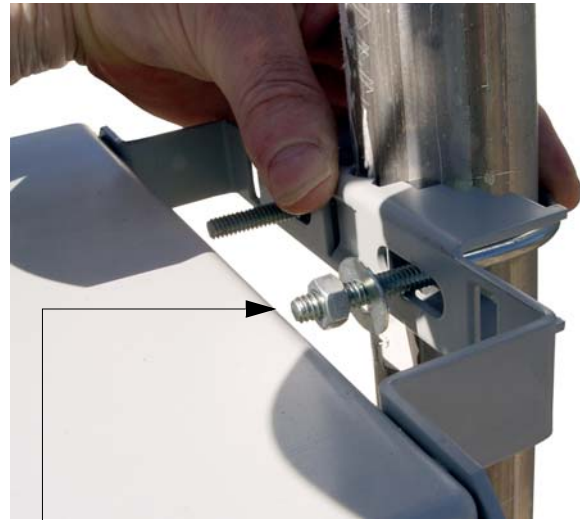

#### U-Bolt Assembly (x2)

Includes:

- ▶ U-bolt
- ▶ Washers (2)
- ▶ Nuts (2)



4. Adjust the OWS enclosure to the desired position on the pole (up and down or rotational).



5. Use a 7/16 inch nut wrench to tighten the U-bolts (4 nuts) and secure the OWS enclosure in place.

Tighten all four nuts to 10–12 lbf.ft (1.38–1.66 kgf.m).

When tightening the U-bolts, ensure that the bolts are not twisted—the ends of each U-bolt should be protruding through the bracket evenly (the same distance).



Tighten (4 places)

6. Check that the U-bolts are tight and that the OWS enclosure is securely anchored to the pole.



- For poles wider than 1 7/8 inch diameter, use two straps (hose clamps)—*not provided*. Feed one strap through each of the vertical mounting brackets.

**Recommended straps:**

Type 301 SS with Type 305 SS screw, 3.125 x 6 inches, available from McMaster-Carr (part number 54155K36).

Straps (x2)



- Loosely attach the OWS enclosure to the pole with the 2 straps.

Adjust the enclosure to the desired position on the pole (up and down or rotational). Use a flat blade screwdriver or 5/16 inch nut driver to tighten both straps to 10–12 lbf.ft (1.38–1.66 kgf.m).



## Mounting the OWS on a Wall

### Parts Required

- ▶ OWS enclosure.
- ▶ 4 nylon hangers, for mounting the OWS enclosure to a wall.
- ▶ 4 screws (10-32 x 0.375), for attaching the nylon hangers to the enclosure.

### Tools Required

- ▶ Flat blade screwdriver
- ▶ Power drill and drill bit (if necessary)

1. Attach the 4 nylon hangers to the OWS enclosure using the 4 screws provided.



2. Mount the OWS enclosure to any wall surface, ensuring that the unit is level and secure (4 places).

If mounting the enclosure to a masonry wall, you will need a power drill, masonry drill bit, and wall plugs.





## Installing Antennas

This section provides instructions for installing and connecting antennas. The antennas shown in this section are a representative sample only and are provided as a guideline for installation—your specific antenna(s) may be different, in which case refer to the instructions provided with the antenna(s).

### Antenna Warning



Antennas must be installed by a trained professional installer only.

**Do not locate any antenna near overhead power lines or other electric light or power circuits, or where the antenna can come into contact with such circuits. When installing antennas, take extreme care not to come into contact with such electrical circuits, as they can cause serious injury or death.**

For the correct installation and grounding of antennas, please refer to national and local codes (for example, US:NFPA 70, National Electrical Code, Article 810; in Canada: Canadian Electrical Code, Section 54).

### Applying Power Before an Antenna is Connected



Do not apply power to the transmitter until the antenna is connected, otherwise permanent damage may result.

### Strong RF Fields are Present



When the unit is operation, avoid standing directly in front of the antenna. Strong RF fields are present when the transmitter is ON.

## Notes About Antenna Installations

Read the following notes before installing any antenna.

- ▶ The system installer should always ensure that antenna radiation patterns do not overlap.
- ▶ A sector antenna should point towards the center of the sector covered by the antenna.
- ▶ Fixed point-to-point backhaul antennas should point towards the desired Strix Systems Access/One® Network device intended for the backhaul connection.
- ▶ Unused antenna ports must be terminated with a 50 ohm terminator.
- ▶ Only antennas approved by Strix Systems (or equivalent) may be used with the Access/One® Network Outdoor Wireless System (OWS).
- ▶ Only one antenna may be used on each antenna port.
- ▶ When installing antennas that require mounting brackets and U-bolts, it is easier to loosely attach the U-bolts to the brackets, then slide the completed antenna assembly over the pole (instead of holding the assembly against the pole and attaching each U-bolt separately—mounting brackets are shipped with the U-bolts pre-assembled. For this reason, do not install an omni antenna at the top of the pole before installing any directional/sector antennas that will reside below it.



- Depending on the selected antenna(s) for your application, it may be necessary to configure the output power of your OWS 2400 or OWS 3600 product. It is the installer's responsibility to ensure the output power is set correctly for the chosen antenna(s). To set the output power, go to [Appendix I: Setting the Output Power on page 32](#). Operation of the OWS 2400 or OWS 3600 in a manner other than as represented here is a violation of FCC rules.

## Maximum Power Settings for Antennas

The following are the maximum power settings for each antenna<sup>1</sup> type, based on wireless technology, antenna type and channels:

### Channels for IEEE 802.11b/g

12 dBi Omni Antenna (2.4 GHz)				
Channel Identifier	Frequency (MHz)	Filter	Power Level (dBm) *	
			CCK	ODFM
1	2412	Yes	Half (+24dBm)	Half (+23dBm)
2	2417	Yes	Half (+24dBm)	Half (+23dBm)
3	2422	Yes	Half (+24dBm)	Half (+23dBm)
4	2427	Yes	Half (+24dBm)	Half (+23dBm)
5	2432	Yes	Half (+24dBm)	Half (+23dBm)
6	2437	Yes	Half (+24dBm)	Half (+23dBm)
7	2442	Yes	Half (+24dBm)	Half (+23dBm)
8	2447	Yes	Half (+24dBm)	Half (+23dBm)
9	2452	Yes	Half (+24dBm)	Half (+23dBm)
10	2457	Yes	Half (+24dBm)	Half (+23dBm)
11	2462	Yes	Half (+24dBm)	Half (+23dBm)

\* Listed power level settings are **average power**.

- 
- To comply with FCC standards for broadband emissions, a band pass filter is required for 802.11g transmissions on channels 1 and 11 in the United States ([RF Linx Corporation](#) part number 2400BPF-8-FB or equivalent), and for 802.11a transmissions in the 5.725 - 5.850 GHz band when using the 23 dBi Patch Panel antenna in the United States ([K&L Microwave](#) part number 6C50-5787.5/U120-n/n or equivalent). For additional information, go to [Appendix II: Installing the Band Pass Filter on page 33](#).

16.4 dBi Sector Antenna (2.4 GHz)				
Channel Identifier	Frequency (MHz)	Filter	Power Level (dBm) *	
			CCK	ODFM
1	2412	Yes	Quarter (+21 dBm)	Quarter (+20dBm)
2	2417	Yes	Quarter (+21 dBm)	Quarter (+20dBm)
3	2422	Yes	Quarter (+21 dBm)	Quarter (+20dBm)
4	2427	Yes	Quarter (+21 dBm)	Quarter (+20dBm)
5	2432	Yes	Quarter (+21 dBm)	Quarter (+20dBm)
6	2437	Yes	Quarter (+21 dBm)	Quarter (+20dBm)
7	2442	Yes	Quarter (+21 dBm)	Quarter (+20dBm)
8	2447	Yes	Quarter (+21 dBm)	Quarter (+20dBm)
9	2452	Yes	Quarter (+21 dBm)	Quarter (+20dBm)
10	2457	Yes	Quarter (+21 dBm)	Quarter (+20dBm)
11	2462	Yes	Quarter (+21 dBm)	Quarter (+20dBm)

\* Listed power level settings are **average power**.

## Channels for IEEE 802.11a

12 dBi Omni Antenna (5.25 – 5.35 GHz)			
Channel Identifier	Frequency (MHz)	Filter	Power Level (dBm) *
			ODFM
52	5260	No	Quarter (+17dBm)
56	5280	No	Quarter (+17dBm)
60	5300	No	Quarter (+17dBm)
64	5320	No	Quarter (+17dBm)

\* Listed power level settings are **average power**.

12 dBi Omni Antenna (5.725 – 5.85 GHz)			
Channel Identifier	Frequency (MHz)	Filter	Power Level (dBm) *
			ODFM
149	5745	No	Half (+23dBm)
153	5765	No	Full (+26dBm)
157	5765	No	Full (+26dBm)
161	5805	No	Full (+26dBm)
165	5825	No	Half (+23dBm)

\* Listed power level settings are **average power**.

23 dBi Patch Panel Antenna (5.25 – 5.35 GHz)			
Channel Identifier	Frequency (MHz)	Filter	Power Level (dBm) *
			ODFM
52	5260	No	Minimum (+5dBm)
56	5280	No	Minimum (+5dBm)
60	5300	No	Minimum (+5dBm)
64	5320	No	Minimum (+5dBm)

\* Listed power level settings are **average power**.

23 dBi Patch Panel Antenna (5.725 – 5.85 GHz)			
Channel Identifier	Frequency (MHz)	Filter	Power Level (dBm) *
			ODFM
149	5745	Yes	Half (+23dBm)
153	5765	Yes	Full (+26dBm)
157	5765	Yes	Full (+26dBm)
161	5805	Yes	Full (+26dBm)
165	5825	Yes	Half (+23dBm)

\* Listed power level settings are **average power**.

## Attaching an Omni Antenna Directly to the OWS Enclosure

### Parts Required

- ▶ Omni Antenna, with optional adapter (no special tools required).

1. If necessary, connect the optional antenna adapter to the desired antenna port at the bottom of the OWS enclosure.

Hand tighten, making sure the adapter is firmly in place—you can use an adjustable wrench, but do not overtighten or damage the adapter.



2. Thread the omni antenna onto the antenna adapter—the electrical connection between the antenna and the enclosure is established via the adapter.

There are no external cables required when attaching an omni antenna directly to the OWS enclosure.

See also, [Antenna Connector Wiring Configurations on page 22](#).



## Mounting a Directional Antenna on a Pole

### Parts Required

- ▶ Pole.
- ▶ Directional antenna (includes adjustable mounting bracket).
- ▶ 2 straps, for mounting the antenna to a standard 1 7/8 inch diameter steel pole.
- ▶ Antenna cable.

### Tools Required

- ▶ Flat blade screwdriver

1. Attach the 2 straps (hose clamps) to the mounting bracket.

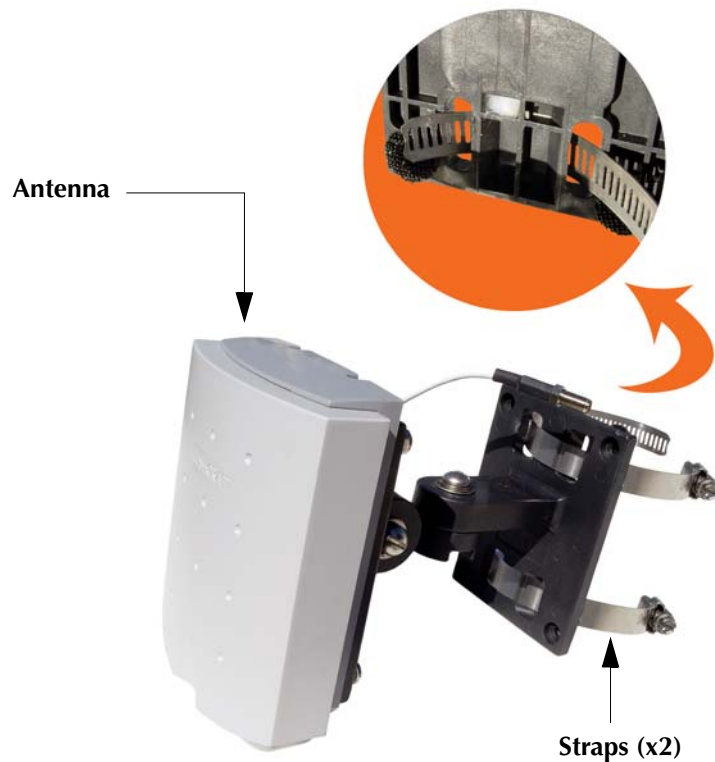

2. Mount the antenna to the pole with the 2 straps.

Adjust the antenna to the desired position, then use a flat blade screwdriver or 5/16 inch nut driver to tighten both straps to 10–12 lbf.ft (1.38–1.66 kgf.m).



- Using a flat blade screwdriver, fine tune the position of the antenna by adjusting the mounting bracket along the vertical axis and the horizontal axis.

Tighten the mounting bracket adjustment screws to 10–12 lbf.ft (1.38–1.66 kgf.m).

## Vertical Adjustment



## Horizontal Adjustment

- Connect one end of the antenna cable to the directional antenna, then connect the other end of the cable to an available antenna port on the OWS enclosure.

See also, [Antenna Connector Wiring Configurations on page 22](#) and [Antenna Connector Wiring Configurations on page 22](#).



## Antenna Cable

Connect between the directional antenna and a free antenna port on the OWS enclosure

## Mounting a Sectored Antenna on a Pole

### Parts Required

- ▶ Pole.
- ▶ Sectored antenna.
- ▶ 2 U-bolt assemblies, for mounting the antenna to a standard 1 7/8 inch diameter steel pole.
- ▶ Adjustable mounting bracket (including antenna mounting plate and U-bolt assemblies).
- ▶ Antenna cable.

### Tools Required

- ▶ 7/16 inch nut wrench

1. If not already assembled, assemble the adjustable mounting bracket.

Secure the antenna mounting plate to the antenna body with 4 x 7/16 inch screws and spring washers. Use a 7/16 inch nut wrench to tighten the screws to 10–12 lbf.ft (1.38–1.66 kgf.m).

Attach the mounting bracket to the antenna mounting plate with 6 x 7/16 inch screws and spring washes—finger tighten only.

*The U-bolts are pre-assembled with the mounting bracket.*

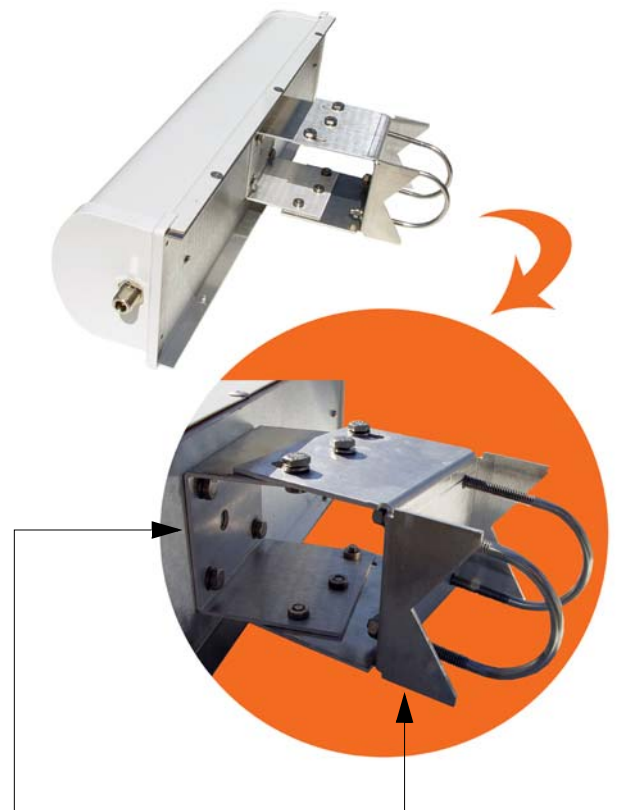

**Antenna Mounting Plate**  
Secure to antenna body with 4 x 7/16 inch screws and spring washers

**Mounting Bracket**  
Attach to mounting plate with 6 x 7/16 inch screws and spring washers—finger tighten only



2. Attach the sectored antenna to the pole—finger tighten only.
3. Adjust the antenna to the desired position on the pole (up and down or rotational).



4. Use a 7/16 inch nut wrench to tighten the U-bolts (4 nuts) and secure the sectored antenna in place.

Tighten all four nuts to 10–12 lbf.ft (1.38–1.66 kgf.m).

When tightening the U-bolts, ensure that the bolts are not twisted—the ends of each U-bolt should be protruding through the mounting bracket evenly (the same distance).



5. If necessary, use a 7/16 inch nut wrench to loosen the 6 bolts on the adjustable mounting bracket. Make your vertical adjustment to the sectored antenna (up to 30 degrees), then tighten all 6 bolts to 10–12 lbf.ft (1.38–1.66 kgf.m).

**Vertical Adjustment (up to 30 degrees)**



6. Connect one end of the antenna cable to the sectored antenna, then connect the other end of the cable to an available antenna port on the OWS enclosure.

See also, [Antenna Connector Wiring Configurations on page 22](#) and [Antenna Connector Wiring Configurations on page 22](#).



**Antenna Cable**

Connect between the sectored antenna and a free antenna port on the OWS enclosure

## Mounting an Omni Antenna on a Pole

### Parts Required

- ▶ Pole.
- ▶ Omni antenna.
- ▶ 2 U-bolt assemblies, for mounting the antenna to a standard 1 7/8 inch diameter steel pole.
- ▶ Mounting bracket.
- ▶ Antenna cable.

### Tools Required

- ▶ 1/2 inch nut wrench
- ▶ 7/8 inch nut wrench

1. Attach the omni antenna to the mounting bracket, using the washer and locknut provided.  
*The U-bolts are pre-assembled with the mounting bracket.*

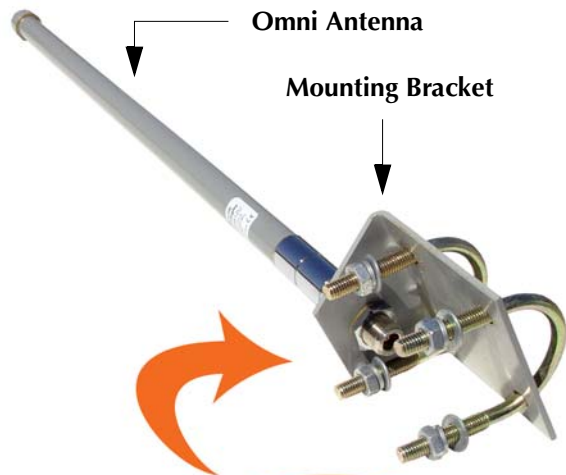

2. Use a 7/8 inch nut wrench to tighten the locknut to 10–12 lbf.ft (1.38–1.66 kgf.m).

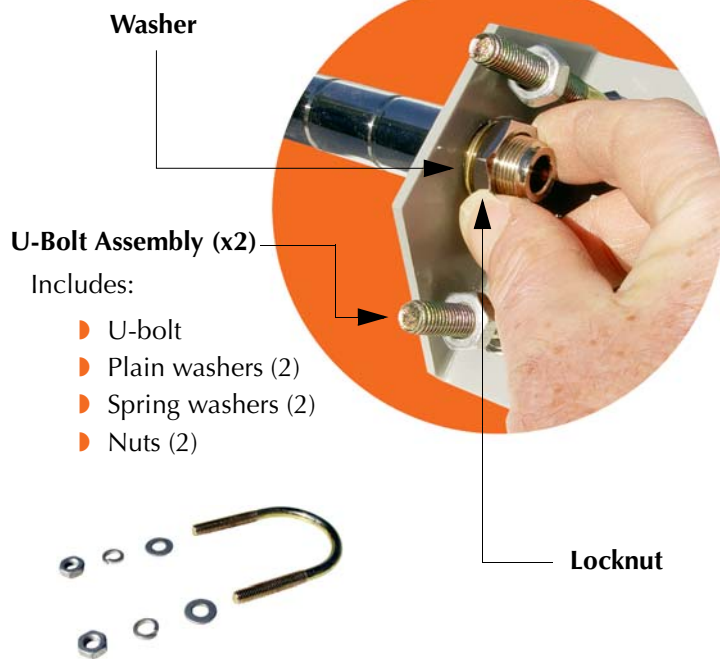

3. Attach the omni antenna to the pole—finger tighten only.
4. Adjust the omni antenna to the desired position on the pole (up and down or rotational).

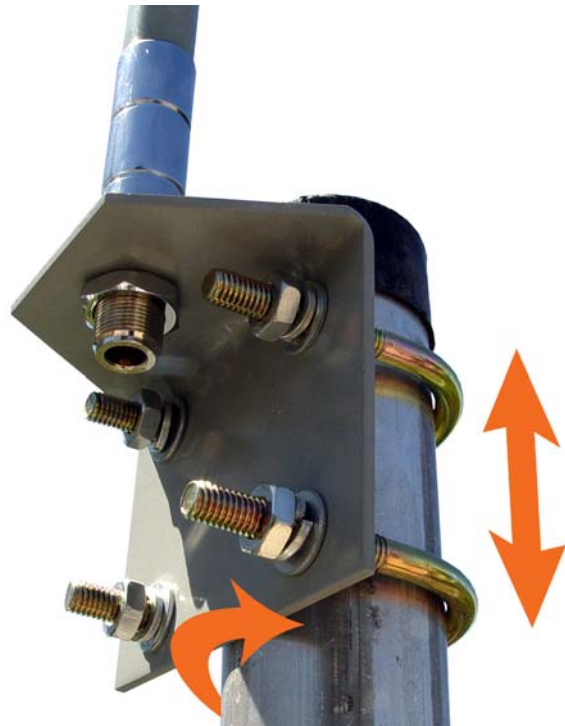

5. Use a 1/2 inch nut wrench to tighten the U-bolts (4 nuts) and secure the omni antenna in place.

Tighten all four nuts to 10–12 lbf.ft (1.38–1.66 kgf.m).

When tightening the U-bolts, ensure that the bolts are not twisted—the ends of each U-bolt should be protruding through the mounting bracket evenly (the same distance).

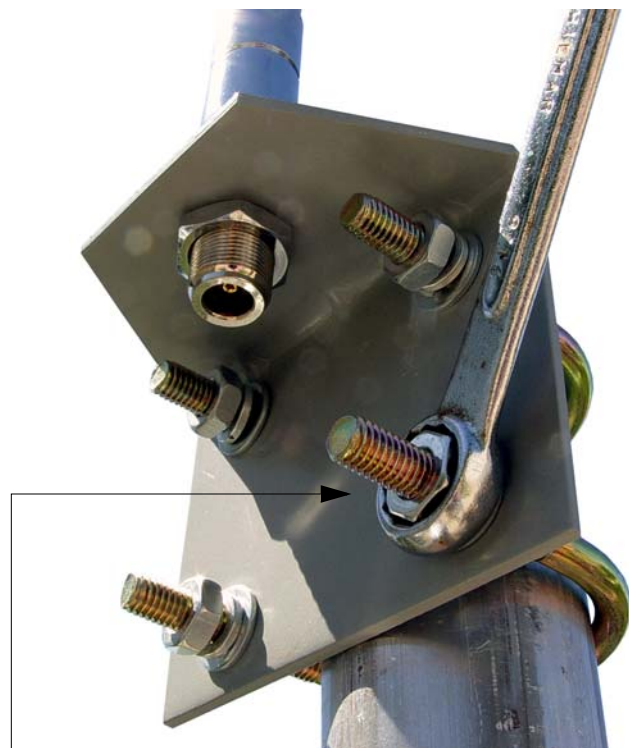

Tighten (4 places)

6. Check that the U-bolts are tight and that the omni antenna is securely anchored to the pole.

7. Connect one end of the antenna cable to the omni antenna, then connect the other end of the cable to an available antenna port on the OWS enclosure.

See also, [Antenna Connector Wiring Configurations on page 22](#) and [Antenna Connector Wiring Configurations on page 22](#).



### **Antenna Cable**

Connect between the omni antenna and a free antenna port on the OWS enclosure

## Antenna Connector Wiring Configurations

The following table shows the antenna connector wiring configurations for the OWS family of products:

Antenna Connector Wiring		
Product	Enclosure Connector	Module Connector
2400 series and 3600 series	ant. 1	G ANT1 – J24
2400 series and 3600 series	ant. 2	A ANT1 – J21
2400 series and 3600 series	ant. 3	G ANT1 – J24
2400 series and 3600 series	ant. 4	A ANT1 – J21
2400 series and 3600 series	ant. 5	G ANT1 – J24
2400 series and 3600 series	ant. 6	A ANT1 – J21
3600 series only	ant. 7	A ANT1 – J21
3600 series only	ant. 8	G ANT1 – J24

### Physical Layout (Enclosure)

The following diagram shows the physical layout of antenna connectors on the OWS 3600 enclosure (the OWS 2400 does not have the **ant. 7** or **ant. 8** antenna options).

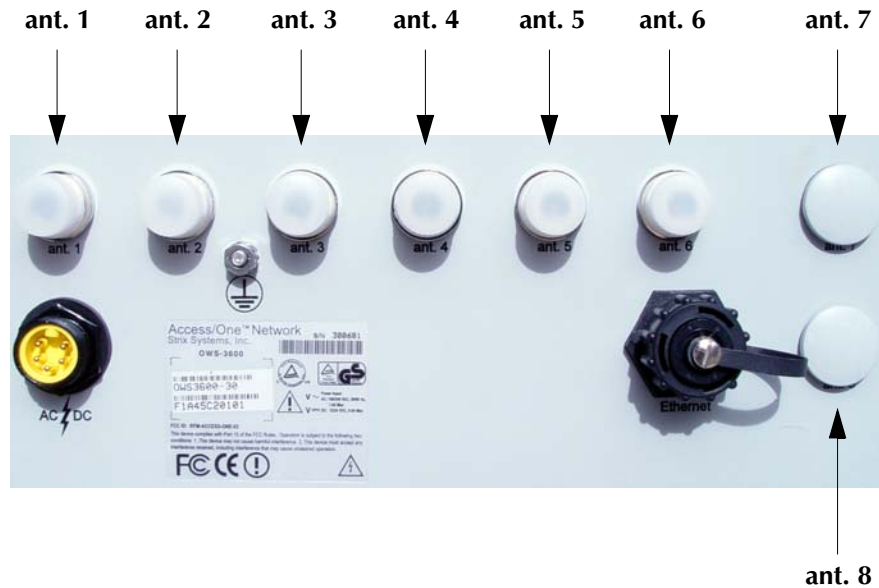



## Physical Layout (Wireless Modules)

The following diagram shows the physical layout of antenna connectors on the OWS wireless modules (top view, looking down on module when the enclosure door is open).

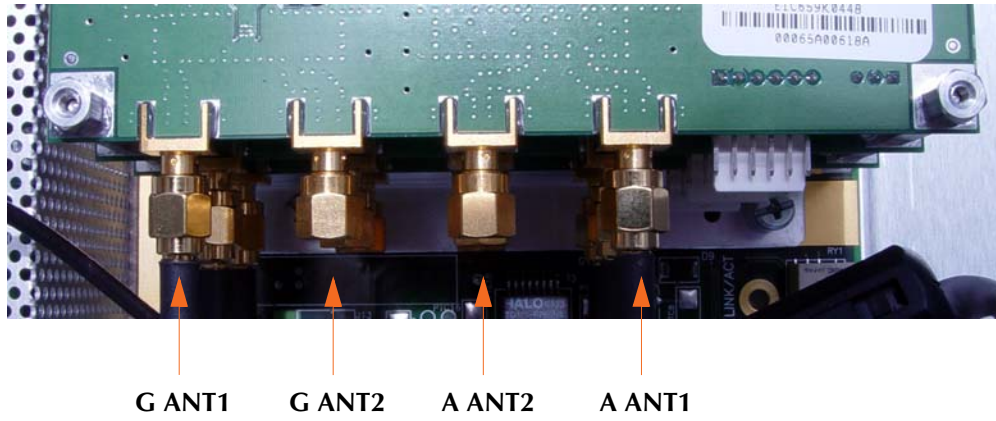

## Routing the Antenna Cables

It is important that when you install the antenna cables they are not hanging randomly and that the cables are secured. This section provides a sample routing scenario.

1. If mounting the OWS on a pole, route the antenna cables through the OWS enclosure mounting bracket and secure with cable ties. Ensure that the cables are not twisted.
2. If mounting the OWS on a wall, the cables should be fixed to the wall with a suitable cable clamp.



## Grounding the OWS Enclosure

This section provides instructions for grounding the OWS enclosure.

### Grounding Caution



You must ALWAYS install an external grounding wire. The ground connection must be complete before connecting power to the OWS enclosure—a simple continuity check between the enclosure and the ground termination point can confirm this. Grounding of the OWS must comply with National Electrical Code (NEC) requirements, unless local codes in your area take precedence over the NEC code.

### Parts Required

- ▶ Ground wire assembly (with ring terminator)—must be 18 gauge AWG wire, or greater.

### Tools Required

- ▶ 3/16 inch nut wrench
- ▶ Wire stripper (if necessary)

1. Connect the ground wire to the ground terminal on the bottom of the OWS enclosure.

Make sure the lock washer is in place and that the nut is securely fastened.



Ground Wire

2. Connect the other end of the ground wire to a grounding strap attached to a grounded surface, such as a cold water pipe (or other suitable ground termination point, compliant with NEC and local standards).

On pole-mounted OWS enclosures, if the pole (or pole stand) is already grounded, you may use one of these items as the ground termination point.

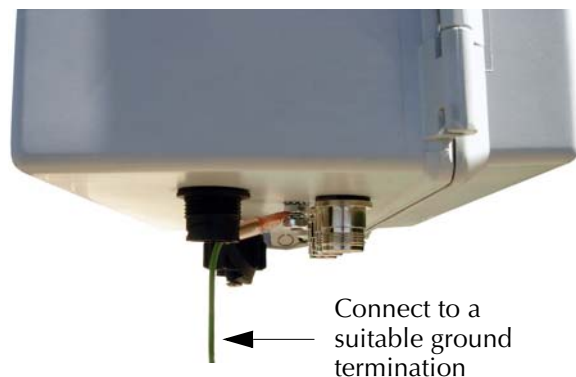



## Configuring the Power Cord

This section provides instructions for configuring the power cord (not supplied) for either AC or DC operation, and connecting the power cord to the OWS enclosure.

### Electrical Power Warning



This unit must be installed by a trained professional installer only. Read the installation instructions before you connect the wireless network device to its power source.

### Power Cord Assembly Caution



The power cord must be assembled by a professional installer, and the final assembly must comply with National Electrical Code (NEC) requirements, unless local codes in your area take precedence over the NEC code.

### Parts Required

- ▶ AC or DC power cord (not supplied), cut to the desired length.
- ▶ AC/DC plug assembly.

### Tools Required

- ▶ Wire stripper
- ▶ Flat blade screwdriver

#### 1. Review the pin connections.

- ▶ Pin 1 – AC Neutral
- ▶ Pin 2 – DC Positive (+)
- ▶ Pin 3 – Ground
- ▶ Pin 4 – DC Negative (-)
- ▶ Pin 5 – AC Line

*The example opposite shows an AC plug assembly.*

#### 2. Assemble the plug and connect the plug to the power cord of your choice for the electrical configuration you need, either AC or DC.

*The power cord must be assembled by a professional installer.*



3. Attach the plug to the enclosure's power receptacle.

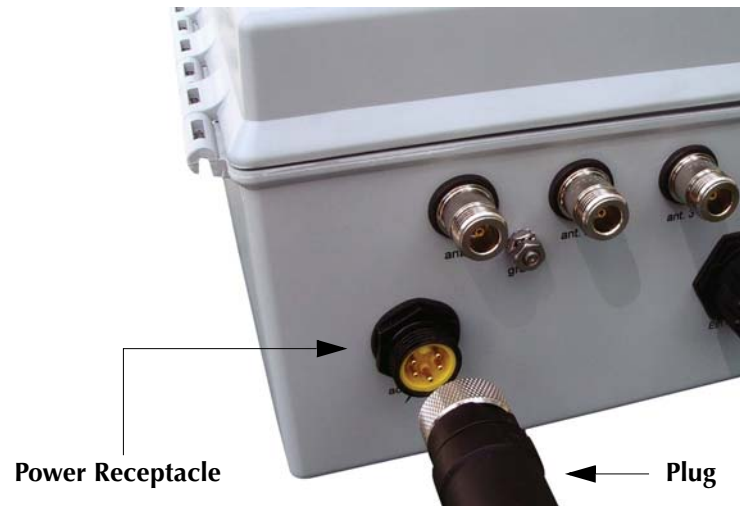

4. Turn the locking ring of the plug and hand tighten to make the connection.

5. Install an appropriate AC or DC connector at the other end of the power cord.



The AC<sup>1</sup> connector you use at the other end of the power cord depends on the AC power source you are connecting to. Refer to [AC Wiring Configurations on page 27](#).

- 
1. If using an AC power source, to comply with FCC standards for radiated spurious EMF emissions a 30 MHz to 1 GHz ferrite core must be attached to the AC power cord in a double-turn configuration (as close to the OWS enclosure as possible. A suitable ferrite core for this purpose can be obtained from [Fair-Rite Products Corporation](#), part number 0444164181 (round cable snap-it model).

## AC Wiring Configurations

The following diagrams show alternative wiring configurations for AC input power options.

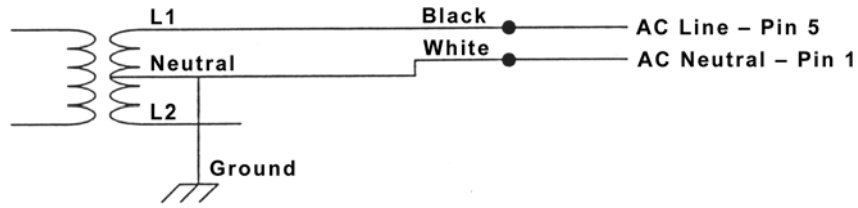

120 VAC Single Phase (two wire service)

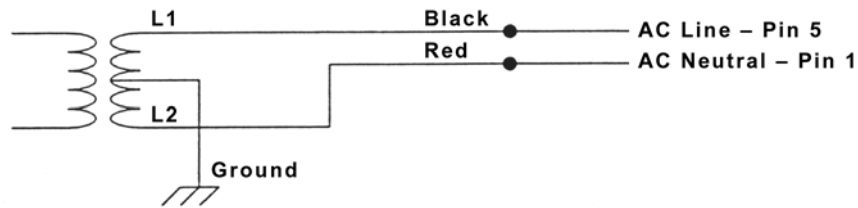

240 VAC Single Phase (two wire service)

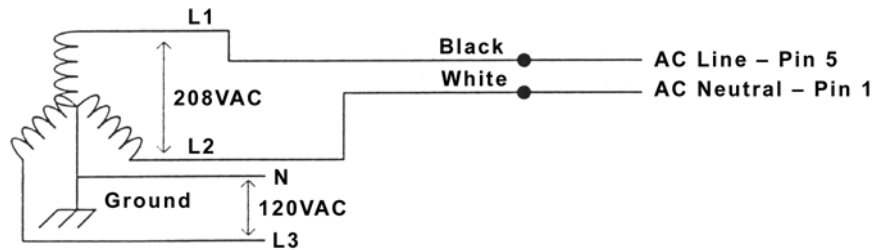

208 VAC Three Phase (two wire service - grounded/Wye)

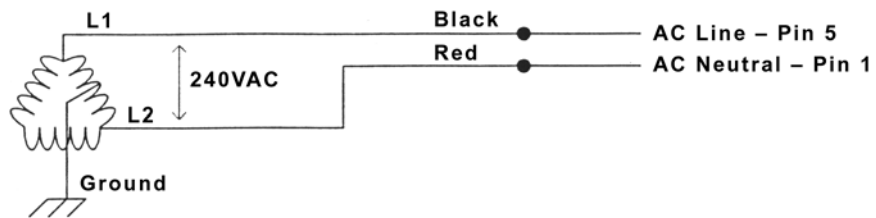

240 VAC Three Phase (two wire service - Delta)

## Connecting the Ethernet Cable

This section provides instructions for configuring the CAT5 Ethernet cable.

### Parts Required

- ▶ Plenum-rated CAT5 Ethernet cable, cut to the desired length (not supplied).
- ▶ RJ45 plug assembly.

### Tools Required

- ▶ Wire stripper
- ▶ Continuity checker

#### 1. Review the pin connections.

- ▶ Pin 1 – TXD+ (TX Data)
- ▶ Pin 2 – TXD- (TX Data)
- ▶ Pin 3 – RXD+ (RX Data)
- ▶ Pin 4 – Not used
- ▶ Pin 5 – Not used
- ▶ Pin 6 – RXD- (RX Data)
- ▶ Pin 7 – Not used
- ▶ Pin 8 – Not used

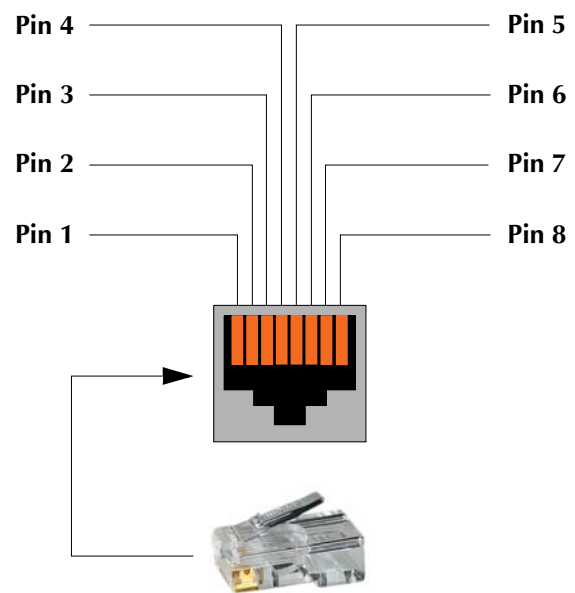

2. Assemble the RJ45 plug/cable.
  - ▶ Item 1 – Shielded RJ45 plug
  - ▶ Item 2 – Gasket seal
  - ▶ Item 3 – Plug holder
  - ▶ Item 4 – Coupling ring
  - ▶ Item 5 – Seal assembly

*When assembling the plug, take care not to lose the gasket seal (item 2)—it must be in place when the assembly is complete.*

3. Install an RJ45 plug at the other end of the cable.
4. Perform a continuity check on each pin to verify that the Ethernet cable<sup>1</sup> has been assembled correctly.

5. Unscrew the protective cap, then connect the Ethernet cable to the OWS enclosure.

Turn the coupling ring clockwise (1/4 turn) to make the connection.

*The connection is locked when you feel and hear a click.*

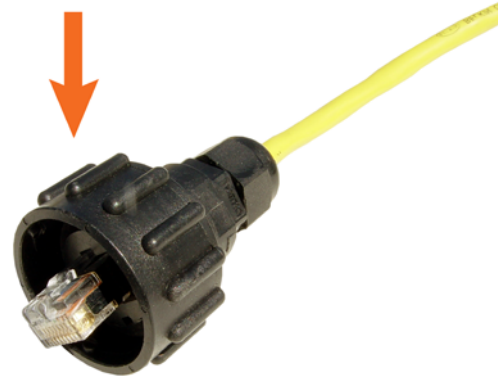

---

1. To comply with FCC standards for radiated spurious EMF emissions a 30 MHz to 1 GHz ferrite core must be attached to the Ethernet cable in a double-turn configuration. A suitable ferrite core for this purpose can be obtained from [Fair-Rite Products Corporation](#), part number 0444167281 (round cable snap-it model).

## Powering Up the OWS

This section provides instructions for powering up the OWS from both an AC and DC power source.

### Powering Up from an AC Power Source

#### Important Note (AC Power)



AC input: 100 – 240 VAC (50/60 Hz) at 1.0 Amp maximum, supplied by a separate branch circuit with 2 Amp over-current protection (2 Amp circuit breaker).

The OWS must always be grounded before applying power to the unit—see *Grounding the OWS Enclosure on page 24*.

1. Verify that the AC service voltage is 120 VAC to 240 VAC.
2. Check that the power is turned OFF at the designated circuits.
3. If necessary, install 1/2 inch liquid-tight conduit from the power source to within 3 feet of the OWS, then connect the conduit to a junction box. The conduit and junction box must be IEEE/ANSI compliant and suitable for outdoor use.
4. Connect the OWS power cord to the AC supply.
5. Close the enclosure's door (the OWS door interlock will actuate).
6. Turn ON the AC supply.

### Powering Up from a DC Power Source

#### Important Note (DC Power)



DC input: 12 – 24 VDC at 9.0 Amp maximum, supplied by an external separate 250 VA power-limited (or less) and isolated DC source with 15 Amp over-current protection (15 Amp circuit breaker).

The OWS must always be grounded before applying power to the unit—see *Grounding the OWS Enclosure on page 24*.

1. Verify that the DC service voltage is 12 VDC to 24 VDC.
2. Check that the power is turned OFF at the designated circuits.
3. If necessary, install 1/2 inch liquid-tight conduit from the power source to within 3 feet of the OWS, then connect the conduit to a junction box. The conduit and junction box must be IEEE/ANSI compliant and suitable for outdoor use.
4. Connect the OWS power cord to the DC supply.
5. Close the enclosure's door (the OWS door interlock will actuate).
6. Turn ON the DC supply.

## OWS Product Specifications

### WIRELESS

- ▶ Wireless Standards: IEEE 802.11 a/g
- ▶ Frequency Bands:
  - 802.11a
    - 5.25 - 5.35 GHz
    - 5.725 - 5.850 GHz
  - 802.11g
    - 2.4 - 2.4835 GHz (Americas, FCC)
- ▶ Data Rates (Mbps):
  - 6, 9, 12, 18, 24, 36, 48, 54 (802.11a/g)
  - 12, 18, 24, 36, 48, 72, 96, 108 (802.11a Turbo)
- ▶ Wireless Medium:
  - 802.11a – OFDM, 802.11g – DSSS
- ▶ Modulation:
  - 802.11a: BPSK, QPSK, 16 QAM, 64 QAM
  - 802.11g: DBPSK, DQPSK, CCK
- ▶ Operating Channels:
  - 802.11a
    - 12 (Americas, FCC), includes 3 turbo channels
  - 802.11g
    - 11 (Americas, FCC)
- ▶ Transmit Power:
  - Configuration dependent—contact Strix
- ▶ Receiver Sensitivity:
  - Configuration dependent—contact Strix
- ▶ LO (crystal) Frequency Stability:
  - +/-10PPM within normal op. range of 0° to 55°C

### ELECTRICAL

- ▶ Power Input:
  - Auto-sensing 120/240 VAC, 50/60 Hz, single phase, with ANSI/IEEE C62.41 category C3 integrated branch circuit protection
- ▶ AC Power Consumption:
  - 25W typical, 90W maximum
- ▶ DC Input:
  - 12/24V, 9A maximum

### PROTECTION CIRCUITS

- ▶ Antenna Lightning Protection (optional):
  - < 9µJ for 6kV/3kA @ 8/20µs waveform
- ▶ Electrical Protection:
  - ANSI/IEEE C62.41, UL 1449 2nd edition; 10kA @ 8/20 µs waveform, 36kA per phase; L-L, L-N, L-PE
- ▶ Data Protection:
  - EN61000-4-2 Level 4 ESD Immunity
  - EN61000-4-5 Level 4 AC Surge Immunity
  - EN61000-4-4 Level 4 Elect. Fast Transient Burst Immun.
  - EN61000-4-3 EMV Field Immunity

### ENVIRONMENTAL

- ▶ Operating Temperature: -40°C to +55°C
- ▶ Storage Temperature: -55°C to +85°C
- ▶ Humidity: 10% to 90% non-condensing
- ▶ Weather Rating: IP67 weather tight
- ▶ Wind Survivability: ≤165 mph
- ▶ Wind Loading (165 mph): <1024 newtons
- ▶ Salt/Fog/Rust Resistance: Mil-STD-810F 509.4
- ▶ Shock & Vibration:
  - ESTI 300-192-4 spec T41.E
  - Class 4M3 and Mil-STD-810
- ▶ Transportation: ISTA 2A and Mil-STD-810

### PHYSICAL

- ▶ Dimensions:
  - 3600 Series: 14" high x 12" wide x 8" deep (without accessories)
  - 2400 Series: 12" high x 10" wide x 6" deep (without accessories)
- ▶ Weight:
  - 3600 Series: 16.5lbs (7.48 Kg)
  - 2400 Series: 14.5lbs (6.58 Kg)
- ▶ NEMA 4 rated for outdoor enclosures

### SECURITY

- ▶ Authentication:
  - 802.1x support, including RADIUS client, EAP-MD5, EAP-TLS, and PEAP-TTLS, WPA
- ▶ Encryption:
  - IEEE 802.11i (WPA) with AES, and WEP

### REMOTE MANAGEMENT

- ▶ Web, CLI and SNMP interfaces
- ▶ Supports BOOTP, DHCP, Telnet, SSH, HTTP, HTTPS, and FTP
- ▶ SNMP: MIB II, 802.11 MIB, and Strix private MIBs

### APPROVALS

- ▶ FCC CFR47 Part 15, Class B
- ▶ Industry Canada RSS210
- ▶ EN60950 cTUVus Listed I.T.E
- ▶ UL 579/IEC 60529 IP67, rated for outdoor use
- ▶ UL 1449 2nd edition / IEC 60664-1
- ▶ CAN/CSA-C22.2 60950-00
- ▶ VCCI Class B

### WARRANTY

- ▶ One year parts and labor

## Appendix I: Setting the Output Power

Use the following procedure to set the output (transmit) power for the chosen antenna:

1. Establish a Telnet connection with the selected wireless module (radio).
2. Log in to the radio.
3. Type the command **get power**.

The system displays the current power settings for the selected radio.

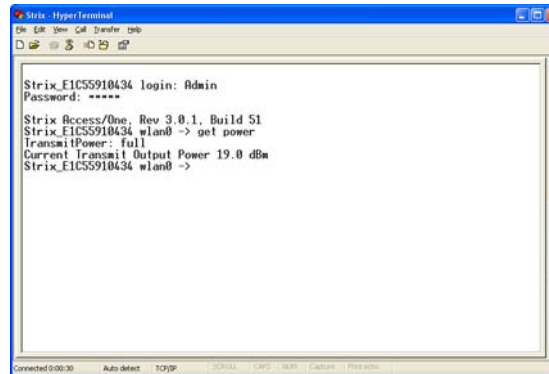

```

Strix_E1C55910434 login: Admin
Password: ****
Strix Access/One, Rev 3.0.1, Build 51
Strix_E1C55910434 wlan0 -> get power
TransmitPower: full
Current transmit Output Power 19.0 dBm
Strix_E1C55910434 wlan0 ->
    
```

If the radio is set to the desired power setting, no further action is required and you can log out, otherwise go to Step 4. The following list shows the available power settings:

- ▶ **Full** – sets the maximum (normal) transmit power. This is the default setting.
  - ▶ **Half** – sets the transmit power to a fractional half of the full power.
  - ▶ **Quarter** – sets the transmit power to a fractional quarter of the full power.
  - ▶ **Eighth** – sets the transmit power to a fractional eighth of the full power.
  - ▶ **Minimum** – sets the transmit power to its minimum.
4. To set the power output for the selected radio, type the command **set power** and append the desired setting to the command. For example, to set the output power to minimum, type **set power min**. Or, to set the output power to one quarter, type **set power quarter**.

When the command is entered, the system displays the new power setting automatically. However, if you need to verify the output power setting for any radio, use the command **get power**. The following graphic shows the output power for a radio being changed from **full** to one **quarter**.

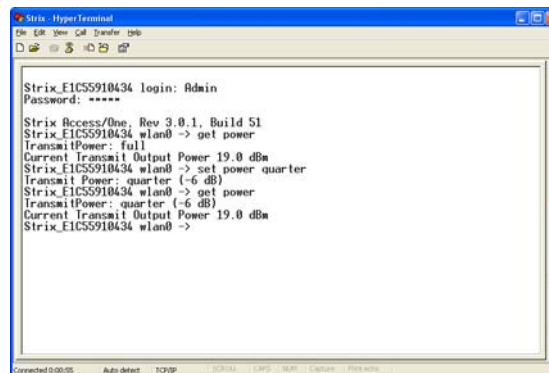

```

Strix_E1C55910434 login: Admin
Password: ****
Strix Access/One, Rev 3.0.1, Build 51
Strix_E1C55910434 wlan0 -> get power
TransmitPower: full
Current transmit Output Power 19.0 dBm
Strix_E1C55910434 wlan0 -> set power quarter
Transmit Power: quarter (-6 dB)
Strix_E1C55910434 wlan0 -> get power
TransmitPower: quarter (-6 dB)
Current transmit Output Power 19.0 dBm
Strix_E1C55910434 wlan0 ->
    
```



## Appendix II: Installing the Band Pass Filter

The band pass filter must be installed as close to the OWS enclosure as possible. The following graphic shows the filter installed on the OWS at its preferred location (connected directly to the antenna connector on the enclosure).

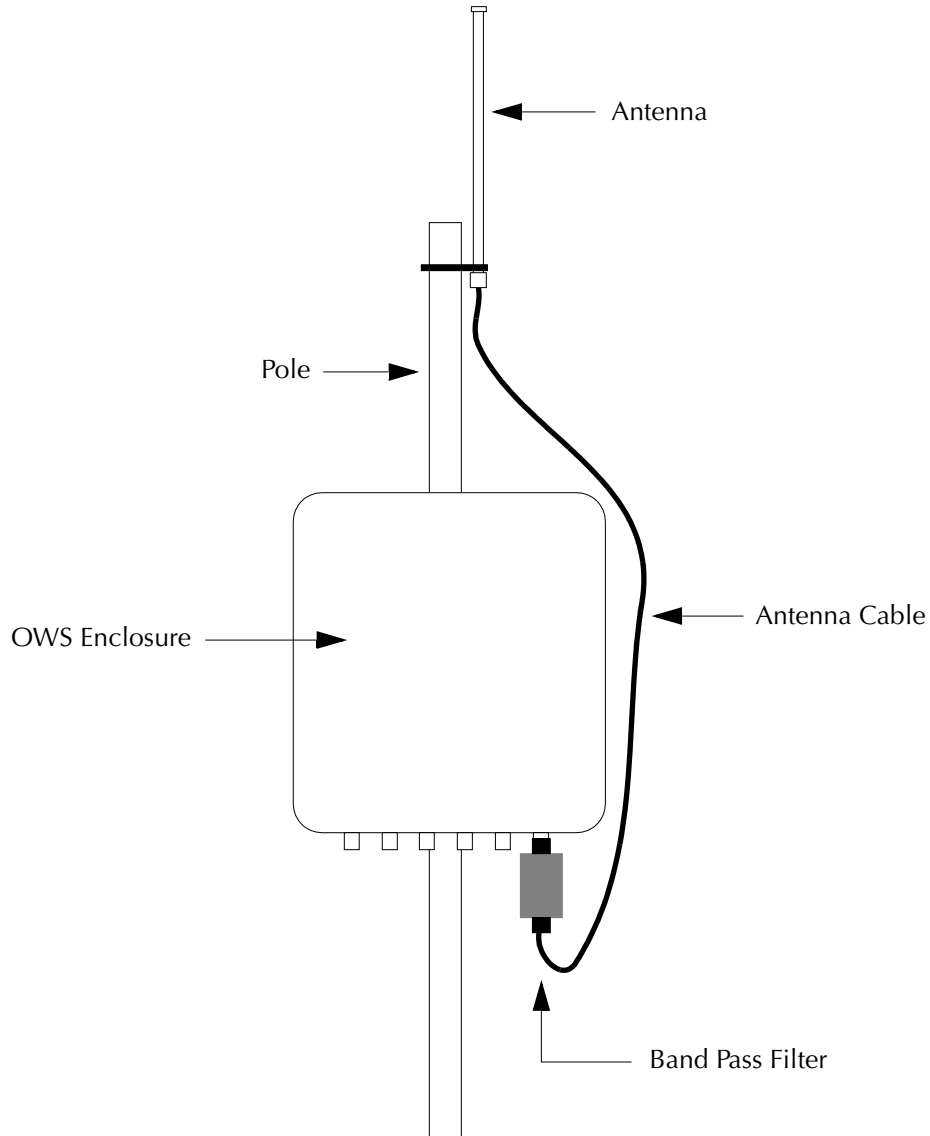



# Index

## A

AC power 30  
 adapter 12, 13  
 airplanes  
   use in 1  
 antenna  
   directional 14  
 antenna adapter 13  
 antennas  
   cable routing 23  
   directional 14  
   installing 8  
   omni 12, 19  
   placement 2  
   routing cables 23  
   sectored 16  
   type 2

## B

band pass filter  
   installing 33  
 building codes 2  
 building materials 2

## C

CAT5 28  
 CAT5 cable 28  
 contact information i  
 continuity check 29  
 copyright notice i, ii  
 coupling 29

## D

data rates 2  
 DC power 30  
 directional antenna 8, 14  
   adjusting 15

## E

enclosure 3  
 enclosure  
   grounding 24  
 environmental limits 1  
 Ethernet cable 28  
 European Community (EC) conformity ii  
 explosive device proximity iii

## F

FAA 1

FCC notice ii  
 Federal Aviation Administration 1  
 filter 33

## G

gasket seal 29  
 ground termination 24  
 grounding 24

## H

hazardous locations 1  
 hospitals  
   use in 1

## I

Industry Canada notice ii

## L

limited warranty v  
 local guidelines 2

## M

maximum power settings 9  
 mounting 3  
   brackets 3  
   on a vertical pole 3  
   on a wall 7

## N

NEC code 2, 24, 28  
 non-modification statement iii  
 notices ii  
   European Community (EC) ii  
   FCC ii  
   Industry Canada ii  
   VCCI ii

## O

obstructions 2  
 omni antenna 8, 12, 19  
 output power  
   setting 32  
 over-current protection 30  
 OWS 2400 1  
 OWS 3600 1  
 OWS enclosure 3  
   grounding 24

## P

physical environment 2  
 planning the installation 2  
 planning your installation 2  
 pole 3

- power settings 9
- power source 2
- powering up 30
- product specifications 31

## R

- RF exposure iii
- RJ45 plug assembly 29

## S

- safety information 1
- safety warnings iii
- sectored antenna 16
- setting the transmit power 32
- site survey 2
- site surveys 2
- solar shield iv
- specifications 31
- straps 3, 6
- Strix contact information i
- survey 2

## T

- table of contents vii
- theory of operation 1
- transmit power 32

## U

- u-bolts 3, 4

## V

- VCCI notice ii
- vertical mounting brackets 3
- vertical pole 3

## W

- warnings iii
  - antenna placement iv
  - electrical power iii
  - general safety iii
  - grounding the unit iv
  - lightning activity iii
- warranty v