

Foreword

This booklet is a supplement to the Owner's Manual for SUBARU B9 TRIBECA and contains a detailed description and instructions for proper operation of the Rear Seat Entertainment System provided in your vehicle.

To ensure optimum and correct use of your Rear Seat Entertainment System, please read this supplement and get acquainted with the system before using it.

Please keep this supplement together with your Owner's Manual and leave it in the vehicle at the time of resale. The next owner will need the information it contains.

FUJI HEAVY INDUSTRIES LTD., TOKYO, JAPAN

Contents

Safety Warnings	3	■ Skipping chapters backward	29
Before Use	4	■ Title search	30
System Components	5	■ Skipping to a predetermined screen	31
Basic Operations	6	■ Displaying each disc's menu on the screen	31
What You Can Enjoy with Your Rear Seat Entertainment		■ Changing the audio language	32
System	6	■ Changing the subtitle language	33
Display	7	■ Image angle selection on multi-angle recorded scenes	34
■ How to open and close the display	7	■ Selecting a dynamic range control setting	35
■ Keeping the display clean	9	Playing Video CDs	36
Remote Control	10	■ Starting playback	36
■ Control buttons and joystick	12	■ Stopping playback	36
■ How to use the remote control	14	■ Pausing	36
■ Replacing the battery	16	■ Fast-forwarding	37
Wireless Headphones	18	■ Fast-reversing	37
■ Replacing the batteries	20	■ Skipping tracks forward	38
DVD Player	22	■ Skipping tracks backward	39
Precautions to Observe When Handling Discs	23	■ Skipping to a predetermined screen (Ver 2.0 video CD only)	39
Types of Discs Playable with the Rear Seat Entertainment		■ Sound channel (MAIN/SUB) selection	40
System	23	Playing Music CDs	40
■ DVD video discs	25	■ Starting playback	40
■ Copyright	26	■ Stopping playback	40
Playing Discs	27	■ Fast-forwarding	41
Playing DVD Video Discs	27	■ Fast-reversing	41
■ Starting playback	27	■ Skipping tracks forward	42
■ Stopping playback	27	■ Skipping tracks backward	42
■ Pausing	27	■ Repeat playback	43
■ Fast-forwarding	28	■ Random playback	43
■ Fast-reversing	28	■ Scan	44
■ Skipping chapters forward	29		

Initial Settings	45
Setting DVD/Audio/Subtitle Language	46
Setting the Angle Mark Display	47
Setting the Viewer Restriction Level	48
■ Password registration	49
Connecting External Devices to Your Rear Seat	
Entertainment System	50
Adjusting Display Conditions and Selecting Display	
Mode	51
Display Condition Adjustment	51
■ Adjusting method	51
Display Mode Selection	52
■ Selecting method	53
Error Messages	54
Language/Code List	55

Safety Warnings

You will find a number of WARNINGS, CAUTIONS and NOTES in this supplement.

These safety warnings alert you to potential hazards that could result in injury to you or others.

Please read these safety warnings as well as all other portions of this supplement carefully in order to gain a better understanding of how to use your Rear Seat Entertainment System safely.

WARNING

A WARNING indicates a situation in which serious injury or death could result if the warning is ignored.

CAUTION

A CAUTION indicates a situation in which injury or damage to your vehicle including the Rear Seat Entertainment System, or both, could result if the cautions is ignored.

NOTE

A NOTE gives information or suggestions how to make better use of your Rear Seat Entertainment System.

Before Use

WARNING

- Never try watching videos or using other entertainment programs with your Rear Seat Entertainment System by keeping the vehicle engine running in a garage or other enclosed area. Exhaust gases accumulated in such an area or entering the vehicle are dangerous, or even lethal.
- The driver must not attempt to operate or watch the Rear Seat Entertainment System while the vehicle is in motion. Doing so will distract attention from driving and the road, and could lead to an accident.
- The driver must not use headphones. Wearing headphones shuts out or drowns out outside sounds and reduces the driver's awareness of dangerous situations, which increases the risk of having an accident.
- If you wish to park your vehicle and enjoy an entertainment program on this system, select a safe place that does not hinder traffic and has no parking ban.

CAUTION

The display, a component of the Rear Seat Entertainment System, contains mercury. For that reason, it is necessary to remove display before vehicle disposal. Once removed, please reuse, recycle or dispose of the display as hazardous waste.

NOTE

- Using the Rear Seat Entertainment System with the engine stopped could lower the battery's electricity level. If the initial charge level were too low, the next engine starting would be impossible. It is recommended that the system be used only when the engine is running.
- The display screen turns off if you start the engine while using the Rear Seat Entertainment System with the ignition switch in the "ACC" or "ON" position and the engine not in operation. To turn on the display again, press the **"DVD • CD"** button on the remote control. The image will re-appear on the screen.
- Liquid-crystal displays may be difficult to read when wearing polarized glasses.

System Components

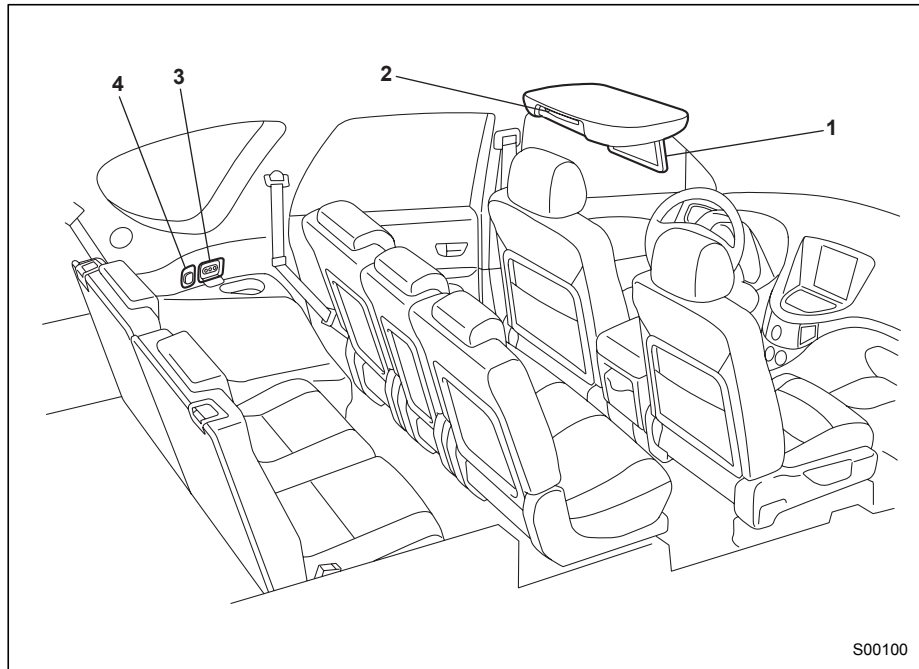

The Rear Seat Entertainment System consists of the following components:

- 1) Display (Refer to Page 7.)
- 2) DVD player (Refer to Page 22.)
- 3) External device jacks (Refer to Page 50.)
- 4) Accessory power outlet (Refer to Page 50.)

In addition to the components listed above, there is a remote control and two sets of wireless headphones as attachments to the system.

Basic Operations

What You Can Enjoy with Your Rear Seat Entertainment System

- The Rear Seat Entertainment System is designed to provide your vehicle's rear-seat passengers with video and music entertainment programs recorded on DVD video discs, video CDs and music CDs.
- The Rear Seat Entertainment System will operate when the ignition switch is in the "ACC" or "ON" position.
- Playback sounds can be listened to by using the wireless headphones accompanying the system.
- All operations with the Rear Seat Entertainment System can be managed using the remote control accompanying the system (except when ejecting a disc).
- Replacements of the dedicated headphones and remote control are available from your SUBARU dealer should you lose them.
- You can also enjoy TV games from a home-use TV game machine or video programs from a video tape player with the Rear Seat Entertainment System if such an external device is connected to one of the external device jacks of the system. For further details, refer to the instruction manual provided by the manufacturer of each external device.

NOTE

- **When the vehicle is parked with the parking brake applied and the selector lever in the "P" position, you can enjoy video programs on the navigation display on the dashboard if you press the "AUDIO" button on the navigation control panel. This does not apply when the vehicle is in motion.**
- **If you press the "AUX/RSE" button on the audio panel, playback sounds from this system will be outputted through the vehicle's speakers.**

Display

■ How to open and close the display

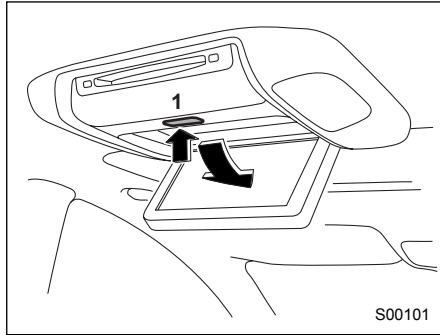

1) Release button

Push the release button to open the display.
The display will swing down partway along its full swing angle.

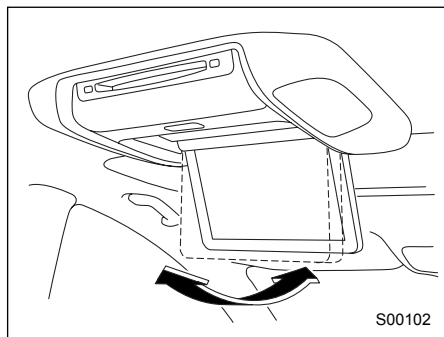

Adjust the display to the desired angle.

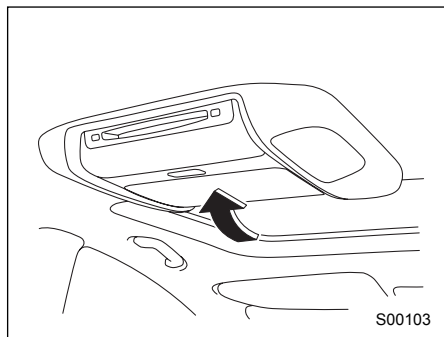

To close the display to its storage position, swing and push it up until it locks.

CAUTION

Close the display when it is not in use to help reduce the chance of injury in the event of an accident or sudden stop.

■ Keeping the display clean

Do not touch the display screen with bare hands. The display screen is easily soiled with hand grease.

Use a soft, dry cloth to clean the display screen surface. Do not use organic solvents.

The screen surface is sensitive to scratches or other physical damage. Avoid pushing on it strongly or rubbing it with a hard cloth or any other scratchy material.

NOTE

- **The screen is made of a liquid crystal display (LCD) panel. When the system is turned on in an extremely low outside temperature, the LCD takes a relatively long time to become bright. On the other hand, when the outside temperature is high, the LCD may become darker than usual. Both conditions are normal.**
- **Images on an LCD screen may contain some tiny black spots and/or bright spots. They reflect a characteristic normal to the LCD and do not indicate any abnormal condition.**

Remote Control

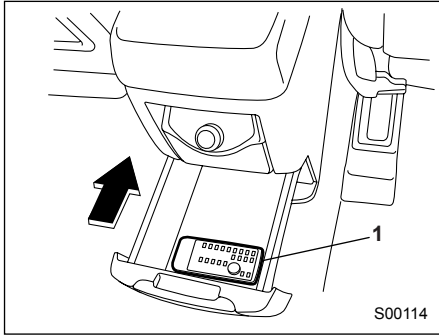

1) Remote control

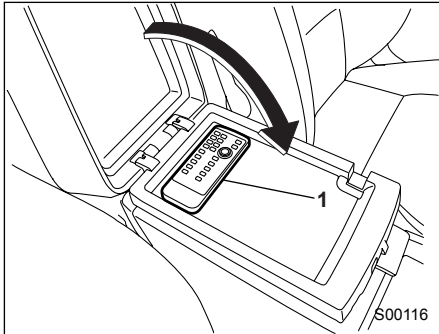

1) Remote control

The Rear Seat Entertainment System can be operated only using the remote control (except when ejecting a disc). Touching a switch on the display screen directly with your finger does not have any effect.

CAUTION

- Store the remote control in the center or rear console box when the Rear Seat Entertainment System is not being used to reduce the chance of injury in case of an accident or sudden stop.
- Be sure to keep the rear console box as well as the upper compartment of the center console box closed to reduce the chance of injury in case of an accident or sudden stop.
- Do not disassemble or modify the remote control. Doing so could cause an accident, fire or electric shock.
- Do not expose the remote control to direct sunlight, strong heat and/or a highly humid environment. The remote control case could become deformed and the battery in it could leak or even explode if exposed to these conditions.
- Avoid dropping the remote control and hitting it against hard objects.
- Do not sit or step on the remote control. Placing anything heavy on it should also be avoided.
- Avoid pressing the remote control buttons for longer than necessary, as the battery is consumed while any button is kept pressed. Also avoid placing an object on the remote control, as it may press buttons and reduce the battery life.

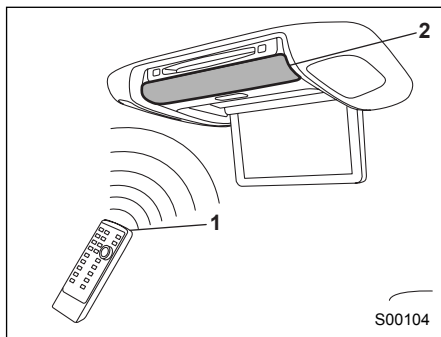

To use the remote control, direct its signal-emitting eye toward the signal reception window of the display.

- 1) Signal emitting eye
- 2) Signal reception window

■ Control buttons and joystick

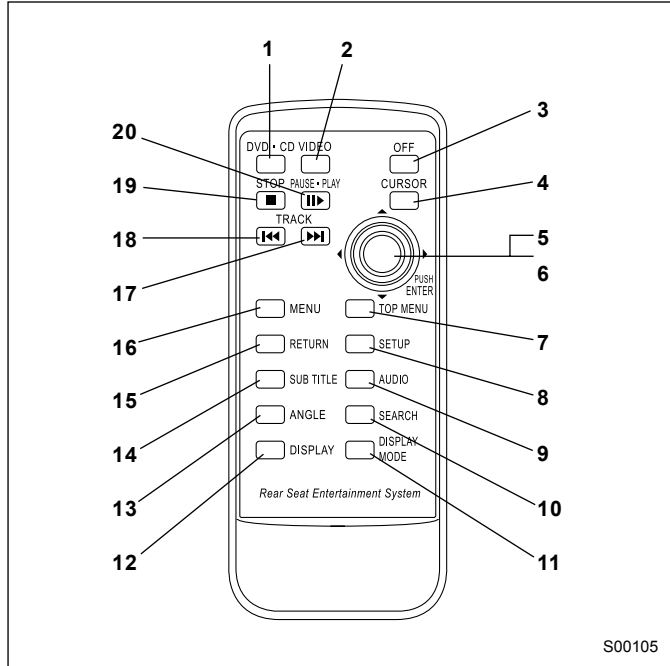

S00105

- 1) **DVD • CD button**
When this button is pressed, the Rear Seat Entertainment System turns on. The display will show DVD mode or CD mode.
- 2) **VIDEO button**
When this button is pressed, the system will accept and operate on the video signal from an external video device connected to the system.
- 3) **OFF button**
When this button is pressed, the Rear Seat Entertainment System turns off.
- 4) **CURSOR button**
When this button is pressed, control switches will appear on the display when the player is in operation.
- 5) **Joystick**
The joystick is used to highlight a control switch or a menu item on the screen and also to make an entry. Click an appropriate one of its four arrow-marked ends (▲, ▶, ▼ and ◀) to use it.
- 6) **ENTER button**
When this button is pressed, the system will execute a selection or entry that was made with the joystick.
- 7) **TOP MENU button**
When this button is pressed, the title selection screen for the DVD video disc currently in the player will appear on the display.
- 8) **SETUP button**
When this button is pressed, the initial setup screen will appear on the display, where you can make your initial settings.

- 9) AUDIO button
When this button is pressed, the desired audio language or MAIN/SUB sound channel can be selected when the player is in operation.
- 10) SEARCH button
When this button is pressed, the title search screen will appear on the display when the player is in operation. You can then start playback beginning with the title you have selected on the screen.
- 11) DISPLAY MODE button
When pressed, this button allows you to select the screen size.
- 12) DISPLAY button
When this button is pressed, the display condition adjustment screen will appear, where you can adjust the brightness, contrast, color and tone for images.
- 13) ANGLE button
When this button is pressed, the angle selection screen will appear, where you can select a desired angle when the player is reproducing a multi-angle recorded DVD video disc.
- 14) SUBTITLE button
When this button is pressed, the subtitle language selection screen will appear, where you can select a desired subtitle language when the player is playing a DVD video disc.
- 15) RETURN button
When this button is pressed, the disc will skip to a predetermined screen.
- 16) MENU button
When this button is pressed, the menu screen will appear for the DVD video disc currently in the player.
- 17) TRACK (▶▶) button
Each brief push (less than 1 second) of this button during operation of the player advances the video scene chapter by chapter. If you push the button continuously, the scene advances continuously and quickly (but slowly when playback is in pause mode) until you release the button.
- 18) TRACK (◀◀) button
Each brief push (less than 1 second) of this button during operation of the player reverses the video scene chapter by chapter. If you push the button continuously, the scene reverses continuously and quickly (but slowly when playback is in pause mode) until you release the button.
- 19) STOP (■) button
This button stops playback when it is pressed during operation of the player.
- 20) PAUSE • PLAY (⏸▶) button
Pressing this button pauses playback when the player is in operation. Pressing it again restarts playback.

■ How to use the remote control

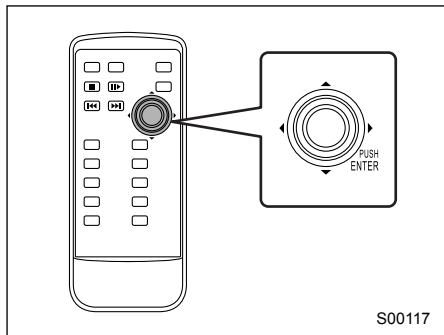

You can control the operation of the DVD player using the buttons on the remote control.

You can also control the player using the joystick on the remote control to highlight a switch on the display screen and then pressing the "ENTER" button. You cannot, however, control the player by touching a switch on the screen with your finger. When a switch is selected with the joystick, the color of the switch changes from blue to white. When you then press the "ENTER" button, your selection is executed.

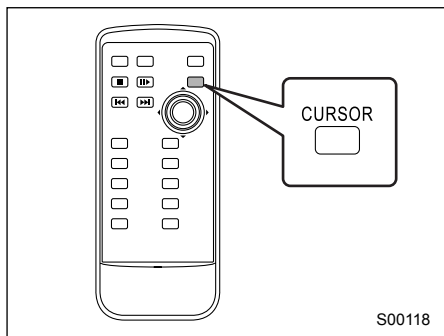

To make control switches appear on the screen when playing a DVD video disc or video CD:

You can use the "CURSOR" button on the remote control to make the control switches appear on the screen. The control switches shown on the next page will be displayed when the button is pressed.

To make control switches appear on the screen when playing a music CD:

When a music disc is loaded in the player, playback will start automatically and the control switches shown on the next page will appear on the screen without the need for operating the remote control.

DVD Video Menu 1

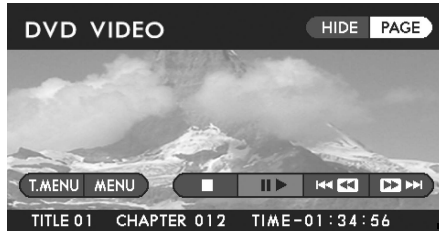

DVD Video Menu 2

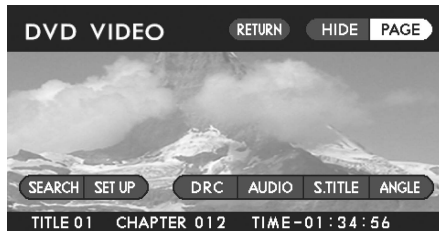

When playing a DVD video disc, different control switches are displayed on the screens for Menu 1 and Menu 2 (Menu 1 screen appears first when the “CURSOR” button is pressed). Switch between the two screens when necessary by highlighting the “PAGE” switch on the screen with the joystick and then pressing the “ENTER” button.

To make the switches disappear from the

screen, push the remote control’s “CURSOR” button again or highlight the “HIDE” switch on the screen with the joystick and then press the “ENTER” button. If you highlight and execute the “HIDE” switch, the TITLE number, CHAPTER number and playback time at the bottom of the screen also disappear.

Video CD Menu



To make the switches disappear from the screen, push the remote control’s “CURSOR” button again or highlight the “HIDE” switch on the screen with the joystick and then press the “ENTER” button. If you highlight and execute the “HIDE” switch, the TRACK number and playback time at the bottom of the screen also disappear.

NOTE

The “RETURN” switch is displayed on

the VIDEO CD menu only when you play a video CD version 2.0.

Music CD Menu

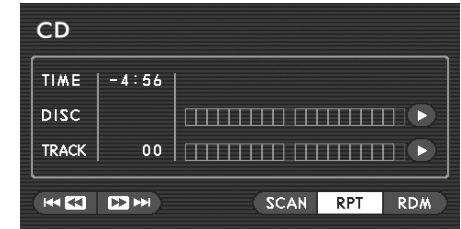

NOTE



If the “⊘” mark appears on the screen when you select a control switch, it will not be possible to select or execute the switch.

■ Replacing the battery

⚠ WARNING

Take great care not to allow children to swallow batteries or any other removed part, as these could cause serious injury or death if swallowed.

⚠ CAUTION

Do not let dust, oil or water get on or in the remote control when replacing the battery.

When the battery begins to get weak, the signal transmission range of the remote control becomes shorter. If this is the case, replace the battery as soon as possible.

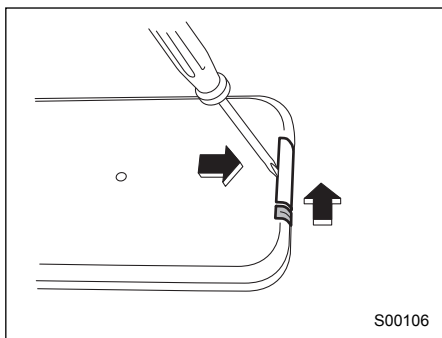

While holding the battery holder pushed in the direction of the arrow with your fingernail inserted in the slot, slide out the holder in the direction of the arrow using a cross-head mini screwdriver.

Remove the battery from the holder.

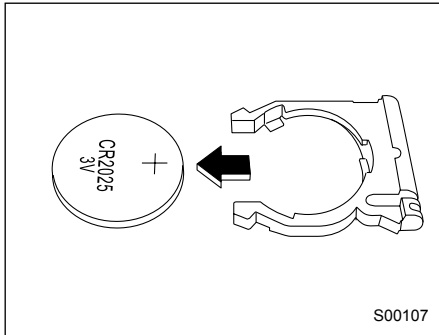

Install a new battery (Type CR2025 or equivalent) in the holder. Make sure the battery's positive (+) side and the "+" mark on the holder are on the same side. Slide the battery holder into the remote control until it clicks.

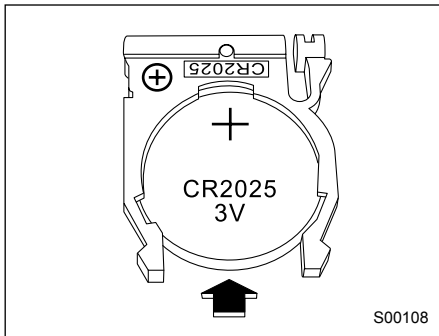

Wireless Headphones

Use the wireless headphones to listen to audio outputted from your Rear Seat Entertainment System.

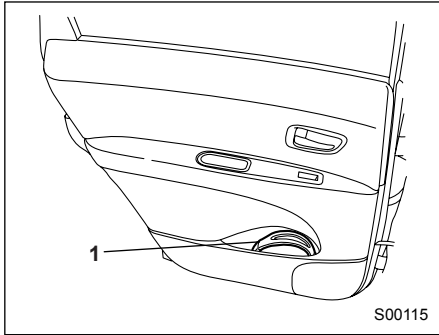

1) Wireless headphone

CAUTION

- Store the headphones in a door pocket when they are not being used in order to reduce the chance of injury in case of an accident or sudden stop.
- Do not disassemble or modify the headphones. Doing so could cause an accident, fire or electric shock.
- Do not expose the headphones to direct sunlight, strong heat and/or a highly humid environment. The headphones could become deformed and the batteries in them could leak or even explode under these conditions.
- Avoid dropping the headphones and hitting them against hard objects.
- Do not sit on the headphones or place anything heavy on them.
- Human voices may have been recorded intentionally at low levels in some DVDs for special acoustic effects. If you carelessly adjust the volume in order to hear these voices more clearly, your ears may be exposed to unexpectedly loud sounds at a later point. This may also happen when you switch to a different audio source. Very loud sounds could damage your hearing and pose a driving hazard. Keep this in mind when you adjust the volume.

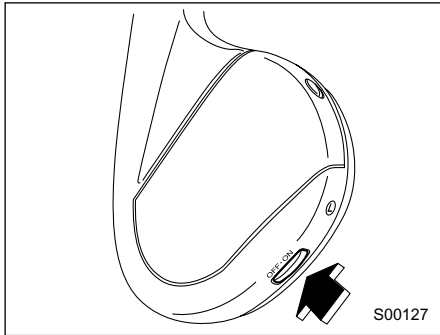

Press the “OFF • ON” button on the left earpiece to turn on the headphones: the power lamp on the right earpiece will come on.

Sentence has been changed according to the power lamp has been removed from left earpiece to right earpiece.

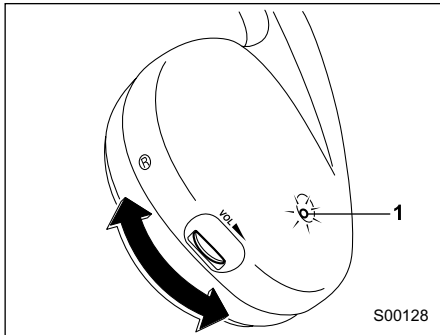

Adjust the sound level as desired with the volume dial on the right earpiece.

Graphics have been changed. Because the headphone has been changed to new ones.

1) Power lamp

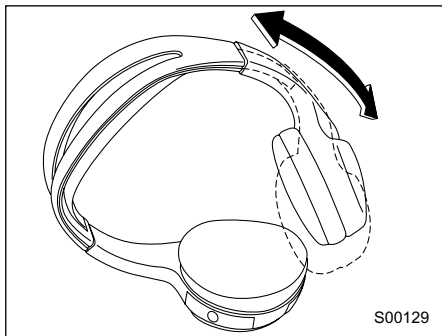

Adjust the earpieces to comfortable positions by extending or retracting the headband.

NOTE

For longer battery life, turn off the headphones whenever they are not being used. Press the **“OFF • ON”** button to turn off the headphones and make sure the **power** lamp has gone out.

■ Replacing the batteries

⚠ WARNING

Take great care not to allow children to swallow batteries or any other removed part, as these could cause serious injury or death if swallowed.

⚠ CAUTION

Do not let dust, oil or water get on or in the headphones when replacing the batteries.

When the batteries begin to get weak, the **power** lamp will not come on even if you press the **“OFF • ON”** button. If this is the case, replace the batteries as soon as possible.

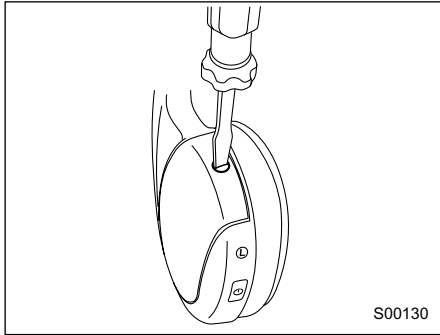

Remove the battery cover on the left earpiece by loosening the screw with a flat-head screwdriver.

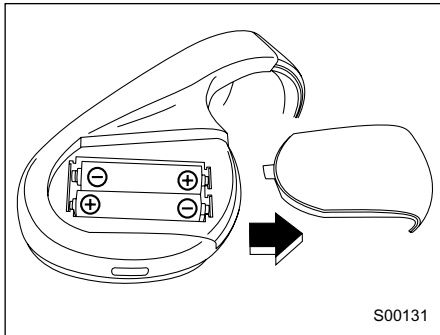

Remove the old batteries and install new ones (two AAA batteries). Pay careful attention to the (+) and (-) marks on the battery case. Reinstall the cover in position by tightening the screw with a flat-head screwdriver.

DVD Player

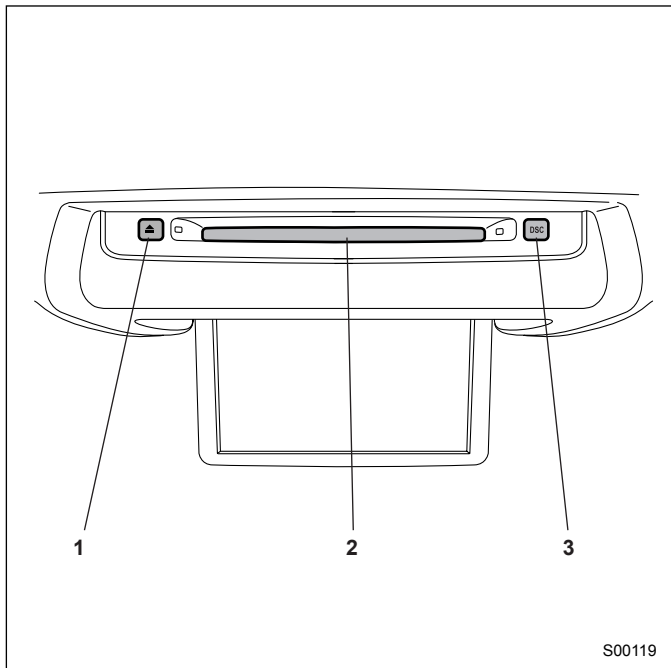

The DVD player can be operated when the ignition switch is in the “ACC” or “ON” position. Load a disc by inserting it into the disc slot of the player, with the label side facing up. The disc will be carried inward automatically when you insert it partially. The disc indicator light will turn on when the disc reaches the full inward position. To eject the disc, press the “Eject (▲)” button. The disc will come out and the indicator light will go out.

- 1) Eject button
- 2) Disc slot
- 3) Disc indicator light



Precautions to Observe When Handling Discs

Types of Discs Playable with the Rear Seat Entertainment System

Your Rear Seat Entertainment System can play back music CDs, DVD video discs and video CDs that have any of the marks indicated below.

NOTE

- The system is not compatible with DVD audio discs and MP3-file or WAV-file based music CDs.
- The system does not support 8-cm/3-inch CDs; if inserted, they will automatically be ejected.

Music CDs	
DVD video discs	
Video CDs	

The following products may not play back on the Rear Seat Entertainment System.

SACD
CCCD
Dual disc
CD-R
CD-RW
CD-ROM
DVD-R
DVD+R
DVD-RW
DVD+RW
DVD-ROM
DVD-RAM

When handling discs, follow these precautions:

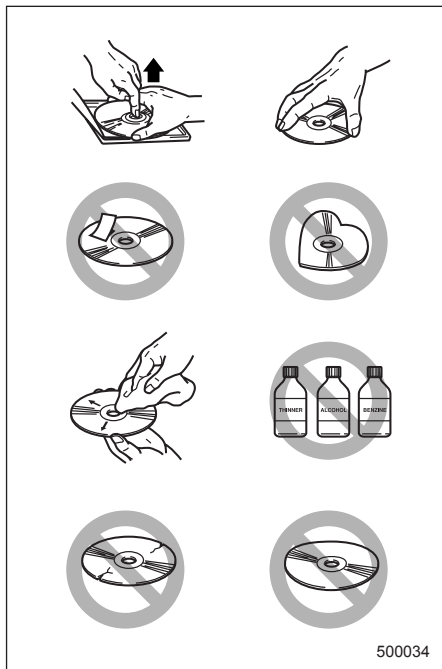







- In cold and/or rainy weather, condensation can form inside the DVD player, preventing normal operation. If this happens, eject the disc and wait for the player to dry out.
- Skipping may occur when the DVD player is subjected to severe vibration (for example, when the vehicle is driven on a rough surface).
- To remove a disc from its case, press the center of the case and hold both edges of the disc. If the disc surface is touched directly, contamination could cause poor image or sound quality. Do not touch the disc surface.
- Use a clean disc whenever possible. If there are any deposits, wipe the disc surface from the center outward with a dry, soft cloth. Be sure not to use a hard cloth, thinner, benzene, alcohol, etc.
- Do not use any disc that is scratched, deformed, transparent/semi-transparent, glue-labeled, or cracked. Also, do not use any disc that has a non-standard shape (for example, a heart shape) or 8-cm/3-inch CDs. Malfunctions or other problems might result.
- Discs are vulnerable to heat. Never keep discs in places exposed to direct sunlight, near heaters or in vehicles parked in the sun or on hot days.

■ DVD video discs

The DVD player of your Rear Seat Entertainment System can play back DVD video discs that conform to NTSC color TV formats. Any DVD video discs produced conforming to other formats such as PAL or SECAM cannot be used with the player.

The following are example logos that may be indicated on DVD video discs and what they mean:

	The disc conforms to NTSC format of color TV.
	The disc has two audio tracks.
	The disc's subtitles are available in two languages.
	The disc's multi-angle recorded scenes are viewable from three different angles.
	Two screen aspect ratios (ratio of width to height) are selectable: wide screen of 16:9 and standard screen of 4:3.
	Region code indicating the area in which this video disc can be played. "ALL" stands for all countries; "1" stands for the United States and Canada.

NOTE

Some DVD video discs have a region code, each indicating where it can be used. If a disc is not labeled "ALL" or "1", you cannot use it in your system's DVD player. If you attempt to play it in the player, a "REGION CODE ERROR" message will appear on the screen. Some DVD video discs without any region code may not be usable with your system's DVD player.

■ Copyright

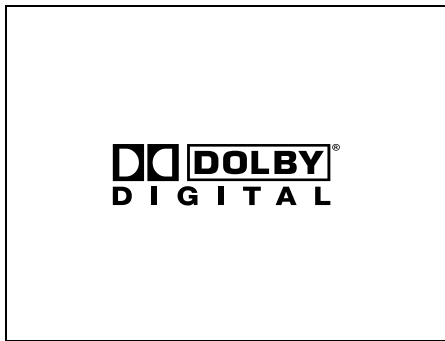

The Dolby system is manufactured under license from Dolby Laboratories.

Dolby, DOLBY, and the double-D symbol are trademarks of Dolby Laboratories.

The Rear Seat Entertainment System incorporates copyright protection technology that is covered by method claims of certain U.S. patents and other intellectual property rights owned by Macrovision Corporation and other rights owners. Use of this copyright protection technology must be authorized by Macrovision Corporation, and is intended for home and other limited viewing uses only, unless otherwise authorized by Macrovision Corporation. Reverse engineering and modification is prohibited.



"dts" is a trademark of Digital Theater Systems, Inc.

Playing Discs

Playing DVD Video Discs

■ Starting playback

With the vehicle's ignition switch in the "ACC" or "ON" position, insert the disc into the disc slot of the DVD player, with the label side facing up. The player automatically starts playback of the disc.

If a disc is already in the player, press the "DVD • CD" button on your remote control to start playback.

■ Stopping playback

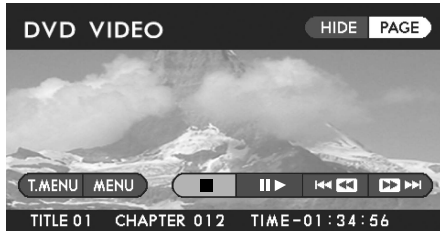

Method using screen and remote control:

Highlight the "■" switch on the screen with your remote control joystick, then press the "ENTER" button.

Method using remote control alone:

Press the remote control "STOP (■)" button.

■ Pausing

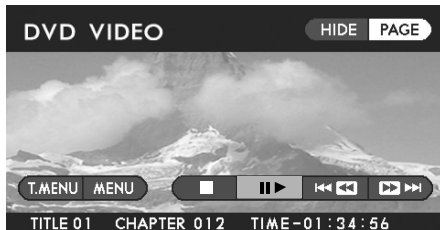

Method using screen and remote control:

Highlight the "||" switch on the screen with the remote control joystick, then press the "ENTER" button.

Method using remote control alone:

Press the remote control "PAUSE • PLAY (||)" button.

To restart playback, perform either of the above operations again.

■ Fast-forwarding

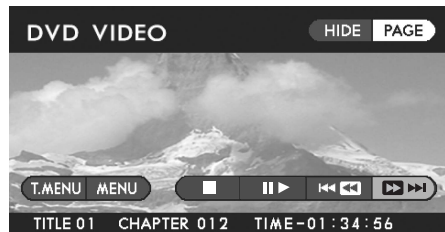

Method using screen and remote control:

Highlight the “▶▶▶▶” switch on the screen with the remote control joystick, then press the “ENTER” button continuously until reaching the desired scene.

Method using remote control alone:

Press the remote control “TRACK (▶▶)” button continuously until reaching the desired scene.

When you perform either of the above operations while the player is in pause mode, the disc will advance slowly.

■ Fast-reversing

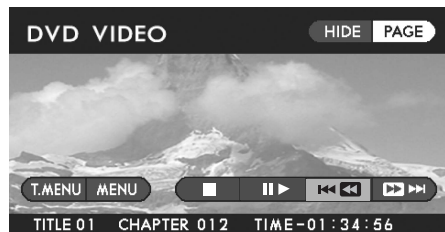

Method using screen and remote control:

Highlight the “◀◀◀◀” switch on the screen with the remote control joystick, then press the “ENTER” button continuously until reaching the desired scene.

Method using remote control alone:

Press the remote control “TRACK (◀◀)” button continuously until reaching the desired scene.

When you perform either of the above operations while the player is in pause mode, the disc will reverse slowly.

■ Skipping chapters forward

The data recorded on DVD video discs is divided into fragments called “titles”, and each title is further divided into smaller fragments called “chapters”. These titles and chapters are given specific numbers, which are indicated in the guide accompanying each disc. You can skip chapter(s) using the following procedure:

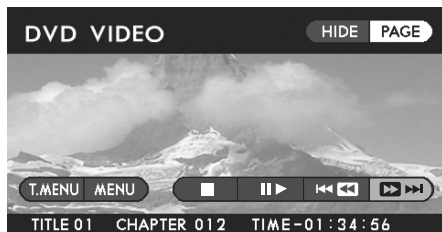

Method using screen and remote control:

Highlight the “▶▶▶▶” switch on the screen with the remote control joystick, then briefly press the “ENTER” button. The disc skips the current chapter and advances to the beginning of the next chapter. Repeat this operation as many times as necessary to reach the desired chapter.

Method using remote control alone:

Briefly press the remote control “TRACK (▶▶)” button. Refer to the above for the subsequent process and operation.

■ Skipping chapters backward

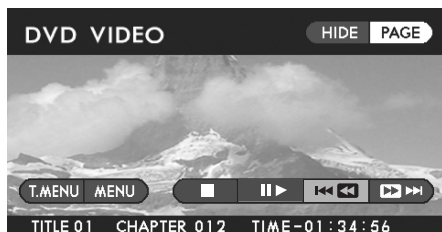

Method using screen and remote control:

Highlight the “◀◀◀◀” switch on the screen with the remote control joystick, then briefly press the “ENTER” button. The disc reverses to the beginning of the current chapter. If you briefly press the button again, the disc reverses to the beginning of the preceding chapter. Repeat this operation as many times as necessary to reach the desired chapter.

Method using remote control alone:

Briefly press the remote control “TRACK (◀◀)” button. Refer to the above for the subsequent process and operation.

■ Title search

If you enter a desired title number using the remote control joystick, the disc is played back beginning with the specified title. The number of titles differs from disc to disc. Refer to the guide attached to each disc for its title numbers.

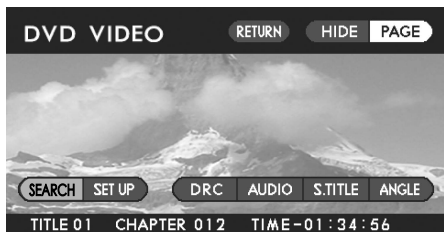

Method using screen and remote control:

Highlight the "SEARCH" switch on the screen with the remote control joystick, then press the "ENTER" button. The display switches to the title number entry screen.



Enter the title number using the remote control joystick, then press the "ENTER" button. The player will play back the disc beginning with the specified title. To revert to the original video screen, highlight the "5" switch with the joystick, and then press the "ENTER" button.

Method using remote control alone:

Press the remote control "SEARCH" button. Refer to the above for the subsequent process and operation.

■ Skipping to a predetermined screen

You can start playing a disc beginning with a registered predetermined screen. Some discs may not be compatible with this function. For the predetermined screen of each disc, refer to the guide accompanying it.

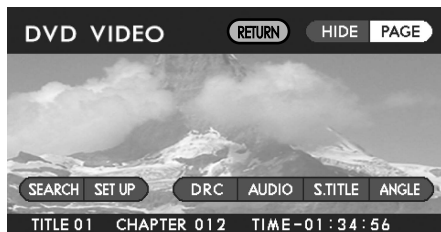

Method using screen and remote control:

Highlight the "RETURN" switch on the screen with the remote control joystick, then press the "ENTER" button. Playback will start at the predetermined screen.

Method using remote control alone:

Press the "RETURN" button on the remote control. Playback will start at the predetermined screen.

■ Displaying each disc's menu on the screen

You can display the menu stored in the disc.

Menus and their contents differ from disc to disc. After displaying a menu using the method below, follow the indications that each disc will show on its screen. Some discs may not allow you to select the top menu. For further details, please refer to the guide accompanying each disc.

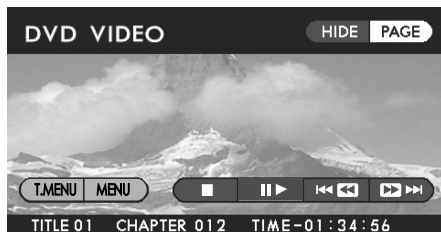

Method using screen and remote control:

With the remote control joystick, highlight the "T. MENU" switch on the screen when displaying the top menu, or the "MENU" switch when displaying other menus. Then press the remote control "ENTER" button. The top menu or other menu will appear on the screen.

Method using the remote control alone:

Press the "TOP MENU" button to display the top menu, or the "MENU" button to display other menus.

■ Changing the audio language

You can select a desired audio language from those available with the disc currently loaded in the player.

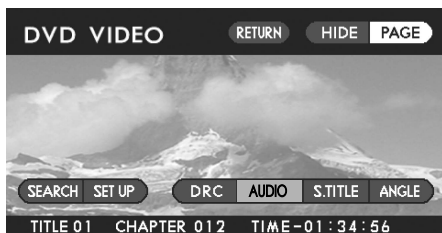

Method using screen and remote control:

Highlight the "AUDIO" switch on the screen with the remote control joystick, then press the "ENTER" button. The display will switch to the audio language selection screen.

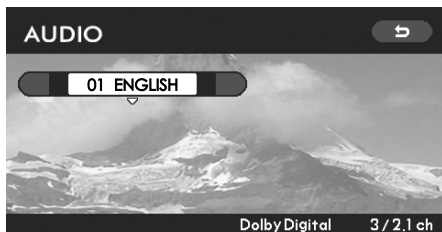

Click the "▼" end of the remote control joystick to highlight the desired language on the screen and then press the "ENTER" button. To revert to the original video screen, highlight the "↩" switch with the joystick, and then press the "ENTER" button.

Method using remote control alone:

Press the remote control "AUDIO" button. Refer to the above for the subsequent operation.

■ Changing the subtitle language

You can select a desired subtitle language from those available with the disc currently in the player.

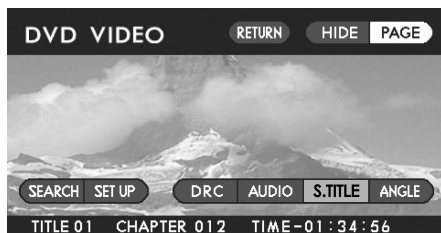

Method using screen and remote control:

Highlight the “S. TITLE” switch on the screen with the remote control joystick, then press the “ENTER” button. The display will switch to the subtitle language selection screen.

Click the “▼” end of the remote control joystick to highlight the desired language on the screen, then press the “ENTER” button. To revert to the original video screen, highlight the “↩” switch with the joystick, and then press the “ENTER” button.

Method using remote control alone:

Press the “**SUBTITLE**” button on the remote control. Refer to the above for the subsequent operation.

NOTE

If you select “OFF” in the above operation, no subtitle is displayed on the screen.

■ Image angle selection on multi-angle recorded scenes

If you play back a DVD video disc containing scenes recorded using the multi-angle technology, you can enjoy viewing them from different angles. For example, you can view the image of the same mountain from both the right and left sides. Some discs may not be compatible with this function.

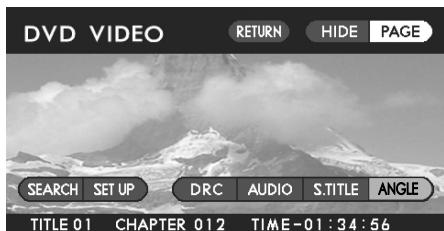

Method using screen and remote control:

Highlight the "ANGLE" switch on the screen with the remote control joystick, then press the "ENTER" button. The display will switch to the angle selection screen.



Click the "▼" end of the remote control joystick to highlight the desired angle on the screen, then press the "ENTER" button. To revert to the original video screen, highlight the "↵" switch with the joystick, and then press the "ENTER" button.

Method using remote control alone:

Press the "ANGLE" button on the remote control. Refer to the above for the subsequent operation.

NOTE

- The default setting is "01" for all multi-angle recorded scenes.
- You may have to wait a short while for the change in angle to take place.
- You can make multi-angle scenes identifiable with the angle mark shown on the display screen. For details of the method, refer to Page 47.

■ Selecting a dynamic range control setting

You can reduce (or compress) the difference between the maximum and minimum sound levels for your listening comfort during playback of a disc. There are three settings available, each having a different level of compression. If you select the “MAX” setting, the dynamic range control lowers the maximum sound level while raising the minimum sound level. This makes the audio sounds gentler to your ears.

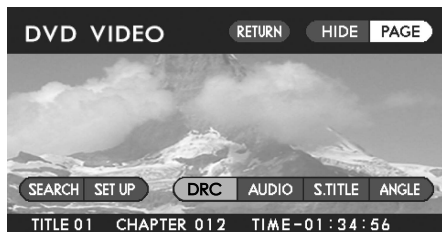

Highlight the “DRC” switch on the screen with the remote control joystick, then press the “ENTER” button. The display will switch to the dynamic range control selection screen.



Click the “▼” end of the remote control joystick. Each time it is clicked, the setting changes in the following sequence:

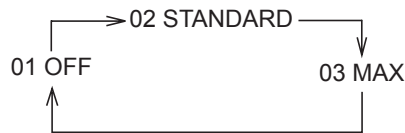

NOTE

The default setting of the dynamic range control is “02 STANDARD”.

With the desired setting selected, press the “ENTER” button. To revert to the original video screen, highlight the “➔” switch with the joystick, and then press the “ENTER” button.

Playing Video CDs

■ Starting playback

With the ignition switch in the “ACC” or “ON” position, insert the CD into the disc slot of the DVD player, with the label side facing up. The player automatically starts playing the disc.

If a disc is already in the player, press the remote control “DVD • CD” button on your remote control to start playback.

■ Stopping playback



Method using screen and remote control:

Highlight the “■” switch on the screen with the remote control joystick, then press the “ENTER” button.

Method using remote control alone:

Press the remote control “STOP (■)” button.

■ Pausing



Method using screen and remote control:

Highlight the “||▶” switch on the screen with the remote control joystick, then press the “ENTER” button.

Method using remote control alone:

Press the remote control “PAUSE • PLAY (||▶)” button.

To restart playback, perform either of the above operations again.

■ Fast-forwarding



Method using screen and remote control:

Highlight the “▶▶▶▶” switch on the screen with the remote control joystick, then press the “ENTER” button continuously until reaching the desired scene.

Method using remote control alone:

Press the remote control “TRACK (▶▶)” button continuously until reaching the desired scene.

When you perform either of the above operations while the player is in pause mode, the disc advances slowly.

■ Fast-reversing



Method using screen and remote control:

Highlight the “◀◀◀◀” switch on the screen with the remote control joystick, then press the “ENTER” button continuously until reaching the desired scene.

Method using remote control alone:

Press the remote control “TRACK (◀◀)” button continuously until reaching the desired scene.

■ Skipping tracks forward

The data recorded on video CDs is divided into fragments called “tracks”. These tracks are given specific numbers, which are indicated in the guide accompanying each disc. You can advance the disc skipping a track or tracks as follows:



Method using screen and remote control:

Highlight the “▶▶▶▶” switch on the screen with the remote control joystick, then briefly press the “ENTER” button. The disc skips the current track and advances to the beginning of the next track. Repeat this operation as many times as necessary to reach the desired track.

Method using remote control alone:

Briefly press the remote control “TRACK (▶▶)” button. Refer to the above for the subsequent process and operation.

NOTE (Ver 2.0 video CD only)

Track skipping is not possible with some Ver 2.0 video CDs. For information on track skipping of each Ver 2.0 video CD, refer to the guide accompanying it.

■ Skipping tracks backward



Method using screen and remote control:

Highlight the “⏮⏮⏮⏮” switch on the screen with the remote control joystick, then briefly press the “ENTER” button. The disc reverses to the beginning of the current track. If you briefly press the button again, the disc reverses to the beginning of the preceding track. Repeat this operation as many times as necessary to reach the desired track.

Method using remote control alone:

Briefly press the remote control “TRACK (⏮⏮)” button. Refer to the above for the subsequent process and operation.

NOTE (Ver 2.0 video CD only)

Track skipping is not possible with some Ver 2.0 video CDs. For information on track skipping of each Ver 2.0 video CD, refer to the guide accompanying it.

■ Skipping to a predetermined screen (Ver 2.0 video CD only)

You can start playing a disc beginning with a registered predetermined screen. Some discs may not be compatible with this function. For the predetermined screen of each disc, refer to the guide accompanying it.



Method using screen and remote control:

Highlight the “RETURN” switch on the screen with the remote control joystick, then press the “ENTER” button. Playback will start at the predetermined screen.

Method using remote control only:

Press the “RETURN” button on the remote control. Playback will start at the predetermined screen.

■ Sound channel (MAIN/SUB) selection



Highlight the "AUDIO" switch on the screen with the remote control joystick, then press the "ENTER" button once or as many times as necessary to select the desired sound channel. Each time you press the "ENTER" button, the sound channel will change in the following sequence:

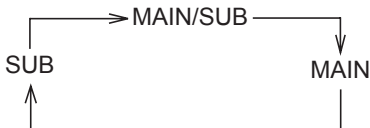

NOTE

The default sound channel setting is "MAIN/SUB".

Playing Music CDs

■ Starting playback

With the ignition switch in the "ACC" or "ON" position, insert the CD into the disc slot of the DVD player, with the label surface facing up. The player automatically starts playing the disc.

If a disc is already in the player, press the remote control "DVD • CD" button on your remote control to start playback.

■ Stopping playback

To stop playback of a music CD, perform the following:

- Press the remote control "OFF" button.
- Press the "Eject (▲)" button on the DVD player.

■ Fast-forwarding

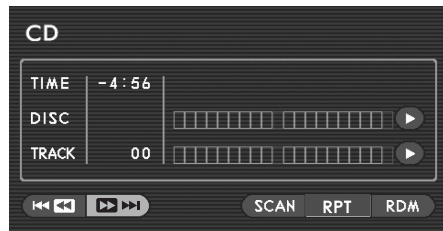

Method using screen and remote control:

Highlight the “▶▶▶▶” switch on the screen with the remote control joystick, then press the “ENTER” button continuously.

Method using remote control alone:

Press the remote control “TRACK (▶▶)” button continuously.

■ Fast-reversing

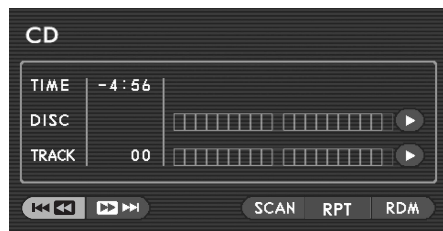

Method using screen and remote control:

Highlight the “◀◀◀◀” switch on the screen with the remote control joystick, then press the “ENTER” button continuously.

Method using remote control alone:

Press the remote control “TRACK (◀◀)” button continuously.

■ Skipping tracks forward

You can advance the disc skipping one or more tracks as follows:

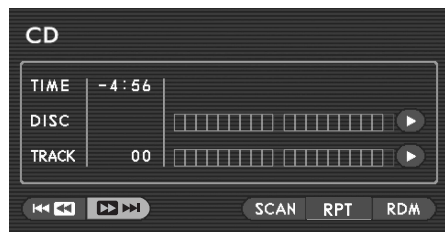

Method using screen and remote control:

Highlight the "▶▶▶▶" switch on the screen with the remote control joystick, then briefly press the "ENTER" button. The disc skips the current track and advances to the beginning of the next track. Repeat this operation as many times as necessary to reach the desired track.

Method using remote control alone:

Briefly press the remote control "TRACK (▶▶)" button. Refer to the above for the subsequent process and operation.

■ Skipping tracks backward

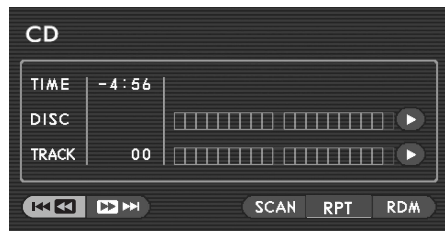

Method using screen and remote control:

Highlight the "◀◀◀◀" switch on the screen with the remote control joystick, then press the "ENTER" button. The disc reverses to the beginning of the current track. If you briefly press the button again, the disc reverses to the beginning of the preceding track. Repeat this operation as many times as necessary to reach the desired track.

Method using remote control alone:

Briefly press the remote control "TRACK (◀◀)" button. Refer to the above for the subsequent process and operation.

■ Repeat playback

If you want to listen to the currently playing track again, perform the following:

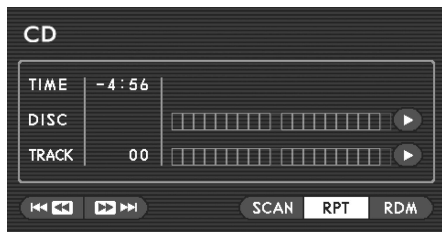

Highlight the “RTP” switch on the screen with the remote control joystick, then press the “ENTER” button.

The repeat-play mode will be cancelled if you press the “ENTER” button again.

■ Random playback

You can play all of the tracks on the disc currently in the player in a random order by doing the following:

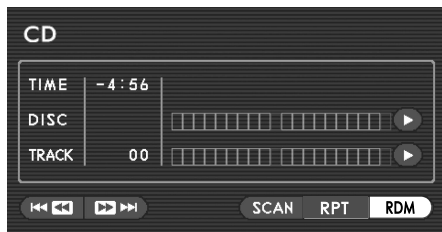

Highlight the “RDM” switch on the screen with the remote control joystick, then press the “ENTER” button.

The random playback will be cancelled if you press the “ENTER” button again.

■ Scan

The scan mode lets you listen to the first 10 seconds of each track on the disc in succession. Do the following to scan-play the disc:

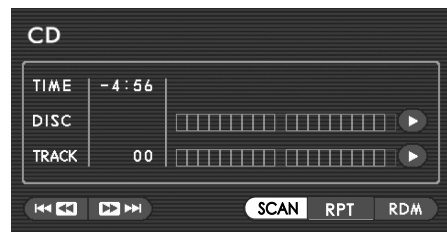

Highlight the “SCAN” switch on the screen with the remote control joystick, then press the “ENTER” button.

The scan mode will be cancelled if you press the “ENTER” button again.

Initial Settings

We recommend that you make these initial settings before enjoying DVD video discs with your Rear Seat Entertainment System in order to eliminate the inconvenience of making selections and settings each time you play a disc.

- DVD language (ENGLISH)
- Audio language (ENGLISH)
- Subtitle language (ENGLISH)
- Angle mark (ON)
- Viewer restriction level (8)
- Password

NOTE

- **The settings shown in () above are default settings made before shipment from the factory. When you highlight the “DEFAULT” switch on the “SETUP MENU” screen with the remote control joystick and then press the “ENTER” button, all settings return to the default settings.**
- **Some discs already contain audio language and other settings. These settings take priority over your settings.**
- **If the vehicle’s power supply is interrupted due to, for example, disconnection of the battery or a blown fuse, all your settings will be cancelled and the system will revert to the factory settings. If this happens, make your settings again.**

Perform these settings from the SETUP MENU screen on the display. To access the SETUP MENU screen, do the following:



Method using screen and remote control:

Highlight the “SET UP” switch on the screen with the remote control joystick, then press the “ENTER” button. The display will switch to the SETUP MENU screen.

Method using remote control alone:

Press the remote control “SETUP” button.

Setting DVD/Audio/Subtitle Language

The following languages are available for setting:

- ENGLISH
- FRENCH
- SPANISH
- GERMAN
- ITALIAN
- DUTCH
- JAPANESE
- OTHERS



On the SETUP MENU screen, highlight a language mode (DVD, Audio, or Subtitle mode) for which you wish to set a language using the remote control joystick and then press the “ENTER” button. Once the language mode has been selected, you can now set the desired language by highlighting it with the joystick and then pressing the “ENTER” button. The switch color of the set language changes from white to gray.

Do the same for the remaining language modes.

To revert to the SETUP MENU screen, highlight the “↩” switch with the joystick, and then press the “ENTER” button.

* This figure shows the screen for setting the audio language.

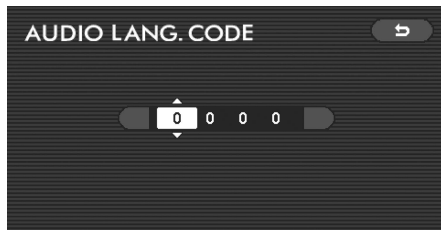

* This figure shows the screen for setting the audio language.

Setting the Angle Mark Display



Angle mark

If you wish to set a language not included in the list of languages that appears on the SETUP MENU screen, highlight "OTHERS" in the second step above and enter the code of the desired language (refer to the language code list on Page 55) using the joystick. After entering the code, press the "ENTER" button. To revert to the SETUP MENU screen, highlight the "↩" switch with the joystick, and then press the "ENTER" button.



On the SETUP MENU screen, highlight “ANGLE MARK” with the remote control joystick, followed by pressing the “ENTER” button. Then, the angle mark display switches between “ON” and “OFF” each time the “ENTER” button is pressed. Select either “ON” or “OFF” as desired.

NOTE

- Image angle selection is not possible for DVD video discs that do not contain multi-angle recorded scenes.
- You can enjoy multi-angle recorded scenes by changing their angle even when “OFF” is set for the angle mark display.

Setting the Viewer Restriction Level

If you make this setting, certain scenes contained in the DVD video disc in the player are prevented from appearing on the screen. The highest restriction level is 1 and the lowest is 8.

NOTE

This setting is not effective for discs without a pre-programmed viewer restriction feature.

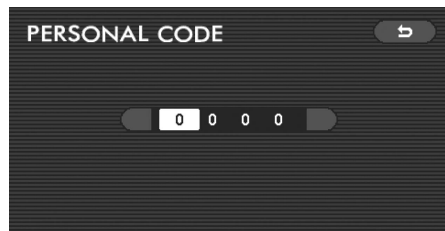

With an appropriate DVD video disc loaded in the player, access the SETUP MENU screen. Highlight “PARENTAL LOCK” with the remote control joystick, then press the “ENTER” button. The display will change to the “PERSONAL CODE” screen.

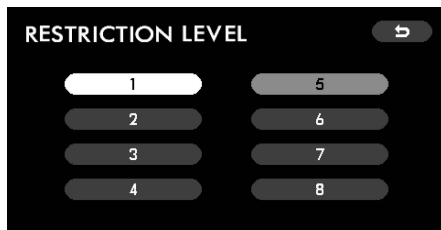

■ Password registration

Use this method to register your password, which is necessary when setting the viewer restriction level.

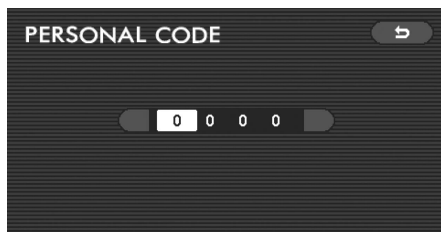

Enter your four-digit password using the joystick, then press the “ENTER” button. The display will change to the “RESTRICTION LEVEL” screen.

Select a restriction level number (1 – 8) with the joystick, then press the “ENTER” button. The switch color of the set number changes from white to gray.

To return to the SETUP MENU screen, highlight the “” switch with the joystick, and then press the “ENTER” button.

NOTE

- No default has been set for the password. The “PERSONAL CODE” screen will show “- - - -”. Register your password as instructed in “Password registration” below.
- Entry of a wrong password results in an “ INCORRECT CODE” message. If this message appears, you cannot continue the viewer restriction setting operation unless you re-enter the correct password. (Refer to Page 54.)
- If you forget your password, return the system to the state before registering the password. The method for doing this is described in NOTE of “Password registration” below. Next, register a new password.

With a DVD video disc loaded in the player, access the SETUP MENU screen. Highlight the “PARENTAL LOCK” with the remote control joystick, then press the “ENTER” button. The display will change to the “PERSONAL CODE” screen.

Enter a numerical four-digit password using the joystick, then press the “ENTER” button.

NOTE

If necessary, you can return the system to the state before registration of the password by doing the following:

On the “PERSONAL CODE” screen, highlight the first digit position with the joystick, and then click the “” mark end of the joystick 10 times. The screen will show “- - - -”, indicating that no password has been set.

Connecting External Devices to Your Rear Seat Entertainment System

You can enjoy TV games from a home-use TV game machine or video programs from a video tape player with the Rear Seat Entertainment System if such an external device is connected to one of the external device jacks of the system. For further details, refer to the instruction manual provided by the manufacturer of each external device.

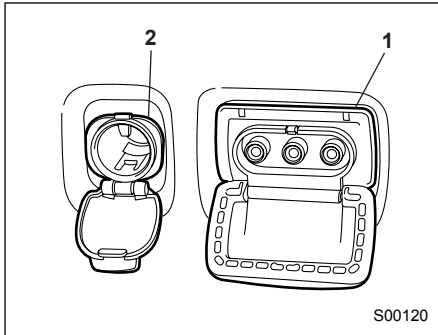

- 1) External device jacks
- 2) Accessory power outlet

Before you can use an external source device connected to the system, push the remote control's "VIDEO" button.

The external device jacks are located on the left side wall behind the second-row seat. Open the cover to use the jacks.

There are three jacks individually marked with different colors to identify their uses as follows:

- Yellow: external video devices
- Red: external audio devices
- White: external audio devices

Of the three accessory power outlets provided in your vehicle, the one located next to the external device jacks can be used to supply power to an external device. When using the power outlet, be sure to read the "Accessory power outlets" section in chapter 6 of the Owner's Manual.

CAUTION

- **Keep the cover closed when the external device jacks are not in use.**
- **Be sure to connect only appropriate plugs that fit the jacks. Doing otherwise could cause electrical failures or short circuits in the system.**
- **Do not allow spilled drinks or other foreign matter to get into the external device jacks. That could cause failure of the system.**
- **Rear-seat passengers must be careful not to hit connected plugs with their body or anything else; failure of the system could result.**

Adjusting Display Conditions and Selecting Display Mode

In addition to the function that allows you to adjust the display color and other esthetic conditions, the Rear Seat Entertainment System has a function that enables you to select the display mode (normal and wide screens) according to your preference. Use the following methods for the adjustment and selection.

Display Condition Adjustment

You can adjust the display conditions with respect to the following items:

- Brightness
- Contrast
- Tone (gradation)
- Color (balance)

NOTE

- **Tone and color adjustments are not possible when a music CD is loaded in the player.**
- **This setting is defaulted to medium within the adjustable range for each of the above adjustment items.**

■ Adjusting method

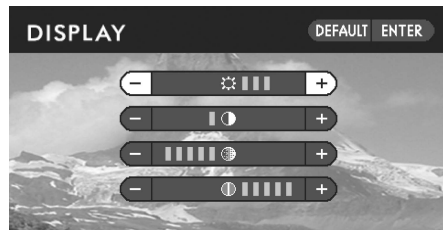

* This figure shows the screen when a DVD video disc or video CD is loaded in the player.

Press the remote control “DISPLAY” button. The display condition adjustment screen will appear.

Highlight the desired adjustment item with the joystick, and then click either the “◀” or “▶” end of the joystick referring to the table below. (Clicking the “◀” end results in “-” direction adjustments and clicking the “▶” end results in “+” direction adjustments.)

Set each adjustment by selecting the “ENTER” switch on the screen or pressing the remote control “ENTER” button.

NOTE

Select the “DEFAULT” switch to revert to a default setting.

Item	“+” direction (“▶”)	“-” direction (“◀”)
BRIGHTNESS	Brighter	Darker
CONTRAST	Stronger contrast	Weaker contrast
TONE	Steeper tone gradation	Gentler tone gradation
COLOR	Stronger green colors	Stronger red colors

Display Mode Selection

The following three display modes are available for your selection:

- Normal
- Wide 1
- Wide 2

NOTE

- You cannot change the display mode when a music CD is loaded in the player.
- The default display mode setting is “Wide 1”.

■ Selecting method



* This figure shows a screen image when the "WIDE 1" mode is selected.

Each time you press the remote control "DISPLAY MODE" button, the mode changes in the following sequence:

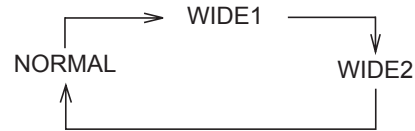

Release the "DISPLAY MODE" button; 6 seconds later, a full screen will be displayed in the selected mode.

Error Messages

The Rear Seat Entertainment System displays one of the following messages whenever it detects the relevant error condition. If an error message is displayed, take the appropriate action that is indicated on this page.

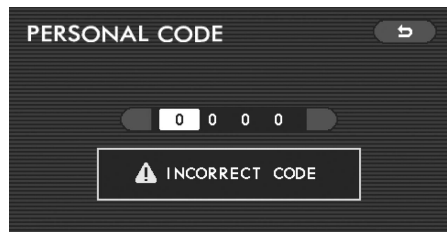

Cause: A wrong password (personal code) has been entered.

Remedy: Enter the correct password (refer to Page 49).



Cause:

- The disc has been inserted with the la-

bel side down.

- The disc is dirty.
- The disc is incompatible with the system.

Remedy: Check the inserted disc for any of the above causes. Correctly insert, clean or change the disc as necessary.



Cause: The inserted disc is of an inappropriate region code.

Remedy: Use only a disc marked "ALL" or "1".



Cause: Operational obstruction or other

mechanical fault has occurred during disc insertion or ejection.

Remedy: Have the system inspected by your SUBARU dealer.



Cause: Remote control "DVD • CD" button has been pressed when there is no disc in the player.

Remedy: Load a disc into the player.

Language/Code List

Language	Code
Afar	0101
Abkhazian	0102
Afrikaans	0106
Amharic	0113
Arabic	0118
Assamese	0119
Aymara	0125
Azerbaijani	0126
Bashkir	0201
Byelorussian	0205
Bulgarian	0207
Bihari	0208
Bislama	0209
Bengali; Bangla	0214
Tibetan	0215
Breton	0218
Catalan	0301
Corsican	0315

Language	Code
Czech	0319
Welsh	0325
Danish	0401
German	0405
Bhutani	0426
Greek	0512
English	0514
Esperanto	0515
Spanish	0519
Estonian	0520
Basque	0521
Persian	0601
Finnish	0609
Fiji	0610
Faroese	0615
French	0618
Frisian	0625
Irish	0701

Language	Code
Scots Gaelic	0704
Galician	0712
Guarani	0714
Gujarati	0721
Hausa	0801
Hindi	0809
Croatian	0818
Hungarian	0821
Armenian	0825
Interlingua	0901
Indonesian (formerly in)	0914
Interlingua	0905
Inupiak	0911
Icelandic	0919
Italian	0920
Inuktitut	0921
iw Hebrew (formerly iw)	0923
Japanese	1001

Language/Code List

Language	Code
Yiddish (formerly ji)	1009
Javanese	1023
Georgian	1101
Kazakh	1111
Greenlandic	1112
Cambodian	1113
Kannada	1114
Korean	1115
Kashmiri	1119
Kurdish	1121
Kirghiz	1125
Latin	1201
Lingala	1214
Laothian	1215
Lithuanian	1220
Latvian, Lettish	1222
Malagasy	1307
Maori	1309

Language	Code
Macedonian	1311
Malayalam	1312
Mongolian	1314
Moldavian	1315
Marathi	1318
Malay	1319
Maltese	1320
Burmese	1325
Nauru	1401
Nepali	1405
Dutch	1412
Norwegian	1415
Occitan	1503
(Afan) Oromo	1513
Oriya	1518
Punjabi	1601
Polish	1612
Pashto, Pushto	1619

Language	Code
Portuguese	1620
Quechua	1721
Rhaeto-Romance	1813
Kirundi	1814
Romanian	1815
Russian	1821
Kinyarwanda	1823
Sanskrit	1901
Sindhi	1904
Sangho	1907
Serbo-Croatian	1908
Sinhalese	1909
Slovak	1911
Slovenian	1912
Samoan	1913
Shona	1914
Somali	1915
Albanian	1917

Language	Code
Serbian	1918
Siswati	1919
Sesotho	1920
Sundanese	1921
Swedish	1922
Swahili	1923
Tamil	2001
Telugu	2005
Tajik	2007
Thai	2008
Tigrinya	2009
Turkmen	2011
Tagalog	2012
Setswana	2014
Tonga	2015
Turkish	2018
Tsonga	2019
Tatar	2020

Language	Code
Twi	2023
Uighur	2107
Ukrainian	2111
Urdu	2118
Uzbek	2126
Vietnamese	2209
Volapuk	2215
Wol'of	2315
Xhosa	2408
Yoruba	2515
Zhuang	2601
Chinese	2608
Zulu	2621
