

IC caution:

This device complies with Industry Canada licence-exempt RSS standard(s). Operation is subject to the following two conditions: (1) this device may not cause interference, and (2) this device must accept any interference, including interference that may cause undesired operation of the device.

Le présent appareil est conforme aux CNR d'Industrie Canada applicables aux appareils radio exempts de licence.

L'exploitation est autorisée aux deux conditions suivantes:

- (1) l'appareil ne doit pas produire de brouillage, et
- (2) l'utilisateur de l'appareil doit accepter tout brouillage radioélectrique subi, même si le brouillage est susceptible d'en compromettre le fonctionnement.

Under Industry Canada regulations, this radio transmitter may only operate using an antenna of a type and maximum (or lesser) gain approved for the transmitter by Industry Canada. To reduce potential radio interference to other users, the antenna type and its gain should be so chosen that the equivalent isotropically radiated power (e.i.r.p.) is not more than that necessary for successful communication.

Conformément à la réglementation d'Industrie Canada, le présent émetteur radio peut fonctionner avec une antenne d'un type et d'un gain maximal (ou inférieur) approuvé pour l'émetteur par Industrie Canada. Dans le but de réduire les risques de brouillage radioélectrique à l'intention des autres utilisateurs, il faut choisir le type d'antenne et son gain de sorte que la puissance isotrope rayonnée équivalente (p.i.r.e.) ne dépasse pas l'intensité nécessaire à l'établissement d'une communication satisfaisante.



28910

Please read the following instructions and warnings carefully.

Keep this instruction manual for future reference.

For technical support see back page.

For adult use only.

WARNING:

Adult assembly required.
Keep small parts away from children when assembling.



INSTRUCTION MANUAL

BABY WAVE™ DELUXE DIGITAL AUDIO MONITOR

WARNING:

STRANGULATION HAZARD - Children have STRANGLED in cords. Keep this cord out of reach of children (more than 3 feet (0.9 m) away from the crib). Use enclosed security clips to help secure cord away from baby's reach. Never use extension cords with AC adapters. Only use the AC adapters provided.



We **LOVE** our consumers!
Get to know us at:

www.summerinfant.com

Summer Infant stands behind all of its products. If you are not completely satisfied or have any questions, please contact our Consumer Relations Team at **1-800-268-6237** or www.summerinfant.com/contact

(For Europe call +44 (0) 144 250 5000 or customerserviceuk@summerinfant.com)

connect with us:



Summer Infant, Inc.
1275 Park East Drive
Woonsocket, RI 02895 USA
1-800-268-6237

Summer Infant Europe, Ltd.
First Floor North Wing, Focus 31
Cleveland Road, Hemel Hempstead
HP2 7BW UK
+44 (0) 144 250 5000

© 2013 Summer Infant, Inc.
Colors and styles may vary.
Please retain information
for future reference.
MADE IN CHINA. 7/13

WARNING:

THIS PRODUCT CANNOT REPLACE RESPONSIBLE ADULT SUPERVISION.

- **STRANGULATION HAZARD** - Children have STRANGLED in cords. Keep this cord out of reach of children (more than 3 feet (0.9 m) away from the crib). Use enclosed security clips to help secure cord away from baby's reach. Never use extension cords with AC adapters. Only use the AC adapters provided.
- When an AC adapter is plugged into an electrical outlet, do not touch the exposed end.
- Test monitor before first use, periodically, and when changing locations.
- Do not use near water (such as bathtub, sink, etc.).
- Keep away from heat sources (such as stoves, radiators, etc.).
- Make sure there is proper ventilation around all components. Do not place on sofas, cushions, beds, etc. which may block ventilation.
- Nursery monitors use public airwaves to transmit signals. This monitor may pick up signals from other monitors or similar devices and signals broadcast by this monitor may be picked up by other receivers.
- This product is not a toy. Do not allow children to play with it.
- This product contains small parts. Adult assembly required. Exercise care when unpacking and assembling the product.

BATTERY WARNING:

- Use only the original rechargeable batteries provided. Please contact Summer Infant, Inc. for replacement batteries. Contact information can be found on page 8 of these instructions or on the battery itself.
- Do not mix old and new batteries.
- Do not mix alkaline, standard, or rechargeable batteries.
- Batteries are to be inserted with correct polarity.
- Clean battery and product contacts prior to battery installation.
- Do not short-circuit supply terminals.
- Only the recommended batteries or equivalent are to be used, volts and size.
- Remove batteries when product is stored for long periods of time or when batteries are exhausted.
- Dispose of exhausted batteries properly.
- Do not recharge non-rechargeable batteries.
- Rechargeable batteries are only to be charged under adult supervision.
- Keep all batteries away from children.



IMPORTANT SAFETY INSTRUCTIONS

- 1) Read Instructions - All the safety and operating instructions should be read before the product is operated.
- 2) Retain Instructions - The safety and operating instructions should be retained for future reference.
- 3) Heed Warnings - All warnings on the product and in the operating instructions should be adhered to.
- 4) Follow Instructions - All operating and use instructions should be followed.
- 5) Cleaning - Unplug this product from the wall outlet before cleaning. Do not use liquid cleaners or aerosol cleaners. Use a damp cloth for cleaning.
- 6) Attachments - Do not use attachments not recommended by the product manufacturer as they may cause hazards.
- 7) Water and Moisture - Do not use this product near water - for example, near a bath tub, wash bowl, kitchen sink, or laundry tub; in a wet basement; or near a swimming pool; and the like.
- 8) Accessories - Do not place this product on an unstable cart, stand, tripod, bracket, or table. The product may fall, causing serious injury to a child or adult, and serious damage to the product. Use only with a cart, stand, tripod, bracket, or table recommended by the manufacturer, or sold with the product. Any mounting of the product should follow the manufacturer's instructions, and should use a mounting accessory recommended by the manufacturer.
- 9) Ventilation - Slots and openings in the cabinet are provided for ventilation and to ensure reliable operation of the product and to protect it from overheating, and these openings must not be blocked or covered. The openings should never be blocked by placing the product on a bed, sofa, rug, or other similar surfaces. This product should not be placed in a built-in installation such as a bookcase or rack unless proper ventilation is provided or the manufacturer's instructions have been adhered to.
- 10) Power Sources - This product should be operated only from the type of power source indicated on the marking label. If you are not sure of the type of power supply to your home, consult your product dealer or local power company. For products intended to operate from battery power, or other sources, refer to the operating instructions.
- 11) Power-Cord Protection - Power-supply cords should be routed so that they are not likely to be walked on or pinched by items placed upon or against them, paying particular attention to cords at plugs, convenience receptacles, and the point where they exit from the product.
- 12) Power Lines - An outside antenna system should not be located in the vicinity of overhead power lines or other electric light or power circuits, or where it can fall into such power lines or circuits. When installing an outside antenna system, extreme care should be taken to keep from touching such power lines or circuits as contact with them might be fatal.
- 13) Overloading - Do not overload wall outlets, extension cords, or integral convenience receptacles as this can result in a risk of fire or electric shock.
- 14) Object and Liquid Entry - Never push objects of any kind into this product through openings as they may touch dangerous voltage points or short-out parts that could result in a fire or electric shock. Never spill liquid of any kind on the product.
- 15) Servicing - Do not attempt to service this product yourself as opening or removing covers may expose you to dangerous voltage or other hazards. Refer all servicing to qualified service personnel.
- 16) Damage Requiring Service - Unplug this product from the wall outlet and refer servicing to qualified service personnel under the following conditions:
 - a) When the power-supply cord or plug is damaged,
 - b) If liquid has been spilled, or objects have fallen into the product,
 - c) If the product has been exposed to rain or water,
 - d) If the product does not operate normally by following the operating instructions. Adjusting only those controls that are covered by the operating instructions as an improper adjustment of other controls may result in damage and will often require extensive work by a qualified technician to restore the product to its normal operation,
 - e) If the product has been dropped or damaged in any way, and
 - f) When the product exhibits a distinct change in performance.
- 17) Replacement Parts - When replacement parts are required, be sure the service technician has used replacement parts specified by the manufacturer or have the same characteristics as the original part. Unauthorized substitutions may result in fire, electric shock, or other hazards.
- 18) Safety Check - Upon completion of any service or repairs to this product, ask the service technician to perform safety checks to determine that the product is in proper operating condition.
- 19) Wall or Ceiling Mounting - The product should be mounted to a wall or ceiling only as recommended by the manufacturer.
- 20) Heat - The product should be situated away from heat sources such as radiators, heat registers, stoves, or other products (including amplifiers) that produce heat.

PROBLEM SOLVING:

Battery Installation

Note: this step is only needed if replacing battery

1. Locate the battery compartment door back of Parent Unit
2. Slide battery door off
3. Remove battery
4. Insert new battery and replace battery door.

REPLACEMENT PARTS AND PRODUCT REGISTRATION

If you need to order a replacement part or want to order an Extra Camera, you can contact our Customer Relations Department at **1-800-268-6237** or via email at www.summerinfant.com/contact

- Rechargeable NiMH battery AAA Size 3.6V 800mAh: #29030-10
- AC Adapter: #28890-13

To register your product, visit:

www.summerinfant.com/product-registration/product-registration-form

If you experience a problem that is not noted in this manual, please do not return the product to the store. Our Customer Service Department may have a simple solution to your problem. Please contact us at 1-800-268-6237 or email us at summerinfant.com/contact.

FCC Information

This device complies with part 15 of the FCC Rules. Operation is subject to the following two conditions: (1) This device may not cause harmful interference, and (2) this device must accept any interference received, including interference that may cause undesired operation.

CAUTION: Changes or modifications not expressly approved by Summer Infant may void the users authority to operate this equipment.

NOTE: This equipment has been tested and found to comply with the limits for a Class B digital device, pursuant to part 15 of the FCC Rules. These limits are designed to provide reasonable protection against harmful interference in a residential installation. This equipment generates, uses and can radiate radio frequency energy and, if not installed and used in accordance with the instructions, may cause harmful interference to radio communications. However, there is no guarantee that interference will not occur in a particular installation. If this equipment does cause harmful interference to radio or television reception, which can be determined by turning the equipment off and on, the user is encouraged to try to correct the interference by one or more of the following measures:

- Reorient or relocate the receiver
- Increase the separation between the equipment and the receiver
- Connect the equipment into an outlet on a circuit different from that to which the receiver is connected.
- Consult the dealer or an experienced radio/TV technician for help

For parent unit:

The equipment complies with FCC/IC radiation exposure limits set forth for an uncontrolled environment. And transmitter must not be collocated or operating in conjunction with any other antenna or transmitter.

For baby unit:

1. To comply with FCC (IC) RF exposure compliance requirements, a separation distance of at least 20 cm must be maintained between the antenna of this device and all persons.
2. This transmitter must not be co-located or operating in conjunction with any other antenna or transmitter.

Summer Infant, Inc. Monitor Warranty Policy

Summer Infant, Inc. will repair or replace (at our option) your unit free of charge for 12 months from the date of purchase if the unit is defective in workmanship or materials. To claim your repair/replacement, the product must be returned to Summer Infant along with a copy of the original purchase receipt. In the absence of the purchase receipt, the warranty will be 12 months from the date of manufacture. This warranty does not apply to normal wear or damage from misuse, abuse, improper storage and handling, installation, accident, unauthorized repair or alteration. Please contact our Customer Service Department by phone at 1-800-268-6237 or via e-mail at summerinfant.com/contact for details.

FEATURES & COMPONENTS:

PARENT UNIT (Receiver):

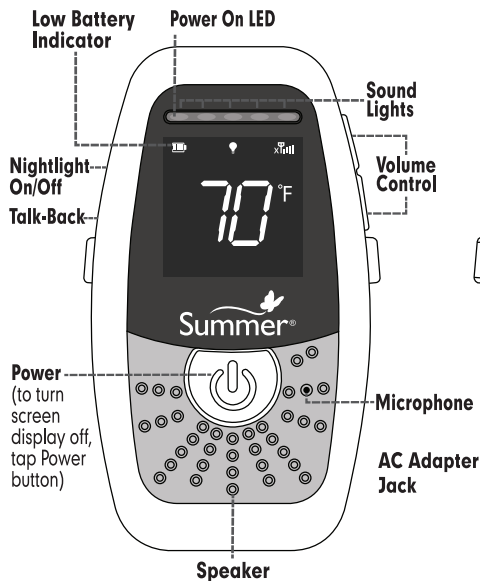

PARENT UNIT (Back View):

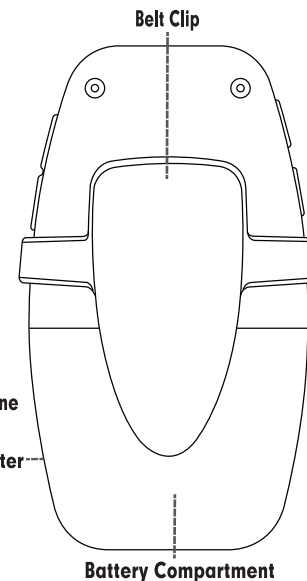

BABY UNIT (Transmitter):

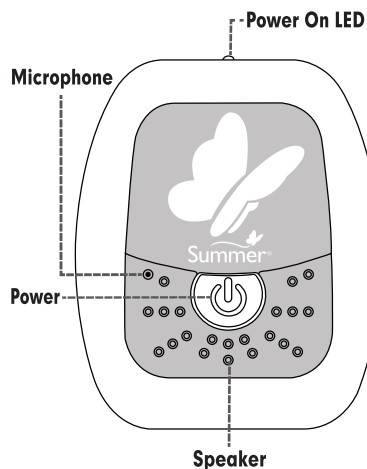

BABY UNIT (Back View):

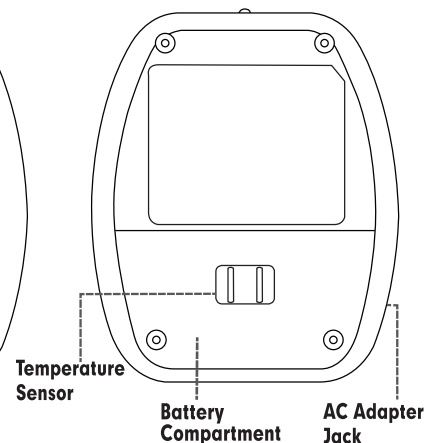

Adapters and Hardware:

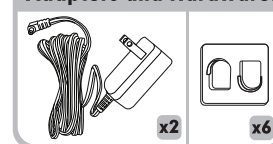

SETUP & USE:

⚠ WARNING: **STRANGULATION HAZARD** - Children have **STRANGL**ED in cords. Keep this cord out of reach of children (more than 3 feet (0.9 m) away from the crib). Use enclosed Security Clips to help secure cord away from baby's reach. Never use extension cords with AC Adapters. Only use the AC Adapters provided.



Initial Setup:

To set up the system, you will need two adults. One adult should be in the nursery with the Baby Unit (transmitter) while the other is in a different room with the Parent Unit (receiver).

Note: The Parent Unit includes a rechargeable battery and it should be fully charged before using the monitor in portable mode. Charge the battery for 12-16 hours. When the unit is fully charged, the LED under the On/Off switch will remain on until it is unplugged. After the initial 12-16 hour charge, only charge the battery when the battery is low to achieve optimal battery life.

Step 1: Place the Baby Unit in the nursery near the crib, on a flat surface, and ensure the cord is more than 3-feet from the crib and out of baby's reach. Plug the AC adapter into a standard electrical outlet.

Step 2: Press the power button on the front of Baby Unit for 4-seconds to turn the unit on.

Step 3: Place the Parent Unit in the room from which you want to monitor baby. Plug the AC adapter into a standard electrical outlet.

Step 4: Press the power button the front of the Parent Unit for 4-seconds to turn it on.

Step 5: Have the adult in the baby's room speak at different levels to adjust the volume to the desired setting. The volume can be adjusted up or down using the Volume Control buttons on the side of the Parent Unit.

Baby Unit Setup in Nursery:

Place the Baby Unit (transmitter) on a flat surface, such as a bureau or shelf (Fig A). NEVER place the Baby Unit or cords within 3-feet of the crib. Secure the cord to the wall (Fig B) using the 6 security clips included to keep the cord away from baby's reach.

Syncing Baby and Parent Unit:

Note: This digital monitor set is pre-synced with security codes for privacy reasons. However, there are instances that the Baby and Parent unit will lose it's code and may require you to re-sync it.

Step 1: Connect the Baby unit to it's power supply and make sure unit is powered OFF.

Step 2: Turn ON Parent unit.

Step 3: Press and keep holding the "VOL +" button and at the same time press the POWER button for about 4 seconds. A continuous audible BEEP and red flashing lights will occur. The Parent unit is now ready to be synced.

Step 4: Within 20 seconds, turn on the Baby unit. A single BEEP will emit from the Parent unit to signify successful syncing.

SPECIAL FEATURES:

• **Two-way Communication:** Calm baby with the sound of your voice or use as a convenient way to remind each other of something needed from the nursery. By speaking into the handheld unit your voice is projected through the unit in baby's room, so you can give comfort and reassurance, or gentle reminders, from another room.

• **Nightlight:** Create an ambient glow for baby's room with the butterfly nightlight right on the monitor. The nightlight provides a convenient way for parents to sneak a peek of baby in a dark room and the remote control from the parent handheld unit makes it easy to turn it on or off for baby's sleeping comfort.

• **Temperature Monitoring:** Monitoring the temperature in baby's room is easy with the option to display it on screen and help parents know baby is comfortable. Press and hold the nightlight button for 4-seconds to switch between Fahrenheit and Celsius.

• **Sound Lights:** The monitor lets you not only hear your baby but with sound activated lights, parents can "see" the sound level coming from baby's room. Displayed on a color bar, the color changes as the sound level changes; moving from green to amber to red as the sound level increases. These lights can be especially helpful for parents when they are in a noisy or crowded room.

• **Adjustable Volume:** Volume adjustments allow parents to monitor baby's sounds at multiple levels accommodating preferences for hearing very low level sounds to monitoring only louder sounds and cries only. The higher volume settings allows parents to hear even very low sounds coming from baby's room, such as the baby cooing while the lower volume settings monitors louder sounds and cries.

• **Sensitive Microphone:** The high sensitivity microphone allows parents to hear low level sounds coming from baby's room as well as the louder sounds and crying, giving them peace of mind know they will be able to hear baby day and night. The microphone focuses on baby's sounds while filtering background, ambient noises enabling a clear connection to the parent unit.

• **Out of Range Indicator:** If the Parent Unit is too far away from the Baby Unit, it will be "out of range" and the monitor (parent unit) will emit 4 consecutive beeps. The beeps will continue until the Parent Unit is moved back within range of the Baby Unit.

• **Low Battery Indicator:** If the Parent Unit is low on battery power, the unit will emit a beeping sound. The low battery will continue to beep until the unit is plugged in.

• **Belt Clip:** Added convenience and portability is provided with a built-in belt clip on the Parent Unit. This feature allows parents a convenient way to keep the unit with them as they move throughout the house, with up to a 650-foot range.

PROBLEM SOLVING:

No sound coming from the speaker

- Make sure both the Baby Unit and Parent Unit are plugged in and powered on.
- Make sure electrical outlets are working.
- Set volume to a higher setting.

Static

- Move the Parent Unit closer to the Baby Unit

Squealing Noise

- Move the Parent Unit and Baby Unit farther apart, the squealing sound indicates the units are too close together
- Turn down the volume on Parent Unit.

Weak reception or no reception

- Make sure both Parent Unit and Baby Unit are turned on.
- Move the Parent Unit closer to the Baby Unit.
- Make sure the battery in the Parent Unit is fully charged.