

Sunbeam

Café Barista™

Automatic 15 BAR pump espresso machine

Instruction Booklet

EM8800

Please read these instructions carefully
and retain for future reference.



تأكد من تفهم احتياطات السلامة المذكورة اعلاه

請務必理解上述的安全預防措施。

Assurez-vous que les précautions ci-dessus relatives à la sécurité sont bien comprises

Versichern Sie sich daß die obenstehenden Sicherheitsmaßnahmen Verstanden werden

Βεβαιώνετε πως οι παραπάνω προφυλάξεις ασφαλείας γίνονται κατανοητές

Pastikan bahwa tindakan-tindakan keselamatan seperti di atas dimengerti anda

Accertatevi che le suddette norme di sicurezza siano comprese a dovere

上記の注意事項をよくお読みになり、安全を御確認ください

Уверете се дека погоре споменатите мерки на претпазливост се добро разбрани

Asegúrese de que las precauciones de seguridad precedentes sean bien comprendidas

کاری بکنید کہ احتیاطهای بالا حتماً درک بشوند

ต้องแน่ใจว่า ข้อควรระวังเรื่องความปลอดภัยข้างต้น เป็นที่เข้าใจกันดี

Yukarda belirtilen güvenliк önlemlerinin anlaşıldığından emin olunuz

Xin kiểm chắc rằng những biện pháp làm an toàn kể trên được hiểu rõ

Contents

Sunbeam's Safety Precautions	2
About espresso coffee	3
Features of your Café Barista™	4
Secrets to the perfect cup	9
Preparing your Café Barista™	10
Filling of water and switching on your Café Barista™	11
Switching off your Café Barista™	12
Determining and adjusting the water hardness	13
Making an espresso with coffee beans	14
Making an espresso with pre-ground coffee	17
Milk frothing using the steam function	20
Easy steps for frothing milk	22
Hot water function	23
Changing and saving coffee pour volumes and coffee strength settings	24
Grind setting selection and maintenance	26
Resetting the Café Barista™	27
Care and cleaning	28
Emptying coffee waste container	29
Cleaning the coffee brewing unit	29
Starting the cleaning programme	32
Starting the descaling programme	33
Indicator lights guide	36
Trouble shooting guide	37
Recipes	41

Sunbeam's Safety Precautions

SAFETY PRECAUTIONS FOR YOUR SUNBEAM ESPRESSO MACHINE.

- Always place the unit on a flat, level surface.
- Do not operate without water in reservoir. Fill only clean and cold water into the water reservoir. Observe the maximum filling volume is 1.5 litres.
- Do not operate without the drip tray and cup rest plate in position.
- The steam nozzle becomes very hot when frothing milk or preparing hot water. This may cause burns in case of contact,

therefore avoid any direct contact with the steam nozzle.

- Hot water or hot steam ejected by the appliance can cause scalding. Only activate the steam nozzle when holding a container underneath.
- Always unplug the appliance from the power outlet if there is any problem during the coffee making process or prior to cleaning and maintenance.
- Never put any part of this appliance into the dishwasher. Never immerse the appliance in water.

Sunbeam are very safety conscious when designing and manufacturing consumer products, but it is essential that the product user also exercise care when using an electrical appliance. Listed below are precautions which are essential for the safe use of an electrical appliance:

- Read carefully and save all the instructions provided with an appliance.
- Always turn the power off at the power outlet before you insert or remove a plug. Remove by grasping the plug - do not pull on the cord.
- Turn the power off and remove the plug when the appliance is not in use and before cleaning.
- Do not use your appliance with an extension cord unless this cord has been checked and tested by a qualified technician or service person.
- Always use your appliance from a power outlet of the voltage (A.C. only) marked on the appliance.
- Close supervision is necessary when your appliance is being used near children or infirm persons.
- Never leave an appliance unattended while in use.
- Young children should be supervised to ensure that they do not play with the appliance.

- Do not use an appliance for any purpose other than its intended use.
- Do not place an appliance on or near a hot gas flame, electric element or on a heated oven. Do not place on top of any other appliance.
- Do not let the power cord of an appliance hang over the edge of a table or bench top or touch any hot surface.
- For safety reasons and to avoid maintenance by unskilled persons, some appliances are 'sealed' using tamperproof screws. Such appliances should always be returned to the nearest Sunbeam Appointed Service Centre for adjustment or repair if required.
- Do not operate any electrical appliance with a damaged cord or after the appliance has been dropped or damaged in any manner. If damage is suspected, return the appliance to the nearest Sunbeam Appointed Service Centre for examination, repair or adjustment.
- For additional protection, Sunbeam recommend the use of a residual current device (RCD) with a tripping current not exceeding 30mA in the electrical circuit supplying power to your appliances.
- Do not immerse the appliance in water or any other liquid unless recommended.

If you have any concerns regarding the performance and use of your appliance, please visit www.sunbeam.com.au or contact the Sunbeam Consumer Service Line. Ensure the above safety precautions are understood.

About espresso coffee

Sunbeam's extensive experience in designing quality, long-lasting appliances has enabled us to develop a range of pump espresso machines that are as beautiful as they are functional. As well as incorporating the learnings from commercial machines to ensure café quality coffee, ease-of-use was an important dynamic in the design of the Café Barista™.

The Sunbeam Café Barista™ is automatic, completely removing any guesswork from making espresso coffee. At the push of a button the machine will grind the coffee beans, place the correct dose of coffee grinds into the filter, tamp it and pump the precise amount of water needed to produce a shot of espresso. As a result, each time you make an espresso with the Sunbeam Café Barista™ you are assured a consistent taste every time. As coffee continues to be an integral element of Australian culture, the demand for the perfect cup is ever increasing. A growing favourite for coffee lovers in Australia, at any time of the day is the Caffè Latte. To accommodate these style of drinks, the height of the espresso pour spouts are adjustable. Ideal for all styles of cups – bring the spouts down for espresso cups and for those that prefer a Caffè Latte or a Long Black raise the pour spouts for taller cups. Drinking authentic café quality coffee at home is guaranteed with a Sunbeam espresso machine. The simple to use design of the machine allows you to enjoy the sweet aroma and taste of the perfect shot of espresso with its signature golden crema every time.

What makes a good coffee?

Sunbeam has consulted with experienced coffee makers and appreciators of coffee through every stage of design, to ensure the machine delivers a great espresso coffee every time. There are many factors that contribute to the perfect coffee. The words 'taste' and 'aroma' are consistently used when describing the perfect cup.

The sweet aroma and taste of the perfect espresso coffee is largely due to the correct combination of temperature and pressure during the brewing process. The 'thermoblock' heating system ensures the water is at the correct temperature, so that the full coffee flavour is extracted. Secondly, the Italian made 15 BAR pump ensures the correct pressure at which the liquid espresso is released from the pour spouts. The pour should be steady and consist of both liquid and cream. This cream is known as the 'crema'. The perfect 'crema' should be a golden colour and be thick and stable, preserving the coffee flavour, aroma and temperature.

We hope you have many enjoyable coffee experiences with the Sunbeam Café Barista™.

Should you need any further assistance, please don't hesitate to contact the Sunbeam coffee hotline on free call 1800 025 059.

Features of your Sunbeam Café Barista™

Warming plate

Allows coffee cups to be warmed before use.

Steam/Hot water switch

Turn the switch to activate steam or hot water.

Steam nozzle

Dispenses steam or hot water.

Height-adjustable espresso pour spout

Fits any size cup. Lower the spout for espresso cups to prevent splashing and raise it for Caffe Latte or taller cups.

Coffee waste container

Holds the used coffee cakes as they are dispensed from the coffee brewing unit.

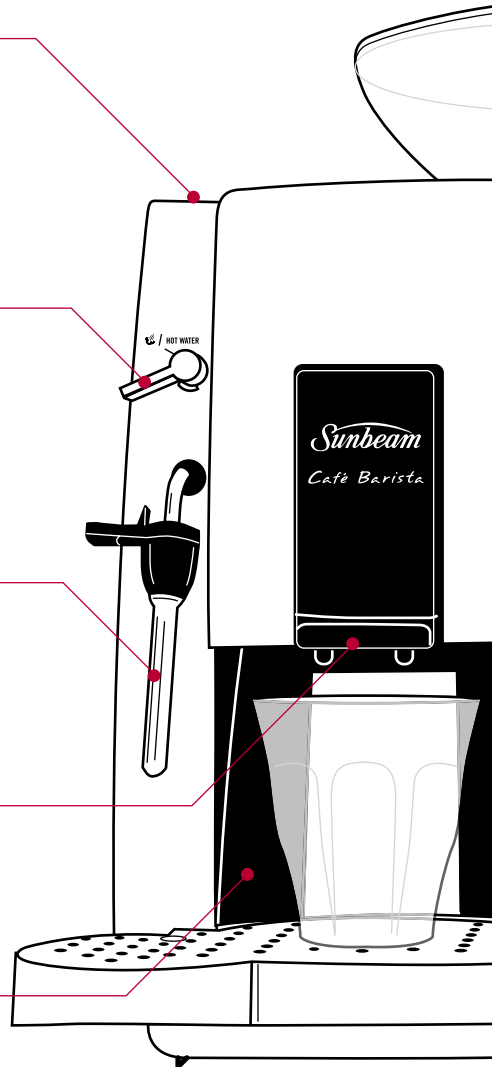

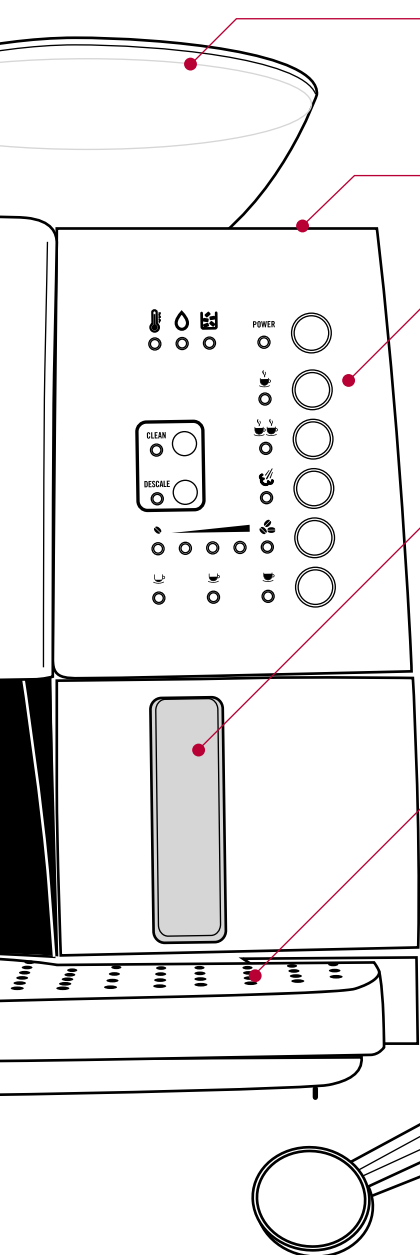

Coffee bean hopper

The conical burr grinder holds up to 230g of coffee beans.

Coffee grind selector

Select grind setting from fine to coarse.

Control panel

1.5 litre removable water reservoir

Simply slides out for easy filling.

Removable drip tray and cup resting grid

Pulls out for easy emptying and cleaning. Also features a water level indicator that floats through the cup resting grid indicating how full the drip tray is.

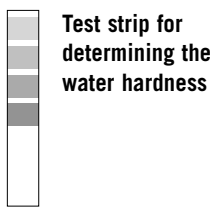

Test strip for determining the water hardness

Cleaning tablets



Descaling tablet

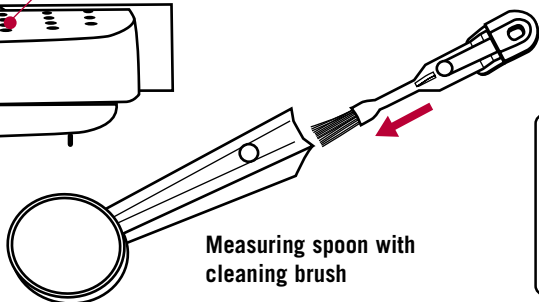
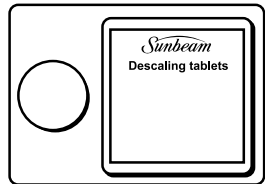

Measuring spoon with cleaning brush

Features of your Sunbeam Café Barista™ (continued)

TOP VIEW

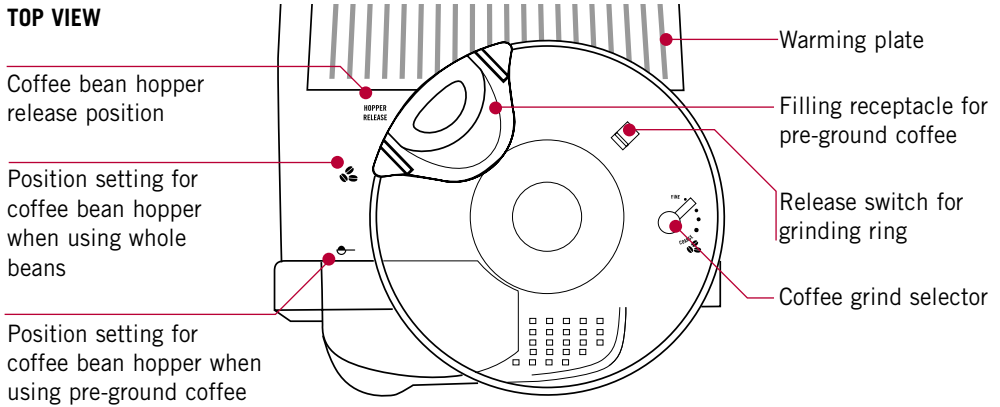

CONTROL PANEL

Temperature indicator

A constant light indicates that the temperature of the Café Barista™ is correct, when flashing it is heating to the correct temperature.

Water indicator

A constant light indicates that the water reservoir needs filling.

Cleaning programme
– button and indicator

Descaling programme
– button and indicator

Coffee pour volume -
button and indicator

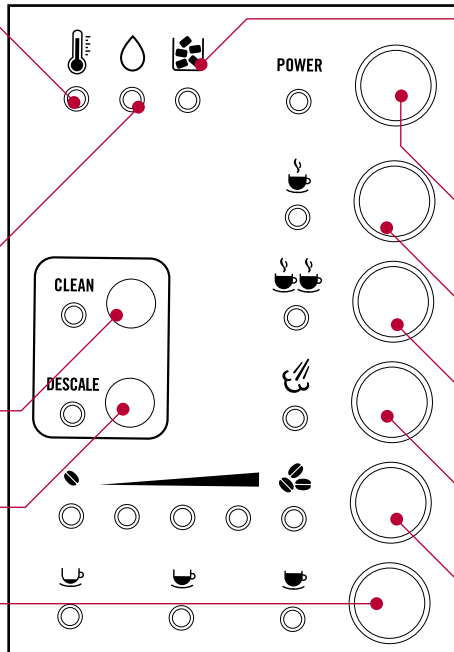

Coffee waste container indicator

A constant light indicates that the coffee waste container needs emptying.

Power - button and indicator

1 cup coffee request -
button and indicator

2 cup coffee request -
button and indicator

Steam pre-selection -
button and indicator

Coffee strength/quantity -
button and indicator

Features of your Sunbeam Café Barista™

One touch operation

The Café Barista™ is an automatic espresso machine that takes the guess work out of making espresso coffee. It grinds the coffee beans, dispenses the ground coffee into the filter, tamps it and pumps water through to produce a consistent shot of espresso every time – all with the touch of a button.



15 BAR pump – Italian designed & manufactured

Supplies the correct and essential pressure necessary for full extraction of oils from the coffee grinds.

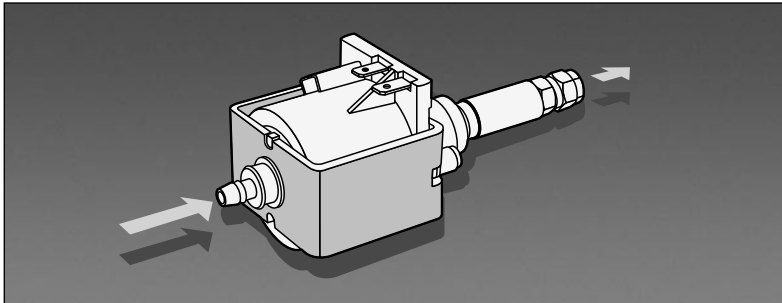

Features of your Sunbeam Café Barista™ (continued)

'Thermoblock' heating system

Ensures the precise temperature is achieved. As espresso is made with hot, rather than boiling water, the 'thermoblock' heats the water to 92°C (just below boiling point) for optimum extraction of oils from the coffee grinds. Temperatures above this will burn the coffee grinds.

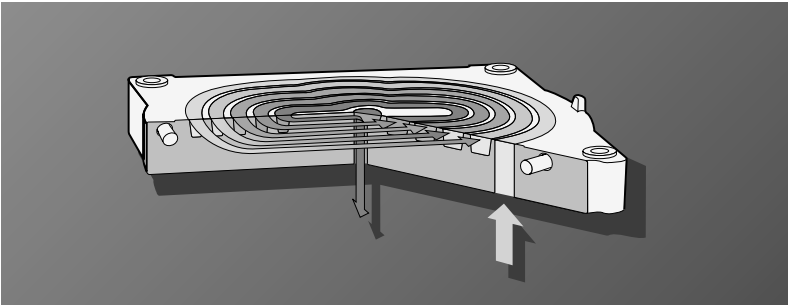

Secrets to the perfect cup

With a Sunbeam pump espresso machine and a little experience, you can create café quality coffee at home. As there are a number of possibilities for making coffee to meet your personal taste, following are a few helpful suggestions:

- The origin of the bean and roasting will affect the taste of the espresso, so test different brands of coffee to find the one that you like best.
- The grind of the coffee is critical. Vary the degree of grinding to find the right fineness for the coffee beans being used.
- A regular shot of espresso, the base of all café coffees is approximately 30mLs. The shot of espresso is a concentrate; vary the quantity of milk to determine the strength and volume of the coffee. If you are using a large coffee cup or mug you may require a double shot of espresso, rather than just a single shot depending on your taste.
- Always use the freshest beans or ground coffee available and store in an airtight container in a cool, dry, dark place.
- Whole coffee beans stay fresh longer than pre-ground coffee.
- Pre-warm cups prior to making an espresso, either by filling with hot water or placing on the warming plate.
- Always use cold milk and a clean stainless steel jug when texturing/frothing milk.
- Don't boil the milk when steaming. The ideal temperature is when the jug becomes too hot to touch.
- Once prepared, serve coffee immediately.
- Keep the espresso machine clean. Familiarise yourself with the 'Care and Cleaning' section of this book.

Preparing your Café Barista™

- Position the espresso machine onto a stable, flat, dry surface.
- Attach the coffee bean hopper onto the espresso machine. With the hopper in hand, align the arrow on the base of the hopper with the 'HOPPER RELEASE' position. When the hopper is sitting flat, push down and turn anti-clockwise so that the arrow on the base of the hopper meets with one of the other two positions; ☿ whole beans or ☉ pre-ground coffee. See figures 1 and 2.
- Insert the drip tray. Simply slide the drip tray into the base of the espresso machine until it clicks into place on the right-hand side below the water reservoir. See figure 3.
- Insert the power cord into a 230-240V AC power outlet. Then open the flap of the power cord compartment and stow away the remaining cable. See figure 4.

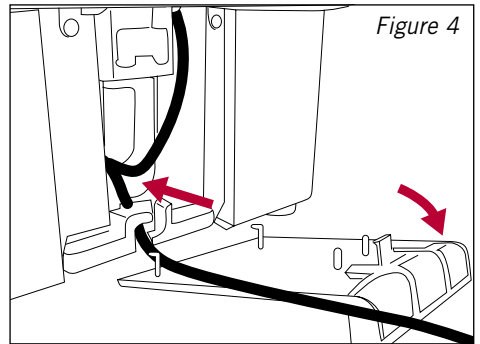
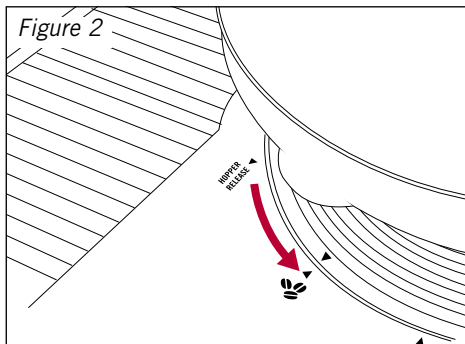
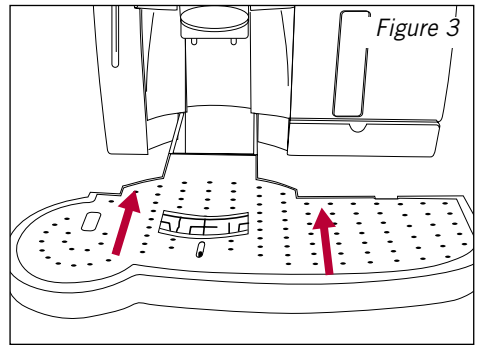
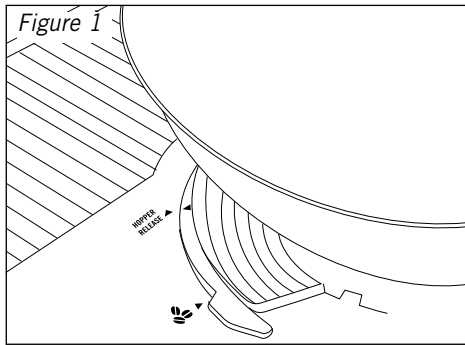

Filling of water and switching on your Café Barista™

Prior to switching on each time, check whether the water reservoir is filled with water. Every time the appliance is switched on or off, it needs water for the Auto Clean cycle.

Filling the appliance

- Slide out and remove the water reservoir from the appliance. See figure 5.
- Fill the water reservoir always with fresh, cold water. See figure 6.

Note: Fill only cold water into the water reservoir. Never fill with other liquids, such as mineral water or milk.

- Replace the water reservoir. Slide the water reservoir in and press firmly into place to ensure that the valve of the water reservoir opens. See figure 7.

Note: If the water reservoir is not correctly in position or if water needs to be refilled while the espresso machine is in operation, the water indicator  illuminates. Making coffee will not be possible or the cycle will be interrupted.

Switching on the appliance

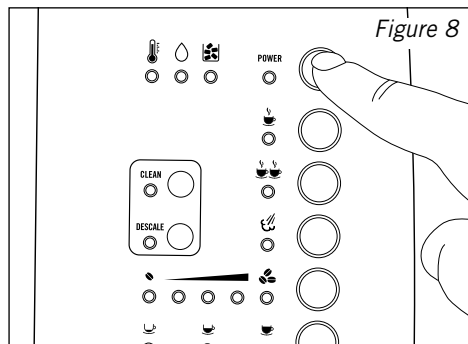
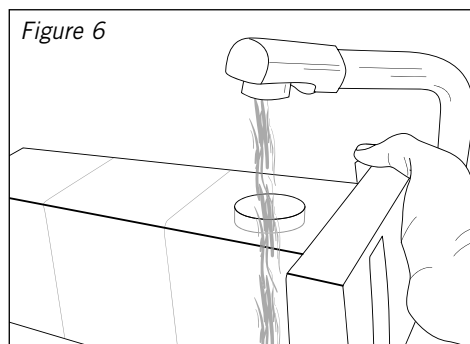
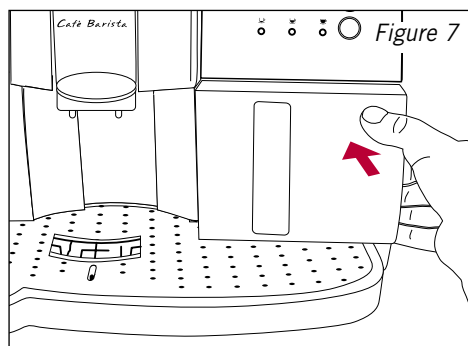
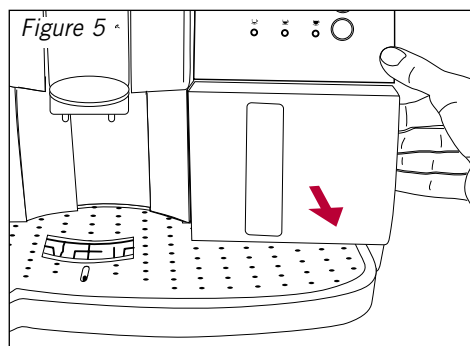

- Turn the power on at the power outlet and switch the espresso machine on by briefly pressing the 'POWER' button on the control panel. See figure 8.

Note: Please note that you only need to briefly press the 'POWER' button and that there is a slight delay until the light comes on.

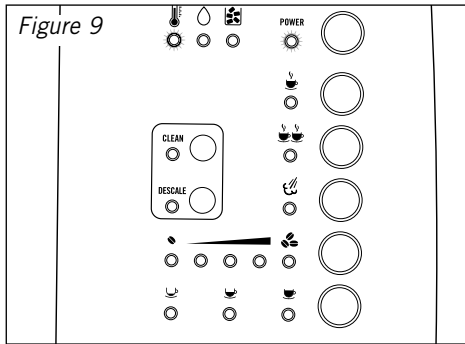

Filling of water and switching on your Café Barista™ (continued)



- When the espresso machine is turned on it will go through an Auto Clean cycle. This removes any old coffee grinds from the coffee brewing unit.
- During the heating procedure the temperature indicator  flashes. When the operating temperature is reached, the temperature indicator  will stop flashing and remain constant. See figure 9.
- The espresso machine is now ready for operation.

Switching off your Café Barista™

When the espresso machine is switched off by briefly pressing the power button on the control panel, another Auto Clean cycle is carried out and the coffee waste container indicator  will flash as a reminder for approximately 1 minute.

If the espresso machine is switched off during a function by pressing the 'POWER' button all functions are immediately switched off.

Determining and adjusting the water hardness

Prior to first use the Café Barista™ should be adjusted to the relevant degree of water hardness for your region. Water hardness refers to the mineral content of your local water supply. You may determine the hardness degree using the supplied test strips.

- Dip the test strip into cold water for 1 second. Shake off the excess water and the degree of water hardness is determined according to the number of pink-coloured squares.

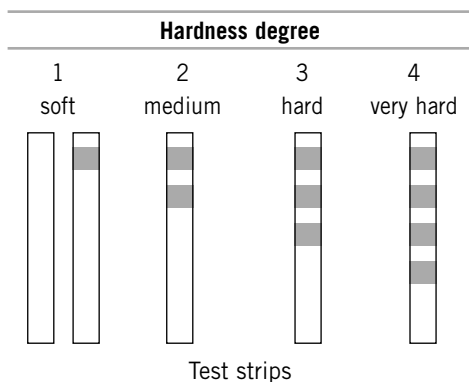

Adjusting and saving the determined degree of water hardness

Note: The Café Barista™ is factory set at a hardness degree of 4.

- Press the 'DESCALE' button and keep it depressed. See figure 10.

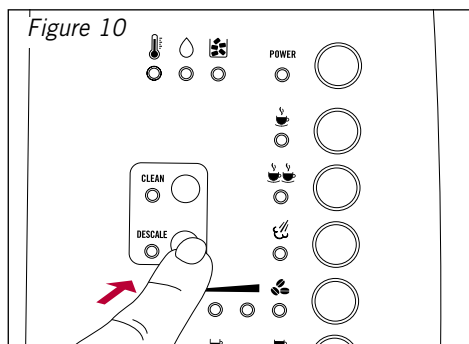

- While holding down the 'DESCALE' button, press the 'coffee strength' button once and this will indicate the current setting for water hardness. Continue to press the 'coffee strength' button until you have reached the desired level of hardness. See figure 11.

The hardness degrees are indicated as follows:

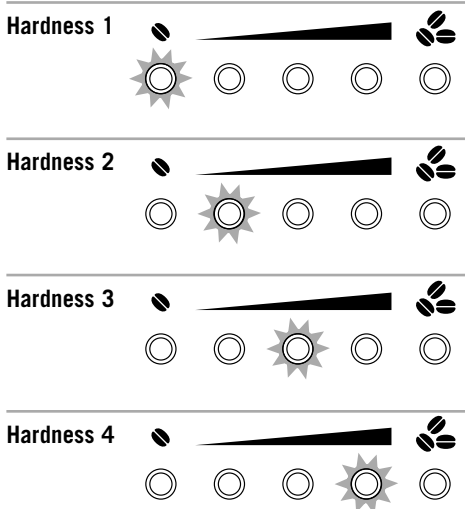

- Once you have selected the degree of water hardness, remove your finger from the 'DESCALE' button and the machine is ready for use.

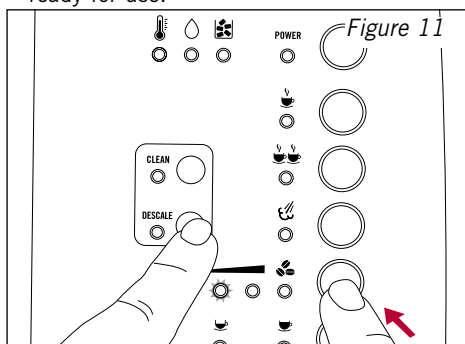

Making an espresso with coffee beans

It is possible to adjust the espresso machine individually to suit your personal taste by adjusting the grinding degree and the amount of coffee beans to be ground.

Filling the coffee bean hopper

Note: Please ensure to fill the coffee bean hopper only with coffee beans.

- Turn the hopper so that the arrow on the base of the hopper is aligned with the ☘ whole beans arrow. See figure 12.
- Open the lid of the hopper and fill with fresh coffee beans. Then close the lid. See figure 13.

Note: Make sure that no foreign matter, e.g. stones or wood chips, get into the coffee bean hopper as this can cause damage to the grinding mechanism.

- Set the grinding degree. See figure 14.

Note: You may set the grinding degree of the grinding mechanism by using the 'coffee grind' lever. There are two ways in which the grinding degree can be set. The first method can only be used when filling the hopper with beans for the first time and you simply use the 'coffee grind' lever. Please note that at this stage the grinding mechanism is empty and at a standstill. At any other time however, once the grinding mechanism has been filled with beans you may only set the grinding position during the grinding procedure; otherwise the espresso machine may be damaged.

Note: A medium grinding degree is factory set on the Café Barista™.

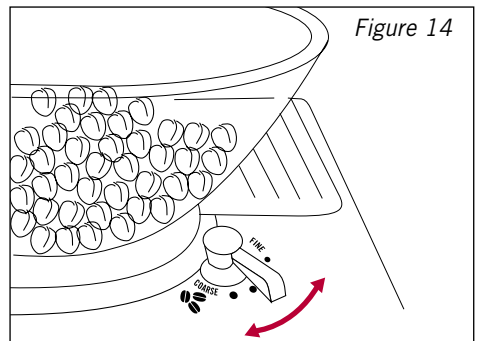
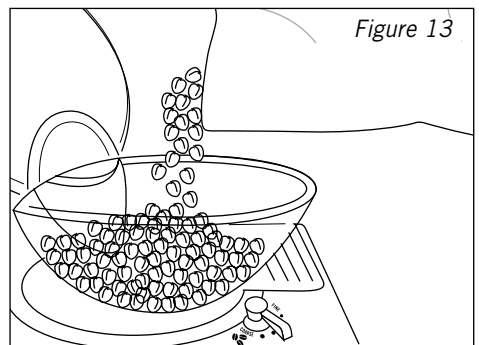
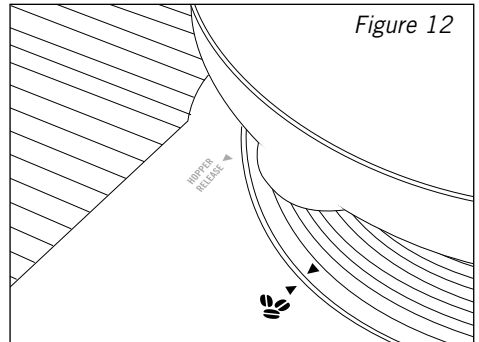



















Making an espresso with coffee beans (continued)

Placing cup(s) under the espresso pour spout and choosing the coffee pour volume

- Place one or two cups under the espresso pour spout. The height of the pour spout can be adjusted to suit the size of the cup by lifting or lowering the pour spout to reduce heat loss and or prevent the espresso from splashing. See figure 15.
- Press the 'coffee pour volume' button as many times as needed to reach the required pour length. See figure 16.

The Café Barista™ pour volumes are set as follows:

20mLs			
			
30mLs			
			
40mLs			
			

Tip: The Café Barista™ is set to standard volumes. If you want to adjust the respective pour volumes, please refer to the instructions in section 'Changing and saving coffee pour volumes and coffee strength settings'.

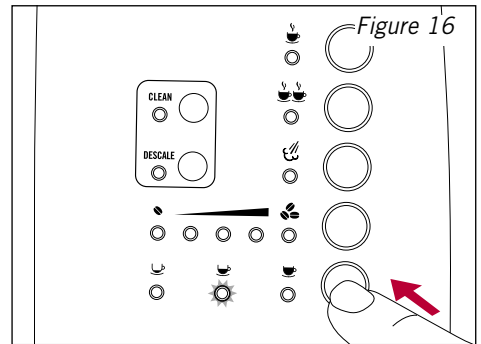
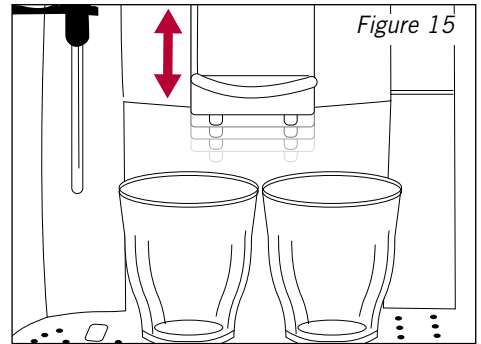

Making an espresso with coffee beans (continued)

Selecting the strength of the coffee and pouring the coffee

- Press the 'coffee strength/quantity' button as many times as needed to select the preferred strength of the espresso. See figure 17.

The coffee strengths are indicated as follows:

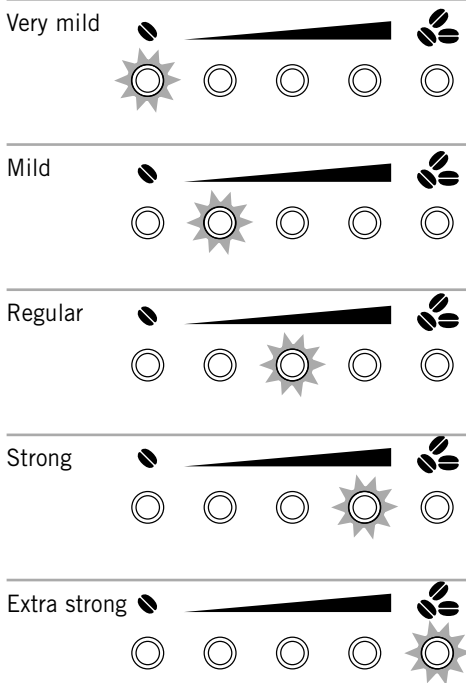

Tip: It is possible to save each of the 'coffee strength/quantity' settings with reference to the length of the 'coffee pour volumes', in order not to have to choose the 'coffee pour volume' every time the espresso machine is switched on. For instructions please refer to section 'Changing and saving coffee pour volumes and coffee strength settings'.

- Press the ☕ button if you want to pour one cup of coffee, see figure 18, or the ☕☕ button to pour 2 cups of coffee, see figure 19.

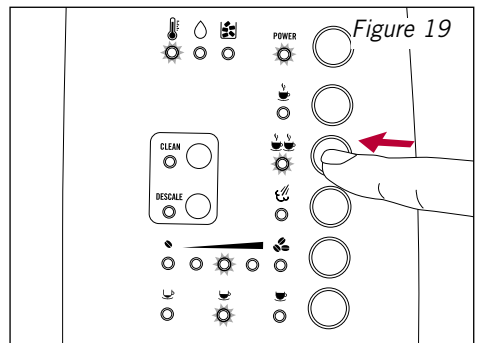
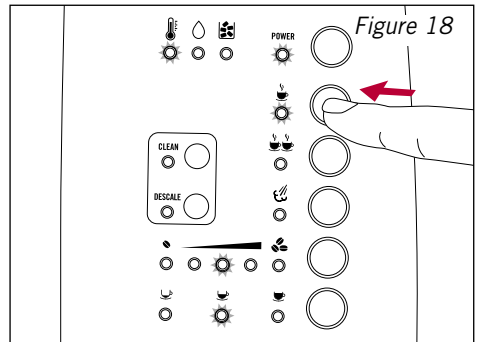
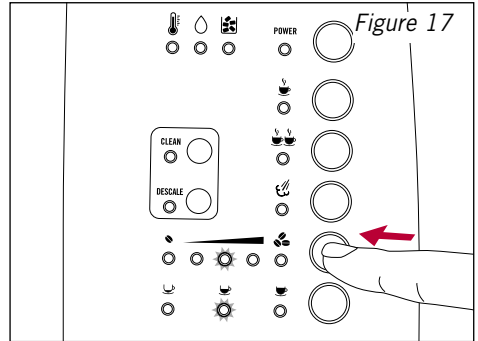

Making an espresso with coffee beans (continued)

Note: When choosing ☕☕ 2 cups of coffee, the pre-set values for 'coffee strength/quantity' to be ground and 'coffee pour volume' are increased automatically.

Note: Before the actual coffee brewing process, the ground coffee is dampened by a small amount of water. Known as pre-infusion, this helps in achieving maximum extraction of oils from the coffee grinds.

After a short pause the actual brewing process starts.

Note: You may stop the pour of coffee at any time by briefly pressing the ☕ 1 cup button or the ☕☕ 2 cup button, respectively, which you pressed before.

- The espresso is made.

Making an espresso with pre-ground coffee

Important: Please use only the supplied measuring spoon. Never fill the receptacle with more than 2 level measuring spoons of pre-ground coffee.

Important: Do not fill the receptacle with water-soluble or freeze-dried instant products or any other drink powders.

Filling the pre-ground coffee receptacle

- Turn the hopper so that the arrow on the base of the hopper is aligned with the ☕ pre-ground coffee arrow. See Figure 20.

Note: Ensure that the pre-ground coffee receptacle is dry. If it is moist from steam, wipe dry before adding any pre-ground coffee.

- When the pre-ground coffee setting has been selected all the indicators for the 'coffee strength' will illuminate. See figure 21.

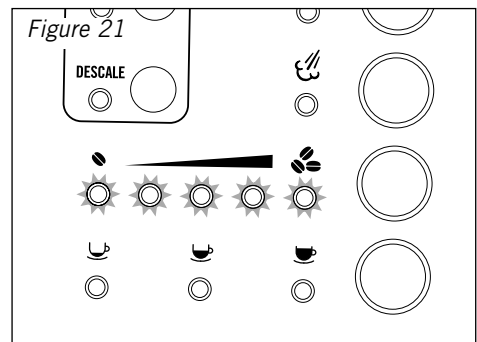
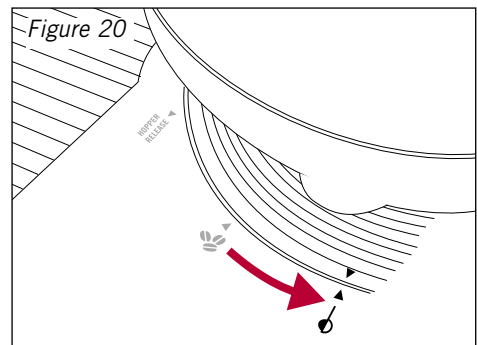

Making an espresso with pre-ground coffee (continued)

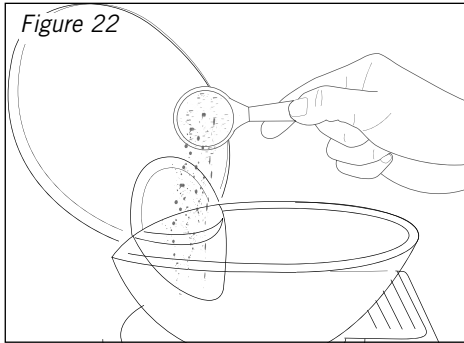

gets into the receptacle. Never fill with more than 2 level measuring spoons of pre-ground coffee. The filling receptacle is not a reservoir, so do not pre-fill. The pre-ground coffee must pass through directly to the coffee brewing unit.

- Leave the lid of the pre-ground coffee receptacle open.

Note: Only leave the pre-ground coffee receptacle lid open when using pre-ground coffee. When using coffee beans ensure that the lid to the pre-ground coffee receptacle is closed.

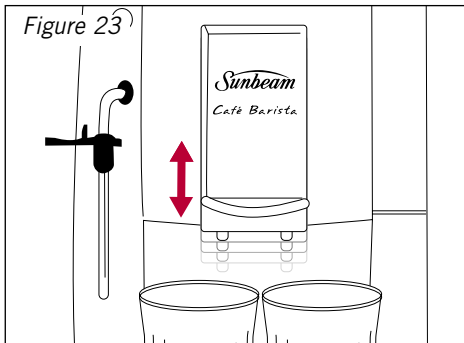

Placing cup(s) under the espresso pour spout, setting the 'coffee pour volume' and the espresso pour

- Place one or two cups under the espresso pour spout. The height of the pour spout can be adjusted to suit the cup by lifting or lowering the pour spout to reduce heat loss and or prevent the espresso from splashing. See figure 23.
- Press the 'coffee pour volume' button as many times as needed to reach the required volume of coffee. See figure 24.

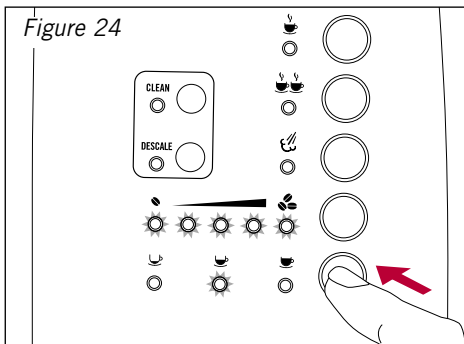

- Open the lid of the pre-ground coffee receptacle and fill with fresh pre-ground coffee. See figure 22.

Important: Make sure that no powder is stuck in the receptacle and that no foreign matter

The Café Barista™ coffee pour volumes are set as follows:

20mLs			
30mLs			
40mLs			

Making an espresso with pre-ground coffee (continued)

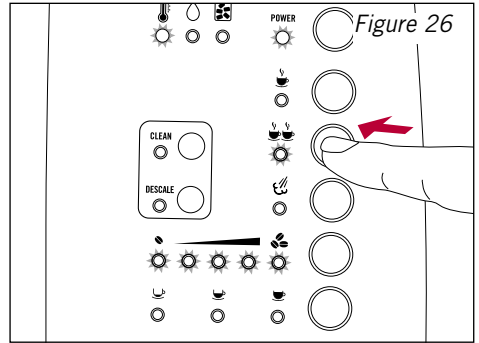
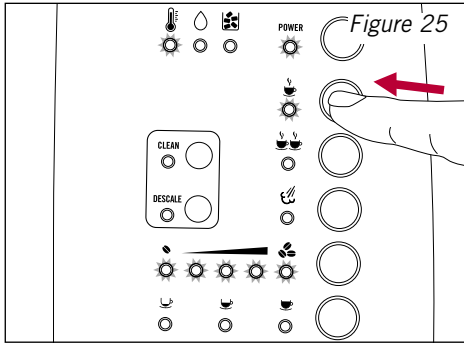

Tip: The Café Barista™ is factory set to standard volumes. If you want to adjust the respective length of coffee pour volumes, please refer to the instructions in section ‘Changing and saving coffee pour volumes and coffee strength settings’.

- Press the ☕ button if you want to pour one cup of coffee, see figure 25, or the ☕☕ button to pour 2 cups of coffee, see figure 26.

Note: When choosing ☕☕ 2 cups of coffee, the pre-set values for the ‘coffee strength/quantity’ and ‘coffee pour volume’ are increased accordingly.

Note: Before the actual coffee brewing process, the ground coffee is dampened by a small amount of water. Known as pre-infusion, this helps in achieving maximum extraction of oils from the coffee grinds. After a short pause the actual brewing process starts.

Note: You may stop the pour of coffee at any time by briefly pressing the ☕ 1 cup button or the ☕☕ 2 cup button, respectively, which you pressed before.

- The espresso is made.

Milk frothing using the steam function

The steam can be used for texturing/frothing milk or for heating liquids. As the temperature for generating steam must be higher than for making coffee, the espresso machine is equipped with an additional steam mode.

Important: There is risk of scalding when the steam nozzle is in use. Hot water or hot steam can cause scalding. Only use the steam nozzle when it is immersed in the milk.

- When wanting to froth milk, press the ☁ steam pre-selection button on the control panel, see figure 27. The ☁ steam pre-selection indicator illuminates and in addition the 🔥 indicator will start to flash, indicating that the espresso machine is heating. When heating is finished, the 🔥

indicator will stop flashing and remain constant. The espresso machine is now ready for texturing/frothing milk, see figure 28.

Note: If the steam function is not used for more than 1 minute, the espresso machine automatically switches back to coffee making mode.

- Pour cold milk into a stainless steel jug to no more than $\frac{1}{3}$ full.

Tip: For best results we recommend using refrigerated milk and a stainless steel jug that is well chilled. Be sure not to rinse the jug with warm water before use.

- Swing the steam nozzle out to the side of the machine and hold the jug under the steam nozzle so that the nozzle opening is completely immersed in the milk. Turn the

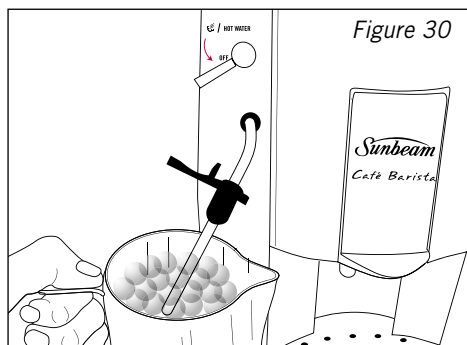
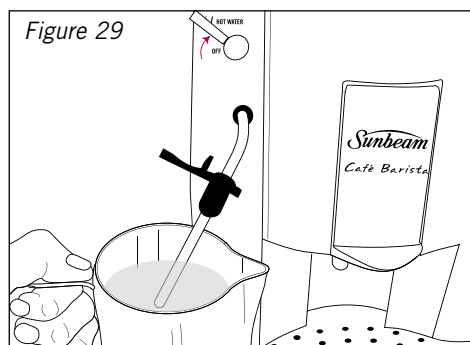
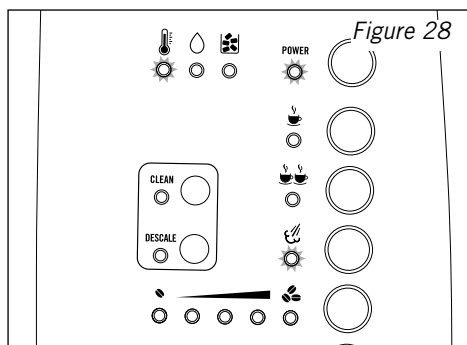
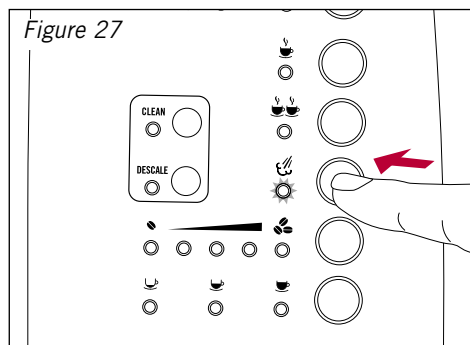

Milk frothing using the steam function (continued)

'steam/hot water' switch up to activate the steam and commence frothing the milk. See figure 29.

Tip: For instructions on how to froth milk refer to the section 'Easy steps for frothing milk'.

Note: The nozzle must not touch the bottom of the jug to ensure that the steam release is not obstructed.

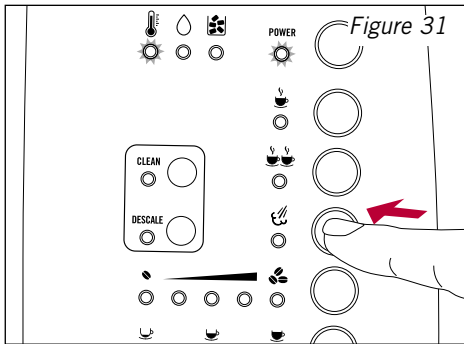

- To stop the frothing process, turn the 'steam/hot water' switch down into the 'off' position and then remove the jug. See figure 30.

Important: There is risk of scalding by splashing hot milk. Switch the steam off before you remove the jug with the frothed milk.

- Deselect the steam mode by pressing the steam pre-selection button, the indicator light will turn off and the appliance is now ready again for making coffee. See figure 31.

Tip: After steaming and the steam mode has been deselected on the control panel, turn the 'steam/hot water' switch up and allow hot water to run out for a couple of seconds. This will help the temperature of the espresso machine return to coffee making temperature and also prevent milk remains from drying inside the steam nozzle and therefore blocking the nozzle. Be sure to place a cup of some kind under the steam nozzle when doing this.

Easy steps for frothing milk

Milk texturing is the steaming of milk to heat it and to create froth. Similar to making an espresso, perfecting the art of milk texturing takes time and practice.

- Use fresh, cold milk and fill a stainless steel frothing jug to no more than $\frac{1}{3}$ full.
- The amount of milk you steam should be adequate for the coffees you are preparing. Keep in mind that the volume of milk will increase or 'stretch' during the texturing process.
- Once you have activated the steam and inserted the steam nozzle into the jug, position the steam arm $1\frac{1}{2}$ cm from the side of the jug with the tip of the nozzle just below the surface of the milk. The jug needs to be at a slight angle with the steam arm resting on the spout of the jug. This will create a whirlwind motion in the milk.

Note: You should hear a hissing sound. If you are creating large bubbles, raise the jug so that the nozzle tip is lowered deeper into the milk.

- As the steam heats the milk, the milk will begin to rise. Follow the level of the milk by lowering the jug, always keeping the tip of the steam nozzle just below the surface.
- Once the milk has stretched to double its original volume, lower the steam nozzle further into the milk and continue to heat the milk. This will give the milk a fine texture and not a mass of large aerated bubbles.
- Cease steaming when the frothing jug becomes too hot to hold your hand against it.
- With the frothing jug in hand, swirl and tap the jug until the milk becomes shiny and no bubbles remain, this ensures an even consistency. Pour the textured milk into your espresso as soon as possible.

Frothing with the frothing attachment

If you are just learning to texture/froth milk you may find it initially easier using the frothing attachment packed with the Café Barista™. Once you have had some practice in texturing/frothing milk, we recommend not to use the frothing attachment as you will have greater control of the texture and temperature of the milk.

- Attach the frothing attachment to the steam arm.
- Once you have activated the steam, insert the steam arm with the frothing attachment into the jug. Position the steam arm $1\frac{1}{2}$ cm from the side of the jug with the frothing attachment completely immersed in the milk, so the tip of the frothing attachment is held just above the base of the jug.
- Hold the frothing attachment in this position until the milk has stretched to double its original volume. Cease steaming when the frothing jug becomes too hot to hold your hand against it.

Important cleaning instructions for the steam nozzle

The steam nozzle needs to be cleaned each time you steam milk. To clean the steam nozzle, wipe with a damp cloth.

Note: Should the steam nozzle become blocked, using a pin or a thin wire, insert it into the hole in the base of the steam nozzle.

Note: When using the frothing attachment, after use remove from the steam arm and clean with hot soapy water to prevent the build up of dried milk.

Hot water function

The hot water function can be used for making tea, hot chocolate or other hot water drinks such as instant soups.

Important: There is risk of scalding when the steam nozzle is in use. Hot water or hot steam can cause scalding. Only use the steam nozzle when holding a container underneath.

- Place a cup or container under the steam nozzle and turn the 'steam/hot water' switch up to activate the hot water. See figure 32.
- As soon as you have dispensed the required amount of hot water, turn the 'steam/hot water' switch down into the 'off' position and then remove the cup or container. See figure 33.

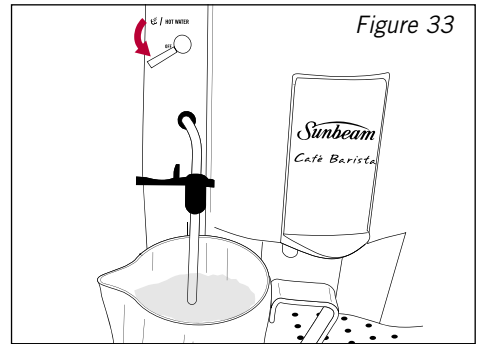
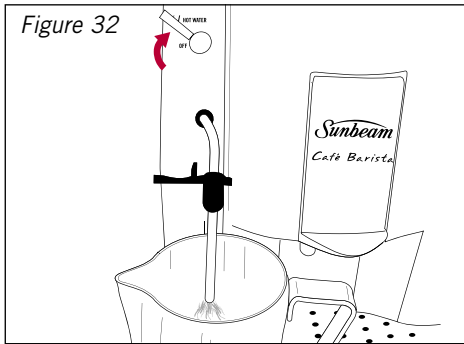

Changing and saving coffee pour volumes and coffee strength settings

The Café Barista™ is set to standard coffee pour volumes. These volumes can be individually adjusted to your taste and stored.

Changing and saving coffee pour volumes

- Press the 'length of coffee pour' button until the respective cup symbol illuminates corresponding to the desired coffee pour volume. See figure 34.
- Place a cup under the espresso pour spout. See figure 35.
- Then press the ☕ one cup coffee button and keep it depressed until the desired coffee pour volume is reached. See figure 36. Release the button and your desired coffee pour volume has been saved.

Tip: Repeat this procedure if you want to adjust the coffee pour volumes of the other cup settings.

Note: The volumes saved remain valid even if the espresso machine is switched off. If the size of your cup or your taste changes, you may individually adapt the coffee pour volume at any time.

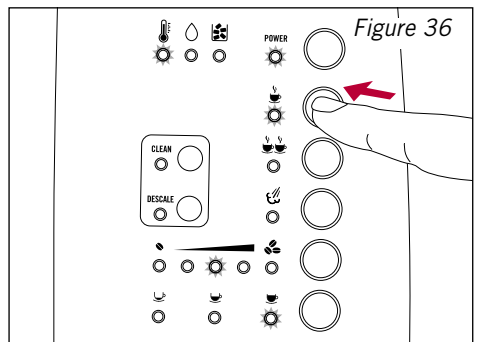
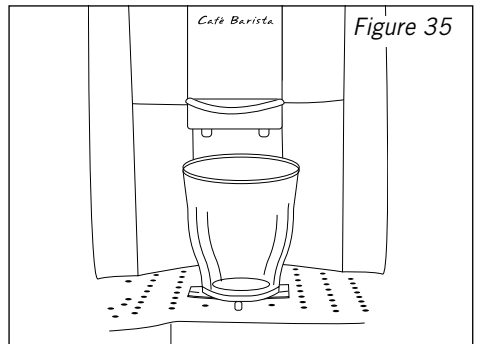
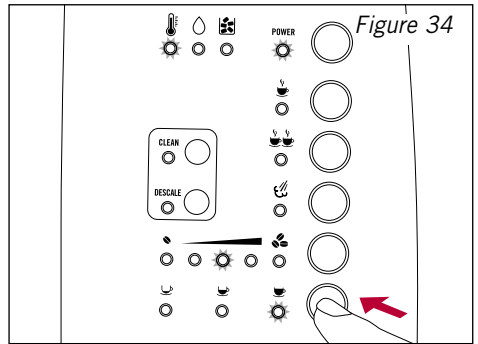

Changing and saving coffee pour volumes and coffee strength settings (continued)

Changing and saving the set relationship between each 'coffee strength' setting and the 'length of coffee pour' volumes

You may save a different 'coffee strength' setting for each 'length of coffee pour' setting.

- Press the 'length of coffee pour' button as many times as needed to reach the required cup symbol. See figure 37.
- Then press the 'coffee strength selector' button as many times as needed until the indicator of the chosen coffee strength illuminates and keep the button depressed. See figure 38.
- After a few seconds of holding the button depressed, all indicators are lit permanently, except the one chosen. See figure 39. Now let the button go.

Tip: Repeat this procedure if you want to save the 'coffee strength' settings for the remaining cup symbols too.

Note: The values saved remain even if the espresso machine is switched off.

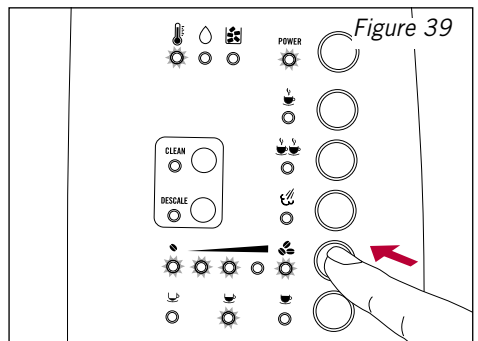
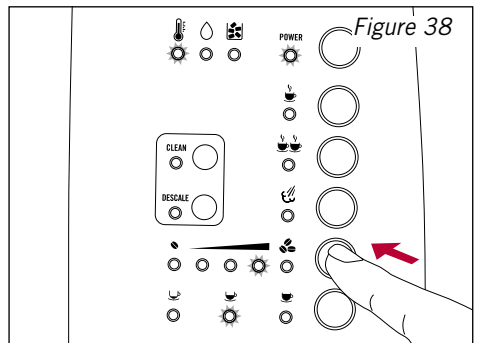
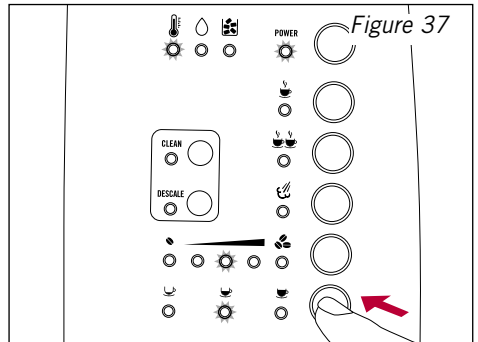

Grind setting selection and maintenance

Important: Only adjust the fineness of the grind during the grinding process. Adjustments of the grind while not in use may cause damage to the espresso machine.

Setting the fineness of the grind

- With a cup placed under the espresso pour spout, press the ☕ one cup coffee button. While the grinding process is running, adjust the fineness of the grind using the 'coffee grind selector' lever. See figure 40.

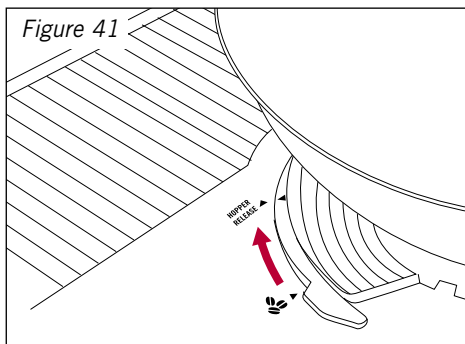
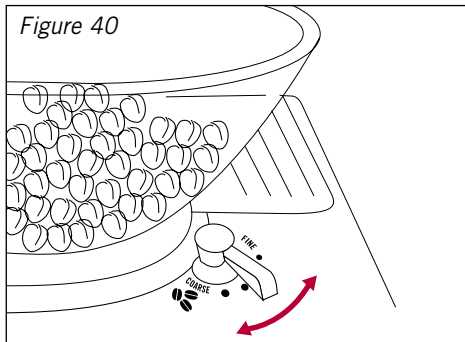

Removing foreign matter from the grinding mechanism

Foreign matter in the grinder, e.g. small stones or wood chips, may cause damage to the grinding mechanism.

The Café Barista™ is designed with a 'stone safety device' which, in case of foreign matter, causes an even, loud rattling. If you should hear this noise during grinding, switch the espresso machine off immediately and remove the foreign matter as follows:

Cleaning the grinding mechanism

- Switch the espresso machine off by pressing the 'POWER' button and unplug the power cord from the power outlet.
- Turn the 'coffee bean hopper' to the position marked 'HOPPER RELEASE' and take it off. See figure 41.
- Remove the any coffee beans in the grinding mechanism. We suggest using the cleaning brush supplied with the Café Barista™ (or, possibly a vacuum cleaner with a hose or nozzle). See figure 42. If any foreign matter cannot be removed, proceed with the next step.
- Slide the 'grinding mechanism release' button to the front in the direction of the grinding mechanism. Hold this position and turn the 'coffee grind' lever clockwise by approximately 1 revolution up to the stop. See figure 43.
- Now detach the grinding ring by lifting it out and remove any foreign matter(s). See figure 44.

Important: There is risk of injury by turning grinding gear. Never switch the espresso machine on while working with the grinding mechanism. This may cause severe injury. Always unplug the power cord from the power outlet.

Grind setting selection and maintenance (continued)

- Replace the grinding ring.
- Slide the 'grinding mechanism release' button to the front in the direction of the grinding mechanism. Hold this position and turn the 'coffee grind' lever anti-clockwise to the desired grind setting.
- Replace the 'coffee bean hopper' in position 'HOPPER RELEASE' and turn it to the coffee beans position. Now test the function of the grinding mechanism with a small quantity of beans and make a cup of coffee.

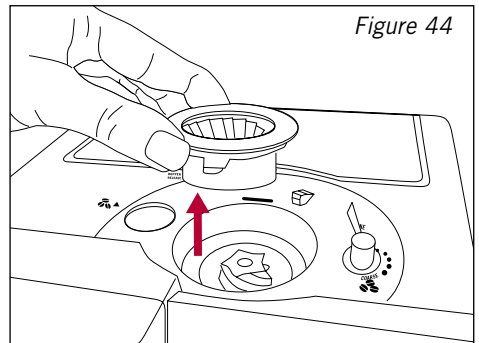
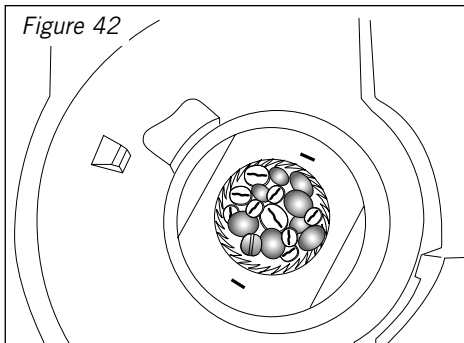
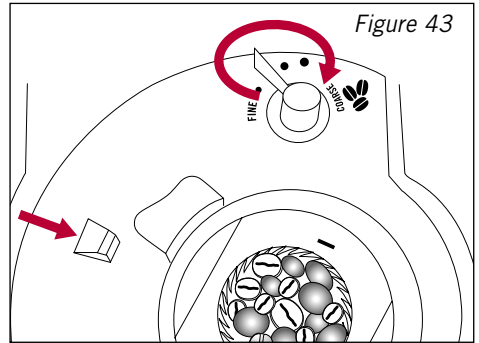

Resetting the Café Barista™

With this function, all previously changed values can be reverted back to the original settings for the Café Barista™.

- Press buttons 'CLEAN' and 'DESCALE' simultaneously. Hold the buttons depressed until all the lights on the control panel turn off (takes approximately 3 seconds). Release the 'CLEAN' and 'DESCALE' buttons and the Café Barista™ is now reset.

Care and cleaning

Note: When the espresso machine is turned on it will go through an Auto Clean cycle. This removes any old coffee grinds from the coffee brewing unit.

The coffee making process involves extracting oils out of coffee grinds to make espresso coffee. Deposits of these oils build up over time and affect the taste of the coffee and operation of the espresso machine.

Regular cleaning of the Café Barista™ guarantees a constant coffee quality and a trouble-free operation.

Regular cleaning

Important: Switch the espresso machine off before cleaning. Let the espresso machine cool down. Do not use scratching, scouring or corrosive agents. Clean the housing inside and outside with a damp cloth only.

Important: Never put the espresso machine or parts of the espresso machine into the dishwasher.

Important: Never pour water into the coffee bean hopper as you will damage the grinding mechanism.

Important: To prevent damage to the espresso machine do not use alkaline cleaning agents when cleaning, use a soft cloth and a mild detergent.

- Clean the drip tray, cup resting grid, coffee waste container and water reservoir with warm soapy water. Rinse and dry thoroughly, be sure to rinse the water reservoir with fresh water.
- Remove the coffee bean hopper from time to time, dispose of the coffee residue and give it a wipe to remove the film of oil from the coffee beans.
- Empty drip tray regularly. However be sure to take note of the red floating level indicator, once which appears through the cup resting grid, empty the drip tray immediately.
- The steam nozzle and frothing attachment need to be cleaned after each frothing process. To clean the steam nozzle, simply wipe clean with a damp cloth. When using the frothing attachment, after each use remove it from the steam nozzle and clean thoroughly in warm water to remove milk remains. Additionally, should the air inlet at the base of the steam nozzle become blocked, open it using a pin or a thin piece of wire.

After making approximately 16 coffees, the  coffee waste container indicator will illuminate to show that the container must be emptied and cleaned.

Note: If the espresso machine is used daily, the coffee waste container should also be cleaned daily. You will always be

Cleaning the coffee brewing unit

We recommend that you clean the brewing unit (depending on intensity of use) regularly, however at the very latest, before the cleaning programme is started. If your espresso machine is left unused for long periods of time (e.g. holidays), it is necessary to empty the coffee waste container and water reservoir and to thoroughly clean the espresso machine, including the coffee brewing unit.

Removing the coffee brewing unit

- Switch the Café Barista™ off by pressing the 'POWER' button and unplug the power cord from the power outlet.
- Remove the coffee waste container from the espresso machine. See figure 45.
- Press the release button on the top of the service door. The service door opens to the front. See figures 46 and 47.
- The coffee brewing unit is situated behind the service door. The 3 red-coloured elements serve for locking/unlocking. See figure 48.

- To remove the coffee brewing unit activate the locking elements in the following sequence:

1. Push the locking lever upwards, see figure 49.
2. Press the safety button and keep it depressed, see figure 49.
3. Press the locking button down, keep it depressed and pull the coffee brewing unit out, see figures 49 and 50.

Cleaning the coffee brewing unit and inserting the brewing unit

- Open the coffee brewing unit by turning the white service lever downwards as far as it will go. Both sieves are easily accessible now and the ejection lever folds down. See figure 51.
- Clean the coffee brewing unit under warm running water, particularly the stainless steel sieves must be well rinsed and cleaned of coffee remains. See figure 52.

Cleaning the coffee brewing unit (continued)

- Dry the coffee brewing unit and turn the service lever upwards again as far as it will go. The ejection lever folds back again and the brewing unit closes. See figure 53.

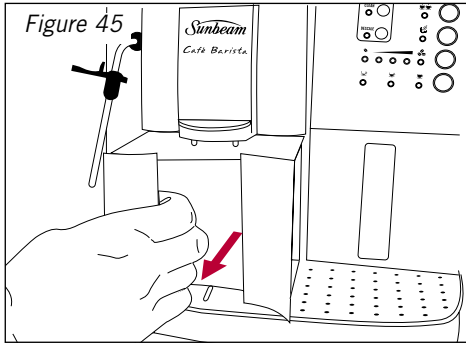

- Re-insert the coffee brewing unit as follows:
 1. Place the coffee brewing unit onto the guide bar and push the coffee brewing unit into the appliance as far as it will go, see figure 54.

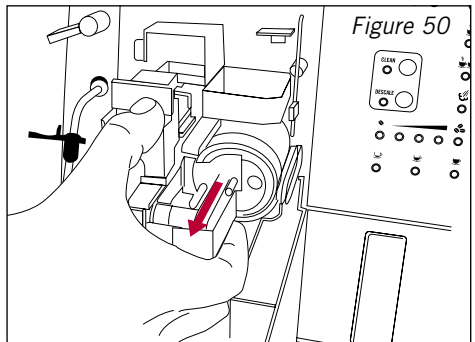
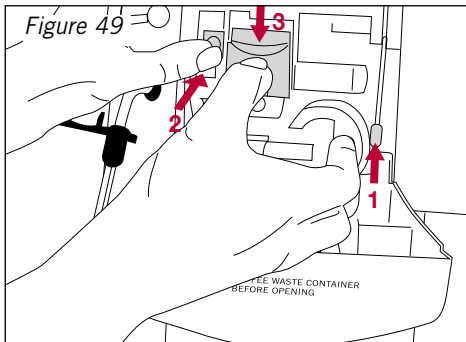
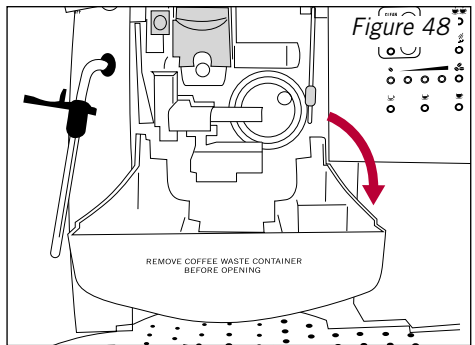
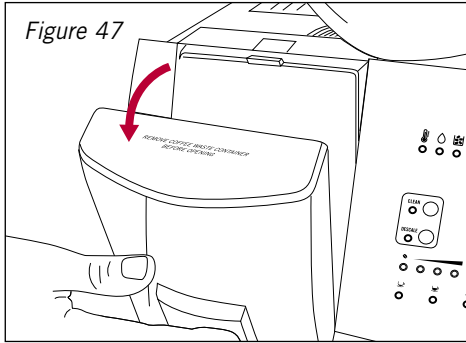
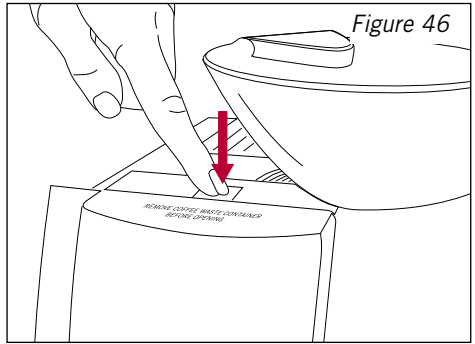

Cleaning the coffee brewing unit (continued)

2. Press the locking button down and push the coffee brewing unit further in for approximately 1cm until the locking button clicks into place, see figure 55.
 3. Press the locking lever down as far as it will go, see figure 55.
- Close the service door and re-insert the coffee waste container.

Note: The Café Barista™ can only be switched on if the service door is closed. After switching on, the coffee brewing unit re-adjusts itself, the normal heating process starts again.

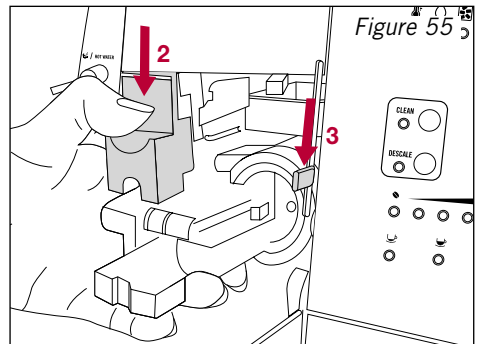
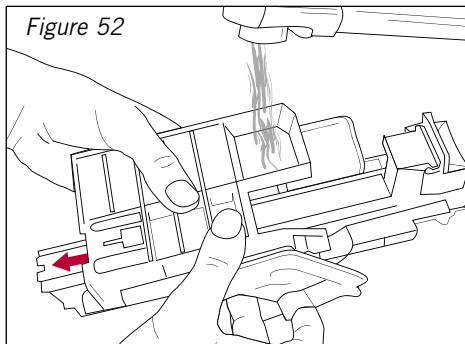
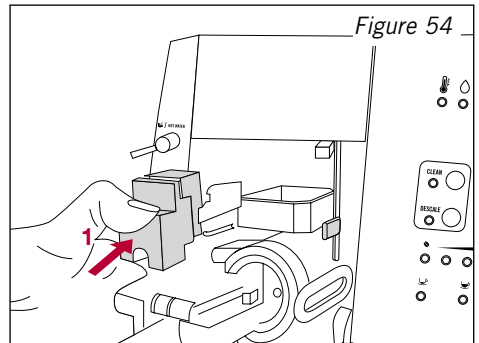
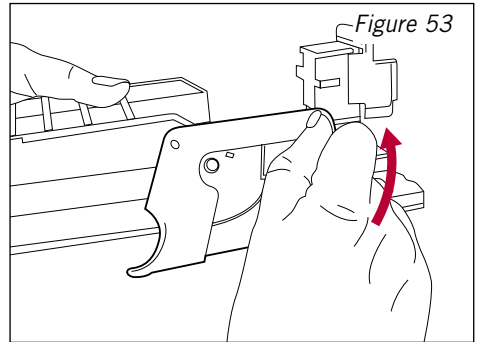
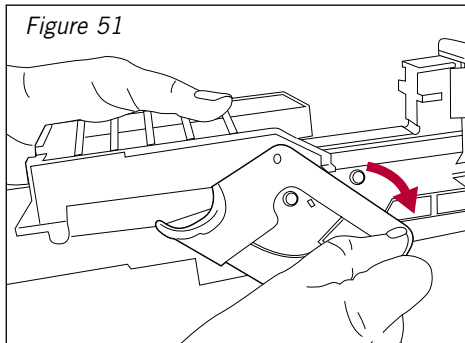

Starting the cleaning programme

The cleaning programme allows complete removal of coffee oils even in areas which are not normally accessible. Start the cleaning programme at the latest when the 'CLEAN' indicator begins to flash.

The cleaning process takes about 8 minutes and should not be interrupted. If it is interrupted the cleaning process has to be started again.

Important: Prior to starting the cleaning programme, clean the coffee brewing unit and empty the coffee waste container. Refill the water reservoir with approximately 1 litre of fresh water.

Important: Use the Sunbeam 'Cleaning' tablets only. If using other cleaning agents, Sunbeam will not be liable for any damage. Sunbeam cleaning tablets are available from selected appliance retailers or from Sunbeam on 1800 025 059.

- Turn the coffee bean hopper to the ☐ pre-ground coffee position. Wait until the mechanism has adjusted itself and all the indicators of the coffee strength settings are illuminated. See figure 56.
- Pull the empty coffee waste container out and position below the coffee pour spout. It will serve as a collecting container for the cleaning water. The ☒ coffee waste container indicator will illuminate as long as the container is pulled out. See figure 57.
- Drop a cleaning tablet into the pre-ground coffee receptacle, press and hold for 3 seconds the 'CLEAN' button, the 'CLEAN' indicator changes from a flashing light to a constant light. The cleaning programme will commence, the process should not be interrupted. See figure 58.

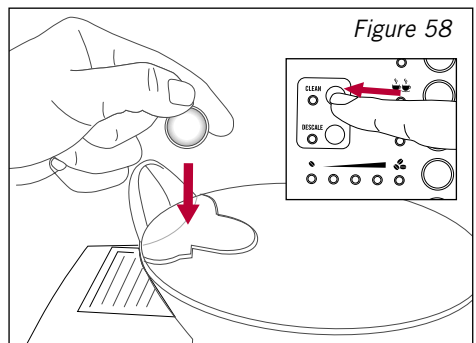
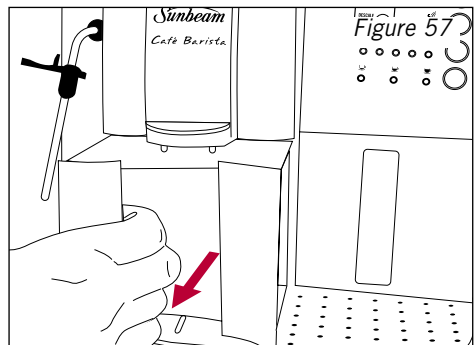
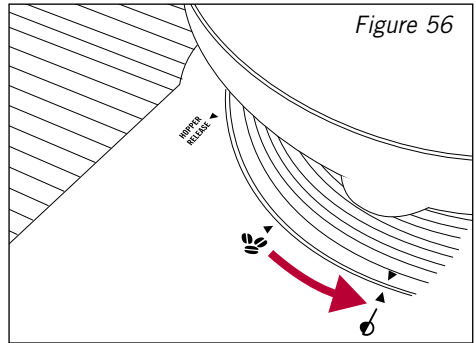

Starting the cleaning programme (continued)

Important: The ☕ coffee waste container indicator will remain illuminated while the cleaning process is running. The programme carries out 6 cycles with fresh water flushing. Pause times are for the cleaning tablet to take effect. In case of a power failure the programme has to be started again.

- The cleaning process is finished after approximately 8 minutes and when the 'CLEAN' indicator is illuminated and the ☕ coffee waste container indicator flashes.

- Empty the coffee waste container and reinsert it so that the ☕ coffee waste container indicator extinguishes. Turn the coffee bean hopper to the desired position and fill the water reservoir.
- Press the ☕ one cup or ☕☕ two cup coffee button and discard/pour away this first cup after running the cleaning programme. You are now ready for operation again.

Important: Take care when removing the coffee waste container as the water may be hot.

Starting the descaling programme

The descaling programme allows for simple and effective descaling of the espresso machine. Scale is a surface build up of minerals that naturally occur over time in all appliances that are involved with the heating of water.

The Café Barista™ should be descaled at regular intervals of 4 – 6 months, at the latest however when the 'DESCALE' indicator begins flashing. The descaling process is carried out in 2 phases, takes 45 minutes and should not be interrupted. If the programme is interrupted, the descaling process has to be started again.

Important: Prior to starting the descaling programme, clean the coffee brewing unit and empty the coffee waste container.

Important: Use Sunbeam descaling tablets only. If using other descaling agents, Sunbeam will not be liable for any damage. Never use vinegar, citric acid or sulfamic acid

or descaling agents containing sulfamic acid as these agents may damage the espresso machine.

Sunbeam descaling tablets are available from selected appliance retailers or from Sunbeam on 1800 025 059.

Phase 1: Descaling

- Fill the water reservoir with approximately 400mL of warm water until the level is just below the grooves of the reservoir lid and put a descaling tablet into the reservoir. See figure 59. Re-insert the reservoir when the tablet has dissolved, this takes about 5 -7 minutes.
- Pull the empty coffee waste container out and position below the espresso pour spout so that the descaling solution is collected in the coffee waste container. The ☕ coffee waste container indicator will illuminate as long as the container is pulled out. See figure 60.

Starting the descaling programme (continued)

- Press and hold for 3 seconds the 'DESCALE' button, the 'DESCALE' indicator changes from a flashing light to a constant light. The descaling programme is now ready and the process should not be interrupted. See figure 61.

Note: Before the automatic process starts you must descale the steam/hot water nozzle.

- Place a container under the steam/hot water nozzle. The container should hold at least 200mL. Turn the steam/hot water switch up. Leave the switch up until the pump switches off and no descaling solution emerges from the nozzle. See figure 62.

- Turn the steam/hot water switch to the 'off' position and the automatic descaling process of the brewing unit starts. See figure 63.

Note: The 'DESCALE' indicator remains illuminated during the descaling process. The programme is carried out in 2 phases; phase 1 descaling phase with 12 cycles as well as phase 2 rinsing phase. Between the two phases, the coffee waste container must be emptied and the water reservoir must be refilled with water. In case of power failure the programme has to be restarted.

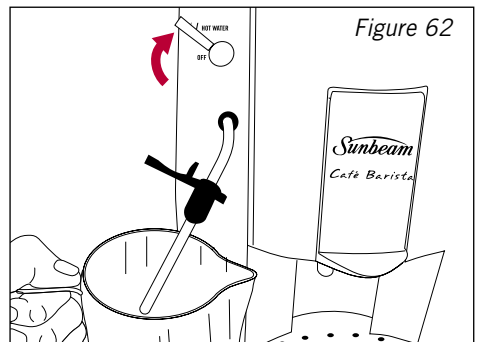
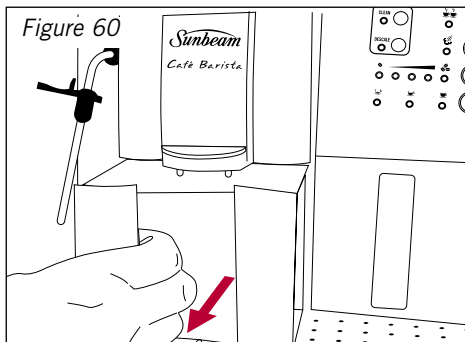
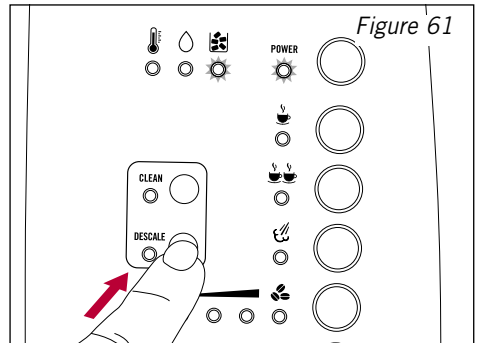
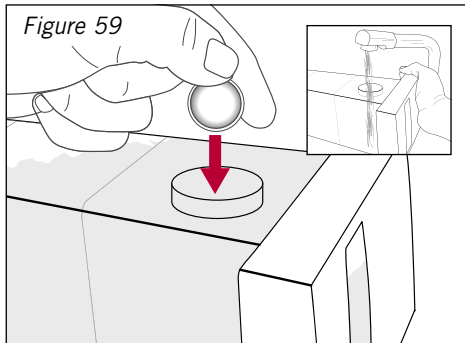

Starting the descaling programme (continued)

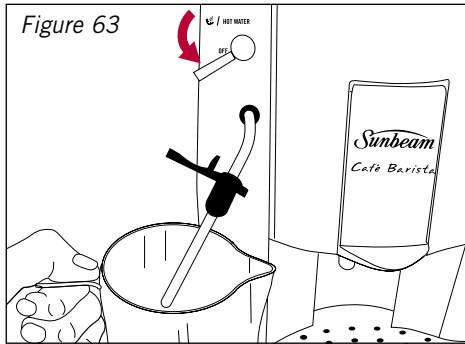



- Rinse the water reservoir and fill it with 1 litre of fresh water. Empty the coffee waste container and push it into the espresso machine only so far so that water from the espresso pour spout can flow into the coffee waste container. See figure 60.

Phase 2: Rinsing

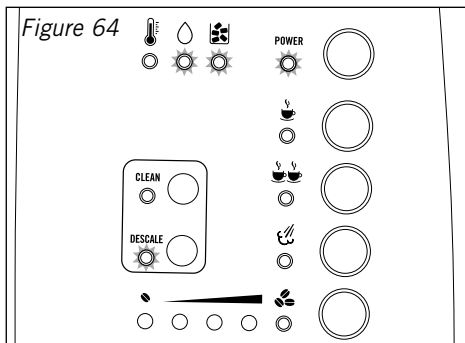
- Place a container under the steam/hot water nozzle. The container should hold at least 200mL. Turn the steam/hot water switch up. Leave the switch up until the pump switches off and no descaling solution emerges from the nozzle. See figure 62.
- Turn the steam/hot water switch to the 'off' position. See figure 63.
- After this, the automatic fresh water rinsing process of the coffee brewing unit starts, this takes about 5 minutes.
- The rinsing process and thus the complete descaling programme are finished when the coffee waste container indicator is flashing.
- Empty the coffee waste container. Thoroughly rinse the water reservoir and fill it with fresh water. The Café Barista™ is now ready for operation again.











Preparing the appliance for phase 2

Phase 1 of the descaling process is finished after approximately 36 minutes and is shown by the  water and  coffee waste container indicators flashing. The 'DESCALE' indicator also flashes. See figure 64.

Important: Take care when removing the coffee waste container as the water may be hot.

Note: We recommend pouring away the first cup of coffee made after running the descaling programme and discarding it.

Indicator Lights Guide

INDICATOR	PROBLEM	POSSIBLE CAUSE	WHAT TO DO
<p>Water indicator is flashing</p> 	The espresso making process is interrupted.	Water reservoir is empty.	Refill the water reservoir and press the 1 cup or 2 cup coffee request button again.
		Coffee is ground too finely.	Clean the brewing unit and adjust the fineness of the grind. See page 29, Cleaning the coffee brewing unit.
<p>Coffee waste container indicator is flashing</p> 	The espresso making function cannot be used.	Coffee waste container is full.	Empty the coffee waste container and rinse.
<p>Cleaning programme indicator is flashing</p> 	The espresso making function cannot be used.	The machine needs cleaning.	See page 32, Starting the cleaning programme.
<p>Descaling programme indicator is flashing</p> 	The espresso making function cannot be used.	The machine needs descaling.	See page 33, Starting the descaling programme.
<p>Coffee strength /quantity indicator</p>  <p>and  or  cup coffee request indicators flashing</p>	The machine cannot be used.	Brewing unit is blocked.	Clean the brewing unit. See page 29, Cleaning the coffee brewing unit. Adjust the fineness of the grind. See page 26, Setting the fineness of the grind.
<p>Coffee strength indicators</p>  <p>and  or  cup coffee request indicators flashing</p>	The machine cannot be used.	The brewing unit is too full.	Clean the brewing unit. See page 29, Cleaning the coffee brewing unit.

Trouble Shooting Guide

PROBLEM	POSSIBLE CAUSE	WHAT TO DO
Espresso/coffee is not hot enough	The internal brewing system is cold.	The first cup is always colder than any following cups as the brewing unit has to warm up. Heat the brewing unit by running the 8 minute cleaning programme without using the cleaning tablet. See page 32, Starting the cleaning programme.
	The cups have not been pre-heated.	Before making an espresso, fill the glass or glasses with hot water. Once you are ready to pour the espresso discard the hot water. This will quickly heat the glasses and significantly improve and retain the drinking temperature of the espresso.
Espresso/coffee not strong enough	The coffee bean hopper is empty.	Refill the hopper with coffee beans.
	The grind setting is too coarse.	Adjust the grind selector to a finer setting. See page 26, Setting the fineness of the grind.
	The setting for the coffee strength/quantity is too low.	Select a higher setting of the coffee strength/quantity. See page 16, Selecting the strength of the coffee.
	Not enough pre-ground coffee used.	Use the correct amount of pre-ground coffee – 2 level measuring spoons.
Espresso/coffee pour is too slow	The coffee grind setting is too fine.	Adjust the grind selector to a coarser setting. See page 26, Setting the fineness of the grind.
Espresso/coffee pour is too fast	The coffee grind setting is too coarse.	Adjust the grind selector to a finer setting. See page 26, Setting the fineness of the grind.
Espresso/coffee pour is uneven	The espresso pour spouts are clogged.	While the espresso is pouring reposition the adjustable espresso pour spout, down or up. Alternatively remove the adjustable espresso pour spout, rinse under running water and with a pin scrape away any built up coffee remains.

Trouble Shooting Guide continued

PROBLEM	POSSIBLE CAUSE	WHAT TO DO
No espresso/coffee, only water is running out	Foreign matter is caught in the grinding mechanism stopping the beans from moving through the grinder.	Turn the machine off and remove the hopper. Clean away any coffee beans in and around the grinding mechanism. Remove the grinding ring and with the cleaning brush or tweezers remove any foreign matter. See page 26, Removing foreign matter from the grinding mechanism.
	Coffee bean hopper is not fitted correctly.	The grinder is working however there is no sound of coffee beans grinding. Remove the hopper and empty the coffee beans into a container. Replace the hopper onto the grinding mechanism, check that the lock on the base of the hopper opens once it is in the coffee bean position, if it remains closed while turning the hopper, remove the hopper and try engaging it again. Therefore push down on the hopper with pressure, whilst turning.
	Brewing unit is not in the correct position.	Should the grinder be working normally, remove the coffee waste container after the espresso making process and check to see if there is any freshly ground coffee. In this case turn the machine off, remove and clean the brewing unit.
No espresso/coffee, only water is running out when using pre-ground coffee.	Coffee bean hopper is not in the correct position.	Adjust the hopper so that the arrow on the base of hopper is aligned with the pre-ground coffee arrow.
	The pre-ground coffee receptacle was filled when the machine was switched off.	When the machine is turned on it will go through an Auto Clean cycle, this will discard any coffee grinds from the coffee brewing unit. Therefore ensure the machine is on and in the pre-ground position before adding coffee.

Trouble Shooting Guide continued

PROBLEM	POSSIBLE CAUSE	WHAT TO DO
	The coffee brewing unit has not adjusted correctly and remains closed, therefore the coffee falls beside.	Ensure that when the hopper is moved to the pre-ground coffee position that prior to adding the coffee you have waited for the programmed mechanical adjustment of the brewing unit.
	The pre-ground coffee is stuck to the sides of the coffee shaft.	After the machine has been used the steam from the brewing process will moisten the sides of the pre-ground coffee shaft which causes the coffee grinds to stick to the sides. Use a piece of paper towel or cloth to dry the pre-ground coffee receptacle and shaft. Alternatively use the cleaning brush to push down the coffee.
No espresso/coffee pours through	No water in the water reservoir.	Fill the reservoir with water.
	The water reservoir is not correctly engaged.	Slide the water reservoir in and press firmly into place to ensure the valve of the water reservoir opens.
	The steam pre-selection button is activated.	Press the steam pre-selection button to turn the steam function off.
Espresso/coffee tastes burnt	Temperature of the heating system is too hot.	Prior to starting the espresso brewing process, turn the steam/hot water switch up and allow hot water to run through the steam arm/wand until there is a steady flow of hot water and no large amount of steam is present.
	Type of coffee being used.	Experiment with different brands and styles of coffee.
No steam comes from the steam arm/wand	Steam arm/wand is blocked.	Using a pin or a thin wire, insert it into the hole in the base of the steam nozzle.
Not enough froth when texturing the milk	Milk is too warm or too old.	Ensure the milk is well refrigerated before use and that the milk is fresh.

Trouble Shooting Guide continued

Problem	Possible cause	What to do
Not enough froth when texturing the milk	Frothing jug.	For best texturing results use a stainless steel jug and if possible refrigerate or run the jug under cold water before use.
	During the texturing process the milk has been over heated and boiled.	Start again with fresh, chilled milk.
The brewing unit cannot be removed	The brewing unit is not in its normal position.	Leave the machine switched on and adjust the coffee bean hopper to the pre-ground coffee position. Then switch off the machine and remove the brewing unit. See page 29, Removing the coffee brewing unit.
The brewing unit cannot be inserted	Brewing unit is not closed correctly.	Turn the white service lever upwards as far as it will go. The ejection lever will fold back and the brewing unit closes. See page 29, Inserting the brewing unit.
	The locking lever behind the service door is not in the up position.	Push the locking lever upwards and insert the brewing unit. See page 29, Inserting the brewing unit.

Recipes

ESPRESSO (SHORT BLACK)

Espresso is a concentrated, full bodied coffee with a stable layer of cream on top – known as 'crema'. An espresso is the foundation of all café coffee. Variations are achieved by adding different amounts of milk and froth.

- 90mL espresso glass or demitasse cup
- single espresso (30-35mL)



LONG BLACK

A standard espresso with hot water, served in a regular coffee cup or mug. The hot water is added first so that the 'crema' is maintained.

- 190mL cup
- hot water (to taste)
- single or double espresso



MACCHIATO

Macchiato, Italian for 'to stain or mark'. Traditionally served as a standard espresso with a dash of milk and a small dollop of froth into the middle of the 'crema'.

- 90mL espresso glass or demitasse cup
- single or double espresso
- marked with steamed milk froth



FLAT WHITE

Another old favourite, the Flat White is an espresso with steamed milk, served in a regular coffee cup or mug. The layer of frothed milk on top should be 2mm to seal the coffee.

- 190mL cup
- single or double espresso
- steamed milk



Recipes (continued)

CAFFE LATTE

An espresso with steamed milk, typically served in a glass. The layer of frothed milk on top should be 10mm to seal the coffee.

- 220mL glass or cup
- single or double espresso
- steamed milk



CAPPUCCINO

This delicious drink is an espresso with steamed milk, topped with creamy froth and a dusting of chocolate. The resulting drink is approximately two-thirds milky coffee, one-third froth.

- 190-240mL cup
- single or double espresso
- two-thirds milky coffee, one-third froth
- dusted with chocolate



CAFFE MOCHA

Made in a similar way to a cappuccino but with the addition of drinking chocolate. Simply stir the chocolate into the espresso prior to adding the steamed milk and froth.

- 190-240mL cup or tall glass
- single or double espresso
- two teaspoons of drinking chocolate
- two-thirds milky coffee, one-third froth



CON PANNA

A variation on the original Vienna coffee, this delicious drink is made up of an espresso topped with lightly whipped cream. It can also be dusted with cinnamon or drinking chocolate.

- 190mL cup
- single or double espresso
- lightly whipped cream
- dusted with cinnamon or chocolate



'Sunbeam' is a registered trademark of Sunbeam Corporation. Café Barista is a trademark of Sunbeam Corporation.

Made in China. Engineered in Australia. Due to minor changes in design or otherwise, the product may differ from the one shown in this leaflet. Backed by Sunbeam's 12 Month Repair Guarantee and National Service Network.

© Copyright. SUNBEAM CORPORATION LIMITED 2004.

(INCORPORATED IN N.S.W.) A.C.N. 000 006 771

For more information or advice on this or any other Sunbeam appliance, visit **www.sunbeam.com.au** or contact the Sunbeam Consumer Service Line. **Australia 1800 025 059 New Zealand 0800 786 232.**



Consumer Hotline

Australia

1800 025 059

New Zealand

0800 786 232

Consumer information:

1800 025 059 or www.sunbeam.com.au

 is a registered Trademark of Sunbeam Corporation Limited. ACN 000 006 771.

© Sunbeam Corporation Limited 2004.