

User Manual



Android 5.1.1
Lollipop



DRM

4X CPU 64bit Cortex A53
5X GPU Mali-450



4K 60fps



3D-HD
1080Px2



Preface

Thanks very much for choosing our TV Box. In order to make it more convenient for you to use proficiently, we provide you with a user manual. Please read it carefully before using and properly keep it for reference.

Statements

We have made every effort to provide the most current information about the product.

We do not grant any guarantees as to the contents of the present instruction manual and disclaim any implied guarantees concerning market value or suitability for specific purposes.

The information contained here is an instruction intended to enable the correct usage and maintenance of the receiver.

We reserve itself the right to introduce amendments, changes or translations of the user manual without prior notification thereof. For this reason, we recommend you regularly visit our website in order to obtain the latest information.

Contents

Chapter 1 System Introduction

1. 1 Key Features ----- 02

1. 2 Environment for System ----- 02

1. 3 Package Contents ----- 02

Chapter 2 Remote Controller

2. 1 Introduction of Remote ----- 03

Chapter 3 System Connection

3. 1 AV Connection ----- 04

3. 2 HDMI Connection ----- 04

3. 3 Startup ----- 05

Chapter 4 Home

Chapter 5 Apps

5.1 Email ----- 06

5.2 Calculator ----- 07

5.3 PPPoE ----- 07

5.4 Browser ----- 08

5.5 Movie Player ----- 08

5.6 Media Centre ----- 09

5.7 Gallery ----- 09

5.8 Samba ----- 10

5.9 File Browser ----- 10

5.10 Download ----- 11

5.11 Music ----- 11

5.12 App Installer ----- 12

5.13 Multi-interaction ----- 12

5.14 OTA update ----- 13

Chapter 6 Settings

6.1 Network ----- 14

6.2 Display ----- 15

6.3 Advanced ----- 16

6.4 Other ----- 16

Chapter 7 Trouble Shooting

Chapter 8 Specification

Chapter 1 System Introduction

1. 1 Key Features

- Android 5.1 operating system with Quad-Core Cortex-A53
- Support many kinds of IPTV and OTT TV programmes.
- Support three main HD formats: 4K,H.265,MPEG-2 and many other normal formats such as MPEG-1、MPEG-2、MPEG-4、DIVX、REALMEDIA and so on.
- Video formats include avi, mpg, vob, rmvb, mkv, m2ts ,ts and so on.
- Photo formats include JPEG, BMP, and PNG up to 80M pixels.
- Audio formats include MP 、WMA、WAV、AC3、AAC and so on.
- Support SD/SDHC/MMC cards.
- Support USB 2.0 host connectors with maximum output current of 1.5A/5V.
- Support standard RJ45 cable network connection and wireless network connection.
- Support infrared remote controller operation.

1. 2 Environment for System

Operation : Temperature limitation: 0--40°C; Humidity limitation: 20--80%.

Storage : Temperature limitation: -20--50°C; Humidity limitation: 10--90%.

1. 3 Package Contents

Accessories	Quantity
Power adaptor	1
Remote control	1
HDMI cable	1
User manual	1

Chapter 2 Remote Controller

2.1 Introduction of Remote



-  **POWER:** Press to turn on/off
-  **MUTE:** Press to turn down the volume
-  **KODI:** Press to enter the KODI app
-  **VIDEO:** Fast key to go to video playlist
-  **WEB:** Press to enter the browser
-  **APPS:** Fast key to go to APP list
-  **VOL +/-:** press to increase/decrease the volume
-  **Go to previous page or next page**
-  **HOME:** Press to get back the main menu
-  **RETURN:** Press to return back to previous menu
-  **MENU:** Press to choose setting function
-  **CURSOR:** Press to use the navigation button as mouse
-  **Navigation:** Press to navigate left/right/up/down
Press Ok to confirm your choose
-  **Number:** Press to choose the number

Chapter 3 System Connection

- 3.1 AV Connection
- 3.2 HDMI Connection

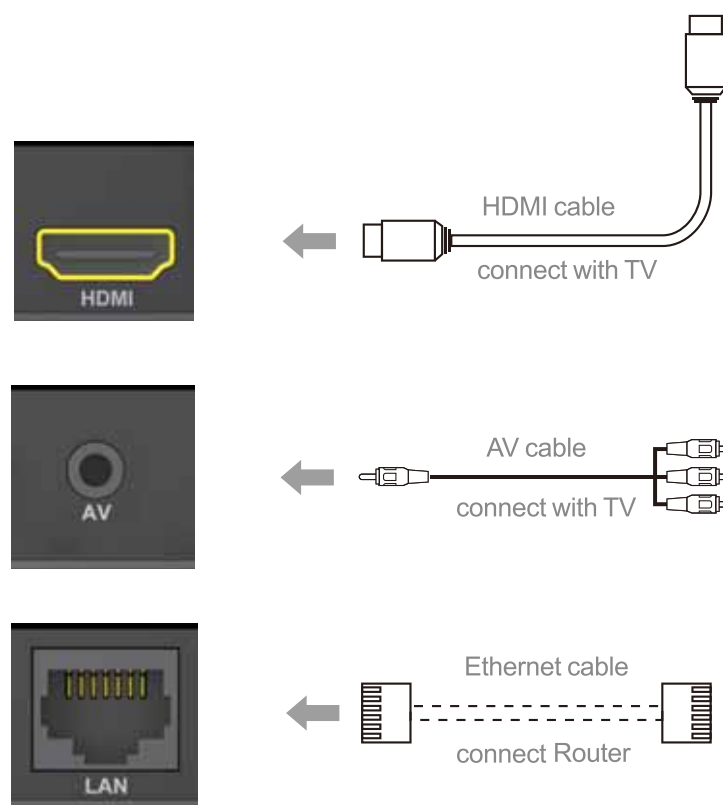

3.3 Startup

Turn on the TV box while indicator light is blue. Enter into main menu at about 30 seconds.



Chapter 4 Home

There are apps which you usual use.

You can add the apps according to your own preference.

Please tick the apps you need. Tick it again when you don't need it.



Chapter 5 My Apps

Move to "My Apps", Press OK to enter in.

You can see icons referring to different function on the picture.



5.1 Email

Move to "Email". Press OK to enter in.

It is a convenient way for you to send and receive your emails.

You can configure Email for most accounts in just a few steps. Move to Email address.

Press to input your email address and password.

And press the icon "next".



5.2 Calculator

Move to "Calculator" icon. Press OK to enter in.
It is a simple calculator for arithmetical workings.



5.3 PPPoE

Move to "PPPoE" icon, Press OK to enter in. You can configure PPPoE here.



5.4 Browser

Move to "Browser". Press OK to enter in.
It is a convenient way for you to go to your desired website.
Notice: Please go to the system setting to set the internet connection before entering into the website.



5.5 Movie Player

Move "Movie Player". Press OK to enter into the movie list.



5.6 Media Centre

Move to "Media Centre" icon, You can play all your prefer media here.



5.7 Gallery

Move to "Gallery". Press OK to enter into the picture list
Here you can enjoy the pictures



5.8 Samba

Move to "Samba". Press OK to enter in.
The system will search the share files automatically.

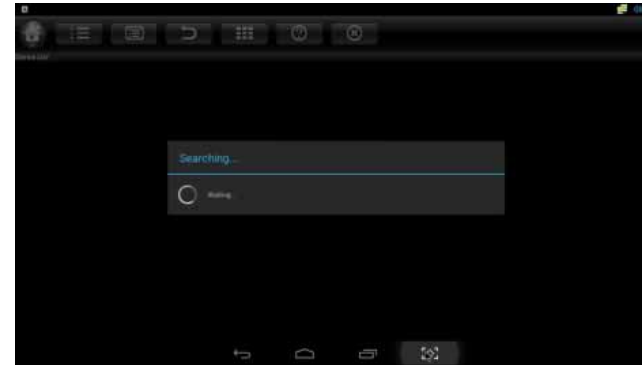

5.9 File Browser

Move to "Filebrowser". Press OK to enter into the device list.
When inserting with USB device or SD/SDHC/MMC cards, the sign "Device is mounting" will be shown on the screen.
Here you can cut, copy, paste and move the files and folder between the local disk and external storage card.

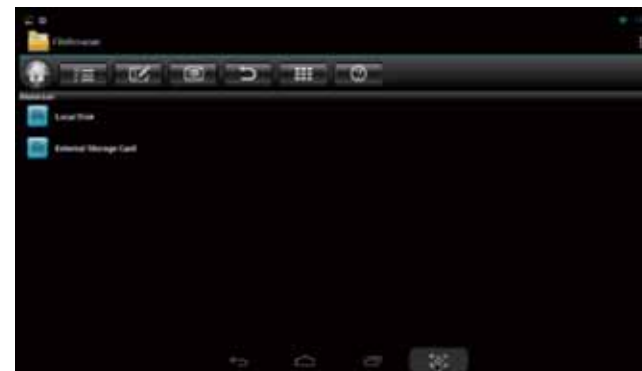

5.10 Download

Move to "Downloads". Press OK to enter in. You can check the status here when downloading apks from the internet.



5.11 Music

Move to "Music". Press OK to enter into the music list. This is for local media player. Here you can enjoy beautiful music.



5.12 App Installer

Move to "AppInstaller". Press OK to enter in.

You can install software by this appinstaller function. Please first download your desired software by apk formats from the computer to the USB. You will choose your desired device in order to scan the apks.

Press OK to install your desired software.

After the installation finished, the software icon will be shown on the applications menu.



5.13 Multi-interaction

Airplay

Move to "Airplay" icon or "Miracast" icon, Press OK to enter in.

Airplay: Download airplay application according to the model of the mobile phone. Enter into Airplay, connect with the same WIFI hotspot. Play video, picture, or music on your phone. Click the "airplay" icon on the phone to share files.



Miracast

Miracast: Please make sure the android TV box and mobile phone under the same WIFI environment. Press "Miracast" on android TV box, it will find peers automatically, and click "setting" on your mobile phone, enter into "WLAN", Click "Menu" to choose "WLAN Display" on your phone. Choose to share files.



5.14 OTA update

Move "OTA update" icon, Press OK to enter. Click "online update" if there is an update in server, you can choose to download it. After upgrade finished, system will restart automatically.



Chapter 6 Settings

6.1 Network

WI-FI

"√" WI-FI, System will start scanning available WI-FI networks around you automatically.

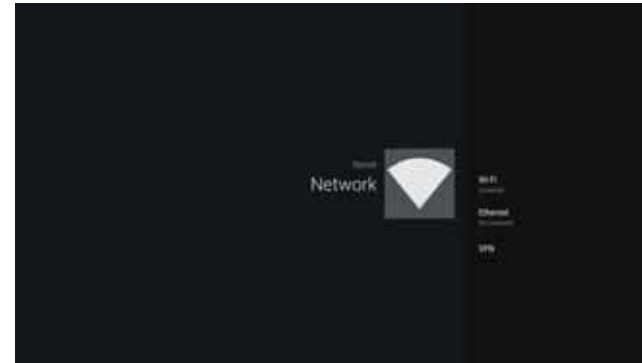

Press OK to choose your WI-FI network and enter with your password. After authenticating IP address, when connected is shown, WI-FI is available now.

Notice: Sometimes WI-FI is not stable. If WI-FI connecting is failed, please try again.



Ethernet:

"√""Ethernet"System will start scanning Ethernet automatically.

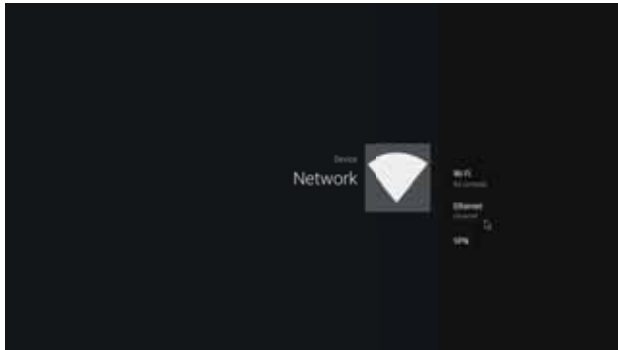

When the IP address appears,the Ethernet connected.

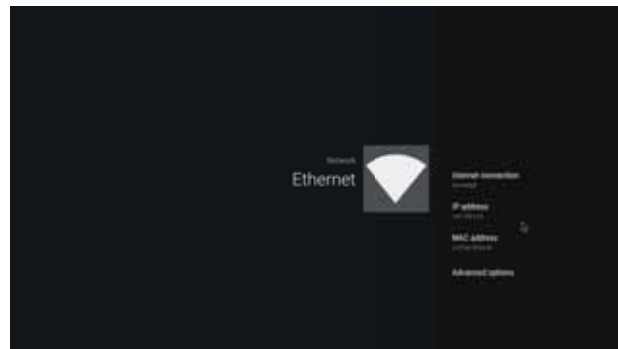

6.2 Display

Move to "Display".

Here you can set wallpaper, HDMI audio output mode,turn on/off hide status bar, display position,choose the time of start screen saver.

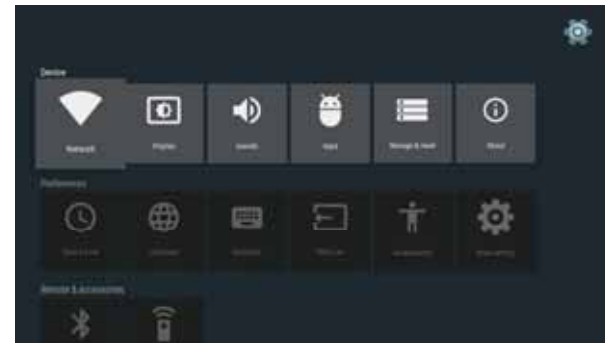

6.3 Advanced

Move to "Advanced" to Choose advanced settings.Here you can set Miracast,Remote control, CEC control,Location,orientation,home screen and digital audio output.



6.4 Other

Move to "Other" to see more TV Box information.You can do system update and more setting here.



Chapter 7 Trouble Shooting

Under no circumstances should you try to repair the TV Box by yourself, as this will invalidate the warranty. Do not open the TV Box as there is a risk of electric shock. If a fault occurs, first check with points listed below before taking the TV Box for repair. If you are unable to remedy a problem by following hints, consult your dealer for help.

Problem	Solution
No power	-Check if the power adaptor is properly connected to the power and the TV Box. -Press the power on the remote controller to turn on the power.
No picture	-Reconnect with HDMI cable or AV cable. -Check if the TV is switched on.
No sound or distorted sound	-Adjust the volume. -Check that the speakers are connected correctly.
No audio or digital output	-Check the digital connections. -Check if your amplifier is set correctly.
The box does not respond to the Remote Control	-Aim the remote control directly at the sensor on the front of the TV Box. -Reduce the distance to the TV Box. -Replace the batteries in the remote control.
Player does not respond to some operating commands during playback	-Operations may not be permitted. Refer to the user manual. -Possibility of system halted, re-insert with power adaptor to restart.
No sound during movies playback	-The audio codec may not be supported by the TV Box. You can change to the supported audio on playing menu. -Check the volume.
The contents of the USB flash drive cannot be read	-The USB flash drive format is not compatible with the box. -If one of the USB can not be read, please turn off the TV Box for 30seconds and restart the TV Box.
Slow operation of the USB flash drive	-Big file size or high resolution USB flash drive takes longer time to read and display on the TV screen.
No sound with HDMI connection	-Check the connection between the TV and the HDMI jack of box. -Check your TV system setup. -Check the volume.
The TV screen is blank and the player LED is blinking	-Turn off your TV Box, wait 30 seconds, turn it on again. -If under HDMI status, check if HDMI connection is correct or change another HDMI cable set the output resolution of this TV Box into 720p.

Chapter 8 Specification

Parameters	Android TV Box	
Item		
Main function	On-line video (IPTV and OTT TV programs)	Many IPTV programmes, all standard IPTV softwares and popular on-line video websites based on android system. (such as Youtube, Netflix, local satellite TVs, sports, finance, etc). It can also connect to your designated websites.
	Android applications	Support many applications from google play including web browser, google map, 2D/3D games, P2P download, online video chat, email and so on. Support mouse and keyboard; Support FAT16, FAT32, NTFS file system.
	Full HD definition All formats with	4k2k H.265 high definition decoding, support all formats
Video format	1080p/720p/480p multi-format decoding	MPEG1/MPEG2/MPEG4/VC-1/H. 264/H. 265/ Real Video formats including avi, mpeg, vob, mkv, ts, m2ts, wmv, rm, rmvb suffixes and so on.
Photo format	Up to 80M pixels	JPG, BMP, PNG
Audio format	Multi-audio format	MP3, WMA, WAV, MIDI, OGG, AC3, (some formats need the support of the third party player software.)
Hardware configuration	Main chipset	Quad core Cortex A53 2GHz
	GPU	GPU: Penta-Core Mali-450
	Memory	Memory: 1GB/2GB-DDR3
Input interface	Storage cards	SD/SDHC/MMC card
	USB interface	Two way 2.0 high speed, output current up to 1.5A/5V, connect with different kinds of mobile devices directly without additional power; Supports hot-plugging.
	Internet interface	Standard RJ45 Internet interface. Support internal wireless Wi-Fi (some other models require additional adaptor)
Output interface	Audio	Coaxial digital audio output . L/R stereo output: standard 3.5mm earphone socket.
	Video	CVBS output (AV output), Standard 3.5mm earphone socket. HDMI interface: HDMI 1.4/2.0 standard interface.
Electric parameters	Video	Range: 1V+/-0.1V(75Ω overload); S/N ≥ 55dB
	Audio	Range: 2V+/-0.2V(10kΩ overload); S/N ≥ 85dB
	Electric power	Power supply: 5V DC; Current: 2A.

This specification will be modified if necessary without notice.

This equipment has been tested and found to comply with the limits for a Class B digital device, pursuant to part 15 of the FCC Rules. These limits are designed to provide reasonable protection against harmful interference in a residential installation. This equipment generates, uses and can radiate radio frequency energy and, if not installed and used in accordance with the instructions, may cause harmful interference to radio communications. However, there is no guarantee that interference will not occur in a particular installation. If this equipment does cause harmful interference to radio or television reception, which can be determined by turning the equipment off and on, the user is encouraged to try to correct the interference by one or more of the following measures:

- Reorient or relocate the receiving antenna.
- Increase the separation between the equipment and receiver.
- Connect the equipment into an outlet on a circuit different from that to which the receiver is connected.
- Consult the dealer or an experienced radio/TV technician for help.

Caution: Any changes or modifications to this device not explicitly approved by manufacturer could void your authority to operate this equipment.

This device complies with part 15 of the FCC Rules. Operation is subject to the following two conditions: (1) This device may not cause harmful interference, and (2) this device must accept any interference received, including interference that may cause undesired operation.

This equipment complies with FCC radiation exposure limits set forth for an uncontrolled environment. This equipment should be installed and operated with minimum distance 20cm between the radiator & your body.