

P-2000

Laser-Based Micropipette
Pulser System

Operation Manual

Rev. 2.4c (20160412)



SUTTER INSTRUMENT®

One Digital Drive
Novato, CA 94949

Voice: 415-883-0128
Fax: 415-883-0572

Web: www.sutter.com
Email: info@sutter.com



Copyright © 2016 Sutter Instrument Company. All Rights Reserved.

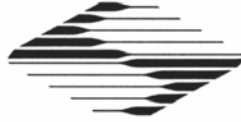

CE EU Declaration of Conformity

Application of Council Directives:
2014/30/EU (EMC), 2014/35/EU (LVD), and 2011/65/EU (RoHS 2)

Manufacturer's Name: Sutter Instrument Company

Manufacturer's Address: One Digital Drive
Novato, CA. 94949 USA
Tel: +1 415 883 0128

Equipment Tested: P-2000 Micropipette Puller

Model(s): P-2000

Conforms to Standards: EMC Emissions: EN 61326-1:2013, including:
EN 55011: 2009 Class B;
EN 61000-3-2:2015, & EN 61000-3-3:2014
EMC Immunity: EN 61000-4-2:2009, EN 61000-4-3:2011,
EN 61000-4-4:2012, EN 61000-4-5:2014,
EN 61000-4-6:2014, EN 61000-4-8:2010, &
EN 61000-4-11:2004
LVD (Safety): EN 61010-1:2010

Tested/Verified By: TUV Product Service
10040 Mesa Rim Road
San Diego, CA 92121 USA
Sutter Instrument

Test Report(s): SI_EMC_P-2000_20160713

Sutter Instrument Company hereby declares that the equipment specified above was tested and conforms to the EU Directives and Standards listed above, and further certifies conformation to the requirements of the European Union's Restriction on Hazardous Substances in Electronic Equipment Directive 2011/65/EU (RoHS 2).

Project Engineer:

Jack Belgum, Ph.D.
Senior Vice President



SUTTER INSTRUMENT®

One Digital Drive, Novato, CA 94949 USA Phone: +1 415 883 0128 Fax: +1 415 883 0572
Email: info@sutter.com Web: <http://www.sutter.com>

DISCLAIMER

- The pipette puller Model P-2000 is designed for the specific use of creating micropipettes, electrospray/nanospray emitters and optic fibers. No other use is recommended.
- This instrument is designed for use in a laboratory environment. It is not intended, nor should it be used in human experimentation or applied to humans in any way. This is not a medical device.
- Do not open or attempt to repair the instrument. Extreme heat and high voltages are present and could cause injury.
- Do not allow unauthorized and/or untrained operative to use this device.
- Any misuse will be the sole responsibility of the user/owner, and Sutter Instrument Company assumes no implied or inferred liability for direct or consequential damages from this instrument if it is operated or used in any way other than for which it is designed.

LASER SAFETY WARNING

- The P-2000 Micropipette Puller is a CO₂ laser based micropipette puller and as such its design and construction are regulated; in the US by the FDA's Bureau of Radiological Health (CDRH), in the European Community by the harmonized standard EN60825-1:1997, and in most other countries by the relevant laser safety documents usually based on IEC60825-1:1997.
- The P-2000 Puller as manufactured is classified as a Class I laser product under each of the above mentioned laser safety standards. This means that it can be operated safely as shipped without the need for additional safety measures.
-  The P-2000 Puller contains a 20W Class IV CO₂ laser with a 3.5mm diameter beam (4mR divergence). A number of safety shields, enclosures and redundant interlocks have been built into the P-2000 to protect the user from any radiation exposure. **UNDER NO CIRCUMSTANCES SHOULD THE SAFETY ENCLOSURES BE REMOVED OR THE INTERLOCKS DEFEATED. DOING SO COULD INJURE THE OPERATOR OR PASSERS BY IN A SERIOUS MANNER.** This laser emits invisible radiation that can inflict severe burns to those exposed to the beam, even momentarily.
-  Regulations require any injury by or exposure to the contained radiation of this device be reported to Sutter Instrument Company immediately.

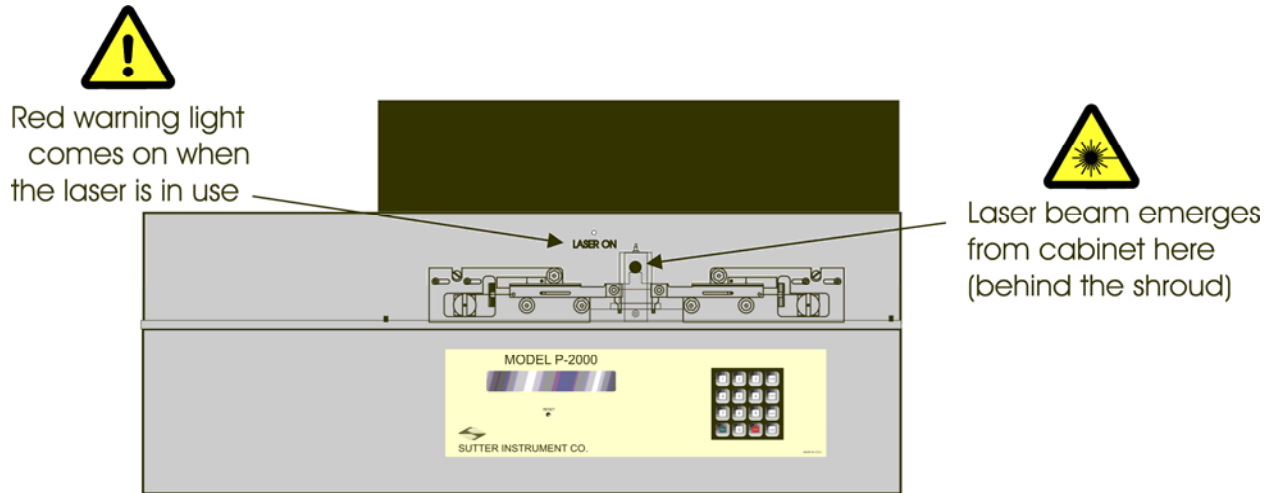

(Figure: Location of Laser Beam and "LASER ON" Warning Light.)

SAFETY WARNING LABELS

The following Safety labels are attached to the P-2000 when shipped to you:

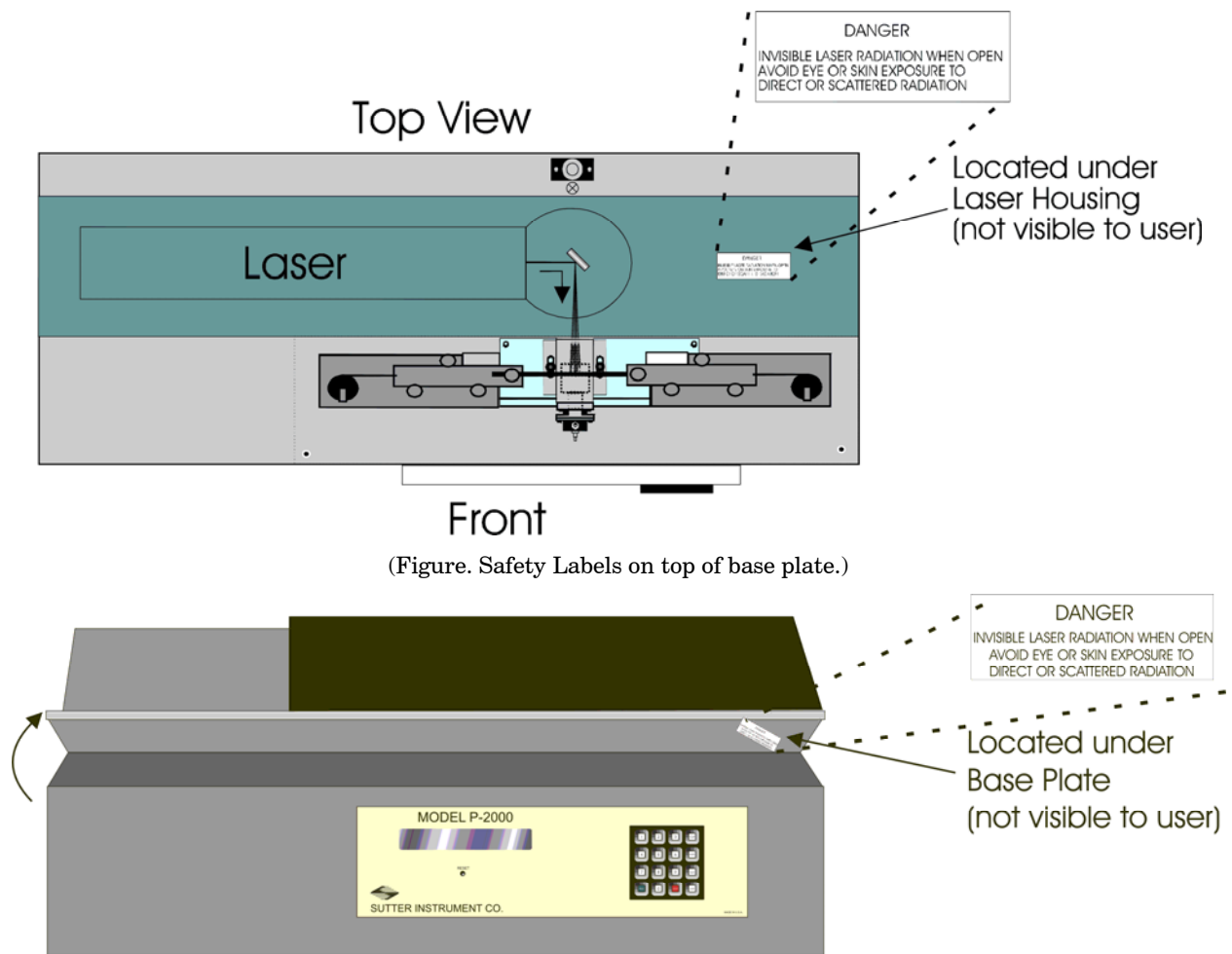

(Figure: Safety Labels on top of base plate.)

(Figure: Safety Label on the bottom of the Base Plate.)

GENERAL SAFETY WARNINGS AND PRECAUTIONS

- 
WARNING: Use of controls or adjustments or performance of procedures other than those specified herein may result in hazardous radiation exposure.

Electrical





- Operate the P-2000 using 110-120 V AC, 60 Hz, or 220-240 V AC., 50 Hz line voltage. This instrument is designed for connection to a standard laboratory power outlet (Overvoltage Category II), and because it is a microprocessor--controlled device, it should be accorded the same system wiring precautions as any 'computer type' system. A surge protector and power regulator are recommended.
- 
Fuse Replacement: Replace fuse only with the same type and rating as indicated in the following table.



(Table. Fuse specifications and ratings according to mains power.)

Mains Voltage Setting	Fuse (Type: Time Delay, 5mm x 20mm, glass tube)	
	Rating	Manufacturer Examples
“110” (100 – 120 VAC)	5A, 125 or 250V (Time Delay)	Bussmann: GMC-5A, GDC-5A or S506-5-R (RoHS) Littelfuse: 239 005 (RoHS)
“220” (200 – 240 VAC)	T3.15A, 250V	Bussmann: GDC-3.15A or S506-3.15-R (RoHS) Littelfuse: 218 3.15 (RoHS)

A spare fuse is provided, which is located in the power input module. Please refer to the Fuse Replacement appendix located in the end portion of this manual.

Avoiding Electrical Shock and Fire-related Injury

- 
WARNING: Always use the grounded power supply cord set provided to connect the unit to a grounded outlet (3-prong). This is required to protect you from injury in the event that an electrical hazard occurs.
- 
CAUTION: Before operating the instrument, check that the instrument's voltage rating corresponds to the supply voltage. The voltage rating can be found on the power entry module on the rear of the instrument.
- 
CAUTION: Before making electrical connections, ensure that the instrument is switched off.
- 
CAUTION: Do not disassemble the unit. All servicing of this unit must be performed at Sutter Instrument Company since appropriate laser safety training is required for all service personnel. Please contact Sutter Instrument Technical Support in the event servicing is required.

-  **CAUTION:** To prevent fire or shock hazard do not expose the unit to rain or moisture.
-  **WARNING:** To avoid burns do not touch the heated ends of glass pipettes that have been pulled.

Back Injury Prevention

 **WARNING:** To avoid injuring your back or limbs it is recommended that you do not attempt to lift this instrument by yourself. The P-2000 Micropipette Puller weighs in excess of 36.4 kg (over 80 lb) and should be moved by TWO (2) people and placed on a cart or trolley of sufficient robustness to support the weight.

Operational

Failure to comply with any of the following precautions may damage this device.

- This instrument is designed for operation in a laboratory environment (Pollution Degree I).
- This unit was not designed for operation at altitudes above 2000 meters nor was it tested for safety above 2000 meters.
-  Operate only in a location where there is a free flow of fresh air on all sides. The fan draws air in and exhausts it through vents on the back of the instrument. **NEVER ALLOW THE FREE FLOW OF AIR TO BE RESTRICTED.**
- Since the P-2000 Puller is a microprocessor-controlled device, it should be accorded the same system wiring precautions as any “computer type” system. If microprocessor based systems in the lab require line surge protection for proper operation, then the same protection should be provided for the P-2000.

Handling Micropipettes

Failure to comply with any of the following precautions may result in injury to the users of this device as well as those working in the general area near the device.

- The micropipettes created using this instrument are very sharp and relatively fragile. Contact with the pulled micropipette tips, therefore, should be avoided to prevent accidentally impaling yourself.
- Always dispose of micropipettes by placing them into a well-marked, spill-proof “sharps” container.
- Use only with glassware recommended by Sutter Instrument Company in the following sections of this manual.

TABLE OF CONTENTS

DISCLAIMER	iii
LASER SAFETY WARNING	iii
SAFETY WARNING LABELS	iv
GENERAL SAFETY WARNINGS AND PRECAUTIONS	v
Electrical	v
Avoiding Electrical Shock and Fire-related Injury	v
Back Injury Prevention	vi
Operational	vi
Handling Micropipettes	vi
1. GENERAL INFORMATION	1
1.1 Introduction	1
1.2 Technical Support	1
1.3 Information Labels	2
1.4 Glassware Specifications	2
1.5 Mechanical Description (Puller Anatomy)	2
1.5.1 Some Basic Information	2
1.5.2 Upper Cable Pulley Assembly	3
1.5.3 Retro-Mirror Assembly	4
1.5.4 Optical Pathway	5
1.5.5 Cabinet	8
2. INSTALLATION	9
2.1 Unpacking	9
2.2 Setting Up	9
2.2.1 Removing the Shipping Screw	9
2.2.2 Line Power (Mains)	10
3. OPERATIONS	13
3.1 First Time Use	13
3.2 Front Panel	15
3.2.1 Controls	15
3.2.2 Display	16
3.3 Programs	18
3.3.1 Program Structure	18
3.3.2 Cycle Parameters	18
3.4 Pull Cycle	20
3.4.1 Default Configuration	21
3.4.2 Selecting a Program [0 to 99]	22
3.4.3 Viewing a Program [NEXT] / [LAST]	23
3.4.4 Clearing a Program from Memory [CLR]	23
3.4.5 Editing a Program	24
3.4.5.1 Entering a new program	24
3.4.5.2 Editing an Existing Program	24
3.5 Software Control Functions	25

3.5.1 RAMP TEST <1>	25
3.5.2 WRITE-PROTECT THIS PROG[RAM] <2>	26
3.5.3 RESET TIME AND DATE <3>	27
3.5.4 MEMORY TEST <4>	27
3.5.5 COPY A PROGRAM <5>	28
3.6 Pulling Pipettes	29
3.6.1 Procedures	29
3.6.1.1 Looping	29
3.6.1.2 Pull Results	30
3.6.2 Notes on Program Operation	31
3.6.2.1 HEAT ON	31
3.6.2.2 Program Memory	32
3.7 Parameter Adjustment	32
3.7.1 General Information	32
3.7.2 Micropipette/Microinjection Needle Fabrication	32
3.7.2.1 Programs	32
3.7.2.2 Selecting Program Parameters	32
3.7.2.3 Glass Selection	34
3.7.2.4 Glass-specific Parameter Adjustment	34
3.7.2.5 Sample Programs (for Quartz glass)	35
3.7.3 Patch Pipette Fabrication	36
3.7.3.1 Programs	36
3.7.3.2 Selecting Program Values	36
3.7.3.3 Glass Selection	37
3.7.3.4 Glass-Specific Parameter Adjustment	38
3.7.3.5 Optical System Adjustments	38
3.7.3.6 Suggested Practices	39
3.7.4 Optic Fiber Fabrication	39
3.7.4.1 Fiber Preparation	39
3.7.4.2 Programs	39
3.7.4.3 Selecting Program Parameters	39
3.7.5 Electrospray/Nanospray Tip Fabrication	40
3.7.5.1 Glass Preparation	40
3.7.5.2 Programs	40
3.7.5.3 Selecting Program Parameters	41
3.7.6 Technical Tips	41
3.7.6.1 Maintaining Pipette Wall Thickness of Quartz Glass	41
4. APPLICATIONS AND TECHNIQUES	43
4.1 Pulling Very Short Micropipettes	43
4.2 Pulling Large-Diameter Glass	44
4.2.1 Background	44
4.2.2 Principles and Strategies	44
4.2.3 Suggested Practices	45
4.3 Determining Tip Concentricity	45
5. MAINTENANCE	49
5.1 Cleaning	49
5.1.1 Exterior	49

5.1.2 Pull Bars and Pulleys.....	49
5.1.3 Retro-Reflective Mirror	49
5.2 Optical Alignment.....	50
5.2.1 Scanning Mirror Tilt Adjustment	50
5.2.2 Reading the Micrometer.....	51
5.2.3 Retro-Reflective (“Retro”) Mirror Adjustment.....	52
5.3 Pulley Adjustment	54
6. TROUBLESHOOTING	57
6.1 Controlling Pipette Tip Shapes	57
6.1.1 Problem: WHAT GLASS SHOULD I USE: THICK OR THIN?.....	57
6.1.2 Problem: THE RESISTANCE OF MY PIPETTES IS TO LOW. HOW DO I PULL A HIGHER RESISTANCE PIPETTE?.....	57
6.1.3 Problem: OK, BUT I STILL WANT A SMALLER TIP THAN I AM GETTING.....	57
6.1.4 Problem: HOW DO I INCREASE THE SIZE OF MY PATCH-PIPETTE?	57
6.1.5 Problem: THE TIPS OF MY PATCH-PIPETTES VARY IN SIZE FROM PULL TO PULL.	57
6.1.6 Problem: ONE ELECTRODE IS MUCH LONGER THAN THE OTHER ELECTRODE.	58
6.1.7 Problem: THE SHAPE AND RESISTANCE OF THE PIPETTE CHANGES FROM PULL TO PULL.....	58
6.2 Controller Problems	58
6.2.1 Problem: DISPLAY BLANK, FAN NOT ON.	58
6.2.2 Problem: DISPLAY SHOWS A ROW OF BLOCKS.	58
6.2.3 Problem: DISPLAYED PROGRAM VALUES ARE NOT CORRECT	59
6.3 Technical Support.....	59
APPENDIX A. LIMITED WARRANTY	61
APPENDIX B. ACCESSORIES.....	63
Spacers	63
Glass Stops.....	63
Glass Loading Aids.....	63
Pipette Storage Boxes.....	63
APPENDIX C. FUSE REPLACEMENT.....	65
APPENDIX D. TECHNICAL SPECIFICATIONS.....	67

TABLE OF FIGURES

Figure 1-1. Information labels on the back of the P-2000 cabinet.....	2
Figure 1-2. Upper Cable Pulley Assembly	3
Figure 1-3. Puller Bar styles.....	4
Figure 1-4. Retro Mirror Assembly.....	5
Figure 1-5. Optical Pathway (top view without laser housing).....	6
Figure 1-6. Optical Pathway (viewed from right end of cabinet; shroud, laser and laser housing not shown)	7

Figure 1-7. Cabinet components	8
Figure 2-1. Location of Shipping Screw	10
Figure 2-2. P-2000 Cabinet (rear view)	10
Figure 2-3. P-2000 Cabinet (end view, left)	11
Figure 2-4. Power connection.....	11
Figure 3-1. Left Puller Bar	13
Figure 3-2. P-2000 Front Panel	15
Figure 3-3. LCD Display (program information)	16
Figure 3-4. LCD Display (program parameters)	17
Figure 3-5. Pull cycle when DELAY is greater than 128	20
Figure 3-6. Pull Cycle when DELAY is less than 128.....	21
Figure 3-7. Power-on Display	22
Figure 3-8. P-2000 Program (Initial) Display	23
Figure 3-9. Clear Program Display	23
Figure 3-10. Access to Control Functions	25
Figure 3-11. Control Function Menu	25
Figure 3-12. Insert-glass, clamp, and pull prompt.	26
Figure 3-13. Filament-selection prompt.....	26
Figure 3-14. Prompt to edit or write-protect the program.....	27
Figure 3-15. Time/Date Minutes prompt.....	27
Figure 3-16. Initiate-Memory-Test prompt.	28
Figure 3-17. Program-to-Copy and To-Which-Number prompts.....	28
Figure 3-18. Message indicating program is write-protected and therefore it cannot be changed.	28
Figure 3-19. Pull cycle report	29
Figure 3-20. Sample program.....	29
Figure 3-21. Pull cycle report (multiple-loops).....	31
Figure 4-1. Mounting the pipette for evaluation of its geometry	46
Figure 4-2. Field of view when aligning the pipette shaft.....	47
Figure 4-3. Field of view when checking the concentricity	47
Figure 5-1. V-groove bearings and pull bars.....	49
Figure 5-2. Scanning mirror tilt adjustment (from right end of cabinet; shroud, laser and laser housing not shown)	50
Figure 5-3. Micrometer scale.....	51
Figure 5-4. Scanning mirror adjustment using thermal paper.	52
Figure 5-5. Retro Mirror Adjustment.....	53
Figure 5-6. Pulley adjustment	55
Figure 6-1. Power entry module	65
Figure 6-2. Fuse holder	65

TABLE OF TABLES

Table 3-1. FILAMENT scan pattern values.	19
Table 3-2. Standard factory configuration.....	21
Table 3-3. Default Programs.	22
Table 3-4. Control Functions.....	25
Table 5-1. Pipette asymmetries and solutions.....	54
Table 6-1. Fuse type and rating.	66
Table 6-2. Fuse type and rating.	67

(This page intentionally left blank.)

1. GENERAL INFORMATION

1.1 Introduction

The P-2000 is a microprocessor controlled, CO₂ laser-based micropipette puller. The default configuration of the P-2000 allows fabrication of micropipettes for intracellular recording, patch clamping, microinjection and microperfusion. The primary advantage of using the CO₂ laser as a heat source is the ability to work with quartz (fused silica) glass, a much stronger and more pure glass formulation than standard glass capillary tubing. Two models of the P-2000 are available, each outfitted at the factory, and one of which is specified when the system is ordered:

P-2000/G Laser-based puller outfitted for use with glass with an outer diameter EQUAL to or GREATER than 0.6mm.

P-2000/F Laser-based puller outfitted for use with glass with an outer diameter LESS than 0.6mm.

The precision with which the laser heat source can be modulated and directed allows the use of a wide range of glass diameters from 0.125 to 1.2 mm. Larger diameter glasses can be used with the P-2000/G (up to 1.5 mm quartz and 1.8 mm conventional glasses) but the performance is best with glass that is 1.2 mm diameter or less. Model P-2000/F can also be used to pull tubing and optical fibers to exceedingly small diameters for research applications such as HPLC and near-field scanning microscopy, respectively. The two models differ in their puller bars and the shroud that covers the retro mirror. Conversion between the models is possible, must be performed at Sutter Instrument and will incur a nominal charge.

The P-2000 can store up to 100 separate programs, each consisting of up to 8 command lines. The five parameters set in each command line allow exquisite control of the micropipette taper geometry.

Realizing the full potential of this instrument is dependent on a complete understanding of the way it implements the pulling process. To this end, we urge that this manual be read in its entirety. To aid in understanding the function of the instrument, sample programs are already loaded in memory (as discussed in subsequent material).

1.2 Technical Support

Unlimited technical support is provided by Sutter Instrument Company at no charge to our customers. Our technical support staff is available between the hours of 8:00 AM and 5:00 PM (Pacific Time) at +1 (415) 883-0128. You may also E-mail your queries to info@sutter.com.

1.3 Information Labels

The following informational labels should be attached to the P-2000 when shipped to you.

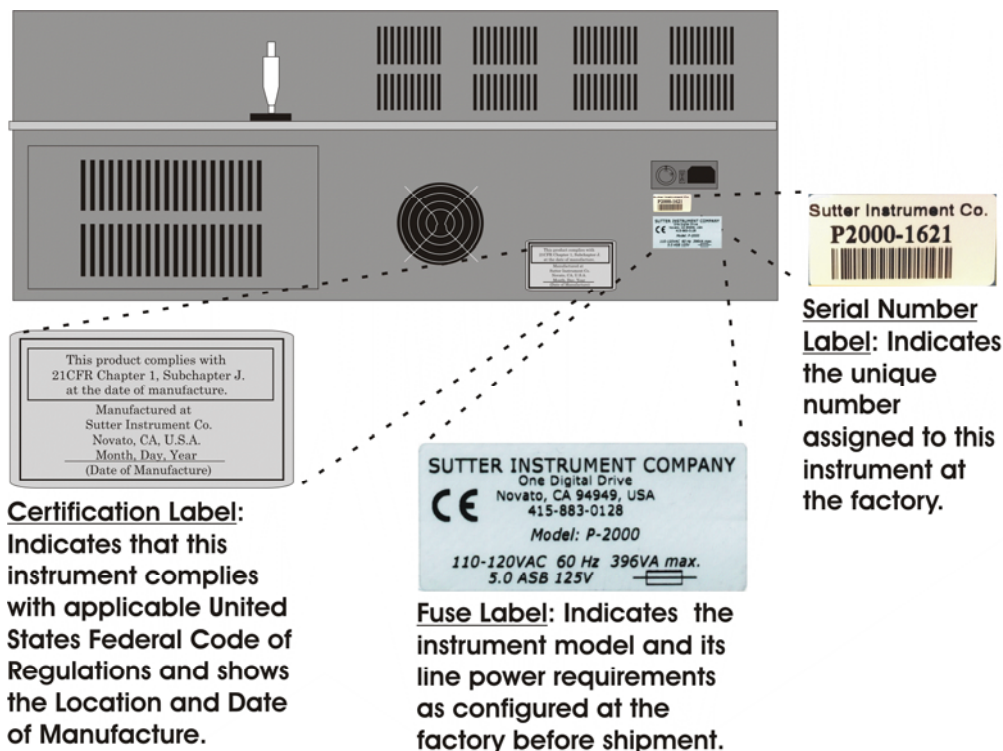

Figure 1-1. Information labels on the back of the P-2000 cabinet.

1.4 Glassware Specifications

The P-2000 micropipette puller is designed for use with aluminosilicate, borosilicate (or other lower melting point glass) and Quartz (fused silica) tubing or fiber ranging from 0.125 mm to 0.6 mm (P-2000/F) or 0.6 mm to 1.2 - 1.8 mm in outer diameter (P-2000/G). Even though the P-2000/G Puller can handle glass with an outer diameter of up to 1.8 mm, the best performance is achieved with 1.2 mm or less. Examples of the specific types and sizes of glassware that can be used with the P-2000 are listed in the Sutter Instrument Company catalogue that was included with this instrument or can be viewed on Sutter Instrument Company's web site at www.sutter.com.

1.5 Mechanical Description (Puller Anatomy)

1.5.1 Some Basic Information

This section presents a basic mechanical description of the P-2000 Puller with particular emphasis on terminology. Knowing the names of the various parts greatly facilitates communication between the investigators and the manufacturer when discussing adjustments or service issues. Those adjustments that are considered part of maintenance procedures are dealt with in the maintenance section of this manual.

1.5.2 Upper Cable Pulley Assembly

This assembly conducts the PULLING CABLES (item **T** in **Figure 1-2**) from the PULLER BARS (**G**) to the centrally located (and concealed) LOWER CABLE PULLEY ASSEMBLY. Note that the UPPER CABLE PULLEY ASSEMBLY is attached to its panel by two screws, in slots (**J'**), and contains a large eccentric adjustment screw (**J**). This eccentric screw is used to adjust cable “tension”. Its use is covered in the maintenance section.

IMPORTANT: Contact Sutter Instrument Tech Support **BEFORE** making any adjustments of the upper cable pulley assembly.

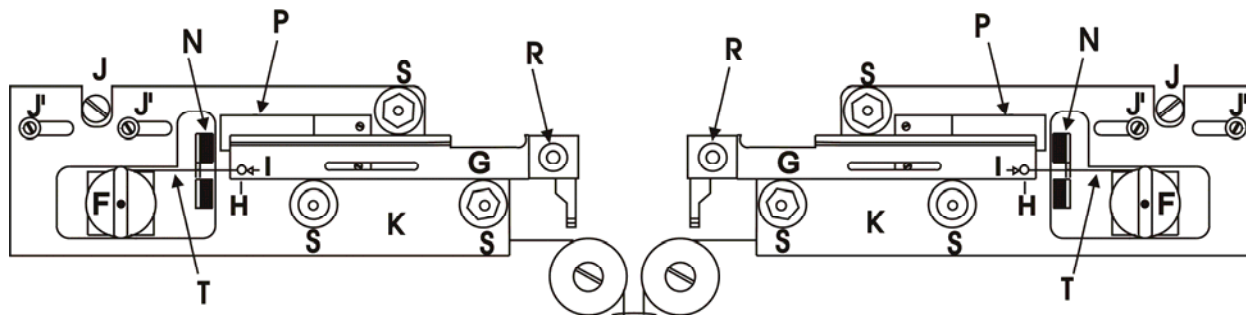

Figure 1-2. Upper Cable Pulley Assembly

PANELS, LEFT & RIGHT (K in Figure 1-2) The panels are the angled surfaces that provide mountings for the PULLER BARS (G) and their BEARINGS (S); the SPRING STOPS (P); the BUMPERS (N); and the UPPER CABLE PULLEY ASSEMBLIES (F). Note the three socket-head cap screws that attach each PANEL to the top (J and J'). These screws are used to align the PULLERS BARS. Their use is covered in Chapter 5 (MAINTENANCE).

BUMPERS (N in Figure 1-2) The BUMPER stops the motion of its associated PULLER BAR (G), and prevents impact forces from breaking pipettes.

SPRING STOPS (P in Figure 1-2) The SPRING STOPS are one-way catches that prevent pipette tip collision by catching the PULLER BARS (G) as they rebound off the BUMPERS (N).

PULLER BARS (G in Figure 1-2) This assembly consists of the puller bar, glass clamp, clamping knob (R) and cable retaining screw (H). The puller bar is made of mild steel and coated with a controlled thickness of hard chrome. Glass is loaded into the groove near the tip of the puller bar and is held in position by tightening down the clamping knob (R). The cable retaining screw (H) holds the cable in a shallow groove (I) at the end of the puller bar, and forms the “resistance” against which the cable ends pull.

See Figure 1-3 for the three different styles of puller bars found on P-2000/G and P-2000/F Pullers. The “old-style” puller bars for model P-2000/G (Figure 1-3B) were discontinued in 2006. All current models ship with the new-style puller bars (C), which ensure that the laser is directed towards the center of the glass capillary irrespectively of its diameter. A glass loading aid is available should you have persistent problems clamping the glass capillary with new-style puller bars (Figure 1-3C).

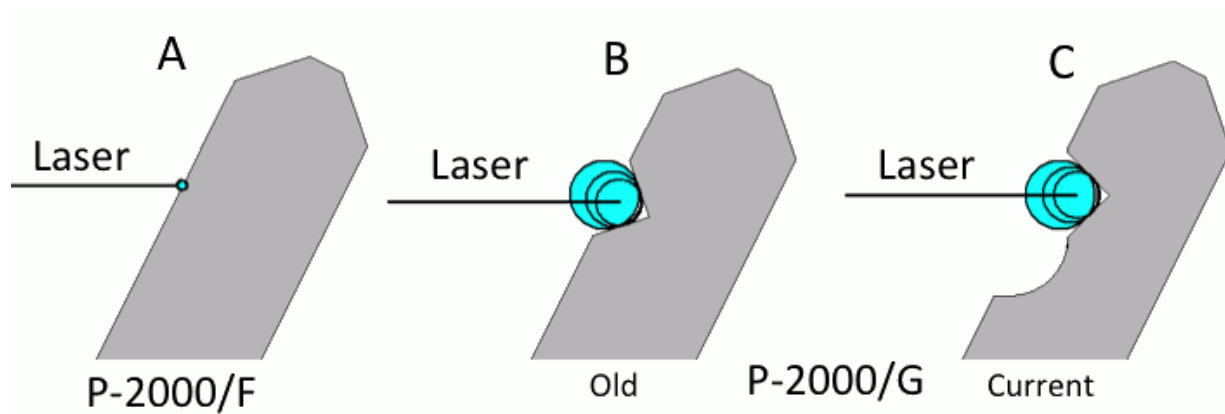

Figure 1-3. Puller Bar styles.

V-BEARINGS (S in Figure 1-2) These bearings are the guides for PULLER BAR motion. They are made of stainless steel and should NEVER be oiled (see maintenance section). These bearings are mounted on stainless steel bushings, one of which is round with the other two being hexagonal. The hexagonal bushings are used to adjust position and ease of travel of the PULLER BARS (see Chapter 5 (MAINTENANCE)). Note that the V-bearings MUST have a significant amount of play for the puller bars. Under no circumstances must the play be eliminated, as this may irreversibly damage the puller bars!

PULL CABLE (T in Figure 1-2) This cable conducts the pulling force of the solenoid to the PULLER BARS (G) via the UPPER (F) AND LOWER PULLEY ASSEMBLIES. It is made of flexible metal with a nylon coating. Never pinch or distort the cable. The cable is terminated with crimped-on clamps or “swages”. Note that the cable is mechanically connected to the puller bar by the cable retaining screw (H), not by the swage. Should the swage point out of the plane of the puller bar, this indicates that the retaining screw may have become loose, and the puller cable tension needs to be checked (see Chapter 5 MAINTENANCE).



IMPORTANT: Contact Sutter Instrument Tech Support BEFORE making any mechanical adjustments of the upper cable pulley assembly.

1.5.3 Retro-Mirror Assembly

The RETRO MIRROR ASSEMBLY comprises the RETRO MIRROR, TWO-STAGE MICROMETER, SHROUD and COVER PLATE. The TWO-STAGE MICROMETER, SHROUD and COVER PLATE are discussed below. The RETRO MIRROR and use of the TWO-STAGE MICROMETER are detailed in the OPTICAL PATHWAY section of this chapter.

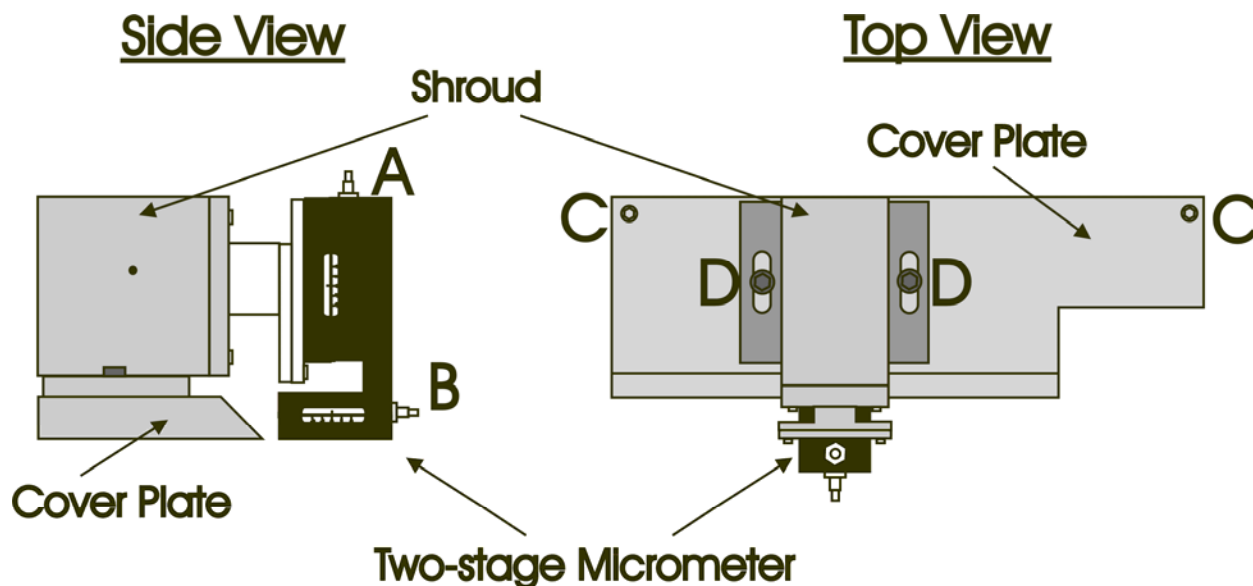

Figure 1-4. Retro Mirror Assembly

- RETRO MIRROR** Covered by the SHROUD and not visible in Figure 1-4. See the Optical Pathway section and Figure 1-6 for details.
- SHROUD (Figure 1-4)** The SHROUD encloses the RETRO MIRROR and the optical pathway of the laser beam. This component is one of the safety features protecting the user from exposure to the laser beam. Access holes in the side of the SHROUD allow the glass to be loaded into the optical pathway of the laser. On a fiber puller, model P-2000/F, the “fiber” SHROUD access holes are connected by a slot to make loading the fiber more convenient. The SHROUD can be removed for inspection and cleaning of the RETRO MIRROR by unscrewing the two screws (labeled D in Figure 1-4) that hold it to the COVER PLATE and lifting the SHROUD straight up.
- TWO-STAGE MICROMETER (Figure 1-4)** The TWO-STAGE MICROMETER is used to align the RETRO MIRROR contained in the SHROUD. Alignment of the RETRO MIRROR has been performed at the factory and should not need readjustment. See the MAINTENANCE chapter for details on this procedure.
- COVER PLATE (Figure 1-4)** The cover plate conceals the entry of the PULLING CABLES into the BASE of the instrument. It is attached to the BASE PLATE by two screws (labeled C in Figure 1-4). The SHROUD, in turn, is anchored to the COVER PLATE.

1.5.4 Optical Pathway

The laser beam used to melt the glass in this instrument is directed as indicated in Figure 1-5, below. Each of the components necessary for defining the optical pathway of the laser beam are labeled in that figure and described in this section.

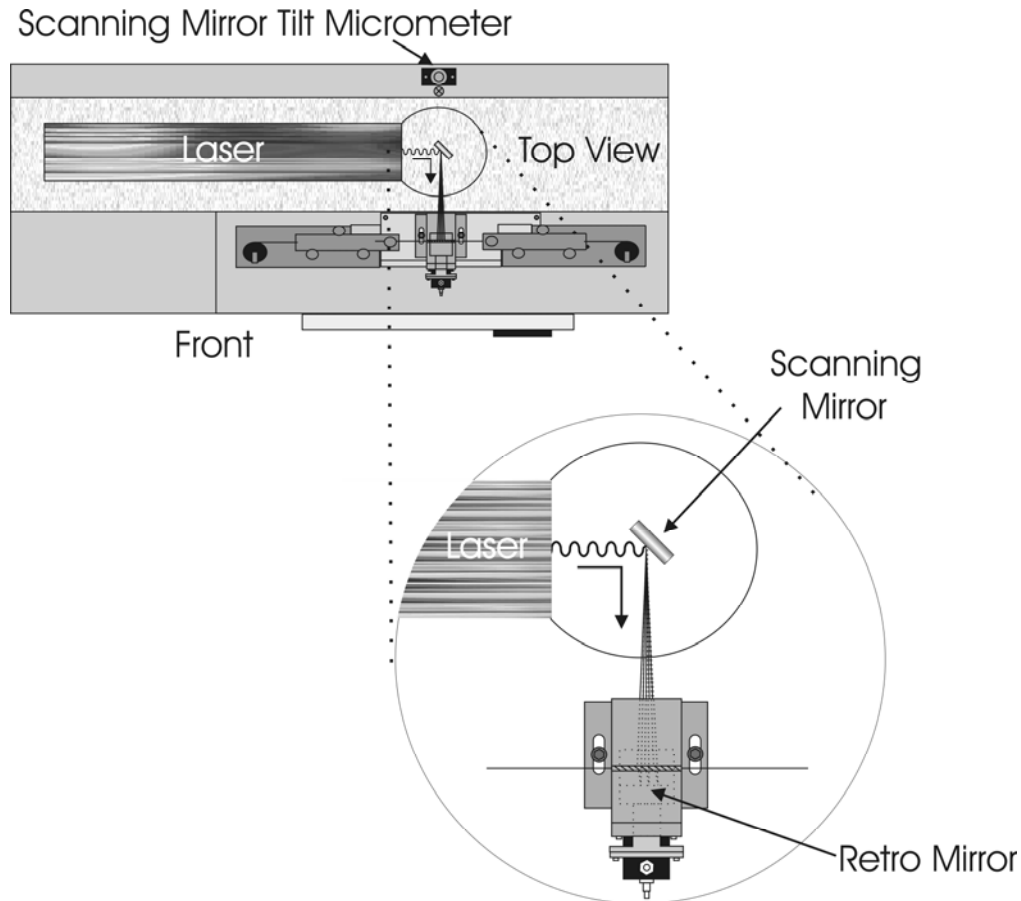

Figure 1-5. Optical Pathway (top view without laser housing).

LASER
(Figure 1-5)

A CO₂ laser serves as the heat source for melting the glass. Laser output power is regulated by feedback control electronics to match the power specified by the program value entered for HEAT.

SCANNING MIRROR
(Figure 1-5 & Figure 1-6)

The laser beam is projected onto the back face of the glass by a reflective SCANNING MIRROR. This mirror is mounted on a rotating base driven by a stepper motor. Heat application to the glass is achieved by repeatedly scanning the mirror horizontally between the limits of a defined longitudinal area that are set by the FILAMENT program parameter.¹

¹ NOTE: Although there are 16 different FILAMENT values, the latest version of the P-2000 firmware supports only six (0 through 5) different (unique) scanning patterns. The range of values 6 through 10 overlaps (duplicates) the last five of the first range (1 through 5), as does the last range (11 through 15). E.g., Using a FILAMENT value of 6 or 11 is identical to 1, 7 or 12 is identical to 2, and so on.

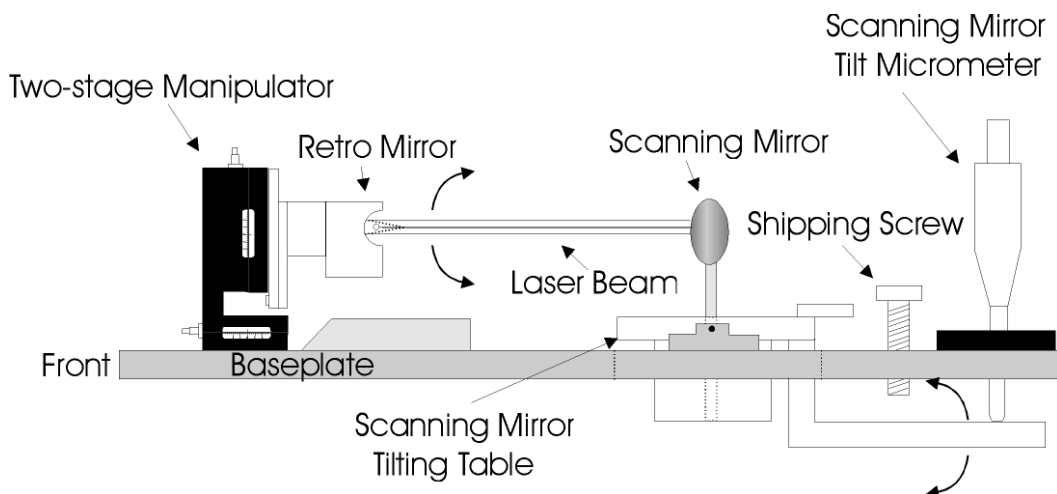

Figure 1-6. Optical Pathway
(viewed from right end of cabinet; shroud, laser and laser housing not shown)

**SCANNING
MIRROR TILT
MICROMETER
(Figure 1-6)**

The SCANNING MIRROR is mounted on a tilting table. The tilt controls the elevation of the laser beam relative to the glass. The degree of tilt is controlled by the Scanning Mirror Tilt Micrometer located at the back of the puller. In order to protect the tilting mechanism, a shipping screw has been installed next to the micrometer. This screw is turned down prior to shipping to unload the micrometer and lock the table in place. Before using the puller, run this screw up (turn counter-clockwise) until it is nearly out of the base plate.

There is a factory default setting indicated near the micrometer. This constitutes a starting point for adjusting the micrometer with a thermo paper test, as described in section 5.2.1 (Scanning Mirror Tilt Adjustment) in the MAINTENANCE Chapter. The micrometer setting may change slightly during shipping or relocation of the puller, but those changes are small. If the value you determine in a thermo paper test is more than a few units different from the factory setting, be sure to consult section 5.2.2 (Reading the Micrometer).

**RETRO
MIRROR
(Figure 1-6)**

The portion of the beam that is projected past the tubing is collected by a gold-plated, concave mirror mounted behind the tubing. This retro-reflective mirror or 'retro mirror' redirects the divergent laser radiation towards the front side of the glass and thereby provides relatively uniform heating around the circumference of the glass.

1.5.5 Cabinet

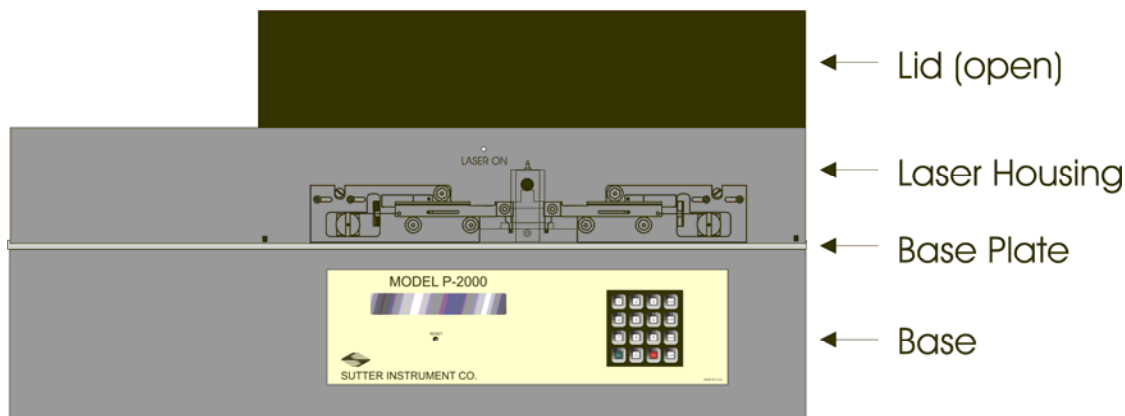

Figure 1-7. Cabinet components

- BASE PLATE** The metal plate on which the mechanical assemblies are mounted.
- LASER HOUSING** The LASER HOUSING is that portion of the blue cabinet, which is mounted on top of the BASE PLATE and encloses the laser, the scanning mirror. The laser housing serves to protect the user from the laser beam. There are no user serviceable parts inside this housing.
- BASE** The BASE includes the lower, blue cabinet to which the BASEPLATE is mounted as well as the transformers and the circuit board contained within. There are no user serviceable parts inside this cabinet.

2. INSTALLATION

2.1 Unpacking

Make certain that you have received all of the following items in the P-2000 shipping box:

- P-2000 laser-based micropipette puller
- Power cord
- Box of sample glass
- Warranty registration

The Model P-2000 is shipped to you in a prefabricated foam mold. Please take note of this method of packaging. Should it ever be necessary to ship the puller to another location the same method of packaging should be employed. Additional packing material may be purchased from Sutter Instrument.

IMPORTANT: Improper packaging is a form of abuse and, as such, can be responsible for voiding the warranty where shipping damage is sustained because of such packing.

2.2 Setting Up

2.2.1 Removing the Shipping Screw

In order to protect the tilting mechanism associated with the scanning mirror, a shipping screw has been installed next to the micrometer located at the back of the instrument (see Figure 2-1). This screw is turned down to unload the micrometer prior to shipping. Before using the puller, run this screw up (turn counter-clockwise) until it is nearly out of the base plate.

There is a factory default setting indicated near the micrometer. This constitutes a starting point for adjusting the micrometer with a thermo paper test, as described in section 5.2.1 (Scanning Mirror Tilt Adjustment) in the MAINTENANCE Chapter. The micrometer setting may change slightly during shipping or relocation of the puller, but those changes are small. If the value you determine in a thermo paper test is more than a few units different from the factory setting, be sure to consult section 5.2.2 (Reading the Micrometer).

We suggest that you test this adjustment with thermal paper as outlined in the Maintenance chapter of this manual before extensive development of new programs.

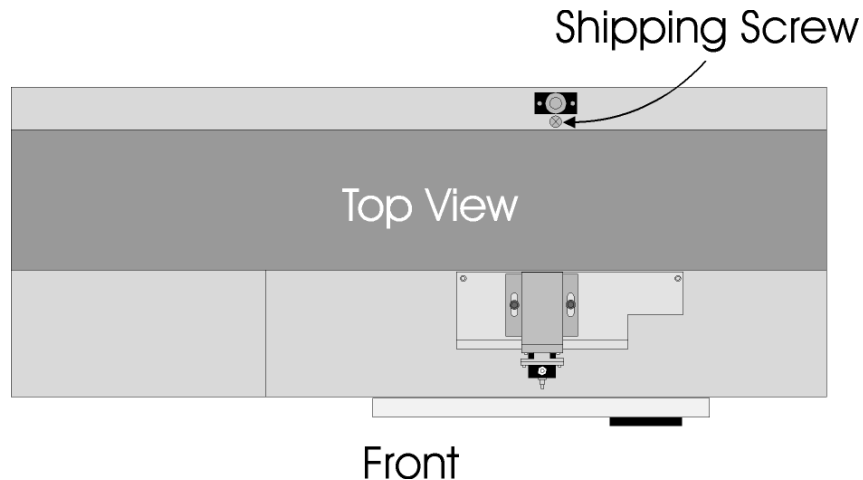

Figure 2-1. Location of Shipping Screw

2.2.2 Line Power (Mains)

The power cord provided with the P-2000 Puller connects to the Power Entry Module located on the back of the unit (see diagram below). This module also includes the Line Fuse and Voltage Selector Switch.

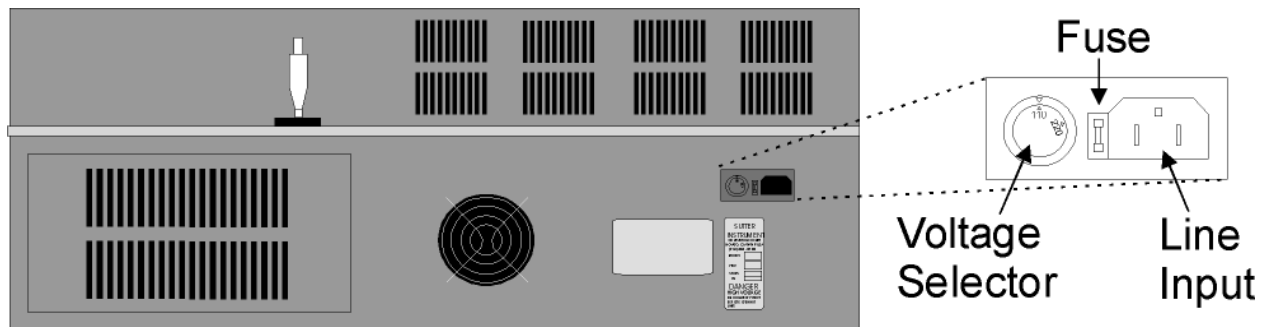

Figure 2-2. P-2000 Cabinet (rear view)

Confirm that the Voltage Selector Switch on the Power Entry Module is set to the proper value (110VAC or 220VAC.). If it is not, turn the selector switch until the appropriate value is lined up with the indicator. You must also replace the fuse with the appropriate value (see 6.3 Appendix D Technical Specifications). Otherwise your protection from fire and electric shock may be compromised.

Make certain that the Power Switch located on the left end of the P-2000 cabinet is turned OFF (see Figure 2-3).

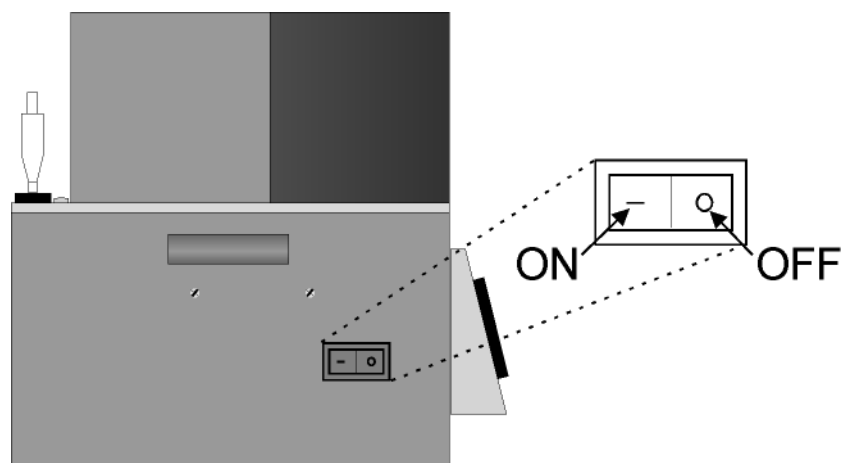

Figure 2-3. P-2000 Cabinet (end view, left)

Plug the power cord provided with the P-2000 into the Line Input socket on the Power Entry Module and then to a power source of the appropriate voltage and frequency.

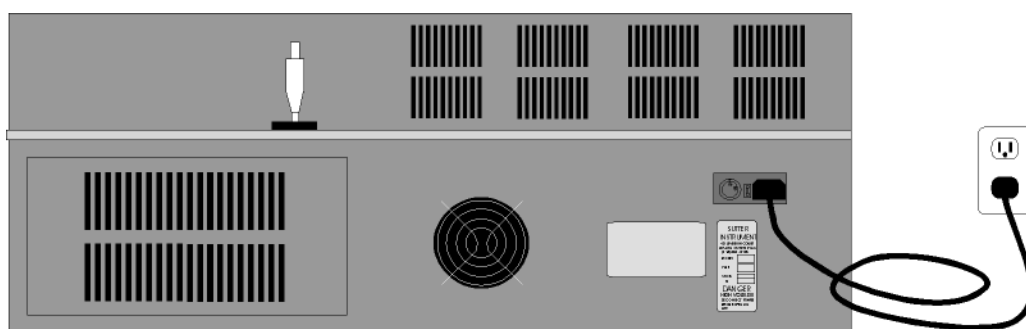

Figure 2-4. Power connection

(This page intentionally left blank.)

3. OPERATIONS

3.1 First Time Use

We realize that most new users of the P-2000 Laser-based Micropipette Puller are anxious to start pulling useable pipettes right away, but we cannot over-state the importance of taking a few moments to review the manual in order to understand how this model puller works. The parameters on the P-2000 Puller that ultimately determine the shape of the pipette tip behave somewhat differently from those used on other Sutter Puller Models. For that reason it will save the user time in developing programs if they familiarize themselves with how these parameters can be best manipulated to achieve the desired results. If you absolutely must use the puller before reading through the manual, the following instructions are provided to help you get going and keep you from wasting too many pipettes in the process.

1. Make certain that the shipping screw has been removed as described above.
2. Make certain that the P-2000 is plugged into the power outlet of the correct voltage and frequency.
3. Turn Power switch on left side of cabinet ON. To assure the most reproducible results you should allow the unit to warm up with the lid down for 15 minutes before pulling pipettes. Alternatively, you can select any program and press the <PULL> button several times with no glass loaded. This will start up the laser for a short period each time.
4. Press 0 <ENTR> on the keypad to view Program 0. The cursor will be flashing on the HEAT parameter. If you are pulling a fiber on a P-2000/F Puller, select program 3 instead.
5. Inspect the parameter values displayed for Program 0. Program 0 should display the factory-installed values listed on the enclosed program sheet. If the values vary, jot down the values displayed and then re-enter the program sheet values.
6. Load a piece of the supplied sample glass into the puller as follows:

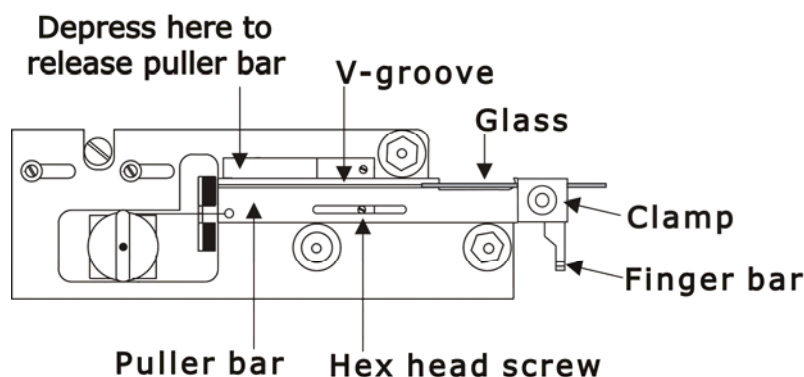

Figure 3-1. Left Puller Bar

- Loosen clamping knob.
- Place glass in V-groove in puller bar, slide it beyond clamp about 2 cm and tighten knob. If you have a P-2000/G Puller with the new-style puller bars, make sure the

glass is correctly loaded in the upper V-groove as shown in Figure 1-3C. If the glass is loaded in the lower, round groove, the laser beam will miss the glass, and the pull will not be executed. It may take several pulls until you reliably clamp the glass correctly, but most users become familiar with this procedure in short time. A glass loading aid is available should you have persistent problems clamping the glass capillary.

- Depress the spring stop on each puller bar to release them from their catch position.
 - Pull both bars towards each other using the finger bars. Hold bars in position using the thumb and index finger from one hand. The hex head screw should be touching the end of the slot in both puller bars.
 - Loosen both clamping knobs and carefully slide glass through the holes in the side of the shroud and into V-groove of opposite puller bar.
 - Tighten down the clamping knobs. Do not over tighten the knobs to avoid crushing the glass and prematurely wearing out the rubber clamp pads.
 - If you are pulling a fiber on a P-2000/F Puller, you may want to load the fiber through the slot in the rather than inserting it sideways. All other steps are as described for glass capillaries.
7. Close the lid. The laser will not turn on unless the lid is fully closed. If you are pulling a long fiber, you may have to coil the ends up underneath the lid or route them out through the small gap under the edge of the lid. To ensure consistent results, make sure the ends of the fiber do not interfere with free movement of the puller bars.
 8. Press the <PULL> key on the keypad. The laser should turn on and the glass should separate in less than 10 seconds².
 9. Loosen the clamping knobs and remove the pipettes from the puller bars.

Unless otherwise stated on your program sheet, Program 0 is factory pre-programmed to pull a micropipette (tip diameter less than 0.05 micron) from 1.0mm x 0.7 mm Quartz glass. Program 2 is factory pre-programmed to pull a patch type pipette (with a tip diameter of about 1 micron) from 1.0mm x 0.7 mm Quartz glass.

To try pulling a patch pipette load program 2:

1. Press RESET to exit Program 0
2. Press 1 <ENTR> to enter into Program 1.
3. Repeat steps 5-9 above.

² If the glass fails to separate in about 50 seconds, the Laser will automatically shut off and the LASER ON warning light above the puller bars will go off. Once this time out mechanism has been activated you will have to press the STOP key on the keypad or the RESET button on the front panel to continue.

3.2 Front Panel

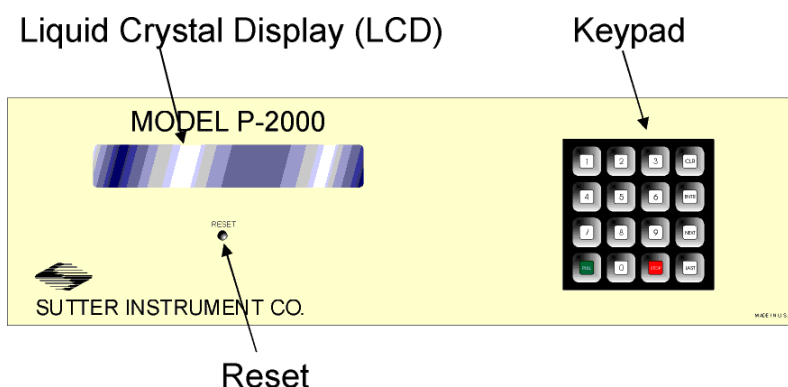

Figure 3-2. P-2000 Front Panel

3.2.1 Controls

LIQUID CRYSTAL DISPLAY	Displays program parameters and information about the loaded program as well as software control functions (see section 3.5).
RESET	Re-initializes the controller. Re-initialization also exits any loaded program or software control function submenu.
KEYPAD	Used to program parameter values and execute programs
0-9	Used for choosing the desired program or control function, entering numeric values when programming and to make YES/NO (1/0) decisions
CLR	Used to delete a program or numeric values entered into those programs. This key is also used to access software control functions (see section 3.5).
ENTR	Used to enter new values
NEXT	Used to move to the next line in a program while editing
LAST	Used to move to the previous line in a program while editing
PULL	Initiates the execution of a program
STOP	Aborts the execution of a program

3.2.2 Display

The P-2000 has a four line Liquid Crystal Display. The following figure demonstrates what you will see after you have selected a program. A brief description of each parameter is provided below.

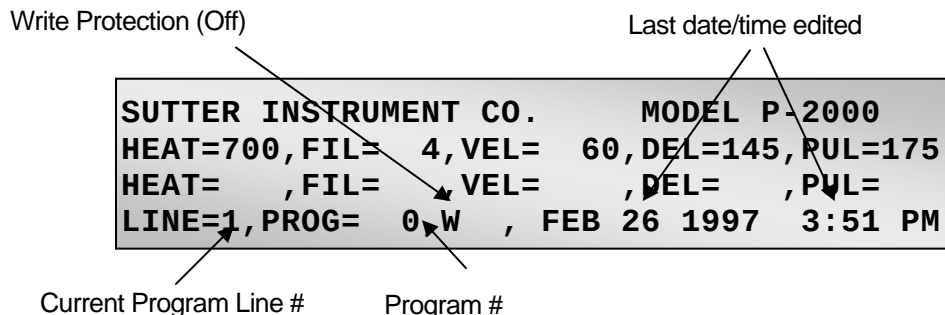

Figure 3-3. LCD Display (program information)

PROGRAM Range: 0 to 99. A program consists of one or more cycles (“Lines”) which, when executed in sequence, will “pull” the capillary glass inserted in the instrument. A program can be up to 8 Lines in length. A **Line** consists of five programmable parameters; **HEAT**, **FILAMENT**, **VELOCITY**, **DELAY** and **PULL**. The sequence of events during execution of a Line / Cycle is described in section 3.4 Pull Cycle.

WRITE PROTECTION **WP**: Write protection enabled. No edits can be made.
W: Write Protection disabled. Edits are possible
 When a program is copied, the status of write protection is copied along with the program parameters. All factory sample programs have write protection enabled.

DATE/TIME Reports the date and time that the program was last edited.

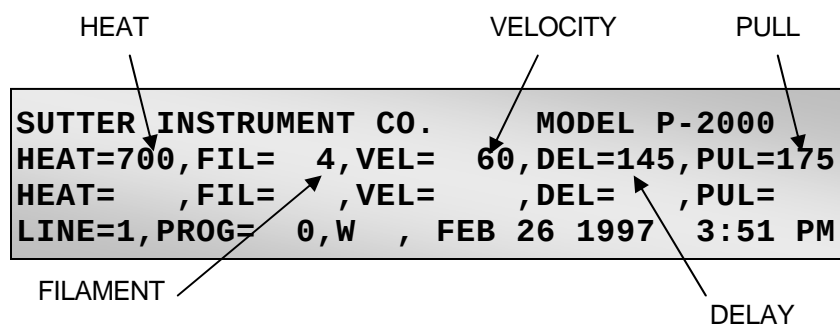

Figure 3-4. LCD Display (program parameters)

- HEAT** Range: 0 to 999. HEAT specifies the output power of the laser, and consequently the amount of energy supplied to the glass. See sections 3.3 Programs and 3.7 Parameter Adjustment for more details.
- FILAMENT** Range: 0 to 15. FILAMENT (FIL) specifies the scanning pattern of the laser beam that is used to supply HEAT to the glass. See sections 3.3 Programs and 3.7 Parameter Adjustment for more details).
- VELOCITY** Range: 0 to 255. The VELOCITY (VEL) parameter specifies the velocity at which the puller bar must be moving before the hard pull is executed. See sections 3.3 Programs and 3.7 Parameter Adjustment for more details.
- DELAY** Range: 0 to 255. The DELAY (DEL) parameter controls the timing of the start of the hard pull relative to the deactivation of the laser. See sections 3.3 Programs, 3.4 Pull Cycle and 3.7 Parameter Adjustment for more details.
- PULL** Range: 0 to 255. The PULL parameter controls the force of the hard pull. See sections 3.3 Programs, 3.4 Pull Cycle and 3.7 Parameter Adjustment for more details.

3.3 Programs

3.3.1 Program Structure

The ultimate size and shape of a micropipette made using the P-2000 are determined by the parameter values that are programmed by the user. One hundred separate programs can be saved in positions 0 through 99 for future use. Each of those programs is structured as follows:

- PROGRAM** Consists of one or more **CYCLES** (“Lines”) which, when executed in sequence, will “pull” the capillary glass inserted in the instrument. A program can be up to 8 cycles in length.
- CYCLE** A cycle consists of five programmable parameters; **HEAT, FILAMENT, VELOCITY, DELAY** and **PULL**. A **CYCLE** is equivalent to one line of **PROGRAM** code.

3.3.2 Cycle Parameters

The four programmable parameters in a **CYCLE** are defined below:

- HEAT** Range: 0 to 999. This parameter specifies the output power of the laser, and consequently the amount of energy supplied to the glass. The **HEAT** required to melt a piece of glass is a function of the “**FILAMENT**” that has been selected and the particular glass size and composition. It is important that the **HEAT** value be set relative to the **RAMP** Test value as discussed in the Operation section. The typical starting range of **HEAT** settings is around 350 for borosilicate glass, 400 for aluminosilicate glass, and 700 to >900 for quartz. Changes to **HEAT** should be made in steps of about 10 units since in most cases smaller changes have little effect.

FILAMENT Range: 0 to 15. **FILAMENT (FIL)** specifies the scanning pattern of the laser beam that is used to supply **HEAT** to the glass. The P-2000 is preprogrammed with scanning pattern values (**FILAMENTS**), each of which defines the longitudinal length and the rate of the scan. The length of the region scanned is analogous to the width of the area heated by a conventional metal heating filament. Changing the laser power (heat) distribution within a heated region is analogous to changing the filament type in our conventional pullers. The following table lists the scan length and distribution for each **FILAMENT** value. **FILAMENTS** also define the distribution of heat within the scanning length

Table 3-1. **FILAMENT** scan pattern values.

FILAMENT #	Scan Length	Equivalent FILAMENT #s	
0	1 mm		
1	1.5 mm	6	11
2	1.9 mm	7	12
3	4.5 mm	8	13
4	6.5 mm	9	14
5	8 mm	10	15

NOTE: Although there are 16 different **FILAMENT** values, the current version of the P-2000 firmware supports only six (0 through 5) unique scanning patterns. The range of values 6 through 10 duplicates the last five settings of the first range (1 through 5), as does the last range (11 through 15). E.g., Using a **FILAMENT** value of 6 or 11 is identical to 1; 7 or 12 is identical to 2, and so on (see Table 2).

VELOCITY Range: 0 to 255. The **VELOCITY** of the glass carriage system is measured as the glass softens and begins to pull apart under a constant load. The increasing velocity of the initial pull is determined by the viscosity of the glass, which, in turn, is a function of the glass temperature. Therefore, the velocity is and indirect, yet highly accurate way of measuring the glass temperature. The **VELOCITY** parameter allows for the selection of a precise glass temperature as the trip point for the hard pull. Useful values for **VELOCITY** range from 10 to 100, with lower values being used for patch and injection pipettes and higher values for micropipettes.

PULL Range: 0 to 255. This parameter controls the force of the hard pull. In general, the higher the pull, the smaller the pipette's tip diameter and the longer the taper. A change of one unit represents a change of 4 mA of current through the pull solenoid. Changes in **PULL** strength of 10 units or more are typically required to see an effect.

DELAY

Range: 0 to 255. The DELAY parameter controls the time between when the HEAT turns off and when the hard PULL is activated. The higher the DELAY value, the cooler the glass will be when the hard PULL is executed. Thus, increasing the DELAY results in decreased taper length and increased tip diameter. The range of DELAY values (0-255) is timed to allow the hard pull to be initiated at the same time as the deactivation of the laser when the DELAY value = 128. If the DELAY value is greater than 128, the hard pull will be initiated after the deactivation of the laser. If the DELAY value is less than 128, the hard pull will be initiated before the deactivation of the laser. See section 3.4 Pull Cycle for a graphic representation of the temporal relationship of the pull cycle events.

3.4 Pull Cycle

A typical PULL CYCLE in a PROGRAM (where PULL is greater than 0) is described below:

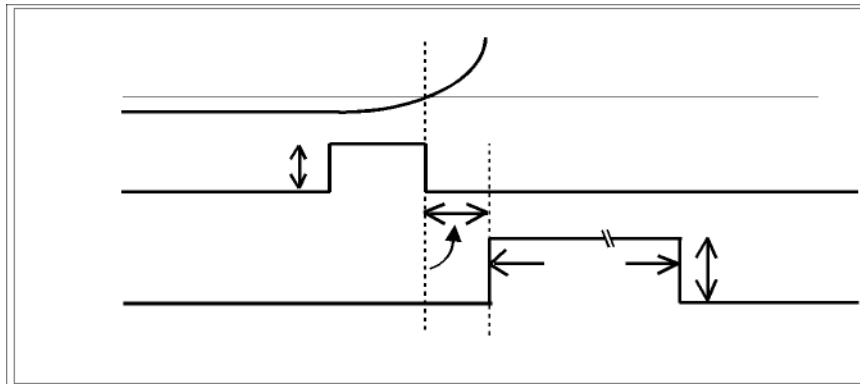

Figure 3-5. Pull cycle when DELAY is greater than 128

1. The HEAT turns on.
2. The glass heats up and a weak pull draws the glass out until it reaches the programmed VELOCITY (Trip Point).
3. If DELAY = 128 HEAT turns off and hard PULL is activated
 - If DELAY is greater than 128 HEAT turns off and hard PULL is activated after (DELAY-128) msec.
 - If DELAY is less than 128 Hard PULL is activated and HEAT turns off after (128-DELAY) msec.

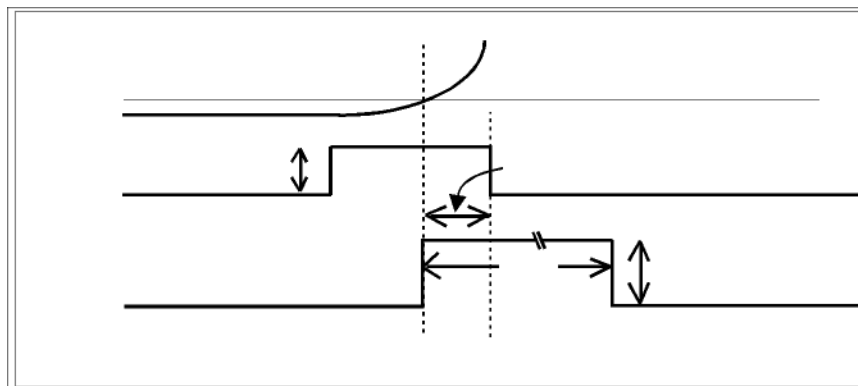

Figure 3-6. Pull Cycle when DELAY is less than 128

3.4.1 Default Configuration

Unless special programming or setup was requested by you at the time of purchase, the puller was set up and shipped with the following standard factory configuration (O.D. = outside diameter, I.D. = inside diameter):

Table 3-2. Standard factory configuration

P-2000/G	Large, Double-grooved Puller Bars (Figure 1-3C) and Glass Shroud Installed	For greater than 0.6mm diameter pipettes
	Glass used to program puller (sample sent with puller)	1.0 mm O.D. x 0.7 mm I.D. Quartz, without internal filament (catalog #Q100-70-7.5)
P-2000/F	Fiber-grooved Puller Bars (Figure 1-3A) and Fiber Shroud Installed	For optic fibers 125 μ m and greater, fused-silica tubing and glass up to 1 mm O.D.
	Glass used to program puller	???

In describing the operation of the puller, the above configuration is assumed. If the configuration of your puller differs, the operating instructions still apply but references to specific program settings may not be accurate. In general, inappropriate program parameters will only affect your ability to control the geometry of the glass micropipette you are trying to fabricate. Damage to the instrument caused by inappropriate program parameters has not been reported. The following table shows the programs that have been installed at the factory:

Table 3-3. Default Programs.

Glass Type	Glass Size	Application	Program #	Program Description					
				Line #	HEAT	FIL	VEL	DEL	PUL
Quartz	1.0mm O.D. x 0.7mm I.D.	Micro-Electrode	0	1	700	4	60	145	175
		Patch Pipette	2	1	700	4	55	130	55
	1.0mm O.D. x 0.5mm I.D.	Patch Pipette	1	1	700	4	55	132	55
		Long Micro-pipette	6	2	750	4	50	127	55
	1.5mm O.D. x 0.75mm I.D.	Patch Pipette	9	1	925	4	40	130	40
				2	875	4	60	126	60
Boro-silicate	1.0mm O.D. x 0.5mm I.D.	Micro-Electrode	10	1	350	4	50	225	150
		Patch Pipette	11	1	350	4	30	200	0
Alumino-silicate	1.0mm O.D. x 0.58mm I.D.	Micro-Electrode	20	1	400	4	50	225	150
		Patch Pipette	21	1	400	4	30	200	0
		??	22	1	400	3	10	200	0
??	??		50	1	500	5	50	128	0
N/A	N/A	Scan Mirror	51	1	200	5	0	40	0
Quartz	125 μ m	Optic Fiber	3	1	225	0	20	126	150

3.4.2 Selecting a Program [0 to 99]

After applying power to the instrument, a power-on reset will occur and the display will appear as follows:

WHICH PROGRAM DO YOU WANT? (0 - 99)
COPYRIGHT SUTTER INSTRUMENT CORP. 1995

Figure 3-7. Power-on Display

The P-2000 has the capacity to store 100 programs (0 - 99). On the keypad, press <0> and <ENTR> to call the factory installed micropipette program #0 (for thin wall, 1.0 mm quartz), or the number of another program you wish to execute. The display will appear as shown below (numerical values may vary). Please refer to the FRONT PANEL chapter and the beginning of this chapter for a full description of the PARAMETERS shown.

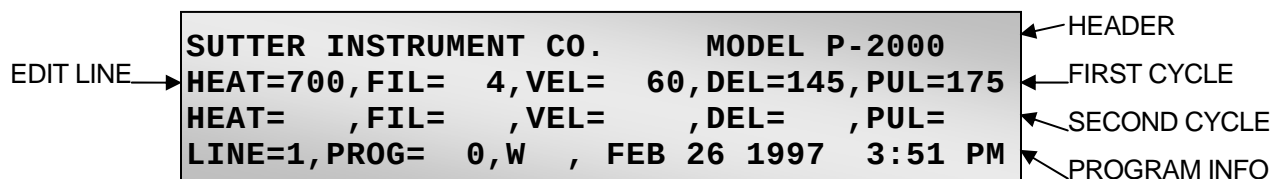

Figure 3-8. P-2000 Program (Initial) Display

To select a different program, press **<RESET>** to bring up the sign-on prompt then press the number of the desired program (0 to 99) followed by **<ENTR>**.

3.4.3 Viewing a Program [NEXT] / [LAST]

The front panel display (LCD) displays three adjacent lines (CYCLES) of a PROGRAM at one time. The **<NEXT>** and **<LAST>** keys allow you to view all 8 program CYCLES by scrolling through them on the LCD. When you first select a PROGRAM, the display above will appear (Figure 3-8). The first line in every program screen is a HEADER LINE showing the puller Manufacturer and Model. This information will appear on the first line of the LCD every time a program is initially selected, but will “scroll” off the display as the programs with multiple CYCLES are reviewed (see below). The second line of the LCD screen is the EDIT LINE. That is where the parameters defining a pull CYCLE of a program must appear in order for them to be edited (see section 3.4.5 Editing a Program). The parameters defining the FIRST CYCLE of a program will appear in the EDIT LINE when the program is initially selected. The third line of the LCD will display the CYCLE subsequent to the one in the EDIT LINE. The fourth line on the LCD will always contain PROGRAM INFO (information about the PROGRAM that is presently loaded), as described in the FRONT PANEL chapter.

- To view CYCLE 3 of a program: Press the **<NEXT>** key. CYCLES 1, 2 and 3 will then be displayed (CYCLE 2 will be on the EDIT LINE).
- To view CYCLE 4 of a program: Press **<NEXT>** again. Lines 2, 3 and 4 will be displayed.
- To scroll back to CYCLE:1 Press **<LAST>**. Lines 1, 2 and 3 will then appear.

3.4.4 Clearing a Program from Memory [CLR]

To clear the values of a particular program from memory press the CLEAR [CLR] key.

Pressing the **<CLR>** key gives you the following message:

**DO YOU WISH TO CLEAR ALL VALUES FROM THE
PRESENT CYCLE TO THE END? NO=0 YES=1**

Figure 3-9. Clear Program Display

Entering **<1>** will clear the PROGRAM from the line the cursor is on to the end of the PROGRAM. If the cursor is on CYCLE 1, the entire program will be cleared from memory. If the cursor is on line 2, line 1 will be preserved, and lines 2-8 will be cleared. It does not

matter in which parameter field the cursor is positioned; the entire line the cursor is on will be cleared.

3.4.5 Editing a Program

Select a program number (e.g., 10). If there are already values entered, make sure that this program was not entered by another user of the puller. Unused program areas are usually cleared before a puller is shipped, but occasionally test program values may be left in memory. We recommend that unused programs be cleared before proceeding.

3.4.5.1 Entering a new program

After selecting or clearing a program area the cursor will be blinking at the HEAT parameter on line 1. To become familiarized with program entry, put in the following sample micropipette program:

Heat	Fil	Vel	Del	Pull
400	4	60	130	150

Press the series of numbers <400> to enter the HEAT value of 400. The cursor will automatically tab over to the FILAMENT parameter.

Enter <4> for FIL. The cursor will remain there, blinking. **Note that when fewer than three digits are entered, the cursor will not automatically tab to the next field.** You must press <ENTR> to enter the value and tab to the next field.

Enter <60> for VEL. Again, the cursor will remain in the current field, blinking. You must either press <ENTR> to enter the value and tab to the next field, or enter the parameter value with leading zeros (i.e., <060>) to achieve a three-digit input.

Enter <130> for DEL. The cursor will automatically tab over to the PULL parameter.

Enter <150> for PULL. The cursor will automatically tab to the next field, which is the HEAT parameter in Cycle 2.

3.4.5.2 Editing an Existing Program

To edit the value of a parameter in a particular CYCLE, the cursor must be blinking in the field you want to edit. If necessary, press <NEXT> or <LAST> to scroll to the CYCLE you want to change. Press <ENTR> to tab the cursor to the field you want to change, and enter the new value. In our example above, to change the value of VELOCITY in Line 1 you first press <LAST> to scroll up to CYCLE 1. Then press <ENTR> two times to tab over to the VELOCITY field. Note that the values for HEAT and PULL remain unchanged. Enter a new value (e.g. 90) and if the value is two digits, press <ENTR> to enter the value. The cursor will be positioned on the DEL field in CYCLE 1. To move to CYCLE 2, press <ENTR> twice to “tab” over to the HEAT field in CYCLE 2.

The program values above are only given to demonstrate data entry procedures. Useful program values to pull the pipette that you want will be discussed in Chapter 3.7 Parameter Adjustment. In general, inappropriate settings will only affect your ability to control the geometry of the glass micropipette you are trying to fabricate. Damage to the instrument caused by inappropriate program parameters has not been reported.

3.5 Software Control Functions

The P-2000 has several software CONTROL FUNCTIONS that allow you to run TEST procedures, RESET the TIME/DATE, COPY programs and WRITE-PROTECT your programs. These CONTROL FUNCTIONS are accessed through the <CLR> key. Pressing <CLR> gives you the following message:

**DO YOU WISH TO CLEAR ALL VALUES FROM THE
PRESENT CYCLE TO THE END? NO=0 YES=1**

Figure 3-10. Access to Control Functions

Entering <0> (NO) will provide you with access to the following P-2000 CONTROL FUNCTIONS:

Table 3-4. Control Functions.

Function #	Function Name	Description
1	RAMP TEST	Run the Ramp Test
2	WRITE-PROTECT THIS PROGRAM	Set the write protection on or off WP = ON; W = OFF
3	RESET TIME AND DATE	Set the clock and the calendar date
4	MEMORY TEST	Test the integrity of the RAM
5	COPY A PROGRAM	Make a copy of a program

The five CONTROL FUNCTIONS will be displayed as shown below. Select the desired CONTROL FUNCTION by pressing the corresponding numeric key. Each CONTROL FUNCTION is more completely described in the next section.

**DO YOU WISH TO ACCESS A FUNCTION? NO = 0
RAMP TEST = 1, WRITE PROTECT THIS PROG
= 2, RESET THE TIME AND DATE = 3, MEMORY
TEST = 4, COPY A PROGRAM = 5**

Figure 3-11. Control Function Menu

3.5.1 RAMP TEST <1>

In the filament-heated Sutter micropipette pullers, the RAMP TEST allows the user to systematically establish HEAT values required to melt the glass with any given combination of FILAMENT and glass. With the P-2000, this significantly taxes the thermal resistance of the unit and reduces its operational lifetime. The RAMP TEST should only be run when troubleshooting or when instructed to do so by Sutter Technical Support personnel. For a discussion of how the HEAT ON value is used in place of the RAMP TEST value see sections 3.6 Pulling Pipettes and 3.7 Parameter Adjustment.

To run the ramp test, press <1> to choose RAMP TEST when the CONTROL FUNCTIONS menu is displayed. The following message will then be displayed.

INSERT THE GLASS. CLAMP AND PRESS PULL

Figure 3-12. Insert-glass, clamp, and pull prompt.

After pressing PULL to execute the RAMP TEST, the following events take place:

1. The puller prompts the user to choose a FILAMENT.³

**WHICH FILAMENT DO YOU WISH TO USE?
0 TO 15 THEN PRESS ENTER**

Figure 3-13. Filament-selection prompt.

2. Once the FILAMENT value is entered, the laser turns on at full power for 250 msec.
3. The voltage is then decreased until the laser output reaches a pre-set, minimum value.
4. The laser command voltage is set to correspond to a HEAT value of 150.
5. The scanning mirror rotates to focus the laser beam on the glass and the laser voltage (HEAT) is slowly incremented.
6. Puller bars begin to move apart as the laser output begins to soften the glass.
7. The laser is turned off when a factory-preset VELOCITY is achieved.
8. The RAMP TEST value shown on the display is the HEAT value that was required to reach the factory-set RAMP TEST VELOCITY.

To reset the display at the conclusion of a RAMP TEST or interrupt the RAMP TEST press **RESET**.

3.5.2 WRITE-PROTECT THIS PROG[RAM] <2>

This CONTROL FUNCTION sets the WRITE PROTECTION status for the program currently loaded. When WRITE PROTECTED, that program cannot be edited and it cannot be over-written by someone copying another program to that program number. It is recommended that this feature be used when there is any chance that the puller will be used by more than one person. This option is chosen by pressing <2> when the CONTROL FUNCTIONS menu is displayed. The following message will then be displayed:

³ NOTE: Although there are 16 different FILAMENT values, the current version of the P-2000 firmware supports only six (0 through 5) unique scanning patterns. The range of values 6 through 10 duplicates the last five of the first range (1 through 5), as does the last range (11 through 15). E.g., Using a FILAMENT value of 6 or 11 is identical to 1, 7 or 12 is identical to 2, and so on.

**TO BE ABLE TO EDIT THE PROGRAM PRESS 0
TO WRITE PROTECT THE PROGRAM PRESS 1**

Figure 3-14. Prompt to edit or write-protect the program.

After setting the WRITE PROTECTION, the display will return to the PROGRAM DISPLAY and the WRITE PROTECTION status will be shown on the PROGRAM INFO (bottom) line.

W = WRITE PROTECT IS OFF

WP = WRITE PROTECT IS ON

3.5.3 RESET TIME AND DATE <3>

This function allows you to set the system clock. The clock is used to establish the date and time of the last program edit as displayed on the program header line. This option is chosen by pressing <3> when the CONTROL FUNCTIONS menu is displayed. The following message will then be displayed:

ENTER THE MINUTES (1-60):

Figure 3-15. Time/Date Minutes prompt.

Once entered, a series of five more similar prompts will be displayed to set the HOUR, AM/PM, DAY-OF-THE-MONTH, MONTH, and YEAR.

NOTE (Entering Time and Date Information): Each date and time component is entered as two digits, using a leading zero as necessary. For example, enter “01” if intending a 1 for the month, day, hours, or minutes. Do not press the ENTR key to terminate an entry. When the requisite number of digits for date/time is entered, the value will be accepted and the next prompt is automatically displayed. The only exception is the AM/PM prompt: Only a single digit is entered (“0” for AM or “1” for PM).

NOTE (Entering the Year): Only the last two digits of the year are entered in response to the year-entry prompt. Based upon what is entered, the system’s software will automatically determine whether the year falls within the 1900’s or 2000’s (20th or 21st century). The year in a program’s date will not be updated until that program is exited and reloaded.

After setting the TIME and DATE, the display will return to the PROGRAM DISPLAY.

3.5.4 MEMORY TEST <4>

This CONTROL FUNCTION will perform a non-destructive test of the RAM. Press RESET to reset the system after performing this test. This option is chosen by pressing <4> when the CONTROL FUNCTIONS menu is displayed. The following message will then be displayed:

**DO YOU WANT TO DO A NON-DESTRUCTIVE
MEMORY TEST NO = 0 YES = 1**

Figure 3-16. Initiate-Memory-Test prompt.

To perform the test, press <1>. To return to the PROGRAM DISPLAY, press <0>.

After performing the MEMORY TEST, you must press RESET to return to the PROGRAM DISPLAY.

3.5.5 COPY A PROGRAM <5>

This CONTROL FUNCTION will make a copy of any program and assign a new program number to the copied version. This function is especially useful when you want to make a new program that varies only slightly from an existing one.

This option is chosen by pressing <5> when the CONTROL FUNCTIONS menu is displayed. The following message will then be displayed:

**WHICH PROGRAM DO YOU WANT TO COPY?
TO WHICH PROGRAM NUMBER?**

Figure 3-17. Program-to-Copy and To-Which-Number prompts.

After the required values have been entered, the new program (the copy) will be loaded. Copying a program will overwrite any program settings already stored at the new program number UNLESS those settings are WRITE PROTECTED. This is a good reason to ALWAYS WRITE PROTECT YOUR PROGRAMS! If you attempt to copy a program to a WRITE PROTECTED program number, the following message will be displayed briefly:

**THAT PROGRAM IS WRITE PROTECTED. NO
CHANGES ARE ALLOWED.**

Figure 3-18. Message indicating program is write-protected and therefore it cannot be changed.

The status of write protection in the original program is copied along with the pull parameters.

3.6 Pulling Pipettes

3.6.1 Procedures

To pull a micropipette:

1. Load the glass into the puller as described in section 3.1 First Time Use.
2. Press <0> on the keypad to view Program 0.
3. Inspect the parameter values displayed for Program 0. Program 0 should display the factory-installed values listed in Table 3-3 and on the enclosed program sheet.
4. Press the <Pull> key on the keypad. The laser will turn on and the glass should separate after less than 5 seconds. The display will then report the number of times the program “looped” and the total time that the HEAT was on as shown below:

```
THIS PROGRAM LOOPED 1 TIMES.  THE LAST
LINE USED WAS 1.  HEAT ON SEC. = 3.54
```

Figure 3-19. Pull cycle report

5. Loosen the clamping knobs and remove the pipettes from the puller bars.

Unless otherwise stated on your program sheet, Program 0 is factory pre-programmed to pull a micropipette (tip diameter less than 0.1 micron) from 1.0mm x 0.7 mm Quartz glass. It will pull the pipette in one heating cycle or “loop”. The time reported is very useful for developing programs and will be discussed in the **Parameter Adjustment** section.

3.6.1.1 Looping

A feature of the P-2000 is its capability to loop through a program. This is demonstrated with the multi-cycle Program 1, which is factory pre-programmed to pull a patch type pipette with a tip diameter of about 2 microns from 1.0mm x 0.5 mm Quartz glass. Press RESET to exit Program 0 and then press <1> to enter into Program 1. The display for Program 1 should read similar to the following:

```
SUTTER INSTRUMENT CO.      MODEL P-2000
HEAT=700, FIL= 4, VEL= 55, DEL=132, PUL= 55
HEAT=700, FIL= 4, VEL= 50, DEL=127, PUL= 55
LINE=1, PROG= 0, W , FEB 26 1997 3:51 PM
```

Figure 3-20. Sample program.

To demonstrate the Looping function, load some 1.0mm x 0.5mm Quartz glass into the puller and press <PULL> using the above sample program. The Laser should cycle on and off repeatedly. Here is a detailed description of the events that lead to a successful pull in this example:

1. After the PULL key is pressed line 1 is executed:

HEAT ON. The Laser turns on and melts the glass allowing it to draw apart by the gravitational force of a weight in the base of the P-2000.

HEAT OFF. When the velocity of the puller bars clamping the ends of the glass reach the trip point (VELOCITY=55 in this case), the Laser turns off.

PULL. The DELAY setting of 132 causes a 4 ms delay ($132-128^4$) between Laser deactivation and the application of a “hard” pull (PULL=55) by the solenoid in the P-2000 base.

2. Then line 2 of the program is executed:

HEAT ON. The Laser turns on and melts the glass allowing it to draw apart further by gravitational force.

PULL. In this case, the DELAY setting (127) is less than 128. When the velocity of the puller bars that clamp the ends of the glass reach the trip point (VELOCITY=50 in this case) the “hard” pull is applied (instead of Laser deactivation occurring).

HEAT OFF. The time increment between the “hard” pull and the laser deactivation is determined by the DELAY setting: $128-127 = 1$ ms, in this case.

3. Since the glass does not separate after these two lines have been executed the program loops back to execute the first line again:

HEAT ON. The Laser turns on and melts the glass allowing it to draw apart by gravitational force.

HEAT OFF. When the velocity of the puller bars clamping the ends of the glass reach the trip point (VELOCITY=55 in this case) the Laser turns off.

PULL. The DELAY setting of 132 causes a 4 msec delay ($132-128$) between Laser deactivation and the application of a “hard” pull (PULL=55) by the solenoid.

4. If the puller detects that the glass still has not separated it will continue to line 2. If the glass does not separate after that pull the P-2000 will loop back to line 1 and continue as described above until the glass finally pulls apart.

This looping capability is particularly useful for fabricating patch pipettes that require multiple HEAT cycles with relatively weak PULL values to form the characteristic stubby geometry.

3.6.1.2 Pull Results

When the pull is complete, the PULL RESULTS will be displayed in a manner similar to the following example:

⁴ A DELAY of 128 units corresponds to a delay of 0 ms between laser deactivation and the application of the hard pull. See section 3.4 Pull Cycle for details.

```

THIS PROGRAM LOOPED 2 TIMES.  THE LAST
LINE USED WAS 1.  HEAT
HEAT=750, FIL= 4, VEL= 50, DEL=127, PUL= 55
LINE=1, PROG= 0, W , FEB 26 1997  3:51 PM

```

Figure 3-21. Pull cycle report (multiple-loops).

NOTE: The two bottom lines of the display may not clear when the PULL RESULTS are written to the top two lines. This is normal. The meanings of the values shown are described below:

PROGRAM	The first result of the program execution that is shown is the number of “LOOPS”
LOOPS	The number of loops required to complete the pull. The value given (2 in the above example) refers to the number of times that the first cycle (or line) of a program was executed. In the above example, the “2” indicates that the program ran all of its CYCLES once and then “looped” back to execute the first CYCLE a second time.
LAST LINE	This result (1 in the above example) indicates the last LINE (or CYCLE) of the program
USED	Line number that was executed to complete the pull.
HEAT ON	This third result (3.54 in the above example) is the total time (in seconds) that the laser is directed at the glass. This value should remain very constant from pull to pull using the same program and type of glass. It is useful, therefore, as an indicator of changes in the alignment of and/or the cleanliness of the mirrors in the optical pathway (see <i>Notes on Program Operation</i> , below).

3.6.2 Notes on Program Operation

3.6.2.1 HEAT ON

It was mentioned in the SOFTWARE CONTROL FUNCTIONS chapter that the HEAT ON feature subordinates the RAMP TEST. The latter is typically used in filament-heated pullers built by Sutter to evaluate the efficiency of a given heat source (a filament) in melting a given type of glass. Information analogous to the RAMP TEST value can be more conveniently determined (and with less detriment to the instrument’s circuitry) from the PULL RESULTS displayed on a P-2000 puller after each PULL. The HEAT ON value that is given there will change very little unless there has been a change in the type of glass being used (e.g., a thicker wall will increase the value) or there has been a change in the efficiency of light transmission along the optical pathway (e.g., dirt on the retro mirror will increase the value). For this reason, the HEAT ON value for any given combination of glass and program you use should be recorded somewhere for future reference (along with the program’s cycle parameters). It should be noted that the variability of the HEAT ON value for any given glass/program combination will be greater when the program being used has relatively low HEAT setting(s). A more thorough description of how to use the HEAT ON value to adjust

parameters is found in the next chapter. A description of how to respond to an unexpected change in the HEAT ON value for a given combination of glass and program is given in the maintenance section.

3.6.2.2 Program Memory

All programs entered into memory remain there even after the power is turned off or the RESET switch is toggled. A special memory “chip” that carries its own battery back up will retain stored information for as long as ten years without power being applied to the instrument. In spite of this, it is strongly suggested that you keep a written record of your programs in case of unexpected difficulties.

3.7 Parameter Adjustment

3.7.1 General Information

Fabrication of micropipettes and microinjection needles, patch pipettes, optic fibers and electropray tips are sufficiently different that the following information on parameter adjustments has been divided into four separate sections: **Micropipette/microinjection needle fabrication**, **Patch pipette fabrication**, **Optic fiber fabrication** and **Electropray tip fabrication**. Please note that the programs referred to in the following text are not necessarily meant to pull tip shapes and sizes suited for everyone’s application. In fact, unless your puller was configured to do so you may not be able to pull glass of a diameter less than 0.6mm. Reading through all of the descriptions though should help you to gain a better understanding of program development even though you may not intend to fabricate all of the tips discussed here.

3.7.2 Micropipette/Microinjection Needle Fabrication

3.7.2.1 Programs

The geometry of pipettes used for microinjection and microelectrodes are similar in that they both require long tapers and relatively small tips. This overall shape is accomplished by using relatively high HEAT and PULL settings and FILAMENTS with wide laser scanning patterns.

Consider the following single-line micropipette program for 1.0mm (outside diameter) quartz tubing:

Heat	Filament	Velocity	Delay	Pull
700	4	50	145	175

3.7.2.2 Selecting Program Parameters

HEAT (Laser Output Power) – The HEAT setting will affect the length and tip size of the pipette. Generally, higher HEAT settings tend to give longer and finer tips. The recommended starting HEAT value (700) has been determined at the factory. Variations from this value may be necessary to achieve the desired result. Although the HEAT can be set to any value desired with no danger of damaging the instrument, values lower than 200 should be avoided. At a HEAT setting of 200, a 1mm (outside diameter) x 0.7mm (inside diameter) quartz capillary tube will typically pull in 4 to 6 seconds after the PULL key is pressed. If the pull takes longer than eight seconds, and you are trying to pull a fine

micropipette, increase the HEAT in 10 unit increments until the pull takes place in less than eight seconds. If the pull occurs in less than three seconds, decrease the HEAT until the pull takes place in 4-8 seconds. For the best micropipette reproducibility with the finest tips, you should select a HEAT value that melts the glass in 4 to 5 seconds. If the pull takes 10 - 15 seconds, there will be inherently more variability in laser operation and pipette reproducibility will be compromised. In all cases, if the glass hasn't melted in less than 15 seconds increase the HEAT.

FILAMENT– The FILAMENT selected⁵ will also affect the time it takes to pull an electrode. Any FILAMENT can be used to form a microelectrode but wider FILAMENTS tend to work more effectively. If you find that a wide FILAMENT is not melting the glass, try dropping down to a narrower FILAMENT. This will apply more power per unit length of glass. If you use a multiple line program, you will probably discover that as the glass is drawn out the direct application of HEAT to the glass becomes even more effective. If the beam is not well centered on the glass as the glass draws out, you may find that the program stalls because the glass lies outside of the effective region of the Gaussian beam profile. You can try using a narrower FILAMENT with a slow scan rate. This will have the effect of applying more power to the section of the glass being heated.

VELOCITY (Trip Point) – The VELOCITY value determines the point at which the HEAT is turned off. VELOCITY reflects the speed at which the two carrier bars are moving during the weak pull. The lower the VELOCITY value, the slower the puller bars are moving when the trip point occurs. At the trip point, the HEAT is turned off, and after the programmed DELAY has occurred, the hard PULL is turned on.

Although the functional range of VELOCITY is from 1-255, the VELOCITY value is typically set between 45 and 60 for quartz micropipettes. For borosilicate or aluminosilicate micropipettes, VELOCITY values should be increased to 50 - 70.

In a multiple cycle program, it is possible for the glass to separate before the trip velocity is attained. If this happens, the glass is subjected to direct heating as it is separating. Such an occurrence can lead to difficulties in forming tips as well as lack of reproducibility. If you are using a one-line looping program, try decreasing the VELOCITY a few units at a time. If your program is a multi-line program, decrease the VELOCITY in the next to last line of the program. Decreasing the VELOCITY will increase the amount of glass left in the last cycle of program, allowing the glass to attain the trip velocity before separating.

DELAY – The DELAY controls the timing of the start of the hard PULL relative to the end of heating by the laser. The longer the DELAY, the cooler the glass will be when the hard pull occurs. When using a glass other than quartz, the required DELAY value will usually be 200 or more for microelectrodes. For quartz pipettes, the required DELAY value will usually be between 100 and 140.

PULL – Low values of PULL strength in the range of 40-75 will give larger tips while settings between 150-250 give the smallest tips. The PULL strength can be set to any value desired with no danger of damaging the instrument. Once the trip velocity is attained, the hard pull is turned on for 1 second after the programmed DELAY has elapsed.

⁵ NOTE: Although there are 16 different FILAMENT values, the latest version of the P-2000 firmware supports only six (0 through 5) different (unique) scanning patterns. The range of values 6 through 10 overlaps (duplicates) the last five of the first range (1 through 5), as does the last range (11 through 15). E.g., Using a FILAMENT value of 6 or 11 is identical to 1, 7 or 12 is identical to 2, and so on.

3.7.2.3 Glass Selection

Formulation – The steeper the temperature-viscosity relationship is for a given glass formulation the more sensitive the viscosity is to heat. The temperature-viscosity relationship of a glass will largely determine the evenness of the taper when the glass is drawn out to a shape characteristic of micropipettes and microinjection needles. Borosilicate has the least steep temperature-viscosity relationship. It is best suited for fabrication of long-tapered pipettes with relatively small tips. Quartz has the steepest relationship and is a little more difficult to pull without some inflection (i.e., secondary taper) near the tip. Aluminosilicate's temperature/viscosity relationship is intermediate between borosilicate and Quartz making it suitable for fabrication of long tapered pipettes but with more strength than borosilicate.

Your application may require the pipette or electrode to be as strong as possible to penetrate the target tissue or cell. Quartz is the strongest of the three formulations discussed above, borosilicate is the least strong and aluminosilicate is intermediate in strength to the two. Although stronger than borosilicate, quartz and aluminosilicate glasses tend to thin out at the tip. There is some compromise in evenness of the taper when choosing a glass for its greater strength.

Wall Thickness – The wall thickness of the glass is often chosen based on the minimum inside diameter (ID) that is allowable for a given protocol. The wall thickness of the glass being pulled will greatly influence the evenness of the taper as well as the minimal tip size that can be obtained. Thick wall glass should be used when pulling tip sizes less than 0.2 μ m in diameter, and will provide the most even taper. Thin wall glass is suitable for most pipettes when forming tips greater than 0.2 μ m, especially if some variation in the taper can be tolerated. Thick wall borosilicate glass will produce the most even taper to the tip.

Outside Diameter – The P-2000 is optimized for pulling glass that has an outside diameter (OD) of 1.0mm. When pulling slender microelectrodes it is sometimes desirable to reduce the component resistance by making the shank a little shorter in length. This can be accomplished and simultaneously maintain a small tip size by using a little smaller diameter glass. Glass larger than 1.0 mm can be difficult to pull with the P-2000 and is not advised. If it is necessary to use such glass, please refer to the chapter titled PULLING LARGE DIAMETER GLASS.

3.7.2.4 Glass-specific Parameter Adjustment

BOROSILICATE GLASS – This glass is usually easy to control. Proper melting may require HEAT values ranging from 250 to 500. With 1mm thick wall glass for example, 350 is a good HEAT setting to start with. Use a FILAMENT with a high scan rate, wide scan pattern (FILAMENT 4), and a moderate PULL strength (150). A relatively long DELAY (225) will be necessary to assure good separation of the glass when the hard pull occurs.

ALUMINOSILICATE GLASS – This glass has a higher melting point than borosilicate, and requires higher HEAT values (375-600). With 1 mm thick wall glass for example, 400 is a good HEAT setting to start with. The programs will otherwise be similar to those for borosilicate although aluminosilicate tends to cool slightly more quickly than borosilicate and may require a slight reduction in the DELAY setting.

FLINT OR SOFT GLASS – These glasses generally are 1.5 to 1.8 mm in diameter, which is greater than the 1 mm diameter standard for the P-2000. If the glass can be loaded without rubbing on the holes in the shroud, it may still be possible to use without adjustment of the

puller. The first heating cycle should be used to draw the glass down to near 1 mm diameter. This will produce an hourglass shape that is not well centered on the diameter of the original glass but which may be worked in about the same way as 1 mm glass. The means of clamping the glass will cause the center of larger diameter glasses to be displaced up and towards the user. This may place too much heat on the bottom of the glass and may melt the glass away from the center of the laser beam. See the chapter titled PULLING LARGE DIAMETER GLASS for more details.

QUARTZ – Quartz will require a HEAT value between 550 and 950, depending on the FILAMENT and glass diameter. With 1mm thin wall glass for example, 700 is a good HEAT setting to start with in conjunction with FILAMENT 4. Because of the high melting point and the steep temperature-viscosity relationship of quartz, the DELAY should be considerably shorter than that used for borosilicate and aluminosilicate glass (145), and the PULL setting should be greater (175). Generally, in order to lengthen a micropipette's taper, increase the HEAT setting and broaden the laser-scanning pattern. For example, use a HEAT setting of 825 and FILAMENT 5.

3.7.2.5 Sample Programs (for Quartz glass)

Since quartz is capable of producing both the strongest pipettes as well as the pipettes with the smallest tips, we will start with a program that combines these features. The following program values will produce a strong, stiff pipette with a tip diameter of less than 15 nanometers from 1.0 X 0.5 mm quartz.

```
HEAT 800  FIL 5  VEL 60  DEL 150  PUL 175
```

This DELAY value may be adjusted from 140 to 170 for the best result. For a bit longer taper, try increasing the HEAT value to 825 or 850. For a longer tip with a more gradual taper at the very end, try this program:

```
HEAT 900  FIL 5  VEL 65  DEL 150  PUL 250
```

The result will be a flexible pipette about 12 mm long.

This effect can be extended for a pipette of about 15 mm length by decreasing the VELOCITY and DELAY as in the following program:

```
HEAT 900  FIL 5  VEL 50  DEL 120  PUL 200
```

The standard program for thin-walled quartz (1.0mm X 0.7) is:

```
HEAT 700  FIL 4  VEL 60  DEL 150  PUL 175
```

This will produce a pipette about 8 to 10 mm in length and about 30 nanometers in diameter at the tip.

To obtain a shorter pipette with a larger tip, you can decrease the PULL to 150. For still pipettes with even larger tips, you may want to try a two line program.

```
HEAT 850  FIL 5  VEL 25  DEL 128  PUL 50
```

```
HEAT 700  FIL 4  VEL 50  DEL 130  PUL 150
```

3.7.3 Patch Pipette Fabrication

3.7.3.1 Programs

Patch pipette programs generally differ from programs for fine tips in three ways; the trip velocity is lower, the PULL strength is lower, and more than one heating cycle is used. The first heating cycles work to form the hourglass shape needed for the proper execution of the last line. The last heating cycle is responsible for forming the tip.

Consider the following sample patch program for 1.0 mm (outside diameter) by 0.5 mm (inside diameter) borosilicate glass:

Heat	Filament	Velocity	Delay	Pull
350	4	40	200	0

The P-2000 executes all programs line by line until either the glass separates or a blank line (zero for both VELOCITY and DELAY) is encountered. If the glass has not separated, the P-2000 will loop back to the start and again execute line by line. This will continue until the glass separates. A single-line program, such as the above example, may execute several times before the glass separates. On the other hand, the glass may separate before all lines of a multi-line program have been executed.

Single line programs are easy to write and edit and thus are a good starting point when developing new programs. Modification of a single line program to create a multiple line program is often necessary to better optimize a micropipette's geometry. The use of multi-line programs affords greater control over the ultimate tip size and shape since program values can be different on each line.

3.7.3.2 Selecting Program Values

HEAT – When the P-2000 is used with 1mm glass; heating is fairly uniform as the tubing draws down in diameter. Heating is also fairly uniform for 1.2 mm glass. With 1 mm or 1.2 mm glass, it is possible to draw patch pipettes with the same HEAT level in each heating cycle. Thus, it is possible to use a single program line and the looping feature to make patch pipettes with such glass.

When patch pipettes are made from tubing over 1.2 mm in diameter, the HEAT and VELOCITY values may require considerable adjustment from line to line. For 1.5 mm quartz tubing the HEAT in the first line may need to be over 900 with FILAMENT 4 to get the tubing to melt before the laser times-out. (NOTE: If a HEAT of 940 does not melt the tubing before the time-out, use FILAMENT 3 to get a more concentrated beam.) The HEAT in the second line usually needs to be about 875 to form a good tip.

The actual HEAT value used should be sufficiently high to allow the glass to melt 1 mm diameter glass in 5 to 15 seconds. For larger diameter glass, the best HEAT settings will produce longer melting times. A high HEAT that melts the glass in less than 5 seconds will cause no problem in the first heating but may heat the glass too quickly in subsequent heating cycles, causing tips to curve or one pipette to be much longer than the other.

When the point of greatest heating is centered on the tubing at the start of a pull the effectiveness of the heating tends to increase as the tubing is drawn down in size. This is a result of the beam shape and the action of the RETRO MIRROR. As the point of greatest heating moves away from the center of the tubing the user may find that the effectiveness of

heating actually decreases as the glass is drawn down. In the extreme case, the glass will not melt after a few heating cycles.

FILAMENT– As the HEAT is restricted to shorter and shorter lengths of glass the taper tends to become more rapid. The smallest scans (FILAMENTS 0,1,6,and 11 ⁶) are rather extreme in this regard and are difficult to use successfully. The larger diameter glasses are particularly troublesome with these small FILAMENTS. Remember that restricting the scan size will effectively concentrate the heat so that a given HEAT setting will melt the glass more quickly.

The effect of FILAMENT size on pipette shape becomes less evident after the glass diameter has been reduced by one or more heating cycles. As the glass necks down, the smaller diameter section of the glass will melt much more rapidly than the rest of the glass, automatically restricting the length of glass that will melt and be drawn out. Increasing the FILAMENT size after the first few cycles will act primarily to decrease the effective rate of heating.

VELOCITY – VELOCITY determines the point at which the HEAT is turned off. If the value is too high, the glass will separate after the first HEAT cycle. As the VELOCITY is decreased, the amount the glass is drawn-out by a given line will also decrease and more cycles will be required to form a tip. When possible, it is best to use values greater than 5 to avoid variability. The very narrow FILAMENTS may require lower velocities than the wider FILAMENTS.

Uneven heating can complicate the development of programs by changing the effect of VELOCITY values. When the heat is uneven around the circumference, the resistance to drawing-out will come mostly from the coolest segment. A great deal of heat can be delivered to the other segments before this cool segment yields. More heat than would be expected is required to achieve a given VELOCITY when the heating is uneven.

DELAY – Since the DELAY is the time between Laser deactivation (heat off) and the application of a hard pull the exact value is of little importance in a program that has little or no PULL strength set. This is the case in most patch programs. The DELAY will contribute to the overall time between heating cycles so that a major change in value will have an effect.

PULL. A constant weak pull is exerted on the glass that is caused by gravitational force on a weight located in P-2000's base. This can be felt when pulling the PULLER BARS into position while loading the glass. This amount of force is adequate to form relatively small tips (0.5 micron) with any glass other than quartz. If smaller tips are required, a moderate PULL (25-50) may be used in the last line of the program. If a PULL is used the DELAY will have more effect. If the DELAY is too great, the glass may break rather than draw down to a fine tip because it has had too much time to cool off before the hard pull begins.

3.7.3.3 Glass Selection

A wide range of glass diameters and formulations has been used for forming patch pipettes. The P-2000 will work with all known formulations of glass used for patch pipettes. The P-2000 was designed for use with 1 mm diameter glass tubing but 1.2 mm diameter glass can normally be used with little problem. Larger diameter glass, particularly thin-walled quartz,

⁶ NOTE: Although there are 16 different FILAMENT values, the latest version of the P-2000 firmware supports only six (0 through 5) different (unique) scanning patterns. The range of values 6 through 10 overlaps (duplicates) the last five of the first range (1 through 5), as does the last range (11 through 15). E.g., Using a FILAMENT value of 6 or 11 is identical to 1, 7 or 12 is identical to 2, and so on.

is more difficult to use. This is because the optical system is unable to evenly heat the glass around its circumference. When the heating is uneven, the resulting pipette will not be concentric and will have an uneven wall thickness. In the worst case, the wall becomes too thin and the pipette breaks at a large diameter than is desired.

The effects of uneven heating are more evident with thin-walled glass and with glass having a steep temperature-viscosity relationship (such as quartz and, to a lesser degree, aluminosilicate). The practical limit is 1.65 mm X 1.15 mm quartz tubing, although the resulting tips are not ideal. Thick walled tubing of 1.5 mm (outside diameter) should produce good tips with better control and reproducibility.

3.7.3.4 Glass-Specific Parameter Adjustment

BOROSILICATE GLASS – This glass is usually easy to control. Proper melting may require HEAT values ranging from 250 to 500. Usually no PULL strength is required.

ALUMINOSILICATE GLASS – This glass has a higher melting point than borosilicate, and requires higher HEAT values (375-600). The programs will otherwise be similar to those for borosilicate although aluminosilicate tends to cool slightly more quickly than borosilicate.

FLINT OR SOFT GLASS – These glasses generally are 1.5 to 1.8 mm in diameter, which is greater than the 1 mm diameter standard for the P-2000. If the glass can be loaded without rubbing on the holes in the enclosure, it may still be possible to use without adjustment of the puller. The first heating cycle should be used to draw the glass down to near 1 mm diameter. This will produce an hourglass shape that is not well centered on the diameter of the original glass but which may be worked in about the same way as 1 mm glass. The means of clamping the glass will cause the center of larger diameter glasses to be displaced up and towards the user. This may place too much heat on the bottom of the glass and may melt the glass away from the center of the laser beam.

QUARTZ – Quartz will require a HEAT value between 550 and 950, depending on which FILAMENT and glass diameter are used. Because of the high melting point and the steep temperature-viscosity relationship of quartz, the DELAY should be between 1 and 30.

In order to obtain useable tips some PULL strength (30 to 60) must be used in the last line of the program. The greater the pull, the smaller the resulting tip. Pull may also be used in earlier lines or in a single line program. In order to force the glass to separate in two heating cycles higher VELOCITIES (40 to 60) and shorter DELAYS (126-140) are used.

3.7.3.5 Optical System Adjustments

The adjustment of the mirrors can have a strong effect on the formation of patch pipettes. As the glass draws down in diameter the concentration of heat on the glass can increase or decrease depending on the positioning of the mirrors. If the incident beam and reflected beam are well centered on the glass the glass will stay in the center of the beam as it draws down and the heat will become more concentrated. If the beams are perfectly centered on the glass it is possible that the glass will melt away from the center of the beams as it melts. This becomes more critical when the glass has been drawn down to a small diameter by earlier heating cycles. See the MAINTENANCE chapter for a detailed discussion of the procedures for adjusting the mirror alignments.

3.7.3.6 Suggested Practices

- Avoid programs that require the glass to be drawn down to a very small diameter before the start of the last pull.
- Use thick-walled glass when practical, as it is much more tolerant of uneven heating. The information outlined in the manual may be applied in most cases when using thick-walled tubing so long as the outside diameter is between 1.0 mm and 1.5 mm.
- When using thin-walled glass for patch pipettes try to stick to two line programs. Use a low HEAT, particularly in the first line. A HEAT that requires 15 to 25 seconds to melt the tubing allows more time for the spread of heat in the glass. (Note that the puller will turn the laser off after about 50 seconds of heating if the glass does not pull apart.)
- Expect that changing the outside diameter of thin-walled tubing will have strong effects on the quality of patch pipettes produced.
- When using glass that is not evenly heated expect the glass to draw-out further than would otherwise be the case. Excess heat delivered to segments of the glass during uneven heating can also make it difficult to program for larger tip sizes.

3.7.4 Optic Fiber Fabrication

Quartz (fused silica) is the optical fiber material that is usually drawn into fine pointed optical probes. Typically, these fibers are pulled from 0.125mm stock down to 40nm diameters. The small diameter and flexibility of the fiber stock requires the P-2000 to be configured specifically for the purpose of fiber optic probe (and electrospray tip) fabrication. The required modifications must be performed by Sutter Instrument Company and should have been requested when the unit was ordered. These modifications include: installation and alignment of dedicated “fiber” puller bars, installation of a retro-reflective mirror shroud that has a groove across the top to allow for fiber loading, the alignment of the optical pathway to accommodate the small diameter of the fiber and installation of a sample program for pulling fibers.

3.7.4.1 Fiber Preparation

The quartz fiber used for making fiber optic probes has a plastic sheath that must be stripped back to expose the quartz material before loading it into the puller. Only the region that will be heated (about 1 cm) should be stripped. The sheath should be left intact on the regions that will be clamped in the puller bars.

3.7.4.2 Programs

Fiber optic tip diameters are typically in the range of about 40nm and have a taper length of about 1mm. A single cycle program that executes once is used to pull tips of this geometry.

Consider the following single-line micropipette program for 125 μ m (outside diameter) quartz fiber:

Heat	Filament	Velocity	Delay	Pull
300	0	18	126	150

3.7.4.3 Selecting Program Parameters

HEAT (Laser output power) – The HEAT setting will affect the length and tip size of the pipette. Generally, higher HEAT settings tend to give longer and finer tips. The

recommended range for the HEAT value is 280 to 350. The total time that the laser is heating the fiber can provide the user with very useful information for developing programs. At a HEAT setting within the range given above, 125 μ m O.D. quartz fiber will typically pull with a HEAT value of 0.14 seconds. The fiber tip diameter will be very sensitive to the HEAT setting.

FILAMENT– The “0” FILAMENT should always be used to pull fiber optic probes. A laser scan is not necessary to achieve such a small taper length and fiber diameter.

VELOCITY (trip point) – When pulling fiber optic probes the DELAY setting is less than 128. This means that the VELOCITY value determines when the hard PULL is initiated while the laser remains on. Because of the very small starting diameter of the typical optical fiber material, the trip point for the hard pull must occur at a relatively slow VELOCITY. The suggested range is 18-20. Tip diameter will be very sensitive to the VELOCITY setting.

DELAY – The DELAY controls the timing of the start of the hard PULL relative to the end of heating by the laser. The shorter the DELAY, the warmer the glass will be when the hard pull occurs. In fact, to produce the small tips used for fiber optic probes the DELAY must be set to cause the hard PULL to occur BEFORE the laser turns off. This is done by using a value less than 128. A value of 126 is recommended.

PULL – A relatively high PULL strength is required to separate the quartz fiber. A value of 150 is recommended.

3.7.5 Electrospray/Nanospray Tip Fabrication

Quartz (fused silica) is the tubing material that is used to fabricate fine tips used in electrospray procedures. Typically, these tips are pulled from 125 to 365 μ m stock down to 1 to 15 μ m diameter tips. The small diameter and flexibility of the quartz stock requires the P-2000 to be configured specifically for the purpose of electrospray (and fiber optic probe) fabrication. The required modifications must be performed by Sutter at the factory and should have been requested when the unit was ordered. Those modifications are: installation and alignment of dedicated small grooved “fiber” puller bars, installation of a retro mirror shroud that has a groove across the top to allow for fiber loading, and the alignment and optimization of the optical pathway for optical fiber and small diameter fused silica capillary.

3.7.5.1 Glass Preparation

The quartz glass used for making electrospray tips has a plastic sheath that must be stripped back to expose the quartz material before loading it into the puller. Only the region that will be heated (about 1 cm) should be stripped. The sheath should be left intact on the regions that will be clamped in the puller bars.

3.7.5.2 Programs

Electrospray tip diameters are typically in the range of about 1 to 15 μ m and have a taper length of about 1mm. In general, single cycle program that executes multiple times is used to pull tips of about 1 μ m with this geometry. Ideally, the program should loop 3 times.

A good starting point for developing a program for fused silica capillary with an outer diameter of less than 375 μ m is shown below. The following text (*Selecting Program Parameters*) describes how the program parameters can be adjusted to give the desired tip geometry.

Heat	Filament	Velocity	Delay	Pull
225	0	30	128	0

3.7.5.3 Selecting Program Parameters

HEAT (Laser output power) – The HEAT setting will affect the length and tip size of the pipette. Generally, higher HEAT settings tend to give longer and finer tips. The recommended starting HEAT value is 225. If your program and glass require a HEAT setting greater than 350 to get separation there is a problem. The total time that the laser is heating the fiber (HEAT ON) may be quite variable when pulling electro spray tips but should be less than 5 seconds. The fiber tip diameter will be very sensitive to changes in the HEAT setting. Initially, try using the HEAT setting to control the number of LOOPS that are executed. For example, if your program loops fewer than 3 times reduce the HEAT, if it loops more than 3 times increase the HEAT.

FILAMENT–The “0” FILAMENT should always be used to pull electro spray tips. A laser scan is not necessary to achieve such a small taper length and tip diameter.

VELOCITY (Trip point)– The suggested range is 15-35. If the heat setting is too high, thinning of the glass may occur. If the glass is thinned too much, the tips formed may appear large and broken. In this case, reduce the heat in increment of ten and increase the velocity in increments of two until the glass separates in three loops. If the heat setting is too low, the tips formed may appear broken, however, the walls of the tip will be too thick. Increasing the heat setting in increments of ten and decreasing the velocity setting in increments of two will help to thin the walls of the glass and promote cleaner tip formation.

DELAY – When the hard pull is set to zero, the DELAY controls the amount of time the glass has to cool before the program either loops again if it is a single line program, or starts the next line if it is a multi-line program. A value of 128 or greater is recommended. See page 24 for further discussion of the DELAY parameter.

PULL – A hard PULL is not generally required to separate the glass when pulling electro spray tips. When developing an effective program for your glass you may find that you need a smaller tip diameter than the above program will create. One option for reducing the tip diameter is to create a three-line program by copying the first line of the program in to lines two and three. Then increase the PULL setting in the third line in increments of 10 until the desired geometry is obtained.

3.7.6 Technical Tips

3.7.6.1 Maintaining Pipette Wall Thickness of Quartz Glass

In order to make the most of the electrical and mechanical properties of quartz, it is desirable to maintain the original ratio of wall thickness to diameter as the tubing is drawn down in size.

Thinning may result from an uneven distribution of heat through the thickness of the wall. If the outside of the tubing is heated quickly, a temperature gradient will exist from the outside of the tube to the inside. In this case, the inside is cooler and limits when the tubing will begin to draw. Drawing glass down to a tip while such a temperature gradient exists will cause the hotter outer layers of the glass to "slide" past the cooler inner layers. The result will

be a reduction in wall thickness that is greater in proportion than the reduction in tubing diameter.

To reduce thinning, lower the HEAT levels and lengthen the DELAY setting. Lowering the HEAT setting so that the melting time takes approximately 10 seconds reduces the temperature gradient across the glass and allows the entire tubing to reach a good working consistency before the hard pull is applied. Increasing the DELAY value in the range of 140 to 170 allows more time for the temperature to equalize across the glass before the hard pull is applied.

Using this approach, we developed the following program which produces very strong, stiff pipettes with a tip diameter under 15 nanometers from 1.0 mm outer diameter by 0.5 mm inner diameter quartz:

Heat	Filament	Velocity	Delay	Pull
825	5	50	145	175

4. APPLICATIONS AND TECHNIQUES

4.1 Pulling Very Short Micropipettes

The P-2000 can be used to pull pipettes with tapers as short as 2 mm in length from 1 mm X 0.5 mm quartz. With this same glass, it is also possible to make tips as small as 10 nanometers in diameter but with much longer tapers. In order to make the shortest possible pipettes you will have to accept larger tip diameters, less reproducibility and less control over taper geometry.

A standard microelectrode program for very fine tips such as:

```
HEAT= 700, FIL= 4, VEL= 60, DEL= 145, PULL= 175
```

The above program may produce a taper length of about 8 to 10 mm and a tip diameter of 25 nanometers. The taper length can be shortened a bit by a small reduction of any of the variables except for DELAY, which would be increased. The simple approach to developing an appropriate program for your glass formulation is to decrease HEAT by 25 to 75 units. Do not drop HEAT so low that the glass takes more than 30 seconds to melt. If the glass does not separate after the first heating cycle, you may reduce the DELAY to 130 and try again. This approach can shorten taper lengths to about 4 mm without making the tip diameter dramatically larger.

To further shorten taper length, it is best to use a FILAMENT that heats a shorter length of glass. FILAMENTS 0 to 5 increase in scan distance with 5 being the longest. As you choose smaller FILAMENTS, expect that you will also need to use a lower VELOCITY and HEAT. The following program produced a taper length of about 5 mm:

```
HEAT=600, FIL=3, VEL=25, DEL=145, PULL=200
```

By reducing the HEAT to 550, the taper length dropped to 3.5 mm. When HEAT was dropped to 525 the taper length dropped to 2.5 mm and tip size was still less than 0.5 μm . Narrower FILAMENTS may be used but only a modest decrease in taper length will be possible. For example:

```
HEAT=500, FIL=0, VEL=30, DEL=145, PULL=175
```

produced a 2 mm taper length but the tip diameter was about 1 μm .

For the shortest patch, pipettes FILAMENT 2 or 3 should be used for at least the first line. FILAMENT 0 may be used when the glass has been drawn down to a small diameter. A simple one-line program that loops can be used to make a tip about 1 μm diameter with a taper length of 3 mm.

```
HEAT=550, FIL=2, VEL=30, DEL=130, PULL=75
```

Single line programs are a simple way to start, but more control is possible if the program is expanded to two lines.

The following sample two-line program produced a 0.5 μm tip diameter with a taper length of 2 mm.

```
HEAT=575, FIL=3, VEL=35, DEL=145, PULL=75
HEAT=425, FIL=0, VEL=15, DEL=128, PULL=200
```

It is possible to become confused by the interactions of the two program lines. Remember that the first line forms an hourglass shape and the second line starts out with this hourglass shape and draws the glass out to form a tip. Many combinations will produce similar results. Once you have a program that causes the glass to separate correctly on the second line you can make most of the fine adjustments by changing the amount that the glass necks down in the first line.

In general, the more heating cycles the more rapid the taper but our experience with quartz on the P-2000 shows there seems to be little to gain in using more than two or three heating cycles.

4.2 Pulling Large-Diameter Glass

4.2.1 Background

When the heating of glass loaded in the P2000 is too uneven about the glass' circumference the resulting pipette will not be concentric and will have an uneven wall thickness. In the worst case, the wall becomes too thin and the pipette breaks at a large diameter. This effect is most evident when making patch pipettes from thin-walled quartz tubing. The P-2000 was designed for use with 1 mm diameter glass tubing, and it is normally shipped with the optical elements positioned for pulling glass of that diameter. In this default configuration, 1.2 mm diameter glass can normally be used but larger glass, particularly thin-walled quartz, may cause problems due to uneven heating of the glass. Adjustment of the optical alignment can be made by factory technicians to minimize uneven heating of larger diameter glass but that is not recommended unless the user is certain that glass smaller than 1.2mm will not be used. Programs parameters suited for pulling larger glass can often be developed without adjusting the optical system. The principles and strategies behind pulling large diameter glass are discussed below.

4.2.2 Principles and Strategies

When the P-2000 is adjusted for and used with 1 mm glass, heating is fairly uniform as the tubing draws down in diameter. With this glass size, it is possible to draw patch pipettes with the same HEAT level in each heating cycle. Thus, it is possible to use a single program line and the looping feature to make patch pipettes with 1 mm diameter tubing.

When patch pipettes are made from tubing over 1.2 mm in diameter, the HEAT and VELOCITY values may require considerable adjustment from line to line. For 1.5 mm quartz tubing using FILAMENT 4, the HEAT value in the first line may need to be over 900 to get the tubing to melt before the laser times-out. If a HEAT of 940 does not melt the tubing before the time-out use FILAMENT 3 to get a more concentrated beam. After the first line, the HEAT required to melt the tubing may drop to below 800.

It is possible to have the factory adjust the P2000 optical system to optimize the puller for using 1.5 mm diameter tubing. This custom configuration allows patch pipettes to be formed from thick walled tubing of 1.5 mm or 1.65 mm in diameter. 1.65 mm X 1.15 mm (thin walled) quartz tubing can also be pulled into patch pipettes with this same configuration but the resulting tips are not ideal. Quartz 1 mm tubing can also be used with this custom configuration although the results will not be very concentric. Patch pipettes made with 1 mm tubing may be harder to program and the results will not be optimal.

Uneven heating can also complicate the development of programs by changing the effect of VELOCITY values. When the heat is uneven around the circumference, the resistance to drawing-out will come mostly from the coolest segment. A great deal of heat can be delivered to the other segments before this cool segment yields. This results in more total heat being delivered to the glass than would be the case if the heating were even. The extra heat causes the pipette to draw out further for any given VELOCITY setting than would have been expected.

When the point of greatest heating is centered on the tubing at the start of a hard pull the effectiveness of the heating tends to increase as the tubing is drawn down in size because less material is being illuminated in the area of the laser beam that has the highest power. If the tubing is pulling apart asymmetrically, the drawn portion of the tubing will no longer be in the most intense area of the laser beam. Because of this, the user may find that the effectiveness of heating actually decreases as the glass is drawn down in diameter. In the extreme case the glass will no longer melt at all after a few heating cycles.

4.2.3 Suggested Practices

Avoid programs that require the glass to be drawn down to a very small diameter before the start of the last pull if you must use glass of a size other than 1.2 mm in diameter.

Use thick-walled glass when practical as it is much more tolerant of uneven heating. The information outlined in the manual may be applied in most cases when using thick-walled tubing so long as the outside diameter is between 1.0 mm and 1.5 mm.

When using thin-walled glass for patch pipettes try to stick to two line programs. Use a low HEAT value, particularly in the first line. A HEAT value that requires 15 to 25 seconds to melt the tubing allows more time for the spread of heat in the glass.

NOTE: To protect the laser and power electronics from damage due to overheating the puller microprocessor will turn the laser off after about 50 seconds of heating (laser time out).

Expect that changing the outside diameter of thin-walled tubing will have strong effects on the quality of patch pipettes produced.

When using glass that is not evenly heated expect the glass to draw-out further than would otherwise be the case. Excess heat delivered to segments of the glass during uneven heating can also make it difficult to program for larger tip sizes.

4.3 Determining Tip Concentricity

While troubleshooting and adjusting the optical pathway of the laser beam it is useful to determine whether the pipettes are being heated symmetrically. If they are not they will have an asymmetric taper. A good way to assess this is to inspect the pipettes to determine if the tips are concentric with the shaft. This can be easily done using a microscope with a 10X objective (4X for pipettes greater than 1mm in diameter) and a reticule in the eyepiece. The reticule should have a 1 cm scale bar with marks at 0.2 or 0.1 mm increments. The following description outlines the procedure.

Mark the “top” and/or the “front” surface of the micropipette shaft (the “un-pulled” portion of the glass) with a pen (e.g., a “Sharpie”) before removing it from the puller bar clamp on

the P-2000. This mark will serve as a reference so that the orientation of any asymmetry in the pipette relative to the optical pathway of the laser beam can be determined.

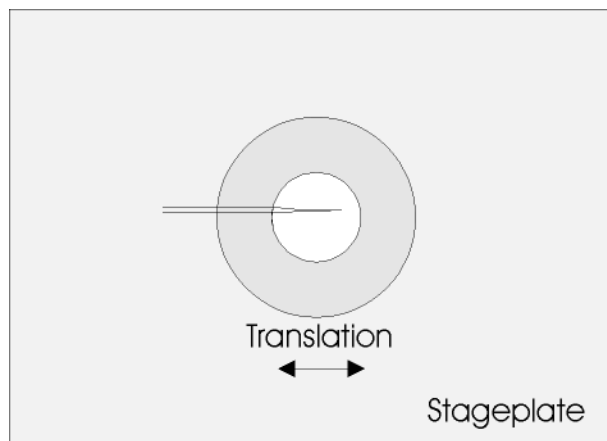

Figure 4-1. Mounting the pipette for evaluation of its geometry

Remove the pipette from the puller and place the pipette orthogonally on the microscope stage plate (Figure 4-1) using a pipette holder or by using some sticky wax or clay. Use the reference mark you made on the pipette to roll the pipette until its position relative to the optical pathway of the microscope matches its position relative to the laser beam while it was in the puller. It is imperative that the pipette be oriented perfectly parallel to the axis along which it will be translated. If you are using a scope that has a round insert under (or over) the working area you can secure the pipette to that ring and rotate it to finely adjust the pipette alignment with the axis. The best way to test the pipette's alignment is:

1. Orient the scale on the reticule perpendicular to the axis along which the pipette is to be translated.
2. Bring the pipette SHAFT into the field of view. Because the SHAFT region has not been "pulled" its walls are parallel. Using a 10X objective, the walls should line up pretty well with the end marks of the reticule scale bar (Figure 4-2).
3. Translate the pipette shaft axially and see if the point where it intersects with the scale bar remains constant. If it does not, adjust the angle of the pipette and re-check it.

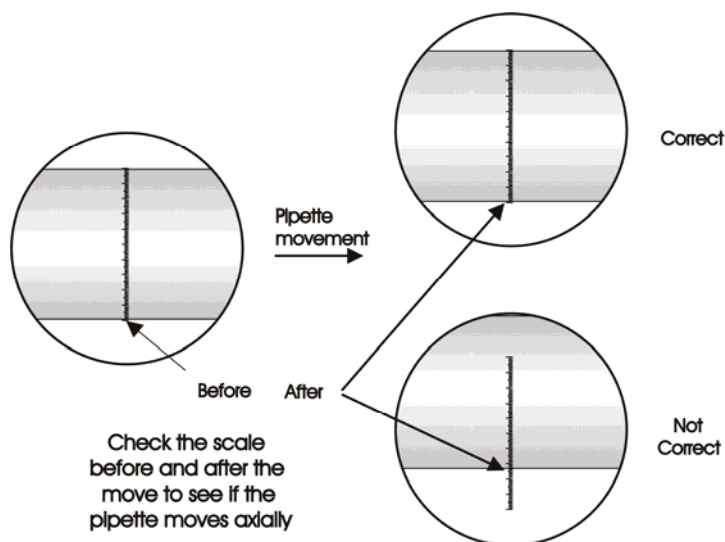

Figure 4-2. Field of view when aligning the pipette shaft

Now translate the pipette until the pipette tip is in view (Figure 4-3). If the tip is concentric with the shaft, the tip should intersect the reticule scale bar at a point midway between the points where the pipette shaft walls intersected the scale bar. Any deviation from the midpoint is due to an asymmetric taper. This would indicate that the pipette was unevenly heated and adjustments to the optical pathway may be necessary. See Table 5 for remedies.

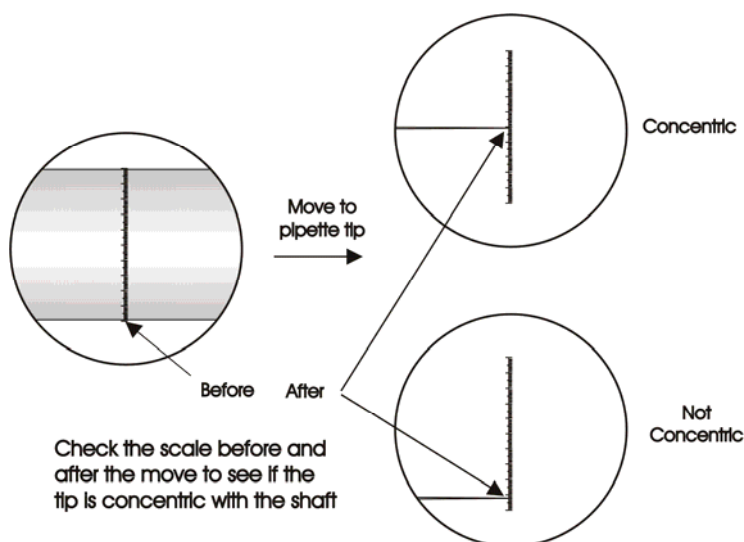

Figure 4-3. Field of view when checking the concentricity

It is important to roll the pipette 90° and then repeat the above test for asymmetric taper in that plane as well.

(This page intentionally blank.)

5. MAINTENANCE

5.1 Cleaning

5.1.1 Exterior

Clean the exterior and the base plate of the unit occasionally by wiping them with a dry cloth to remove dust and fine pieces of glass.

5.1.2 Pull Bars and Pulleys

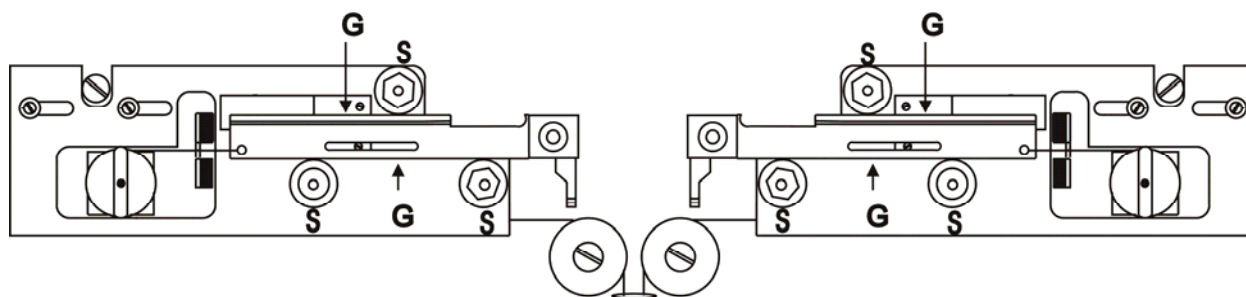

Figure 5-1. V-groove bearings and pull bars.

Clean the V-groove pulleys (**S in Figure 5-1**) and the edges of the pull bars that slide in their grooves (**G in Figure 5-1**) occasionally to maintain reproducibility from pull to pull. Use a dry cotton swab to remove the dust and debris.

CAUTION: DO NOT lubricate any components of the P-2000! No components on this unit require lubrication, and the application of lubricants to some of its parts can cause damage that will degrade the puller's performance.

5.1.3 Retro-Reflective Mirror

The retro mirror surface is close to the target glass and may become coated by materials liberated by the heating of the glass. This is very likely to happen if the glass is dirty, covered with oil from the fingers, or coated with some material during manufacturing or handling. To clean the retro mirror:

- The mirror is covered by a shroud that prevents operator access to the laser beam. To remove the shroud simply remove the two slot-head screws holding the shroud to the cover plate and lift the shroud off. Make sure that you do not disturb the mirror or its adjustable mount.
- The mirror is gold plated and may be cleaned with a soft, clean cotton cloth wetted with a solvent that produces no residue (isopropyl alcohol or acetone). You may be able to see a darkened area of contamination. This residue should come off when gently wiped with the solvent.
- Replace the shroud and insert the screws. Before you tighten the screws, check the position of the through-holes on the shroud to insure that the glass can be loaded without hitting the shroud. Tighten the screws firmly before putting the unit back in service.

5.2 Optical Alignment

Proper alignment of both the front scanning mirror and rear collector mirror is critical for optimizing the performance of the laser puller. Both mirrors were adjusted for optimum performance before shipping the P-2000 from the factory. **We recommend that you refrain from adjusting the mirrors until you have spoken with a member of the Sutter Instrument technical staff.** In the event that you do need to adjust the mirrors, the following procedures can be used.

5.2.1 Scanning Mirror Tilt Adjustment

The scanning mirror is mounted on a tilting table (Figure 5-2). The tilt controls the elevation of the laser beam relative to the glass. The degree of tilt is controlled by a micrometer on the back of the puller. This micrometer pushes against an arm attached to the tilt table, which is spring-loaded against the micrometer. Turning the micrometer clockwise elevates the laser beam relative to the glass.

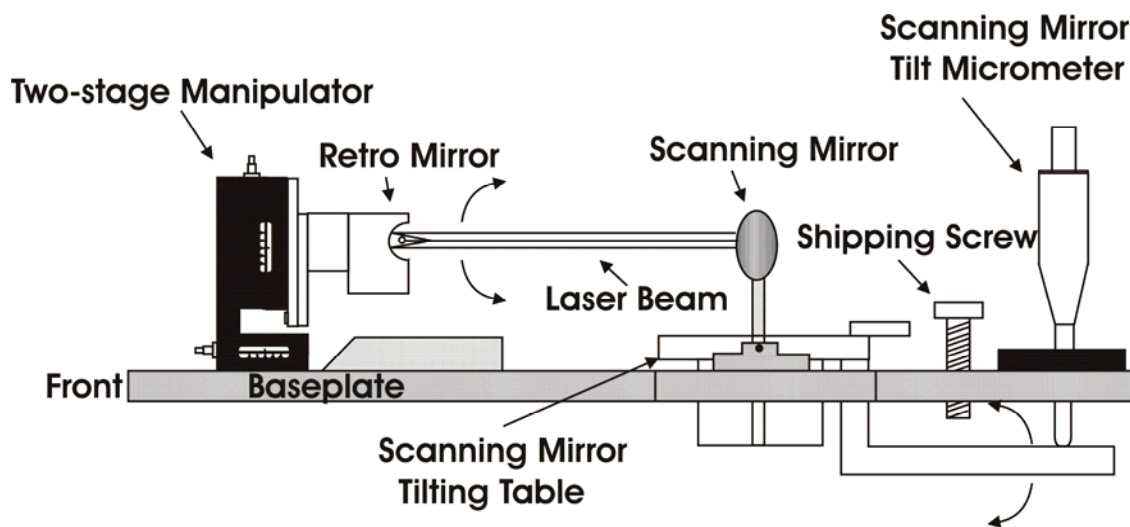

Figure 5-2. Scanning mirror tilt adjustment
(from right end of cabinet; shroud, laser and laser housing not shown)

In order to protect the tilting mechanism a shipping screw has been installed next to the micrometer. This screw is turned down prior to shipping to unload the micrometer and lock the table in place. Before using the puller for the first time, this screw should be unloaded (turned counter-clockwise until the screw is almost out of the base plate). The micrometer should also be set to the factory default setting. This value is indicated on a label near the micrometer. Make sure that the micrometer is set as indicated. If you are not sure how to read a micrometer, consult the text below.

5.2.2 Reading the Micrometer

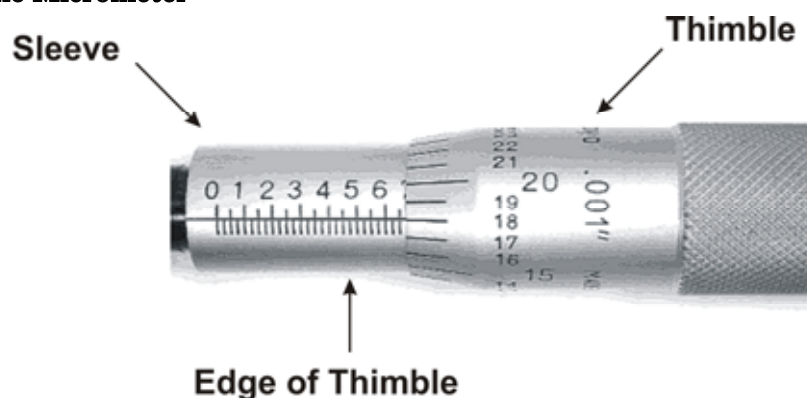

Figure 5-3. Micrometer scale

The micrometer is marked in 25 increments of 0.001" around its thimble. One rotation of the thimble will advance it along the length of the sleeve by 0.025". The numbered long markings on the sleeve represent increments of 0.1". There are also intermediate marks dividing each numbered increment into 0.05" increments. The closest marks along the sleeve represent 0.025" increments. When the thimble is turned so that its zero mark is in line with the vertical line on the sleeve, the reading is an even increment of 0.025". Locate the highest 0.1" number visible and then add 0, 0.025, 0.05, or 0.075 to that number depending on the number of 0.025 increments visible between the 0.1" line and the edge of the thimble. In this case the micrometer sleeve reveals 2 marks beyond 6 tenths of an inch, or .65" total.

If the thimble is rotated counter-clockwise from the 0 position, the number on the thimble next to the vertical line will increase but no more 0.025" marks on the sleeve will appear until a full turn back to 0 has been made. The value from the thimble is added to the value on the sleeve to obtain the reading in .001". In this case, the value is .018", which when added to .65" gives the final reading of .668".

The default micrometer setting supplied by Sutter Instrument Company should be adequate for most users. If you feel that this setting is not ideal, the micrometer allows for an easy change of tilt and a return to the old value. Since the micrometer is located about the same distance from the mirror as the target glass, a change in micrometer setting will produce about the same change in the elevation of the laser beam at the glass.

As there is no sensor-based beam positioning system built into the P-2000. You will need to make beam position adjustments utilizing qualitative information obtained with thermally sensitive paper. Scanning mirror adjustments are made as follows:

1. Remove the shroud that encloses the retro mirror. There are two screws holding the shroud to the cover plate (see the instructions for cleaning the retro mirror).
2. For pulling 1.0 - 1.2 mm outer diameter glass on a P-2000/G, load a piece of 1.0mm OD tubing into the puller. For pulling small diameter fused silica capillary and optical fiber on a P-2000/F, load the small diameter fused silica capillary or the optical fiber that you will be using.
3. Enter the following values into a program:

Heat	Filament	Velocity	Delay	Pull
200	5	0	40	0

4. Cut a 1.5cm x 3cm rectangle from a piece of thermal fax paper and slip it between the tubing and the retro mirror with the shiny side of the paper facing the tubing.
5. Lower the plastic top and press <PULL>. The laser will burn the fax paper in the region just above and below the glass. Note the symmetry, or lack of symmetry, of the burn pattern. Ideally, you want the burn pattern above and below the glass to be perfectly symmetric.

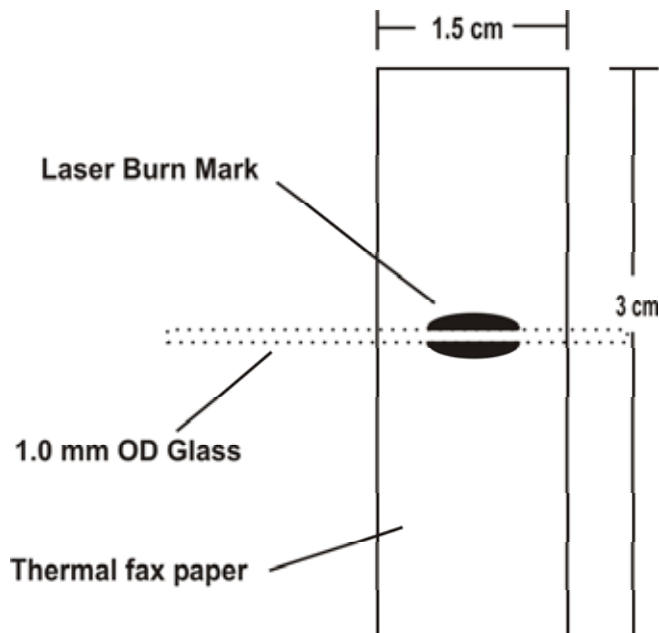

Figure 5-4. Scanning mirror adjustment using thermal paper.

6. If the burn pattern is asymmetric, turn the tilt adjustment micrometer about 1/4 turn then repeat the instructions #4-6 until the burn pattern is symmetric.\
7. When the burn pattern is symmetric, you should clean the retro-mirror per the instructions in the beginning of this section, and then reinstall the shroud.

5.2.3 Retro-Reflective (“Retro”) Mirror Adjustment

****CAUTION: Retro-mirror adjustments of any kind are extremely sensitive! Please contact Sutter Instrument Company P-2000 Tech Support before making any adjustments to the retro-mirror****

The retro mirror is mounted on a two-stage manipulator allowing you to adjust the up/down (vertical) and in/out (horizontal) positions. When the scales on the left side of the manipulator are aligned at 0 the mirror will be approximately in its factory calibrated position. It is highly unlikely that the HORIZONTAL AXIS will ever require adjustment. The VERTICAL AXIS may require adjustment if the scales are not aligned or if the pipettes (or fibers) are noticeably asymmetric. **Always check the alignment of the scanning mirror before concluding that the retro mirror is in need of adjustment.** If you are trying to

accommodate glass larger than 1.2mm in diameter please see *Appendix B: Pulling glass greater than 1 mm in diameter using the P-2000*.

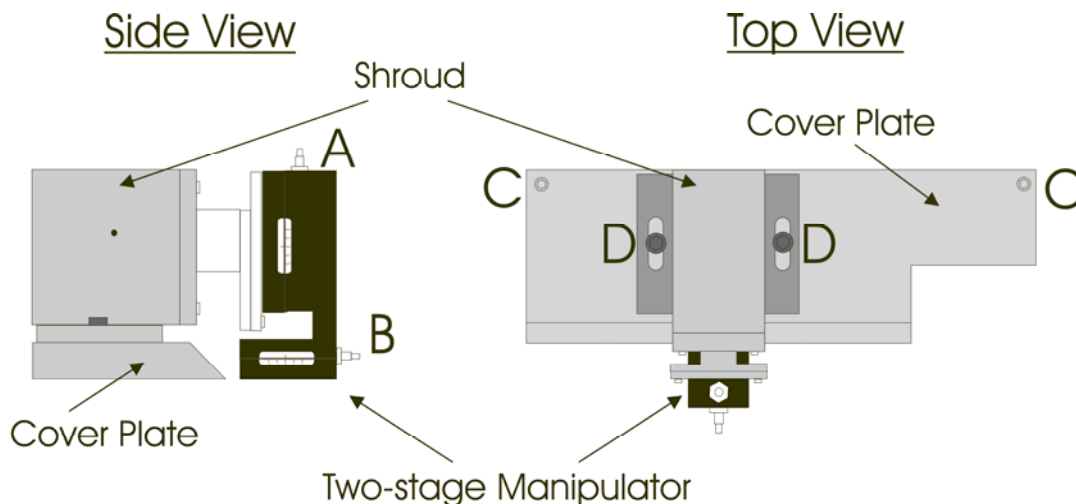

Figure 5-5. Retro Mirror Adjustment

To avoid accidental repositioning of the retro mirror the manipulator has been fitted with 3/16 nuts which require a nut driver or wrench to rotate. Turning the top nut (A) will change the vertical position of the mirror while turning the nut on the forward face of the manipulator (B) will change the horizontal position of the mirror.







NOTE

NEVER TURN THE SET SCREWS LOCATED IN THE END OF THE ADJUSTMENT NUTS AND ON THE SIDES OF THE MANIPULATORS! THEY ARE ASSEMBLY SCREWS THAT ARE NOT USED FOR ADJUSTMENT OF THE RETRO MIRROR.

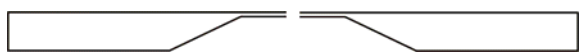
The manipulator travel limits are much greater than the travel limits of the mirror relative to the enclosure. You will notice an increased resistance to turning the manipulator adjustment nuts if the mirror is pushing against the shroud. Avoid exceeding the travel limits of the mirror as this may cause some damage to the manipulator.

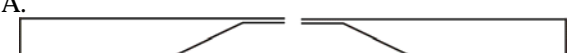
The shape of the pulled pipettes is the best feedback for adjusting the retro mirror position. To determine the laser beam position relative to a pulled pipette, it is useful to mark the pipette with an orientation mark before removing it from the glass clamp. See *APPENDIX C: Determining Tip Concentricity* for hints on how to assess a pipette's geometry. The chart on the following page lists some common pipette asymmetries and the corresponding mirror adjustments.

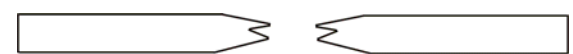
Table 5-1. Pipette asymmetries and solutions.

Pipette Geometry	Problem /Adjustment
 <p>Pipette as viewed from Front of instrument</p>	<p>This condition results from too much heat being focused too low.</p> <p>Move mirror up.</p>
 <p>Pipette as viewed from Front of instrument</p>	<p>This condition results from too much heat being focused too high.</p> <p>Move mirror down.</p>
<p>A.</p>  <p>B.</p>  <p>Pipettes as viewed from Top of instrument</p>	<p>Either geometry (A or B) indicates that the retro mirror is focused too close to the glass.</p> <p>**NOTE: Call Sutter technical support before attempting to make an in/out (horizontal) adjustment. Optimal setting as viewed from the top of the instrument is NOT centered. Call Sutter for details**</p>
 <p>Pipette as viewed from Front of instrument</p>  <p>Same pipette viewed from the Top</p>	<p>This geometry indicates that the retro mirror is focusing the beam onto the glass. The “bird beak” geometry is an indication that you are close to optimum.</p> <p>Consult with Sutter Technical Support before attempting to make an in/out (horizontal) adjustment</p>

5.3 Pulley Adjustment

When the two micropipettes formed from one pull (one from each end of the tubing) are of quite different lengths it is sometimes due to dirt on the V-groove bearings or on the puller bars, a misalignment of the laser beam or an unequal tension in the cables leading from the puller bars to the solenoid. The position of the two pulleys (**F in Figure 5-6**) that carry the cables from the solenoid (**not shown**) to the carriers (**G in Figure 5-6A**) is adjustable. While this is true, the performance of the P-2000 is EXTREMELY SENSITIVE to adjustments in this mechanism. To rule out other potential sources of this problem, this adjustment should not be made without first speaking with Sutter Technical Support Personnel.

The pulley adjustment is made by moving one or both of the pulleys to equalize the tension on the two cables. It should be explained at this point that there are two sets of stops in the system. There are the stops in the carrier slots against which the carriers rest (**M in Figure 5-6A**), and a stop to prevent the solenoid from being pulled out of its housing (**not shown**). The adjustment of the pulleys must be made so that the carriers will still come up against their stops while the solenoid is not against its stop. The two cables should not be under high tension when the carriers are against their stops (the position they would be in just before pulling an electrode).

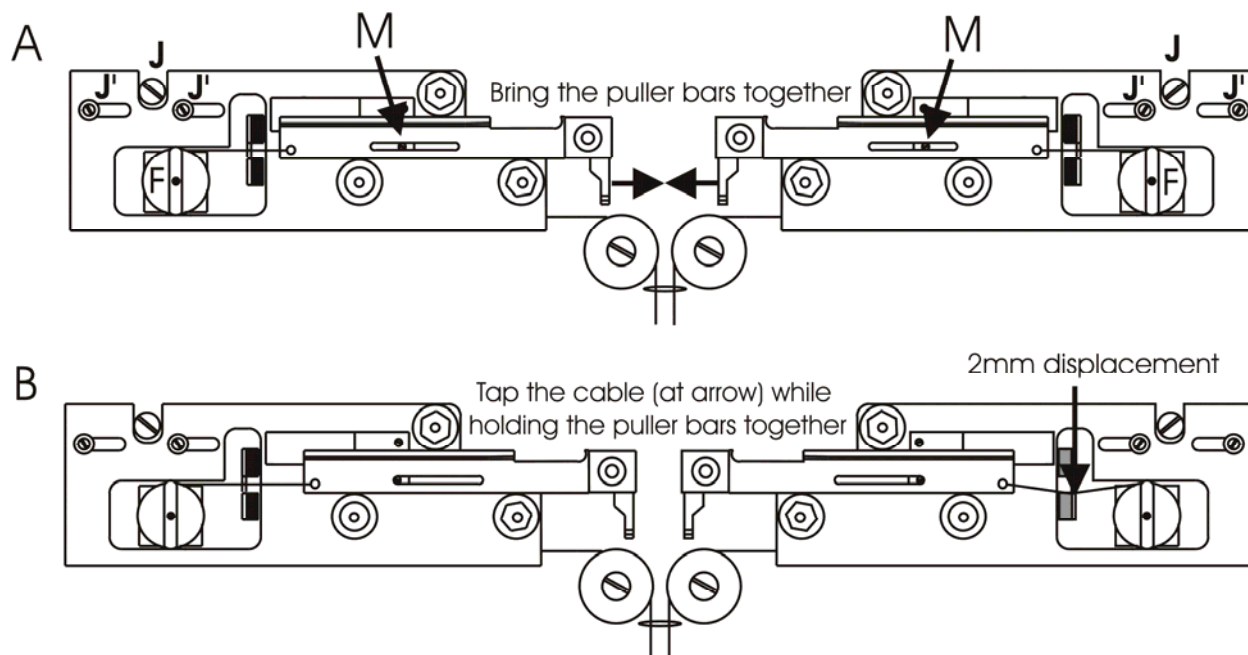

Figure 5-6. Pulley adjustment

With the puller bars pulled together with one hand you should be able to press on either cable between the carrier and the pulley and feel about 2mm of deflection (**Figure 5-6B**) before the solenoid hits its stop. If the deflection is more or less the pulley position should be changed. This is done by loosening the two screws above the pulley (**J'** in **Figure 5-6A**) and turning the chrome eccentric screws (**J** in **Figure 5-6A**) to move the pulley in small increments until the two cables are of equal tension. If the carrier no longer stops against its stop in the slot (**M** in **Figure 5-6A**) but stops against the cable, then the cam must be adjusted back until the carrier once more hits its stop. It is important that the carriers come up against their stops without significant tension on the cables. If there is too much tension, the initial pull will depend on how tightly you hold the finger stops when the glass is clamped in the carriers. If this happens, the electrodes will not be consistent from pull to pull.

(This page intentionally left blank.)

6. TROUBLESHOOTING

6.1 Controlling Pipette Tip Shapes

6.1.1 Problem: WHAT GLASS SHOULD I USE: THICK OR THIN?

In general, the thicker the wall in relation to the outside diameter of the glass the finer the tip will be, and the thinner the wall the larger the tip will be. Thin wall glass will give the best results in most experiments as it will have the largest pore for a given tip size. This means it will have a lower resistance and will allow for easier injection of solutions. However, in many cases with small cells the thin wall glass will not form tips fine enough to obtain good penetrations. In this case, heavier wall glass must be used.

6.1.2 Problem: THE RESISTANCE OF MY PIPETTES IS TOO LOW. HOW DO I PULL A HIGHER RESISTANCE PIPETTE?

The first point to note is that there is very little correlation between tip size and electrode resistance. Most of the resistance of a microelectrode is in the shank of the electrode behind the tip. Electrode tips that are .1 micron in diameter can vary in resistance from 20 Mega-ohms to 1000 Mega-ohms depending on the length of the electrode and what is used for the filling solution. If the same solution is used then resistance may give an indication of how well the electrode will penetrate a cell as the electrode with the higher resistance will probably have a longer shank and a smaller cone angle at the tip. This combination will aid in the penetration of cells where the cell is not a surface cell.

6.1.3 Problem: OK, BUT I STILL WANT A SMALLER TIP THAN I AM GETTING.

The first thing to try in most cases is to increase the HEAT value. This will generally decrease the tip size but it will also give a longer shank. If the higher resistance is not a problem, this is generally the best solution. Continuing to increase the HEAT is not the final answer as too high a HEAT can lead to very high resistances. It is usually a good idea to incrementally (and alternately) increase the HEAT and the PULL settings until the desired pipette geometry has been achieved.

6.1.4 Problem: HOW DO I INCREASE THE SIZE OF MY PATCH-PIPETTE?

Reduce the HEAT. Try dropping the HEAT 10 units at a time to see if this will increase the size of the tips. You may also need to try reducing the PULL and VELOCITY setting to achieve the desired tip shape and size

6.1.5 Problem: THE TIPS OF MY PATCH-PIPETTES VARY IN SIZE FROM PULL TO PULL.

This can happen when a pipette is formed in two or more LOOPS. If the pipette is formed in three LOOPS in one case and then on the next pull it forms in four LOOPS the tips will not be the same. Adding one unit in the VELOCITY value will in most cases cause the pipette to be formed in three LOOPS or subtracting 1 unit should cause the pipette to form in 4 LOOPS. It is always good technique when a program is developed that produces a desired pipette, to try increasing and decreasing the VELOCITY value to be sure that you are in a stable region. The best procedure in developing a very reliable pipette program is to change

the VELOCITY value both up and down until the number of LOOPS to pull the pipette changes. Then pick a value halfway between these extremes for the final VELOCITY value.

6.1.6 Problem: ONE ELECTRODE IS MUCH LONGER THAN THE OTHER ELECTRODE.

This is caused by one of four things: dirt on the V-groove bearings or on the puller bars, misalignment of the laser beam, uneven tension in the cables between the puller bars and the solenoid, or, most commonly, a dirty retro-mirror. First, try cleaning the V-groove bearings, the retro-mirror, and the puller bars as described in the maintenance chapter. **IF THE PROBLEM PERSISTS, CALL SUTTER TECHNICAL SUPPORT PERSONNEL. DO NOT TRY TO ADJUST LASER BEAM ALIGNMENT OR CABLE TENSION BEFORE CONSULTING WITH SUTTER TECHNICAL SUPPORT!**

6.1.7 Problem: THE SHAPE AND RESISTANCE OF THE PIPETTE CHANGES FROM PULL TO PULL.

1. In most cases, this occurs when one or both of the cables to the pipette puller bars are adjusted too tightly. One way to see if this is the case is to look at the stop in the slot of each puller bar (figure 33). If the cable is adjusted so that the puller bar can't come against the stop in the slot then the initial pull tension will depend on how hard the carriers are squeezed together when the glass clamps are tightened. **DO NOT TRY TO ADJUST THE CABLE TENSION BEFORE CONSULTING WITH SUTTER TECHNICAL SUPPORT PERSONNEL!**
2. A second possible cause of this problem is dirt on the carrier bars or bearings. In this case, clean the carriers and bearings with a lint free tissue or cloth as described in the Maintenance chapter.
3. **IF THE PROBLEM PERSISTS CALL SUTTER TECHNICAL SUPPORT.**

6.2 Controller Problems

6.2.1 Problem: DISPLAY BLANK, FAN NOT ON.

1. Check to see that the unit is plugged into the appropriate voltage outlet.
2. If the unit is properly plugged in, and still does not work, then remove the power cord and check to see that the fuse hasn't blown. If the fuse has blown, a failure in components that are not serviceable by the user has likely occurred. **CONTACT SUTTER INSTRUMENT COMPANY TECHNICAL SUPPORT.**
3. If the fuse is still good, the unit is properly plugged in, and it still does not work, then a failure in the components that are not serviceable by the user has likely occurred. **CONTACT SUTTER INSTRUMENT COMPANY TECHNICAL SUPPORT.**

6.2.2 Problem: DISPLAY SHOWS A ROW OF BLOCKS.

The microprocessor has failed to properly initialize the display. This problem can occur when the power has been turned off and then on again too rapidly. Press RESET and the display should show the proper power-up message. Always allow at least five seconds before powering on a unit that has just been powered off. If the display still shows a row of blocks, a failure in components that are not serviceable by the user has likely occurred. **CONTACT SUTTER INSTRUMENT COMPANY TECHNICAL SUPPORT.**

6.2.3 Problem: DISPLAYED PROGRAM VALUES ARE NOT CORRECT

Make sure that values were not changed by another user. Always write down the program values keep them in a secure place. If the values entered are not held when the power is turned off, a failure in components that are not serviceable by the user has likely occurred. Contact Sutter Instrument Company Technical Support.

6.3 Technical Support

For further assistance, contact Sutter Instrument Technical Support at:

(415) 883-0128 or info@sutter.com

(This page intentionally blank.)

APPENDIX A. LIMITED WARRANTY

- Sutter Instrument Company, a division of Sutter Instrument Corporation, limits the warranty on this instrument to repair and replacement of defective components for two years from date of shipment, provided the instrument has been operated in accordance with the instructions outlined in this manual.
- Abuse, misuse, or unauthorized repairs will void this warranty.
- Warranty work will be performed only at the factory.
- The cost of shipment both ways is paid for by Sutter Instrument during the first three months this warranty is in effect, after which the cost is the responsibility of the customer.
- The limited warranty is as stated above and no implied or inferred liability for direct or consequential damages is intended.
- Consumables, PMTs, galvanometers, and Uniblitz^{®1} shutters are exempt from this warranty.
- An extended warranty for up to three additional years can be purchased at the time of ordering, or until the original warranty expires. For pricing and other information, please contact Sutter Instrument.

¹ Uniblitz[®] is a registered trademark of Vincent Associates.

(This page intentionally blank.)

APPENDIX B. ACCESSORIES

The following accessories are available for the P-2000.

Spacers

Spacer for special procedures (**FPS**)

Glass Stops

Glass Stop (**GS**). (Installs on either puller bar.)

Glass Loading Aids

Glass loading aid (**GLA**). (Installs on either puller bar.)

Pipette Storage Boxes

Pipette storage box 4.75 x 3.625 x 0.75 inches.

Pipette storage box 7 x 3.625 x 0.75 inches.

(This page intentionally blank.)

APPENDIX C. FUSE REPLACEMENT

In the event that the controller fails to power up when the power switch is turned on, check the line power fuse to see if it has blown. The fuse is located in the fuse holder on the power entry module on the back of the controller. To remove the fuse holder first unplug the power cord from the power entry module. This will reveal a slot just under the edge of the fuse holder. Use a screwdriver to pry the holder straight out of the power entry module.

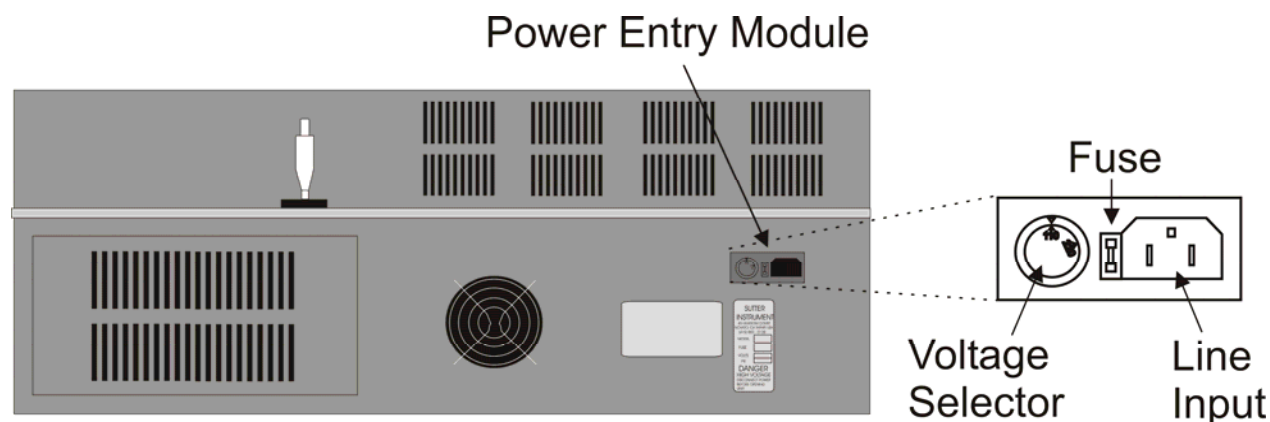

Figure 6-1. Power entry module

The fuse that is readily visible in the fuse holder when you take it out is the one that is “active” when the holder is installed. A spare fuse is also stored within the fuse holder. It is concealed in a compartment as shown in Figure 6-2. To remove the spare fuse, press down on the end of the compartment and push it out of the other end. The old fuse can serve as a convenient tool for pushing the spare fuse compartment out. Replace the active fuse with the spare and re-install the fuse holder and power cord. If the controller fails to power up with the new fuse installed, call Sutter Instrument technical support personnel for assistance.

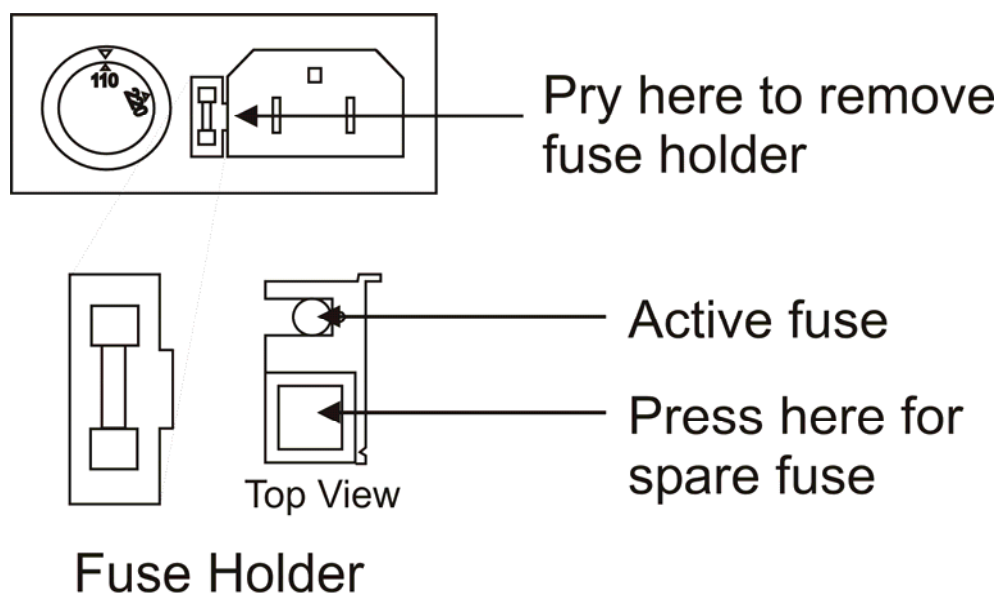

Figure 6-2. Fuse holder

Make certain that the type and rating of the fuse being replaced are as indicated in Table 6-1, according to the mains voltage setting being used.

Table 6-1. Fuse type and rating.

Mains Voltage Setting	Fuse (Type: Time Delay, 5mm x 20mm, glass tube)	
	Rating	Manufacturer Examples
“110” (100 – 120 VAC)	5A, 125 or 250V (Time Delay)	Bussmann: GMC-5A or S506-5-R (RoHS) Littelfuse: 239 005 (RoHS)
“220” (200 – 240 VAC)	T3.15A, 250V	Bussmann: GDC-3.15A or S506-3.15-R (RoHS) Littelfuse: 218 3.15 (RoHS)

APPENDIX D. TECHNICAL SPECIFICATIONS



Dimensions (H x W x D): 13 x 30 x 14.5 in (33 x 76 x 37 cm)

Weight: 80 lb. (36.4 kg)

Electrical:

Mains voltage 100 - 120 VAC, 60 Hz

200 - 240 VAC, 50 Hz

Maximum power consumption 396 VA

Mains fuse (rear of cabinet):

Table 6-2. Fuse type and rating.

Mains Voltage Setting	Fuse (Type: Time Delay, 5mm x 20mm, glass tube)	
	Rating	Manufacturer Examples
“110” (100 – 120 VAC)	5A, 125 or 250V (Time Delay)	Bussmann: GMC-5A or S506-5-R (RoHS) Littelfuse: 239 005 (RoHS)
“220” (200 – 240 VAC)	T3.15A, 250V	Bussmann: GDC-3.15A or S506-3.15-R (RoHS) Littelfuse: 218 3.15 (RoHS)

Internal safety fuses (not operator accessible)

A41-43-515 transformer (All Type T (slow blow))

Yellow #1 line 0.5A, 250V, 3AG

Yellow #2 line 0.5A, 250V, 3AG

Orange line 3.2A, 250V, 3AG

A41-80-36 transformer (All Type T (slow blow))

Yellow #1 line 3.2A, 250V, 3AG

Yellow #2 line 3.2A, 250V, 3AG

Power cord 10A, 250V,
with safety ground plug

(This page intentionally left blank.)

INDEX

A

accessories	65
glass loading aids	65
glass stops	65
pipette storage boxes	65
spacers	65

B

base	8
baseplate	8
bumpers	3

C

cabinet	8
cable	4
adjustment	56
cable pulley assembly	3
bumpers	3
cable	4
pull bars	51
puller bars	4
spring stops	3
V-bearings	4, 51
cables	56
configuration	
default	21
control functions	25
copy a program	28
memory test	28
ramp test	25
reset time/date	27
write protection	26
controls	
front panel	15
copy a program	28
cover plate	5
cycle	20
definition	16, 18
cycle parameters	18

D

date	16
default configuration	29
defaults	
configuration	21
programs	21
delay	
definition	17, 20
determining tip concentricity	47

disclaimer	iii
display	16
edit line	23
header line	23
program info line	23
program information	16
date/time	16
program	16
write protection	16
program parameters	17
delay	17
filament	17
heat	17
pull	17
velocity	17

E

edit line	23
electrospray tip	
fabrication	42

F

fax paper test	54
filament	
adjustment	19
definition	17
first time use	13
front panel	15
controls	15
keypad	15
reset	15
display	15, 16
fuse	
holder	67
Line Fuse	10
location	10
location	10, 67
replacement	67
spare	67
fuse replacement	67
fuses, replacement	
internal	69
mains	v, 69

G

General Information	1
Introduction	1
glass selection	34
glassware	
loading	13

precautions	vi		
specifications	2		
H			
header line	23		
heat			
definition	17, 18		
heat on	31, 32		
heat value			
optimal setting	13		
heating chamber			
removal	5		
I			
information labels			
certification	2		
fuse	2		
serial number	2		
information labels.....	2		
injection pipettes.....	19		
K			
keypad.....	15		
keys			
CLR.....	15, 23		
ENTR.....	15		
LAST.....	15, 23		
NEXT.....	15, 23		
numeric.....	15		
PULL.....	15		
reset.....	15		
STOP.....	15		
L			
laser.....	6		
time out.....	46, 47		
time out.....	14		
laser housing	8		
last line used.....	31		
line power (mains).....	10		
Power Entry Module			
Line Input socket.....	11		
looping	29		
loops	31		
M			
mains	10		
fuses	v, 69		
power cord	69		
voltage.....	69		
maintenance			
cleaning			
exterior.....	51		
pull bars and pulleys.....	51		
retro reflective mirror	51		
cleaning.....	51		
optical alignment			
reading the micrometer.....	53		
retro reflective mirror adjustment.....	54		
scanning mirror tilt adjustment.....	52		
optical alignment	52		
pulley adjustment	56		
maintenance.....	51		
manipulator.....	5		
mechanical description (puller anatomy).....	2		
cabinet	8		
base	8		
baseplate	8		
laser housing	8		
optical pathway.....	6		
laser	6		
retro mirror	7		
scanning mirror	7		
scanning mirror tilt micrometer	7		
retro mirror assembly	5		
cover plate	5		
retro mirror	5		
shroud.....	5		
two-stage micrometer.....	5		
some basic information	2		
upper cable pulley assembly	3		
bumpers	3		
panels, left & right.....	3		
pull cable.....	4		
puller bars.....	4		
spring stops	3		
V bearings.....	4		
memory.....	32		
memory test	28		
microinjection needle fabrication.....	33		
micrometer.....	7		
use of.....	53		
micropipette fabrication.....	33		
N			
nanospray tip			
fabrication	42		
notes			
user.....	75, 76		
O			
operation.....	29		
first time use	13		
precautions.....	vi		
optical alignment	52		
optical fiber			

fabrication	40	micropipette/microinjection needle fabrication	33
optical pathway	6	glass selection	34
laser	6	formulation	34
retro mirror	7	outside diameter	35
scanning mirror	7	wall thickness	35
scanning mirror tilt micrometer	7	glass-specific parameter adjustment	35
P		aluminosilicate glass	35
parameter		borosilicate glass	35
adjustment	32	flint or soft glass	35
parameter adjustment		quartz	36
electrospray/nanospray tip fabrication		programs	33
glass preparation	42	sample programs (for quartz glass)	36
programs	42	selecting program parameters	33
selecting program parameters		selecting program parameters	
delay	43	delay	34
filament	43	filament	33
heat (laser output power)	42	heat (laser output power)	33
pull	43	pull	34
velocity (trip point)	43	velocity (trip point)	34
selecting program parameters	42	patch pipette fabrication	37
electrospray/nanospray tip fabrication	42	programs	37
optic fiber fabrication		selecting program values	37
fiber preparation	41	patch pipette	
programs	41	fabrication	37
selecting program parameters		patch pipettes	19
delay	41	power cord	
filament	41	mains	69
heat (laser output power)	41	power entry module	67
pull	42	Power Entry Module	10
velocity (trip point)	41	power switch	10
selecting program parameters	41	precautions	
optic fiber fabrication	40	handling micropipettes	vi
patch pipette fabrication		precautions	v
glass selection	39	electrical	v
glass-specific parameter adjustment	39	program	
aluminosilicate glass	39	clearing	23
borosilicate glass	39	copying	28
flint or soft glass	39	default configuration	29
quartz	39	definition	16, 18
optical system adjustments	40	display	22
selecting program values		editing	24
DELAY	38	editing existing	24
FILAMENT	38	entering new	24
HEAT	37	memory	32
VELOCITY	38	parameters	32
suggested practices	40	results	31
technical tips		selection	22
maintaining pipette wall thickness of quartz		viewing	23
glass	43	program info line	23
technical tips	43	programs	
parameter adjustment	32	default	21
general information	32	Programs	18

cycle parameters	18	retro mirror assembly	5
delay	20	shroud	5
filament.....	19	S	
heat	18	safety warnings.....v	
pull	19	electrical.....v	
velocity.....	19	safety warnings & precautions.....v	
program structure	18	scanning mirror	7
cycle.....	18	tilt adjustment	52
program (definition)	18	tilt micrometer	7
pull		scanning mirror alignment.....	53
definition	17, 19	setting up.....	9
pull cycle	20	line power (mains)	10
clearing a program from memory	23	Power Entry Module.....	10
default configuration	21	fuse	10
default programs.....	21	Line Input socket.....	11
standard factory configuration.....	21	voltage selector switch.....	10
editing a program	24	power switch	10
editing an existing program.....	24	voltage selector switch.....	10
entering a new program.....	24	power switch	10
selecting a program	22	shipping screw removal.....	9
viewing a program	23	shipping screws.....	13
pull results.....	31	shroud	5
puller bar		software control functions	25
adjustment	4	COPY A PROGRAM	28
alignment	3	MEMORY TEST	28
clamping knob.....	14	RAMP TEST	25
puller bar	14	RESET TIME AND DATE.....	27
puller bars	4	WRITE PROTECT THIS PROGRAM.....	26
pulleys		specifications	69
adjustment	56	dimensions	69
pulling large diameter glass.....	46	glassware	2
background.....	46	weight	69
principles and strategies	46	spring stops	3
suggested practices	47	T	
pulling pipettes	29	technical specifications.....	69
notes on program operation	32	technical support	1
HEAT ON.....	32	technical tips	43
program memory	32	time	16
procedures	29	time out.....	14, 46, 47
looping.....	29	time/date	
pull results.....	31	resetting.....	27
heat on	31	tip shapes.....	59
last line.....	31	troubleshooting.....	59
program	31	controller problems	60
used	31	controlling pipette tip shapes	59
pulling very short micropipettes	45	Technical Support	61
R		two-stage manipulator	5
ramp test	25	U	
reset.....	15	unpacking.....	9
retro mirror	7		
alignment	54		
cleaning.....	51		

<i>V</i>		<i>W</i>	
V-bearings	4	W/WP	16
velocity		warranty	63
definition	17, 19	write protection.....	16, 26
voltage			
mains.....	69		
voltage selector switch	10		

NOTES

NOTES