

TABLE OF CONTENTS

MAINTENANCE SERVICE RECORD	1
WARRANTY POLICY	2
BEFORE DRIVING	3
STEERING COLUMN CONTROLS	4
INSTRUMENT PANEL	5
OTHER CONTROLS AND EQUIPMENT	6
OPERATING YOUR VEHICLE	7
DRIVING TIPS AND SAFE DRIVING	8
INSPECTION AND MAINTENANCE	9
EMERGENCY SERVICE	10
BODY WORK CARE	11
GENERAL INFORMATION	12
SPECIFICATION	13

FOREWORD

This manual is an essential part of your vehicle and should be kept with the vehicle at all times. Please read this manual carefully and review it from time to time. It contains important information on maintenance. It is especially important that this manual remain with the vehicle at the time of resale. The next owner will need this information also.

You are invited to avail the three free inspection services as described in this manual. Three free inspection coupons are attached to this manual. Please show this manual to your dealer when you take your vehicle for any Service.

To prolong the life of your vehicle and reduce maintenance costs, the periodic maintenance must be carried out according to the "PERIODIC MAINTENANCE SCHEDULE" described in "INSPECTION AND MAINTENANCE" section of this manual. Periodic maintenance is essential for preventing trouble and accidents to ensure your satisfaction and safety.

Daily Inspection and Care as per "DAILY INSPECTION CHECKLIST" described in the "INSPECTION AND MAINTENANCE" section of this Manual is essential for prolonging the operating life of the vehicle and for safe driving.

3

MARUTI SUZUKI INDIA LIMITED believes in conservation and protection of Earth's natural resources.

To that end, we encourage every vehicle owner to recycle, trade in, or properly dispose of, as appropriate, used motor oil, coolant, and other fluids; batteries; and tyres.

MARUTI SUZUKI INDIA LIMITED

All information in this manual is based on the latest product information available at the time of publication. Due to improvements or other changes, there may be discrepancies between information in this manual and your vehicle. MARUTI SUZUKI reserves the right to make changes at any time without notice.

This vehicle may not comply with standards or regulations of other countries. Before attempting to register this vehicle in any other country, check all applicable regulations and make any necessary modifications.

IMPORTANT

WARNING/CAUTION/NOTE

Please read this manual and follow its instructions carefully. To emphasise special information, the words **WARNING**, **CAUTION**, and **NOTE** have special meanings. Information following these signal words should be carefully reviewed.

▲ WARNING

The personal safety of the driver, passengers, or bystanders may be involved. Disregarding this information could result in their injury or death.

CAUTION

These instructions point out special service procedures or precautions that must be followed to avoid damaging the vehicle.

NOTE :

This provides special information to make maintenance easier or important instructions clearer.

MODIFICATION WARNING

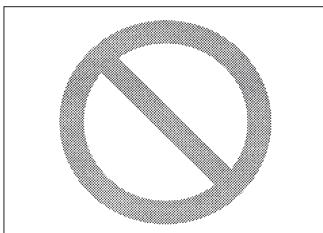

76G-00-001

The circle with a slash in this manual means "Don't do this" or "Don't let this happen".

⚠ WARNING

Do not modify this vehicle. Modification could adversely affect safety, handling, performance, or durability and may contravene regulations. In addition, damage or performance problems resulting from modification may not be covered under warranty.

⚠ WARNING

Your vehicle has monocoque body construction which provides for certain crumple zones in the body which absorbs larger part of impact energy in the event of a front collision and protects the occupants from impact. Do not use any fitments such as crash guards. These fitments will increase the risk to the occupants because of the shock directly getting transmitted to the occupants.

CAUTION

Improper installation of mobile communication equipment such as cellular telephones or CB (Citizen's Band) radios may cause electronic interference with your vehicle's ignition system, resulting in vehicle performance problems. Consult your MARUTI SUZUKI dealer or qualified service technician for advice on installing such mobile communication equipment.

Copying, quoting or reproduction of any part of this manual is not permitted without explicit approval by **MARUTI SUZUKI INDIA LIMITED.**

MAINTENANCE SERVICE RECORD

1

MODEL	CHASSIS NO.	ENGINE NO.	KEY NO.	DATE OF DELIVERY	MILEAGE (km)	BATTERY	
						MAKE	SR. NO./BATCH CODE

OWNER'S NAME & ADDRESS _____ _____ TEL. NO. _____
--

ADDRESS/STAMP OF SELLING DEALER	SELLING DEALER CODE
SHOWROOM	
	IMPORTANT INFORMATION TO CUSTOMER
WORKSHOP	<p>Dear Customer</p> <p>For any assistance with regard to our product, please contact General Manager/Works Manager at any of our Dealer or Authorised Service Station. For additional enquiry you may contact our Regional office or Service Department. The Addresses and Phone nos. are given in Service Network booklet provided along with vehicle.</p>

WARRANTY POLICY

Maruti Suzuki India Limited (hereinafter called "Maruti Suzuki"), warrants that each new Maruti Suzuki vehicle distributed in India by Maruti Suzuki and sold by an authorised Maruti Suzuki dealer will be free, under normal use and service, from any defects in material and workmanship at the time of manufacture SUBJECT TO THE FOLLOWING TERMS AND CONDITIONS:

(1) Qualification:

To qualify for this warranty:

- (a) The Maruti Suzuki vehicle must be delivered by Maruti Suzuki authorised dealer and set-up, serviced by Maruti Suzuki authorised dealer/service station.
- (b) The warranty registration card in respect of each vehicle must be completed by the dealer at the time of delivery of the vehicle and dealer should retain the same.

(2) Term:

The term of the warranty shall be twenty four (24) months or 40,000 kilometers (whichever occurs first) from the date of delivery to the first owner.

(3) Maruti Suzuki Warranty Obligation:

If any defect(s) should be found in a Maruti Suzuki vehicle within the term stipulated above, Maruti Suzuki only obligation is to repair or replace at its sole discretion any part shown to be defective, with a new part or the equivalent at no cost to the owner for parts or labour, when Maruti Suzuki acknowledges that such a defect is attributable to faulty material or workmanship at the time of manufacture. The owner is responsible for any repair or replacements which are not

covered by this warranty.

(4) Limitation:

This warranty shall not apply to:

- (a) normal maintenance service required other than the three free services, including without limitation, oil and fluid changes, headlight aiming, fastener retightening, wheel balancing, wheel alignment and tyre rotation, cleaning of injectors, adjustments of carburettor, ignition timing, clutch and valve clearance.
- (b) the replacement of normal wear parts including without limitation, bulbs, battery, tyres and tubes, spark plugs, belts, hoses, filters, wiper blades, brushes, contact points, fuses, clutch disc, brake shoes, brake pads, cable and all rubber parts (except oil seal and glass run).
- (c) any vehicle which has been used for competition or racing.
- (d) any repairs or replacement required as a result of accidents or collision.
- (e) any defects caused by misuse, negligence, abnormal use or insufficient care.
- (f) any vehicle which has been modified or altered, including without limitation, the installation of performance accessories.
- (g) any vehicle on which parts or accessories not approved by Maruti Suzuki have been used.
- (h) any vehicle which has not been operated in accordance with the operating instructions in the Maruti Suzuki Owner's Manual.
- (i) any vehicle which has not received, during the warranty term, the service inspections prescribed in the Maruti Suzuki Owner's Manual.
- (j) any vehicle which has been assembled, disassembled,

WARRANTY POLICY

59K,76G,844-74E

adjusted or repaired by other than an Maruti Suzuki authorised dealer/service station.

- (k) any vehicle which has been used for purposes other than what it was designed for.
- (l) any damage or deterioration caused by industrial pollution and bird droppings.
- (m) insignificant defects which do not affect the function of the vehicle including without limitation, sound, vibration and fluid seep.
- (n) any natural wear and tear including without limitation, aging etc.
- (o) Installation and usage of Domestic LPG Gas/LPG cylinder.

For Maruti Suzuki Air-Conditioned Vehicles

- (p) V-belts, hoses and gas leaks.

(5) Extent of Warranty:

This warranty is the entire written warranty given by Maruti Suzuki for Maruti Suzuki vehicles and no dealer or its or his agent or employee is authorised to extend or enlarge this warranty and no dealer or its or his agent or employee is authorised to make any oral warranty on Maruti Suzuki behalf. Maruti Suzuki reserves the right to add any improvements or change the design of any model at any time with no obligation to make the same changes on units previously sold.

(6) Warranty Service:

To obtain warranty service, the complete vehicle must be presented at the owner's expenses to any authorised Maruti Suzuki dealer.

(7) Owner's Warranty Responsibilities:

It is responsibility of each owner to:

- (a) make certain that the warranty registration/PDI card was completed at the time of delivery of the vehicle;
- (b) have performed, at his own expenses, by an Maruti Suzuki authorised dealer/service station all the service inspections specified in the Maruti Suzuki "Owner's Manual and Service Booklet" and maintain adequate proof that such service inspections have been performed.
- (c) make certain that the Maruti Suzuki authorised dealer/ service station performing the service inspection has certified the work on the "Maintenance Service Record" page in the "Owner's Manual and Service Booklet" and
- (d) present the Maruti Suzuki "Owner's Manual and Service Booklet" to the authorised Maruti Suzuki dealer whenever requesting service inspections or warranty service.

If the "Owner's Manual and Service Booklet" should be lost or destroyed the owner should consult the authorised Maruti Suzuki dealer from whom the vehicle was purchased for instructions concerning replacement of the "Owner's Manual and Service Booklet".

(8) Disclaimer of Consequential Damage:

Maruti Suzuki assumes no responsibility for loss of vehicle, loss of time, inconvenience or any other indirect incidental or consequential damage resulting from the vehicle not being available to the owner because of any defect covered by this warranty.

(9) Change of Owner

Even if ownership of the vehicle changes, the remaining warranty period is effective for the new owner.

Maruti Suzuki offers the Emission Warranty on all Maruti Suzuki vehicles (apart from the Regular warranty and will run parallel to the regular product warranty) only in four metropolitan cities (**New Delhi, Kolkata, Mumbai and Chennai**) with effect from **July 1st, 2001**.

Terms:

The Emission Warranty will be applicable for **80,000 kms or 3 years** (Which ever comes earlier) from the date of delivery to the first owner. The remaining warranty terms will be valid in case of any change in ownership provided the production of all valid document.

Conditions:

1. Under Emission Warranty, Warranty claims will be admitted for a prima facie examination, in case vehicle fails to meet to the Emission Standard as specified in sub rule (2) of rule no. 115 of Central Motor Vehicles Rules (CMVR), 1989.
2. The warranty claims will only be accepted after examination carried out by Maruti Suzuki or it's dealer which leads to firm conclusions that the
 - a) Original settings have not been tempered in any case.
 - b) Part (as given in Annexure-A) has a manufacturing defect.
 - c) Vehicle is unable to meet the Emission Standards (as given in 1.), inspite of the vehicle having been maintained and used in accordance with the instructions as specified in Owner's Manual and Service Booklet and the used fuel and different oils (Engine oil, Transmission oil, Brake oil etc.) are also as per specification.
3. The method of examination for deciding the warranty of the parts will be at the sole discretion of Maruti Suzuki and it's dealer and results of the examination will be final and binding. If after examination, the warrantable condition is not established, Maruti Suzuki and it's dealer has the right to charge all, or part of the cost of such examination.
4. Under Emission Warranty, the parts (as given in Annexure-A) will be changed free of cost, but the consumables will be charged as per actual.
5. If the part covered under Emission Warranty or the associated parts, are not independently replaceable, on account of these being integral parts a complete assembly, Maruti Suzuki and it's dealer will have the sole discretion to replace entire assembly or by using some of the parts of the system through suitable repair or modifications.

EMISSION WARRANTY

59K,76G,844-74E

6. Any consequential repairs or replacement of parts which may be found necessary to establish compliance of Emission Warranty, will not be considered under warranty, unless the same is under product warranty. The consumable will be charged as per actual under such repair or replacement.
7. Maruti Suzuki will not be responsible for the cost of transportation of the vehicle to the nearest Maruti Suzuki dealer workshop or any loss due to non-availability of the vehicle during the period of lodging of a warranty claim and examination and/or repair by Maruti Suzuki dealer.
8. Maruti Suzuki will not be responsible for any penalty that may be charged by statutory authorities on account of failure to comply with the EMISSION STANDARDS.
9. Emission Warranty will not be affected on the change of owner, provided all the documents are available.
10. All maintenance actions (as specified in the Owner's Manual and Service Booklet) need to be followed and recorded in the manual for emission warranty.
11. The customer needs to produce the PUC (Pollution Under Control) certificate valid for the period preceding the test during which the failure is discovered. The receipts (for the maintenance of the vehicle as per specification in Owner's Manual and Service Booklet from the date of original purchase of the vehicle) will also be required.

Condition Under which the Emission Warranty is not APPLICABLE

1. In the absence of valid PUC certificate.
2. Vehicle not serviced from Maruti Suzuki authorised workshop as per the schedule specified in the Owner's Manual.
3. Vehicle subjected to abnormal use (accident, motor race, rallies or for the purpose of establishing the records etc.)
4. Use of non MGP (Maruti Genuine Part).
5. Vehicle tempered in an unauthorised manner.
6. Tampering with odometer so that the actual kilometer reading can not be read.
7. Use of adulterated fuel and/or unspecified oils (Engine oil, Transmission oil and Brake oil etc.)

Annexure-A

List of parts covered under Emission Warranty

1. Fuel injection Assembly, Pressure Regulator, Throttle Body Assembly.
2. Electronic Control Module (ECM).
3. Intake Manifold.
4. EGR valve.
5. Distributor and internal parts.
6. Ignitions coil.
7. Canister Assembly.
8. Vapour Liquid Separator.
9. Fuel Tank and Filler Cap.
10. PCV (Positive Crankcase Ventilation) Valve.
11. Oil Filler Cap.
12. Catalytic Converter.
13. Exhaust manifold.
14. All fuel injection System related SENSORS.
15. Maniverter

BEFORE DRIVING

Fuel Recommendation 3-1
Immobilizer System 3-2
Door Locks 3-4
Windows 3-6
Mirrors 3-8
Front Seat Adjustment 3-9
Adjusting Seat Position 3-9
Adjusting Seatbacks 3-10
Seat Belts 3-11
Lap Belt (if equipped) 3-15

FUEL RECOMMENDATION

You must use unleaded petrol with an octane number (RON) of 91 or higher.

CAUTION

Use of leaded fuel in vehicle equipped with catalytic converter is prohibited, because lead deactivates the pollutant reducing components of catalytic converter and may result in permanent damage to catalytic converter.

Petrol/Ethanol Blends

Blends of unleaded petrol and ethanol (grain alcohol), also known as gasohol, are commercially available in some areas. Blends of this type may be used in your vehicle if they are no more than 5% ethanol. Make sure this petrol-ethanol blend has octane ratings no lower than those recommended for petrol.

Petrol/Methanol Blends

Blends of unleaded petrol and methanol (wood alcohol) are also commercially available in some areas. DO NOT USE fuels containing more than 5% methanol under any circumstances. Fuel system damage or vehicle performance problems resulting from the use of such fuels are not the responsibility of MARUTI SUZUKI and may not be covered under Warranty.

Fuels containing 5% or less methanol may be suitable for use in your vehicle if they contain cosolvents and corrosion inhibitors.

NOTE:

If you are not satisfied with the driveability or fuel economy of your vehicle when you are using a petrol/alcohol blend, you should switch back to unleaded petrol containing no alcohol.

CAUTION

Be careful not to spill fuel containing alcohol while refuelling. If fuel is spilled on the vehicle body, wipe it up immediately. Fuels containing alcohol can cause paint damage, which is not covered under New Vehicle Limited Warranty.

CAUTION

The fuel tank has an air space to allow for fuel expansion in hot weather. If you continue to add fuel after the filler nozzle has automatically shut off or an initial blowback occurs, the air chamber will become full. Exposure to heat when fully fuelled in this manner will result in leakage due to fuel expansion. To prevent such fuel leakage, stop filling after the filler nozzle has automatically shut off, or when using an alternative non automatic system, initial vent blowback occurs.

IMMOBILIZER KEYS

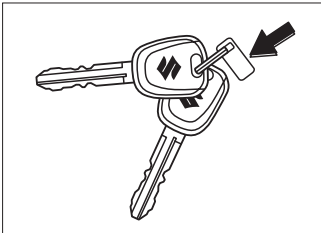

76G-03-002

Your vehicle comes with a pair of identical keys. Keep the spare key in a safe place. One key can open all of the locks on the vehicle.

The key identification number is stamped on a metal tag provided with the keys. Keep the tag in a safe place. If you lose your keys, you will need this number to have new keys made. Write the number down and keep it in a safe accessible place away from the vehicle.

Key Number :

▲ WARNING

- Do not use locally made key.
- Should you require a duplicate key, place your order with a **MARUTI SUZUKI dealer only.**

Note:

Keep the spare key very carefully. When it is lost, consult your dealer by quoting key number.

Immobilizer System

This system is designed to help prevent vehicle theft by electronically disabling the engine starting system.

The engine can be started only with your vehicle's original immobilizer ignition key which has an electronic identification code programmed into it. The key communicates the identification code to the vehicle when the key is turned to the "ON" position. If you need to make spare keys, contact your MARUTI SUZUKI dealer. The vehicle must be programmed with the correct identification code for the spare keys. A key made by an ordinary locksmith will not work.

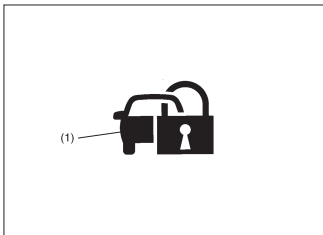

76G-03-003

If the Immobilizer system light (1) blinks when the ignition switch is in the "ON" position, there may be something wrong with your key or with the immobilizer system. Contact your MARUTI SUZUKI dealer to inspect the system.

NOTE:

- If you lose your Immobilizer ignition key, contact your MARUTI SUZUKI dealer as soon as possible to have the lost one deactivated, then have the new key made by them.
- If you own other vehicles with immobilizer keys, keep those keys away from the ignition switch when using your vehicle, or the engine may not be started because they may interfere with your vehicle's immobilizer system.

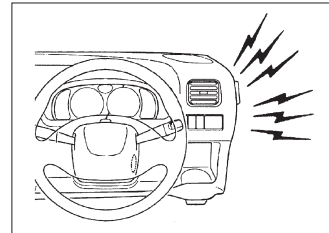

76G-03-004

CAUTION

In case of attaching any metal objects to the immobilizer key, it may not start the engine.

The immobilizer key is a sensitive electronic instrument. To avoid damaging the immobilizer key:

- Do not expose it to impacts, moisture or high temperature such as by leaving it on the dashboard under direct sunlight.
- Keep the immobilizer key away from magnetic objects.

Ignition Key Reminder (if equipped)

A buzzer sounds intermittently to remind you to remove the ignition key if it is in the ignition switch when the driver's doors is opened.

DOOR LOCKS

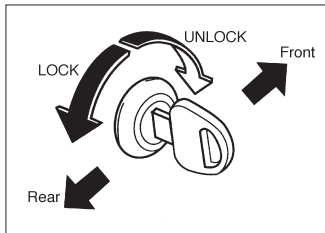

76G-03-005

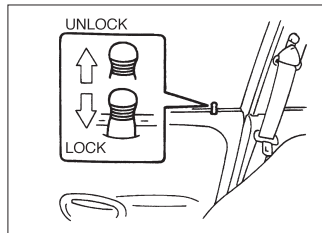

76G-03-006

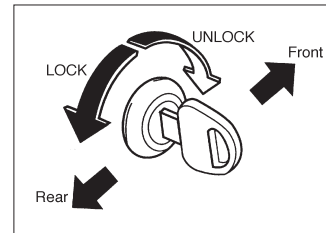

76G-03-007

Side Door Locks

To lock the driver's door from outside the vehicle:

- Insert the key fully and turn the top of the key toward the rear of the vehicle, or

- Push in the lock knob down and hold the door handle up as you close the door.

To unlock the driver's door from outside the vehicle, insert the key fully and turn the top of the key toward the front of the vehicle.

To lock a front passenger's door from outside the vehicle, turn the lock knob forward, then pull and hold the door handle as you close the door.

To lock a rear door from outside the vehicle, push in the lock knob down and close the door.

17

To lock a door from inside the vehicle, push the lock knob down. Pull the lock knob up to unlock the door.

⚠ WARNING

Always lock all doors when driving. Locking the door prevents occupants from being thrown from the vehicle in the event of an accident. It also helps prevent unintentional opening of the doors.

Central door locking system (if equipped)

You can lock and unlock all doors simultaneously by using the key in the driver's door lock.

To lock all doors simultaneously, insert the key in the driver's door lock and turn the top of the key toward the rear of the vehicle.

To unlock all doors simultaneously, insert the key in a driver's door lock and turn the top of the key toward the front of the vehicle.

You can also lock or unlock all the side doors by pushing down or pulling up the driver's door lock knob.

3-4

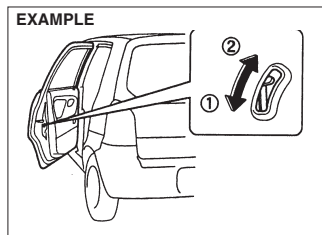

76G-03-008

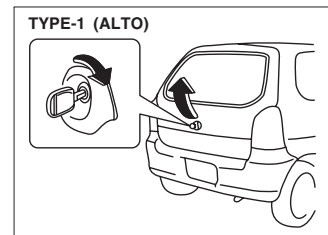

76G-03-009

NOTE:

- Moving the lock knob on passenger's door locks or unlocks the passenger's door only.
- Be sure to hold the door handle up when you close a locked front door, or the door will not remain locked.

Child-Proof Locks (if equipped)

As illustrated, a child-proof lock is provided for both rear doors. When the lock lever is down, position ①, the child proof lock is activated, and when up, in position ② the child-proof lock is deactivated, when the child-proof lock is activated, the rear door cannot be opened from the inside even if the inside door lock is unlocked but can be opened from the outside.

Rearend Door Lock

To unlock the door, insert the key into the lock knob and turn it clockwise.

⚠ WARNING

Be sure to place the child-proof lock in the locked position whenever children are seated in the rear.

WINDOWS

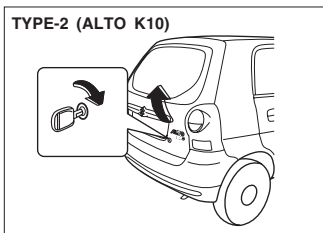

76G-03-009A

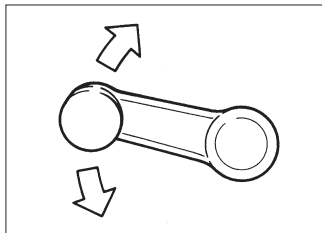

76G-03-011

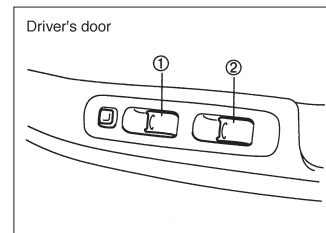

76G-03-012

▲ WARNING

Always make sure that the rearend door is closed and latched securely. Closing the door completely helps to prevent exhaust gases from entering the vehicle. Completely closing the rearend door also helps prevent occupants from being thrown from the vehicle in the event of an accident.

Raise or lower the door windows by turning the handle located on the door panel.

Electric window controls (if equipped)

The driver's door has switches ① & ② to operate the driver's window and front passenger's window respectively.

The passenger's door only has a switch ③ to operate the passenger's window. The electric windows can only be operated when the ignition switch is in the "ON" position.

To open a window with the driver's door switches, push the top part of the switch and to close the window lift up the top part of the switch.

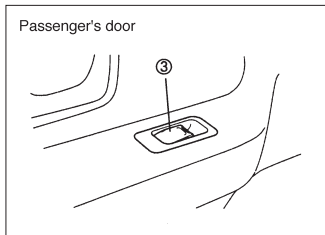

76G-03-013

The driver's window has an "auto-down" feature for added convenience (at toll booths or drive-through restaurants, for example). This means you can open the window without holding the window switch in the "Down" position. Press the driver's window switch completely down and release it. To stop the window before it reaches the bottom, lift up the switch briefly.

To open or to close a window with the passenger's door switch, push the top part of the switch or lift up the top part of the switch respectively.

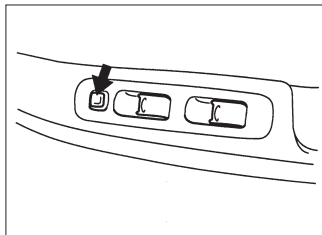

76G-03-014

The driver's door also has a lock switch for the passenger's window. When you push in the lock switch, the passenger's window can not be raised or lowered by operating either of the switches ② or ③. To restore normal operation, push the switch again.

⚠ WARNING
 You should always push in the lock switch when there are children in the vehicle. Children can be seriously injured if they get part of their body caught by the window during operation.

CAUTION
 Since the electric windows consumes a large amount of electricity, the same should not be used excessively with engine in "OFF" condition.

MIRRORS

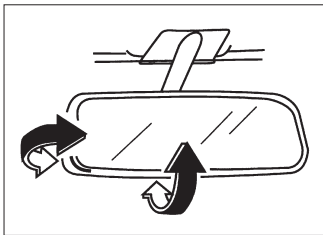

76G-03-015

Inside Rearview Mirror

To adjust the inside rearview mirror, move the mirror up, down, or sideways to obtain the best view.

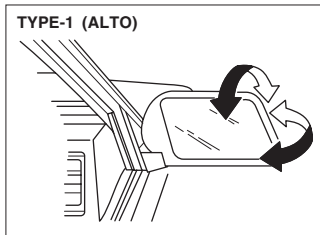

76G-03-017

Outside Rearview Mirrors

Adjust the outside rearview mirrors (with the help of control lever, if equipped), so that you can just see the side of your vehicle in the mirrors.

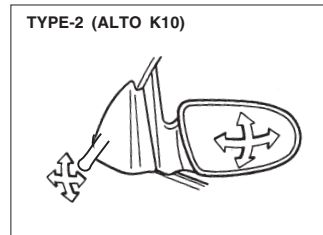

76G-03-017A

▲ WARNING

Be careful when judging the size or distance of a vehicle or other object seen in the side convex mirror (if equipped). Be aware that objects look smaller and appear farther away than when seen in a flat mirror.

BEFORE DRIVING

76G-74E

FRONT SEAT ADJUSTMENT

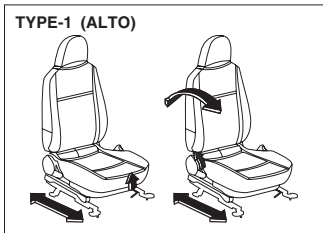

⚠ WARNING
Never attempt to adjust the driver's seat or seatback while driving. The seat or seatback could move unexpectedly, causing loss of control. Make sure that the driver's seat and seatback are properly adjusted before you start driving.

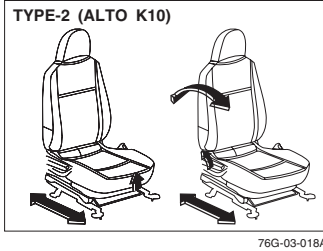

ADJUSTING SEAT POSITION

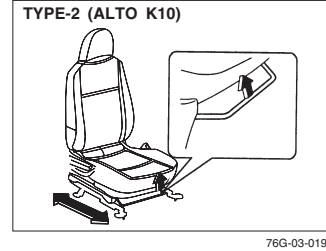
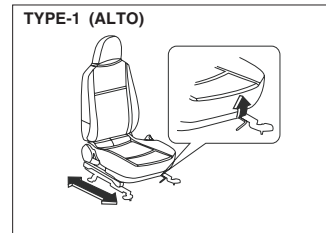

ADJUSTING SEATBACKS

The adjustment lever for each front seat is located under the front of the seat. To adjust the seat position, pull up on the adjustment lever and slide the seat forward or rearward. After adjustment, try to move the seat forward and rearward to ensure that it is securely latched.

▲ WARNING

To avoid excessive seat belt slack, which reduces the effectiveness of the seat belts as a safety device, make sure that the seats are adjusted before the seat belts are fastened.

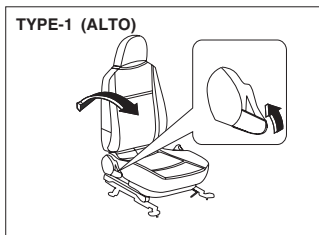

76G-03-022



76G-03-023

▲ WARNING

Seatbacks should always be in an upright position when driving, or seat belt effectiveness may be reduced. Seat belts are designed to offer maximum protection when seatbacks are in the fully upright position.

Front Seats

The seatbacks can be adjusted to different angles. To adjust the seatback angle, pull up the lever on the outboard side of the seat, move the seatback to the desired position, and release the lever to lock the seatback in place.

SEAT BELTS

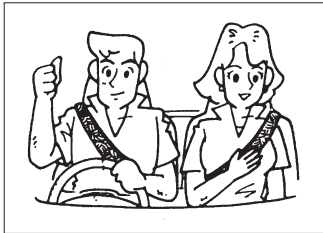

76G-03-026

▲ WARNING

Seat belts are good help to protect occupants from injury or death in the event of accidents. We urge you to wear seat belts at all times if the belts are equipped. If seat belts are not equipped at the rear seating positions, we recommend you to install optional or after market high quality seat belts to increase occupant's safety.

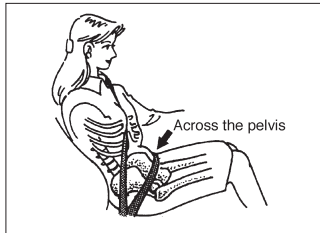

76G-03-027

▲ WARNING

- Never allow persons to ride in the cargo area of a vehicle. In the event of an accident, there is a much greater risk of injury for persons who are not riding in a seat with their seat belt securely fastened.
- Seat belts should always be adjusted so the lap portion of the belt is worn low across the pelvis, not across the waist. Shoulder straps should be worn on the outside shoulder only, and never under the arm. Seat belts should never be worn with the straps twisted and should be adjusted as

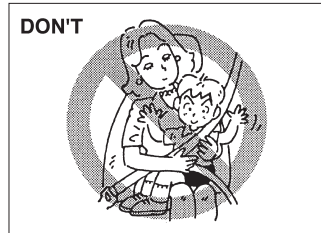

76G-03-028

▲ WARNING

- ← tightly as is comfortable to provide the protection for which they have been designed. A slack belt will provide less protection than one which is snug.
- Make sure that each seat belt buckle is inserted into the proper buckle catch.
- Do not wear your seat belt over hard or breakable objects in your pockets or on your clothing. If an accident occurs, objects such as glasses, pens, etc. under the seat belt can cause injury. →

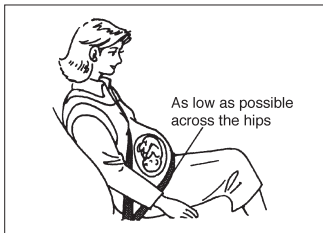

76G-03-029

▲ WARNING

- ◀ Never use the same seat belt on more than one occupant and never attach a seat belt over an infant or child being held on an occupant's lap. Such seat belt use could cause serious injury in the event of an accident.
- Pregnant women should use seat belts, although specific recommendations about restraint use should be made by the woman's medical advisor. Remember that the lap portion of the belt should be worn as low as possible across the hips, as shown in the diagram. ➡

▲ WARNING

- ◀ Periodically inspect seat belt assemblies for excessive wear and damage. Seat belts should be replaced if webbing becomes frayed, contaminated, or damaged in any way. It is essential to replace the entire seat belt assembly after it has been stressed in an impact, even if damage to the assembly is not obvious.
- Infants and small children should never be transported unless they are properly restrained. Restraint systems for infants and small children can be purchased locally and should be used. Make sure that the system you purchase meets applicable safety standards. Read and follow all the directions provided by the manufacturer.
- Avoid contamination of seat belt webbing by polishes, oils, chemicals, and particularly battery acid. Cleaning may safely be carried out using mild soap and water.
- For children, if the shoulder belt irritates the neck or face, move the child closer to the center of the vehicle. ➡

▲ WARNING

- ◀ Be sure to inspect all seat belt assemblies after any collision. Any seat belt assembly which was in use during a collision (other than a very minor one) should be replaced, even if damage to the assembly is not obvious. Any seat belt assembly which was not in use during a collision should be replaced if it does not function properly or is damaged in any way.

BEFORE DRIVING

76G-74E



76G-03-030

To fasten the seat belt, sit up straight and well back in the seat, pull the buckle tongue attached to the seat belt across your body and slide it into the buckle catch on the opposite side until you hear a "click".

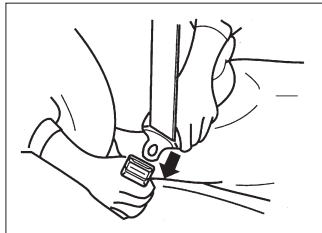

76G-03-031

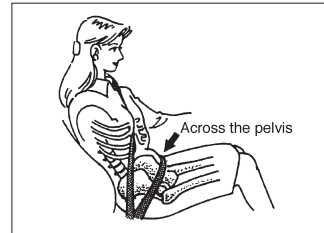

76G-03-033

To reduce the risk of sliding under the belt during a collision, position the lap portion of the belt across your lap as low on your hips as possible and adjust the belt to a snug fit using the proper method for each type of the belt as described below. Make sure that the belt is not twisted.

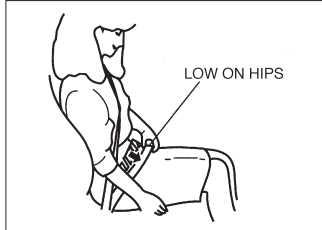

76G-03-032

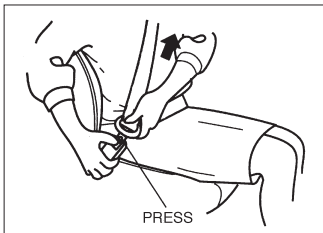

76G-03-034

To unfasten the belt, press the release button on the buckle catch.

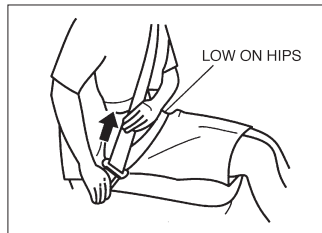

76G-03-035

To Adjust the Belt

- Pull the shoulder portion of the belt upwards through the tongue plate.

The length of the diagonal shoulder strap adjusts itself to allow freedom of movement. The seat belt has an emergency locking retractor (ELR), which is designed to lock the seat belt only during a sudden stop or impact.

▲ WARNING

No modifications or additions of any sort should be made to the seat belt or its operating mechanism.

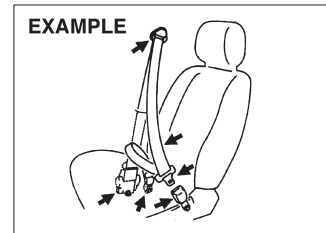

76G-03-036

Seat Belt Inspection

Periodically inspect the seat belts to make sure they work properly and are not damaged. Check the webbing, buckles, latch plates, retractors, anchorages and guide loops. Replace any seat belts which do not work properly or are damaged.

BEFORE DRIVING

76G-74E

LAP BELT (if equipped)

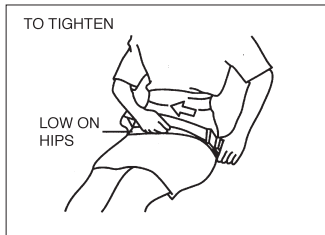

76G-03-037

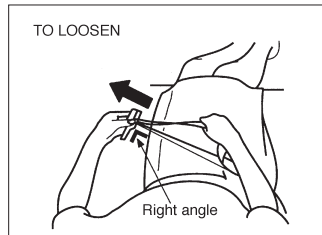

76G-03-038

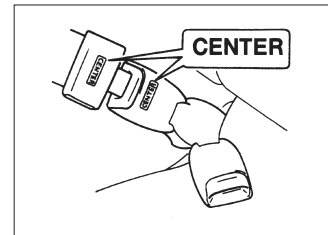

76G-03-039

On this belt the adjuster is incorporated in the tongue unit.

To tighten the belt, pull the free end of the belt across alongside the lap strap until it is adjusted to a snug comfortable position.

To lengthen, release the tongue from the buckle unit, pull the tongue (adjuster) in the direction of the arrow, at right angles to the belt. The tongue should then be refitted into the buckle unit and the belt tightened as previously described.

NOTE:

To identify the center seat belt buckle catch and tongue in the rear seat, "CENTER" is moulded on the buckle catch and tongue of the center lap belt. The buckle catches are designed so a buckle tongue can not be inserted into the wrong buckle catch.

STEERING COLUMN CONTROLS

Ignition Switch 4-1
Lighting/Turn Signal Control Lever 4-2
Hazard Warning Switch 4-5
Windscreen Wiper and Washer Lever 4-5
Horn 4-6
Electrical Power Steering (if equipped) 4-7

IGNITION SWITCH

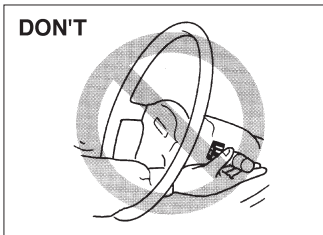

76G-04-001

▲ WARNING
To avoid possible injury, do not operate controls by reaching through the steering wheel.

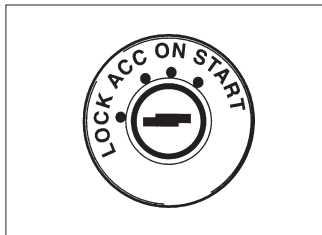

76G-04-002

The ignition switch has the following four positions:

▲ WARNING

- Do not use any locally made key.
- Should you require duplicate key, place your order with MARUTI SUZUKI dealer only.

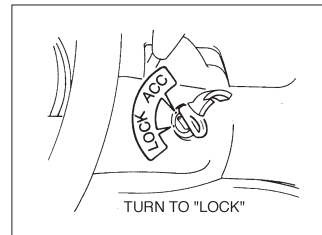

76G-04-003

LOCK
This is the normal parking position. It is the only position in which the key can be removed.

The "LOCK" position locks the ignition, and prevents normal use of the steering wheel after the key is removed.

To release the steering lock, fully insert the key and turn it clockwise to one of the other positions. If you have trouble turning the key to unlock the steering, try turning the steering wheel slightly to the right or left while turning the key.

ACC

Accessories such as the radio can operate, but the engine is off.

ON

This is the normal operating position. All electrical systems are on.

START

This is the position for starting the engine using the starter motor. The key should be released from this position as soon as the engine starts.

▲ WARNING

- Never remove the ignition key while the vehicle is moving. The steering wheel will lock and you will not be able to steer the vehicle.
- Do not leave children alone in a parked vehicle. Unattended children could cause accidental movement of the vehicle, which could result in severe personal injury.
- Always remove the key when parked to prevent unintentional operation of the vehicle and to improve security.

DON'T

76G-04-004

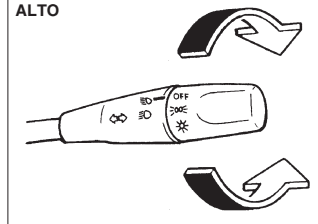
LIGHTING/TURN SIGNAL CONTROL LEVER**ALTO**

76G-04-005

CAUTION

- Do not use the starter motor for more than 15 seconds at a time. If the engine does not start; wait 15 seconds before trying again. If the engine does not start after several attempts, check the fuel and ignition systems or consult your MARUTI SUZUKI dealer.
- Do not leave the ignition switch in the "ON" position if the engine is not running as the battery will discharge.

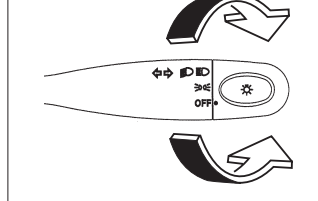
ALTO K10 TYPE-1

76G-04-005A

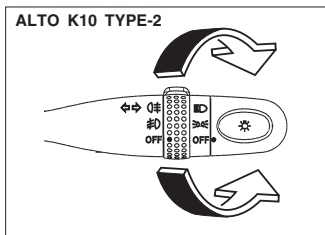

76G-04-005B

This control lever is located on the outboard side of the steering column. Operate the lever as described below.

Lighting Operation

To turn the lights on or off, twist the knob on the end of the lever. There are three positions: in the "OFF" position all lights are off; in the middle position the front parking lights, tail-lights, registration plate light, and instrument lights are on, but the headlights are off; in the third position the headlights come on in addition to the other lights.

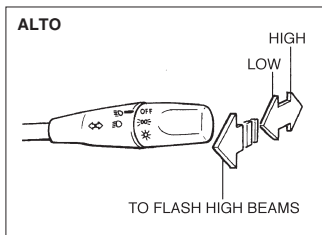

76G-04-006

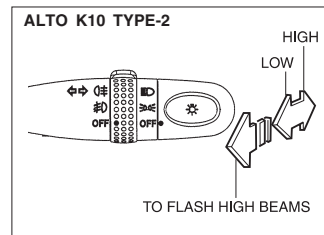

76G-04-006B

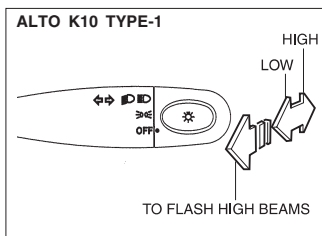

76G-04-006A

With the headlights on, push the lever forward to switch to the high beams (main beams) or pull the lever toward you to switch to the low beams. When the high beams (main beams) are on, a light on the instrument panel will come on. To flash the high beams (main beams) pull the lever slightly towards you and release it.

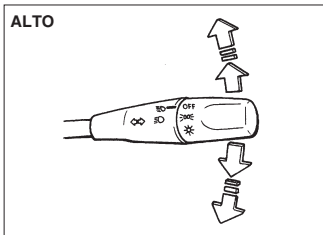

76G-04-007

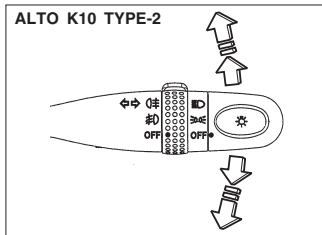

76G-04-007B

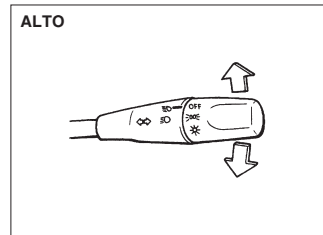

76G-04-008

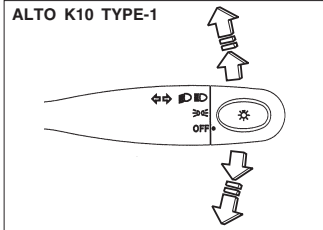

76G-04-007A

Turn Signal Operation

With the ignition switch in the "ON" position, move the lever up or down to activate the left or right turn signals.

Normal Turn Signal

Move the lever clockwise until it clicks to signal a right turn or anticlockwise to signal a left turn. When the turn is completed, the signal will cancel and the lever will return to its normal position.

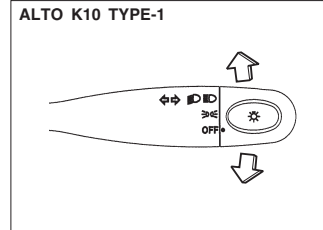

76G-04-008A

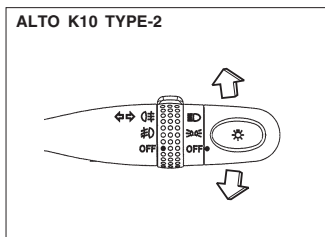

76G-04-008B

Lane Change Signal

Some times, such as when changing lanes, the steering wheel is not turned far enough to cancel the turn signal. For convenience, you can flash the turn signal by moving the lever part way and holding it there. The lever will return to its normal position when you release it.

HAZARD WARNING SWITCH

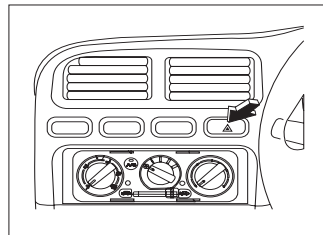

76G-04-009

Push in the marked part of the hazard warning switch to activate the hazard warning lights. All four turn signal lights and both turn signal indicators will flash simultaneously. To turn off the lights, push the switch once again.

Use the hazard warning lights to warn other traffic during emergency parking or when your vehicle could otherwise become a traffic hazard.

WINDSCREEN WIPER AND WASHER LEVER

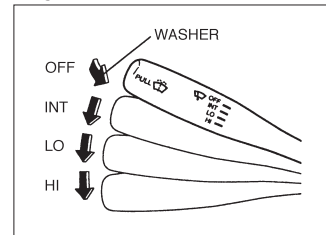

76G-04-010

Windscreen Wipers

To turn the windscreen wipers on, move the lever down to one of the three operating positions. In the "INT" position, (if equipped) the wipers operate intermittently. The "INT" position is very convenient for driving in mist or light rain. In the "LO" position the wipers operate at a steady low speed. In the "HI" position, the wipers operate at a steady high speed. To turn off the wipers, move the lever back to the "OFF" position.

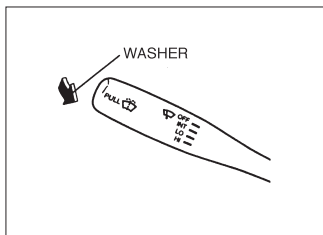

76G-04-011

Windscreen Washer

To spray windscreen washer fluid, pull the lever toward you. The windscreen wipers will automatically turn on at low speed if they are not already on and the "INT" position is equipped.

⚠ WARNING

- To prevent windscreen icing in cold weather, turn on the defroster to heat the windscreen before and during windscreen washer use.
- Do not use radiator antifreeze in the windscreen washer reservoir. It can severely impair visibility when sprayed on the windscreen, and can also damage your vehicle's paint.

CAUTION

To prevent damage to the windscreen wiper and washer system components, you should take the following precautions:

- Do not continue to hold in the lever when there is no windscreen washer fluid being sprayed or the washer motor can be damaged.
- Do not attempt to remove dirt from a dry windscreen with the wipers or you can damage the windscreen and the wiper blades. Always wet the windscreen with washer fluid before operating the wipers.
- Clear ice or packed snow from the wiper blades before using the wipers.
- Check the washer fluid level regularly. Check it often when the weather is bad.
- Only fill the washer fluid reservoir 3/4 full during cold weather to allow room for expansion if the temperature falls low enough to freeze the solution.

HORN

EXAMPLE

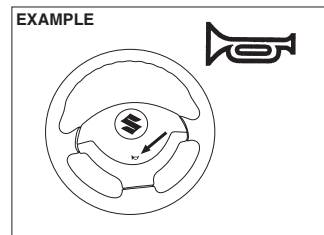

76G-04-012

Press the horn button of the steering wheel to sound the horn. The horn will sound with the ignition switch in any position.

STEERING COLUMN CONTROLS

76G-74E

ELECTRIC POWER STEERING (If equipped)

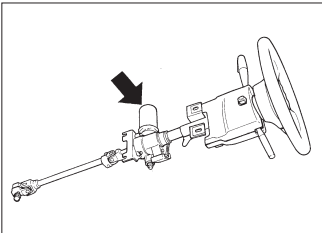

76G-04-013

Depending on specifications, your vehicle is equipped with electric power steering system to reduce the steering effort while driving.

INSTRUMENT PANEL

Instrument Panel	5-1
Instrument Cluster	5-2
Warning and Indicator Lights	5-4
Speedometer	5-7
Odometer/Tripmeter	5-8
Tachometer (if equipped)	5-9
Fuel Gauge	5-9
High Engine Coolant Temperature Warning Light (Red Color)	5-9
Glove Box	5-10
Head Light Leveling Switch	5-10
Heating System (if equipped)	5-11
System Operating Instructions	5-12
Air Conditioning System (if equipped)	5-17
System Operating Instructions	5-17

INSTRUMENT PANEL

76G-74E

INSTRUMENT PANEL

TYPE-1 (ALTO)

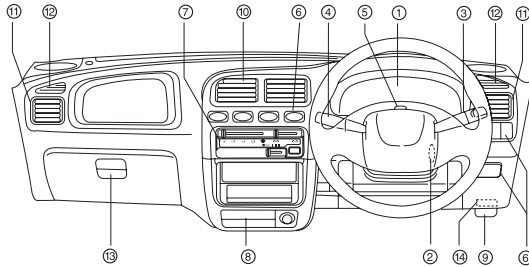

1. Instrument cluster
2. Ignition switch
3. Lighting switch/Turn signal and dimmer switch
4. Windscreen wiper and washer switch
5. Hazard warning switch
6. Other switches (if equipped)
7. Heater control panel (if equipped)
8. Ashtray (if equipped)
9. Bonnet release (if equipped)
10. Center ventilator
11. Side ventilator
12. Side defroster
13. Glove box
14. Fuse box

76G-05-001

TYPE-2 (ALTO / ALTO K10)

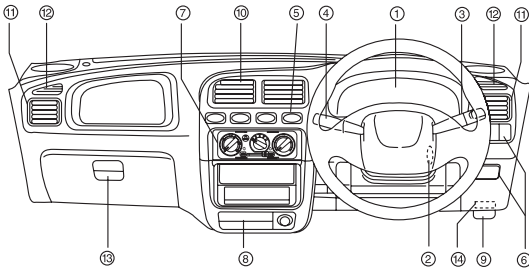

76G-05-002

INSTRUMENT CLUSTER (ALTO)

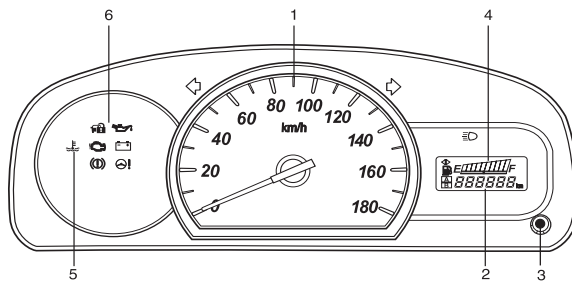

- ① Speedometer
- ② Odometer/Trip meter
- ③ Odometer/Trip meter selector knob
- ④ Fuel gauge
- ⑤ High Temperature Coolant warning lamp
- ⑥ Warning and indicator lights

76G-05-003

INSTRUMENT PANEL

76G-74E

INSTRUMENT CLUSTER (ALTO K10)

TYPE-1

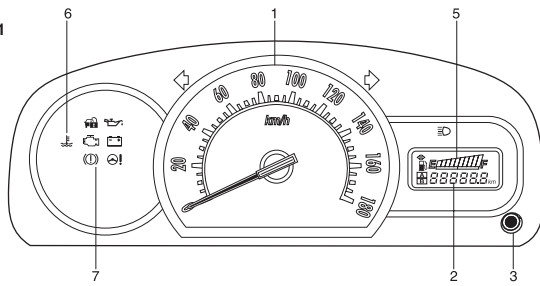

- ① Speedometer
- ② Odometer/Trip meter
- ③ Odometer/Trip meter selector knob
- ④ Tachometer (if equipped)
- ⑤ Fuel gauge
- ⑥ High Temperature Coolant warning lamp
- ⑦ Warning and indicator lights

TYPE-2

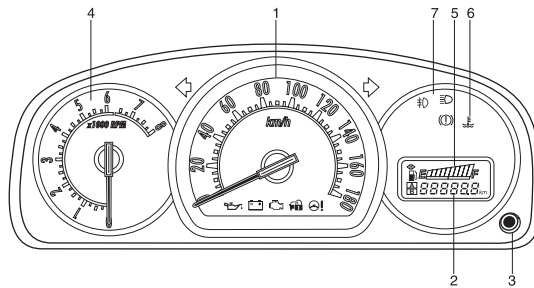

76G-05-004

WARNING AND INDICATOR LIGHTS



76G-05-005

Brake fluid level warning/Parking Brake Indicator light

This light operates under three different type of operations :

- 1) The light comes on briefly when the ignition switch is turned to the "ON" position.
- 2) The light comes on when the parking brake is engaged with the ignition switch in the "ON" position.
- 3) The light comes on when the fluid in the brake fluid reservoir falls below the adequate level.

The light should go out after starting the engine and fully releasing the parking brake, if the fluid level in the brake fluid reservoir is adequate.

If the light does not go off or comes on whilst your driving, it may mean that there is something wrong with the vehicle's braking system. If this happens, you should:

- 1) Pull off the road and stop carefully.

▲ WARNING

Remember that stopping distance may be longer, you may have to push harder on the pedal, and the pedal may go down farther than normal.

- 2) Test the brakes by carefully starting and stopping at the side of the road.
- 3) If you determine that it is safe, drive carefully at low speed to the nearest dealer for repairs. or
- 4) Have the vehicle towed to the nearest dealer for repairs.

▲ WARNING

If any of the following conditions occur, you should immediately ask your MARUTI SUZUKI dealer to inspect the brake system.

- If the brake fluid level warning light does not go out after the engine has been started and the parking brake has been fully released.
- If the brake fluid level warning light does not come on when the ignition switch is turned to the "ON" position with the parking brake applied.
- If the brake fluid level warning light comes on at any time during vehicle operation.

NOTE:

Because the disc brake system is self adjusting, the fluid level will drop as the brake pads become worn.

Replenishing the brake fluid reservoir is considered normal periodic maintenance.



76G-05-006

Oil Pressure Light

This light comes on when the ignition switch is turned on, and goes out when the engine is started. The light will come on and remain on if there is insufficient oil pressure. If the light comes on when driving, pull off the road as soon as you can and stop the engine. Check the oil level and add oil if necessary (see section "INSPECTION & MAINTENANCE"). If there is enough oil, the lubrication system should be inspected by your MARUTI SUZUKI dealer before you drive the vehicle again.

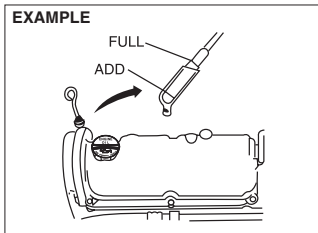

76G-05-007

CAUTION

- If you operate the engine with this light on, severe engine damage can result.
- Do not rely on the Oil Pressure Light to indicate the need to add oil. Be sure to periodically check the engine oil level (see section "INSPECTION & MAINTENANCE").

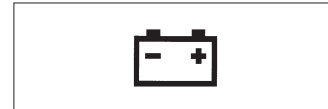

76G-05-008

Charging Light

This light comes on when the ignition switch is turned on, and goes out when the engine is started. The light will come on and remain on if there is something wrong with the battery charging system. If the light comes on when the engine is running, the charging system should be inspected immediately by your MARUTI SUZUKI dealer.

CAUTION

Do not continue driving long with the charging light ON as this will drain the battery 'dead'.

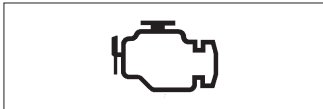

76G-05-009

"Malfunction Indicator" Light

Your vehicle has a computer-controlled emission control system. A "Malfunction Indicator" light is provided on the instrument panel to indicate when it is necessary to have the emission control system serviced. The "Malfunction Indicator" light comes on when the ignition switch is turned to "ON" and goes out when the engine is started.

If the "Malfunction Indicator" light comes on when the engine is running, there is a problem with the emission control system. Take the vehicle to your MARUTI SUZUKI dealer to have the problem corrected.

CAUTION

Continuing to drive the vehicle when the "Malfunction Indicator" light is on can cause permanent damage to the vehicle's emission control system, and can affect fuel economy and driveability.



76G-05-009A

Electric Power Steering Light (if equipped)

This light comes on when the ignition switch is turned to the "ON" position, and goes out when the engine is started.

If this light comes on while driving, the power steering system may not work properly. Have the system inspected by your MARUTI SUZUKI Authorized workshop.

NOTE:

If the power steering system does not work properly, you will feel heavier to steer but you still will be able to steer.



76G-05-010

Immobilizer System Light

When the ignition switch is turned to the "ON" position, this light comes on to let you know the light is working. If this light blinks with the ignition switch turned to "ON", there may be something wrong with the immobilizer system. Contact your MARUTI SUZUKI dealer to have the system inspected.

SPEEDOMETER

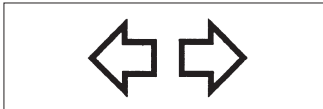

76G-05-011

Turn Signal Indicators
 When you turn on the left or right turn signals, the corresponding green arrow on the instrument panel will flash along with the respective turn signal lights. When you turn on the hazard warning switch, both arrows will flash along with all of the turn signal lights.



76G-05-012

Main Beam (High Beam) Indicator Light
 This indicator comes on when headlight main beams (high beams) are turned on.

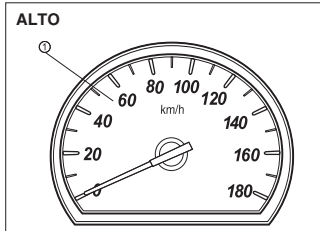

76G-05-013

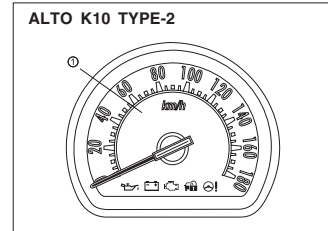

76G-05-013B

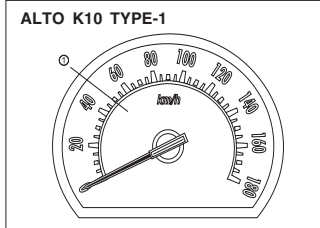

76G-05-013A

The speedometer (1) indicates vehicle speed in km/h.

ODOMETER/TRIPMETER

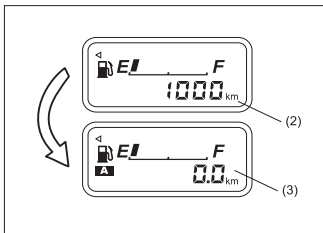

76G-05-014

The odometer (2) records the total distance the vehicle has been driven. The trip meter (3) can be used to measure the distance travelled on short trips or between fuel stops.

CAUTION

Keep track of your odometer reading and check the maintenance schedule regularly for required services. Increased wear or damage to certain parts can result from failure to perform required services at the proper mileage intervals.

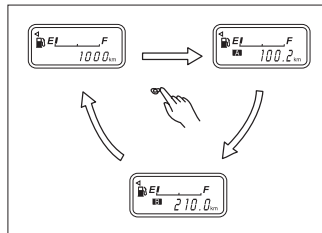

76G-05-015

When the ignition switch is turned to "ON" the display shows the odometer or trip meter.

The display shows three types of indication; odometer, trip meter A and/or trip meter B. Push the selector knob quickly to switch the indication among the three.

You can use the two trip meters (A and B) independently.

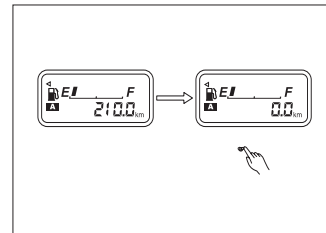

76G-05-016

Push the selector knob for a little while (about 2 seconds) to reset the trip meter to zero.

INSTRUMENT PANEL

76G-74E

TACHOMETER (if equipped)

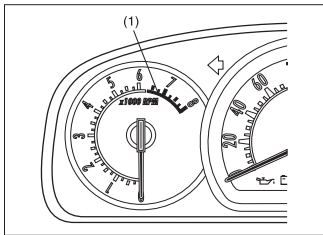

76G-05-013C

The tachometer indicates engine speed in revolutions per minute.

CAUTION

Never drive with the engine speed indicator in the red zone (1) or severe engine damage can result. When downshifting to a lower gear, make sure not to operate with excessive revolution speeds of the engine. Refer to "Downshifting maximum allowable speeds" in the "OPERATING YOUR VEHICLE" section.

FUEL GAUGE

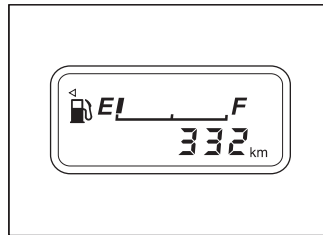

76G-05-018

When the ignition switch is in the "ON" position, this gauge gives an approximate indication of the amount of fuel in the fuel tank. "F" stands for full and "E" stands for empty.

When the fuel meter indicator shows only one segment to "E", refill the tank as soon as possible.

Note:
If the last segment blinks, it means that the fuel tank is almost empty.

Note:
The fuel level indicator varies depending on road conditions (for example, slope or curve) and driving conditions because of fuel moving in the tank.

HIGH ENGINE COOLANT TEMPERATURE WARNING LIGHT (Red Color)



76G-05-019

When the ignition switch is turned to the "ON" position, this light comes on briefly so you can check that the light is working. If this light blinks while driving, it means the engine is running hot. Avoid driving conditions that may lead to actual overheating. If the light stays on without blinking, then the engine is overheating. Follow the instructions in the "If the Engine Over heats" of "EMERGENCY SERVICE" section.

CAUTION

Continuing to drive the vehicle when engine overheating is indicated can result in severe engine damage.

GLOVE BOX

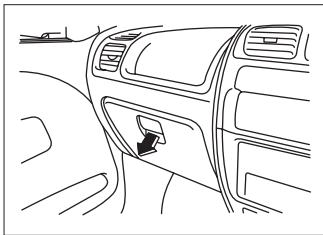

76G-05-022

To open the glove box, pull the latch lever. To close it, push the lid until it latches securely.

⚠ WARNING
 Never drive with the glove box lid open. It could cause injury if an accident occurs.

HEADLIGHT LEVELING SWITCH

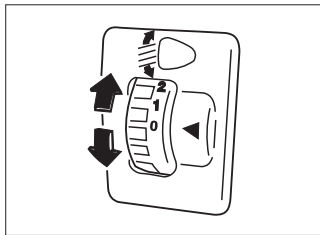

76G-05-023

Level the headlight beam according to the load condition of your vehicle by turning this switch. The chart shows the appropriate switch position for different vehicle-load conditions.

Vehicle load Condition	Switch Position
Driver only	0
Driver + 1 passenger (in front seat)	0
Driver + 3 passenger No cargo	1
Driver + 3 passenger Cargo added	2
Driver + full cargo	3
Dummy	4

INSTRUMENT PANEL

76G-74E

HEATING SYSTEM (if equipped)

The heating system provides heating, demisting, and ventilation.

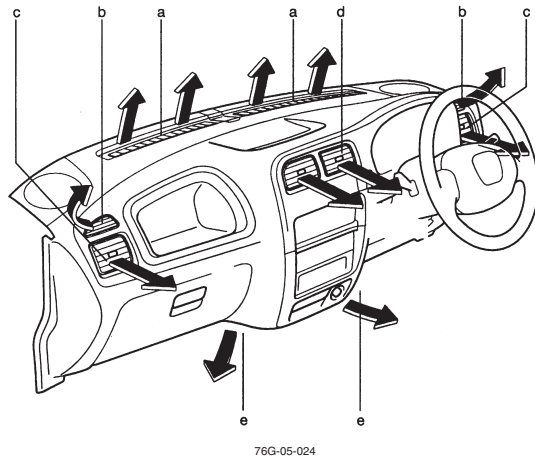

- a. Windscreen defroster outlet
- b. Side defroster outlet
- c. Side outlet
- d. Center outlet
- e. Floor outlet

TYPE-1 (ALTO)

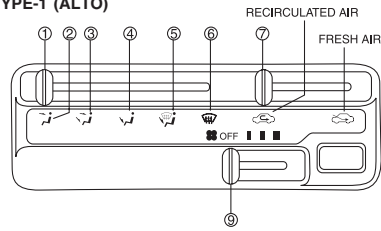

TYPE-2 (ALTO / ALTO K10)

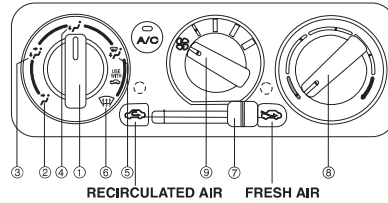

Description of Controls (if equipped)

Function Lever/Knob ①: This lever/knob is used to select one of the functions described below:



76G-05-027

VENTILATION ②: Temperature-controlled air comes out of the center and side air outlets.



76G-05-028

BI-LEVEL ③: Temperature-controlled air comes out of the floor outlets and cooler air comes out of the center and side outlets. When the temperature control lever is in the fully "COOL" position or fully "HOT" position, however, the air from the floor outlets and the air from the center and side outlets will be the same temperature.



76G-05-029

HEAT ④: Temperature-controlled air comes out of the floor outlets.



76G-05-030

HEAT & DEFROST ⑤: Temperature-controlled air comes out of the floor outlets, the windscreen defroster outlets, and the side defroster outlets.



76G-05-031

DEFROST ⑥: Temperature-controlled air comes out of the windscreen defroster outlets and the side defroster outlets.



76G-05-032

Air Intake Lever/Knob ⑦: This lever/knob is used to select between circulating outside air (FRESH AIR) or recirculating inside air (RECIRCULATED AIR).

Temperature Control Lever/Knob ⑧: (if equipped) This lever /knob is used to control the temperature of the air that comes out of the air outlets.

Fan switch ⑨: This switch is used to turn on the fan and to select fan speed. Fan switch has different speed options:-

For Type-1 (Alto)

Four positions-OFF, LOW, MEDIUM and HIGH.

For Type-2 (Alto / Alto K10)

Five Positions-OFF, LOW, MEDIUM LOW, MEDIUM HIGH and HIGH.

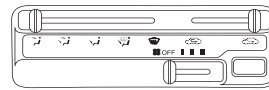
SYSTEM OPERATING INSTRUCTIONS**TYPE-1 (ALTO)**

76G-05-032

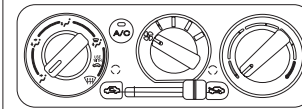
TYPE-2 (ALTO / ALTO K10)

76G-05-033

Natural Ventilation

Move the function lever/knob to "VENTILATION" and the air intake lever to "FRESH AIR", the temperature control lever/knob to the desired temperature position, and the fan switch to "OFF". Fresh air will flow through the vehicle when it is moving.

TYPE-1 (ALTO)

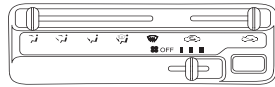

76G-05-034

Forced Ventilation

The lever/knob settings are the same as for natural ventilation except you move the fan switch to a position other than "OFF".

TYPE-2 (ALTO/ALTO K10)

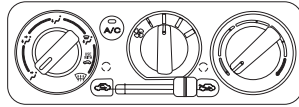

76G-05-035

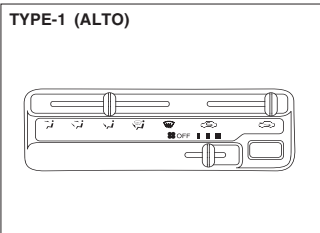

76G-05-036

Normal Heating (Using outside air)
Move the function lever/knob to "HEAT" and the air intake lever to "FRESH AIR", the temperature control lever/knob to the desired temperature position, and the fan switch to the desired fan speed position. Moving the fan switch to a higher fan speed position increases heating efficiency.

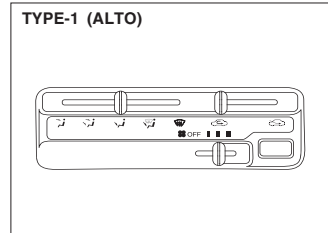

76G-05-038

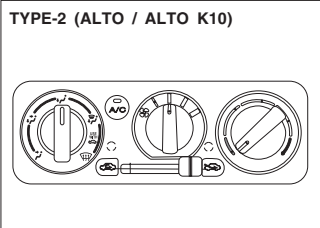

76G-05-037

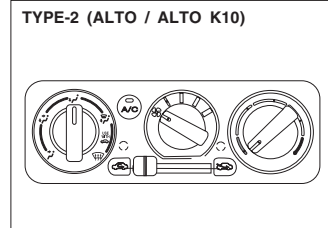

76G-05-039

Quick Heating (Using recirculated air)
 The lever/knob settings are the same as for normal heating except you move the air intake lever to "RECIRCULATED AIR". If you use this heating method for an extended period of time, the air in the vehicle can become contaminated and the windows can become misty. Therefore, use this method only for quick heating and change to the normal heating method as soon as possible.

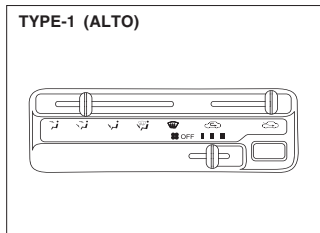

76G-05-040

Cool Face/Warm Feet
 Move the function lever/knob to "BI-LEVEL" and the air intake lever to "FRESH AIR", the temperature control lever/knob to the desired temperature position, and the fan switch to the desired fan speed position. Unless the temperature control lever is in the fully "COOL" position or fully "HOT" position, the air that comes out of the center and side outlets will be cooler than the air that comes out of the floor outlets.

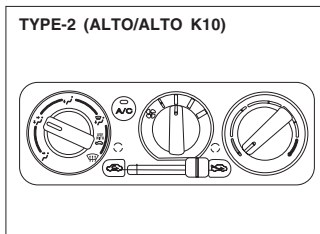

76G-05-041

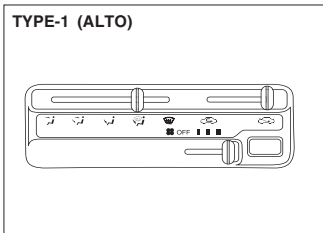

76G-05-042

Defrosting/Warm Feet

Move the function lever/knob to "HEAT & DEFROST" and the air intake lever to "FRESH AIR", the temperature control lever /knob to the desired temperature position, and the fan switch to "HIGH". When the windscreen has become clear, move the fan switch to the desired fan speed position.

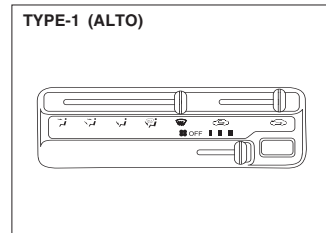

76G-05-044

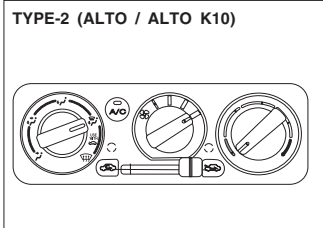

76G-05-043

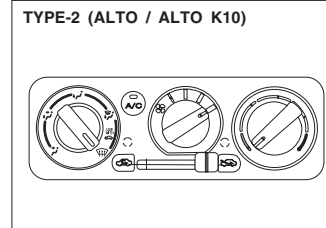

76G-05-045

Defrosting

Move the function lever/knob to "DEFROST" and the air intake lever to "FRESH AIR", the temperature control lever/knob to the desired temperature position, and the fan switch to "HIGH". Moving the temperature control lever/knob to a higher temperature position increases defrosting efficiency. When the windscreen has become clear, move the fan switch to the desired fan speed position.

**AIR CONDITIONING SYSTEM
(if equipped)**

(ALTO / ALTO K10)

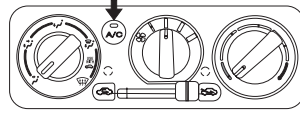

76G-05-047

If your vehicle is equipped with air conditioner, it has an A/C button located on the heater control panel. The air conditioning system can be used to provide cooling and dehumidifying, as described below. To turn on the air conditioning system, push in the A/C button and move the fan switch to a position other than "OFF". An indicator light will come on when the air conditioning system is on. To turn off the air conditioning system, push the A/C button again.

During operation of the air conditioner, you may notice slight changes in engine speed. These changes are normal, the system is designed so that the compressor turns on or off to maintain the desired temperature. Less operation of the compressor results in better fuel economy.

SYSTEM OPERATING INSTRUCTIONS

(ALTO / ALTO K10)

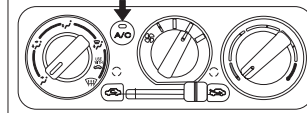

76G-05-049

Normal Cooling (using outside air)

Push in the A/C button, move the function lever/knob to "VENTILATION", the air intake lever to "FRESH AIR", the temperature control lever/knob to the "COOL" position, and the fan switch to the desired fan speed position. Moving the fan switch to a higher fan speed position increases cooling efficiency.

If the ambient temperature is high enough to cause insufficient cooling, use the "**Quick Cooling**" as following.

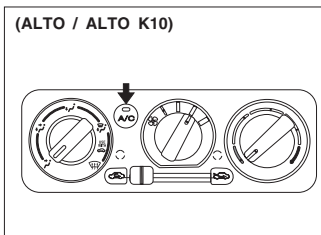

Quick Cooling (Using recirculated air)

The lever/knob settings are the same as for normal cooling except you move the air intake lever to "RECIRCULATED AIR". If you use this cooling method for an extended period of time, the air in the vehicle can become contaminated. Therefore, you should occasionally move the air intake lever to "FRESH AIR".

NOTE:

If your vehicle has been left in the sun with the windows closed, it will cool faster if you open the windows briefly while you operate the air conditioner with the air intake lever at "FRESH AIR" and the fan at high speed.

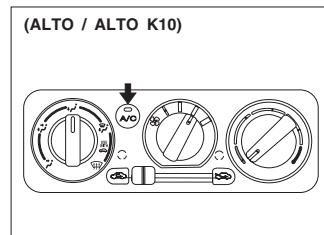

Dehumidifying

Push in the A/C button, move the function lever/knob to the desired function position, the air intake lever to "FRESH AIR", the temperature control lever/knob to the desired temperature position, and the fan switch to the desired fan speed position.

NOTE:

Because the air conditioner dehumidifies the air, turning it on will help keep the windows clear, even when blowing heated air using the DEMIST or HEATER & DEMIST functions.

Maintenance

If you do not use the air conditioner for a long period, such as during winter, it may not give the best performance when you start using it again. To help maintain optimum performance and durability of your air conditioner, it needs to be run periodically. Operate the air conditioner at least once a month for one minute with the engine idling. This circulates the refrigerant and oil and helps protect the internal components.

Note:

Your vehicle uses the air conditioning refrigerant HFC-134a, commonly called "R-134a". Only R-134a should be used in your vehicle.

CAUTION

Using the wrong refrigerant may damage your air conditioning system. Use R-134a only. Do not mix or replace the R-134a with other refrigerants.

OTHER CONTROLS AND EQUIPMENT

Parking Brake Lever 6-1
Pedals 6-2
Gear Lever 6-3
Fuel Filler Cap 6-3
Folding Rear Seats 6-5
Sun Visor 6-5
Interior Light Switch 6-6
Assist Grips 6-6
Bonnet 6-6
Frame Hooks (if equipped) 6-7
Cup Holder (if equipped) 6-8
Tyre Changing Tools 6-8
High Mount Stop Lamp 6-9

PARKING BRAKE LEVER

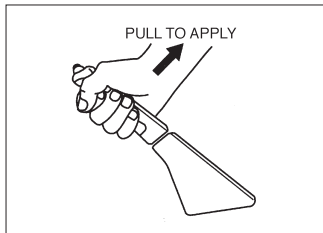

76G-06-001

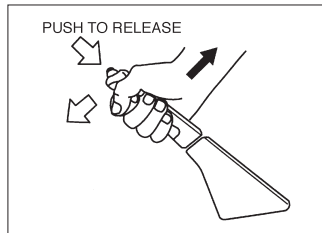

76G-06-002

The parking brake lever is located between the seats. To apply the parking brake, hold the brake pedal down and pull the parking brake lever all the way up.

To release the parking brake, hold the brake pedal down, pull up slightly on the parking brake lever, push the button on the end of the lever with your thumb, and lower the lever to its original position.

▲ WARNING

- Never drive your vehicle with the parking brake on: rear brake effectiveness can be reduced from over heating, brake life may be shortened, or permanent brake damage may result.
- If the parking brake does not hold the vehicle securely or does not fully release, have your vehicle inspected immediately by an authorized MARUTI SUZUKI dealer.

▲ WARNING

Always apply the parking brake fully before leaving your vehicle or it may move, causing injury or damage. When parking, make sure the gear shift lever for manual transmission is left in first gear or reverse. Remember, even though the transmission is in gear, you must always apply the parking brake fully.

PEDALS

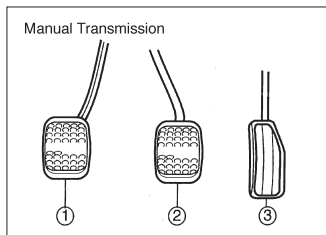

76G-06-003

Clutch Pedal ①

The clutch pedal is used to disengage the drive to the wheels when starting the engine, stopping, or shifting the transmission lever. Depressing the pedal disengages the clutch.

CAUTION

Do not drive with your foot resting on the clutch pedal. It could result in excessive clutch wear, clutch damage, or unexpected loss of engine braking.

Brake Pedal ②

Your MARUTI SUZUKI vehicle is equipped with front disc brakes and rear drum brakes. Depressing the brake pedal applies both sets of brakes.

You may hear occasional brake squeal when you apply the brakes. This is a normal condition caused by environmental factors such as cold, wet, snow, etc.

⚠ WARNING

If brake squeal is excessive and occurs each time the brakes are applied, you should have the brakes checked by your MARUTI SUZUKI dealer.

⚠ WARNING

Do not "ride" the brakes by applying them continuously or resting your foot on the pedal. This will result in overheating of the brakes which could cause unpredictable braking action, longer stopping distances, or permanent brake damage.

Accelerator Pedal ③

This pedal controls the speed of the engine. Depressing the accelerator pedal increases power output and speed.

**GEAR LEVER
MANUAL TRANSMISSION**

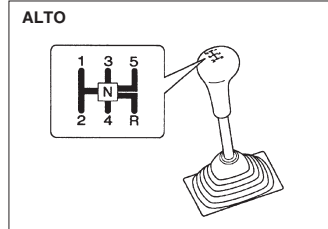

76G-06-004

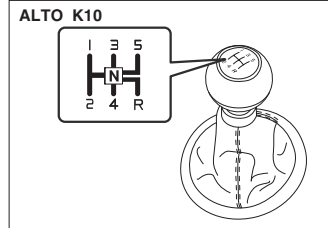

76G-06-004A

Your vehicle is equipped with a manual transmission. The gear change pattern for manual transmission is shown in the illustration. For details on how to use the transmission, refer to USING THE TRANSMISSION in the OPERATING YOUR VEHICLE section.

FUEL FILLER CAP

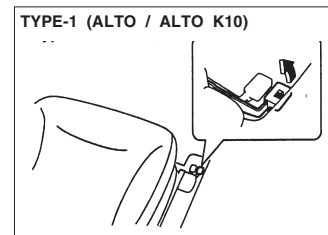

76G-06-005

The fuel filler cap is located on the left rear side of the vehicle. The fuel filler lid can be unlocked by pulling up the opener lever (if equipped) located on the outboard side of the driver's seat and locked by simply closing the lid.

⚠ WARNING

Remove the fuel filler cap slowly. The fuel may be under pressure and may spray out, causing injury.

⚠ WARNING

Petrol is extremely flammable. Do not smoke when refuelling, and make sure there are no open flames or sparks in the area.

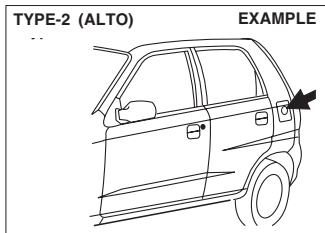

76G-06-006

The fuel filler cap is located on the left rear side of the vehicle. To unlock the fuel filler lid, turn the key clockwise. To lock turn the key anticlockwise.

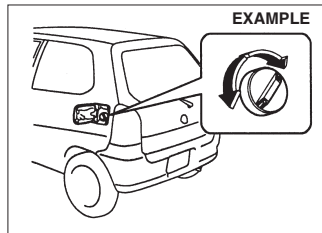

76G-06-007

The fuel tank filler cap has a "screw-on ratcheting type" feature.

- To remove - turn the cap counter clockwise. Turn the cap slowly to allow any residual pressure to escape.
- To install - turn the cap clockwise and tighten it securely until a "ratcheting" (clicking) sound is heard. The "ratcheting" sound indicates that the cap is on properly.

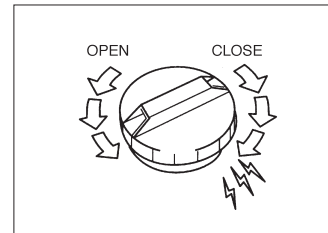

76G-06-008

CAUTION

If you need to replace the fuel cap, use only a cap specified for your model. Using an improper fuel cap can cause a serious malfunction of the fuel system. You can get the correct replacement cap from your MARUTI SUZUKI dealer.

FOLDING REAR SEATS

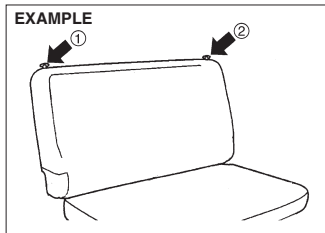

76G-06-011

The rear seats of your vehicle can be folded forward to provide additional luggage space.

To fold the rear seats forward, pull up the two lock knobs (1 and 2) on top of the seat simultaneously and fold the seatback forward. To raise the seatback lift it up and push it back until it locks into place.

▲ WARNING

When returning a rear seat to the normal position, make sure that movement of the seatback is unobstructed and the seatback is securely latched.

▲ WARNING

Luggage or other cargo should be stowed in the luggage compartment with the rear seat in an upright position, whenever possible. If you need to carry cargo in the passenger compartment with the rear seat back folded forward, be sure to secure the cargo or it may be thrown about, causing injury. Never pile cargo higher than the seatbacks.

SUN VISOR

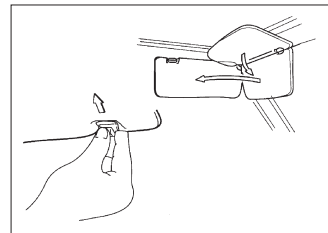

76G-06-012

The sun visor(s) can be pulled down to block glare coming through the wind screen, or they can be unhooked and turned to the side to block glare coming through the side window.

CAUTION

When unhooking and hooking a sun visor, be sure to handle it by the hard plastic parts or the sun visor can be damaged.

INTERIOR LIGHT SWITCH

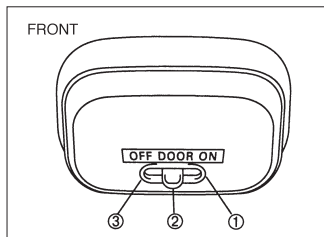

76G-06-013

This light switch has three positions which function as described below:

- ① The light comes on and stays on regardless of whether the door is open or closed.
- ② The light comes on when the door is opened.
- ③ The light remains off even when the door is opened.

NOTE:

Only front door(s) are involved in lighting operation of the interior light(s).

ASSIST GRIPS

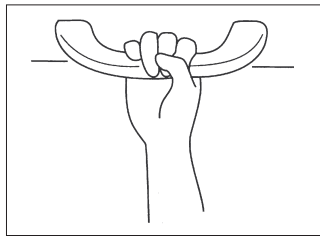

76G-06-014

Assist grips are provided for passenger convenience.

▲ WARNING

Do not hang items on the assist grips. They could obstruct the driver's view, resulting in an accident, or could be thrown about in an accident or abrupt manoeuvre, causing injury.

BONNET

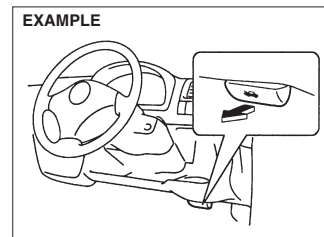

76G-06-015

To open the bonnet:

- 1) Pull the bonnet release handle located on the outboard side of the driver's side of the instrument panel. This will disengage the bonnet lock halfway.

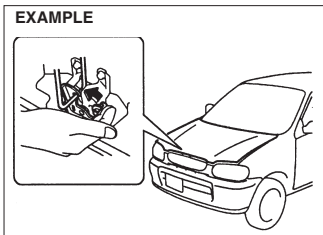

76G-06-016

2) Push the under-bonnet release lever sideways with your finger, as shown in the illustration. While pushing the lever, lift up the bonnet.

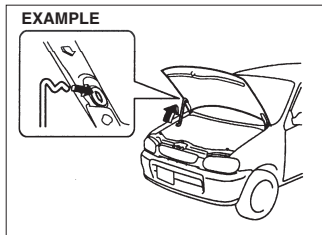

76G-06-017

3) Continue to lift up the bonnet until it is high enough to support with the prop rod.

▲ WARNING

Make sure the bonnet is fully closed and latched before driving. If it is not, it can fly up unexpectedly during driving, obstructing your view and resulting in an accident.

FRAME HOOKS (if equipped)

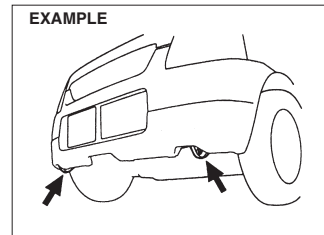

76G-06-018

Hooks are provided in both the front and rear of the vehicle for use in emergency situations. To tow your vehicle on the road or highway, follow the instruction of "TOWING" in "EMERGENCY SERVICE" section.

The shipping hook is provided on the rear of the vehicle for shipping use. Do not use the shipping hook for other than shipping purpose.

▲ WARNING

Do not use these hooks to tow (or be towed by) another vehicle on the road or highway except in emergency situations.

CUP HOLDER (if equipped)

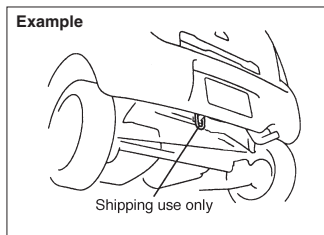

76G-06-019

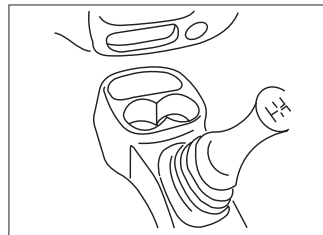

76G-06-020

The cup holder is provided in the center console (if equipped).

▲ WARNING

Do not use the cup holder to hold cups containing hot liquids, or objects other than cups. Objects in the cup holder may be thrown about during a sudden stop or impact, and could cause personal injury.

TYRE CHANGING TOOLS

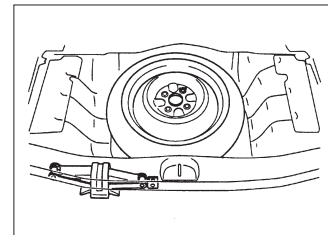

76G-06-021

The jack is stowed in the luggage compartment behind the rear seat.

To remove the jack, turn its shaft counterclockwise and pull the jack out of the storage bracket. To stow the jack, place it in the storage bracket and turn the shaft clockwise until the jack is securely held in place.

NOTE:

If it is hard to loosen the bolt that secures the spare tyre, use the jack handle shaft as illustrated.

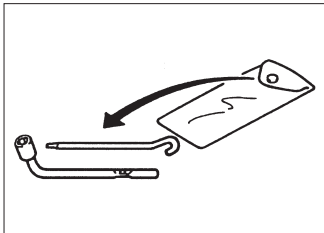

76G-06-022

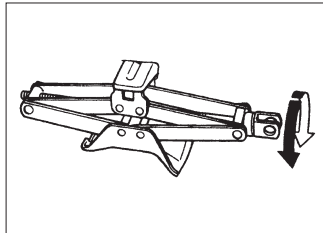

76G-06-024

HIGH MOUNT STOP LAMP

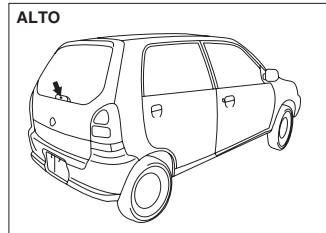

76G-06-025

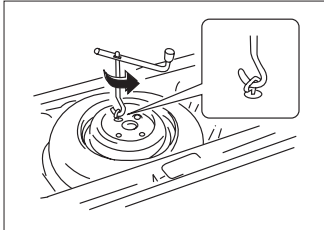

76G-06-023

▲ WARNING

The jack should be used only to change wheels. It is important to read the jacking instructions in the EMERGENCY SERVICE section of this manual before attempting to use the jack.

▲ WARNING

After using the jack crank and wheel wrench, be sure to stow them securely or they can cause injury if an accident occurs.

ALTO K10

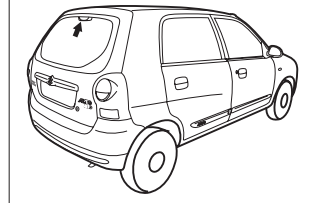

76G-06-025A

High mount stop lamp is provided with your vehicle and is fitted on back door. The stop lamp will glow as when the brake pedal will be depressed.

To change the bulb of the stop lamp, remove the clips at both sides of the cover, by pressing the inner pin inside so that the clip gets loose and remove the bulb on turning it anticlockwise.

There is one bulb in high mount stop lamp.

MEMO

OPERATING YOUR VEHICLE

Exhaust Gas Warning 7-1
Daily Inspection Checklist..... 7-1
Starting the Engine 7-2
Using the Transmission..... 7-3
Braking 7-4
Running-in 7-5
Catalytic Converter 7-5
Improving Fuel Economy 7-6
Trailer Towing 7-7

EXHAUST GAS WARNING

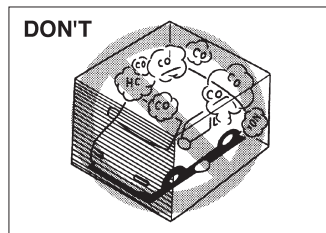

▲ WARNING

Avoid breathing exhaust gases. Exhaust gases contain carbon monoxide, a potentially lethal gas that is colourless and odourless. Since carbon monoxide is difficult to detect by itself, be sure to take the following precautions to help prevent carbon monoxide from entering your vehicle.

- Do not leave the engine running in garages or other confined areas.
- Do not park with the engine running for a long period of time, even in an open area. If it is necessary to sit for a short time in a parked vehicle

▲ WARNING

← with the engine running, make sure the air intake lever is set to "FRESH AIR" and the fan is at high speed.

- Avoid operating the vehicle with the rearend door open. If it is necessary to operate the vehicle with the rearend door open, make sure all the windows are closed and the fan is at high speed with the air intake lever set to "FRESH AIR".
- To allow proper operation of your vehicle's ventilation system, keep the air inlet grille in front of the windshield clear of snow, leaves, or other obstructions at all times.
- Keep the exhaust tailpipe area clear of snow and other material to help reduce the buildup of exhaust gases under the vehicle. This is particularly important when parked in blizzard conditions.
- Have the exhaust system inspected periodically for damage and leaks. Any damage or leaks should be repaired immediately.

DAILY INSPECTION CHECKLIST



Before driving:

- 1) Make sure that windows, mirrors, lights, and reflectors are clean and unobstructed.
- 2) Check the tyres.
- 3) Look for fluid and oil leaks.

NOTE:

It is normal for water to drip from the air conditioning system after use.

- 4) Adjust the seat/head restraint.
- 5) Check the brake pedal and the parking brake lever.
- 6) Adjust the mirrors.
- 7) Make sure that you and passengers have properly fastened your seat belts.
- 8) Make sure that all warning lights come on as the key is turned to the "ON" or "START" position.
- 9) Check all gauges.
- 10) Make sure that the brake fluid level warning light is off when the parking brake is released with the engine running.

STARTING THE ENGINE

Once a week, or each time you fill your fuel tank, perform the following under-bonnet checks:

- 1) Engine oil level.
- 2) Coolant level.
- 3) Brake fluid level.
- 4) Windscreen washer fluid level.
- 5) Battery solution level.
- 6) Bonnet latch operation.

Pull the bonnet release handle inside the vehicle. Make sure that you can not open the hood all the way without releasing the secondary latch. Be sure to close the hood securely after checking for proper operation. See "All Latches, Hinges & Locks" of "PERIODIC MAINTENANCE SCHEDULE" in the "INSPECTION AND MAINTENANCE" section for lubrication schedule.

▲ WARNING

Make sure the bonnet is fully closed and latched before driving. If it is not, it can fly up unexpectedly during driving, obstructing your view and resulting in an accident.

Before starting the engine:

- 1) Make sure the parking brake is applied fully.
- 2) Manual Transmission - Shift into "N" (neutral) and depress the clutch pedal all the way to the floor. Hold it while starting the engine.

▲ WARNING

Make sure that the parking brake is applied fully and the transmission is in Neutral before attempting to start the engine.

CAUTION

- **Stop turning the starter immediately after the engine has started or the starter system can be damaged.**
- **Do not crank the engine for more than 15 seconds at a time. If the engine doesn't start on the first try, wait about 15 seconds before trying again.**

Starting a Cold Engine

Engine which is started after 6 hours should be treated as cold engine.

For Electronic fuel injection models

- With your foot off the accelerator pedal, crank the engine by turning the ignition key to "START". Release the key when the engine starts.
- If the engine does not start after 15 seconds of cranking, wait about 15 seconds, then press down the accelerator pedal to 1/3 of its travel and try cranking the engine again. Release the key and accelerator pedal when the engine starts.
- If the engine still does not start, try holding the accelerator pedal all the way to the floor while cranking. This should clear the engine if it is flooded.

Starting a Warm Engine

For Electronic fuel injection models:

Use the same procedure as for "Starting a Cold Engine".

USING THE TRANSMISSION

MANUAL TRANSMISSION

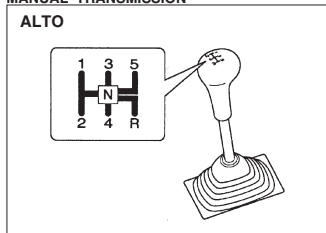

76G-07-003

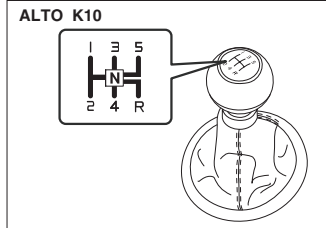

76G-07-003A

Starting off

To start off, depress and maintain pressure upon the clutch pedal and change into 1st gear. After releasing the parking brake,

7-3

gradually release the clutch. When you hear a change in the engine's sound (speed), gently apply pressure to the accelerator to keep the engine sound (speed) constant whilst continuing to gradually release the clutch.

Gear changing

All forward gears are synchronized, which provides for quiet, easy changing. Always depress the clutch pedal fully before changing gears. The following table shows the maximum allowable speed for each gear.

ALTO

GEAR	MAXIMUM SPEED
First	37 km/h
Second	66 km/h
Third	98 km/h
Fourth	Top Speed
Fifth	Top Speed

ALTO K10

GEAR	MAXIMUM SPEED
First	43 km/h
Second	80 km/h
Third	119 km/h
Fourth	Top Speed
Fifth	Top Speed

▲ WARNING

- Reduce your speed and change down to a lower gear before going down a long or steep hill. A lower gear will allow the engine to provide braking. Avoid riding the brakes or they may overheat, resulting in brake failure.
- When driving on slippery roads, be sure to slow down before changing down. Excessive and or sudden changes in engine speed may cause loss of traction, which could cause you to lose control.
- Make sure that the vehicle is completely stationary before you change into reverse.

CAUTION

- To help avoid clutch damage, do not use the clutch pedal as a footrest while driving or use the clutch to keep the vehicle stationary on a hill. Depress the clutch fully when changing gear.
- When changing gears or starting off, do not race the engine. Racing the engine can shorten engine life and prevent smooth operation.

To avoid shock loads on the driveline and consequent driveline breakage, it is strongly recommended not to exceed the following speeds when downshifting:-

ALTO

GEAR	MAXIMUM SPEED
2nd to 1st	9 km/h
3rd to 2nd	33 km/h
4th to 3rd	49 km/h
5th to 4th	Any Speed OK

ALTO K10

GEAR	MAXIMUM SPEED
2nd to 1st	10 km/h
3rd to 2nd	37 km/h
4th to 3rd	55 km/h
5th to 4th	Any Speed OK

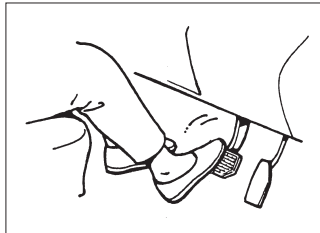
BRAKING

76G-07-004

The distance needed to bring any vehicle to a halt increases with the speed of the vehicle. The braking distance needed, for example, at 60 km/h will be approximately 4 times greater than the braking distance needed at 30 km/h. Start to brake the vehicle when there is plenty of distance between your vehicle and the stopping point, and slow down gradually.

⚠ WARNING

If water gets into the brake drums, brake performance may become poor and unpredictable. After driving through water or washing the underside of the vehicle, test the brakes while driving at a slow speed to see if they have maintained their normal effectiveness. If the brakes are less effective than normal, dry them by repeatedly applying the brakes while driving slowly until the brakes have regained their normal effectiveness.

Servo assisted brakes

Your vehicle has servo assisted brakes which works with the assistance of engine vacuum.

⚠ WARNING

Do not switch off the engine while vehicle is in motion, for example, while driving down a hill as this will cause loss of vacuum assistance leading to reduction of braking efficiency substantially.

If servo assistance is lost due to a stalled engine or other failures, the system is still fully operational on reserve power and you can bring the vehicle to a complete stop by pressing the brake pedal once and holding it down. The reserve power is partly used up each time you depress the brake pedal. Apply smooth and constant pressure to the pedal. Do not pump the pedal.

7-4

▲ WARNING

Even without reserve power in the brake system, you can still stop the vehicle by pressing the brake pedal harder than normally required. However, the stopping distance may be longer.

▲ WARNING

On loose surface where the wheels can easily lose traction (such as gravel, etc.), the stopping distance required for your vehicle may be greater than for a comparable vehicle with a conventional brake system. Allow for extra stopping distance when driving on loose surfaces.

RUNNING-IN**CAUTION**

The future performance and reliability of the engine depends on the care and restraint exercised during its early life. It is especially important to observe the following precautions during the initial 1000 km of vehicle operation.

- After starting, do not race the engine. Warm it up gradually.
- Avoid prolonged vehicle operation at a constant speed. Moving parts will bed in better if you vary your speed.
- Do not exceed 100 km/h.
- Start off from a stop slowly. Avoid full throttle starts.
- If possible, avoid hard braking, especially during the first 300 km of driving.
- Do not drive slowly with the transmission in a high gear.
- Drive the vehicle at moderate engine speeds.

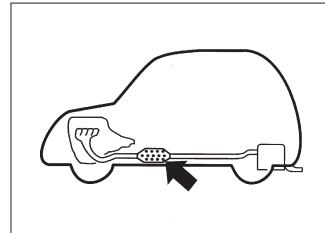
CATALYTIC CONVERTER

76G-07-005

The purpose of the catalytic converter installed on your vehicle is to convert exhaust pollutants to harmless water vapour, carbon dioxide, and nitrogen. Use of leaded fuel in vehicles equipped with catalytic converters is prohibited, because lead deactivates the pollutant-reducing components of the catalyst system.

It is very important to keep the engine properly tuned. Engine misfiring, which can result from an improperly tuned engine, may cause overheating of the catalyst. This may result in permanent heat damage to the catalyst and other vehicle components.

CAUTION

To minimize the possibility of catalyst or other vehicle damage:

- Maintain the engine in the proper operating condition.
- In the event of an engine malfunction, particularly one involving engine misfire or other apparent loss of performance, have the vehicle serviced promptly.
- Do not turn off the engine or interrupt the ignition when the transmission is in gear and the vehicle is in motion.
- Do not try to start the engine by pushing or towing the vehicle, or coasting down a hill.
- Do not idle the engine with any spark plug wires disconnected or removed, such as during diagnostic testing.
- Do not idle the vehicle for prolonged periods if idling seems rough or there are other malfunctions.
- Do not allow the fuel tank to get near the empty level.

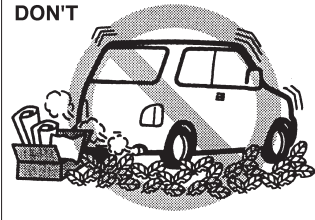
DON'T

76G-07-006

▲ WARNING

Be careful where you park and drive; the catalytic converter and other exhaust components can get very hot. As with any vehicle, do not park or operate this vehicle in areas where combustible materials such as dry grass or leaves can come in contact with a hot exhaust system.

IMPROVING FUEL ECONOMY

The following instructions will help you improve fuel economy.

Avoid excessive idling:

If you are to wait for more than a minute while you are parked, stop the engine and start it again later. When warming up a cold engine, allow the engine to idle for some time.

Avoid "fast" starts:

Fast starts away from lights or stop signs will consume fuel unnecessarily and shorten engine life. Start off slowly.

Avoid unnecessary stops:

Avoid unnecessary deceleration and stopping. Try to maintain a slow, steady speed whenever possible. Slowing down and then accelerating again uses more fuel.

Keep a steady cruising speed:

Keep as constant a speed as road and traffic conditions will permit.

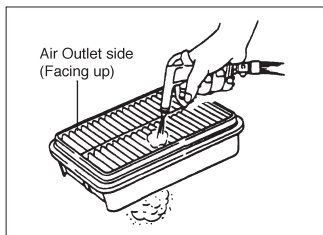
TRAILER TOWING

76G-07-007

Your MARUTI SUZUKI is designed to carry people and a normal amount of cargo, not to tow a trailer. Maruti does not recommend you use your vehicle to tow a trailer. Towing a trailer can adversely affect handling, durability, and fuel economy.

Keep the air cleaner clean:

A dirty air cleaner will cause the fuel system to supply too much fuel to the engine for the amount of air being supplied. The result is waste of fuel due to incomplete combustion.

Keep weight to a minimum:

The heavier the load, the more fuel the vehicle consumes. Take out any luggage or cargo when it is not necessary.

Keep tyre pressures correct:

Under-inflation of the tyres can waste fuel due to increased running resistance of the tyres. Keep your tyres inflated to the correct pressure shown on the label on the driver's side door or door lock pillar.

DRIVING TIPS AND SAFE DRIVING

High Speed Driving	8-1
Driving on Hills	8-1
Driving on Slippery Roads	8-1
Driving on Wet Roads	8-2
Do's and Don'ts for Safe Driving	8-3

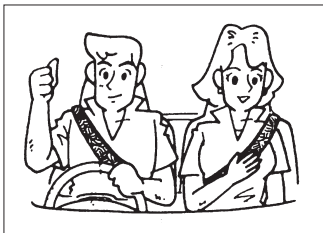

76G-08-001

⚠ WARNING

- **Wear Your Seat Belts at All Times.** The driver and passengers should be properly restrained at all times, using the seatbelts provided. Refer to the "SEATBELTS" section for instructions on proper use of the seat belts.
- **Never drive while under the influence of alcohol or other drugs.** Alcohol and drugs can seriously impair your ability to drive safely, greatly increasing the risk of injury to yourself and others. You should also avoid driving when you are tired, sick, irritated, or under stress.

HIGH-SPEED DRIVING

When driving at a high-speed, pay attention to the following:

- Stopping distance progressively increases with vehicle speed. Apply the brakes far enough ahead of the stopping point to allow for the extra stopping distance.
- On rainy days, "Aquaplaning" can occur. "Aquaplaning" is the loss of direct contact between the road surface and the vehicle's tyres due to a water film forming between them. Steering or braking the vehicle while "Aquaplaning" can be very difficult, and loss of control can occur. Keep speed down when the road surface is wet.
- At high speeds, the vehicle may be affected by side winds. Therefore, reduce speed and be prepared for unexpected buffeting, which can occur at the exits of tunnels, when passing by a cut of a hill, or when being overtaken by large vehicles, etc.

DRIVING ON HILLS

- When climbing steep hills, the vehicle may begin to slow down and show a lack of power. If this happens, you should change to a lower gear so that the engine will again be operating in its normal power range. Change rapidly to prevent the vehicle from losing momentum.

- When driving down a hill, the engine should be used for braking by shifting to next lower gear.

⚠ WARNING

Try not to hold the brake pedal down too long or too often while going down a steep or long hill. This could cause the brakes to overheat, resulting in reduced braking efficiency. Failure to take this precaution could result in loss of vehicle control.

CAUTION

When descending a down hill, NEVER turn the ignition key to the "OFF" position. Emission control system damage may result.

DRIVING ON SLIPPERY ROADS

Under wet road conditions you should drive at a lower speed than on dry roads due to possible slippage of tyres during braking. When driving on icy, snowcovered, or muddy roads, reduce your speed and avoid sudden acceleration, abrupt braking, or sharp steering movements.

Snow Chains

If you must use snow chains to increase tyre traction, observe the following precautions:

- Use cable type chains.
- Choose a safe place away from traffic to install the chains.
- When installing the chains carefully follow the manufacturer's instructions.
- Install the chains on the front tyres.
- With the chains on, drive only at slow and moderate speeds.
- If the chain hits the vehicle body while driving, stop at a safe place and retighten it as soon as possible.
- If snow and/or ice on the road disappear, remove the chains as soon as possible.

If Your Vehicle Gets Stuck

If your vehicle gets stuck in snow, mud, or sand, follow the directions below:

- 1) Change back and forth between a forward range (or first gear for manual transmission) and reverse. This will create a rocking motion which may give you enough momentum to free the vehicle. Press gently on the accelerator to keep wheel spin to a minimum. Remove your foot from the accelerator while changing gear.
Do not race the engine. Excessive wheel spin will cause the tyres to dig deeper, making it more difficult to free the vehicle.

- 2) If your vehicle remains stuck after a few minutes of rocking, get another vehicle to pull you out.

⚠ WARNING

Do not allow anyone to stand near the vehicle when you are rocking it, and do not spin the wheels faster than an indicated 40 km/h on the speedometer. Personal injury and/or vehicle damage may result from spinning the wheels too fast.

CAUTION

Do not continue rocking the vehicle for more than a few minutes. Prolonged rocking can cause engine overheating or transmission damage.

DRIVING ON WET ROADS**CAUTION**

- When driving on wet roads, avoid driving through large amount of standing water on the road. Large amount of water entering the engine compartment may cause damage to the engine and or electrical components.
- If stuck in deep water, do not start till water level drops.
- Water is incompressible substance, water inside engine is harmful to the engine.

⚠ WARNING

- Make sure your tyres are in good condition and always maintain the specified tyre pressure. Refer to "TYRES" in the "INSPECTION AND MAINTENANCE" section for details.
- Do not use tyres other than those specified by MARUTI SUZUKI. Never use different sizes or types of tyres on the front and rear wheels. For information regarding the specified tyres, refer to the "SPECIFICATIONS" section.
- Never use oversized tyres or special shock absorbers and springs to raise (jack up) your vehicle. This will change the handling characteristics.
- After driving through water, test the brakes while driving at a slow speed to see if they have maintained their normal effectiveness. If the brakes are less effective than normal, dry them by repeatedly applying the brakes while driving slowly until the brakes have regained their normal effectiveness.

DO'S AND DON'TS FOR SAFE DRIVING

Exercise care in handling your vehicle. Be conscious of not only your own safety but also the safety of others on the road, and thus enjoy the best and most comfortable driving experience.

This section contains basic rules for safe driving. Read it carefully for good understanding of the content so that you can enjoy safe and pleasant driving in your Maruti Suzuki vehicle.

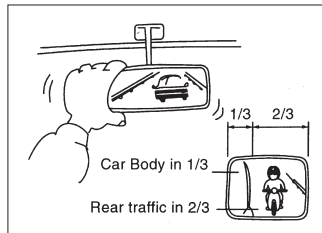

76G-08-002

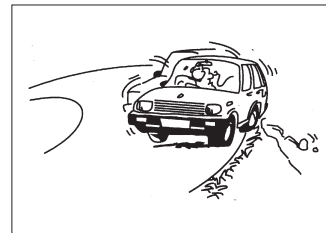

76G-08-003

Starting

1. Adjust the driver's seat for the proper driving posture.
2. Adjust the rear view mirror so as to obtain the best possible rear view.
3. Before moving off, look forward and back to confirm safety.
4. Don't start quickly, for it is dangerous and wastes fuel.

General driving

1. Be sure to stop before the stop light and stop sign. When moving into the intersection without any traffic lights or signs, drive slowly to confirm safety.

2. Always follow other vehicles at a safe distance in order to prevent a rear-end collision, should the vehicle ahead make a sudden stop.
3. Turn ON the turn signal at least 30 meters before making a turn or changing the lane so as not to be hit from behind.
4. Before entering a corner, decelerate to a safe speed. Don't apply brakes during cornering, or a cornering skid may occur.
5. When overtaking other vehicles, watch out for the oncoming vehicle and carefully confirm the safety.
6. Don't attempt zigzag driving which will hinder your control over the vehicle and cause an accident.

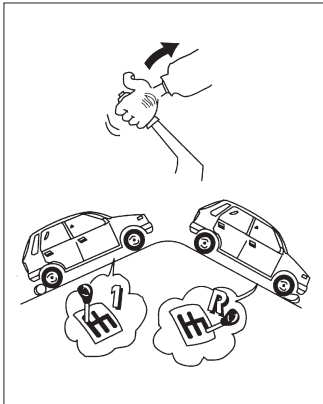

76G-08-004

Braking

1. Use the parking brake when parking your vehicle and shift the gear shift lever into the first gear or reverse gear position for the sake of safety.
2. Don't use handbraking unless unavoidable. It causes the vehicle to skid and a rear-end collision occur. It is



76G-08-005

- especially dangerous when the tyres are worn, for they allow a larger skid. Use foot brake in three stages
- (1) Warn the vehicle behind you
 - (2) Gradually apply the brake.
 - (3) Bring the vehicle to a halt.
3. When driving on a downhill, try not to apply the brake but use the engine brake effectively. Overuse of the footbrake may result in total brake failure.
 4. Avoid reckless high speed driving and try to drive at a safe speed suitable for the road conditions while maintaining a constant speed.

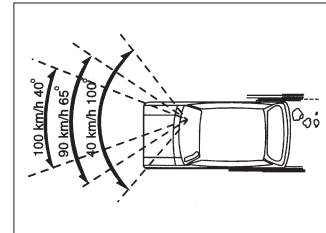

76G-08-006

5. The higher the speed, the narrower the driver's visual range becomes. In such a state, it is difficult to anticipate any hazard and the driver feels much fatigued.
6. Never do sharp handling during high speed driving. You will lose your control over your vehicle.
7. When overtaking or changing the lane while driving at a high speed, keep an ample vehicle-to-vehicle distance.

Long distance driving

1. Be sure to perform safety checks before starting a trip.
2. Take rest at certain intervals to prevent an accident which may occur when you are sleepy or tired.



76G-08-007

Night time driving

1. Drive more slowly at night than in the daytime, for the visual range is restricted at night.
2. Don't overtake other vehicles at night. Darkness bothers your sense of speed and hinders your judgement on the vehicle-to-vehicle distance.
3. Don't use the high headlight beam unless its use is inevitable. Its dazzle may blitz the driver of the oncoming vehicle, thus causing an accident.
4. Always keep the window glasses clean. Don't operate the windshield wiper when the windshield glass is dry or the wiper blade and glass may get damaged.

8-5

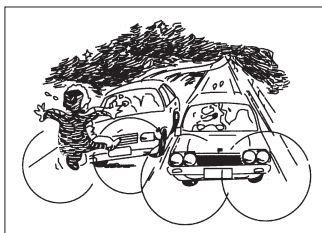

76G-08-008

MARGIN FOR SAFETY

It is important to allow yourself a margin for safety during driving so that you can cope with erroneous or unexpected driving of other drivers. For that, observe the following.

- Drive at a safe speed.
- Maintain a sufficient distance between your vehicle and the vehicle ahead.
- Don't force yourself to overtake other vehicles.
- Don't make quick start, hard steering or sudden stops.
- Allow an ample time in the driving schedule.
- Observe traffic rules and regulations.

CONCLUSION

A perfect driver does not exist. The endeavour of every motorist should be to strive for perfection. Safety consciousness not only ensures your safety and the safety of other road users, it also helps reduce the wear and tear on your vehicle, prolongs its life, gives more mileage and ensures a comfortable driving experience.

Follow the do's and don'ts listed, and driving will never be the same again.

82

INSPECTION AND MAINTENANCE

Periodic Maintenance Schedule	9-1
Alto	9-2
Alto K-10	9-6
Drive Belt	9-10
Engine Oil and Filter	9-11
Gear Oil	9-14
Engine Coolant	9-15
Windscreen Washer Fluid	9-18
Air Cleaner	9-18
Spark Plugs	9-19
Fuel Filter Replacement	9-21
Brakes	9-21
Parking Brake	9-23
Steering	9-23
Clutch Pedal	9-24
Tyres	9-24
Tubeless Tyre (if equipped)	9-27
Battery	9-28
Fuses	9-29
Bulb Replacement	9-32
Wiper Blades	9-35

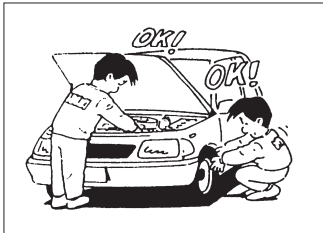

76G-09-001

⚠ WARNING

You should take extreme care when working on your vehicle to prevent accidental injury. Here are a few precautions that you should be especially careful to observe:

- Do not leave the engine running in garages or other confined areas.
- When the engine is running, keep hands, clothing, tools, and other objects away from the fan and water pump belt. Even though the fan may not be moving, it can automatically turn on without warning.

⚠ WARNING

- When it is necessary to do service work with the engine running, make sure that the parking brake is applied fully and the transmission is in Neutral.
- Do not touch ignition wires or other ignition system parts when starting the engine or when the engine is running, or you could receive an electric shock.
- Be careful not to touch a hot engine, exhaust manifold and pipes, muffler, radiator and water hoses.
- Do not allow smoking, sparks, or flames around gasoline or the battery. Flammable fumes are present.
- Do not get under your vehicle if it is supported only with the portable jack provided in your vehicle.
- Be careful not to cause accidental short circuits between the positive and negative battery terminals.
- Keep used oil, coolant, and other fluids away from children and pets. Dispose of used fluids properly; never pour them on the ground, into sewers, etc.

PERIODIC MAINTENANCE SCHEDULE

The following table shows when regular maintenance on your vehicle is required. This table shows in kilometres and months when inspections, adjustments, lubrication and other services should be performed.

⚠ WARNING

MARUTI SUZUKI recommends that maintenance on your MARUTI SUZUKI vehicle be performed by MARUTI SUZUKI Authorised Dealer/Service Station.

CAUTION

Whenever it becomes necessary to replace parts on your vehicle, it is recommended that you use MARUTI GENUINE PARTS (MGP).

ALTO

A....Adjust. I....Inspect and correct or replace if necessary.
 T....Tighten to specified torque. C....Clean.
 R....Replace or change. O....Rotate
 L....Lubricate.

Note:

This table includes services as scheduled up to 80,000 km mileage. Beyond 80,000 km, carry out the same services at the same intervals respectively.

Interval: This interval should be judged by odometer reading or months, whichever comes first.	km (x 1,000) months	FREE INSPECTIONS			PERIODIC MAINTENANCE SERVICE AT COST							
		1	5	10	20	30	40	50	60	70	80	
		1	6	12	24	36	48	60	72	84	96	
ENGINE												
1. Water pump drive belt (tension, wear)		A	I	I	I	I	I	I	R	A	I	
2. Engine coolant (level, leakage)		I	I	I	R	I	R	I	R	I	R	
3. Engine oil (API GRADE SF, SG, SH) & Oil filter		R	I	R	R	R	R	R	R	R	R	
4. Cooling system hoses and connections (leakage, damage)		I	I	I	I	I	I	I	I	I	I	
5. Engine bolts (All cylinder head and manifold fixings)		-	-	T	-	T	-	T	-	T	-	
6. Engine mounting (loose, damage)		-	-	T	-	T	-	T	-	T	-	
7. Valve clearance		-	A	-	A	-	A	-	A	-	A	
8. Camshaft timing belt (damage, wear)		-	-	-	I	-	I	-	I	-	I	
		Replace every 1,00,000 km										
9. Exhaust system (noise, leakage or otherwise defective)		-	I	-	I	-	I	-	I	-	I	
10. Positive crankcase ventilation System (Hoses, connections and valve)		-	I	-	I	-	I	-	I	-	I	
IGNITION												
1. Ignition wiring, (damage, deterioration)		-	-	-	I	-	I	-	I	-	I	
2. Spark plugs (clean and adjust the gap)		-	-	I	R	I	R	I	R	I	R	
3. Distributor cap and rotor (wear and deterioration)*		-	-	-	I	-	I	-	I	-	I	

*For LX only

INSPECTION AND MAINTENANCE

76G-74E

Interval: This interval should be judged by odometer reading or months, whichever comes first.		km (x 1,000) months	FREE INSPECTIONS			PERIODIC MAINTENANCE SERVICE AT COST						
			1	5	10	20	30	40	50	60	70	80
			1	6	12	24	36	48	60	72	84	96
FUEL												
1.	Air cleaner	Paved-road	Clean every 5,000 km. Replace every 40,000 km.									
		Dusty condition	Clean every 2,500 km or as required. Replace every 40,000 km. More frequent replacement if dust condition is severe.									
2.	Accelerator cable and Throttle shafts	-	I&L	I&L	I&L	I&L	I&L	I&L	I&L	I&L	I&L	
3.	Fuel tank cap, fuel lines & connections(leakage,damage)	-	I	-	-	-	I	-	-	-	I	
4.	Fuel filter (leakage)	I	I	I	I	I	R	I	I	I	R	
CLUTCH AND TRANSMISSION												
1.	Clutch pedal (play)	I	I	I	I	I	I	I	I	I	I	
2.	Clutch slipping (dragging or excessive damage)	I	I	I	I	I	I	I	I	I	I	
3.	Manual Transmission/Transfer and Differential oil (level, leakage)	I	I	I	R	I	R	I	R	I	R	
DRIVE SHAFTS												
1.	Drive shafts boots (bent of boots damage)	-	I	I	I	I	I	I	I	I	I	
BRAKE												
1.	Brake fluid (level, leakage)	I	I	I	R	I	R	I	R	I	R	
2.	Brake pedal (pedal-to-wall clearance)	I	I	I	I	I	I	I	I	I	I	
3.	Parking brake lever and cable (play, damage)	I	I	I	I	I	I	I	I	I	I	
4.	a. Brake discs and pads, (wear)	-	I	I	I	I	I	I	I	I	I	
	b. Brake drums & shoes	-	-	I	I	I	I	I	I	I	I	
5.	Master cylinder and wheel cylinder or calliper (oil leakage, boot kit)	I	I	I	I	I	R	I	I	I	R	
6.	Brake hoses and pipes (leakage, damage)	I	I	I	I	I	I	I	I	I	I	

Interval: This interval should be judged by odometer reading or months, whichever comes first.	km (x 1,000) months	FREE INSPECTIONS			PERIODIC MAINTENANCE SERVICE AT COST							
		1	5	10	20	30	40	50	60	70	80	
		1	6	12	24	36	48	60	72	84	96	
WHEEL												
1. Tyres (air pressure, abnormal wear, crack, rotation)		I	I&O	I&O	I&O	I&O	I&O	I&O	I&O	I&O	I&O	
2. Wheels (damage)		I	I	I	I	I	I	I	I	I	I	
3. Front wheel bearings (loose, damage)		-	I	I	I	I	I	I	I	I	I	
4. Rear wheel bearings (loose, damage)		-	I	I	I	I	I	I	I	I	I	
FRONT AND REAR SUSPENSION												
1. Suspension strut (oil leakage, damage)		I	I	I	I	I	I	I	I	I	I	
2. Suspension arms and knuckle supports (loose, damage)		-	I	I	I	I	I	I	I	I	I	
3. Rear spring (damage)		-	I	I	I	I	I	I	I	I	I	
4. Shock absorbers (oil leakage, damage)		I	I	I	I	I	I	I	I	I	I	
5. All bolts and nuts (loose)		-	T	T	T	T	T	T	T	T	T	
6. Suspension arms and Tension rods		-	I	I	I	I	I	I	I	I	I	
STEERING												
1. Steering wheel (play, loose)		I	I	I	I	I	I	I	I	I	I	
2. All rods and arms (loose, damage, wear)		I	I	I	I	I	I	I	I	I	I	
ELECTRICAL												
1. Battery electrolyte (level, leakage)		I	I	I	I	I	I	I	I	I	I	
2. Wiring harness connection (looseness, damage)		-	I	I	I	I	I	I	I	I	I	
3. Lighting system (operation, stains, damage)		I	I	I	I	I	I	I	I	I	I	
4. Horn (operation)		I	I	I	I	I	I	I	I	I	I	
5. System voltage		-	I	I	I	I	I	I	I	I	I	
BODY												
1. All chassis bolts and nuts (tighten)		-	I	T	T	T	T	T	T	T	T	
2. All Latches, Hinges & Locks (function)		I	I&L	I&L	I&L	I&L	I&L	I&L	I&L	I&L	I&L	

INSPECTION AND MAINTENANCE

76G-74E

Interval: This interval should be judged by odometer reading or months, whichever comes first.	km (x 1,000) months	FREE INSPECTIONS			PERIODIC MAINTENANCE SERVICE AT COST							
		1	5	10	20	30	40	50	60	70	80	
		1	6	12	24	36	48	60	72	84	96	
ROAD TEST												
1.	Operation of Brakes, Gear shifting & speedometer	I	I	I	I	I	I	I	I	I	I	
2.	Body and Chassis noise	I	I	I	I	I	I	I	I	I	I	
AIR CONDITIONER (if equipped)												
1.	Check belt tension	I	I	I	I	I	I	I	I	I	I	
2.	Tighten compressor mounting bolts	-	T	T	T	T	T	T	T	T	T	
3.	Check all hose joints, tighten if necessary	I	I	I	I	I	I	I	I	I	I	
4.	Check functioning of Recirc flap	I	I	I	I	I	I	I	I	I	I	
5.	Clean condenser with low pressure water	-	C	C	C	C	C	C	C	C	C	
6.	Check belt for frayed edges, change if necessary	-	I	I	I	I	I	I	I	I	I	
7.	Check all mounting bolts	-	I	I	I	I	I	I	I	I	I	

ALTO K10

A...Adjust. I...Inspect and correct or replace if necessary.
 T...Tighten to specified torque. C...Clean.
 R...Replace or change. O...Rotate
 L...Lubricate.

Note:

This table includes services as scheduled up to 80,000 km mileage. Beyond 80,000 km, carry out the same services at the same intervals respectively.

Interval: This interval should be judged by odometer reading or months, whichever comes first.	km (x 1,000) months	FREE INSPECTIONS			PERIODIC MAINTENANCE SERVICE AT COST						
		1	5	10	20	30	40	50	60	70	80
		1	6	12	24	36	48	60	72	84	96
ENGINE											
1. Water pump drive belt (tension, wear)		-	-	-	-	-	I	-	-	-	R
2. Engine coolant (level, leakage)		I	I	I	R	I	R	I	R	I	R
3. Engine oil (API GRADE SG+, SJ & SL) & Oil filter		-	-	R	R	R	R	R	R	R	R
4. Cooling system hoses and connections (leakage, damage)		I	I	I	I	I	I	I	I	I	I
5. Engine bolts (All cylinder head and manifold fixings)		-	-	T	-	T	-	T	-	T	-
6. Engine mounting (loose, damage)		-	-	T	-	T	-	T	-	T	-
7. Valve clearance		-	-	-	-	I	-	-	I	-	-
8. Exhaust system (noise, leakage or otherwise defective)		-	I	-	I	-	I	-	I	-	I
9. Positive crankcase ventilation System (Hoses, connections and valve)		-	I	-	I	-	I	-	I	-	I
IGNITION											
1. Ignition wiring, (damage, deterioration)		-	-	-	I	-	I	-	I	-	I
2. Spark plugs (clean and adjust the gap)		-	-	-	-	-	R	-	-	-	R

INSPECTION AND MAINTENANCE

76G-74E

Interval: This interval should be judged by odometer reading or months, whichever comes first.		km (x 1,000) months	FREE INSPECTIONS			PERIODIC MAINTENANCE SERVICE AT COST						
			1	5	10	20	30	40	50	60	70	80
			1	6	12	24	36	48	60	72	84	96
FUEL												
1.	Air cleaner	Paved-road	Clean every 5,000 km. Replace every 40,000 km.									
		Dusty condition	Clean every 2,500 km or as required. Replace every 40,000 km. More frequent replacement if dust condition is severe.									
2.	Accelerator cable and Throttle shafts		-	I&L	I&L	I&L	I&L	I&L	I&L	I&L	I&L	
3.	Fuel tank cap, fuel lines & connections (leakage,damage)		-	I	-	-	-	I	-	-	I	
4.	Fuel filter (leakage)		I	I	I	I	I	R	I	I	R	
CLUTCH AND TRANSMISSION												
1.	Clutch pedal (play)		I	I	I	I	I	I	I	I	I	
2.	Clutch slipping (dragging or excessive damage)		I	I	I	I	I	I	I	I	I	
3.	Manual Transmission/Transfer and Differential oil (level, leakage)		I	I	I	R	I	R	I	R	R	
DRIVE SHAFTS												
1.	Drive shafts boots (boot cut / damage)		I	I	I	I	I	I	I	I	I	
2.	Noise from drive shafts		I	I	I	I	I	I	I	I	I	
BRAKE												
1.	Brake fluid (level, leakage)		I	I	I	R	I	R	I	R	R	
2.	Brake pedal (pedal-to-wall clearance)		I	I	I	I	I	I	I	I	I	
3.	Parking brake lever and cable (play, damage)		I	I	I	I	I	I	I	I	I	
4.	a. Brake discs and pads, (wear)		-	I	I	I	I	I	I	I	I	
	b. Brake drums & shoes		-	-	I	I	I	I	I	I	I	
5.	Master cylinder and wheel cylinder or calliper boot kit (oil leakage)		I	I	I	I	I	R	I	I	R	
6.	Brake hoses and pipes (leakage, damage)		I	I	I	I	I	I	I	I	I	

Interval: This interval should be judged by odometer reading or months, whichever comes first.		km (x 1,000) months		FREE INSPECTIONS			PERIODIC MAINTENANCE SERVICE AT COST						
				1	5	10	20	30	40	50	60	70	80
				1	6	12	24	36	48	60	72	84	96
WHEEL													
1.	Tyres (air pressure, abnormal wear, crack, rotation)	I	I&O	I&O	I&O	I&O	I&O	I&O	I&O	I&O	I&O		
2.	Wheels (damage)	I	I	I	I	I	I	I	I	I	I		
3.	Front wheel bearings (loose, damage, noise)	-	I	I	I	I	I	I	I	I	I		
4.	Rear wheel bearings (loose, damage, noise)	-	I	I	I	I	I	I	I	I	I		
FRONT AND REAR SUSPENSION													
1.	Suspension strut (oil leakage, damage, noise)	I	I	I	I	I	I	I	I	I	I		
2.	Suspension arms and knuckle supports (loose, damage)	-	I	I	I	I	I	I	I	I	I		
3.	Rear spring (damage, noise)	-	I	I	I	I	I	I	I	I	I		
4.	Shock absorbers (oil leakage, damage, noise)	I	I	I	I	I	I	I	I	I	I		
5.	All bolts and nuts (loose)	-	T	T	T	T	T	T	T	T	T		
6.	Suspension arms and Tension rods	-	I	I	I	I	I	I	I	I	I		
STEERING													
1.	Steering wheel (play, loose)	I	I	I	I	I	I	I	I	I	I		
2.	All rods and arms (loose, damage, wear)	I	I	I	I	I	I	I	I	I	I		
ELECTRICAL													
1.	Battery electrolyte (level, leakage)	I	I	I	I	I	I	I	I	I	I		
2.	Wiring harness connection (looseness, damage)	-	I	I	I	I	I	I	I	I	I		
3.	Lighting system (operation, stains, damage)	I	I	I	I	I	I	I	I	I	I		
4.	Horn (operation)	I	I	I	I	I	I	I	I	I	I		
5.	System voltage	-	I	I	I	I	I	I	I	I	I		

INSPECTION AND MAINTENANCE

76G-74E

Interval: This interval should be judged by odometer reading or months, whichever comes first.	km (x 1,000) months	FREE INSPECTIONS			PERIODIC MAINTENANCE SERVICE AT COST						
		1	5	10	20	30	40	50	60	70	80
		1	6	12	24	36	48	60	72	84	96
BODY											
1.	All chassis bolts and nuts (tighten)	–	I	T	T	T	T	T	T	T	T
2.	All Latches, Hinges & Locks (function)	I	I&L	I&L	I&L	I&L	I&L	I&L	I&L	I&L	I&L
ROAD TEST											
1.	Operation of Brakes, Gear shifting & speedometer	I	I	I	I	I	I	I	I	I	I
2.	Body and Chassis noise	I	I	I	I	I	I	I	I	I	I
AIR CONDITIONER (if equipped)											
1.	Check belt tension	I	I	I	I	I	I	I	I	I	I
2.	Tighten compressor mounting bolts	–	T	T	T	T	T	T	T	T	T
3.	Check all hose joints, tighten if necessary	I	I	I	I	I	I	I	I	I	I
4.	Check functioning of Recirc flap	I	I	I	I	I	I	I	I	I	I
5.	Clean condenser with low pressure water	–	C	C	C	C	C	C	C	C	C
6.	Check belt for frayed edges, change if necessary	–	I	I	I	I	I	I	I	I	I
7.	Check all mounting bolts	–	I	I	I	I	I	I	I	I	I

▲ WARNING
 The rear shock absorbers are filled with high pressure gas. Never attempt to disassemble it or throw it into a fire. Avoid storing it near a heater or heating device. When scrapping the absorber, the gas must be released from the absorber safely. Ask your dealer for assistance.

▲ WARNING
 • All maintenance should be carried out with the ignition switch in the "OFF" position and the car parked securely on the level ground unless otherwise specified.
 • If you are in any way unsure of your ability to undertake a task, then do not start it but contact your MARUTI SUZUKI dealer to perform the work for you.

DRIVE BELT

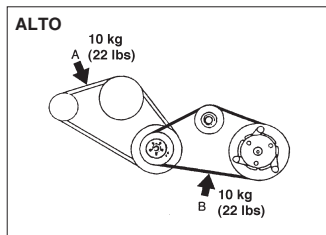

76G-09-002

Water pump belt (A)	8 - 9 mm
Air conditioner belt (B)	8 - 9 mm

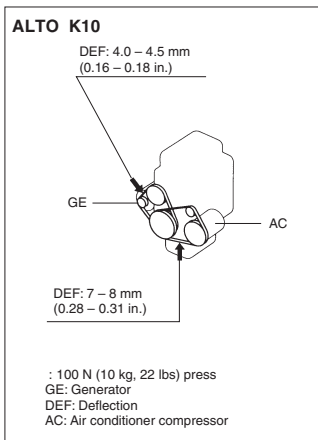

: 100 N (10 kg, 22 lbs) press
 GE: Generator
 DEF: Deflection
 AC: Air conditioner compressor

⚠ WARNING

When the engine is running, keep hands, hair, clothing, tools, etc. away from the fan and drive belt. Even though the fan may not be moving, it can automatically turn on without warning.

Make sure the drive belt tension is correct. If the belt is too loose, insufficient battery charging, engine overheating, or excessive belt wear can result. When you press the belt with your thumb midway between the pulleys, the belt deflection should be within the specification below.

The belt should also be examined to ensure that it is not damaged. If the belt needs to be replaced or adjusted, have it done by your MARUTI SUZUKI dealer.

ENGINE OIL AND FILTER

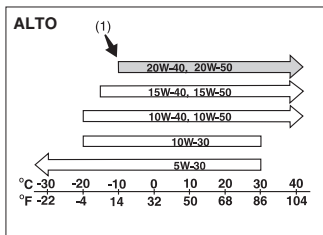
**Specified oil**

Be sure that the engine oil you use comes under the API classification of SF, SG or SH. The recommended engine oil is SF 20W40 (1). Select the appropriate oil viscosity according to the above chart.

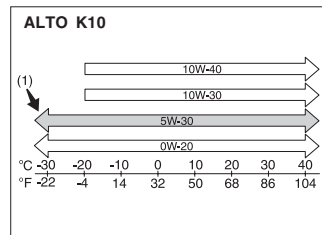

(1) Preferred

Be sure that the engine oil you use comes under the quality classification of SG+, SL & SJ. Select the appropriate oil viscosity according to the above chart.

SAE 5W30 (1) is the best choice for good fuel economy, and good starting in cold weather.

CAUTION

Failure to check the oil level regularly could lead to serious engine trouble due to insufficient oil.

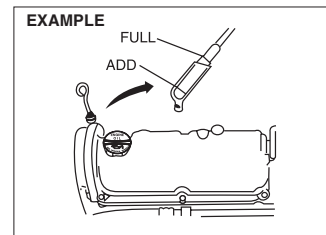
**Oil Level Check**

It is important to keep the engine oil at the correct level for proper lubrication of your vehicle's engine. Check the oil level with the vehicle on a level surface. The oil level indication may be inaccurate if the vehicle is on a slope. The oil level should be checked either before starting the engine or at least 5 minutes after stopping the engine.

Pull out the oil dipstick, wipe oil off with a clean cloth, insert the dipstick all the way into the engine, then remove it again. The oil on the stick should be between the upper and lower limits shown on the stick. If the oil level indication is near the lower limit, add enough oil to raise the level to the upper limit.

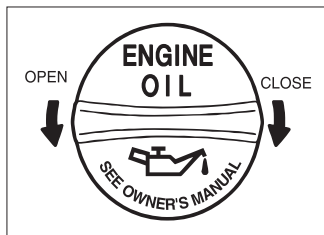

76G-09-005

Refilling

Remove the oil filler cap and pour oil slowly through the filler hole to bring the oil level to the upper limit on the dipstick. Be careful not to overfill. Too much oil is almost as bad as too little oil. After refilling, start the engine and allow it to idle for about a minute. Stop the engine, wait for five minutes and check the oil level again.

Changing Engine Oil and Filter

Drain the engine oil while the engine is still warm.

- 1) Remove the oil filler cap.
- 2) Place a drain pan under the drain plug.
- 3) Using the correct spanner remove the drain plug and drain out the engine oil.

95

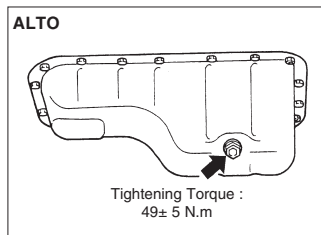

76G-09-006

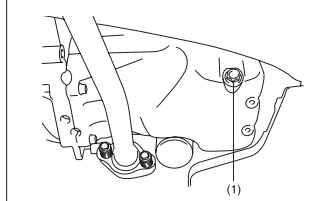
ALTO K10

Tightening torque for drain plug (1):
35 Nm (3.5 kg-m, 25.5 lb-ft)

⚠ WARNING

The engine oil temperature may be high enough to burn your fingers when the drain plug is loosened. Wait until the drain plug is cool enough to touch with your bare hands.

⚠ WARNING

New and used oil can be hazardous. Children and pets may be harmed by swallowing new or used oil. Keep new and used oil and used oil filters away from children and pets. Continuous contact with used engine oil may cause (skin) cancer. Brief contact with used oil may irritate skin.

To minimize your exposure to used oil, wear a long-sleeve shirt and moistureproof gloves (such as dishwashing gloves) when changing oil. If oil contacts your skin, wash thoroughly with soap and water. Launder any clothing or rags if wet with oil.

Recycle or properly dispose of used oil and filters.

4. Reinstall the drain plug and new gasket. Tighten the plug with a wrench to the specified torque.

9-12

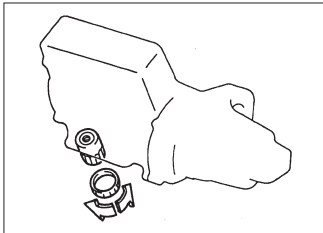

76G-09-007

Replace the oil filter

- 1) Using an oil filter wrench, turn the oil filter counterclockwise and remove it.
- 2) Using a clean rag, wipe off the mounting surface on the engine where the new filter will be seated.
- 3) Smear a little engine oil around the rubber gasket of the new oil filter.
- 4) Screw on the new filter by hand until the filter gasket contacts the mounting surface.

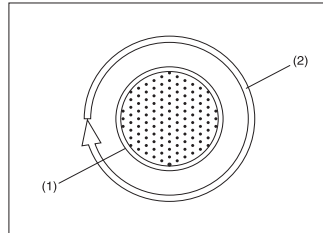

76G-09-008

- (1) Oil filter
- (2) 1 Turn

CAUTION

To tighten the oil filter properly, it is important to accurately identify the position at which the filter gasket first contacts the mounting surface.

5. Tighten the filter specified turn from the point of contact with the mounting surface (or to the specified torque) using an oil filter wrench.

Tightening torque for oil filter
1 turn or
14 Nm (1.4 kg-m, 10.5 lb-ft)

CAUTION

To prevent oil leakage, make sure that the oil filter is tight, but do not overtighten it.

Refill with oil and check for leaks.

- 1) Pour oil through the filler hole and install the filler cap.
 For the approximate capacity of the oil, refer to the "CAPACITIES" item in the "SPECIFICATIONS" section.
- 2) Start the engine and look carefully for leaks at the oil filter and drain plug. Run the engine at various speeds for at least 5 minutes.
- 3) Stop the engine and wait for 5 minutes. Check the oil level again and add oil if necessary. Check for leaks again.

CAUTION

When replacing the oil filter, it is recommended that you use a genuine MARUTI replacement filter.

CAUTION

Oil leaks from around the oil filter or drain plug indicate incorrect installation or gasket damage. If you find any leaks or are not sure that the filter has been properly tightened, have the vehicle inspected by your MARUTI SUZUKI dealer.

GEAR OIL

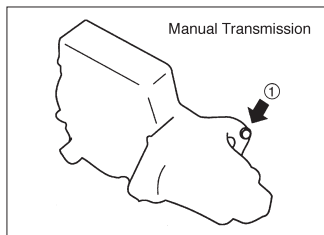

Oil filler and level plug ①
Tightening torque: 21 Nm (2.1 kg-m, 15.5 lb-ft)

Specified Manual Transmission oil
When adding gear oil, use the appropriate viscosity and grade as shown in the chart below. We highly recommend you use API GL-4 SAE 75W-90 (1) gear oil.

Type of oil	Gear oil, API GL-4
-------------	--------------------

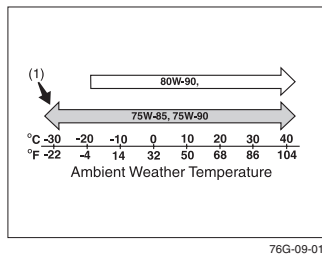
**Gear oil level check**

To check the gear oil level, use the following procedure:

- 1) Park the vehicle on a level surface with the parking brake applied. Then, stop the engine.
- 2) Clean casing around oil filler plug to remove risk of any loose dirt or debris entering oil filler plug hole. Remove the oil filler plug ①.
- 3) Feel the inside of the hole with your finger. If the oil level comes up to the bottom of the plug hole, the oil level is correct. If so, reinstall the plug.
- 4) If the oil level is low, add gear oil through the filler plug hole ① until the oil level reaches the bottom of the filler hole, then reinstall the plug.

WARNING

After driving the vehicle, the transmission oil temperature may be high enough to burn you. Wait until the oil filler plug is cool enough to touch with your bare hands before inspecting transmission oil.

CAUTION

When tightening the plug, apply sealing compound to the plug threads to prevent oil leakage.

Gear oil change

Since special procedures, materials and tools are required, it is recommended that you trust this job to your authorized MARUTI SUZUKI dealer.

ENGINE COOLANT

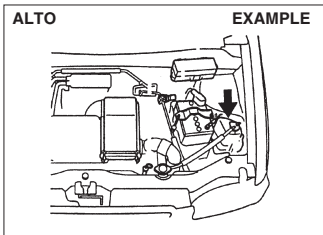

76G-09-011

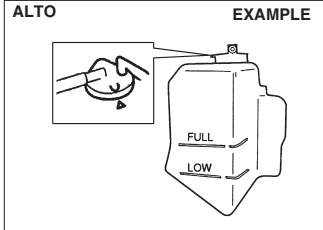
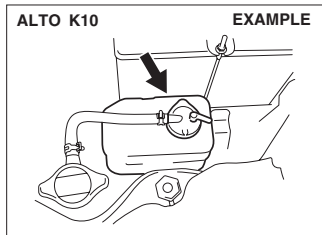

76G-09-012

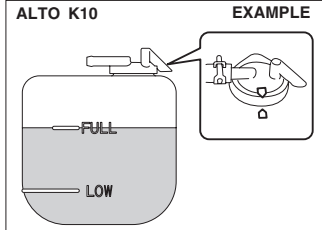

Selection of Coolant

To maintain optimum performance and durability of your engine, use MARUTI Genuine Coolant or equivalent.

This type of coolant is best for your cooling system as it:

- Helps maintain proper engine temperature.
- Gives proper protection against freezing and boiling.
- Gives proper protection against corrosion and rust.

Failure to use the proper coolant can damage your cooling system. Your MARUTI SUZUKI authorized dealer can help you select the proper coolant.

CAUTION

To avoid damaging your cooling system:

- Always use a high quality ethylene glycol base non-silicate type coolant diluted with distilled water at the correct mixture concentration.
- Make sure that the proper mix is 30/70 coolant to distilled water. Concentrations greater than 70/30 coolant to distilled water will cause over heating conditions.
- Do not use straight coolant nor plain water.
- Do not add extra inhibitors or additives. They may not be compatible with your cooling system.
- Do not mix different types of base coolants. Doing so may result in accelerated seal wear and/or the possibility of severe overheating and extensive engine damage.

Coolant Level Check

Check the coolant level at the reservoir tank, not at the radiator. With the engine cool, the coolant level should be between the "FULL" and "LOW" marks.

Adding Coolant

If the coolant level is below the "LOW" mark, more coolant should be added. Remove the reservoir tank cap and add coolant until the reservoir tank level reaches the "FULL" mark. Never fill the reservoir tank above the "FULL" mark.

CAUTION

- The mixture you use should contain 50% concentration of antifreeze.
- If the lowest ambient temperature in your area is expected to be -35°C (-31°F) or below, use higher concentrations up to 60% following the instructions on the antifreeze container.
- When putting the cap on the reservoir tank, line up the arrow on the cap and the arrow on the tank. Failure to follow this can result in coolant leakage.

▲ WARNING

Engine coolant is harmful or fatal if swallowed or inhaled. Do not drink antifreeze or coolant solution. If swallowed, do not induce vomiting. Immediately contact a poison control center or a physician. Avoid inhaling mist or hot vapors. If inhaled, expose yourself to fresh air. If coolant gets in eyes, flush eyes with water and seek medical attention. Wash thoroughly after handling. Solution can be poisonous to animals. Keep out of the reach of children and animals.

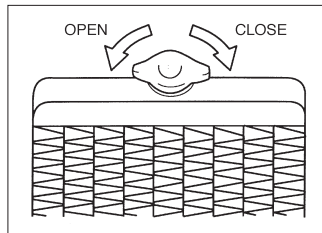

76G-09-013

Coolant Replacement

Trust this job to your Maruti Suzuki Authorised Workshop.

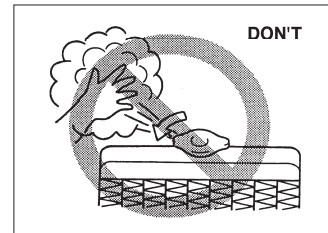

76G-09-014

▲ WARNING

It is dangerous to remove the radiator cap when the water temperature is high, because scalding fluid and steam may be blown out under pressure. Wait until the coolant temperature has lowered before removing the cap.

WINDSCREEN WASHER FLUID

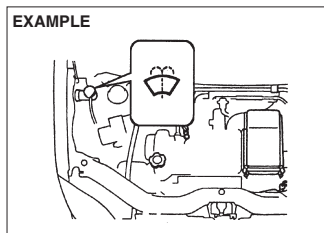

76G-09-016

Check that there is washer fluid in the tank. Refill it if necessary. Use a good quality windscreen washer fluid, diluted with water as necessary.

▲ WARNING

Do not use "antifreeze" solution in the windscreen washer reservoir. This can severely impair visibility when sprayed on the windscreen, and can also damage your vehicle's paint.

CAUTION

Damage may result if the washer motor is operated whilst the fluid or fluid nozzles are frozen or with no fluid in the washer tank.

AIR CLEANER

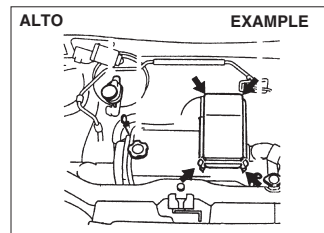

76G-09-017

If the air cleaner is clogged with dust, there will be greater intake resistance, resulting in decreased power output and increased fuel consumption.

Take out the air cleaner element after unhooking the clamps shown in the illustration. Blow off dust on air cleaner element by compressed air. If the air cleaner element appears to be dirty, replace it with a new one.

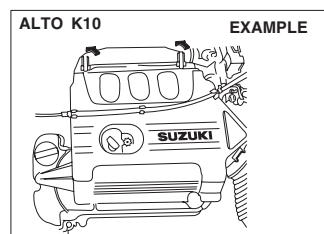

SPARK PLUGS

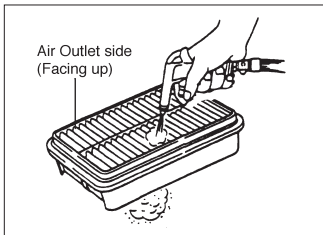

76G-09-018

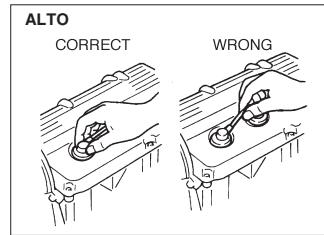

76G-09-019

You should inspect spark plugs periodically for carbon deposits. When carbon accumulates on a spark plug, a strong spark may not be produced. Remove carbon deposits with a wire or pin and adjust the spark plug gap.

CAUTION
 The air cleaner element should be replaced every 40,000 km. More frequent replacement is necessary when you drive under dusty conditions.

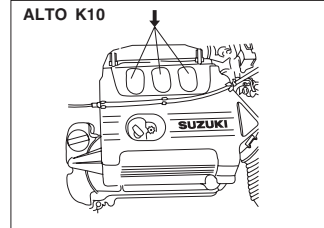

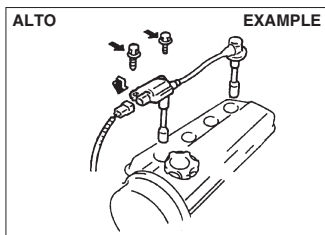

76G-09-020

To access the spark plugs,

For Alto

1. Disconnect the coupler while pushing the release lever,
2. Remove the bolts, and
3. Pull the spark plug boots.

For Alto K10

1. Unclamp and remove the air cleaner case.
2. If necessary, disconnect the coupler (1) while pushing the release lever.
3. Remove the ignitor bolts.
4. Pull the spark plug boots out.

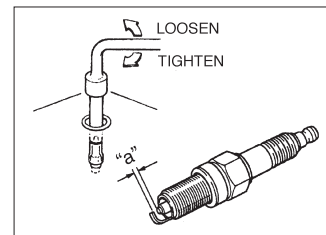

76G-09-021

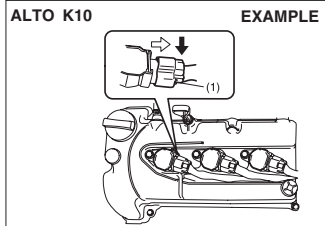

CAUTION

- When disconnecting the spark plug cables, pull on the boot, not on the cable itself. Pulling on the cable can damage it.
- When installing the spark plugs, screw them in with your fingers to avoid stripping the threads. Tighten with a torque wrench to :
Alto - 13.0–22.0 N-m (1.3–2.2 kg-m, 9.4–15.9 lb-ft)
Alto K10 - 25 N-m (2.5 kg-m, 18.0 lb-ft).

Do not allow contaminants to enter the engine through the spark plug holes when the plugs are removed.

- Never use spark plugs with the wrong thread size or length.

Spark Plug gap "a"

Alto - 0.85 ± 0.5 mm
Alto K10 - 1.0 ± 0.05 mm

CAUTION

When replacing spark plugs, you should use the brand and type specified for your vehicle. For the specified plugs, refer to the "SPECIFICATIONS" section at the end of this book.

NOTE:

When installation, make sure the wires, couplers, sealing rubber of top cover and washers, are correctly returned in place.

FUEL FILTER REPLACEMENT

Trust this replacement job to your MARUTI SUZUKI authorised workshop.

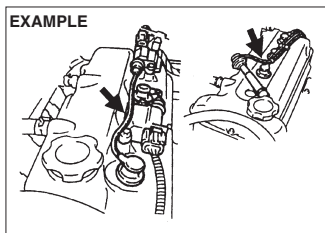

76G-09-022

NOTE:

If you experience some firing problem of spark plugs, such as, hard engine-starting, misfire etc., the cause may be located not only on spark plugs but also on deteriorated ignition wiring (generally, used for more than 80,000 km or five years). If spark plug replacement does not solve the problem, have the ignition wiring and other ignition system inspected by your MARUTI SUZUKI dealer.

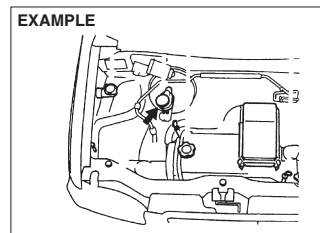
BRAKES

76G-09-023

Brake Fluid

Check the brake fluid level by looking at the reservoir in the engine compartment. Check that the fluid level is between the "MAX" and "MIN" lines. If the brake fluid level is near the "MIN" line, fill it up to the "MAX" line with MARUTI GENUINE brake fluid.

▲ WARNING

Failure to follow the guidelines below can result in personal injury or serious damage to the brake system.

- If the brake fluid in the reservoir drops below a certain level, the brake warning light on the instrument panel will come on (the



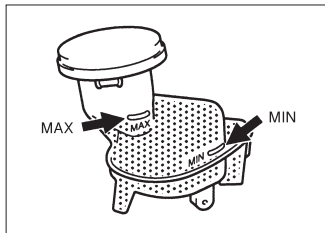

76G-09-024

⚠ WARNING

← parking brake must be fully disengaged with ignition switch in "ON" position). Should the light come on, immediately ask your MARUTI SUZUKI dealer to inspect the brake system.

- A rapid fluid loss indicates a leak in the brake system which should be inspected by your MARUTI SUZUKI dealer immediately.
- Brake fluid can harm your eyes and damage painted surfaces. Use caution when refilling the reservoir.



76G-09-025

⚠ WARNING

- Do not use any fluid other than MARUTI GENUINE brake fluid. Do not use reclaimed fluid or fluid that has been stored in old or open containers. It is essential that foreign particles and other liquids are kept out of the brake fluid reservoir.

CAUTION

The brake fluid should be replaced every two years or 20,000 km.

NOTE:

With disc brakes, the fluid level can be expected to gradually fall as the brake pads wear.

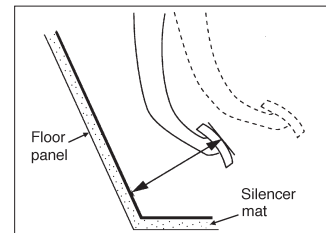

76G-09-026

Brake Pedal

Check if the brake pedal stops at the regular height without "spongy" feeling when you depress it. If not, have the brake system inspected by your MARUTI SUZUKI dealer. If you doubt the brake pedal for the regular height, check it as follows:

With the engine running, measure the distance between the brake pedal and floor silencer mat when the pedal is depressed with approximately 30 kg (66 lbs) of force. The minimum distance required is 110 mm (4.3 in). Since your vehicle's brake system is self-adjusting, there is no need for pedal adjustment. If the pedal to floor wall distance as measured above is less than the minimum distance required, have your vehicle inspected by your MARUTI SUZUKI dealer.

NOTE:
When measuring the distance between the brake pedal and floor wall, be sure not to include any floor covering other than silencer mat in the measurement.

▲ WARNING

If you experience any of the following problems with your vehicle's brake system, have the vehicle inspected immediately by your MARUTI SUZUKI dealer.

- Poor braking performance
- Uneven braking (Brakes not working uniformly on all wheels.)
- Excessive pedal travel
- Brake dragging
- Excessive noise
- Pedal pulsation (Pedal pulsates when depressed.)

PARKING BRAKE

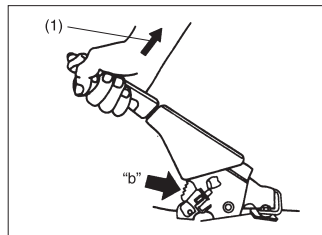

76G-09-027

Ratchet tooth specification "b"
4th- 9th
Lever pull force (1)
200 N (20kg, 44 lbs)

Check the parking brake for proper adjustment by counting the number of clicks made by the ratchet teeth as you slowly pull up on the parking brake lever to the point of full engagement. The parking brake lever should stop between the specified ratchet teeth and the rear wheels should be securely locked. If the parking brake is not properly adjusted or the brakes drag after the lever has been fully released, have the parking brake inspected and/or adjusted by your MARUTI SUZUKI dealer.

STEERING

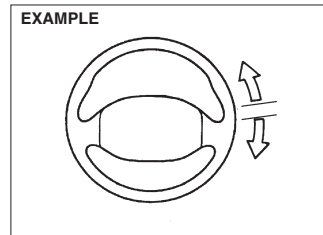

76G-09-028

EXAMPLE
Check the play of the steering wheel by gently turning it from left to right and measuring the distance that it moves before you feel slight resistance. The play should be between 0 – 30 mm (0.0 – 1.2 in).

Check that the steering wheel turns easily and smoothly without rattling by turning it all the way to the right and to the left while driving very slowly in an open area. If the amount of free play is outside the specification or you find anything else to be wrong, an inspection must be performed by your MARUTI SUZUKI dealer.

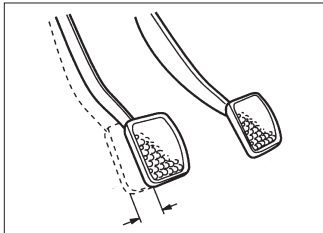
CLUTCH PEDAL

76G-09-029

Measure the clutch pedal play by moving the clutch pedal with your hand and measuring the distance it moves until you feel slight resistance. The play in the clutch pedal should be between 15 – 20 mm (0.6 – 0.8 in). If the play is more or less than the above, or clutch dragging is felt with the pedal fully depressed, have the clutch inspected by your MARUTI SUZUKI dealer.

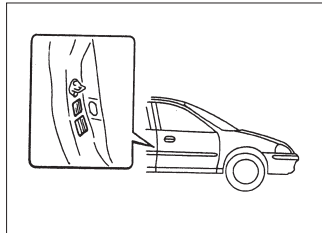
TYRES

76G-09-030

The front and rear tyre pressure specifications for your vehicle are listed on the Tyre Inflation Pressure Label and in the "SPECIFICATIONS" section at the end of this book. Both the front and rear tyres should have the specified tyre pressure.

Tyre Inspection

Inspect your vehicle's tyres periodically by performing the following checks:

- 1) Measure the air pressure with a tyre gauge. Adjust the pressure if necessary. Remember to check the spare tyre too.

▲ WARNING

- Air pressures should be checked when the tyres are cold or you may get inaccurate readings.
- Check the inflation pressure from time to time while inflating the tyre gradually, until the specified pressure is obtained.
- Never underinflate or overinflate the tyres.

Underinflation can cause unusual handling characteristics or can cause the rim to slip on the tyre bead, resulting in an accident or damage to the tyre or rim. Overinflation can cause the tyre to burst, resulting in personal injury. Overinflation can also cause unusual handling characteristics which may result in an accident.

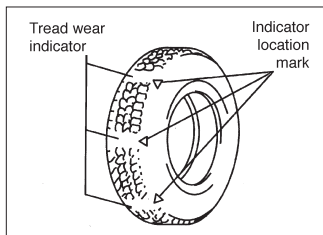

76G-09-031

- 2) Check that the depth of the tread groove is more than 1.6 mm (0.06 in). To help you check this, the tyres have moulded-in tread wear indicators in the grooves. When the indicators appear on the tread surface, the remaining depth of the tread is 1.6 mm (0.06 in) or less and the tyre should be replaced.
- 3) Check for abnormal wear, cracks and damage. Any tyres with cracks or other damage should be replaced. If any tyres show abnormal wear, have them inspected by your MARUTI SUZUKI dealer.

▲ WARNING

Hitting curbs and running over rocks can damage tyres and affect wheel alignment. Be sure to have tyres and wheel alignment checked periodically by your MARUTI SUZUKI dealer.

- 4) Check for loose wheel nuts.
- 5) Check that there are no nails, stones, or other objects sticking into the tyres.

▲ WARNING

Your MARUTI SUZUKI is equipped with tyres which are all the same type and size. This is important to ensure proper steering and handling of the vehicle. Never mix tyres of different size or type on the four wheels of your vehicle. The size and type of tyres used should be only those approved by MARUTI SUZUKI as standard or optional equipment for your vehicle.

▲ WARNING

Replacing the wheels and tyres equipped on your vehicle with certain combinations of aftermarket wheels and tyres can significantly change the steering and handling characteristics of your vehicle. Therefore, use only those wheel and tyre combinations approved by MARUTI SUZUKI as standard or optional equipment for your vehicle.

CAUTION

Replacing the original tyres with tyres of a different size may result in false speedometer or odometer readings.

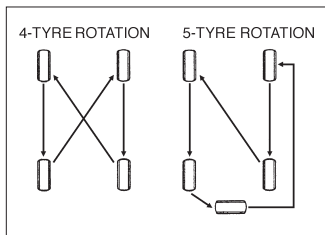

76G-09-032

Tyre Rotation

To avoid uneven wear of your tyres and to prolong their life, rotate the tyres as illustrated. Tyres should be rotated as recommended in the periodic maintenance schedule. After rotation, adjust front and rear tyre pressures to the specification listed on your vehicle's Tyre Inflation Pressure Label.

Wheel Balancing

If the vehicle vibrates abnormally on smooth road, have the wheels balanced at Maruti Suzuki authorized workshop.

Wheel Alignment

In case of abnormal tyre wear or pulling towards one side, have the wheel aligned at Maruti Suzuki authorized workshop.

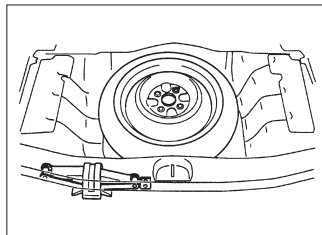

76G-09-033

Changing Wheels

To change a wheel, use the following procedure:

- 1) Remove the jack, tools and spare wheel from the vehicle

NOTE:

If it is hard to loosen the bolt that secures the spare tyre, use the jack crank as illustrated.

- 2) Loosen, but do not remove the wheel nuts.
- 3) Jack up the vehicle (follow the jacking instructions in the EMERGENCY SERVICE section in this manual)

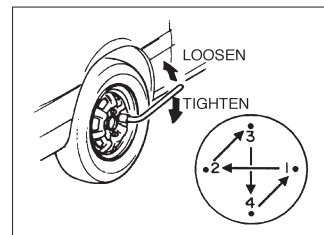

76G-09-034

- 4) Remove the wheel nuts and wheel.
- 5) Before installing the new wheel, clean any mud or dirt off from the surface of the wheel and hub with a clean cloth. Clean the hub carefully; it may be hot from driving.
- 6) Install the new wheel and replace the wheel nuts with their cone shaped end facing the wheel. Tighten each nut snugly by hand until the wheel is securely seated on the hub.
- 7) Lower the jack and fully tighten the nuts [to 8.5 kg-m (61.5 lb-ft)] in a crisscross fashion with a wrench as shown in the illustration.

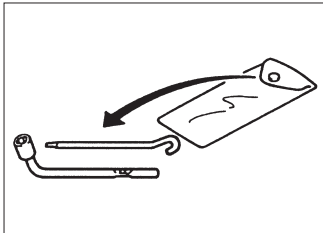

76G-09-035

⚠ WARNING

Use MARUTI Genuine wheel nuts and tighten them to the specified torque as soon as possible after changing wheels. Incorrect wheel nuts or improperly tightened wheel nuts may come loose or fall off, which can result in an accident. If you do not have a torque wrench, have the wheel nut torque checked by a MARUTI SUZUKI authorized dealer.

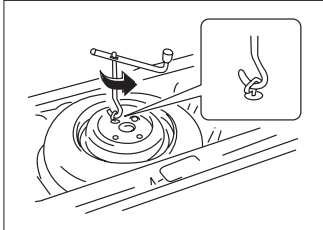

76G-09-036

Tubeless Tyres (If equipped)

The vehicle is equipped with Tubeless Tyres. In tubeless tyre, a thin layer of butyl rubber is used for lining the inside of the tubeless tyre. This layer is to prevent air loss and fulfilling the purpose of tube. The air pressure is maintained by the sealing between tyre bead and wheel rim. Tubeless tyres are having advantage of slow air loss and preventing sudden deflation while driving.

Care and maintenance tips for tubeless tyres

1. Always maintain recommended inflation pressure. Driving continuously at low inflation pressure can lead to tyre damage.
2. In case any leakage is found, check for any nail penetration/valve core damage or rim bent. Damaged wheel must not be used.
3. In case tyre has run at low pressure, it must be inspected for any defect.
4. Whenever new tyre is fitted, replace the valve.
5. If continuous high speed driving is required, increase tyres pressure by 5 psi over recommended inflation pressure.

BATTERY

6. Never run the tyre beyond TWI (Tread wear indicator). The tyre is recommended to be replaced when the remaining tread has worn to this point. The indicators are spaced across the tread around the tyre marked by a triangular symbol (TWI).
7. Always prefer tubeless tyre mounting machine. In case of manual mounting-tyre/wheel rim damage may occur.
8. In case of any problem, please get in touch with MARUTI SUZUKI authorised dealer.

EXAMPLE-1

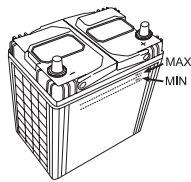

76G-09-037

EXAMPLE-2

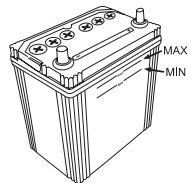

76G-09-038

⚠ WARNING

Batteries produce flammable hydrogen gas. Keep flames and sparks away from the battery or an explosion may occur. Never smoke when working in the vicinity of the battery.

⚠ WARNING

When checking or servicing the battery, disconnect the negative cable. Be careful not to cause a short circuit by allowing metal objects to contact the battery posts and the vehicle at the same time.

FUSES

⚠ WARNING

To avoid harm to yourself or damage to your vehicle or battery, follow the jump starting instructions in the EMERGENCY SERVICE section of this manual if it is necessary to jump start your vehicle.

The level of the battery solution must be kept between the "MAX" and the "MIN" level lines at all times. If the level is found to be below the "MIN" level line, add distilled water to the "MAX" level line. You should periodically check the battery, battery terminals, and battery hold-down bracket for corrosion. Remove corrosion using a stiff brush and ammonia mixed with water, or baking soda mixed with water. After removing corrosion, rinse with clean water.

If your vehicle is not going to be driven for a month or longer, disconnect the cable from the negative terminal of the battery to help prevent discharge.

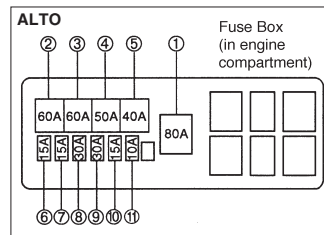

76G-09-039

- ①. Main fuse
- ②. Primary fuse (IG)
- ③. Primary fuse (Not under ignition switch)
- ④. Empty
- ⑤. Empty
- ⑥. Headlight (R)
- ⑦. Headlight (L)
- ⑧. Empty
- ⑨. Radiator fan motor fuse
- ⑩. Fuel injection system fuse
- ⑪. Air conditioner (If equipped)

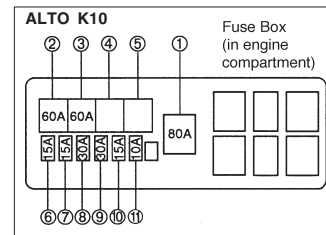

76G-09-039

- ①. Main fuse
- ②. Primary fuse (IG)
- ③. Primary fuse (Not under ignition switch)
- ④. Empty
- ⑤. Empty
- ⑥. Headlight (R)
- ⑦. Headlight (L)
- ⑧. Blower
- ⑨. Radiator fan motor fuse
- ⑩. Fuel injection system fuse
- ⑪. Air conditioner (If equipped)

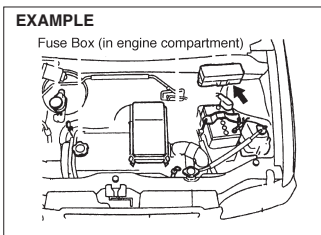

This vehicle has three types of fuses, as described below :

Main Fuse - The main fuse takes current directly from the battery.

Primary Fuses - These fuses are between the main fuse and individual fuses, and are for electrical load groups.

Individual Fuses - These fuses are in the fuse box and for individual electrical circuits.

MAIN FUSE / PRIMARY FUSES	
80A	All Electric Load
60A (IG)	CIGAR, TURN/BACK, I.G./METER, HEATER, REAR DEFG, WIPER/WASHER, POWER WINDOW
60A	DOOR LOCK, TAIL, STOP, RADIO/DOME, HORN/HAZARD

Main Fuse and Primary Fuses

The main fuse and primary fuses are located in the engine compartment. If the main fuse blows, no electrical component will function. If a primary fuse blows, no electrical component in the corresponding load group will function. When replacing the main fuse or a primary fuse, use a MARUTI genuine replacement.

⚠ WARNING

If the main fuse or a primary fuse blows, be sure to have your vehicle inspected by an authorized MARUTI SUZUKI dealer. Always use a MARUTI genuine replacement. Never use a substitute such as a wire even for a temporary repair, or extensive electrical damage and a fire can result.

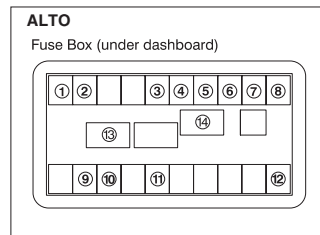

- | | |
|-----------------|-----|
| ①. HEATER | 10A |
| ②. WIPER/WASHER | 15A |
| ③. BLANK | |
| ④. STOP | 10A |
| ⑤. TAIL | 10A |
| ⑥. RADIO/DOME | 15A |
| ⑦. HORN HAZARD | 15A |
| ⑧. BLOWER | 25A |
| ⑨. IG | 15A |
| ⑩. TURN/BACK | 10A |
| ⑪. STEERING | 30A |
| ⑫. CIGAR | 15A |
| ⑬. STARTER FUSE | 30A |
| ⑭. FUSE PULLER | |

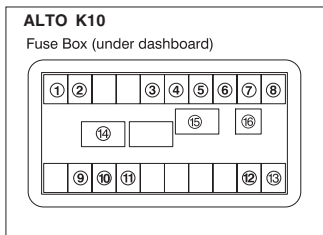

76G-09-041A

①. HEATER	10A
②. WIPER/WASHER	15A
③. DOOR LOCK	20A
④. STOP	10A
⑤. TAIL	10A
⑥. RADIO/DOME	15A
⑦. HORN HAZARD	15A
⑧. POWER STEERING	30A
⑨. IG	15A
⑩. TURN/BACK	10A
⑪. METER	10A
⑫. ACC	15A
⑬. CIGAR	15A
⑭. STARTER FUSE	30A
⑮. FUSE PULLER	
⑯. POWER WINDOW	30A

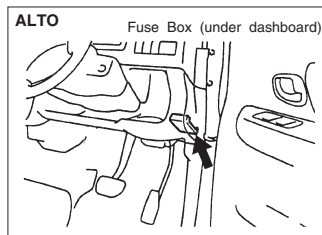

76G-09-042

Fuse Box

The fuse boxes are located in the engine compartment and under the driver's side of the dashboard.

To remove the fuse box cover under the dashboard pull off the cover.

NOTE:**Alto**

To remove the fuse from the fuse box use the fuse puller given in the fuse box (under dashboard) as shown in the illustration.

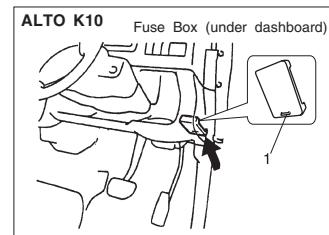

76G-09-042A

NOTE:**Alto K10**

Replace the fuse as described on the fuse box cover. Use the fuse puller given in the fuse box and keeping cover rib (1) in downward direction as shown.

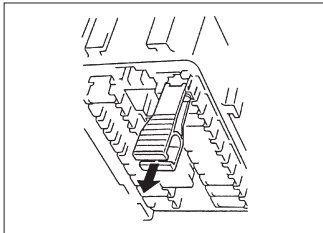

76G-09-043

⚠ WARNING

Always be sure to replace a blown fuse with a fuse of the correct amperage. Never use a substitute such as aluminium foil or wire to replace a blown fuse. If you replace a fuse and the new one blows in a short period of time, you may have a major electrical problem. Have your vehicle inspected immediately by your MARUTI SUZUKI dealer.

NOTE:
Make sure that the fuse box always carries spare fuses.

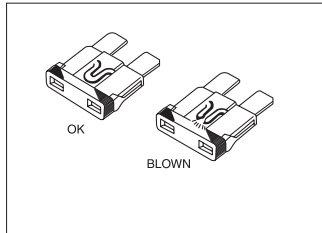

76G-09-044

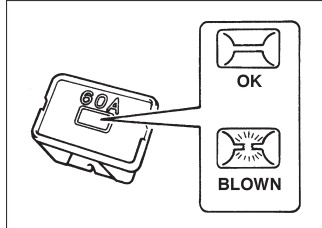

76G-09-045

BULB REPLACEMENT

⚠ WARNING

- Light bulbs can be hot enough to burn your finger right after being turned off. This is true especially for halogen headlight bulbs. Replace the bulbs after they become cool enough.
- The headlight bulbs are filled with pressurized halogen gas. They can burst and injure you if they are hit or dropped. Handle them carefully.

CAUTION

The oils from your skin may cause a halogen bulb to overheat and burst when the lights are on. Grasp a new bulb with a clean cloth.

CAUTION

Frequent replacement of a bulb indicates the need for an inspection of the electrical system. This should be carried out by your MARUTI SUZUKI dealer.

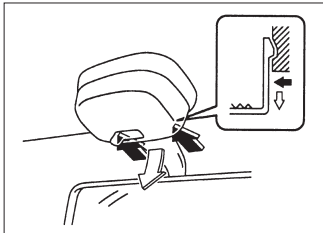

76G-09-046

Front Interior Light

Press the front part of the lens toward you and pull down the lens. To install it, simply push it back in.

The bulb can be removed by simply pulling it out. When replacing the bulb, make sure that the contact springs are holding the bulb securely.

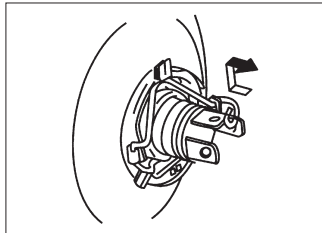

76G-09-047

Headlights

Open the bonnet. Disconnect the coupler. Remove the sealing rubber.

Push the retaining spring forward and unhook it. Then remove the bulb. Install a new bulb in the reverse order of removal.

Note:

Your vehicle is provided with two spare headlight bulbs for replacement in emergency.

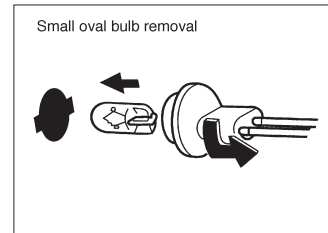

76G-09-048

Front Clearance/Turn Signal Light, Side Turn Signal Light, rear Combination Light, Registration Plate Light

To remove a bulb holder from a light housing, turn the holder counterclockwise and pull it out. To install the holder, push the holder in and turn it clockwise.

Two types (small oval and round) of bulb are used for these lights. To remove and install a small oval bulb, simply pull out or push in the bulb.

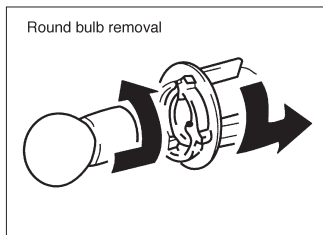

76G-09-049

To remove a round bulb from a bulb holder, push in the bulb and turn it counterclockwise. To install a new bulb, push it in and turn it clockwise. You can access the individual bulb holders as described below:

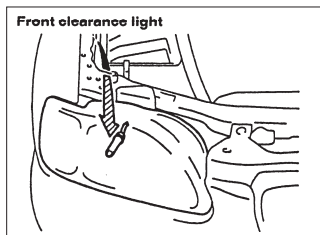

76G-09-050

Front clearance light / Turn Light

Trust this replacement job to your MARUTI SUZUKI authorised workshop.

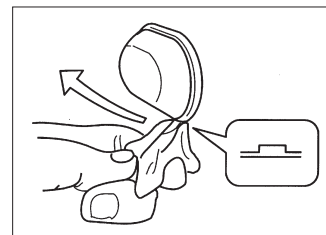

76G-09-051

Side turn signal light

Remove the lens by using a plain screw driver covered with a soft cloth.

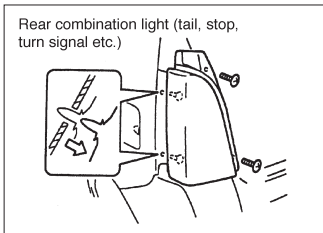

76G-09-052

Rear combination light (tail, stop, turn signal, etc.)

Undo the screws that secure the housing and remove the housing by sliding in the direction of the white arrow in the illustration.

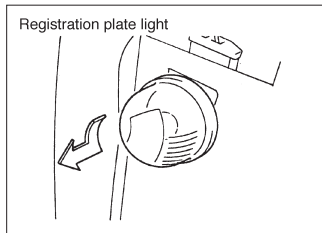

76G-09-053

Registration plate light

Turn the lens counterclockwise and pull it off

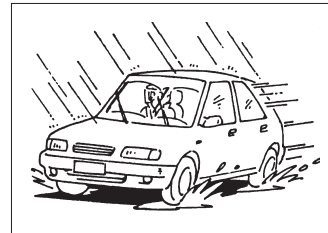
WIPER BLADES

76G-09-054

If the wiper blades become brittle or damaged, or make streaks when wiping, replace the wiper blades.

To install new wiper blades, follow the procedure below.

CAUTION

To avoid scratching or breaking the window, do not let the wiper arm strike the windshield while replacing the wiper blade.

NOTE:

Some wiper blades may be different from the ones described here depending on vehicle specifications. If so consult your MARUTI SUZUKI dealer for proper replacement method.

▲ WARNING

The left and the right wiper arm assemblies are different from each other. In case you have to remove the wiper arm assemblies for any reason, remember not to interchange the two while fitting them back. Wrong fitment may lead to windshield breakage.

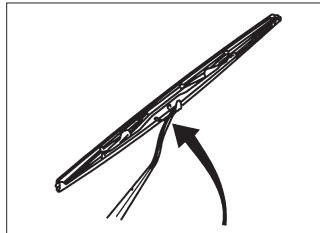

76G-09-055

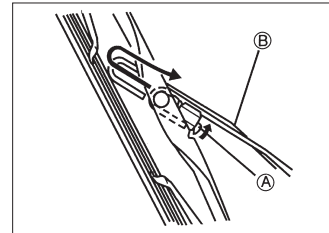

76G-09-056

For windshield wipers:

1. Hold the wiper arm away from the window.
2. Squeeze lock lever (A) towards wiper arms (B) and remove the wiper frame from the arm as shown.

EMERGENCY SERVICE

Jacking Instructions	10-1
Jump Starting Instructions	10-2
Towing	10-4
Towing Hook (if equipped)	10-4
Emergency Remedies	10-4
Warning Triangle	10-5

JACKING INSTRUCTIONS

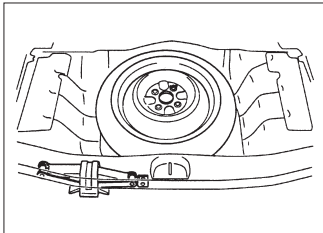

76G-10-001

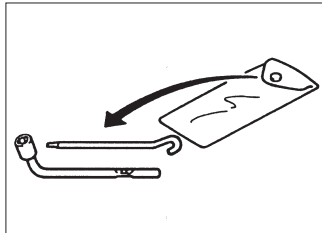

76G-10-002

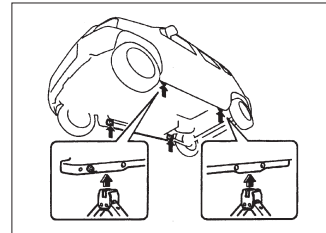

76G-10-004

- 1) Park the vehicle securely on hard level ground.
- 2) Apply the parking brake firmly and change into "R" (Reverse) gear. Choke the front and rear wheel diagonally opposite the wheel to be changed.
- 3) Switch on the hazard warning flasher if your vehicle is in or near traffic.
- 4) Slacken but do not remove wheel nuts on the wheel to be changed.
- 5) Position the jack vertically and raise the jack by turning the jack handle clockwise until the jack head recess fits the frame boss.

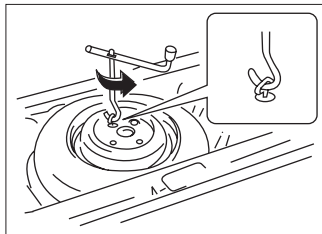

76G-10-003

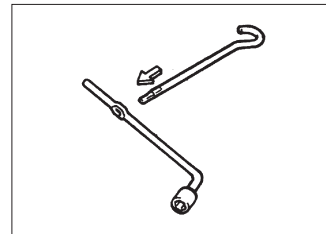

76G-10-005

- 6) Continue to raise the jack slowly and smoothly until the tyre clears the ground. Do not raise the vehicle more than necessary.

NOTE:
Use the wheel nut wrench in combination with jack crank to raise or lower the jack as shown in the illustration.

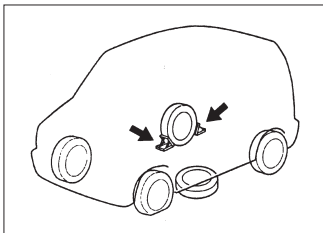

76G-10-006

▲ WARNING

- Use the jack only to change wheels.
- Never jack up the vehicle on an inclined surface.
- Never raise the vehicle with the jack in a location other than under the frame boss near the wheel to be changed.
- Make sure that the jack is raised at least 2 inches (51 mm) before it contacts the vehicle. Use of the jack when it is within 2 inches of being fully collapsed may result in failure of the jack.
- Never get under the vehicle when it is supported by the jack.
- Never run the engine when the vehicle is supported by the jack and

123

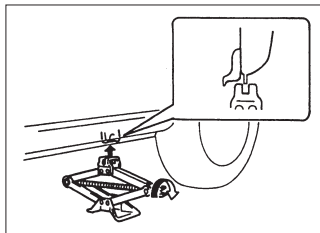

76G-10-007

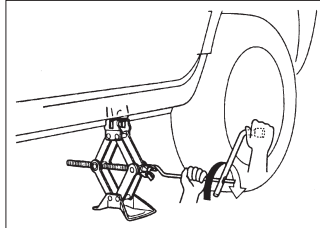

76G-10-008

▲ WARNING

← never allow passengers to remain in the vehicle.

JUMP STARTING INSTRUCTIONS

▲ WARNING

- Never attempt to jump start your vehicle if the battery appears to be frozen. Batteries in this condition may explode or rupture if jump starting is attempted.
- When making jump lead connections, be certain that your hands and the jump leads remain clear from pulleys, belts, or fans.
- Batteries produce flammable hydrogen gas. Keep flames and sparks away from the battery or an explosion may occur. Never smoke when working in the vicinity of the battery.
- If the booster battery you use for jump starting is installed in another vehicle, make sure the two vehicles are not touching each other.
- If your battery discharges repeatedly, for no apparent reason, have your vehicle inspected by an authorized MARUTI SUZUKI dealer.
- To avoid harm to yourself or damage to your vehicle or battery, follow the jump starting instructions below precisely and in order. If you are in doubt, call MARUTI SUZUKI authorized workshop.

10-2

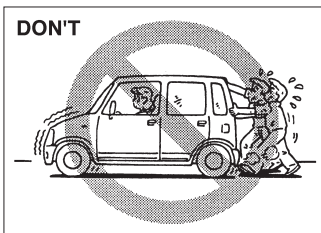

76G-10-009

CAUTION

- Vehicle equipped with electronic fuel injection system will not start by pushing or towing as the fuel pump will not work in this condition. This starting method could also result in permanent damage to the catalytic converter. Use jump leads to start a vehicle with a weak or flat battery.

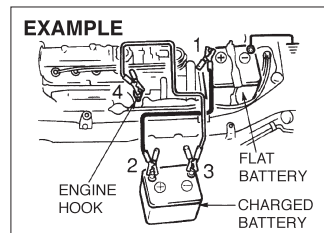

76G-10-010

When jump starting your vehicle, use the following procedure:

- 1) Use only a 12 volt battery to jump start your vehicle. Position the good 12V battery close to your vehicle so that the jump leads will reach both batteries. When using a battery installed on another vehicle, DO NOT LET THE VEHICLES TOUCH. Apply the parking brakes fully on both vehicles.
- 2) Turn off all vehicle accessories, except those necessary for safety reasons (for example, headlights or hazard lights).

3) Make jump lead connections as follows:

- a) Connect one end of the first jump lead to the positive (+) terminal of the flat battery.
- b) Connect the other end to the positive (+) terminal of the booster battery.
- c) Connect one end of the second jump lead to the negative (-) terminal of the booster battery.
- d) Make the final connection to an unpainted, heavy metal part of the engine of the vehicle with the flat battery.

⚠ WARNING

Never connect the jump lead directly to the negative (-) terminal of the discharged battery, or an explosion may occur.

- 4) If the booster battery you are using is fitted to another vehicle, start the engine of the vehicle with the booster battery. Run the engine at moderate speed.
- 5) Start the engine of the vehicle with the flat battery.
- 6) Remove the jump leads in the exact reverse order in which you connected them.

TOWING

76G-10-011

If you need to have your vehicle towed, contact a professional service. Your dealer can provide you with detailed towing instructions.

CAUTION

To help avoid damage to your vehicle during towing, proper equipment and towing procedures must be used.

TOWING HOOK (If equipped)**Manual Transmission**

Whenever possible, your vehicle should be towed from the front with the front wheels lifted. If the steering and drivetrain are in good condition, your vehicle may be towed from the rear with the rear wheels lifted and the front wheels on the ground. Before towing, make sure the steering is unlocked and the transmission is in neutral.

EMERGENCY REMEDIES**If the Starter Does Not Operate:**

- 1) Try turning the ignition switch to the "START" position with the headlights turned on to determine the battery condition. If the headlights go excessively dim or go off, it usually means that either the battery is flat or the battery terminal contact is poor. Recharge the battery or correct battery terminal contact as necessary.
- 2) If the headlights remain bright, check the fuses. If the reason for failure of the starter is not obvious, there may be a major electrical problem. Have the vehicle inspected by your authorized MARUTI SUZUKI dealer.

If the Engine is Flooded

If the engine is flooded with petrol, it may be hard to start. If this happens, press the accelerator pedal all the way to the floor and hold it there while cranking the engine. (Do not operate the starter motor for more than 15 seconds). Release the accelerator as soon as the engine has started.

If the Engine Overheats

The engine could overheat temporarily under severe driving conditions. If the engine coolant temperature warning light comes on, it indicates overheating during driving:

- 1) Turn off the air conditioner, if equipped.
- 2) Take the vehicle to a safe place and park.
- 3) Let the engine run at normal idle speed for a few minutes until engine coolant temperature warning light goes off.

▲ WARNING

If you see or hear escaping steam, stop the vehicle in a safe place and immediately turn off the engine to let it cool. Do not open the bonnet when steam is present. When the steam can no longer be seen or heard, open the hood to see if the coolant is still boiling. If it is, you must wait until it stops boiling before you proceed.

If the engine coolant temperature warning light does not go off:

- 1) Turn off the engine and check that the water pump belt and pulleys are not damaged or slipping. If any abnormality is found, correct it.
- 2) Check the coolant level in the reservoir. If it is found to be lower than the "LOW" line, look for leaks at the radiator, water pump, and radiator and heater hoses. If you locate any leaks that may have caused the overheating, do not run the

engine until these problems have been corrected.

- 3) If you do not find a leak, carefully add coolant to the reservoir and then the radiator, if necessary. (Refer to "ENGINE COOLANT" in the "INSPECTION AND MAINTENANCE" section.)

▲ WARNING

It is dangerous to remove the radiator cap when the water temperature is high, because scalding fluid and steam may be blown out under pressure. The cap should only be taken off when the coolant temperature has lowered.

▲ WARNING

To help prevent personal injury, keep hands, tools and clothing away from the engine cooling fan and air-conditioner fan (if equipped). These electric fans can automatically turn on without warning.

WARNING TRIANGLE

EXAMPLE

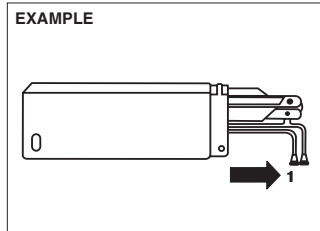

76G-10-012

In case of vehicle break-down or during emergency stopping, where, your vehicle could become a potential traffic hazard, keep the warning triangle, provided with your vehicle, on the road free from any obstacles behind your vehicle so as to warn the approaching traffic, at an approximate distance of 50-100 m. The reflecting side of the triangle should face the on coming traffic. Please activate the hazard warning lamps before alighting the vehicle to keep the warning triangle.

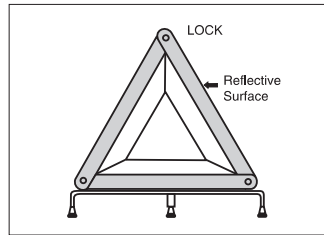
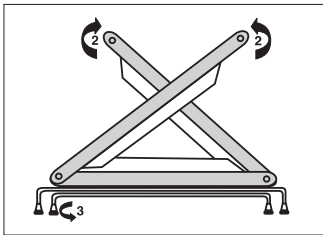

- Remove the warning triangle carefully from the cover as shown by arrow 1.
- Open both the reflector arms as shown by arrow 2 and lock the arms with each other with the clip provided in the right arm. Open the bottom stand in counter clock-wise direction as shown by arrow 3. Position the warning triangle behind the vehicle on a plain surface.
- Reverse the removal procedure for keeping inside the cover.

BODY WORK CARE

Corrosion Prevention	11-1
Vehicle Cleaning	11-2

CORROSION PREVENTION

It is important to take good care of your vehicle to protect it from corrosion. Listed below are instructions for how to maintain your vehicle to prevent corrosion. Please read and follow these instructions carefully.

Important Information About Corrosion**Common causes of corrosion**

- 1) Accumulation of road salt, dirt, moisture, or chemicals in hard to reach areas of the vehicle underbody or frame.
- 2) Chipping, scratches and any damage to treated or painted metal surfaces resulting from minor accidents or abrasion by stones and gravel.

Environmental conditions which accelerate corrosion

- 1) Road salt, dust control chemicals, sea air or industrial pollution will all accelerate the corrosion of metal.
- 2) High humidity will increase the rate of corrosion particularly when the temperature range is just above the freezing point.
- 3) Moisture in certain areas of a vehicle for an extended period of time may promote corrosion even though other body sections may be completely dry.
- 4) High temperatures will cause an accelerated rate of corrosion to parts of

the vehicle which are not well ventilated to permit quick drying.

This information illustrates the necessity of keeping your vehicle (particularly the underbody) as clean and dry as possible. It is equally important to repair any damage to the paint or protective coatings as soon as possible.

How to Help Prevent Corrosion**Wash your vehicle frequently**

The best way to preserve the finish on your vehicle and to help avoid corrosion is to keep it clean with frequent washing.

Wash your vehicle regularly during the winter and immediately after the winter. Keep your vehicle, particularly the underside, as clean and dry as possible.

If you frequently drive on salted roads, your vehicle should be washed at least once a month during the winter. If you live near the ocean, your vehicle should be washed at least once a month throughout the year. For washing instructions, refer to the "VEHICLE CLEANING" section.

Remove foreign material deposits

Foreign material such as salts, chemicals, road oil or tar, tree sap, bird droppings and industrial fall-out may damage the finish of your vehicle if it is left on painted surfaces. Remove these types of deposits as quickly

as possible. If these deposits are difficult to wash off, an additional cleaner may be required. Be sure that any cleaner you use is not harmful to painted surfaces and is specifically intended for your purposes. Follow the manufacturer's directions when using these special cleaners.

Repair finish damage

Carefully examine your vehicle for damage to the painted surfaces. Should you find any chips or scratches in the paint, touch them up immediately to prevent corrosion from starting. If the chips or scratches have gone through to the bare metal, have a qualified body shop make the repair.

Keep Passenger and luggage compartments clean.

Moisture, dirt or mud can accumulate under the floor mats and may cause corrosion. Occasionally, check under these mats to ensure that this area is clean and dry. More frequent checks are necessary if the vehicle is used off road or in wet weather.

Certain cargos such as chemicals, fertilizers, cleaners, salts, etc., are extremely corrosive by nature. These products should be transported in sealed containers. If a spill or leak does occur, clean and dry the area immediately.

VEHICLE CLEANING

Store your vehicle in a dry, well-ventilated area.

Do not park your vehicle in a damp, poorly ventilated area. If you often wash your vehicle in the garage or if you frequently drive it in when wet, your garage may be damp. The high humidity in the garage may cause or accelerate corrosion. A wet vehicle may corrode even in a heated garage if the ventilation is poor.

▲ WARNING

Do not apply additional undercoating or rust preventive coating on or around exhaust system components such as the exhaust pipes, etc. A fire could be started if the undercoating substance becomes overheated.

Cover your vehicle

If you cannot regularly park your vehicle in a garage, we recommend you use a vehicle cover.

▲ WARNING

When cleaning the interior or exterior of the vehicle, NEVER USE flammable solvents such as lacquer thinners, petrol, benzene or cleaning materials such as bleach or strong household detergents. The materials could cause personal injury or damage to the vehicle.

Cleaning the Interior**Vinyl upholstery**

Prepare a solution of soap or mild detergent mixed with warm water. Apply the solution to the vinyl with a sponge or soft cloth and let it soak for a few minutes to loosen dirt. Rub the surface with a clean, damp cloth to remove dirt and the soap solution. If some dirt still remains on the surface, repeat this procedure.

Fabric upholstery

Remove loose dirt with a vacuum cleaner. Using a mild soap solution, rub stained areas with a clean damp cloth. To remove soap, rub the areas again with a cloth dampened with water. Repeat this until the stain is removed, or use a commercial fabric

cleaner for tougher stains. If you use a fabric cleaner, carefully follow the manufacturer's instructions and precautions.

Seat Belts

Clean seat belts with a mild soap and water. Do not use bleach or dye on the belts. They may weaken the fabric in the belts.

Vinyl floor mats

Ordinary dirt can be removed from vinyl with water or mild soap. Use a brush to help loosen dirt. After the dirt is loosened, rinse the mat thoroughly with water and dry it in the shade.

Carpets

Remove dirt and soil as much as possible with a vacuum cleaner. Using a mild soap solution, rub stained areas with a clean damp cloth. To remove soap, rub the areas again with a cloth dampened with water. Repeat this until the stain is removed, or use a commercial carpet cleaner for tougher stains. If you use a carpet cleaner, carefully follow the manufacturer's instructions and precautions.

Cleaning the Exterior

CAUTION

It is important that your vehicle be kept clean and free from dirt. Failure to keep your vehicle clean may result in fading of the paint or corrosion to various parts of the vehicle body.

Washing

▲ WARNING

- Never attempt to wash and wax your vehicle with the engine running.
- When cleaning the underside of the body and fender, where there may be sharp-edged parts, you should wear gloves and a longsleeved shirt to protect your hands and arms from being cut.
- After washing your vehicle, carefully test the brakes before driving to make sure they have maintained their normal effectiveness.

When washing the vehicle, follow the instructions below:

- 1) Flush the underside of body and wheel housings with pressurized water to remove mud and debris. Use plenty of water.

CAUTION

When washing the vehicle, avoid directing steam or hot water of more than 80°C (176°F) on plastic parts.

- 2) Remove dirt and mud from the body exterior with running water. You may use a soft sponge or brush. Do not use hard materials which can scratch the paint.
- 3) Wash the entire exterior with a mild detergent or car wash soap using a sponge or soft cloth. The sponge or cloth should be frequently soaked in the soap solution.

CAUTION

When using a commercial car wash product, observe the cautions specified by the manufacturer. Never use strong household detergents or soaps.

- 4) Once the dirt has been completely removed, rinse off the detergent with running water.
- 5) After rinsing, wipe off the vehicle body with a wet chamois or cloth and allow it to dry in the shade.
- 6) Check carefully for damage to painted surfaces. If there is any damage, "Touchup" the damage following the procedure below:
 - a) Clean all damaged spots and allow them to dry.
 - b) Stir the paint and "touchup" the damaged spots lightly using a small brush.
 - c) Allow the paint to dry completely.

Waxing

After washing the vehicle, waxing and polishing are recommended to further protect and beautify the paint.

- Only use waxes and polishes of good quality.
- When using waxes and polishes, observe the precautions specified by the manufacturers.

GENERAL INFORMATION

Vehicle Identification 12-1

VEHICLE IDENTIFICATION



76G-12-001

Chassis Serial Number

The chassis and/or engine serial numbers are used to register the vehicle. They are also used to assist your dealer when ordering or referring to special service information. Whenever you have occasion to consult your MARUTI SUZUKI dealer, remember to identify your vehicle with this number. Should you find the number difficult to read, you will also find it on the identification plate in the engine compartment.

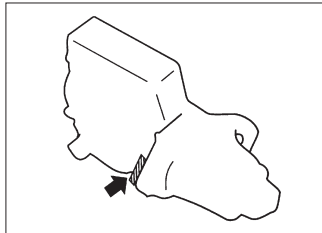

76G-12-002

Engine Serial Number

The engine serial number is stamped on the cylinder block as shown in the illustration and also on the identification plate.

SPECIFICATIONS

NOTE:

Specifications are subject to change without notice.

ITEM: DIMENSIONS		UNIT:mm	
		ALTO (STD / Lx / Lxi)	ALTO K10 (Lxi / Vxi)
Overall length		3495	3620
Overall width		1475	1495/1475 (without side moulding)
Overall height		1460	1460
Wheelbase		2360	2360
Tread	front	1295	1295
	rear	1290	1290
Ground clearance		160	160

ITEM: MASS (WEIGHT)		UNIT:Kg	
		ALTO (STD / Lx / Lxi)	ALTO K10 (Lxi / Vxi)
Kerb mass (weight)		690-705	750-765
Gross vehicle mass (weight) rating		1140	1185
Seating Capacity		5 persons	5 persons

ITEM: ENGINE		ALTO (STD / Lx / Lxi)		ALTO K10 (Lxi / Vxi)	
Type		F8D		K10B	
Number of cylinders		3		3	
Bore		68.5		73	
Stroke		72.0		79.5	
Piston displacement		796 cc		998 cc	
Compression ratio		9.2 ± 0.2 : 1		10.0 ± 0.4 : 1	

SPECIFICATIONS

76G-74E

ITEM: ELECTRICAL		
	ALTO (STD / Lx / Lxi)	ALTO K10 (Lxi / Vxi)
Standard spark plug	NGK-DCPR7E, BOSCH-YR7DC	NGK KR6A-10
Battery	34B20L (27AH/5HR)	38B20L (28AH/5HR)
Fuses	See "INSPECTION AND MAINTENANCE" section	
Headlight	12V 55/60W	
Turn signal light	12V 21W	
Side turn signal light	12V 5W	
Clearance light	12V 5W	
Tail/brake light	12V 21/5W	
Registration plate light	12V 5W	
Reversing light	12V 21W	
High Mount Stop Lamp	12V W16W	
ITEM: WHEEL AND SUSPENSION		
	ALTO (STD / Lx / Lxi)	ALTO K10 (Lxi / Vxi)
Tyre size, front and rear	145/80R12	155/65R13
Tyre pressures front/rear	2.1 kg/cm ²	2.2 kg/cm ²
Suspension type	front	Mac Pherson Strut
	rear	3-link-rigid axle suspension
ITEM: STEERING		
Toe-in	front	0 ± 1 mm
ITEM: CAPACITIES		
	ALTO (STD / Lx / Lxi)	ALTO K10 (Lxi / Vxi)
Coolant (Including reservoir tank)	3.5 Ltrs	4.3 Ltrs
Fuel tank	35.0 Ltrs	35.0 Ltrs
Engine oil (with oil filter)	2.7 Ltrs	2.9 Ltrs
Transmission oil	2.2 Ltrs	2.2 Ltrs

MEMO

