

SYLVANIA

32" Digital / Analog LCD TV built-in DVD Player

Owner's Manual

LD320SS8

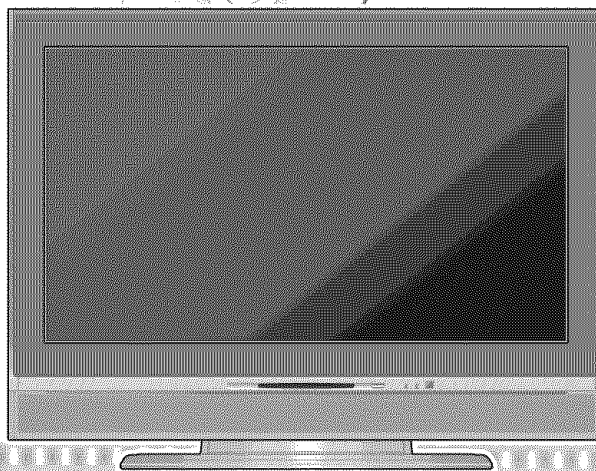
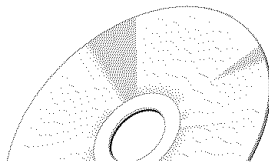
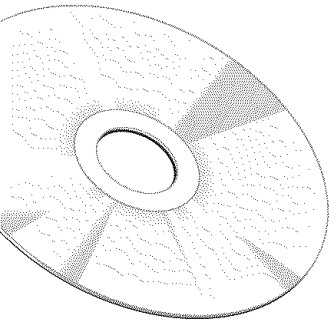

5 inch
Disc ONLY



TO RECEIVE DIGITAL/ANALOG SIGNAL, YOU MUST CONNECT ANTENNA.

IF YOU NEED ADDITIONAL ASSISTANCE WITH SETUP OR OPERATING AFTER READING OWNER'S MANUAL, PLEASE CALL TOLL FREE **1-800-968-3429**, OR VISIT OUR WEB SITE AT **<http://www.SylvaniaConsumerElectronics.com>**

WARNING: TO REDUCE THE RISK OF FIRE OR ELECTRIC SHOCK, DO NOT EXPOSE THIS APPLIANCE TO RAIN OR MOISTURE.



CAUTION
RISK OF ELECTRIC SHOCK
DO NOT OPEN



CAUTION: TO REDUCE THE RISK OF ELECTRIC SHOCK, DO NOT REMOVE COVER (OR BACK). NO USER SERVICEABLE PARTS INSIDE. REFER SERVICING TO QUALIFIED SERVICE PERSONNEL.



THIS SYMBOL INDICATES THAT DANGEROUS VOLTAGE CONSTITUTING A RISK OF ELECTRIC SHOCK IS PRESENT WITHIN THIS UNIT.



THIS SYMBOL INDICATES THAT THERE ARE IMPORTANT OPERATING AND MAINTENANCE INSTRUCTIONS IN THE LITERATURE ACCOMPANYING THE APPLIANCE.

The important note is located on the rear of the cabinet.

Important Safeguards

- READ INSTRUCTIONS** - All the safety and operating instructions should be read before the appliance is operated.
- RETAIN INSTRUCTIONS** - The safety and operating instructions should be retained for future reference.
- HEED WARNINGS** - All warnings on the appliance and in the operating instructions should be adhered to.
- FOLLOW INSTRUCTIONS** - All operating and use instructions should be followed.
- CLEANING** - Unplug TV from the wall outlet before cleaning. Do not use liquid cleaners or aerosol cleaners. Use a damp cloth for cleaning.
EXCEPTION: A product that is meant for uninterrupted service and, that for some specific reason, such as the possibility of the loss of an authorization code for a CATV converter, is not intended to be unplugged by the user for cleaning or any other purpose, may exclude the reference to unplugging the appliance in the cleaning description otherwise required in item 5.
- ATTACHMENTS** - Do not use attachments not recommended by the TV manufacturer as they may cause hazards.
- WATER AND MOISTURE** - Do not use this TV near water, for example, near a bath tub, wash bowl, kitchen sink, or laundry tub, in a wet basement, or near a swimming pool, and the like.
- ACCESSORIES** - Do not place this TV on an unstable cart, stand, tripod, bracket, or table. The TV may fall, causing serious injury to someone, and serious damage to the appliance. Use only with a cart, stand, tripod, bracket, or table recommended by the manufacturer, or sold with the TV. Any mounting of the appliance should follow the manufacturer's instructions and should use a mounting accessory recommended by the manufacturer. An appliance and cart combination should be moved with care. Quick stops, excessive force, and uneven surfaces may cause the appliance and cart combination to overturn.



- AMEUBLES** - Cet appareil ne doit être placé que sur un meuble (avec ou sans roulettes) recommandé par le fabricant. Si vous l'installez sur un meuble à roulettes, déplacez les deux ensembles avec précaution. Un arrêt brusque, l'utilisation d'une force excessive et des surfaces irrégulières risquent de déstabiliser l'ensemble et de le renverser.
- VENTILATION** - Slots and openings in the cabinet and the back or bottom are provided for ventilation and to ensure reliable operation of the TV and to protect it from overheating, these openings must not be blocked or covered. The openings should never be blocked by placing the TV on a bed, sofa, rug, or other similar surface. This TV should never be placed near or over a radiator or heat register. This TV should not be placed in a built-in installation such as a bookcase or rack unless proper ventilation is provided or the manufacturer's instructions have been adhered to.
 - POWER SOURCES** - This TV should be operated only from the type of power source indicated on the marking label. If you are not sure of the type of power supply to your home, consult your appliance dealer or local power company. For TVs intended to operate from battery power, or other sources, refer to the operating instructions.
 - GROUNDING OR POLARIZATION** - This TV is equipped with a polarized alternating-current line plug (a plug having one blade wider than the other). This plug will fit into the power outlet only one way. This is a safety feature. If you are unable to insert the plug fully into the outlet, try reversing the plug. If the plug should still fail to fit, contact your electrician to replace your obsolete outlet. Do not defeat the safety purpose of the polarized plug.
 - POWER-CORD PROTECTION** - Power-supply cords should be routed so that they are not likely to be walked on or pinched by items placed upon or against them, paying particular attention to cords at plugs, convenience receptacles, and the point where they exit from the appliance.
 - OUTDOOR ANTENNA GROUNDING** - If an outside antenna or cable system is connected to the TV, be sure the antenna or cable system is grounded so as to provide some protection against voltage surges and built-up static charges. Article 810 of the National Electrical Code, ANSI/NFPA No. 70, provides information with respect to proper grounding of the mast and

supporting structure, grounding of the lead-in wire to an antenna discharge unit, size of grounding conductors, location of antenna-discharge unit, connection to grounding electrodes, and requirements for the grounding electrode. (Fig. A)

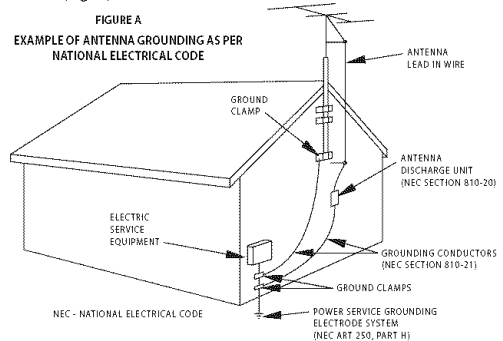

- LIGHTNING** - For added protection for this TV receiver during a lightning storm, or when it is left unattended and unused for long periods of time, unplug it from the wall outlet and disconnect the antenna or cable system. This will prevent damage to the TV due to lightning and power-line surges.
- POWER LINES** - An outside antenna system should not be located in the vicinity of overhead power lines or other electric light of power circuits, or where it can fall into such power lines or circuits. When installing an outside antenna system, extreme care should be taken to keep from touching such power lines or circuits as contact with them might be fatal.
- OVERLOADING** - Do not overload wall outlets and extension cords as this can result in a risk of fire or electric shock.
- OBJECT AND LIQUID ENTRY** - Never push objects of any kind into this TV through openings as they may touch dangerous voltage points or short out parts that could result in a fire or electric shock. Never spill liquid of any kind on the TV.
- SERVICING** - Do not attempt to service this TV yourself as opening or removing covers may expose you to dangerous voltage or other hazards. Refer all servicing to qualified service personnel.
- DAMAGE REQUIRING SERVICE** - Unplug this TV from the wall outlet and refer servicing to qualified service personnel under the following conditions:
 - When the power supply cord or plug is damaged or frayed.
 - If liquid has been spilled, or objects have fallen into the TV.
 - If the TV has been exposed to rain or water.
 - If the TV does not operate normally by following the operating instructions. Adjust only those controls that are covered by the operating instructions, as improper adjustment of other controls may result in damage and will often require extensive work by a qualified technician to restore the TV to its normal operation.
 - If the TV has been dropped or damaged in any way.
 - If the TV exhibits a distinct change in performance, this indicates a need for service.
- REPLACEMENT PARTS** - When replacement parts are required, be sure the service technician uses replacement parts specified by the manufacturer that have the same characteristics as the original part. Unauthorized substitutions may result in fire, electric shock, injury to persons or other hazards.
- SAFETY CHECK** - Upon completion of any service or repairs to this TV, ask the service technician to perform routine safety checks to determine that the TV is in proper operating condition.
- HEAT** - This TV product should be situated away from heat sources such as radiators, heat registers, stoves, or other products (including amplifiers) that produce heat.

✓ **Precautions**

(Hg) LAMP IN LCD CONTAINS MERCURY, DISPOSE ACCORDING TO LOCAL, STATE OR FEDERAL LAW.

CAUTION: TO PREVENT ELECTRIC SHOCK, MATCH WIDE BLADE OF PLUG TO WIDE SLOT, FULLY INSERT.
ATTENTION: POUR ÉVITER LES CHOCS ÉLECTRIQUES, INTRODUIRE LA LAME LA PLUS LARGE DE LA FICHE DANS LA BORNE CORRESPONDANTE DE LA PRISE ET POUSSER JUSQU'AU FOND.

FCC WARNING This equipment may generate or use radio frequency energy. Changes or modifications to this equipment may cause harmful interference unless the modifications are expressly approved in the manual. The user could lose the authority to operate this equipment if an unauthorized change or modification is made.

RADIO-TV INTERFERENCE

This equipment has been tested and found to comply with the limits for a Class B digital device, pursuant to Part 15 of the FCC Rules. These limits are designed to provide reasonable protection against harmful interference in a residential installation. This equipment generates, uses, and can radiate radio frequency energy and, if not installed and used in accordance with the instructions, may cause harmful interference to radio communications. However, there is no guarantee that interference will not occur in a particular installation. If this equipment does cause harmful interference to radio or television reception, which can be determined by turning the equipment off and on, the user is encouraged to try to correct the interference by one or more of the following measures:

- 1) Reorient or relocate the receiving antenna.
- 2) Increase the separation between the equipment and receiver.
- 3) Connect the equipment into an outlet on a circuit different from that to which the receiver is connected.
- 4) Consult the dealer or an experienced radio/TV technician for help.

This Class B digital apparatus complies with Canadian ICES-003.

Cet appareil numérique de la classe B est conforme à la norme NMB-003 du Canada.

Note to CATV system installer:

This reminder is provided to call the CATV system installer's attention to Article 820-40 of the NEC that provides guidelines for proper grounding and, in particular, specifies that the cable ground should be connected to the grounding system of the building as close to the point of cable entry as practical.

LASER SAFETY

This unit employs a laser. Only a qualified service person should remove the cover or attempt to service this device, due to possible eye injury.

CAUTION: USE OF CONTROLS OR ADJUSTMENTS OR PERFORMANCE OF PROCEDURES OTHER THAN THOSE SPECIFIED HEREIN MAY RESULT IN HAZARDOUS RADIATION EXPOSURE.

CAUTION: VISIBLE AND INVISIBLE LASER RADIATION WHEN OPEN AND INTERLOCK DEFEATED. DO NOT STARE INTO BEAM.

LOCATION: INSIDE, NEAR THE DECK MECHANISM.

IMPORTANT COPYRIGHT INFORMATION

Unauthorized copying, broadcasting, public performance and lending of discs are prohibited. This product incorporates copyright protection technology that is protected by U.S. patents and other intellectual property rights. Use of this copyright protection technology must be authorized by Macrovision, and is intended for home and other limited viewing uses only unless otherwise authorized by Macrovision. Reverse engineering or disassembly is prohibited.



"HDMI, the HDMI logo and High-Definition Multimedia Interface are trademarks or registered trademarks of HDMI Licensing LLC."



Manufactured under license from Dolby Laboratories. "Dolby" and the double-D symbol are trademarks of Dolby Laboratories.



"Kodak Picture CD COMPATIBLE" is a trademark of Eastman Kodak Company.



Product that have earned ENERGY STAR® are designed to protect the environment through superior energy efficiency.

LOCATION

For safe operation and satisfactory performance of the unit, keep the following in mind when selecting a place for its installation:

- Shield it from direct sunlight and keep it away from sources of intense heat.
- Avoid dusty or humid places.
- Avoid places with insufficient ventilation for proper heat dissipation. Do not block the ventilation holes at the top and bottom of the unit. Do not place the unit on a carpet because this will block the ventilation holes.
- Install the unit in a horizontal position.
- Avoid locations subject to strong vibration.
- Do not place the unit near strong magnetic fields.
- Avoid moving the unit to locations where temperature differences are extreme.
- Be sure to unplug the AC power cord from the outlet before carrying the unit.

TO AVOID THE HAZARDS OF ELECTRICAL SHOCK AND FIRE

- Do not handle the power cord with wet hands.
- Do not pull on the power cord when disconnecting it from an AC outlet. Grasp it by the plug.
- If, by accident, water is spilled on the unit, unplug the power cord immediately and take the unit to our authorized service center for servicing.
- Do not place anything directly on top of the unit.

MOISTURE WARNING

- Moisture condensation may occur inside the unit when it is moved from a cold place to a warm place, or after heating a cold room or under conditions of high humidity.
When the condensation occurs inside the unit, turn the unit on and leave it at least 2 hours to dry out.

The serial number of this product may be found on the back of the unit. No others have the same serial number as yours. You should record the number and other vital information here and retain this book as a permanent record of your purchase to aid identification in case of theft.

date of purchase	dealer phone No.	serial No.
dealer purchase from	model No.	dealer address

Note about recycling:

*This product's packaging materials are recyclable and can be reused. Please dispose of any materials in accordance with your local recycling regulations.
Batteries should never be thrown away or incinerated but disposed of in accordance with your local regulations concerning chemical wastes.*

✓ Supplied Accessories

owner's manual
(1EMN22184)

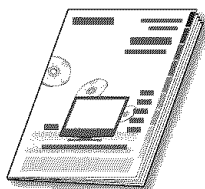

quick start guide
(1EMN22188)

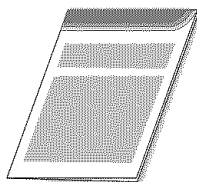

remote control
(NF018UD)



batteries
(AA x 2)

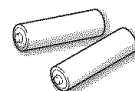

- If you need to replace these accessories, please refer to the part No. with the illustrations and call our toll free customer support line found on the cover of this manual.
- Depending on your antenna system, you may need different types of combiners (mixers) or separators (splitters). Contact your local electronics store for these items.

✓ Symbols Used in this Manual

The following is the description for the symbols used in this manual.
Description refers to:

TV FUNCTIONS	DVD FUNCTIONS
<p>TV : Analog TV operation</p> <p>DTV : Digital TV operation</p>	<p>DVD : Playback of DVD-video</p> <p>CD : Playback of audio CD</p> <p>VCD : Playback of video CD</p> <p>VCD w/o PBC : Playback of video CD without PBC function</p> <p>MP3 : Playback of CD-RW/-R with MP3 files</p> <p>JPEG : Playback of CD-RW/-R with JPEG files</p>
<p>• If neither symbol appears under the function heading, operation is applicable to both.</p>	<p>• If none of symbol appears under the function heading, operation is applicable to all.</p>

✓ Features

TV

- **DTV/TV/CATV**
 - You can use your remote control to select channels which are broadcast in digital, conventional analog, standard definition, and high definition formats. Also, cable subscribers can access their cable TV channels.
- **Program Information Display (DTV only)**
 - You can display the title, contents and other information of the current DTV program on the TV screen.
- **Auto Channel Scan**
 - This unit automatically scans and memorizes channels available in your area, eliminating difficult setup procedures.
- **V-chip**
 - This feature allows you to block children's access to inappropriate programs.
- **Closed Caption Decoder**
 - Built-in closed caption decoder displays text for closed caption supported programming.
- **MTS/SAP Tuner**
 - Audio can be selected from the remote control.
- **Auto Shut Off Function**
 - If there is no signal input from the antenna terminal and no operation for 15 minutes, the unit will turn off automatically.
- **Sleep Timer**
 - This feature will automatically turned off the power of the unit at a specific time.
- **Choices for On-screen Language**
 - Select your on-screen language: English, Spanish or French.
- **Stereo Sound Function**
- **PLL Frequency Synthesized Tuning**
 - Provides free and easy channel selection and lets you tune directly to any channel using the channel number buttons on the remote control.
- **Resume**
 - This unit automatically memorizes settings if a power failure occurs.
- **HDMI Input**
- **PC Input**
- **Component Video Input**
- **S-video Input**
- **AV Input**
- **Digital Audio Coaxial Output**

DVD

- **Dolby Digital Sound**
 - Enjoy Dolby Digital multi-channel surround sound when you connect the unit to your Dolby Digital decoder.
 - **Still / Fast / Slow / Step Playback**
 - Various playback modes are available including still pictures, fast forward/reverse, slow motion and step frames.
 - **DVD Menus in a Desired Language**
 - You can display DVD menus in a desired language, if available on a DVD-video.
 - **Screen Saver**
 - If there is no operation for 5 minutes, the screen saver program starts. The unit will turn itself off automatically.
 - **Parental Lock**
 - Block the viewing of DVD-video unsuitable for children.
 - **Resume Playback**
 - Lets you resume playback from the point at which playback was stopped.
 - **Bit Rate Indication**
 - **DRC (dynamic range control)**
 - You can control the range of sound volume.
 - **Selecting a Camera Angle**
 - You can select the desired camera angle, if a DVD contains sequences recorded from different angles.
 - **Zoom**
 - Allows you to enlarge the size of picture image.
 - **Black Level Adjustment**
 - **Virtual Surround**
 - **Search**
 - chapter search / title search / track search / time search
 - **Marker**
 - The part on the disc designated by user can be called back.
 - **Repeat**
 - chapter / title / track / group / all / A-B
 - **Program Playback for audio CD, MP3, JPEG and Picture CD**
 - You can program the order of tracks/files to play them back in designated order.
 - **Random Playback for audio CD, MP3, JPEG and Picture CD**
 - This unit can shuffle the order of tracks/files to play them back in randomly.
- ➡ **Accessing from [AUDIO] button**
- During playback**
- **Choices for Audio Language and Stereo Sound Function**
 - Select your desired languages or stereo sound function when different options are available on your disc.
- ➡ **Accessing from [SUBTITLE] button**
- During playback**
- **Subtitles in a Desired Language**
 - You can select a desired language for displaying subtitle, if that language is available on a DVD-video.

✓ Contents

INTRODUCTION

Precautions	3
Supplied Accessories	4
Symbols Used in this Manual	4
Features	5
Remote Control Function	7
Installing the Batteries	7
Control Panel	8
Rear Panel	8

CONNECTION

Basic Connection	9
External Device Connection	10

TV Functions

INITIAL SETTING

Initial Setup	13
Main Menu	13
Auto Channel Scan	14
Language Selection	14

WATCHING TV

Channel Selection	15
Volume Adjustment	15
Still Mode	15
Sleep Timer	15
Switching Each Mode	16
Switching Audio Mode	16
Screen Information	17
TV Screen Display Mode	18

OPTIONAL SETTING

Channel List	19
Manual Register	19
Antenna Confirmation	20
Picture Adjustment	20
Sound Adjustment	21
Closed Caption	22
DTV Closed Caption	23
CC Style	23
V-chip	24
PC Settings	26
HDMI Audio	27
Blue LED	27

DVD Functions

OPERATING DVD

Playable Media	28
About the PBC Function of Video CD	28
Unplayable Media	28
Playback	29
Disc Menu	29
Resume Playback	29
Paused and Step-by-step Playback	29
Fast Forward / Fast Reverse	30
Slow Forward / Slow Reverse	30
Zoom	30
MP3, JPEG Playback	30
Kodak Picture CD	31
Dual Playback	32
Folder Playback	32
Transition Mode	32
Adjustment of Picture Size	32
Search Functions	33
Repeat Playback	34
Repeat A-B Playback	35
Random Playback	35
Programmed Playback	35
On-screen Display	36
Special Settings	37

SETTING DVD

DVD Language Setting	39
DVD Audio Setting	40
Parental Setting	41
Others	42
Reset to the Default Setting	43
Language Code List	43

TROUBLESHOOTING

Troubleshooting Guide	44
-----------------------------	----

INFORMATION

Maintenance	46
Glossary	46
Cable Channel Designations	47
General Specifications	47
Electrical Specification	47
Other Specifications	47

Limited Warranty	Back Cover
------------------------	------------

© 2007 Funai Electric Co., Ltd.

All rights reserved. No part of this manual may be reproduced, copied, transmitted, disseminated, transcribed, downloaded or stored in any storage medium, in any form or for any purpose without the express prior written consent of Funai. Furthermore, any unauthorized commercial distribution of this manual or any revision hereto is strictly prohibited.

Information in this document is subject to change without notice. Funai reserves the right to change the content herein without the obligation to notify any person or organization of such changes.

FUNAI with the  design is a registered trademark of Funai Electric Co., Ltd and may not be used in any way without the express written consent of Funai. All other trademarks used herein remain the exclusive property of their respective owners. Nothing contained in this manual should be construed as granting, by implication or otherwise, any license or right to use any of the trademarks displayed herein. Misuse of any trademarks or any other content in this manual is strictly prohibited. Funai shall aggressively enforce its intellectual property rights to the fullest extent of the law.

✓ Remote Control Function

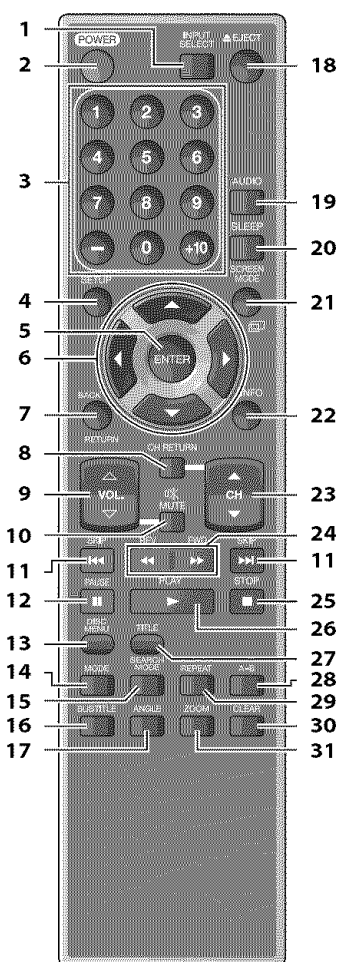

1. **INPUT SELECT button** (p16)
Press to access connected external devices like a DVD recorder or VCR.
2. **POWER button** (p13)
Press to turn the unit on and off.
3. **Number buttons** (p15)
• Press to select channels.
• Press to select chapter, title (DVD), or track/file (CD, MP3) directly.
• **- button**
• Press to shift the minor channel from the major channel.
4. **SETUP button** (p13)
Press to display the main menu.
5. **ENTER button** (p13)
Press to decide the command of setting when the main menu is displayed.
6. **◀/▶/▲/▼ buttons** (p13)
Press to move left/right/up/down through the items.
7. **BACK/RETURN button** (p17)
Press to return to previous menu operation.
8. **CH RETURN button** (p15)
Press to return to previous channel.
9. **VOL. ▲/▼ buttons** (p15)
Press to adjust the volume.
10. **MUTE button** (p15)
Press to turn the sound on and off.
11. **SKIP ◀◀/▶▶ buttons** (p33)
Press to skip forward or backward chapters, titles (DVD), tracks (CD, VCD) or files (MP3, JPEG).
12. **PAUSE button** (p15 / p29)
• **TV mode**
Press to pause screen image.
• **DVD mode**
Press to pause disc playback.
13. **DISC MENU button** (p29)
• Press to call up the menu on a disc.
• Press to call up the file list (MP3/JPEG).
14. **MODE button** (p35)
• Press to call up the folder list on a disc when "DUAL PLAYBACK" is "ON" (MP3, JPEG).
• Press to arrange the playing order or play randomly (CD, MP3, JPEG).
• Press to set black level (DVD, VCD) and virtual surround (DVD, CD, VCD, MP3) on or off.
15. **SEARCH MODE button** (p33)
Press to search chapter, title (DVD), time (DVD, CD, VCD) or track/file (CD, VCD, MP3, JPEG).
16. **SUBTITLE button** (p37)
Press to select subtitles on a disc (DVD).
17. **ANGLE button** (p37)
• Press to change the camera angle to see the sequence being played back from different angle (DVD).
• Press to rotate a picture (JPEG).
18. **EJECT button** (p29)
Press to eject the disc.
19. **AUDIO button** (p16 / p37)
• **Digital mode (DTV)**
Press to select the audio language.
• **Analog mode (TV)**
Press to select audio mode.
• **DVD mode**
Press to select audio language (DVD) or sound mode (CD, VCD).
20. **SLEEP button** (p15)
Press to activate the sleep timer.
21. **SCREEN MODE button** (p18)
Press to select aspect ratios available for the TV screen.
22. **INFO button** (p17 / p36)
• **Digital mode (DTV)**
Press to display the channel information, signal type and TV setting.
• **Analog mode (TV)**
Press to display the channel number, signal type and TV setting.
• **External Input Mode**
Press to display the external input mode, signal type and TV setting.
• **DVD mode**
Press to display the current status (DVD, CD, VCD, MP3, JPEG).
23. **CH ▲/▼ buttons** (p15)
Press to select channels and the external input mode.
24. **REV ◀◀ / FWD ▶▶ buttons** (p30)
Press to begin slow forward or slow reverse playback during the pause mode (DVD, VCD) and search forward or backward through a disc (DVD, CD, VCD, MP3).
25. **STOP button** (p29)
Press to stop disc playback.
26. **PLAY button** (p29)
Press to begin disc playback.
27. **TITLE button** (p30)
Press to call up the title menu (DVD).
28. **A-B button** (p35)
Press to repeat between your designated point A and B (DVD, CD, VCD).
29. **REPEAT button** (p34)
Press to play a chapter or title (DVD), track, disc (CD, VCD, MP3, JPEG) or group (MP3, JPEG) repeatedly.
30. **CLEAR button** (p34)
• Press to clear the numbers entered incorrectly.
• Press to cancel the point A for A-B repeat (DVD, CD, VCD).
• Press to remove track/file number in program input (CD, MP3, JPEG).
31. **ZOOM button** (p30)
Press to magnify a part of picture (2x and 4x: DVD, 2x: VCD, JPEG).

✓ Installing the Batteries

Install the batteries (AA x 2) matching the polarity indicated inside battery compartment of the remote control.

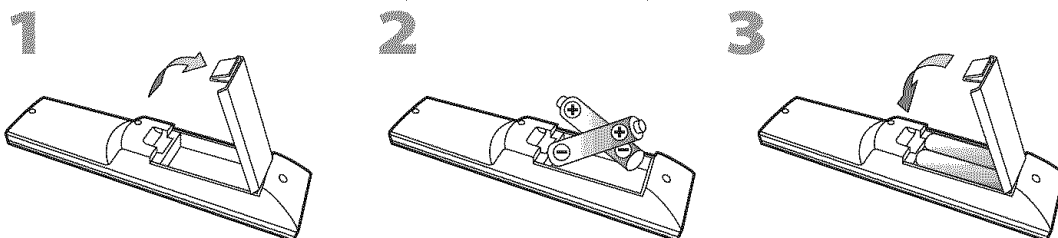

Battery Precautions:

- Be sure to follow the correct polarity as indicated in the battery compartment. Reversed batteries may cause damage to the device.
- Do not mix different types of batteries together (e.g., Alkaline and Carbon-Zinc) or old batteries with fresh ones.
- If the device is not to be used for a long period of time, remove the batteries to prevent damage or injury from possible battery leakage.
- Do not try to recharge batteries; they can overheat and rupture.

Control Panel

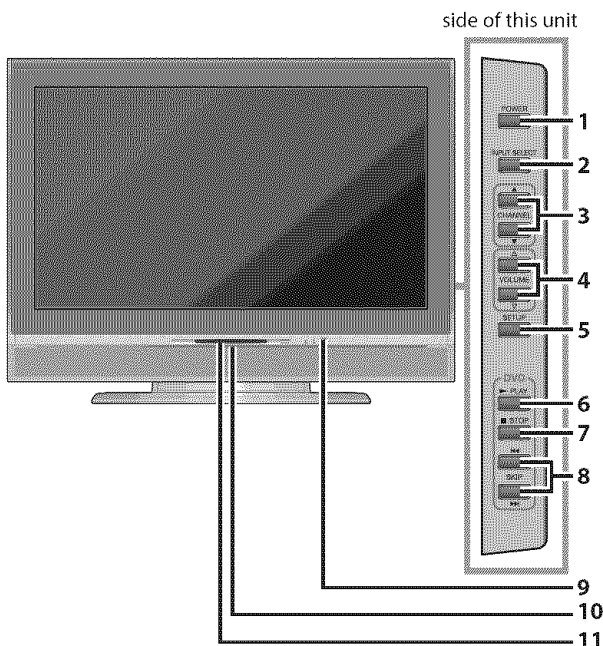

1. **POWER button** (p13)
Press to turn the unit on and off.
2. **INPUT SELECT button** (p16)
 - Press to access connected an external devices like a DVD recorder or VCR.
 - Press to decide the command of setting when the menu is displayed.
3. **CHANNEL ▲/▼ buttons** (p15)
Press to select channels or move up/down through the main menu items.
4. **VOLUME ▲/▼ buttons** (p15)
Press to adjust the volume or move right (▲)/left (▼) through the main menu items.
5. **SETUP button** (p13)
Press to display the main menu.
6. **PLAY ► button** (p29)
Press to begin disc playback.
7. **STOP ■ button** (p29)
Press to stop disc playback.
8. **SKIP ◀◀ / ▶▶ buttons** (p33)
Press to skip forward or backward chapters, titles (DVD) or tracks/files (CD, VCD, MP3, JPEG).
9. **Infrared Sensor Window**
Receives infrared rays transmitted from the remote control.
10. **Blue LED** (p27)
Lights up when the unit is turned on or a disc is inserted.
11. **Disc Loading Slot** (p29)
Insert the disc with label facing up.

Rear Panel

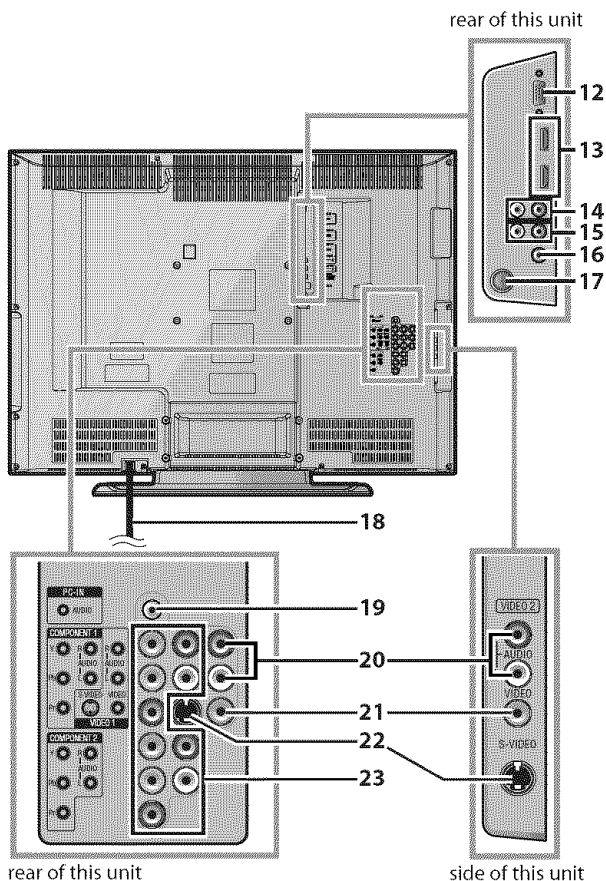

12. **PC-IN jack** (p12)
VGA cable connection for PC.
13. **HDMI IN jacks** (p10)
HDMI connection for an HDMI device.
14. **AUDIO IN jacks** (p10)
RCA audio cable connection for a DVI device. (For HDMI 1-IN jack only)
15. **AUDIO OUT jacks** (p12)
RCA audio cable connection for an external device. Use analog audio input jacks of an external device.
16. **DIGITAL AUDIO OUT (COAXIAL) jack** (p12)
Digital audio coaxial cable connection for a decoder or an audio receiver. Use digital audio input jack of an external device.
17. **ANT. IN jack** (p9)
RF coaxial cable connection for your antenna or cable box.
18. **AC Power Cord**
Connect to a standard AC outlet to supply power to this unit.
19. **PC-IN AUDIO jack** (p12)
Mini-plug audio cable connection for PC. Use line out jack of a PC.
20. **AUDIO input jacks** (p11)
RCA audio cable connection for an external device.
21. **VIDEO input jack** (p11)
RCA video cable connection for an external device.
22. **S-VIDEO input jack** (p11)
S-video cable connection for an external device.
23. **COMPONENT and AUDIO input jacks** (p10)
Component video cable and RCA audio cable connection for an external device. Use component video and audio output jacks of an external device.

Cables not included.

Please purchase the necessary cables at your local store.

✓ Basic Connection

This section describes how to connect the unit to an antenna, cable/satellite box, etc.

Note:

- Be sure your antenna or other device is connected properly before plugging in the power cord.

[Antenna Cable Connection]

When connecting the unit to an antenna or cable TV company (without cable/satellite box)

Connect the RF coaxial cable on your home outlet to the antenna input jack of this unit.

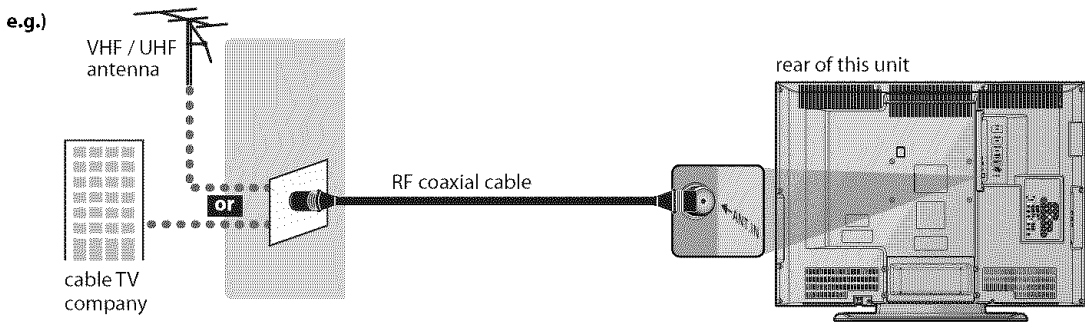

- * Once connections are completed, turn on the unit and begin initial setup. Channel scanning is necessary for the unit to memorize all available channels in your area. (Refer to "Initial Setup" on page 13.)

Note:

- For your safety and to avoid damage to device, please unplug the RF coaxial cable from the antenna input jack before moving the unit.
- If you use an antenna to receive analog TV, it should also work for DTV reception. Outdoor or attic antennas will be more effective than settop versions.
- To easily switch your reception source between antenna and cable, install an antenna selector.
- If you connect to the cable system directly, contact the CATV installer.

[Connection to Cable Box or Satellite Box]

Connect the RF coaxial cable on your home outlet to the input jack of the cable/satellite box.

Use another RF coaxial cable to connect the antenna input jack of the unit to the output jack of the cable/satellite box.

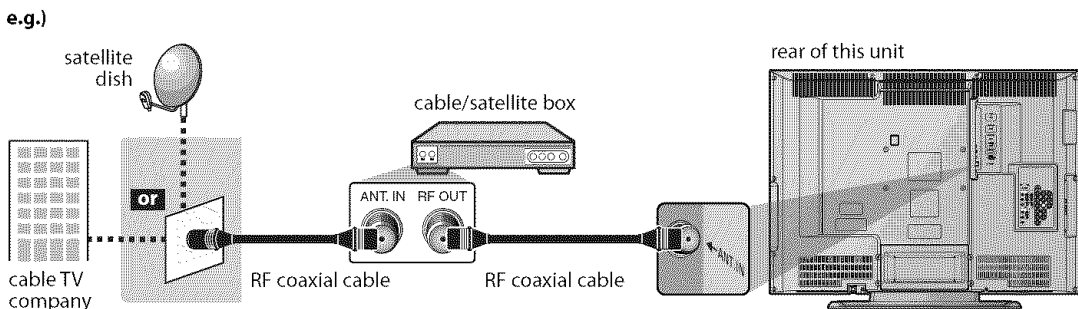

- * Required cables and connecting methods differ depending on the cable/satellite box. For more information, please contact your cable/satellite provider.

Cables not included.

Please purchase the necessary cables at your local store.

External Device Connection

[HDMI Connection]

HDMI (High Definition Multimedia Interface) transports high definition video and multi-channel digital audio through a single cable. It ensures that the content sent from the source to this unit is of the highest possible resolution.

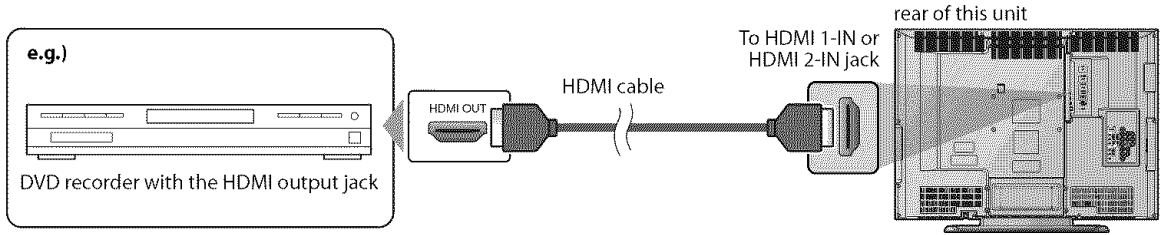

Note:

- This unit accepts 480i / 480p / 720p / 1080i video signals, and 32kHz / 44.1kHz / 48kHz audio signals compliant with EIA-861.
- This unit accepts only 2 channel audio signal (LPCM).
- You need to select "PCM" for the digital audio output of the device connected or the HDMI audio setting. There may be no audio output if you select "Bitstream", etc.

[HDMI-DVI Connection]

If your video device has a DVI output jack, connect using an HDMI-DVI conversion cable. An HDMI-DVI conversion cable requires a separate audio cable connection as well. As such, only the HDMI 1-IN jack can be used.

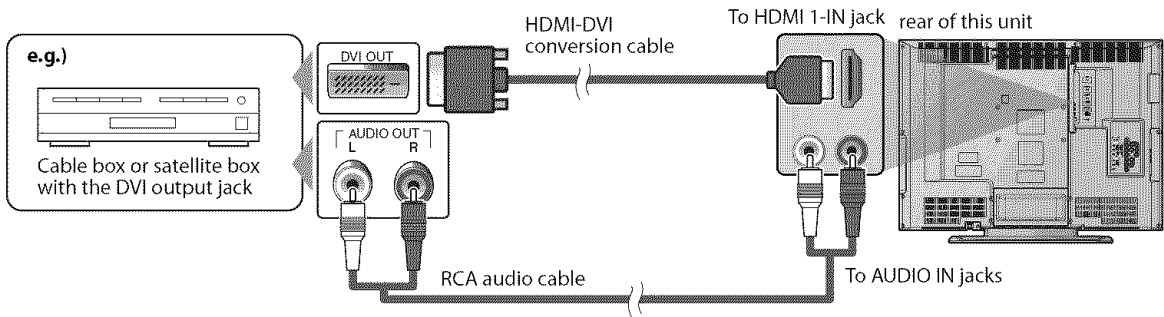

Note:

- This unit accepts 480i / 480p / 720p / 1080i video signals. DVI does not display 480i image that is not compliant with EIA/CEA-861/861B.
- Audio signals are converted from digital to analog for this connection.

[Component Video Cable Connection]

Component video connection offers better picture quality for video devices connected to the unit. Use a component video cable to connect the unit to external video devices equipped with component video output jacks.

If you connect to the unit's COMPONENT 1 or COMPONENT 2 video input jack, connect RCA audio cables to the audio L/R jacks of COMPONENT 1 or COMPONENT 2 accordingly.

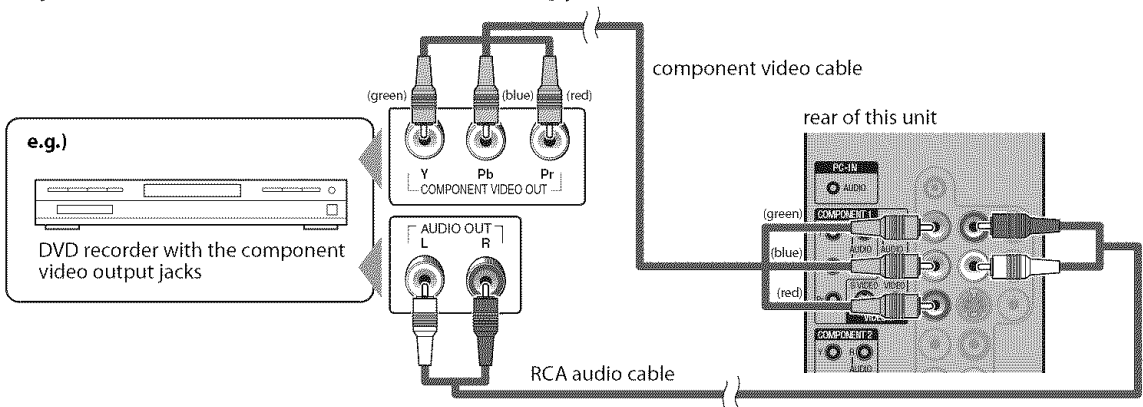

Note:

- This unit accepts 480i / 480p / 720p / 1080i video signals.

Cables not included.

Please purchase the necessary cables at your local store.

[S-video Cable Connection]

S-video connection offers good picture quality for video devices connected to the unit.

Use an S-video cable to connect the unit to external video devices equipped with S-video output jack.

If you connect to the unit's VIDEO 1 or VIDEO 2 S-video input jack, connect RCA audio cables to the audio L/R jacks of VIDEO 1 or VIDEO 2 accordingly.

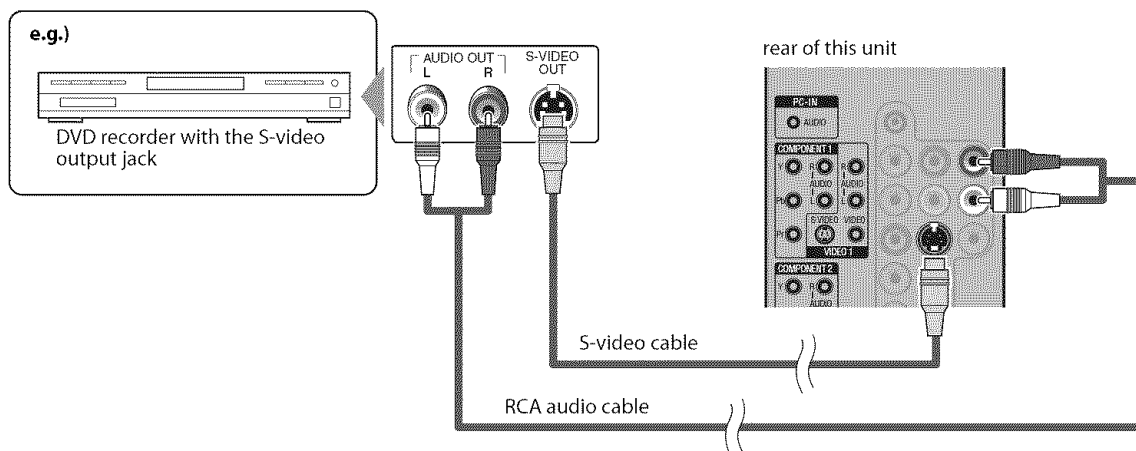
**Note:**

- If you connect to the S-video jack and the video jack at the same time, the S-video connection will have priority.

[Video Connection]

Video connection offers standard picture quality for video devices connected to the unit.

If you connect to the unit's VIDEO 1 or VIDEO 2 input jack, connect RCA audio cables to the audio L/R jacks of VIDEO 1 or VIDEO 2 accordingly.

When the audio jack of the video device is monaural, connect the RCA audio cable to the audio L input jack.

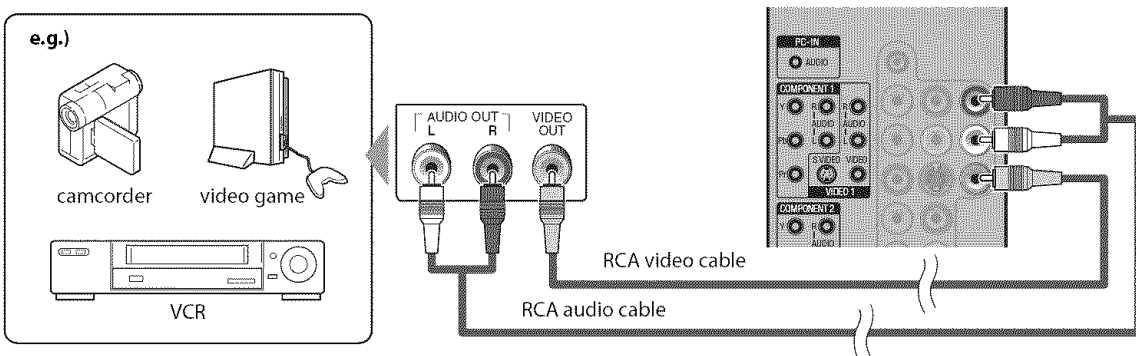
**Note:**

- If you connect to the S-video jack and the video jack at the same time, the S-video connection will have priority.

Cables not included.

Please purchase the necessary cables at your local store.

[Audio Output Connection]

[Digital]

If you connect this unit to an external digital audio device, you can enjoy multi-channel audio like 5.1ch digital broadcasting sound.

[Analog]

If you connect this unit to an external analog audio device, you can enjoy stereo (2 channel) audio.

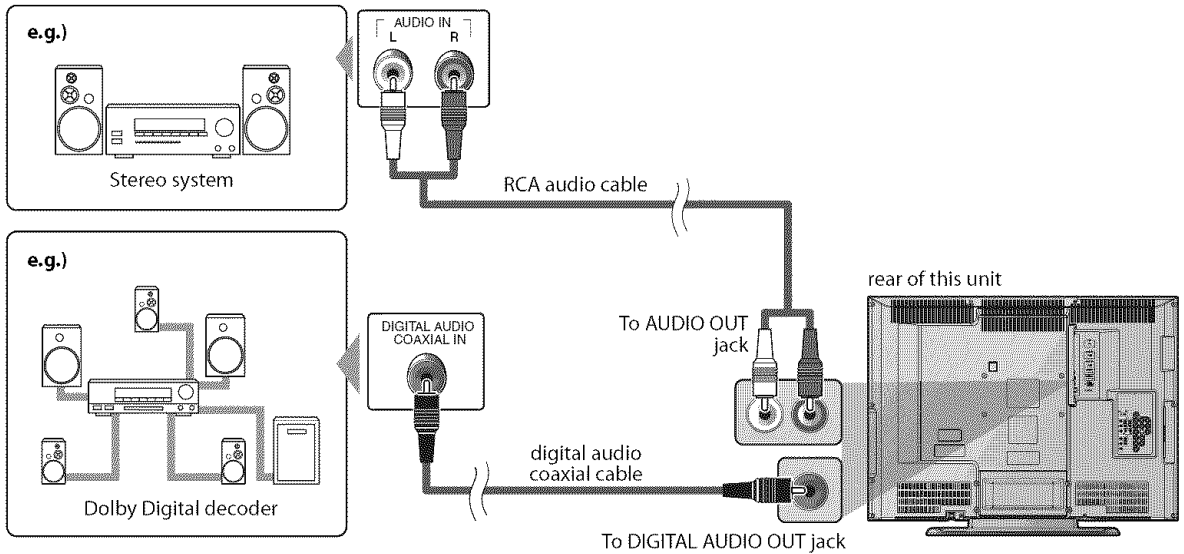

[PC Connection]

This unit is equipped with a PC-IN jack. If you connect this unit to your PC, you can use this unit as a computer monitor.

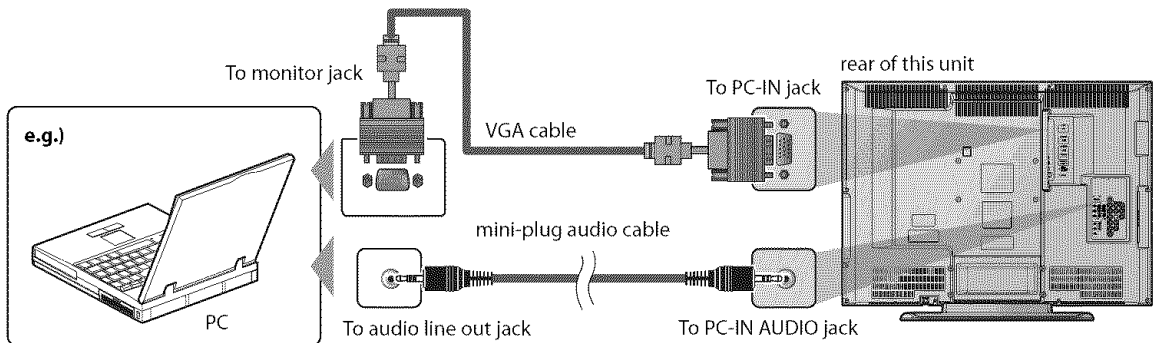

These operations are accessible by remote control. Some may also be accessible by controls on the main unit.

TV Functions

✓ Initial Setup

This section will guide you through the unit's initial setting which includes selecting a language for your on-screen menu and auto channel scan, which automatically scans and memorizes viewable channels.

Before you begin:

Make sure if the unit is connected to antenna or cable.

- 1 After making all the necessary connections, press **[POWER]** to turn on the unit.

POWER



- Starting up the unit take a few moments. Meanwhile, any key input is invalid.

- 2 Use **[Cursor ▲/▼]** to select the on-screen language from the choices on the right side of the TV screen. (English / Español / Français)

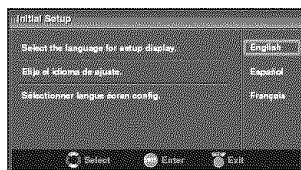

- "Initial Setup" menu on step 3 will be displayed in the selected language after you press **[ENTER]**.

- 3 Use **[Cursor ▲/▼]** to select "Air" for TV channels or "Cable" for CATV channels, then press **[ENTER]**.

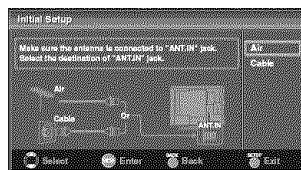

- Scanning and memorizing of channels start automatically.

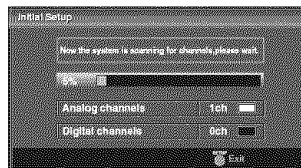

- When the scanning and memorizing are completed, the lowest memorized channel in the broadcasting will be displayed.

Note:

- If you connect the cable system directly, contact the CATV installer.
- If you press **[POWER]** or **[SETUP]** during auto channel scan, this setting will be canceled.
- The initial auto channel scan function can be executed for either "Air" or "Cable" only once. When you change the connection (Air/Cable), set auto channel scan again. (Refer to page 14.)
- You can cancel or exit the initial auto channel scan menu by pressing **[SETUP]**.
- If there is no signal input from the antenna terminal and no operation for several seconds after you turn on the unit, "Helpful Hints" appears. Follow the instructions listed on the TV screen.

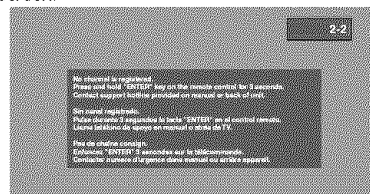

✓ Main Menu

This section describes the overview of the main menu displayed when you press **[SETUP]**. For more details, see the reference page for each item. The main menu consists of the function setting items below.

Press **[SETUP]**.

SETUP



- **EXIT**
To exit settings.
- **PICTURE**
You can adjust the picture quality. (Refer to "Picture Adjustment" on page 20.)
- **SOUND**
You can adjust the sound quality. (Refer to "Sound Adjustment" on page 21.)
- **CHANNEL**
You can automatically scan the viewable channels and remove those that are undesired. (Refer to "Auto Channel Scan" on page 14.)
- **DETAIL**
You can change the display format for closed caption, which displays the dialogue of a TV program or other information across the TV screen. (Refer to "Closed Caption" on page 22.)
Set the viewing limitations. (Refer to "V-chip" on page 24.)
Adjust the position, stability and clarity of the PC screen. (Refer to "PC Settings" on page 26.)

And select the sound input for the HDMI jack if your TV is connected to a HDMI device.
(Refer to "HDMI Audio" on page 27.)

• **LANGUAGE**

You can change the language (English, Spanish, French) displayed on the main menu.
(Refer to "Language Selection" on page 14.)

• **DVD**

You can customize some functions for the disc playback. Make sure the player is in stop mode.
(Refer to "SETTING DVD" section on page 39.)

- When aerial antenna is connected, select "Air".
- When connected to CATV, select "Cable".
- Scanning and memorizing of channels start automatically.

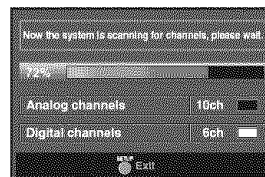

- When the scanning and memorizing are completed, the lowest memorized channel will be displayed.

Note:

- If you connect the cable system directly, contact the CATV installer.
- If you press [POWER] or [SETUP] during auto channel scan, the setting will be canceled.
- Channel settings will be saved even if the power fails.
- If you need the English menus instead of the Spanish or French menus you are having, press [SETUP]. Use [Cursor ▲/▼] to select "IDIOMA" or "LANGAGE", then press [ENTER]. Use [Cursor ▲/▼] to select "English", then press [ENTER]. Press [SETUP] to exit the main menu.
- With regard only to the digital channel, even after the scanning is complete if you unplug the AC power cord before turning off the unit by pressing [POWER], the channel setting may be lost.

✓ Auto Channel Scan

If you switch wires (e.g., between antenna and CATV) or if you move the TV to a different area after the initial setting, or if you restore the DTV channel you deleted, you will need to perform auto channel scan.

Before you begin:

Make sure if the unit is connected to antenna or cable.

- 1 Press [SETUP] to display the main menu.



- 2 Use [Cursor ▲/▼] to select "CHANNEL", then press [ENTER].



- 3 Use [Cursor ▲/▼] to select "Autoscan", then press [ENTER].



Use [Cursor ▲/▼] to select an appropriate option, then press [ENTER].

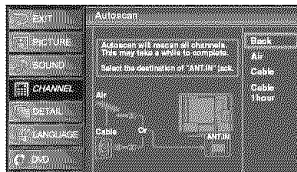

✓ Language Selection

You can choose English, Spanish, or French as your on-screen language.

- 1 Press [SETUP] to display the main menu.



- 2 Use [Cursor ▲/▼] to select "LANGUAGE", then press [ENTER].



- 3 Use [Cursor ▲/▼] to select "English", "Español" or "Français", then press [ENTER].

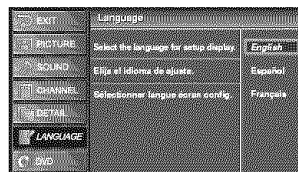

- 4 Press [SETUP] to exit.



✓ Channel Selection

Select channels by pressing [CH ▲/▼] or [the Number buttons].

- To select the memorized channels, use [CH ▲/▼] or [the Number buttons].
- To select the non-memorized channels use [the Number buttons].

To Use [the Number buttons]

TV

- When selecting analog channel 12



DTV

- When selecting digital channel 12-1
Be sure to press [-] before entering the minor channel number.



- Press [CH RETURN] to return to the previously viewed channel.

About digital TV broadcasting:

With its high definition broadcast, digital broadcasting far surpasses analog broadcasting in both its picture and sound quality.

What is the minor channel?

By using high compression technology, digital broadcasting offers a service that enables multiple signals to send simultaneously. Therefore, you can select more than one program per major channel since digital broadcasting technology distinguishes between multiple channels broadcast by a single network.

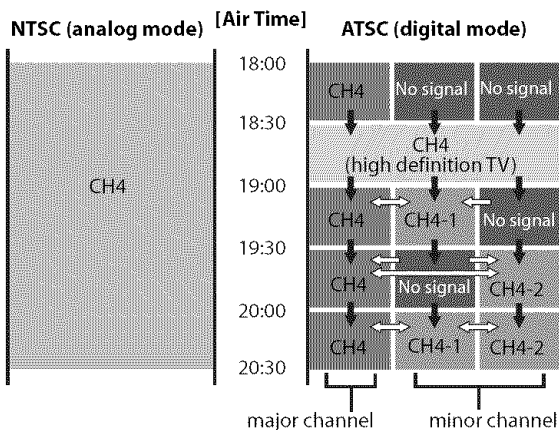

➡ : change automatically

⇨ : change manually by using [CH ▲/▼]

Note:

- "No Signal" will appear on the TV screen after the minor channel broadcast is over.

✓ Volume Adjustment

This section describes how to adjust the volume. The mute function, which turns the sound off and on, is also described.

Use [VOL. ▲/▼] to adjust the audio volume.



- The volume bar will be displayed at the bottom of the TV screen when adjusting the volume.
- The volume bar display will automatically disappear in a few seconds.

Press [MUTE] to turn off and on the sound.



- "Mute" is displayed on the TV screen for a few seconds.

Press [MUTE] again or [VOL. ▲/▼] to recover the original volume.

✓ Still Mode

You can freeze the image shown on the TV screen.

Press [PAUSE] to pause the image shown on the screen.



- The sound output will not be paused.
- If no signal is detected or protected signal is received during still mode, the image remains paused and the sound output will be muted.
- The still function will be released after 5 minutes.

To cancel still mode, press any button except [POWER].

✓ Sleep Timer

The sleep timer can be set to automatically turn off the unit after an incremental period of time.

- 1 Press [SLEEP] to set the sleep timer.



- Sleep timer display appears on the TV screen.

- 2 Press [SLEEP] repeatedly to change the amount of time until shut off.



- You can set your unit to turn off after a set period of time (from 30 to 120 minutes).
- Each press of [SLEEP] will increase the time by 30 minutes.
- After set up, the sleep timer display can be called up for checking by pressing [SLEEP].

To Cancel the Sleep Timer

Press **[SLEEP]** repeatedly until "Sleep Off" is displayed on the TV screen.

Note:

- The sleep timer setting display will automatically disappear in 4 seconds.
- When you disconnect the unit from the AC outlet or when a power failure occurs, the sleep timer setting will be canceled.

Switching Each Mode

You can easily switch with the remote control to the DTV (ATSC) and TV (NTSC) or to access an external device when they are connected to the unit.

Press **[INPUT SELECT]** or **[CH ▲]** repeatedly to cycle through the input modes.

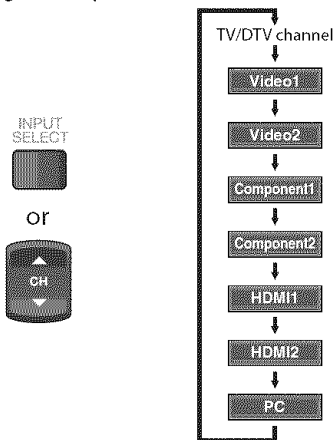

- Pressing **[CH ▼]** reverses the direction of the mode.
- To use the video or S-video input jack of VIDEO 1 on the unit, select "Video1".
- To use the video or S-video input jack of VIDEO 2 on the unit, select "Video2".
- To use the component video input jack of COMPONENT 1 on the unit, select "Component1".
- To use the component video input jack of COMPONENT 2 on the unit, select "Component2".
- To use the HDMI 1-IN jack on the unit, select "HDMI1".
- To use the HDMI 2-IN jack on the unit, select "HDMI2".
- To use the PC-IN jack on the unit, select "PC".

Switching Audio Mode

This section describes how to switch the audio language.

TV

- 1 Press **[AUDIO]** to display the currently selected audio mode. While receiving an MTS broadcast, press repeatedly to cycle through the available audio channel.



When all audio are available



When stereo and monaural audio are available

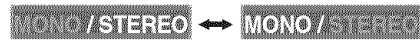

When SAP and monaural audio are available



When only monaural audio is available



STEREO : Outputs stereo-audio

SAP : Outputs second audio program

MONO : Outputs mono-audio

- The current mode will automatically disappear in 4 seconds.

DTV

- 1 Press **[AUDIO]** to display the currently selected language and the number of available languages.



- 2 Press **[AUDIO]** repeatedly to cycle through the available audio languages.

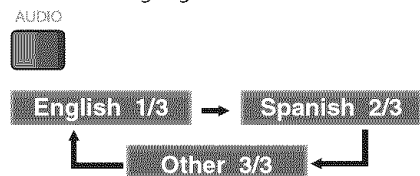

- Available languages differ depending on the broadcast. "Other" is displayed when the audio language cannot be acquired, or the acquired languages are other than English, Spanish or French.
- The current mode will automatically disappear in 4 seconds.

Note:

- Pressing **[AUDIO]** does not control external audio device.

✓ Screen Information

You can display the currently selected channel or other information such as the audio mode on the TV screen.

TV

In the analog mode, the current channel number and the audio mode are displayed.

Press **[INFO]**.



- The current channel number, audio mode, type of resolutions for video signal, TV aspect ratio, CC and TV rating are displayed at the top-right corner of the TV screen.

To clear the display, press **[INFO]** again.

You can also press **[BACK/RETURN]**.

DTV

In the digital mode, the detailed broadcasting information for the current channel such as program title, program guides are displayed.

Press **[INFO]** to display the details of the currently selected program.



[Broadcasting Information]

- The following information is displayed.
 - 1 program title
 - 2 broadcast station
 - 3 program guide
(The program guide added to broadcasting information is displayed. Maximum display of 4 lines.)
 - 4 channel number
 - 5 audio language
(Refer to "Switching Audio Mode" on page 16.)
 - 6 effective scanning lines and scan mode
 - 7 program format
 - 8 program aspect ratio
 - 9 program rating
 - 10 CC (not available if CC is set to "Off")

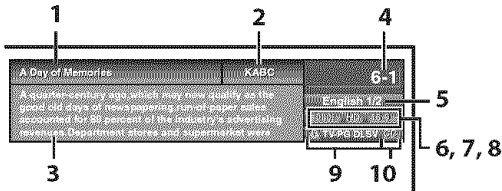

Note:

- When the program guide consists of more than 4 lines, use **[Cursor ▲/▼]** to scroll.
- "No description provided" is displayed when the program guide is not provided.
- While the program guide is displayed, the closed caption function is interrupted.
- In external input mode, the following screen is displayed; e.g.) When an external device is connected to VIDEO 1 input jack.



- The TV screen displays whether the disc is in. e.g.) when the disc is inside:



TV Screen Display Mode

4 types of display modes can be selected when the broadcasting station is sending 4:3 or 16:9 video signal. And 3 types of display modes can be selected for PC input signal.

Press **[SCREEN MODE]** repeatedly to switch the TV aspect ratio.



For 4:3 video signal

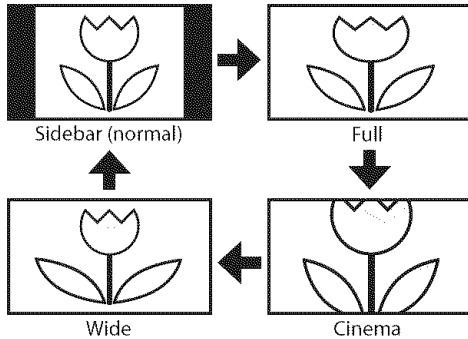

[Sidebar]

Display a 4:3 picture at its original size. Sidebars appear on both edges of the screen.

[Full]

Display a 4:3 picture at a 16:9 size; the picture is stretched horizontally to fill the screen.

[Cinema]

Display a 4:3 picture at a 16:9 size; the picture is stretched horizontally and vertically to fill the screen. This crops out the top and bottom of the picture.

[Wide]

Display the picture with its center at the original size and the edges stretched horizontally.

For 16:9 video signal

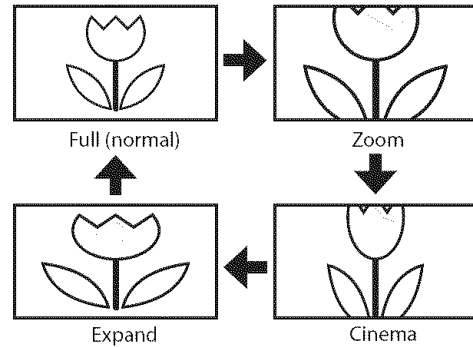

[Full]

Display a 16:9 picture at its original size.

[Zoom]

Display a 16:9 picture at its maximum size without changing its horizontal and vertical ratio.

[Cinema]

Display a vertically stretched picture.

[Expand]

Display a horizontally stretched picture.

For PC input signal

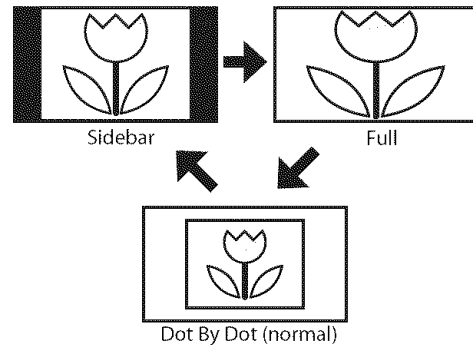

[Sidebar]

Display a proportionately stretched picture. Sidebars appear on both edges of the screen.

[Full]

Display a picture that is stretched out of proportion to fill the screen.

[Dot By Dot]

Display a picture in its original size.

Note:

- You may not switch the display mode depending on the program.
- For PC input signal, "Sidebar" may not be selectable depending on the aspect ratio of the input signal.

✓ Channel List

The channel list function lets you remove undesired channels from the channel registration list.

1 Press **[SETUP]** to display the main menu.



2 Use **[Cursor ▲/▼]** to select "CHANNEL", then press **[ENTER]**.

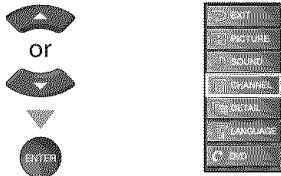

3 Use **[Cursor ▲/▼]** to select "Channel List", then press **[ENTER]**.

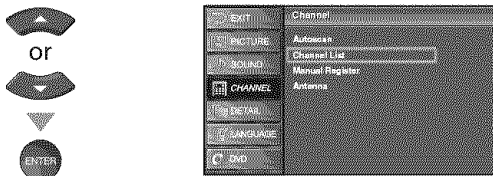

4 Use **[Cursor ▲/▼]** to select the channel you want to remove, then press **[ENTER]**.

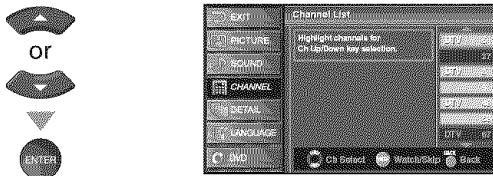

- The channel display for the removed channel darkens. You will not be able to select the channel again using **[CH ▲/▼]**.
- To reactivate a removed channel, highlight it using **[Cursor ▲/▼]** and press **[ENTER]**. The channel display lightens.
- When you remove a major channel, its minor channels are removed as well.

Note:

- The channel with the "DTV" indicated on the display is ATSC. Otherwise the channel is NTSC.

5 Press **[SETUP]** to exit.



✓ Manual Register

The manual register function lets you add the channels that were not added by the auto channel scan due to the reception condition at the initial setting.

1 Press **[SETUP]** to display the main menu.



2 Use **[Cursor ▲/▼]** to select "CHANNEL", then press **[ENTER]**.

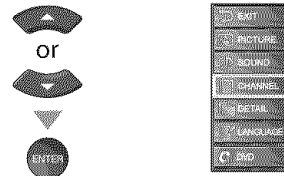

3 Use **[Cursor ▲/▼]** to select "Manual Register", then press **[ENTER]**.

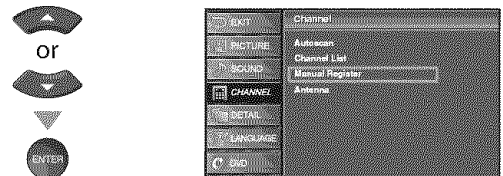

4 Use **[the Number buttons]** to enter the number of the channel you want to add, then press **[ENTER]**.

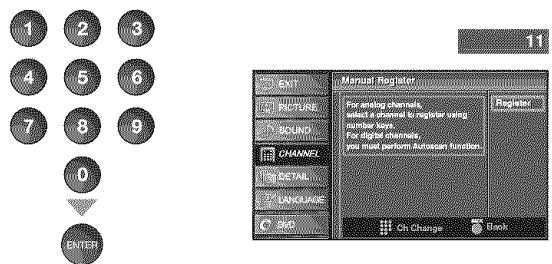

5 Press **[SETUP]** to exit.



Note:

- If set up completes successfully, "Registered to the Channel List" is displayed.
- If external input is used, it is not possible to register the channel and "Unavailable" will be displayed on the TV screen.

Antenna Confirmation

This function lets you check the signal strength of each channel.

1 Press [SETUP] to display the main menu.



2 Use [Cursor ▲/▼] to select "CHANNEL", then press [ENTER].

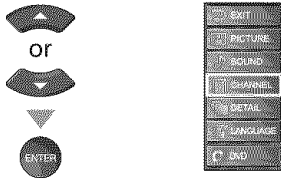

3 Use [Cursor ▲/▼] to select "Antenna", then press [ENTER].

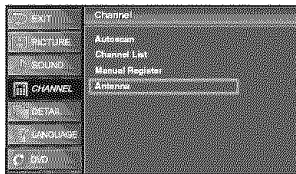

4 Use [the Number buttons] or [CH ▲/▼] to select the channel for which you want to check the signal strength.

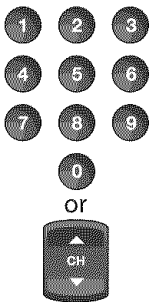

11

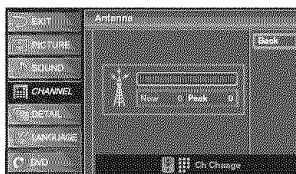

• If the channel is set to external input, you cannot confirm the antenna condition.

Video

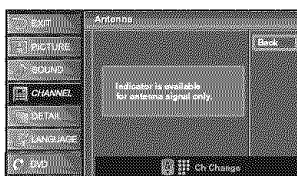

5 Press [SETUP] to exit.



Picture Adjustment

You can adjust brightness, contrast, color, tint and sharpness.

1 Press [SETUP] to display the main menu.



2 Use [Cursor ▲/▼] to select "PICTURE", then press [ENTER].



3 Use [Cursor ▲/▼] to select the item you want to adjust, then press [ENTER].

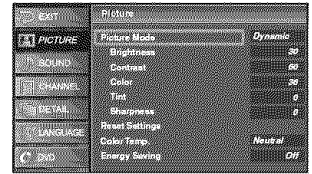

4 Adjust the picture quality.

Picture Mode

Use [Cursor ▲/▼] to select the desired setting, then press [ENTER]. (Standard, Dynamic, Movie and News)

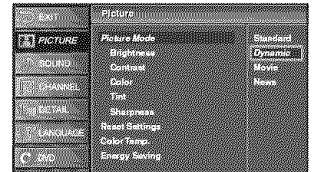

Brightness, Contrast, Color, Tint, Sharpness

Use [Cursor ◀/▶] to adjust.

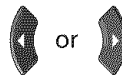

	Cursor ◀	Cursor ▶
Brightness 	to decrease brightness	to increase brightness
Contrast 	to decrease contrast	to increase contrast
Color 	to decrease color	to brighten color
Tint 	to add red	to add green
Sharpness 	to make soft	to make clear

Reset Settings

Use [Cursor ▲/▼] to select "Reset", then press [ENTER] to restore the "Picture Mode" setting to default.

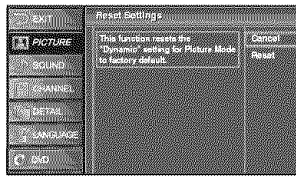

Color Temp.

Use [Cursor ▲/▼] to select the desired setting, then press [ENTER]. (Cool, Neutral and Warm)

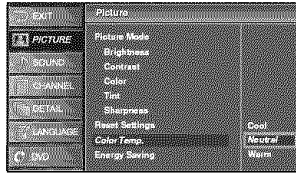

Energy Saving

Use [Cursor ◀/▶] to adjust the brightness of the backlight.

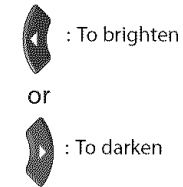

Note:

• To cancel picture adjustment, press [SETUP].

3 Use [Cursor ▲/▼] to select the sound type you want to adjust, then press [ENTER].

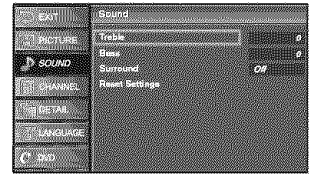

4 Adjust the sound setting.

Treble, Bass

Use [Cursor ◀/▶] to adjust.

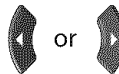

	Cursor ◀	Cursor ▶
Treble 	to decrease higher-pitched sounds	to increase higher-pitched sounds
Bass 	to decrease lower-pitched sounds	to increase lower-pitched sounds

Surround

Use [Cursor ▲/▼] to turn on or off the surround function, then press [ENTER].

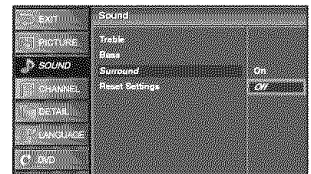

Reset Settings

Use [Cursor ▲/▼] to select "Reset", then press [ENTER] to restore the "Sound" settings to default.

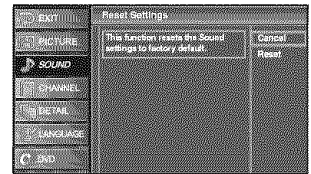

Note:

• To cancel sound adjustment, press [SETUP].

5 Press [SETUP] to exit.



5 Press [SETUP] to exit.



✓ Sound Adjustment

You can adjust treble, bass and surround.

1 Press [SETUP] to display the main menu.



2 Use [Cursor ▲/▼] to select "SOUND", then press [ENTER].



✓ Closed Caption

You can view closed captioning (cc) for TV programs, movies and news. Closed caption refer to text of dialogue or descriptions displayed on-screen for the hearing impaired.

1 Press [SETUP] to display the main menu.



2 Use [Cursor ▲/▼] to select "DETAIL", then press [ENTER].

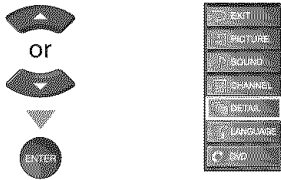

3 Use [Cursor ▲/▼] to select "Closed Caption", then press [ENTER].

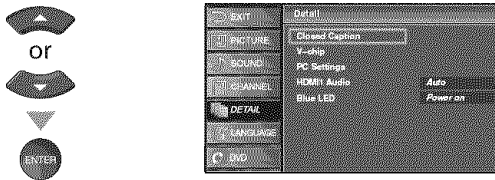

4 Use [Cursor ▲/▼] to select "Conventional CC", then press [ENTER].

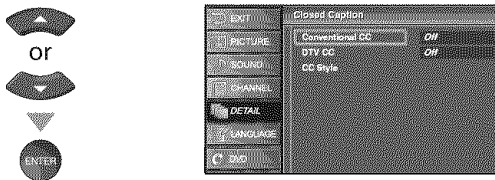

5 Use [Cursor ▲/▼] to select the desired closed caption, then press [ENTER].

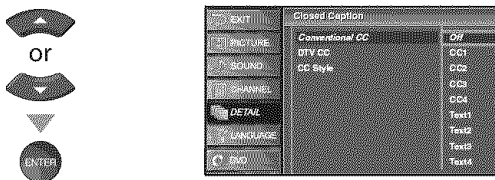

[Caption Mode]

CC1 and Text1;

are the primary caption and text services. The captioning or text is displayed in the same language as the program's dialogue (up to 4 lines of script on the TV screen, where it does not obstruct relevant parts of the picture).

CC3 and Text3;

serve as the preferred data channels. The captioning or text is often a secondary language.

CC2, CC4, Text2 and Text4;

are rarely available and broadcasters use them only in special conditions, such as when "CC1" and "CC3" or "Text1" and "Text3" are not available.

- There are 3 display modes according to programs:

Paint-on mode:

Displays input characters on the TV screen immediately.

Pop-on mode:

Once characters are stored in memory, they are displayed all at once.

Roll-up mode:

Displays the characters continuously by scrolling (max. 4 lines).

6 Press [SETUP] to exit.



Note:

- To show the closed caption on your TV screen, broadcast signal must contain the closed caption data.
- Not all TV programs and commercials have the closed caption or all types of the closed caption.
- Captions and texts may not match the TV voice exactly.
- Changing channels may delay the closed caption for a few seconds.
- Adjusting or muting the volume may delay the closed caption for a few seconds.
- Abbreviations, symbols and other grammatical shortcuts may be used in order to keep pace with the on-screen action. This is not a problem with the unit.
- The caption or text characters will not be displayed while the main menu or functions display is shown.
- If a black box appears on the TV screen, this means that the closed caption is set to TEXT mode. To clear the box, select "CC1", "CC2", "CC3", "CC4" or "Off".
- If the unit receives poor quality television signals, the captions may contain errors, or there might be no captions at all. Some possible causes of poor quality signals are:
 - Automobile ignition noise
 - Electric motor noise
 - Weak signal reception
 - Multiplex signal reception (ghosts or screen flutter)
- The unit retains the closed caption setting if the power fails.
- Closed caption will not be displayed when you are using an HDMI connection.
- When the unit receives a special effects playback signal (i.e., Search, Slow and Still) from a VCR's video output channel (CH3 or CH4), the unit may not display the correct caption or text.

✔ DTV Closed Caption

DTV

In addition to the basic closed caption described on page 22, DTV has its own closed caption called DTV CC. Use this menu to change the settings for DTV CC.

1 Repeat steps 1 and 2 in "Closed Caption" on page 22.

2 Use [Cursor ▲/▼] to select "Closed Caption", then press [ENTER].

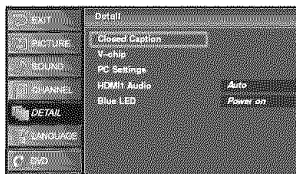

3 Use [Cursor ▲/▼] to select "DTV CC", then press [ENTER].

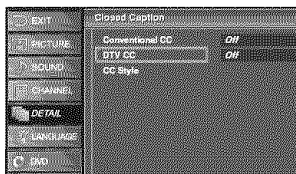

4 Use [Cursor ▲/▼] to select the desired DTV closed caption, then press [ENTER].

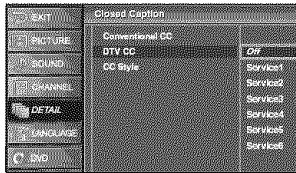

DTV CC	Off	Select if you do not want DTV CC. This is the default.
	Service1~6	Select one of these before changing any other item in "Closed Caption" menu. Choose "Service1" under normal circumstances.

5 Press [SETUP] to exit.



Note:

- "DTV CC" that you can switch differs depending on the broadcast description.

✔ CC Style

You can change the style of CC such as font, color or size, etc.

1 Repeat steps 1 and 2 in "Closed Caption" on page 22.

2 Use [Cursor ▲/▼] to select "Closed Caption", then press [ENTER].

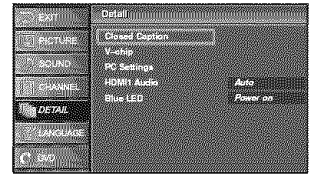

3 Use [Cursor ▲/▼] to select "CC Style", then press [ENTER].

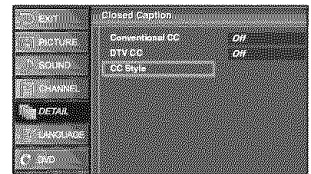

4 Use [Cursor ▲/▼] to select "User Setting", then press [ENTER].

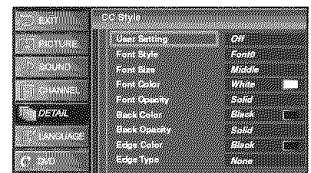

5 Use [Cursor ▲/▼] to select "On", then press [ENTER].



6 Use [Cursor ▲/▼] to select an item, then press [ENTER]. Then use [Cursor ▲/▼] to select the desired setting and press [ENTER].

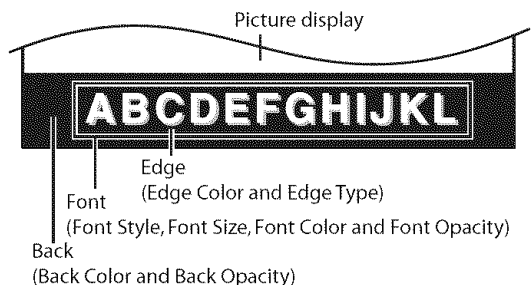

- The setting description for each item is shown below.

[Font Style]

Closed Captioning font style can be changed as below.

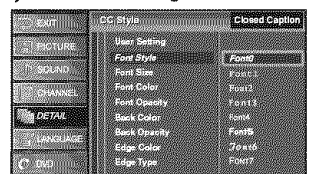

[Font Size]

Font size of the displayed caption can be switched as below.

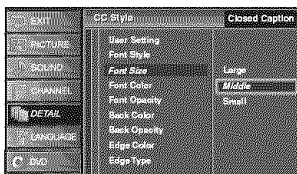

[Font Color]

Font color of the displayed caption can be switched as below.



[Font Opacity]

Font opacity of the displayed caption can be switched as below.



[Back Color]

Background color of the displayed caption can be switched as below.

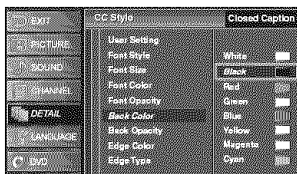

[Back Opacity]

Background opacity of the displayed caption can be switched as below.



[Edge Color]

Edge color of the displayed caption can be switched as below.



[Edge Type]

Edge type of the displayed caption can be switched as below.

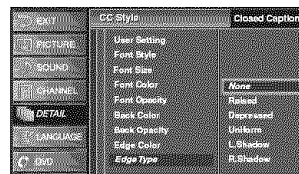

7 Press **[SETUP]** to exit.

SETUP



✓ V-chip

V-chip reads the ratings for programs, then denies access to the programs which exceed the rating level you set. With this function, you can block certain programming inappropriate for children.

1 Repeat steps 1 and 2 in "Closed Caption" on page 22.

2 Use **[Cursor ▲/▼]** to select "V-chip", then press **[ENTER]**.



OR



ENTER



3 Use **[the Number buttons]** to enter the 4-digit numbers for your password.

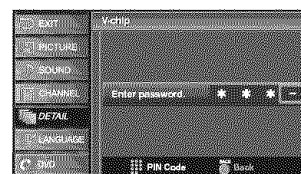
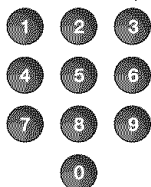

- When you have not set up your password, enter 0000.
- When the password is correct, the "V-chip" menu is displayed.

See the following description for setting each item.

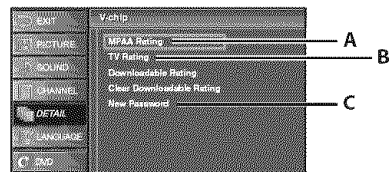

A... "A. MPAA Rating" ⇒ page 25

B... "B. TV Rating" ⇒ page 25

C... "C. New Password" ⇒ page 26

Note:

- When you select a rating and set it to "Block", the higher ratings will be blocked automatically. The lower ratings will be available for viewing.
- When you set the highest rating to "View", all ratings turn to "View" automatically.
- To block any inappropriate programming, set your limits in "MPAA Rating", "TV Rating" and "Downloadable Rating".
- The V-chip setting will be retained after a power failure (except the access code reverts to 0000).
- If the rating is blocked,  will appear.
- "Downloadable Rating" will be available when the unit receives a digital broadcast using the new rating system.
- If the broadcasting signal does not have the downloadable rating information, "Downloadable Rating is currently not available." will appear. This message will also appear when you try to access "Downloadable Rating" after you have cleared the downloadable rating information, and the new information has not been downloaded since.
- To clear the downloadable rating information and its setting, select "Clear Downloadable Rating".

Note:

- Changing the category to "Block" or "View" automatically changes all its sub ratings to the same ("Block" or "View").

A. MPAA Rating

MPAA Rating is the rating system created by MPAA (Motion Picture Association of America).

4 Use [Cursor ▲/▼] to select "MPAA Rating", then press [ENTER].

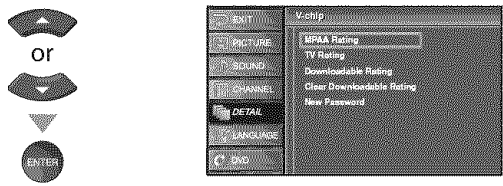

5 Use [Cursor ▲/▼] to select the desired rating, then press [ENTER] repeatedly to switch between "View" and "Block".

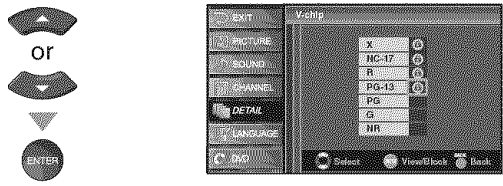

Rating	Category
X	Mature audience only
NC-17	No one under 17 admitted
R	Restricted; under 17 requires accompanying parent or adult guardian
PG-13	Unsuitable for children under 13
PG	Parental guidance suggested
G	General audience
NR	No rating

6 Press [SETUP] to exit.



B. TV Rating

4 Use [Cursor ▲/▼] to select "TV Rating", then press [ENTER].

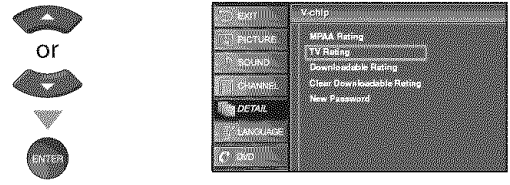

5 Use [Cursor ▲/▼/◀/▶] to select the desired rating, then press [ENTER] repeatedly to switch between "View" and "Block".

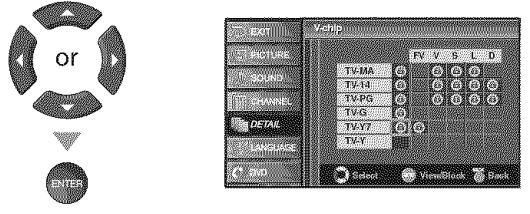

6 Press [SETUP] to exit.



[To Set the Sub Ratings]

As for TV-MA, TV-14, TV-PG, or TV-Y7, you can further set the sub ratings to block specific elements of programming. To set the sub ratings, follow the step below.

Use [Cursor ▲/▼/◀/▶] to select the desired rating, then press [ENTER] repeatedly to switch between "View" and "Block".

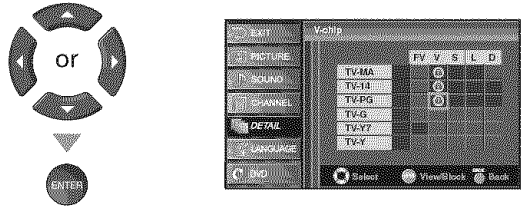

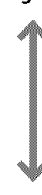
Rating	Category	
TV-MA	Mature audience only	higher  lower
TV-14	Unsuitable for children under 14	
TV-PG	Parental guidance suggested	
TV-G	General audience	
TV-Y7	Appropriate for all children 7 and older	
TV-Y	Appropriate for all children	

Sub Rating	Category	Rating
FV	Fantasy Violence	TV-Y7
V	Violence	TV-PG
S	Sexual Situation	TV-14
L	Coarse Language	TV-MA
D	Suggestive Dialogue	TV-PG, TV-14

Note:

- Blocked sub rating will appear beside the main rating category in "TV Rating" menu.
- You cannot block a sub rating (D, L, S or V) if the main rating is set to "View".
- Changing the category to "Block" or "View" automatically changes all its sub ratings to the same ("Block" or "View").

New Password

Although the default code "0000" is supplied with the unit, you can set your own password.

4 Use [Cursor ▲/▼] to select "New Password", then press [ENTER].

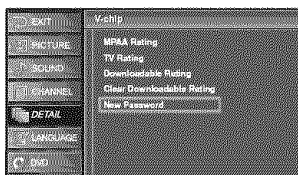

5 Press [the Number buttons] to enter the new 4-digit password.

- Enter password again in "Confirm password." entry field.

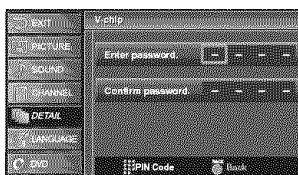
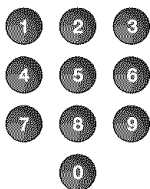

6 Press [SETUP] to exit.



Note:

- Make sure new password and confirm password must be exactly the same. If they are different, the space is cleared for reentering.
- Your password will be erased and return to the default (0000) when a power failure occurs. If you forget the password, unplug the power cord for 10 seconds to restore the password to 0000.

PC Settings

This function lets you adjust the PC screen position, clock and phase during PC input.

1 Repeat steps 1 and 2 in "Closed Caption" on page 22.

2 Use [Cursor ▲/▼] to select "PC Settings", then press [ENTER].

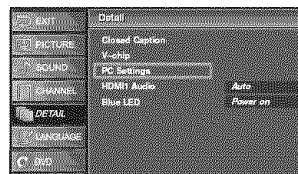

3 Use [Cursor ▲/▼] to select the setting you want to adjust, then press [ENTER].

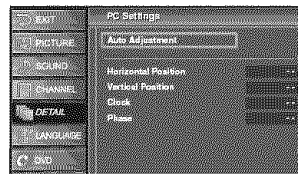

4 Adjust the setting.

Auto Adjustment

Use [Cursor ▲/▼] to select "Adjust", then press [ENTER].

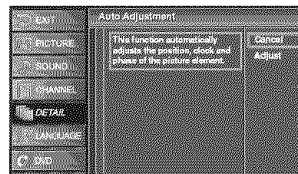

- The Horizontal/Vertical position, clock and phase of the PC screen are automatically adjusted.

Horizontal Position, Vertical Position

Use [Cursor ◀/▶] to adjust.

	Cursor ◀	Cursor ▶
Horizontal Position 	to move PC screen left	to move PC screen right
Vertical Position 	to move PC screen down	to move PC screen up

Clock, Phase

Use [Cursor ◀/▶] to adjust the "Clock" setting to stabilize the PC screen and the "Phase" setting to improve the clarity of the PC screen.

	Cursor ◀	Cursor ▶
Clock 	to decrease setting value	to increase setting value
Phase 		

5 Press [SETUP] to exit.



Note:

- Adjust the "Phase" setting after the "Clock" setting has been properly adjusted.
- You may not obtain an appropriate screen with auto adjustment for some signals. In this case, adjust the settings manually.

✓ HDMI Audio

You can set the method of sound input for the HDMI 1-IN jack.

1 Repeat steps 1 and 2 in "Closed Caption" on page 22.

2 Use [Cursor ▲/▼] to select "HDMI1 Audio", then press [ENTER].

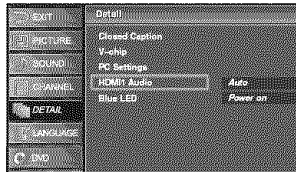

3 Use [Cursor ▲/▼] to select the desired sound input, then press [ENTER].

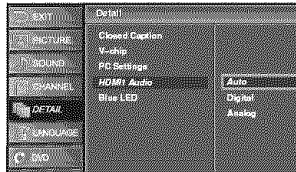

HDMI1 Audio	Auto	Select if you have connected both digital device to the HDMI 1-IN jack and analog device to the audio sources. Digital audio input signal will have priority.
	Digital	Select if you have connected digital device to the HDMI 1-IN jack for digital audio input signal.
	Analog	Select if you have connected analog device to the analog audio jacks for analog audio input signal.

4 Press [SETUP] to exit.



✓ Blue LED

You can set the blue LED on the front panel to light up when the unit is turned on or when a disc is inserted.

1 Repeat steps 1 and 2 in "Closed Caption" on page 22.

2 Use [Cursor ▲/▼] to select "Blue LED", then press [ENTER].

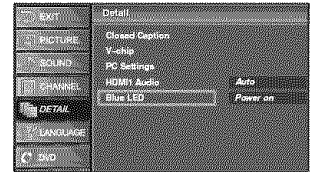

3 Use [Cursor ▲/▼] to select the desired setting, then press [ENTER].

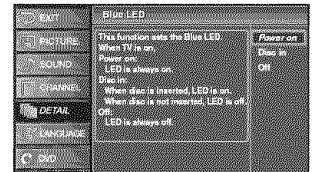

Blue LED	Power on	Lights up while the unit is turned on.
	Disc in	Lights up when a disc is inserted. Lights off when there is no disc.
	Off	Turns off the Blue LED.

4 Press [SETUP] to exit.



DVD Functions

✓ Playable Media

Type of media	Mark (logo)	Region code	Recorded signals	Media size	Disc types	
DVD-video *1, 2, 4, 6, 10, 11			digital video (MPEG2)	5 inches (12 cm)		
DVD-RW DVD-R *1, 3, 4, 5, 6, 7, 8, 9, 10		—				
DVD+RW DVD+R *1, 4, 5, 6, 9, 10		—				
audio CD *4, 6, 10		—	digital audio		audio CD or video CD	
video CD *4, 6, 10		—	digital video (MPEG1)		video CD	
CD-RW CD-R *4, 5, 6, 9, 10		—	digital audio or MP3 or JPEG		MP3 or JPEG	
Kodak Picture CD *4, 5, 6, 9, 10		—	JPEG	Kodak Picture CD		

DVD is a trademark of DVD Format/Logo Licensing Corporation.

If you cannot play back a disc which bears one of the marks above, check the following notes.

- *1: This unit conforms to the NTSC color system. Discs recorded in other color system such as PAL cannot be played back.
- *2: Certain DVD-video do not operate as described in this manual due to the intentions of the disc's producers.
- *3: Discs recorded in VR (video recording) format cannot be played back.
- *4: Scratched or stained discs may not be played back.
- *5: Some discs cannot be played back because of incompatible recording conditions, characteristics of the recorder or special properties of discs.
- *6: You can play back discs which bear the marks above. If you use non-standardized discs, this unit may not play them back. Even if they are played back, the sound or video quality will be compromised.
- *7: You may playback the unfinalized DVD-RW/R recorded in the video format on our brand's DVD recorder. However, depending on the recording status of a disc, the disc may not be played back at all or normally (the picture or sound may not be smooth, etc.). In this case, you need to finalize the disc with the DVD recorder. Refer to the manual accompanying the DVD recorder.
- *8: Only the discs recorded in the video mode and finalized can be played back. Unfinalized discs cannot be played back. Depending on the recording status of a disc, the disc may not be played back at all or the picture or sound may not be smooth, etc.
- *9: If the recorded portion of the disc is too small (less than 55 mm across), it may not play back properly.
- *10: Do not glue paper or put stickers on to the disc. These may damage the disc, and the unit may not read it correctly.
- *11: The number inside the symbol refers to a region of the world and a disc encoded in a specific region format can only be played back on unit with the same region code.

✓ About the PBC Function of Video CD

This unit conforms to ver.1.1 and ver.2.0 of video CD standard, with PBC function.

Ver.1.1 (without PBC function): You can enjoy playback picture as well as music CD.

Ver.2.0 (with PBC function): When using a video CD with PBC function, "PBC" appears on the TV screen.

✓ Unplayable Media

- **NEVER play back the following discs. Otherwise, malfunction may result!**
3 inch (8 cm) disc, DVD-RAM, DVD-audio, CD-i, photo CD, DVD with region codes other than 1 or ALL, DTS-CD, DVD-ROM for personal computers, CD-ROM for personal computers
- **On the following disc, the sound MAY NOT be heard.**
super audio CD

Note:

- Never insert a disc which is broken or abnormal shape (other than 5 inch (12 cm) round disc)
- Do not use a single CD adaptor which make 3 inch (8 cm) to 5 inch (12 cm) disc.
- For super audio CD, only the sound recorded on the normal CD layer can be delivered. The sound recorded on the high density super audio CD layer cannot be delivered.

- **Any other discs without compatibility indications**

These operations are accessible by remote control. Some may also be accessible by controls on the main unit.

✓ Playback

DVD CD VCD

MP3 JPEG on page 30)

Before you begin:

Turn on the amplifier and any other equipment which is connected to this unit. Make sure the external audio receiver (not included) are set to the correct channel.

- 1 Press **[POWER]** to turn on the unit.

POWER



- 2 Insert a disc with label facing up.

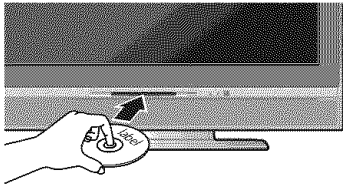

- In case the DVD was recorded on both sides, make sure the label of the side you want to play back is facing up.

- 3 The unit switches to the DVD mode when the unit was in TV mode and detects the type of disc.

e.g.) DVD



- Press **[PLAY ▶]** if the unit does not go to the DVD mode.

- 4 The disc starts playback.



- If playback does not start automatically, press **[PLAY ▶]** again.

- 5 Press **[STOP ■]** to stop playback temporarily.

STOP



- If playback remains stopped for 5 minutes, the screen saver program will activate automatically.

- 6 Press **[EJECT ▲]** to eject the disc.

▲EJECT



Note:

- When you play back CD-RW/-R with MP3 or JPEG files, details on page 30.
- A "⊘" may appear at the top-right on the TV screen when the operation is prohibited by the disc or this unit.
- Some DVD may start playback from title 2 or 3 due to specific programs.
- During the playback of a 2-layered disc, pictures may stop for a moment. This happens while the 1st layer is being switched to the 2nd layer. This is not a malfunction.

✓ Disc Menu

DVD VCD

Some discs contain disc menus which describe the contents of the disc or allow you to customize disc playback, or title menu which lists the titles available on the DVD.

Press **[DISC MENU]** and, use **[Cursor ▲ / ▼ / ◀ / ▶]** to select an item, then press **[ENTER]** (or **[PLAY ▶]**).

Note:

- Menu operations may vary depending on the disc. Refer to the manual accompanying the disc for more details.

Cancelling the PBC (for playback of a video CD)

- 1 Insert a video CD. (Playback will start automatically.)
- 2 Press **[STOP ■]**.
- 3 Enter track number of your choice with **[the Number buttons]**.
- 4 PBC is now cancelled and the playback of the video CD will start.

To call back PBC function, press **[STOP ■]** twice, and then press **[PLAY ▶]**.

- The title menu will appear.

✓ Resume Playback

DVD CD VCD MP3 JPEG

w/o PBC

Press **[STOP ■]** during playback. e.g.) DVD

Resume message will appear on the TV screen.

Press **[PLAY ▶]**. Playback will resume from the point at which playback was stopped.

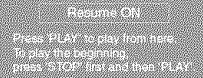

Note:

- To cancel resume information, press **[STOP ■]** again in the stop mode.
- The resume information will be kept even when unit is in standby mode. For MP3 and JPEG, playback will resume from the beginning of the file at which playback was stopped.

✓ Paused and Step-by-step Playback

DVD CD VCD MP3 JPEG

Press **[PAUSE III]** during playback.

- Playback will be paused and sound will be muted.
- Press **[PAUSE III]** once during dual/folder playback to pause a JPEG file only. Press **[PAUSE III]** one more time to pause an MP3 file.

To continue playback, press **[PLAY ▶]**.

DVD VCD

Each time you press **[PAUSE III]** in the pause mode, the disc goes forward one frame at a time.

To continue playback, press **[PLAY ▶]**.

Note:

- Set "STILL MODE" to "FIELD" in the "OTHERS" menu if pictures in the pause mode are blurred. (Refer to page 42.)

Fast Forward / Fast Reverse

DVD

CD

VCD

MP3

Press **[FWD ►►]** or **[REV ◀◀]** repeatedly during playback to select the required forward or reverse speed. To continue playback, press **[PLAY ►]**.



Note:

- Set "STILL MODE" to "FIELD" in the "OTHERS" menu if pictures in the fast playback mode are blurred. (Refer to page 42.)
- Fast forward / fast reverse speed is varies with disc. Approximate speed is 1(2x), 2(8x), 3(20x), 4(50x) and 5(100x) on DVD and 1(2x), 2(8x) and 3(30x) on audio CD, video CD and MP3.
- For DVD and video CD, sound will be muted during the search.
- For audio CD and MP3, sound will be intermittent during the search.

Slow Forward / Slow Reverse

DVD

VCD

Press **[FWD ►►]** or **[REV ◀◀]** repeatedly during the paused mode to select the required forward or reverse speed. To continue playback, press **[PLAY ►]**.



Note:

- Slow forward/slow reverse speed varies with disc. Approximate speed is 1(1/16x), 2(1/8x) and 3(1/2x).
- Set "STILL MODE" to "FIELD" in the "OTHERS" menu if pictures in the slow playback mode are blurred. (Refer to page 42.)
- You cannot playback video CD in reverse slow motion.

Zoom

DVD

VCD

JPEG

The zoom function allows you to enlarge the video image and to pan through the enlarged image.

1 During playback, press **[ZOOM]**.

ZOOM

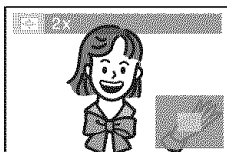

- The picture becomes twice as large.

2 Press **[ZOOM]** repeatedly to change the zoom factor, "2x" or "4x".

ZOOM

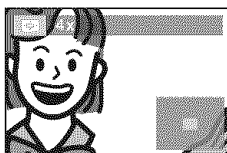

3 Once a desired zoom factor is set, use **[Cursor ▲ / ▼ / ◀ / ▶]** to slide the zoomed picture across the TV screen.

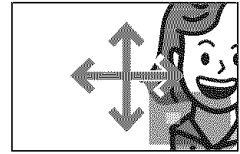
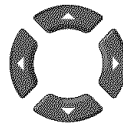

4 Press **[ZOOM]** repeatedly to exit zoom mode.

ZOOM



Note:

- Zoom function does not work while the disc menu is displayed.
- 4x zoom is not available on some discs.
- Only 2x zoom is available on video CD and JPEG files.
- Zoom function is also available during pause mode.
- Position guide is not available for JPEG files.

MP3, JPEG Playback

MP3

JPEG

MP3 or JPEG is a method of compressing files. You can copy MP3 or JPEG files on CD-RW/-R from the personal computer and play back the files on this unit.

1 Insert an CD-RW/-R with MP3 or JPEG files, playback starts automatically.

- Press **[PLAY ►]** if the disc is already inserted.
- Press **[DISC MENU]** when you want to call up the file list.

When selecting the folder:

- Press **[Cursor ►]** when you want to go to the next hierarchy.

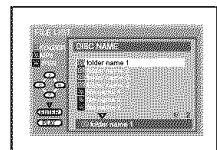
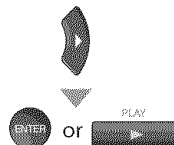

- Press **[Cursor ◀]** when you want to go back to the previous hierarchy (except for the top hierarchy).
- If **[TITLE]** is pressed when a file list is displayed, the 1st item in the top hierarchy will be highlighted.
- Press **[DISC MENU]** or **[BACK/RETURN]** to go back to playback display.



2 Press **[STOP ■]** once to stop playback temporarily.

STOP



- Refer to "Resume Playback" on page 29.

Note:

- A file with an extension of ".mp3 (MP3)" is called an "MP3 file".
- A file with an extension of ".jpg (JPG)" or ".jpeg (JPEG)" is called a "JPEG file".
- Some selections may take a while to be recognized.
- Folders are known as Groups; files are known as Tracks.
- Folders, MP3 files and JPEG files are displayed respectively as ,  and .
- A maximum of 255 folders or 999 files may be recognized in one disc.
- Up to 8 hierarchies can be recognized in one folder. Files in the 9th or deeper hierarchies cannot be played back.
- This unit can play back images and sounds from data recorded in MP3 and JPEG files on CD-RW/-R.
- The unit can run an image file conforming to the Exif specification. Exif is a file format, Exchangeable Image File format established by Japanese Electronic Industry Development Association (JEIDA).
- Files whose extension is other than ".mp3 (MP3)", ".jpg (JPG)" and ".jpeg (JPEG)" will not be listed in the file list.
- If the file is not recorded in MP3 or JPEG format, noise may be produced even if the file extension is either ".mp3 (MP3)", ".jpg (JPG)" or ".jpeg (JPEG)".
- The name of folder and file can be displayed in up to 25 characters. Unrecognizable characters will be replaced with asterisks.
- Unplayable folders or files may be displayed depending on the recording conditions.
- Progressive JPEGs (JPEG files saved in the progressive format) will not be played back on this unit.
- If a folder is selected, press [Cursor ▲/▼] to select a desired folder, then press [Cursor ►], [PLAY ►] or [ENTER] to select a file.

✓ Kodak Picture CD

JPEG

The unit can also run JPEG files stored on Kodak Picture CD. The Picture CD is a service to convert photographs taken by a conventional film camera into digital data and write the data on a CD. The user can enjoy picture images on the television set by playing back the Picture CD.

For details of Kodak Picture CD, contact a shop that deal with developing service of Kodak Inc.

1 Press [DISC MENU], when you want to call up the file.

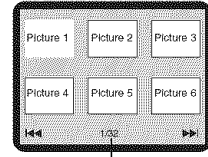

Current file number / the number of total files

- If all menu items cannot be displayed in the screen scope, "▶▶▶" appears at the right bottom of the screen, indicating that the user can view remaining items on the next page. "◀◀◀" appears, it indicates that the user can view other items on the previous page. The file number of the currently highlighted item and the total files are shown at the center bottom of the screen.
- If "▶▶▶" is shown at the right bottom, press [SKIP ▶▶▶] to view the next page. If "◀◀◀" is shown at the left bottom, press [SKIP ◀◀◀] to view the previous page.
- It may take some time until all menu items are displayed on the menu screen.

2 Use [Cursor ▲ / ▼ / ◀ / ▶] to select a desired file, then press [ENTER] (or [PLAY ►]).

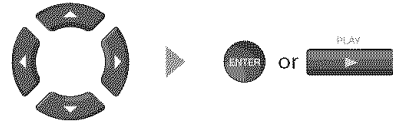

- If a Kodak Picture CD file is selected, an image will be played back from the selected file and go to the next one in turn.

Note:

- A file is displayed for 5 seconds and then the next file is displayed.
- Every press on [ANGLE] will turn the image clockwise by 90 degrees when an image is displayed.

This unit recommends the files recorded under the following circumstances:

Applicable MP3 file	Remarks
Sampling frequency: 44.1 kHz or 48 kHz	For MP3 file recorded in variable bit rate (VBR), the unit may not display the actual elapsed time.
Constant bit rate: 32 kbps ~ 320 kbps	
Applicable JPEG file	Remarks
Normal playback Upper limit: 6,300 x 5,100 dots Lower limit: 32 x 32 dots File size: Max. 7 MB	A JPEG image that extends beyond the TV screen is reduced so that it will be displayed within the TV screen.
Dual playback Upper limit: 5,000 x 5,000 dots Lower limit: 32 x 32 dots File size: Max. 5 MB	

✓ Dual Playback

MP3

JPEG

This function lets you play back MP3 and JPEG files simultaneously. Available only when "DUAL PLAYBACK" is "ON". See page 42 on how to set "DUAL PLAYBACK" "ON" or "OFF".

1 Press [PLAY ▶], then press [DISC MENU].

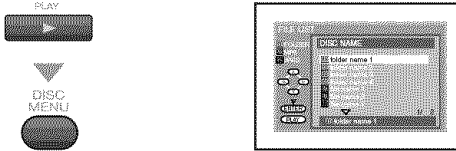

2 When playing back an MP3 file, use [Cursor ▲ / ▼] to select a desired JPEG file from the file list, then press [ENTER] (or [PLAY ▶]).

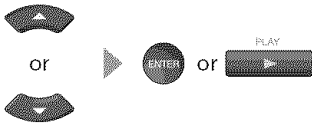

• When playing back a JPEG file, select an MP3 file.

Note:

- To cancel dual playback, press [DISC MENU] again at step 1.
- If you press [PLAY ▶] directly after you inserted a disc which contains both MP3 and JPEG files and if "DUAL PLAYBACK" is set to "ON", dual playback will start automatically.
- If you press [FWD ▶▶] or [REV ◀◀] during dual playback, a JPEG file will be paused.
- Zooming or rotating a JPEG file during dual playback may cause an intermittent sound.
- Depending on the data size of each file, dual playback may not function properly. (Refer to "Applicable JPEG file" on page 31.)

✓ Folder Playback

MP3

JPEG

This function lets you play back all the files and tracks contained in one selected folder automatically. Available only when "DUAL PLAYBACK" is "ON".

If the folder contains both MP3 and JPEG files, dual playback will begin automatically within that folder. See page 42 on how to set "DUAL PLAYBACK" "ON" or "OFF".

1 Press [STOP ■], then press [MODE].

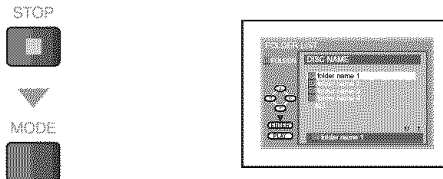

2 Use [Cursor ▲ / ▼] to select a desired folder from the folder list, then press [ENTER] (or [PLAY ▶]).

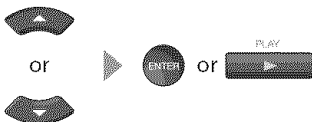

Note:

- To cancel folder playback, press [MODE] again at step 1.
- If you press [FWD ▶▶] or [REV ◀◀] during folder playback, a JPEG file will be paused.
- Zooming or rotating a JPEG file during folder playback may cause an intermittent sound.
- Depending on the data size of each file, folder playback may not function properly. (Refer to "Applicable JPEG file" on page 31.)

✓ Transition Mode

JPEG

You can switch to the transition mode for JPEG files during playback.

1 Press [PLAY ▶], then press [MODE] repeatedly until "CUT IN/OUT" appears.

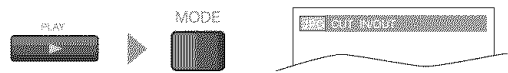

2 Use [ENTER] or [Cursor ◀ / ▶] to select a desired setting.

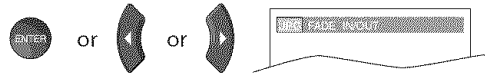

- CUT IN/OUT :** The entire image appears in one time.
- FADE IN/OUT :** The image appears gradually and then disappears.

3 Press [BACK/RETURN] to exit.



Note:

- The transition mode cannot be switched when it is stopped, or from the file list.
- The default setting is "CUT IN/OUT".

✓ Adjustment of Picture Size

JPEG

When the overall picture cannot be displayed and the edge of the picture is cut off, you can adjust the size of the JPEG playback image on TV screen.

1 Press [PLAY ▶], then press [MODE] repeatedly until "NORMAL" appears.



2 Use [ENTER] or [Cursor ◀ / ▶] to select a desired setting.



- NORMAL :** To display the image at 100% of the picture size.
- SMALL :** To display the image at 95% of the picture size.

Using [SKIP |◀◀, ▶▶|]

- 1 During playback, press [SKIP |◀◀, ▶▶|] repeatedly until a desired chapter or title will be selected.

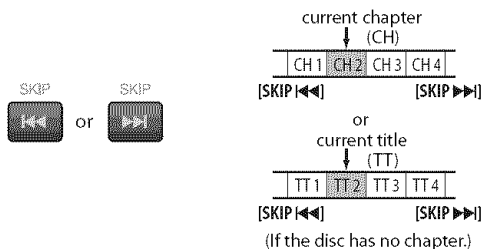

- 2 Playback will start automatically from the chapter or title you selected.

Note:

- [SKIP |◀◀/▶▶|] are not available when playback is stopped.
- Chapter or title search can only be performed during playback or when the unit has kept the resume information. It cannot be performed in the stop mode.

- 3 Press [BACK/RETURN] to exit.



Note:

- Picture adjustment menu will not be displayed while in the stop mode or from the file list.
- This feature may have no effect on some files (e.g. Files with a small picture size).
- The default setting is "NORMAL".

✓ Search Functions

Chapter / Title Search

DVD

Using [SEARCH MODE]

- 1 Press [SEARCH MODE] repeatedly until "CH" appears.
 - If you want to perform the title search, press [SEARCH MODE] repeatedly until "TT" appears.

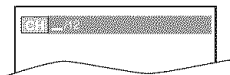

- 2 Press [the Number buttons] to select your desired chapter or title within 30 seconds.

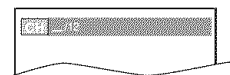
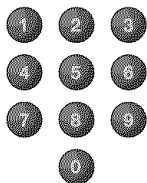

To play back a single-digit chapter or title when there are more than 10 chapters or titles, press [ENTER] after entering the chapter or title number.

- 3 Playback will start automatically from the chapter or title you selected.

Note:

- The total number of chapters/titles in your disc; with less than 10 chapters/titles, press the chapter/title number directly. With 10 or more chapters/titles, to play a single digit chapter/title, press [0] first, then the chapter/title number. (e.g., for chapter 3, press [0] and [3].) To play a double-digit chapter/title, press the chapter/title number.

Track Search

CD VCD MP3 JPEG

w/o PBC

Using [SEARCH MODE]

- 1 Press [SEARCH MODE] repeatedly until "TR" appears.



- 2 Press [the Number buttons] to select your desired track/file within 30 seconds.

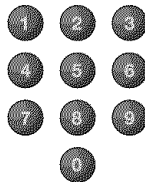

To play back a single-digit track/file when there are more than 10 tracks/files, press [ENTER] after entering the track/file number.

- 3 Playback will start automatically from the track/file you selected.

Note:

- The total number of tracks/files in your disc; With less than 10 tracks/files, press the track/file number directly. With 10 or more tracks/files, to play a single digit track/file, press [0] first, then the track/file number. (e.g., for track 3, press [0] and [3].) To play a double-digit track/file, press the track/file number. With 100 or more files, to play a single or double digit file, press [0] first, then the file number directly. (e.g., for file 3, press [0], [0] and [3]. For file 26, press [0], [2] and [6].) To play a triple digit file, press the file number.
- Track search is not available for programmed or random playback.

Using [SKIP <<, >>]

- 1 During playback, press [SKIP <<, >>] repeatedly until a desired track/file will be selected.

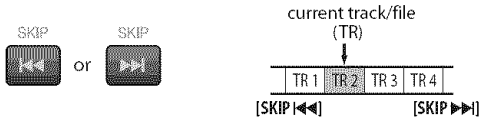

- 2 Playback will start automatically from the track/file you selected.

Note:

- [SKIP <</>>] are not available when playback is stopped.
- Track search can only be performed during playback or when the unit has kept the resume information. It cannot be performed in the stop mode.

Time Search

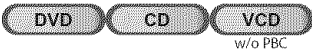

- 1 During playback, press [SEARCH MODE] repeatedly until "SEARCH MODE" appears.

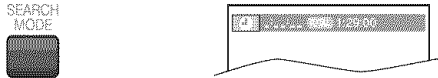

- 2 Press [the Number buttons] to select your desired time lapse within 30 seconds.

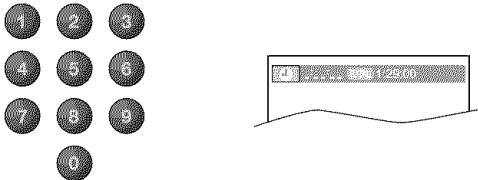

- 3 Playback will start automatically from the time you selected.

Note:

- When there is no need to enter a number, "0" appears automatically. For example, "0: 0 : _ _" appears in the time search menu if the total time of the title or track is less than 10 minutes.
- Press [CLEAR] to erase the incorrect input at step 2.
- Time search can only be performed during playback or when the unit has kept the resume information. It cannot be performed in the stop mode.

Direct Search



Press [the Number buttons] to select your desired chapter, title, track/file.

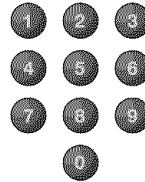

Note:

- To select a single-digit chapter, title, track/file number, press the number directly.
- To select double digit chapter, title, track/file number:
 - If the disc contains more than 9 and less than 100 chapter, title, tracks/files, press [+10] first, then enter the double digit chapter, title, track/file number.
 - (e.g., for track 26, press [+10], [2] and [6].)

Repeat Playback



Repeat function is available only during playback.

- 1 During playback, press [REPEAT] repeatedly until "REPEAT" appears.

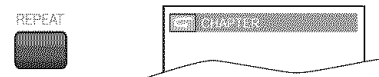

- 2 Press [REPEAT] to change the repeat mode.

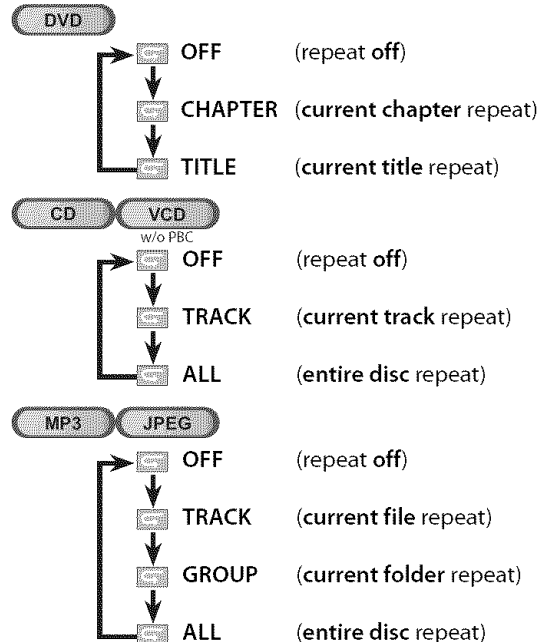

- 3 Press [BACK/RETURN] to exit.



Repeat A-B Playback

DVD CD VCD

You can repeat playback between A and B on a disc.

1 During playback, press **[A-B]** at your desired starting point (A).



2 Press **[A-B]** at your desired ending point (B).

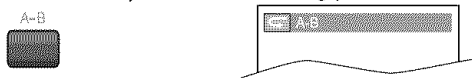

- Point B should be in the same title or track as point A.
- Within a few seconds, the section A-B will begin to play back repeatedly.

3 To cancel repeat A-B playback, press **[A-B]** repeatedly until "OFF" appears.



Note:

- Repeat setting (except "ALL") will be cleared when moving to another title, chapter, track/file or folder.
- During programmed playback, repeat setting will be effective for the tracks/files in the program.
- Repeat playback or repeat A-B playback may not available with some discs.
- Repeat A-B playback does not function during other repeat mode.
- To cancel point A, press **[CLEAR]** at step 1 in "Repeat A-B Playback".
- Stopping playback will cancel repeat A-B playback.

Random Playback

CD MP3 JPEG

This function shuffles the playing order of tracks instead of playback in the sequence.

1 In stop mode, press **[MODE]** repeatedly until "RANDOM" menu appears.

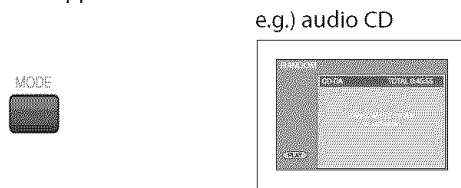

2 Press **[PLAY ▶]** to start random playback.



Note:

- To repeat the current track/file in the random mode, follow the steps 1 and 2 in "Repeat Playback" on page 34 and select "TRACK".
- To repeat the entire random selections, follow the steps 1 and 2 in "Repeat Playback" on page 34 and select "ALL".
- Random playback of MP3 or JPEG is not available while "DUAL PLAYBACK" is "ON".
- Random playback will be kept until you press **[STOP ■]**.

Programmed Playback

CD MP3 JPEG

You may determine the order in which tracks will play back.

1 In stop mode, press **[MODE]** repeatedly until "PROGRAM" menu appears.

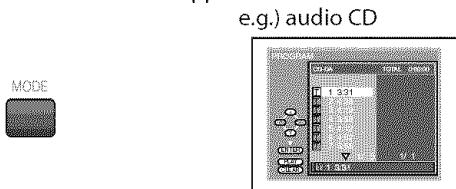

2 Use **[Cursor ▲ / ▼]** to select a desired track/file, then press **[ENTER]** to store.

- Additional tracks/files may be on other screens. Use **[Cursor ◀ / ▶]** to go on to the next / previous pages.
- Repeat this step until you have selected all the tracks/files you wish to play back in the program.

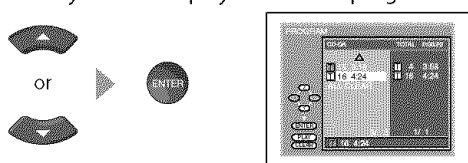

- Up to 99 tracks/files can be ordered.
- If 8 or more tracks/files were in a program, use **[SKIP ◀◀ / ▶▶]** to see all the tracks/files.

While an MP3 or a JPEG folder is open:

- Press **[Cursor ▶]** when you want to go to the next hierarchy.
- Press **[Cursor ◀]** when you want to go back to the previous hierarchy (except for the top hierarchy).
- Press **[TITLE]** when you want to go back to the item in the top hierarchy.

3 Press **[PLAY ▶]** to start programmed playback.



Note:

- Press **[CLEAR]** to erase the last track/file in the program if you make an error.
- To erase all programmed tracks/files at once, select "ALL CLEAR" and press **[ENTER]** at step 2.
- While a program is being played back, **[STOP ■]** works as follows:
 - Pressing **[STOP ■]** once: The track/file will be in the resume standby mode. Next time you press **[PLAY ▶]**, the playback will resume from the point where it is stopped in the programmed playback. (For MP3 file, playback will resume from the beginning of the current file.)
 - Pressing **[STOP ■]** twice: Resume mode will be canceled. Next time you press **[PLAY ▶]**, playback will restart from the first track/file in the original order. However, your programmed playback can be restarted when you follow the above steps. (Your programs are still stored until either the disc is ejected or the unit is turned off.)
- On some discs, **[STOP ■]** will not work while the resume message appears. Please wait until the message disappears.
- To repeat the current track/file in the program, follow the steps 1 and 2 in "Repeat Playback" on page 34 and select "TRACK".
- To repeat the entire program, follow the steps 1 and 2 in "Repeat Playback" on page 34 and select "ALL".
- Turning off the unit or ejecting the disc will erase the program.
- You cannot use **[the Number buttons]** to select another track/file during programmed playback. Use **[SKIP ◀◀ / ▶▶]** to select other tracks/files in the program.
- You cannot combine random playback with programmed playback.
- You cannot alter a programmed order during playback.
- You can start programmed playback only while in "PROGRAM" menu.

On-screen Display

You can check the information about the current disc by pressing [INFO] on the remote control.

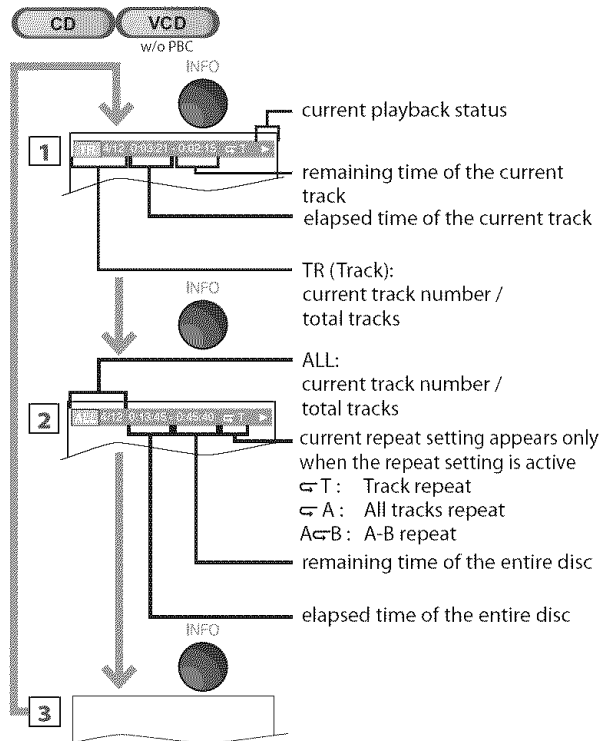
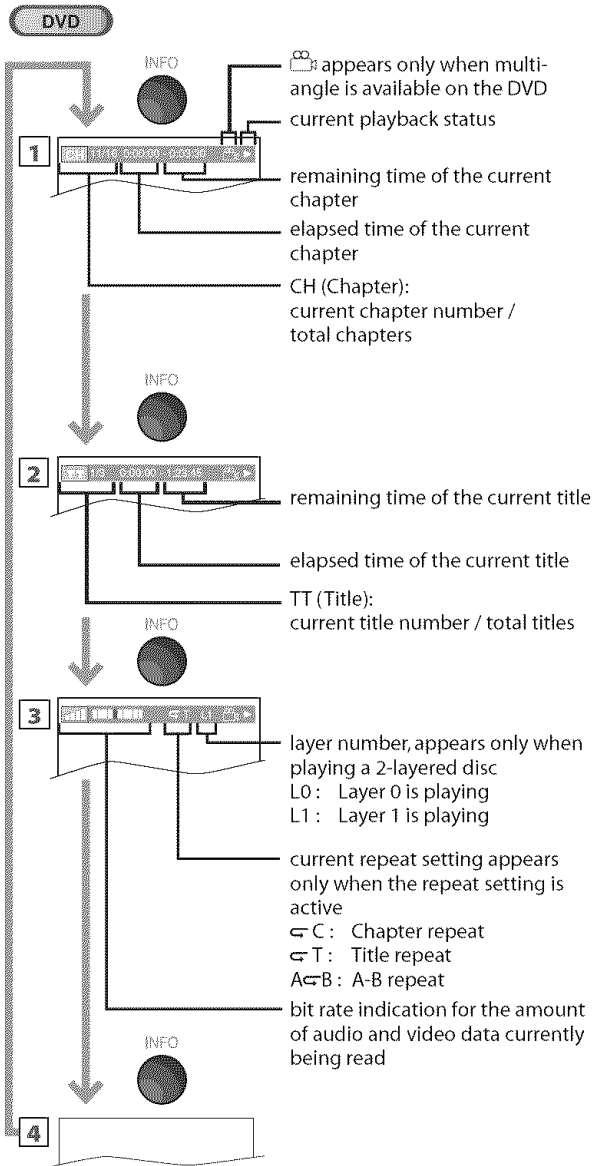

Note:

- When you are playing back an audio CD in program or random mode, "PROGRAM" (or "RANDOM") will be displayed instead of [2].

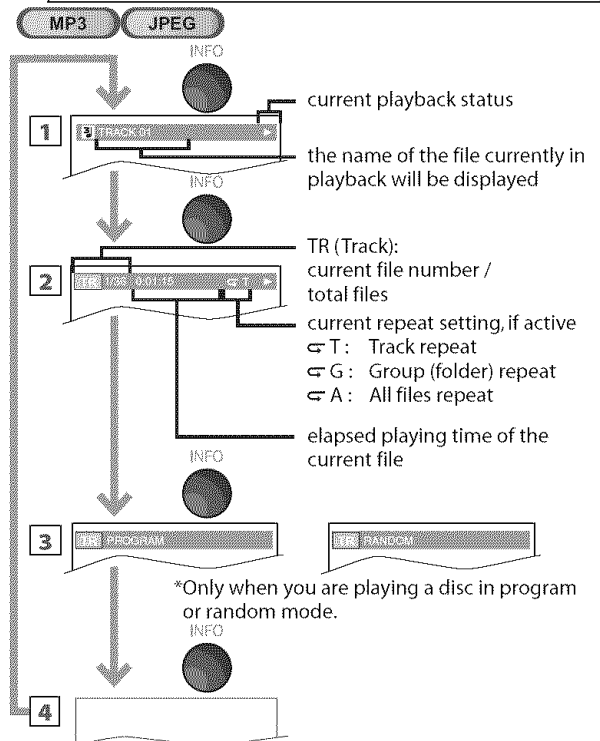

Note:

- When "DUAL PLAYBACK" is "ON", MP3 and JPEG file name will be displayed.

Special Settings

Subtitle Language

DVD

This unit allows you to select a subtitle language (if available) during DVD playback.

During playback, press [SUBTITLE] repeatedly until the desired language appears.

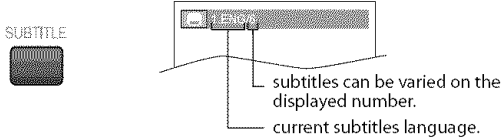

- Each time you press [SUBTITLE], the subtitle language changes as example below.

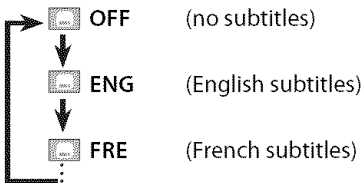

- Each time you press [AUDIO], the audio language changes as example below.



Note:

- Some discs will only allow you to change the audio setting from the disc menu. Refer to the manual accompanying the discs for details.
- If your language is not shown after pressing [AUDIO] several times, the disc may not have that language. However, some discs allow you to change multiple audio languages setting in the disc menu. (Operation varies depending on the disc, so refer to the manual along with the disc.)
- When "NOT AVAILABLE" appears on the TV screen, it means audio language is not available.

To cancel the subtitle

- 1 During playback, press [SUBTITLE] to display the subtitle display.

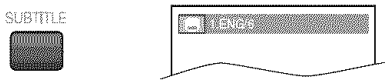

- 2 Press [Cursor ▶] to set "OFF".

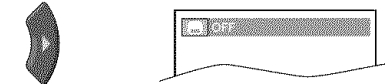

Note:

- If your language is not shown after pressing [SUBTITLE] several times, the disc may not have that language. However, some discs allow you to change subtitle languages setting in the disc menu. (Operation varies depending on the disc, so refer to the manual along with the disc.)
- When "NOT AVAILABLE" appears on the TV screen, it means no subtitle is recorded on the scene.
- If you choose a language that has 3-letter-language code, the code will be displayed every time you change the subtitle language setting. If you choose any other languages, "---" will be displayed instead. (Refer to page 43.)

Audio Language

DVD

This unit allows you to select an audio language (if multiple languages are available) during DVD playback.

During playback, press [AUDIO] repeatedly until the desired language appears.

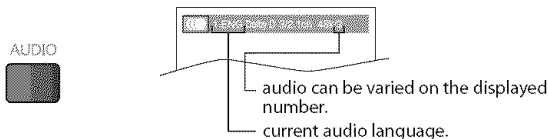

Camera Angles

DVD

Some DVD may contain scenes which have been shot simultaneously from various angles. You can change the camera angle if "ANGLE" appears on the screen. If "ANGLE ICON" is set to "OFF" in "OTHERS" menu, "ANGLE" will not appear. (Refer to page 42.)

During playback, press [ANGLE] repeatedly until the desired camera angle appears.

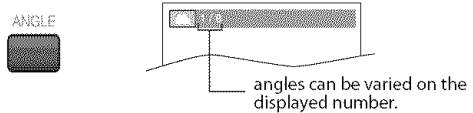

Black Level Setting

DVD VCD

Adjust the black level to make the dark areas of the TV picture brighter.

- 1 During playback, press [MODE] repeatedly until "OFF" appears.

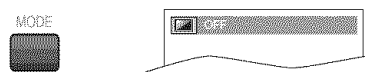

- 2 Press [ENTER] to adjust the black level.

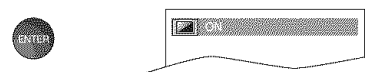

- ON** : Makes the dark areas brighter.
- OFF** : Shows the original picture as recorded.

- 3 Press [BACK/RETURN] to exit.



Note:

- The setting will be kept even if the unit is turned off.

Stereo Sound Mode

CD VCD

This unit allows you to select a sound mode during CD playback.

During playback, press **[AUDIO]** repeatedly until the desired sound mode appears.

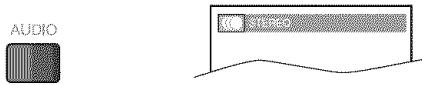

- Each time you press **[AUDIO]**, the sound mode changes as example below.

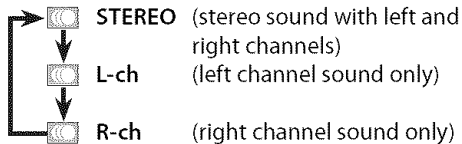

Note:

- Virtual surround cannot be changed when the sound mode is set to either "L-ch" or "R-ch".

Virtual Surround

DVD CD VCD MP3

You can enjoy virtual surround on your existing 2 channel stereo system.

- During playback, press **[MODE]** repeatedly until "OFF" appears.

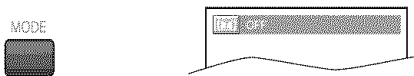

- Press **[ENTER]** to select the sound level.

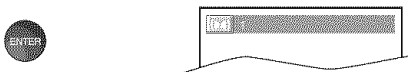

- 1: Natural effect.
- 2: Emphasized effect.
- OFF: No effects (original sound).

- Press **[BACK/RETURN]** to exit.



Note:

- The setting will be kept even if the unit is turned off.
- For audio CD and video CD, virtual surround will not be effective if the sound mode is set to something other than "STEREO". Refer to "Stereo Sound Mode".
- Turn down the level or select "OFF" if the sound is distorted.

Marker Setup

DVD CD VCD
w/o PBC

This feature allows you to assign a specific point on a disc to be called back later.

To set a marker

- During playback, press **[SEARCH MODE]** repeatedly until "SEARCH MODE" appears.

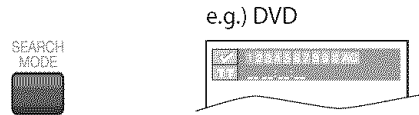

e.g.) DVD

- Use **[Cursor ◀/▶]** to select an available marker within 30 seconds.

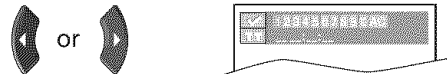

- When the playback reaches the point at which you want to set a marker, press **[ENTER]**.

- Marker is now set.

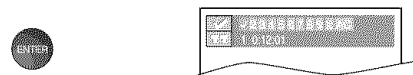

- Press **[BACK/RETURN]** to exit.



To return to the marker later

- To select a desired marker, repeat steps 1-2 in "To set a marker".

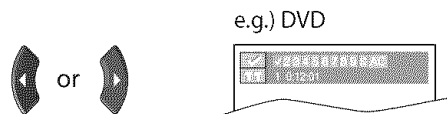

e.g.) DVD

- Press **[ENTER]** at the desired marker to restart playback from the specific point which you set.

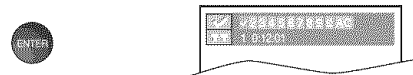

Note:

- Marker search menu will disappear in about 30 seconds when there is no input.
- You can mark up to 10 points.
- To clear a marker, select the marker to be cleared at step 2 in the section "To set a marker" or "To return to the marker later", and then press **[CLEAR]**.
- Ejecting the disc or turning off the power will erase all markers.
- Selecting "OFF" at step 2 in the section "To set a marker" or "To return to the marker later" will also erase all markers.

Settings are only effective when the unit is in DVD mode and any discs should not be played back.

✓ DVD Language Setting

You can change the desired language when playing back the disc.

1 Press **[SETUP]** to display the main menu.

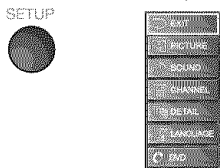

2 Use **[Cursor ▲/▼]** to select "DVD", then press **[ENTER]**.

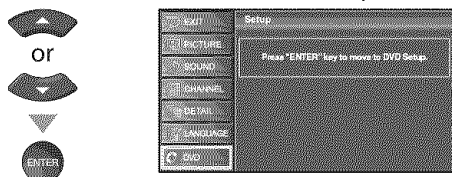

3 Use **[Cursor ◀/▶]** to select "LANGUAGE", then press **[ENTER]**.

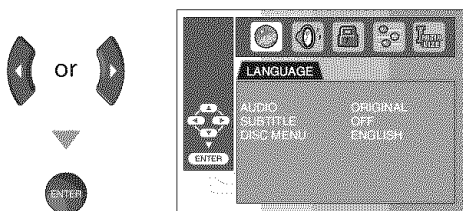

4 Use **[Cursor ▲/▼]** to select the desired item, then press **[ENTER]**.

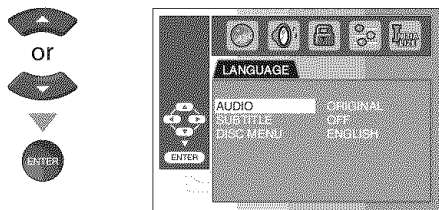

5 Use **[Cursor ▲/▼]** to select the desired item, then press **[ENTER]**.

[AUDIO] *1, *2 (Default: ORIGINAL)
Select the desired audio language.

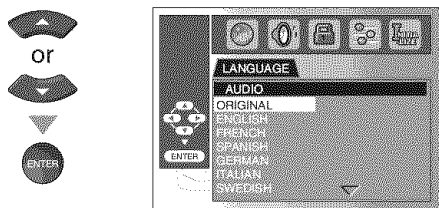

[SUBTITLE] *1, *2 (Default: OFF)

Select the desired subtitle language.

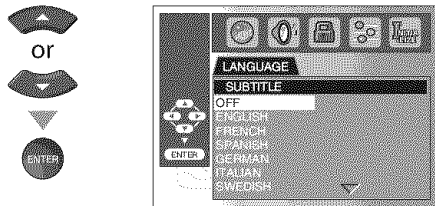

[DISC MENU] *1 (Default: ENGLISH)

Select the desired language in DVD menu.

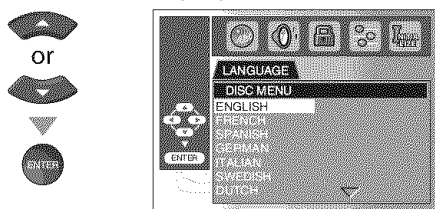

Note:

- To change the on-screen language, call up "LANGUAGE" from the main menu and set the desired language.
- (Refer to "Language Selection" on page 14.)
- *1
 - Language options are not available with some discs.
 - If "OTHER" is selected in "AUDIO", "SUBTITLE" or "DISC MENU" menu, press 4-digit number to enter the code for the desired language. (Refer to "Language Code List" on page 43.)
 - Only the languages supported by the disc can be selected.
- *2
 - Language setting for Audio and Subtitle are not available with some discs. Then press **[AUDIO]** and **[SUBTITLE]**. Details are on page 37.
 - If the DVD's default settings for audio and subtitle are the same language, the subtitles may not show unless you turn them on.

6 Press **[SETUP]** to exit.



✓ DVD Audio Setting

Choose the appropriate audio settings for your equipment. It only affects during the playback of DVD.

1 Press **[SETUP]** to display the main menu.

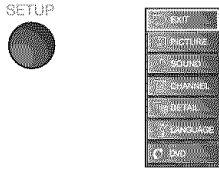

2 Use **[Cursor ▲/▼]** to select "DVD", then press **[ENTER]**.

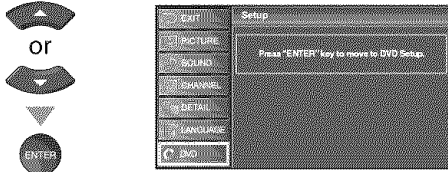

3 Use **[Cursor ◀/▶]** to select "0", then press **[ENTER]**.

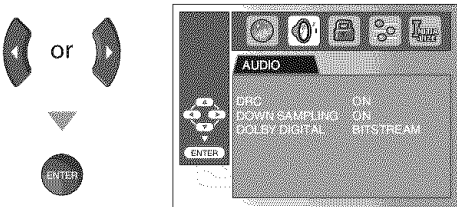

4 Use **[Cursor ▲/▼]** to select the desired item, then press **[ENTER]**.

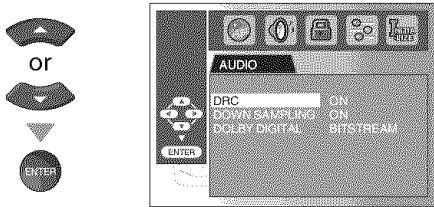

5 Use **[Cursor ▲/▼]** to select the desired item, then press **[ENTER]**.

[DRC] (dynamic range control) (Default: ON)

Set "DRC".

This function is available only on the discs which are recorded in the Dolby Digital format.

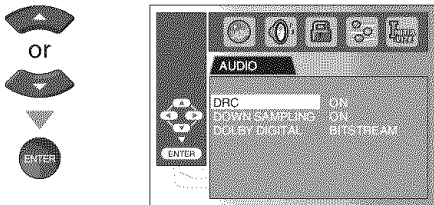

ON : Compress the range between soft and loud sounds.

OFF : No effects (original sound).

[DOWN SAMPLING]

(Default: ON)

Set "DOWN SAMPLING".

This function is available only on digital outputting of a disc recorded in 96kHz.

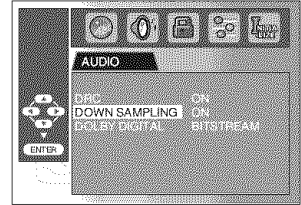

ON : When outputting in 48kHz.

OFF : When outputting the original sound.

Note:

- When playing back a 96 kHz disc with the copyright protection or when virtual surround is set to "1" or "2", the sound will be down sampled at 48 kHz even if the "DOWN SAMPLING" is set to "OFF".

[DOLBY DIGITAL]

(Default: BITSTREAM)

Set to "BITSTREAM" when this unit is connected to a Dolby Digital decoder. Available on DVD only.

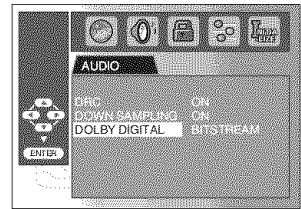

BITSTREAM : Outputs Dolby Digital signals.

PCM : Converts the Dolby Digital into PCM. (2 channel)

6 Press **[SETUP]** to exit.



✓ Parental Setting

Parental setting prevents your children from viewing inappropriate materials. (password protected.) Playback will stop if the ratings exceed the levels you set.

1 Press **[SETUP]** to display the main menu.

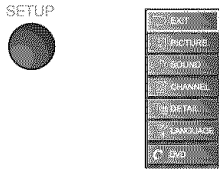

2 Use **[Cursor ▲/▼]** to select "DVD", then press **[ENTER]**.

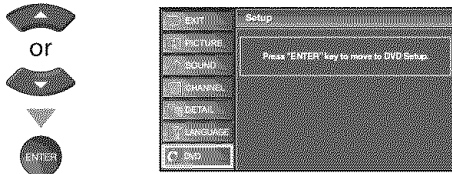

3 Use **[Cursor ◀/▶]** to select " ", then press **[ENTER]**.

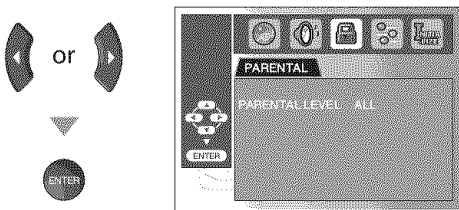

4 Use **[the Number buttons]** to enter the 4-digit numbers for your password, then press **[ENTER]**.

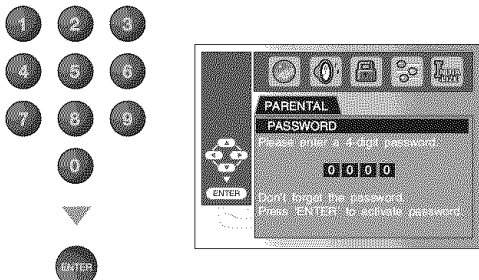

- If you have set password already, use **[the Number buttons]** to enter the current 4-digit password.
- You cannot use the default password (4737) to play back a DVD.

5 Use **[Cursor ▲/▼]** to select the "PARENTAL LEVEL", then press **[ENTER]**.

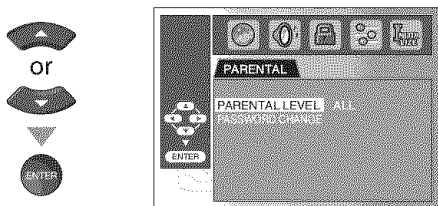

6 Use **[Cursor ▲/▼]** to select the desired item, then press **[ENTER]**.

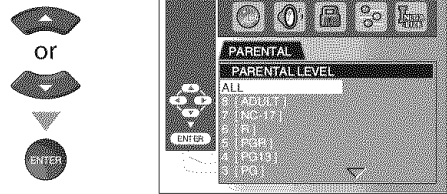

PARENTAL LEVEL

- ALL :** All parental locks are cancelled.
- 8 [ADULT] :** All ratings (adult/general/children) can be played back.
- 7 [NC-17]-2 [G] :** Only DVD intended for general use and children can be played back.
- 1 [KID SAFE] :** Only DVD intended for children can be played back.

7 Press **[SETUP]** to exit.



To change the password

5 Follow steps 1 to 4. Use **[Cursor ▲/▼]** to select "PASSWORD CHANGE", then press **[ENTER]**.

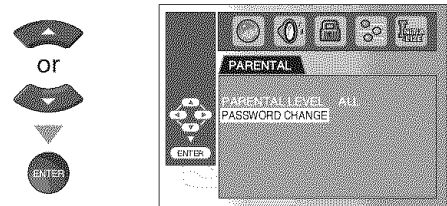

6 Use **[the Number buttons]** to enter the new 4-digit password.

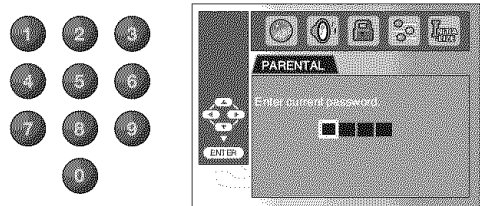

Note:

- DVD-video may not respond to parental lock settings. Make sure this function works with your DVD-video.
- Record the password in case you forget it.
- If you forget the password, press **[4], [7], [3], [7]**, then enter your new password. Password will be cleared and parental levels will be set to "ALL".
- A power failure will not erase your password.

7 Press **[SETUP]** to exit.



Others

You can change the other functions.

1 Press **[SETUP]** to display the main menu.

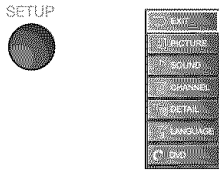

2 Use **[Cursor ▲/▼]** to select "DVD", then press **[ENTER]**.

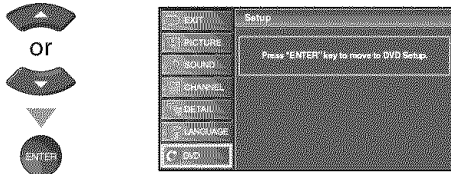

3 Use **[Cursor ◀/▶]** to select "OTHERS", then press **[ENTER]**.

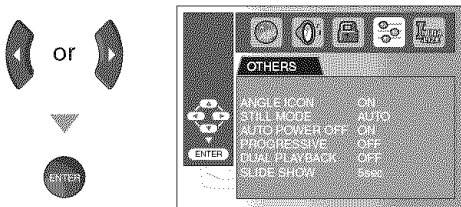

4 Use **[Cursor ▲/▼]** to select the desired item, then press **[ENTER]**.

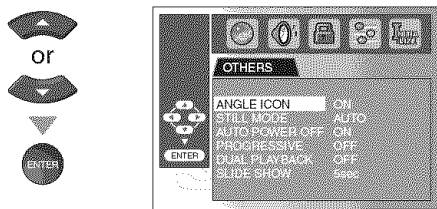

5 Use **[Cursor ▲/▼]** to select the desired item, then press **[ENTER]**.

[ANGLE ICON] (Default: ON)
Set to "ON" to show the angle icon when multiple camera angles are available during DVD playback.

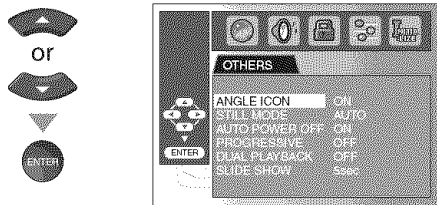

[STILL MODE] (Default: AUTO)
Set the picture quality in the still mode.
If you select "AUTO", it automatically selects the best resolution setting ("FRAME" or "FIELD") based on the data characteristics of the pictures.

FIELD : the picture in the still mode will be stabilized.

FRAME : the picture in the still mode will be highly defined.

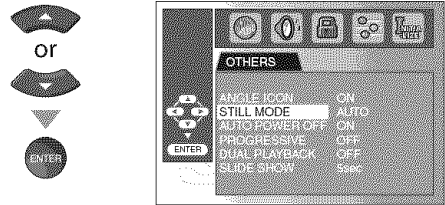

[AUTO POWER OFF] (Default: ON)

Set to "ON" to turn this unit off automatically after 20 minutes of no use.

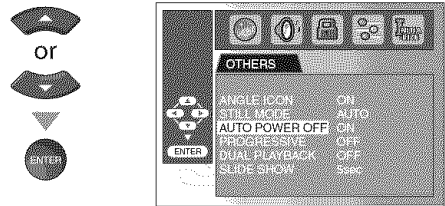

[PROGRESSIVE] (Default: OFF)

Set to "ON" to play back in progressive mode.

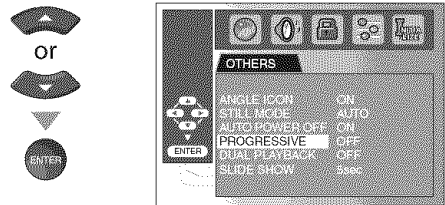

[DUAL PLAYBACK] (Default: OFF)

Set to "ON" to play back MP3 and JPEG files simultaneously.

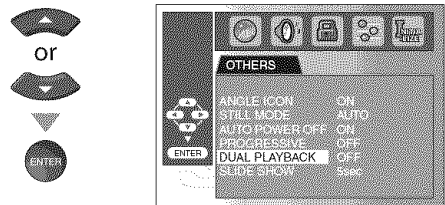

[SLIDE SHOW] (Default: 5sec)

Set the length of displayed JPEG picture.

5sec : The picture changes every 5 seconds.

10sec : The picture changes every 10 seconds.

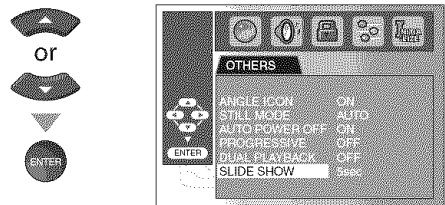

6 Press **[SETUP]** to exit.



✓ Reset to the Default Setting

You can reset all the settings except for the parental setting and on-screen menu language.

1 Press **[SETUP]** to display the main menu.

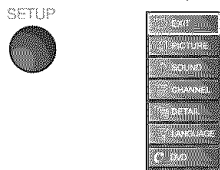

2 Use **[Cursor ▲/▼]** to select "DVD", then press **[ENTER]**.

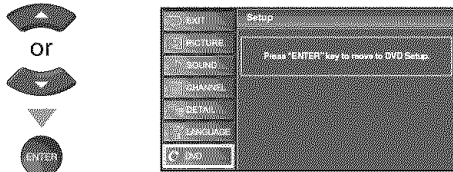

3 Use **[Cursor ◀/▶]** to select "INITIALIZE", then press **[ENTER]**.

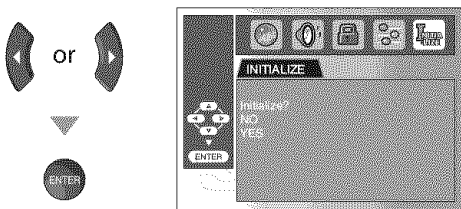

4 Use **[Cursor ▲/▼]** to select "YES", then press **[ENTER]**.

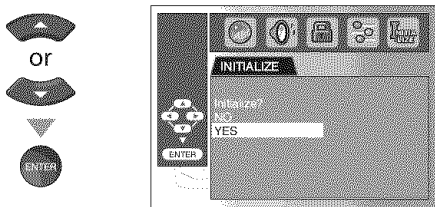

Note:

- When you want to cancel the initialization, select "NO" at step 4, then press **[SETUP]**.

5 Press **[SETUP]** to exit.



✓ Language Code List

Language	A-B	Code	Language	Code
Abkhazian		4748	Marathi	5964
Afar		4747	Moldavian	5961
Afrikaans		4752	Mongolian	5960
Albanian		6563	Nauru	6047
Amharic		4759	Nepali	6051
Arabic		4764	Norwegian [NOR]	6061
Armenian		5471		O-R
Assamese		4765	Occitan	6149
Aymara		4771	Oriya	6164
Azerbaijani		4772	Oromo(Afan)	6159
Bashkir		4847	Panjabi	6247
Basque		5167	Pashto;Pushto	6265
Bengali;Bangla		4860	Persian	5247
Bhutani		5072	Polish [POL]	6258
Bihari		4854	Portuguese [POR]	6266
Bislama		4855	Quechua	6367
Breton		4864	Rhaeto-Romance	6459
Bulgarian		4853	Romanian [RUM]	6461
Burmese		5971	Russian [RUS]	6467
Byelorussian		4851		S
	C-E		Samoan	6559
Cambodian		5759	Sangho	6553
Catalan		4947	Sanskrit	6547
Chinese [CHI]		7254	Sanscrit	5350
Corsican		4961	Scots Gaelic	5664
Croatian		5464	Serbian	6554
Czech [CZE]		4965	Serbo-Croatian	6554
Danish [DAN]		5047	Sesotho	6566
Dutch [DUT]		6058	Setswana	6660
English [ENG]		5160	Shona	6560
Esperanto		5161	Sindhi	6550
Estonian		5166	Singhalese	6555
	F-H		Siswat	6565
Faroese		5261	Slovak	6557
Fiji		5256	Slovenian	6558
Finnish [FIN]		5255	Somali	6561
French [FRE]		5264	Spanish [SPA]	5165
Frisian		5271	Sundanese	6567
Galician		5358	Swahili	6569
Georgian		5747	Swedish [SWE]	6568
German [GER]		5051		T
Greek [GRE]		5158	Tagalog	6658
Greenlandic		5758	Tajik	6653
Guarani		5360	Tamil	6647
Gujarati		5367	Tatar	6666
Hausa		5447	Telugu	6651
Hebrew		5569	Thai	6654
Hindi		5455	Tibetan	4861
Hungarian [HUN]		5467	Tigrinya	6655
	I-K		Tonga	6661
Icelandic [ICE]		5565	Tsonga	6665
Indonesian		5560	Turkish [TUR]	6664
Interlingua		5547	Turkmen	6657
Interlingue		5551	Twí	6669
Inupiak		5557		U-Z
Irish [IRI]		5347	Ukrainian	6757
Italian [ITA]		5566	Urdu	6764
Japanese [JPN]		5647	Uzbek	6772
Javanese		5669	Vietnamese	6855
Kannada		5760	Volapuk	6861
Kashmiri		5765	Welsh	4971
Kazakh		5757	Wolof	6961
Kinyarwanda		6469	Xhosa	7054
Kirghiz		5771	Yiddish	5655
Kirundi		6460	Yoruba	7161
Korean [KOR]		5761	Zulu	7267
Kurdish		5767		
	L-N			
Laothian		5861		
Latin		5847		
Latvian;Lettish		5868		
Lingala		5860		
Lithuanian		5866		
Macedonian		5957		
Malagasy		5953		
Malay		5965		
Malayalam		5958		
Maltese		5966		
Maori		5955		

Note:

- If you choose a language that has a 3-letter language code, the code will be displayed every time you change the audio or subtitle language setting above. If you choose any other language, "---" will be displayed instead. (3-letter language code is written in bracket.)

✓ Troubleshooting Guide

If the unit does not perform properly when operated as instructed in this Owner's Manual, check the following chart once before calling for service.

Symptom	Remedy
No power	<ul style="list-style-type: none"> • Be sure the power cord is plugged in. • If a power failure occurs, unplug the power cord for 30 minutes to allow the unit to reset itself.
No picture or sound	<ul style="list-style-type: none"> • Check if the power is on. • Check the outlet connection. • Check the antenna or cable connection to the main unit. • When the outside antenna is used, check the wire condition and connection. • View other TV channels. The problem might be limited to the broadcasting station. • Turn off the power and wait for about 1 minute, then turn it on again.
No color	<ul style="list-style-type: none"> • Check the antenna or cable connection to the main unit. • When the outside antenna is used, check the wire condition and connection. • View other TV channels. The problem might be limited to the broadcasting station. • Adjust the Color in the setup screen.
Sound OK, picture poor	<ul style="list-style-type: none"> • Check the antenna or cable connection to the main unit. • When the outside antenna is used, check the wire condition and connection. • Electrical interference from nearby appliances may affect picture quality. • Adjust Contrast and Brightness in the setup screen. • View other TV channels. The problem might be limited to the broadcasting station.
Picture distorted	<ul style="list-style-type: none"> • When the outside antenna is used, check the wire condition and connection. • View other TV channels. The problem might be limited to the broadcasting station.
Weak picture	<ul style="list-style-type: none"> • Check the antenna or cable connection to the main unit. • When the outside antenna is used, check the wire condition and connection. • Adjust Contrast and Brightness in the setup screen. • View other TV channels. The problem might be limited to the broadcasting station.
Lines or streaks in picture	<ul style="list-style-type: none"> • When the outside antenna is used, check the wire condition and connection. • Electrical interference from nearby appliances may affect picture quality. • View other TV channels. The problem might be limited to the broadcasting station.
Picture blurred	<ul style="list-style-type: none"> • When the outside antenna is used, check the wire condition and connection. • View other TV channels. The problem might be limited to the broadcasting station.
Ghosts in picture	<ul style="list-style-type: none"> • Check the antenna or cable connection to the main unit. • When the outside antenna is used, check the wire condition and connection. • Electrical interference from nearby appliances may affect picture quality. • View other TV channels. The problem might be limited to the broadcasting station.
Bars on TV screen	<ul style="list-style-type: none"> • When the outside antenna is used, check the wire condition and connection. • Electrical interference from nearby appliances may affect picture quality.
Picture rolls vertically	<ul style="list-style-type: none"> • When the outside antenna is used, check the wire condition and connection. • Electrical interference from nearby appliances may affect picture quality. • View other TV channels. The problem might be limited to the broadcasting station.
Different color marks on TV screen	<ul style="list-style-type: none"> • Move your TV away from nearby electric appliances. Turn off the power and wait 30 minutes before turning it back on. • View other TV channels. The problem might be limited to the broadcasting station.
Poor reception on some channels	<ul style="list-style-type: none"> • Check the antenna or cable connection to the main unit. • When the outside antenna is used, check the wire condition and connection. • Electrical interference from nearby appliances may affect picture quality. • View other TV channels. The problem might be limited to the broadcasting station.
Picture OK, sound poor	<ul style="list-style-type: none"> • View other TV channels. The problem might be limited to the broadcasting station.
No reception of digital signals	<ul style="list-style-type: none"> • Make sure Autoscanner has been completed (Refer to "Auto Channel Scan" on page 14). Autoscanner must be completed when you set up your TV for the first time or move it to a location where previously unavailable channels are broadcast. • The selected channel may not be broadcasting. • When Autoscanner is interrupted and not completed, some channels will not be received. Make sure to complete Autoscanner in the setup screen.

Symptom	Remedy
The entered channel number changes automatically	<ul style="list-style-type: none"> Many digital channels have alternate channel numbers. TV changes the numbers automatically to the ones signifying the broadcasting stations. These are the numbers used for analog broadcasts.
Remote control does not work	<ul style="list-style-type: none"> Check the antenna or cable connection to the main unit. Check the batteries of the remote control. Check if there is an obstacle between the sensor and the remote control. Test the signal output. If OK, then possible remote sensor trouble. (Refer to "IR Signal Check" on page 46.) Aim the remote control directly at the sensor on the front of the unit. Reduce the distance to the unit. Re-insert the batteries with their polarities (+/- signs) as indicated. When there is an infrared-equipped device such as PC near this unit, it may interrupt the remote control signal of this unit. Move the infrared-equipped device away from this unit, change the angle of the infrared sensor or turn off the infrared communication function.
Problems with Closed Caption Feature	
Misspelled captions are displayed.	<ul style="list-style-type: none"> Closed captioning production companies may broadcast programs without correcting the misspelling in a live broadcast.
Captions are not entirely displayed, or captions are delayed behind the dialogue.	<ul style="list-style-type: none"> Captions that are delayed a few seconds behind the actual dialogue are common for live broadcasts. Most captioning production companies can display a dialogue to a maximum of 220 words per minute. If a dialogue exceeds that rate, selective editing is used to insure that the captions remain up-to-date with the current TV screen dialogue.
Captions are displayed as a white box. No caption is displayed in the Closed Caption-supported program.	<ul style="list-style-type: none"> Interference from buildings or weather conditions may cause captioning to be incomplete. Broadcasting station may shorten the program to insert advertisement. The closed caption decoder cannot read the information of the shortened program.
No caption is displayed when playing the videotape containing captions.	<ul style="list-style-type: none"> The videotape may be illegally copied, or the caption signal might not have been read during copying.
Black box is displayed in the screen.	<ul style="list-style-type: none"> "Text" mode is selected for caption. Select "CC1", "CC2", "CC3", "CC4" or "Off".
Completely distorted picture or black/white picture with DVD	<ul style="list-style-type: none"> Make sure the disc is compatible with the unit.
Picture freezes momentarily during playback.	<ul style="list-style-type: none"> Check the disc for finger prints/scratches and clean with a soft cloth wiping from center to edge.
Disc cannot be played.	<ul style="list-style-type: none"> Clean the disc. Ensure the disc is correctly inserted. Check if the disc is defective by trying another disc. Cancel the parental lock or change the control level. Insert a correct disc that plays on this unit. Handle a disc with special care so that it does not have fingerprints, scratches, or dusts on its surface.
Buttons do not work or the unit stops responding.	<ul style="list-style-type: none"> To completely reset the unit, unplug the power cord from the power outlet for 5-10 seconds.
The unit does not respond to some operating commands during playback.	<ul style="list-style-type: none"> Operations may not be permitted by the disc. Refer to the instructions of the disc.
Angle does not switch.	<ul style="list-style-type: none"> The angle cannot be switched for DVD which do not contain multiple angles. In some cases multiple angles are only recorded for specific scenes.
Playback does not start when the title is selected.	<ul style="list-style-type: none"> Check the "PARENTAL" setting.
The password for rating level has been forgotten.	<ul style="list-style-type: none"> Enter the default password "4737", then your forgotten password will be cleared.

Note:

- The LCD panel is manufactured to provide many years of useful life. Occasionally a few non active pixels may appear as a fixed point of blue, green or red. This is not to be considered a defect in the LCD screen.
- Some functions are not available in specific modes, but this is not a malfunction. Read the description in this Owner's Manual for more details on correct operations.
- Playback from a desired track and random playback are not available during program playback.
- Some functions are prohibited on some discs.

✓ Maintenance

Cabinet Cleaning

- Wipe the front panel and other exterior surfaces of the unit with a soft cloth immersed in lukewarm water and wrung dry.
- Never use a solvent or alcohol. Do not spray insecticide liquid near the unit. Such chemicals may cause damage and discoloration to the exposed surfaces.

Panel Cleaning

Wipe the panel of the unit with a soft cloth. Before cleaning the panel, disconnect the power cord.

Disc Handling

Handle the discs so that fingerprints and dust do not adhere to the surfaces of the discs.



- Always store the disc in its protective case when it is not used.
- To clean-off, use a soft cloth.
- Do not use a hard cloth since this will mar the disc.
- Wipe the disc in a straight line form center to edge.
- Never wipe with a circular motion.

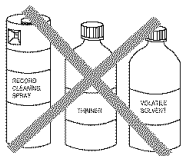

- Do not use detergent or abrasive cleaning agents.

Servicing

Should your unit become inoperative, do not try to correct the problem yourself. There are no user serviceable parts inside. Turn off the unit, unplug the power cord and call our toll free customer support line found on the cover of this manual to locate an authorized service center.

If the Laser Optical Pickup Unit is Dirty

If the unit still does not perform properly when it is operated, while referring to the relevant sections and to "Troubleshooting Guide" in this owner's manual, the laser optical pickup unit may be dirty. Consult your dealer or an Authorized Service Center for inspection and cleaning of the laser optical pickup unit.

IR Signal Check

If the remote control is not working properly, you can use an AM radio or digital camera (including a cellular phone with built-in camera) to see if it is sending out an infrared signal.

- With an AM radio: Tune the AM radio station to a non-broadcasting frequency. Point the remote control towards it, push any button and listen. If the sound from the radio flutters, it is receiving the remote control's infrared signal.

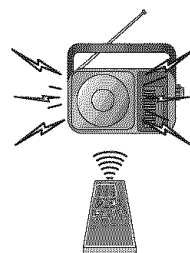

- With a digital camera (including built-in cell phone cameras): Point a digital camera towards the remote control. Push any button on the remote control and look through the digital camera. If the infrared light appears through the camera, the remote control is working.

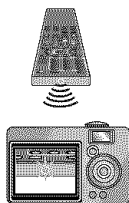

✓ Glossary

ATSC

Acronym that stands for Advanced Television Systems Committee and the name of the digital broadcasting standards.

Aspect Ratio

The width of a TV screen relative to its height. Conventional TVs are 4:3 (in other words, the TV screen is almost square); widescreen models are 16:9 (the TV screen is almost twice as wide as its height).

Component Video

This is a video signal format that conveys each of 3 principal colors of light (red, blue and green) through different signal lines. This allows the viewers to experience picture colors as original as it is. There are several signal formats, including Y / Pb / Pr and Y / Cb / Cr.

Dolby Digital

The system developed by Dolby Laboratories to compress digital sound. It offers stereo sound (2ch) or multi-channel audio.

HDMI (high-definition multimedia interface)

Interface that supports all uncompressed, digital audio/video formats including set-top box, DVD player or digital television, over a single cable.

HDTV (high definition TV)

Ultimate digital format that produces high resolution and high picture quality.

NTSC

Acronym that stands for National Television Systems Committee and the name of the current analog broadcasting standards.

Password

A stored 4-digit number that allows access to parental control features.

PBC(playback control)

An interactive software which has the selectable images or information in the menu screen to playback video CD.

Region Code

Regions associate discs and players with particular areas of the world. This unit will only play back discs that have compatible region codes. You can find the region code of your unit by looking on the rear panel. Some discs are compatible with more than one region (or all regions).

SAP (secondary audio program)

Second-audio channel delivered separately from main-audio channel. This audio channel is used as an alternate in bilingual broadcasting.

SDTV (standard definition TV)

Standard digital format that is similar to the NTSC picture quality.

S-video

Offers higher quality images by delivering each signal, color (c) and luminance (y) independently of each other through separate cables.

☑ Cable Channel Designations

If you subscribe to cable TV, the channels are displayed as 1-135.

Cable companies often designate channels with letters or letter-number combinations. Please check with your local cable company.

The following is a chart of common cable channel designations.

CATV channel	5A	2	3	4	5	6	7	8	9	10	11	12	13	A	B	C	D	E	F	G	H
TV Display	1	2	3	4	5	6	7	8	9	10	11	12	13	14	15	16	17	18	19	20	21
CATV channel	I	J	K	L	M	N	O	P	Q	R	S	T	U	V	W	W+1	W+2	W+3	W+4	W+5	W+6
TV Display	22	23	24	25	26	27	28	29	30	31	32	33	34	35	36	37	38	39	40	41	42
CATV channel	W+7	W+8	W+9	W+10	W+11	W+12	W+13	W+14	W+15	W+16	W+17	W+18	W+19	W+20	W+21	W+22	W+23	W+24	W+25	W+26	W+27
TV Display	43	44	45	46	47	48	49	50	51	52	53	54	55	56	57	58	59	60	61	62	63
CATV channel	W+28	W+29	W+30	W+31	W+32	W+33	W+34	W+35	W+36	W+37	W+38	W+39	W+40	W+41	W+42	W+43	W+44	W+45	W+46	W+47	W+48
TV Display	64	65	66	67	68	69	70	71	72	73	74	75	76	77	78	79	80	81	82	83	84
CATV channel	W+49	W+50	W+51	W+52	W+53	W+54	W+55	W+56	W+57	W+58	A-5	A-4	A-3	A-2	A-1	W+59	W+60	W+61	W+62	W+63	W+64
TV Display	85	86	87	88	89	90	91	92	93	94	95	96	97	98	99	100	101	102	103	104	105
CATV channel	W+65	W+66	W+67	W+68	W+69	W+70	W+71	W+72	W+73	W+74	W+75	W+76	W+77	W+78	W+79	W+80	W+81	W+82	W+83	W+84	W+85
TV Display	106	107	108	109	110	111	112	113	114	115	116	117	118	119	120	121	122	123	124	125	126
CATV channel	W+86	W+87	W+88	W+89	W+90	W+91	W+92	W+93	W+94												
TV Display	127	128	129	130	131	132	133	134	135												

☑ General Specifications

TV

TV format: ATSC / NTSC-M TV standard

Closed caption system:

\$15.122/FCC (digital CC) \$15.119/FCC (analog CC)

Channel coverage (ATSC/NTSC):

Terrestrial VHF: 2~13 **UHF:** 14~69

CATV 2~13, A~W, W+1~W+94 (analog W+1~W+84),
A-5~A-1, 5A

Tuning system: Channel frequency synthesized tuning system

Channel access: Direct access keyboard,

Programmable scan, and up/down

DVD

Discs (Playback compatibility):

DVD video, DVD-RW/-R,

DVD+RW/+R, audio CD, video CD, CD-RW/-R

Frequency response:

DVD (linear sound): 20 Hz to 20 kHz (sample rate: 48 kHz)

20 Hz to 44 kHz (sample rate: 96 kHz)

CD: 20 Hz to 20 kHz

Signal-to-noise ratio (S/N ratio):

CD: 90 dB (JEITA)

Total distortion factor:

DVD: 1 KHz 0.007% (JEITA)

CD: 1 KHz 0.007% (JEITA)

☑ Electrical Specification

Sound Output: 10W, 8 Ω x 2

☑ Other Specifications

Terminals:

Antenna input: VHF/UHF/CATV 75Ω unbalanced (F-type)

S-video input: Mini DIN 4-pin jack x 2 Y: 1Vp-p (75Ω)

C: 286mVp-p (75Ω)

Video input: RCA jack x 2 1Vp-p (75Ω)

Audio input: RCA jack (L/R) x 10 2V rms

Component video input:

RCA jack x 6

Y: 1Vp-p (75Ω)

Pb: 700mVp-p (75Ω)

Pr: 700mVp-p (75Ω)

HDMI input: HDMI 19pin x 2

PC input: D-Sub 15pin x 1 (RGB)

Mini jack ø3.5mm x 1 (audio)

Coaxial digital audio output:

RCA jack x1

500mVp-p (75Ω)

Analog audio output:

RCA jack x2

Remote Control: Digital encoded infrared light system

Operating Temperature:

41°F (5°C) to 104°F (40°C)

Power Requirements:

120 V AC +/- 10%, 60 Hz +/- 0.5%

Power Consumption (Maximum):

180W

LCD:

32 inches wide XGA panel

(1,366 x 768 pixels)

Dimensions:

H : 24.5 inches (620mm)

W : 31.6 inches (802mm)

D : 10.3 inches (260mm)

Weight:

34.7 lbs. (15.7kg)

- Designs and specifications are subject to change without notice and without our legal obligation.
- If there is a discrepancy between languages, the default language will be English.

SYLVANIA

LIMITED WARRANTY

FUNAI CORP. will repair this product, free of charge in the USA in the event of defect in materials or workmanship as follows:

DURATION:

PARTS: FUNAI CORP. will provide parts to replace defective parts without charge for one (1) year from the date of original retail purchase. Certain parts and LCD image burn-in are excluded from this warranty.

LABOR: FUNAI CORP. will provide the labor without charge for a period of ninety (90) days from the date of original retail purchase.

LIMITS AND EXCLUSIONS:

THIS WARRANTY IS EXTENDED ONLY TO THE ORIGINAL RETAIL PURCHASER. A PURCHASE RECEIPT OR OTHER PROOF OF ORIGINAL RETAIL PURCHASE WILL BE REQUIRED TOGETHER WITH THE PRODUCT TO OBTAIN SERVICE UNDER THIS WARRANTY.

This warranty shall not be extended to any other person or transferee.

This warranty is void and of no effect if any serial numbers on the product are altered, replaced, defaced, missing or if service was attempted by an unauthorized service center. This limited warranty does not apply to any product not purchased and used in the United States.

This warranty only covers failures due to defects in material or workmanship which occur during normal use. It does not cover damage which occurs in shipment, or failures which are caused by repairs, alterations or products not supplied by FUNAI CORP., or damage, which results from accident, misuse, abuse, mishandling, misapplication, alteration, faulty installation, improper maintenance, commercial use such as hotel, rental or office use of this product, or damage which results from fire, flood, lightning or other acts of God.

THIS WARRANTY DOES NOT COVER PACKING MATERIALS, ANY ACCESSORIES (EXCEPT REMOTE CONTROL), ANY COSMETIC PARTS, COMPLETE ASSEMBLY PARTS, DEMO OR FLOOR MODELS.

FUNAI CORP. AND ITS REPRESENTATIVES OR AGENTS SHALL IN NO EVENT BE LIABLE FOR ANY GENERAL, INDIRECT OR CONSEQUENTIAL DAMAGES ARISING OUT OF OR OCCASIONED BY THE USE OF OR THE INABILITY TO USE THIS PRODUCT. THIS WARRANTY IS MADE IN LIEU OF ALL OTHER WARRANTIES, EXPRESS OR IMPLIED, AND OF ALL OTHER LIABILITIES ON THE PART OF FUNAI, ALL OTHER WARRANTIES INCLUDING THE WARRANTY OF MERCHANTABILITY AND FITNESS FOR A PARTICULAR PURPOSE, ARE HEREBY DISCLAIMED BY FUNAI AND ITS REPRESENTATIVES IN THE UNITED STATES.

ALL WARRANTY INSPECTIONS AND REPAIRS MUST BE PERFORMED BY AN AUTHORIZED SERVICE CENTER. THIS WARRANTY IS ONLY VALID WHEN THE UNIT IS CARRIED-IN TO AN AUTHORIZED SERVICE CENTER.

THE PRODUCT MUST BE ACCOMPANIED BY A COPY OF THE ORIGINAL RETAIL PURCHASE RECEIPT. IF NO PROOF OF PURCHASE IS ATTACHED, THE WARRANTY WILL NOT BE HONORED AND REPAIR COSTS WILL BE CHARGED.

IMPORTANT:

THIS LIMITED WARRANTY GIVES YOU SPECIFIC LEGAL RIGHTS. YOU MAY HAVE OTHER RIGHTS THAT VARY FROM STATE TO STATE. IF, AT ANY TIME DURING THE WARRANTY PERIOD, YOU ARE UNABLE TO OBTAIN SATISFACTION WITH THE REPAIR OF THIS PRODUCT, PLEASE CONTACT FUNAI CORP.

ATTENTION:

FUNAI CORP. RESERVES THE RIGHT TO MODIFY ANY DESIGN OF THIS PRODUCT WITHOUT PRIOR NOTICE.

WARRANTY STATEMENT REGARDING NON AUTHORIZED REPAIRS:

To obtain warranty service, you must take the product, or deliver the product freight prepaid, in either its original packaging or packaging affording an equal degree of protection, to any AUTHORIZED SERVICE CENTER. FUNAI CORP. will not reimburse you for any service done by unauthorized service providers without prior written approval.

To locate your nearest AUTHORIZED SERVICE CENTER or for general service inquiries, please contact us at:

FUNAI CORPORATION

Customer Service

Tel : 1-800-968-3429

<http://www.SylvaniaConsumerElectronics.com>

19900 Van Ness Avenue, Torrance, CA 90501