



FR6874 Mobile Computer User Guide



***FR6874 Enterprise Digital
Assistant
User Guide***

*Rev.A
Jan.2009*

© 2008 by Motorola, Inc. All rights reserved.

No part of this publication may be reproduced or used in any form, or by any electrical or mechanical means, without permission in writing from Motorola. This includes electronic or mechanical means, such as photocopying, recording, or information storage and retrieval systems. The material in this manual is subject to change without notice.

The software is provided strictly on an “as is” basis. All software, including firmware, furnished to the user is on a licensed basis. Motorola grants to the user a non-transferable and non-exclusive license to use each software or firmware program delivered hereunder (licensed program). Except as noted below, such license may not be assigned, sublicensed, or otherwise transferred by the user without prior written consent of Motorola. No right to copy a licensed program in whole or in part is granted, except as permitted under copyright law. The user shall not modify, merge, or incorporate any form or portion of a licensed program with other program material, create a derivative work from a licensed program, or use a licensed program in a network without written permission from Motorola. The user agrees to maintain Motorola’s copyright notice on the licensed programs delivered hereunder, and to include the same on any authorized copies it makes, in whole or in part. The user agrees not to decompile, disassemble, decode, or reverse engineer any licensed program delivered to the user or any portion thereof.

Motorola reserves the right to make changes to any software or product to improve reliability, function, or design.

Motorola does not assume any product liability arising out of, or in connection with, the application or use of any product, circuit, or application described herein.

No license is granted, either expressly or by implication, estoppel, or otherwise under any Motorola, Inc., intellectual property rights. An implied license only exists for equipment, circuits, and subsystems contained in Motorola products.

MOTOROLA and the Stylized M Logo and Symbol and the Symbol logo are registered in the US Patent & Trademark Office. Bluetooth is a registered trademark of Bluetooth SIG. Microsoft, Windows and ActiveSync are either registered trademarks or trademarks of Microsoft Corporation. All other product or service names are the property of their respective owners.

Motorola, Inc.
One Motorola Plaza
Holtsville, New York 11742-1300
<http://www.motorola.com>

Patents

This product is covered by one or more of the patents listed on the website: www.symbol.com/patents.

Revision History

Changes to the original manual are listed below:

Change	Date	Description
-01 Rev. A		Initial release.

DECLARATION OF CONFORMITY

CE Regulations:

Hereby, declares that this FR6874 product is in compliance with the essential requirements and other relevant provisions of Directive 1999/5/EC.

To which this declaration relates, is in conformity with the following standards

EN 301 511 9.0.2

EN300328 V1.7.1

EN300440-2 V1.2.1

EN 301 489-1 V1.8.1

EN301 489-3 V1.4.1

EN301 489-7 V1.3.1

EN301 489-17 V1.3.2

EN 60950-1:2001+A11:2004

EN50360:2001/ EN62209-1:2006

EN 55022:2006+A1:2007

EN55024:1998+A2:2003+A1:2001

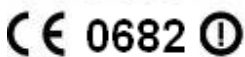

FCC Regulations:

This device complies with part 15 of the FCC Rules. Operation is subject to the following two conditions: (1) This device may not cause harmful interference, and (2) this device must accept any interference received, including interference that may cause undesired operation.

This device has been tested and found to comply with the limits for a Class B digital device, pursuant to Part 15 of the FCC Rules. These limits are designed to provide reasonable protection against harmful interference in a residential installation. This equipment generates, uses and can radiated radio frequency energy and, if not installed and used in accordance with the instructions, may cause harmful interference to radio communications. However, there is no guarantee that interference will not occur in a particular installation. If this equipment does cause harmful interference to radio or television reception, which can be determined by turning the equipment off and on, the user is encouraged to try to correct the interference by one or more of the following measures:

- Reorient or relocate the receiving antenna.
- Increase the separation between the equipment and receiver.
- Connect the equipment into an outlet on a circuit different from that to which the receiver is connected.
- Consult the dealer or an experienced radio/TV technician for help.

Changes or modifications not expressly approved by the party responsible for compliance could void the user's authority to operate the equipment.

RF Exposure Information (SAR)

This device meets the government's requirements for exposure to radio waves.

This device is designed and manufactured not to exceed the emission limits for exposure to radio frequency (RF) energy set by the Federal Communications Commission of the U.S. Government.

The exposure standard for wireless devices employs a unit of measurement known as the Specific Absorption Rate, or SAR. The SAR limit set by the FCC is 1.6W/kg. Tests for SAR are conducted using standard operating positions accepted by the FCC with the device transmitting at its highest certified power level in all tested frequency bands. Although the SAR is determined at the highest certified power level, the actual SAR level of the device while operating can be well below the maximum value. This is because the device is designed to operate at multiple power levels so as to use only the power required to reach the network. In general, the closer you are to a wireless base station antenna, the lower the power output.

The highest SAR value for the device as reported to the FCC when tested for use at the ear is **0.667** W/kg and when worn on the body, as described in this user guide, is **1.370** W/kg. (Body-worn measurements differ among device models, depending upon available enhancements and FCC requirements.)

For WLAN Head SAR and when worn on the body, as described in this user guide, is 0.032 W/kg for WLAN Head SAR and 0.058 W/kg for WLAN Body SAR.

While there may be differences between the SAR levels of various devices and at various positions, they all meet the government requirement.

The FCC has granted an Equipment Authorization for this device with all reported SAR levels evaluated as in compliance with the FCC RF exposure guidelines. SAR information on this device is on file with the FCC and can be found under the Display Grant section of <http://www.fcc.gov/oet/fccid> after searching on FCC ID: **H9PFR6874**.

For body worn operation, this device has been tested and meets the FCC RF exposure guidelines for use with an accessory that contains no metal and the positions the handset a minimum of 1.5 cm from the body. Use of other enhancements may not ensure compliance with FCC RF exposure guidelines.

Using Your Phone With a Hearing Aid Device

FR6874 is compliant with the FCC Hearing Aid Compatibility (HAC) requirements. For additional HAC information, including the HAC rating of this product, some wireless phones are used near some hearing devices (hearing aids and cochlear implants), users may detect a buzzing, humming, or whining noise. Some hearing devices are more immune than others to this interference noise, and phones also vary in the amount of interference they generate. The wireless telephone industry has developed ratings for some of their mobile phones, to assist hearing-device users in finding phones that may be compatible with their hearing devices. Not all phones have been rated. Phones that have been rated have a label on the box. FR6874 has been tested for hearing aid device compatibility and has an **M3** and/or **T3** rating.

These ratings are not guarantees. Results will vary, depending on the level of immunity of your hearing device and the degree of your hearing loss. If your hearing device happens to be vulnerable to interference, you may not be able to use a rated phone successfully. Trying out the phone with your hearing device is the best way to evaluate it for your personal needs.

M-Ratings: Phones rated M3 or M4 meet FCC requirements and are likely to generate less interference with hearing devices than phones that are not labeled. M4 is the better/higher of the two ratings. T-Ratings: Phones rated T3 or T4 meet FCC requirements and are likely to be more usable with a hearing device's telecoil ("T Switch" or "Telephone Switch") than unrated phones. T4 is the better/higher of the two ratings. (Note that not all hearing devices contain telecoils.) The more immune your hearing aid device is, the less likely you are to experience interference noise from your wireless phone. Hearing aid devices should have ratings similar to those of phones. Ask your hearing health-care professional for the rating of your hearing aid.

Hearing devices may also be measured for immunity to this type of interference. Your hearing device manufacturer or hearing health professional may help you find results for your hearing device. The more immune your hearing aid is, the less likely you are to experience interference noise from wireless devices.

For additional information about the FCC's actions with regard to hearing aid compatible wireless devices and other steps the FCC has taken to ensure that individuals with disabilities have access to telecommunications services, please go to www.fcc.gov/cgb/dro.

Turning on the HAC Setting

When the HAC setting is on, FR6874 sends the audio from your phone calls to the telecoil rather than to the microphone of your hearing aid. You are likely to hear calls much better because volume is increased and background noise and feedback are diminished. The HAC setting improves only the calls you listen to through the earpiece. Turn off the [Bluetooth](#) function. Turn off the [WiFi](#) function. It does not affect calls heard on the speakerphone or with or a headset. HAC requires extra battery power, so watch your battery consumption when it's turned on.



FCC ID:H9PFR6874



Table of Contents

About This Guide.....	12
Introduction	12
Documentation Set	12
Configurations.....	13
Software Versions	13
Phone Software	13
Chapter Descriptions	14
Notational Conventions	14
Related Documents.....	15
Service Information.....	15
Chapter 1 Getting Started.....	11
Introduction	11
Unpacking.....	12
Accessories	13
Getting Started.....	14
Installing the SIM Card	14
Installing the Main Battery	15
Charging the Battery.....	15
Charging the Main Battery and Memory Backup Battery.....	15
Charging Spare Batteries.....	17
Charging Temperature	17
Powering On the FR6874	17
Calibrating the Screen	17
Checking Battery Status	17
Micro Secure Digital (microSD) Card	18
Removing the Screen Protector.....	19
Replacing the Main Battery.....	19
Battery Management	20
Changing the Power Settings.....	20
Changing the Backlight Settings.....	20
Turning Off the Radios	21

Chapter 2 Using the FR6874	22
Introduction	22
Today Screen.....	22
Status Icons	23
Programs	25
Settings.....	28
Adjusting Volume	31
Power Setting.....	32
Main Battery Temperature Notifications	33
LED Indicators	34
Resetting the FR6874.....	35
Performing a Warm Boot.....	35
Performing a Cold Boot.....	35
Waking the FR6874.....	35
Locking the FR6874.....	36
Keypads.....	37
Alpha-numeric Keypad Configurations.....	37
Function Buttons	41
Stylus.....	42
Entering Data	42
Data Capture	43
Linear Scanning.....	43
Scanning Considerations.....	43
Taking Photos	44
Recording Video	44
Infrared Connection	46
Exchanging Files using IR Connection	46
Adding New Network	51
Chapter 3 Using GPS	54
Introduction	54
Software Installation.....	54
FR6874 GPS Setup	54
Operation.....	55
GPS Maps on microSD Cards.....	55
Downloading GPS Data	55
Answering a Phone Call While Using GPS.....	56
Losing the GPS Signal While in a Vehicle	56
Assisted GPS	56
Chapter 4 Using Bluetooth.....	58
Introduction	58
Adaptive Frequency Hopping.....	58
Security.....	59
Turning the Bluetooth Radio Mode On and Off.....	61
Disabling Bluetooth	61
Enabling Bluetooth.....	61
Bond New Device(s)	62
File Transfer Services	63
Bluetooth Settings.....	64

Device Info Tab	64
Mode Tab	64
COM Ports Tab	64
Chapter 5 Using the Phone	66
Introduction	66
Accessing the Phone Keypad	66
Turning the Phone On and Off	67
Audio Modes	68
Using a Wired Headset	68
Adjusting Audio Volume	69
Making a Call	70
Using the Phone	70
Using Contacts	70
Using Call History	71
Making a Speed Dial Call	71
Making an Emergency Call	72
Answering a Call	72
Incoming Call Features	73
Smart Dialing	73
Taking Notes	75
Using Speed Dial	76
Adding a Speed Dial Entry	76
Editing a Speed Dial Entry	78
Deleting a Speed Dial Entry	79
Using Call History	80
Managing Call History	80
Changing the Call History View	80
Resetting the Recent Calls Counter	80
Deleting Call History Items by Call Date	81
Deleting All Call History Items	82
Viewing Call Status	83
Using the Call History Menu	83
Swapping Calls on an FR687476	84
Conference Calling on an FR687476	85
Text Messaging	86
Viewing Text Messages	86
Sending a Text Message	88
Chapter 6 Accessories	90
Introduction	90
Single Slot USB/Serial Cradle	90
Charging the FR6874 Battery	90
Charging the Spare Battery	91
Battery Charging Indicators	92
Charging Temperature	92
Headset	93
Cables	93
Battery Charging and Operating Power	94
LED Charge Indications	94

Charging Temperature	94
Chapter 7 Maintenance&Troubleshooting.....	95
Introduction	95
Maintaining the FR6874	95
Battery Safety Guidelines	96
Cleaning.....	97
Materials Required	97
Cleaning the FR6874	97
Housing	97
Display	97
Scanner Exit Window	97
Connector	97
Cleaning Cradle Connectors.....	98
Cleaning Frequency.....	98
Troubleshooting.....	99
FR6874	99
Bluetooth Connection.....	101
Single Slot USB/Serial Cradle	102
Cables.....	103



About This Guide

Introduction

This guide provides information about using the FR6874 Enterprise Digital Assistant (EDA) and accessories.

✓ **NOTE** Screens and windows pictured in this guide are samples and can differ from actual screens.

Documentation Set

The documentation set for the FR6874 provides information for specific user needs, and includes:

- **FR6874 Quick Start Guide** - describes how to get the FR6874 up and running.
- **FR6874 User Guide** - describes how to use the FR6874.

Configurations

This guide covers the following configurations:

Configuration	Radios	Display	Memory	Data Capture	Operating System	Keypads
FR6874	WPAN: Bluetooth WWAN GPS: AGPS	2.8" QVGA Color	128 MB RAM/ 256 MB Flash	1D laser scanner, 2D imager or camera	Windows Mobile 6 Professional	Alphanumeric keypad

Software Versions

This guide covers various software configurations and references are made to operating system or software versions for:

- Adaptation Kit Update (AKU) version
- Phone version

AKU Version

To determine the Adaptation Kit Update (AKU) version:

Tap **Start** > **Settings** > **System** tab > **About** icon > **Version** tab.

The second line lists the operating system version and the build number. The last part of the build number represents the AKU number. For example, *Build 18552.0.7.5* indicates that the device is running AKU version *0.7.5*.

Phone Software

To determine the Phone software version:

Tap **Start** > **Phone** > **Menu** > **Options** > **Phone Info** tab.

Chapter Descriptions

Topics covered in this guide are as follows:

- [Chapter 1, Getting Started](#) provides information on getting the FR6874 up and running for the first time.
 - [Chapter 2, Using the FR6874](#) provides basic instructions for using the FR6874, including powering on and resetting the FR6874, and entering and capturing data.
 - [Chapter 3, Using GPS Navigation](#) provides information about GPS navigation with the FR6874.
 - [Chapter 4, Using Bluetooth](#) explains Bluetooth functionality on the FR6874.
 - [Chapter 5, Using the Phone](#) provides basic instructions for using the FR6874 phone.
 - [Chapter 6, Accessories](#) describes the available accessories and how to use them with the FR6874.
 - [Chapter 7, Maintenance & Troubleshooting](#) includes instructions on cleaning and storing the FR6874, and provides troubleshooting solutions for potential problems during FR6874 operation.
 - [Appendix A, Technical Specifications](#) provides the technical specifications for the FR6874.
 - [Appendix B, Voice Quality Manager](#) provides information on using the Voice Quality Manager software.
-

Notational Conventions

The following conventions are used in this document:

- “EDA” refers to the Motorola FR6874 series of hand-held computers.
- *Italics* are used to highlight the following:
 - Chapters and sections in this and related documents
 - Icons on a screen.
- **Bold** text is used to highlight the following:
 - Dialog box, window, and screen names
 - Drop-down list and list box names

- Check box and radio button names
 - Key names on a keypad
 - Button names on a screen.
 - bullets (•) indicate:
 - Action items
 - Lists of alternatives
 - Lists of required steps that are not necessarily sequential
 - Sequential lists (e.g., those that describe step-by-step procedures) appear as numbered lists.
-

Related Documents

- *FR6874 Quick Start Guide*, p/n 72-103079-xx.
- *FR6874 Windows Mobile 6 Regulatory Guide*, p/n 72-103080-xx.
- *FR6874 Integrator Guide*, p/n 72E-103078-xx.
- *Microsoft® Applications for Mobile 6 User Guide*, p/n 72E-108299-xx
- *Enterprise Mobility Application Guide*, p/n 72E-68901-xx
- *Enterprise Mobility Developer Kits (EMDKs)*, available at: <http://support.symbol.com/>.
- Latest ActiveSync software, available at: <http://www.microsoft.com>.

For the latest version of this guide and all guides, go to: <http://www.symbol.com/manuals>.

Service Information

If you have a problem with your equipment, contact Motorola Enterprise Mobility support for your region. Contact information is available at: <http://www.symbol.com/contactsupport>.

When contacting Enterprise Mobility support, please have the following information available:

- Serial number of the unit
- Model number or product name
- Software type and version number

Motorola responds to calls by email, telephone or fax within the time limits set forth in support

agreements.

If your problem cannot be solved by Motorola Enterprise Mobility Support, you may need to return your equipment for servicing and will be given specific directions. Motorola is not responsible for any damages incurred during shipment if the approved shipping container is not used. Shipping the units improperly can possibly void the warranty.

If you purchased your Enterprise Mobility business product from a Motorola business partner, contact that business partner for support.



Chapter 1 Getting Started

Introduction

This chapter lists the parts and accessories for the FR6874 and explains how to install and charge the batteries, replace the strap, and power on the FR6874 for the first time.

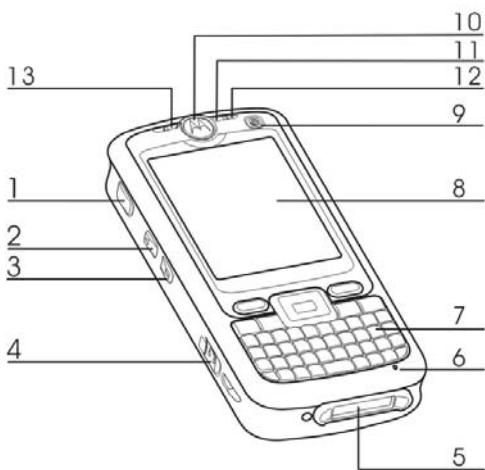

Figure 1-1 FR6874 Front View

- 1. Scan Button
- 2. Up Button
- 3. Down Button
- 4. Headset Jack
- 5. I/O Connector
- 6. Microphone
- 7. Keypad
- 8. Touch Screen
- 9. Power Button
- 10. Scan/Decode LED

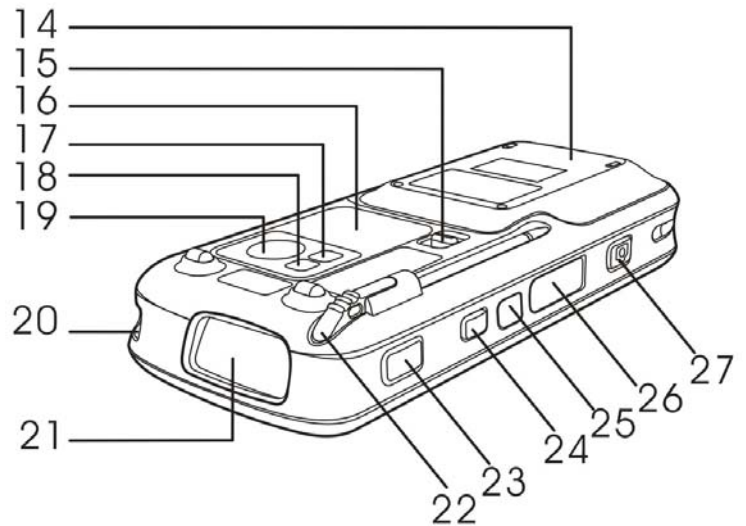

Figure 1-2 FR6874 Rear View

- 14. Battery Door
- 15. Door Latch
- 16. Speaker
- 17. Camera Flash
- 18. Self-view Mirror
- 19. Camera
- 20. Tether Point
- 21. Scan Window
- 22. Stylus
- 23. Scan Button
- 24. [unlabeled]
- 25. [unlabeled]
- 26. [unlabeled]
- 27. [unlabeled]

11. Charging LED 12. Radio Status LED

24. Hold Key

25. IrDA Window

13. Receiver

26. Memory Card Slot

27. Camera Button

Unpacking

Carefully remove all protective material from the FR6874 and save the shipping container for later storage and shipping.

Verify that you received the following:

- FR6874 EDA
- 1950 mAh Lithium-ion battery
- Battery cover/strap assembly
- Tethered stylus
- Protective overlay, installed on display window
- Regulatory Guide
- Quick Start Guide.

Inspect the equipment for damage. If any equipment is missing or damaged, contact the Motorola Enterprise Mobility Support center immediately. See [page xvi](#) for contact information.

Accessories

[Table 1-1](#) lists the accessories available for the FR6874.

Table 1-1 FR6874 Accessories

[Table 1-1](#) lists the accessories available for the FR6074.

Table 1-1 FR6074 Accessories

Manufacturing Part Number	Description		
Cradle			
CRD7X00-1000RR(Optional)	MC70/MC75/FR68/FR6000 Series RoHS Compliant Single Slot USB Cradle with Spare Battery Charging: Must Order power adapter (KT-14000-148) and US AC Line Cord (23844-00-00R) separately.		

Power Adapter			
KT-14000-148R(Optional)	Power adapter (HP-O2040D43) manufacture from HIPRO with following (1)Input 100-240V,50-60Hz,1.5A (2)Output 12V, 3.33A.		
50-14000-249R(Optional)	Power adapter (EADP-16BBA)manufacture from Delta Electronics Ltd. with following (1)Input 100-240V,50-60Hz,0.4A (2)Output 5.4V, 3A.		

USB Charging Cable			
25-118703-01R(Optional)	FR6000 series USB Charging Cable. Requires power adapter (P/N:50-14000-249R.) Model:EADP-16BBA, Manufacture: Delta Electronics Ltd.		

Line Cords			
23844-00-00R(Optional)	AC Line Cord, 2.3M, grounded, NEMA 5-15P plug. Associated Countries: Brazil, United States		
50-16000-217R(Optional)	AC Line Cord, 1.8M, grounded, AS 3112 plug. Associated Country: Australia, China, New Guinea		

Getting Started

To start using the FR6874 for the first time:

- Install the SIM card (FR687474 and FR687476 only)
- Install the main battery.
- Charge the FR6874.
- Power on the FR6874.
- Configure the FR6874.

Installing the SIM Card

✓ **NOTE** FR687474 and FR687476 configurations only.

GSM phone service requires a Subscriber Identification Module (SIM) card, or smart card. Obtain this card from your service provider. The card fits into the FR6874 and can contain the following information:

- Mobile phone service provider account details.
- Information regarding service access and preferences.
- Contact information, which can be moved to **Contacts** on the FR6874.
- Any additional services to which you have subscribed.

✓ **NOTE** For more information about SIM cards, refer to the service provider's documentation.

To install the SIM card(Located Under Battery):

Place SIM card with contacts facing down

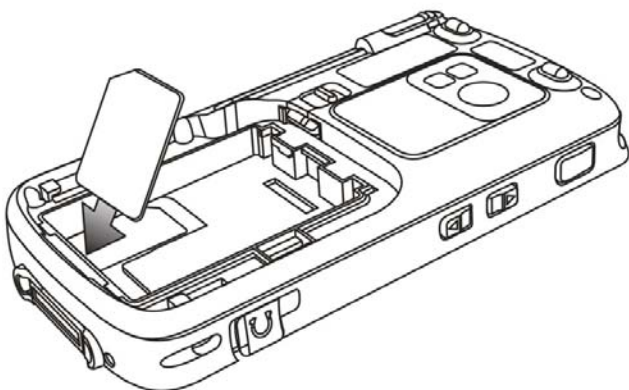

Figure 1-3 *Install the SIM*

1. Install the battery See *Installing the Main Battery* on page 1-6 for more information.
2. Press the red **Power** button.
3. Tap **Start > Phone > Menu > Options > Network** tab and verify that the service provider appears in the **Current network:** field.

4. Make a call to verify connection.

✓ **NOTE** For detailed information about WWAN activation and settings, refer to the *FR6874 Integrator Guide*.

Installing the Main Battery

✓ **NOTE** The FR6874 ships with a **1950 mAh** battery. An optional **3600 mAh** battery is available.

To install the main battery:

1. Insert the battery, top first, into the battery compartment in the back of the FR6874.

✓ **NOTE** Position the battery correctly, with the battery charging contacts on top of the charging contacts in the battery compartment.

2. Press the battery down into the battery compartment until the battery release latch snaps into place.

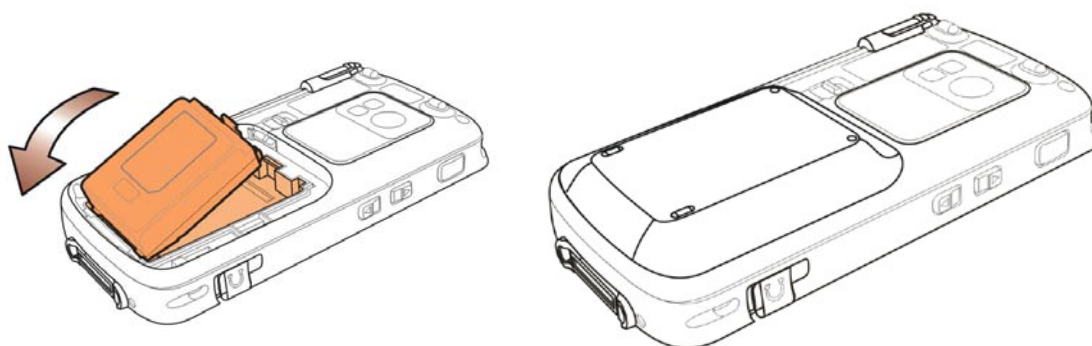

Figure 1-4/1-5 Inserting the Battery

3. With the battery cover latches open, insert the cover, bottom first, then press down on the top of the cover.
4. Close the battery cover latches on either side of the battery cover.

The FR6874 powers up after inserting the battery and replacing the battery cover.

Charging the Battery

CAUTION Ensure that you follow the guidelines for battery safety described in *Battery Safety Guidelines* on page 7-2.

Charging the Main Battery and Memory Backup Battery

Before using the FR6874 for the first time, charge the main battery until the amber Charging/Battery Status LED remains lit (see [Table 1-2 on page 1-7](#) for charge status indications). To charge the FR6874, use a cable or a cradle with the appropriate power supply. For information about the accessories available for the FR6874, see [Chapter 6, Accessories](#).

The FR6874 is equipped with a memory backup battery which automatically charges from the fully-charged main battery. When using the FR6874 for the first time, the backup battery requires approximately 36 hours to fully charge. This is also true any time the backup battery is discharged, which occurs when the main battery is removed for several hours. The backup battery retains RAM data in memory for at least 15 minutes (at room temperature) when the FR6874's main battery is removed. When the FR6874 reaches a very low battery state, the combination of main battery and backup battery retains RAM data in memory for at least 48 hours.

To charge the main battery, use either a charging cable or a cradle. For cable and cradle setup and charging procedures refer to the *FR6874 Integrator Guide*.

- Single Slot USB/Serial Cradle
- Vehicle Cradle.

To charge the main battery:

1. Connect the charging accessory to the appropriate power source.
2. Insert the FR6874 into a cradle or attach to a cable. The FR6874 begins charging. The Charging/Battery Status LED blinks amber while charging, then turns solid green when fully charged. See [Table 1-2](#) for charging indications.

The **1950 mAh** battery fully charges in approximately five hours and the **3600 mAh** battery charges in approximately seven hours.

Table 1-2 LED Charge Indicators

Charging/Battery Status LED	Indication
Off	FR6874 is not charging. FR6874 is not inserted correctly in the cradle or connected to a power source. Charger/cradle is not powered.
Slow Blinking Amber (1 blink every 2 seconds)	FR6874 is charging.
Solid Green	Charging complete. Note: When the battery is initially inserted in the FR6874, the amber LED flashes once if the battery power is low or the battery is not fully inserted.
Fast Blinking Red (2 blinks/second)	Charging error, e.g.: <ul style="list-style-type: none"> • Temperature is too low or too high. • Charging has gone on too long without completion (typically eight hours).

Table 1-2 LED Charge Indicators (Continued)

Charging/Battery Status LED	Indication
Single Blink Amber (when device is turned on)	Battery depleted.
Blink Amber (Battery charger temperature is too high.)	Battery over-temperature condition.

Charging Spare Batteries

See [Chapter 6, Accessories](#) for information on using accessories to change spare batteries.

Charging Temperature

Charge batteries in temperatures from **0°C to 45°C (32°F to 113°F)**. Charging is intelligently controlled by the FR687

4.

To accomplish this, for small periods of time, the FR6874 or accessory alternately enables and disables battery charging to keep the battery at acceptable temperatures. The FR6874 or accessory indicates when charging is disabled due to abnormal temperatures via its LED. See [Table 1-2](#).

Powering On the FR6874

Press the **Power** button to turn on the FR6874. If the FR6874 does not power on perform a warm boot. See [Resetting the FR6874 on page 2-14](#).

When turning the FR6874 on for the first time, the splash screen displays for about a minute as the FR6874 initializes its flash file system, then the calibration window appears. Note that these windows also appear upon cold boot.



NOTE When the FR6874 powers up after inserting a battery for the first time, the device boots and powers on automatically.

Calibrating the Screen

To calibrate the screen so the cursor on the touch screen aligns with the tip of the stylus:

1. Remove the stylus from its holder on the back of the FR6874.
2. Carefully press and briefly hold the tip of stylus on the center of each target that appears on the screen.
3. Repeat as the target moves around the screen, then tap the screen to continue.

Checking Battery Status

To check the charge status of the main battery or backup battery in the FR6874, tap **Start > Settings > System tab > Power** icon to display the **Power** window.

To save battery power, tap the **Advanced** tab and set the FR6874 to turn off after a specified number of minutes.

Micro Secure Digital (microSD) Card

The microSD card slot provides secondary non-volatile storage. The slot is located on the side of the FR6874 (see [Figure 1-7](#)). Refer to the documentation provided with the card for more information, and follow the manufacturer's recommendations for use.



CAUTION Follow proper ESD precautions to avoid damaging the microSD card. Proper ESD precautions include, but are not limited to, working on an ESD mat and ensuring that the operator is properly grounded.

To install the microSD card:

1. Power off the FR6874.
2. Remove the memory card cover on the side of the FR6874 .

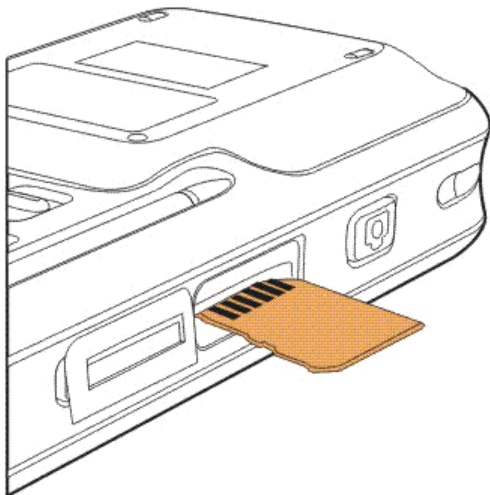

Figure 1-6 *Card Installation*

3. Insert the card with the card contacts facing up and the cut corner on the left, until you feel a click.
4. Replace the memory card cover .

To remove an microSD card:

1. Power off the FR6874.
2. Remove the memory card cover.
3. Carefully press and release the card to eject it.
4. Remove the card from the card slot.
5. Replace the memory card cover.

Removing the Screen Protector

A screen protector is applied to the FR6874. Motorola recommends using this to minimize wear and tear. Screen protectors enhance the usability and durability of touch screen displays.

To remove the screen protector, lift the corner using a thin plastic card, such as a credit card, then carefully lift it off the display.

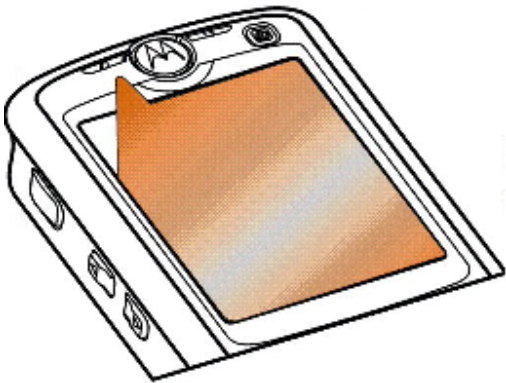

Figure 1-7 *Removing the Screen Protector*



CAUTION Do not use a sharp object to remove the protector. Doing so can damage the display.



NOTE Not using a screen protector can affect warranty coverage. To purchase replacement protectors, contact your local account manager or Motorola, Inc. These include screen protector installation instructions. Part number: KT-93765-01R Screen Protector 3/pk.

Replacing the Main Battery

1. Press the red **Power** button to suspend the FR6874.
2. Open the battery cover latches on either side of the battery cover.
3. Lift the top of the battery cover and remove.
4. Press the battery release latch on the bottom of the battery to unlock, and lift the battery out of the well.
5. Insert the replacement battery, top first, into the battery compartment in the back of the FR6874.
6. Press the battery down into the battery compartment until the battery release latch snaps into place.



NOTE Position the battery correctly, with the battery charging contacts on top of the charging contacts in the battery compartment.

7. With the battery cover latches open, insert the cover, bottom first, then press down on the top of the cover.
8. Close the battery cover latches on either side of the battery cover.

The FR6874 powers up after the battery is inserted and the battery cover is replaced.

Battery Management

Observe the following battery saving tips:



NOTE The FR6874 factory default settings for the WWAN and WLAN radios are set to ON.

- Leave the FR6874 connected to AC power at all times when not in use.
- Set the FR6874 to turn off after a short period of non-use.
- Set the backlight to turn off after a short period of non-use.
- Turn off all wireless activities when not in use.
- Power off the FR6874 when charging to charge at a faster rate.

Changing the Power Settings

To set the FR6874 to turn off after a short period of non-use:

1. Tap **Start > Settings > System tab > Power icon > Advanced tab**.
2. Select the **On battery power: Turn off device if not used for** check box and select a value from the drop-down list.
3. Select **ok**.

Changing the Backlight Settings

To change the backlight settings in order to conserve more battery power:

1. Tap **Start > Settings > System tab > Backlight icon > Power tab**.
2. Select the **Turn off backlight if device is not used for** check box and select a value from the drop-down list.
3. Select the **Brightness** tab.
4. Use the slider to set a low value for the backlight.
5. Select **ok**.

Turning Off the Radios

Windows Mobile 6 devices include **Wireless Manager**, which provides a simple method of enabling, disabling, and configuring all the device's wireless capabilities in one place.

To open **Wireless Manager**, tap the **Connectivity** icon or tap **Wireless Manager** on the **Today** screen.

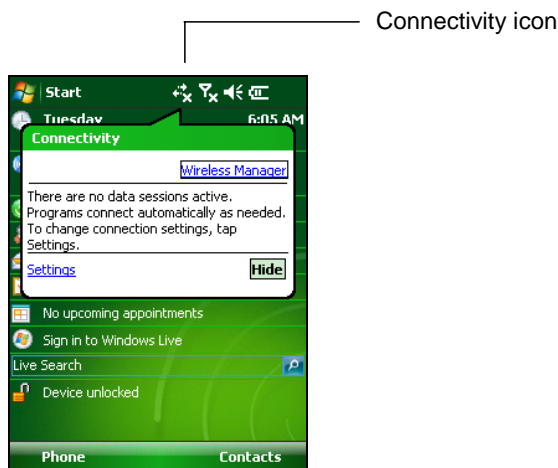

Figure 1-8 Opening Wireless Manager

Select **Wireless Manager**.



Figure 1-9 Wireless Manager Window

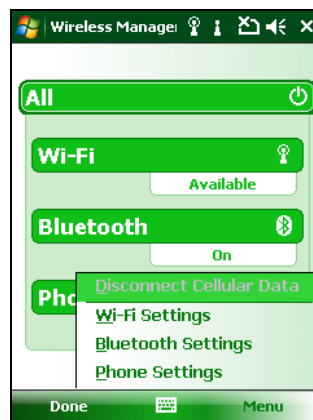

Figure 1-10 Wireless Manager Menu



NOTE Wireless connection options vary depending upon configurations.

To enable or disable a wireless connection, tap the specific button.

To enable or disable all wireless connections, tap the **All** button. To configure settings for a connection, tap **Menu**.

Chapter 2 Using the FR6874

Introduction

This chapter explains the buttons, status icons, and controls on the FR6874, and provides basic instructions for using the FR6874, including powering on and resetting the FR6874, and entering and capturing data.

The FR6874 factory default radio states are:

- Bluetooth - OFF
- Phone - ON
- Wireless LAN - ON.

Today Screen

The Today screen displays important information, such as upcoming appointments and status indicators. Tap a section on the screen to open the associated program. Alternatively, tap **Start > Today** to display the **Today** screen.

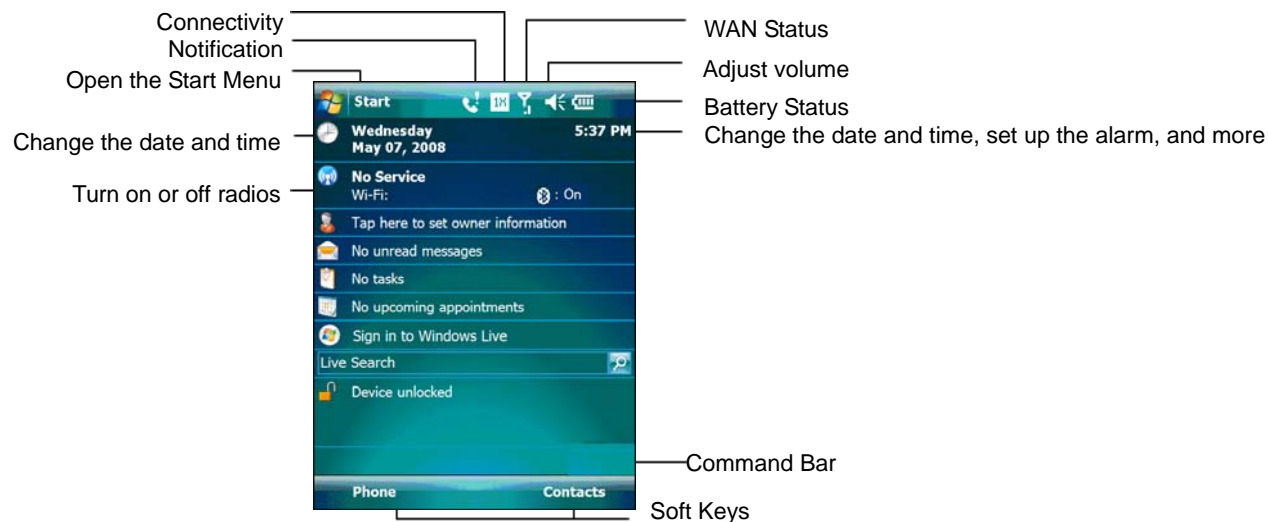

Figure 2-1 Today Screen

To customize the **Today** screen, tap **Start > Settings > Today** icon. Use the **Appearance** tab to customize the background and the **Items** tab to change the list and order of items that appear on the screen.























Status Icons

The Navigation bar at the top of the screen can contain the status icons listed in [Table 2-1](#).

Table 2-1 *Status Icons*





Icon	Function	Description
	Notification	Backup Battery Low.
		Notification that one or more instant messages were received.
		Notification that one or more e-mail/text messages were received.
		Notification that one or more voice messages were received.
		There are more notification icons than can be displayed. Tap to display remaining icons.
		Indicates a reminder of an upcoming calendar event.
	Connectivity	Connection is active.
		Connection is not active.
		Synchronization is occurring.
		Wi-Fi available.
		Wi-Fi in use.
		GPRS available.
		EGPRS available.
		Dormant State - no data transmission during a 1x connection.

Table 2-1 Status Icons (Continued)

Icon	Function	Description
	WAN	Call missed.
		Dialing while no SIM card is installed.
		Voice call in progress.
		Calls are forwarded.
		Call on hold.
		Speakerphone is on.
		Antenna/signal icon: wireless on/good signal.
		Antenna/signal icon: wireless off.
		Antenna/signal icon: no service or searching.
		GPRS connecting. (FR687474 and FR687476)
		GPRS in use. (FR687474 and FR687476)
		EGPRS connecting. (FR687406 and FR687496)
		EGPRS in use. (FR687406 and FR687496)
		Roaming.
		SIM Card not installed. (FR687474 and FR687476)
	Speaker	All sounds are on.
		All sounds are off.
		Vibrate is on.
	Battery	Main battery is charging.
		Battery power completely depleted.
		Main battery is low.
		Main battery level.
	Time and Next Appointment	Displays current time in analog or digital format.

The command bar at the bottom of the screen can contain the task tray icons listed in [Table 2-2](#).

Table 2-2 *Task Tray Icons*

Icon	Description	
	Wireless connection status	Indicates WLAN signal strength.
	Bluetooth Enabled	Bluetooth radio is on.
	Bluetooth Disabled	Bluetooth radio is off.
	Bluetooth Connection	Bluetooth radio is connected to another Bluetooth device.
	ActiveSync	Active serial connection between the FR6874 and the host computer.

Programs

[Table 2-3](#) lists the default programs on the **Start** menu.

Table 2-3 *Programs in the Start Menu*





Icon	Name	Description
	Office Mobile	Use the complete suite of Microsoft® Office applications for your mobile device. Excel Mobile - Create new workbooks or view and edit Microsoft® Excel® workbooks. OneNote Mobile - Create new notes or view existing notes. PowerPoint Mobile - View Microsoft® PowerPoint® slides and presentations. Word Mobile - Create, view, and edit Microsoft® Word documents.
	Calendar	Keep track of appointments and create meeting requests.
	Contacts	Keep track of friends and colleagues.
	Internet Explorer Mobile	Browse Web and WAP sites as well as download new programs and files from the Internet.

Table 2-3 *Programs in the Start Menu*



Icon	Name	Description
	Messaging	Send and receive e-mail, MMS, and text messages.
	Phone	Make and receive calls, switch between calls, and set up conference calling.
	Help	See Help topics for the current screen or program.

Table 2-4 lists programs that are listed in the Programs window.

Table 2-4 *Programs in Program Window*



















Icon	Name	Description
	ActiveSync	Synchronize information between the FR6874 and a host computer or the Exchange Server.
	Games	Bubble Breaker, Solitaire
	Sample AP	DataWedge, Notify, and Scanner
	Calculator	Perform basic arithmetic and calculations, such as addition, subtraction, multiplication, and division.
	File Explorer	Organize and manage files on your device.
	GPSXtra	Allow you to download GPS data to enhance GPS performance
	Getting Started	Help about how to use some functions
	Camera	Picture and video shooting
	Internet Sharing	Connect a notebook computer to the Internet using the FR6874's data connection.
	Messenger	Use this mobile version of Windows Live Messenger.













Table 2-4 *Programs in Program Window (Continued)*

Icon	Name	Description
	Notes	Create handwritten or typed notes, drawings, and voice recordings.
	Pictures & Videos	View and manage pictures, animated GIFs, and video files.
	Search	Search contacts, data, and other information on your FR6874.
	SIM Toolkit	Manage the contacts that are stored on your SIM card. Copy SIM contents to Contacts on the FR6874.
	Task Manager	Show and stop all the tasks on run
	Tasks	Keep track of your tasks.
	Windows Live	Use this mobile version of Windows Live™ to find information on the web.
	Windows Media Player Mobile	Play back audio and video files.

Settings

Table 2-5 lists control applications pre installed on the FR6874. Tap **Start > Settings** to open the **Settings** window.

Table 2-5 Settings in the Setting Window

Icon	Name	Description
Personal Tab		
	Buttons	Assign a program to a button.
	Input	Set options for each of the input methods.
	Lock	Set a password for the FR6874.
	Menus	Set what programs appear in the Start menu.
	Owner Information	Enter personal information on the FR6874.
	Phone	Make and receive calls, switch between calls, and set up conference calling.
	Sounds & Notifications	Enable sounds for events, notifications, and more, and set the type of notification for different events.
	Today	Customize the appearance and the information to be displayed on the Today screen.
System Tab		
	About	View basic information such as the Windows Mobile® version and type of processor used on the FR6874.
	802.11d Tools	Enable or disable 802.11d
	Backlight	Set the display backlight time-out and adjust brightness.
	Certificates	See information about certificates installed on the FR6874.





















	Clock & Alarms	Set the device clock to the date and time of your locale or to a visiting time zone when you're traveling. Alarms can also be set at specified days and times of a week.
	Customer Feedback	Submit feedback on the Windows Mobile 6 software.
	Device information	Displays the FR6874's software and hardware information.
	Encryption	Allow files on a storage card to be encrypted. Encrypted files are readable only on your device.
	Enroller	Allow you to get a Certificate from Certificate servers.
	Error Reporting	Enable or disable the device's error reporting function. When this function is enabled and a program error occurs, technical data about the state of the program and your computer is logged in a text file and delivered to Microsoft's technical support if you choose to send it.
	External GPS	Set the appropriate GPS communication ports, if required. You may need to do this when there are programs on your device that access GPS data or you have connected a GPS receiver to the FR6874.
	Managed Programs	View installation history.
	Memory	Check the device memory allocation status and memory card information and stop currently running programs.
	Power	Check battery power and set the time-out for turning off the display to conserve battery power.
	Regional Settings	Set the regional configuration to use, including the format for displaying numbers, currency, date, and time on the FR6874.
	Remove Programs	Remove programs that you installed on the FR6874.
	Screen	Change the screen orientation, re-calibrate the screen, and change the screen text size.
	Windows Update	Link to Microsoft's web site and update Windows Mobile® on your device with the latest security patches or fixes. Do not use. Obtain updates from Motorola.

Table 2-5 *Settings in the Setting Window (Continued)*

Icon	Name	Description
ConnectionsTab		
	Beam	Set the FR6874 to receive incoming IrDA beams and Bluetooth beam.
	Bluetooth	Search for other Bluetooth devices.
	Connections	Set up one or more types of modem connections for your device, such as phone dial-up, GPRS, Bluetooth, and more, so that your device can connect to the Internet or a private local network.
	Domain Enroll	Enroll in domain.
	USB to PC	Enables or disables the enhanced network connectivity.
	Wi-Fi	Setup wireless network connection and customize settings.
	Wireless Manager	Enables or disables the FR6874's wireless radios and customizes Wi-Fi, Bluetooth and Phone settings.

Adjusting Volume

To adjust the system volume using the **Speaker** icon in the navigation bar:

1. Tap the **Speaker** icon. The **Volume** dialog box appears.



Figure 2-2 Volume Dialog Box

2. Tap and move the slide bar to adjust the volume.
3. Select the **On** or **Off** radio button to turn the volume on or off.

You can also adjust the system volume using the **Sounds & Notifications** window, or use the **Up/Down** button on the side of the FR6874.

Battery Status Indications

Battery icons appear on the navigation bar indicating the battery power level. When the main battery or backup battery power falls below a predetermined level, the icon indicates the status and a battery dialog box appears indicating the status of the main or backup battery.

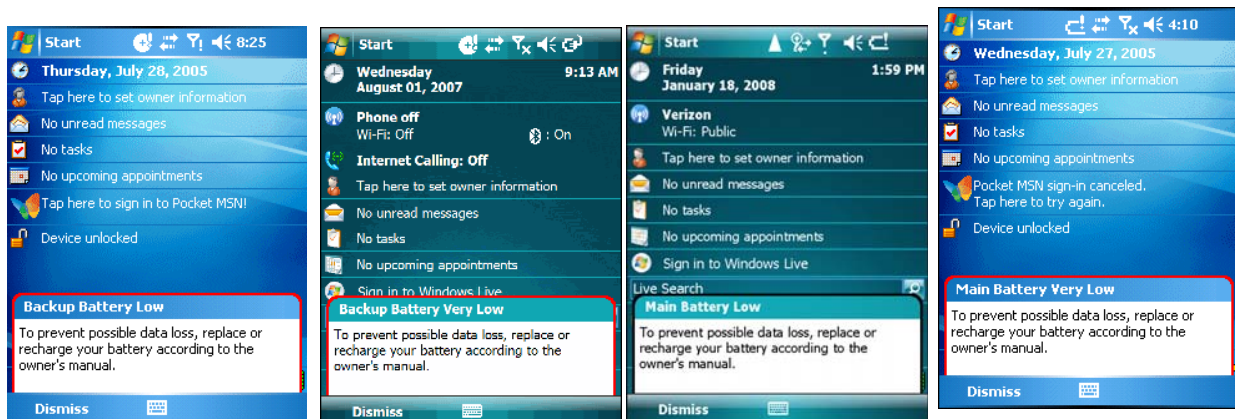

Figure 2-3 Battery Status Dialog Box

The **Battery** icon always appears in the **navigation bar** when the Today screen is visible. The icon indicates the battery power level. The message displays until the **Dismiss** button is pressed.



Figure 2-4 Battery Icon on the Title Bar

Also view the battery status using the **Power** window.

Power Setting

1. Tap **Start > Settings > Power icon > Main** tab. A power remaining capacity bar appears.

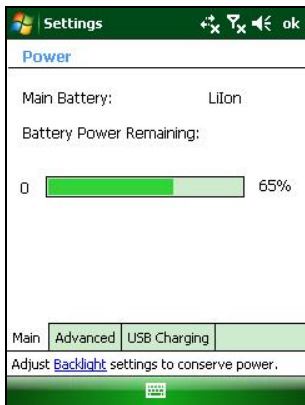

Figure 2-5 Main Tab

2. Tick the following options to save the power, and tap **ok**.

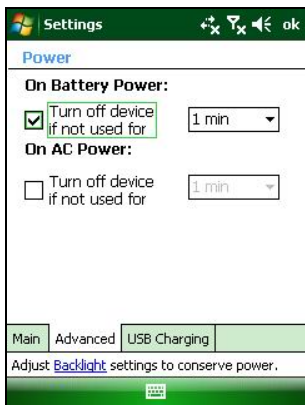

Figure 2-6 Advanced Tab

3. Select Slow charge or Fast charge, and tap **ok**.

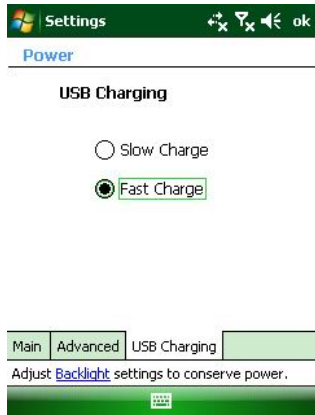

Figure 2-7 USB Charge Tab

Main Battery Temperature Notifications

The temperature notification system implements three levels of notification when the temperature within the battery exceeds specific temperature thresholds:

- **Level 1: Temperature Watch;** this level is similar to main battery low warning. It indicates that the battery temperature has reached the first threshold level. The user should move to an environment within proper operating temperature.
- **Level 2: Temperature Warning;** this level is similar to main battery very low warning. It indicates the battery temperature has reached the second threshold level. The user should stop using the FR6874.
- **Level 3: Temperature Error;** this level indicates the battery has reached an unusable temperature threshold and immediately suspends the FR6874. This level does not have any graphical notification associated with it.



Figure 2-8 Main Battery Temperature Watch Dialog Box



Figure 2-9 Main Battery Temperature Warning Dialog Box



NOTE The **Temperature Warning** dialog box remains visible until you tap **Hide**.

LED Indicators

The FR6874 has three LED indicators. The Scan/Decode LED indicates status for bar code scanning. The Charging/Battery Status LED indicates battery charging and status. The Radio Status LED indicates WAN radio status. [Table 2-6](#) describes the LED indications.

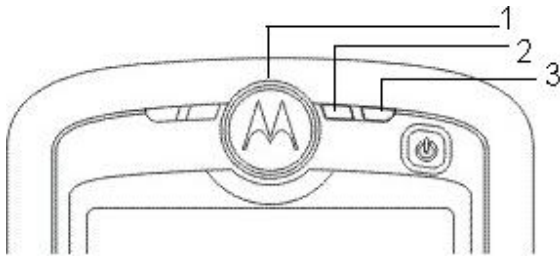

Figure 2-10 LED Indicators

1. Scan/Decode LED
2. Charging LED
3. Radio Status LED

Table 2-6 LED Indications

LED status	Indication
Scan/Decode LED	
Solid Green	Successful decode/capture
Solid red	Laser enabled, scanning in process
Off	Not enabled
Charging/Battery Status LED	
Slow blinking amber	Main battery in FR6874 is charging.
Solid green	Main battery in FR6874 is fully charged.
Fast blinking amber	Charging error
Off	Not charging
Single blink amber (when power button is pressed)	Battery depleted
Blinking amber (when power button is pressed)	Battery over-temperature condition
Radio Status LED	
Slow blink green	The radio (BT,WIFI,GPS,RIL) can work correctly when it is on
Slow blink red	Some radio (BT,WIFI,GPS,RIL) can not work correctly when it is on.
Off	All radio off.

✓ **NOTE** For information about scanning/decoding, see *Data Capture on page 2-29*. For information about WAN radio status and settings, see [Chapter 5, Using the Phone](#), or refer to the *FR6874 Integrator Guide*.

Resetting the FR6874

There are two reset functions, warm boot and cold boot. A warm boot restarts the FR6874 by closing all running programs. A cold boot also restarts the FR6874, and also resets the clock. Data saved in flash memory or a memory card is not lost.

If the FR6874 is not functioning properly, perform a warm boot first. If the FR6874 still does not respond, perform a cold boot.

Performing a Warm Boot

Press the reset button to reboot the device.

Performing a Cold Boot

Put the battery into the device, lock the battery cover, and press the power button.

Waking the FR6874

The wake-up conditions define what actions wake up the mobile computer after it has gone into suspend mode. The mobile computer can go into suspend mode by either pressing the Power button or automatically by Control Panel time-out settings. These settings are configurable and the factory default settings are shown in [Table 2-7](#) are subject to change/update.

Table 2-7 Wake-up Default Settings

Condition for Wake-up	Power Button	Automatic Time-out
AC power is applied.	No	Yes
Mobile computer is inserted into a cradle.	No	Yes
Mobile computer is removed from a cradle.	No	Yes
Mobile computer is connected to a USB device.	No	Yes
Mobile computer is disconnected from a USB device.	No	Yes
A key is pressed.	No	Yes
The scan triggered is pressed.	No	Yes
The screen is touched.	No	No
Audio Jack	No	No
Audio Btn	No	No
Bluetooth communication	Yes	Yes
Incoming phone call	Yes	Yes

Locking the FR6874

Use the Device Lock feature to prevent use of the device. Note that when locked, the FR6874 does not respond to screen or keypad input.

To lock the device, tap the **Device unlocked** icon. The icon changes to locked.

Figure 2-11 *Device Locked/Unlocked Icons*

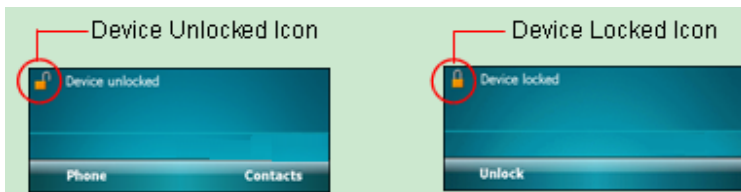

Figure 2-12 *Unlock Device Window*

Tap **Unlock** on the **Unlock** window.

- ✓ **NOTE** You can make emergency calls even when the FR6874 is locked. See *Making an Emergency Call* on page 5-7 for more information.

Keypads

The FR6874 offers one type modular keypad configuration: alpha-numeric.









Alpha-numeric Keypad Configurations

The three types of alpha-numeric keypads produce the 26-character alphabet (A-Z, both lowercase and uppercase), numbers (0-9), and assorted characters. The keypad is color-coded to indicate which modifier key to press to produce a particular character or action. The keypad default is alphabetic, producing lowercase letters. See [Table 2-8](#) for key and button descriptions.



Figure 2-13 QWERTY Keypad Configuration

Table 2-8 Alpha-numeric Keypad Descriptions

Key	Action
Blue Key 	<p>Launches applications (shown on the keypad in blue). Press the Blue key once to activate this mode temporarily, followed by another key. This displays the following icon at the bottom of the screen, until a second key is pressed: </p> <p>Press the Blue key twice to lock this mode. This displays the following icon at the bottom of the screen: </p> <p>Press the Blue key a third time to unlock. Press and hold the Blue key while selecting a sequence of keys to activate this mode temporarily. This displays the following icon at the bottom of the screen as long as the key is pressed: </p>
Orange Key 	<p>Accesses the secondary layer of characters and actions (shown on the keypad in orange). Press the Orange key once to activate this mode temporarily, followed by another key. This displays the following icon at the bottom of the screen, until a second key is pressed: </p> <p>Press the Orange key twice to lock this mode. This displays the following icon at the bottom of the screen: </p> <p>Press the Orange key a third time to unlock. Press and hold the Orange key while selecting a sequence of keys to activate this mode temporarily. This displays the following icon at the bottom of the screen as long as the key is pressed: </p>
Talk/End	Talk (Green Phone): press to display the phone keypad window or to dial a

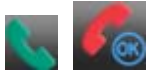

phone number (from the phone keypad window).

End (Red Phone): press when the phone keypad window displays to stop dialing or end a call.

Key	Action
Scroll Up and Left 	Moves up one item. Moves left one item when pressed with the Orange key.
Scroll Down and Right 	Moves down one item. Moves right one item when pressed with the Orange key.
Soft Keys 	Accesses the command or menu above it on the screen.
Shift 	Changes the state of the alpha characters from lowercase to uppercase. <ul style="list-style-type: none"> Press the Shift key to activate this mode temporarily, followed by another key. This displays the following icon at the bottom of the screen, until a second key is pressed: Press and hold the Shift key while selecting a sequence of keys to activate this mode temporarily. This displays the following icon at the bottom of the screen as long as the key is pressed: Press the Shift key twice to lock this mode. This displays the following icon at the bottom of the screen: Press the Shift key a third time to unlock.
Backspace 	Produces a backspace.
Enter 	Executes a selected item or function.
Star 	Produces an asterisk.
OK 	Use this key in conjunction with the Blue key as an OK or close button. This function is user programmable.
Start Menu 	Use this key in conjunction with the Blue key to instantly display the <i>Start</i> menu from any application without tapping the screen. This function is user programmable.
Menu 	Use this key in conjunction with the Blue key to instantly display the context menu from any application without tapping the screen. This function is user programmable.
Phonepad 	Use this key in conjunction with the Blue key to display the Phonepad application without tapping the screen. This function is user programmable.

Table 2-9 QWERTY Keypad Input Modes

Key	Normal	Shift + Key	Orange + Key	Blue + Key
Q	q	Q	*	
W	w	W	1	
E	e	E	2	
R	r	R	3	
T	t	T	+	
Y	y	Y	_	
U	u	U	-	
I	i	I	=	
O	o	O	"	
P	p	P	,	
A	a	A	#	
S	s	S	4	
D	d	D	5	
F	f	F	6	
G	g	G	(
H	h	H)	
J	j	J	/	
K	k	K	\	
L	l	L	:	
Backspace	Backspace			
Shift	Shift			
Z	Z	Z	7	
X	x	X	8	
C	c	C	9	
V	v	V	%	
B	b	B	&	
N	n	N	!	
M	m	M	?	
,	,	<	;	
ENTER	Enter			
O	O	O)	O
Mail	Mail	Mail	Mail	Mail

TAB	Tab	Tab	Tab	Tab
SPACE	Space	Space	Space	Space
.	.	>	@	.

Note: An application can change the key functions. The keypad may not function exactly as described.

Function Buttons

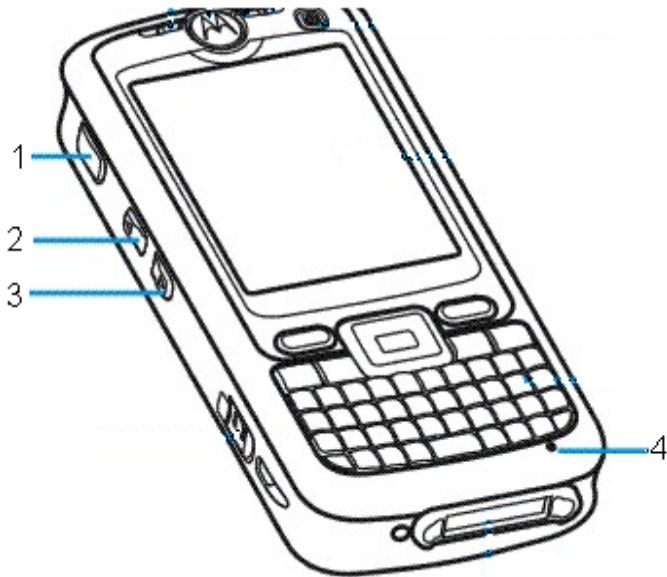

- **Power:** Press the red **Power** button to turn the FR6874 screen on and off. The FR6874 is in suspend mode when the screen is off. For more information, see *Powering On the FR6874 on page 1-8*. Also use the **Power** button to reset the FR6874 by performing a warm or cold boot. See *Resetting the FR6874 on page 2-14*.
- **Scan:** Press to scan bar codes. See *Data Capture on page 2-29*.
- **Up/Down:** Press to increase or decrease the FR6874's volume.

Stylus

Use the FR6874 stylus to select items and enter information. The stylus functions as a mouse.

- **Tap:** Touch the screen once with the stylus to press option buttons and open menu items.
- **Tap and Hold:** Tap and hold the stylus on an item to see a list of actions available for that item. On the pop-up menu that appears, tap the action to perform.
- **Drag:** Hold the stylus on the screen and drag across the screen to select text and picture. Drag in a list to select multiple items.



NOTE Motorola recommends using the spring-loaded tip of the stylus to write on the screen, and the back end of the stylus to tap the screen. Use your finger to press the **Power** button and keypad buttons.



CAUTION To prevent damage to the screen, do not use any device other than the Motorola-provided stylus.

Entering Data

When entering data on the keypad, use either the single-hand method or the two-hand method as shown in [Figure 2-14](#).



Single-hand Method



Two-hand Method

Figure 2-14 *Entering Data on the Keypad*

Data Capture

The FR6874 offers one type of data capture option: linear scanning



NOTE To perform data capture a scanning enabled application must be installed on the FR6874. A sample scanning application can be downloaded from the Motorola Support site at <http://support.symbol.com>.

Linear Scanning

FR6874 with an integrated linear scanner have the following features:

- Reading of a variety of bar code symbologies, including the most popular linear, postal, and 1-D code types.
- Intuitive aiming for easy point-and-shoot operation.

Scanning Considerations

Typically, scanning is a simple matter of aim, scan, and decode and a few quick trial efforts master it. However, consider the following to optimize scanning performance:

- Range

Any scanning device decodes well over a particular working range — minimum and maximum distances from the bar code. This range varies according to bar code density and scanning device optics.

Scanning within range brings quick and constant decodes; scanning too close or too far away prevents decodes. Move the scanner closer and further away to find the right working range for the bar codes being scanned.

- Angle

Scanning angle is important for promoting quick decodes. When laser beams reflect directly back into the scanner from the bar code, this special reflection can “blind” the scanner.

To avoid this, scan the bar code so that the beam does not bounce directly back. But don't scan at too sharp an angle; the scanner needs to collect scattered reflections from the scan to make a successful decode. Practice quickly shows what tolerances to work within.

- Hold the FR6874 farther away for larger symbols.
- Move the FR6874 closer for symbols with bars that are close together.



NOTE Scanning procedures depend on the application and FR6874 configuration. An application may use different scanning procedures from the one listed above.

1. Ensure that a scan enabled application is loaded on the FR6874.
2. Aim the scan window at the bar code.

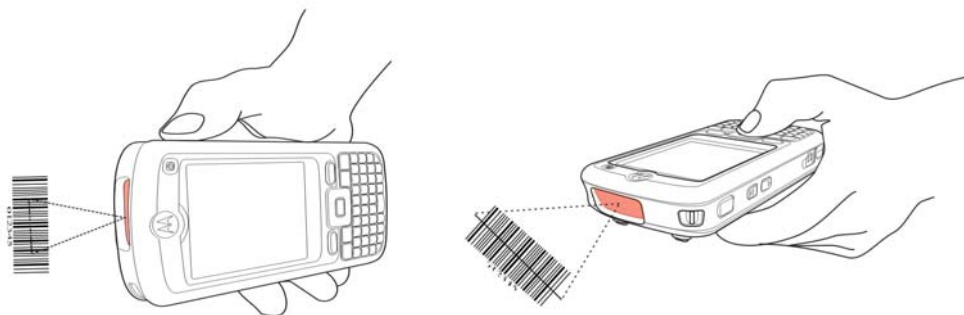

Figure 2-15 *Linear Scanning*

3. Press the scan button. Ensure the red scan beam covers the entire bar code. The Scan/Decode LED lights red to indicate that scanning is in process, then lights green and a beep sounds, by default, to indicate the bar code was decoded successfully.

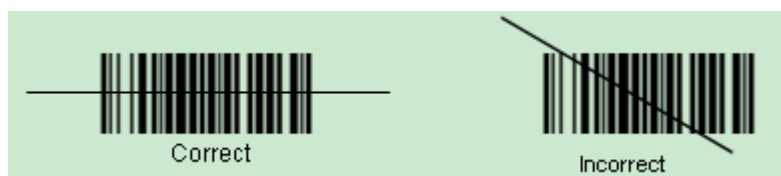

Figure 2-16 *Linear Scanner Aiming Pattern*

Taking Photos

To take a photo:

1. Tap **Start > Programs > Pictures & Videos** icon.
2. Tap **Camera** on the command bar.
3. Check the picture on the view finder, adjust if necessary.
4. Press the **Enter** key to take the picture. Hold the FR6874 still until the camera flash occurs or the shutter sound is heard.

Recording Video

To record a video clip:

1. Tap **Start > Programs > Pictures & Videos** icon.
2. Tap **Camera** on the command bar.
3. Tap **Menu > Video** to set shooting mode to video. The available recording time displays on the screen.



NOTE By default, the time limit for recording videos is set to 30 seconds.

4. Press the **Enter** key to begin recording.
Recording stops when you press the **Enter** button again.

Viewing Photos and Videos



NOTE For detailed information on the Photos and Videos, refer to the *Microsoft Applications User Guide for Mobile 6*, p/n 72E-108299-xx.

To view photos and video clips:

1. Tap **Start > Programs > Pictures & Videos** icon.
2. Tap the picture or video clip to view.

Using IrDA

In a Microsoft Windows Mobile program (except Messaging), and Picture & Videos, you can exchange files using either infrared or Bluetooth.



NOTE You can also beam files (not folders) from the **File Explorer** window. Tap and hold the item you want to send, then tap **Beam File** from the pop-up menu.

First activate the beam function before exchanging files with another IrDA device.

To activate the Beam function:

1. Tap **Start > Settings > Connections** tab > **Beam** icon.
2. Tap **Receive all incoming beams** check box.

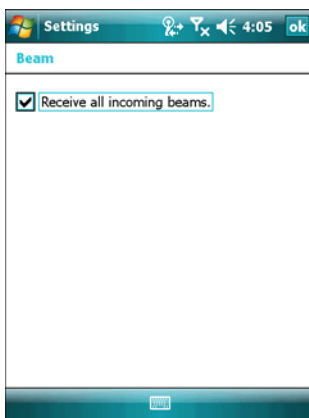

Figure 2-17 *Beam Window*

3. Tap **ok**.

Infrared Connection

Using infrared, you can enable short-range file exchange between your FR6874 and another IrDA device.

Exchanging Files using IR Connection

Ensure that the IrDA function on both the FR6874 and the other device are enabled. To send files via IrDA connection:

1. Switch to the program where you created the item you want to send and locate the item in the list.



NOTE Do not cover or block the IrDA window.

- Align the IrDA port of the FR6874 with that of the IrDA device so that they are unobstructed and within a close range.

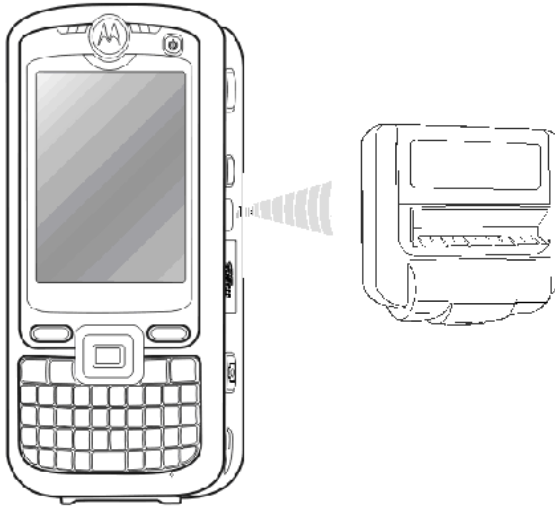

Figure 2-18 *Align FR6874 with IrDA Device*

- Tap and hold the item, then tap Beam [type of item] on the pop-up menu.
- Tap the device that you want to send the file to.

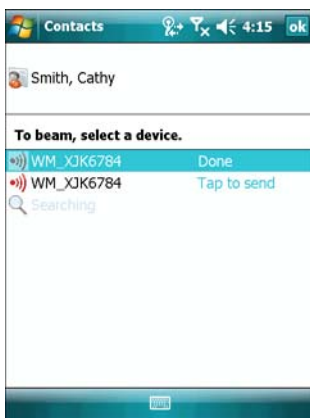

Figure 2-19 *Beam Contact*



Figure 2-20 *Receive File*

To receive files via IrDA connection:

- Align the IrDA port of the FR6874 with that of the other IrDA device so that they are unobstructed and within a close range.
- On the other device, send the file to the FR6874.
- When the **Receiving Data** dialog displays, tap **Yes**.

Using Wi-Fi

With Wi-Fi, you can access the internet.

1. Tap **Start>Settings>Connection tab>Wireless Manager icon>Menu**.

Or tap the operator name on the Today screen.

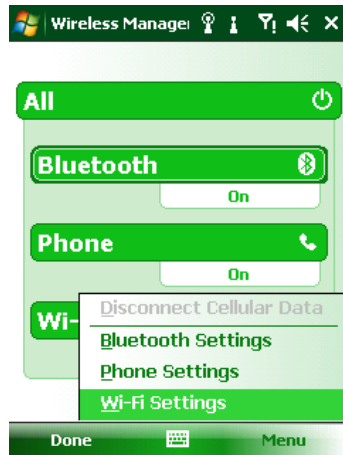

Figure 2-21 *Wireless Manager menu*

2. Tap **Wi-Fi settings** to enter the configuration screen.

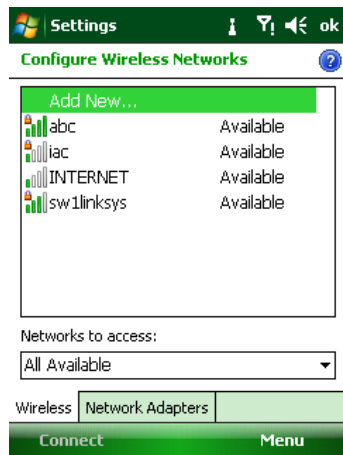

Figure 2-22 *Wireless networks configuration*

3. Tap the item in the “Network to access” drop box, and select the desired item.

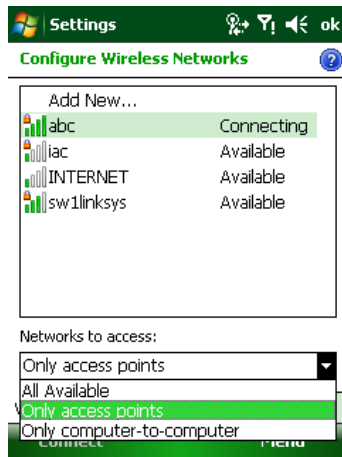

Figure 2-23 Networks to access

4. Tap the Network Adapters tab in the Figure 2-26.

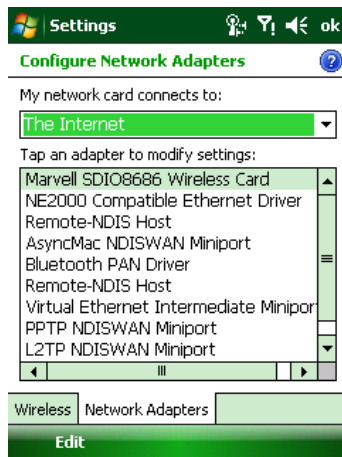

Figure 2-24 Network Adapter

5. In the Figure 2-28, tap **Edit** or tap the “network card connections to”, or tap an adapter to modify the settings.

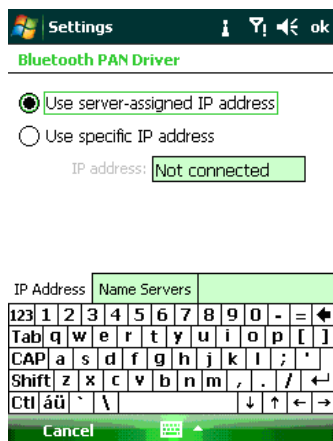

Figure 2-25 Network Adapter settings modification

6. Tap “Use specific IP address” in the Figure 2-29

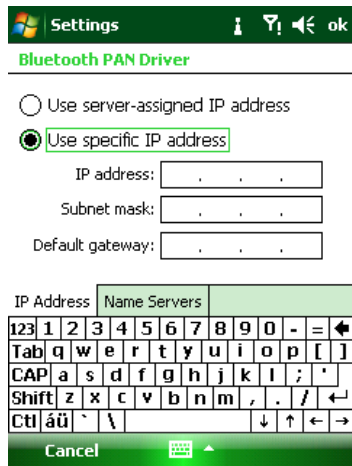

Figure 2-26 IP address setting

7. Tap the Name Servers tab in the **Figure 2-30**.

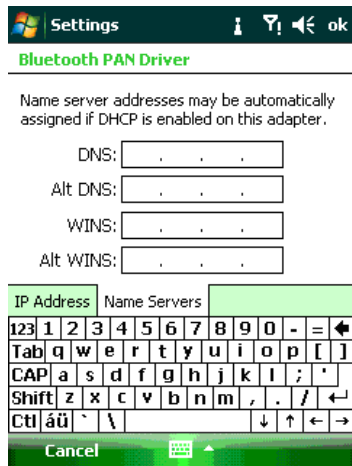

Figure 2-27 Name Servers setting

Adding New Network

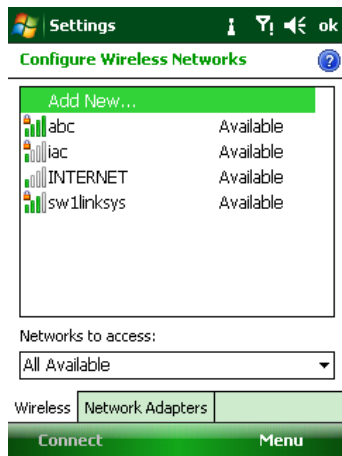

Figure 2-28 Wireless networks configuration

1. Tap “Add New...” in the Figure 2-31.

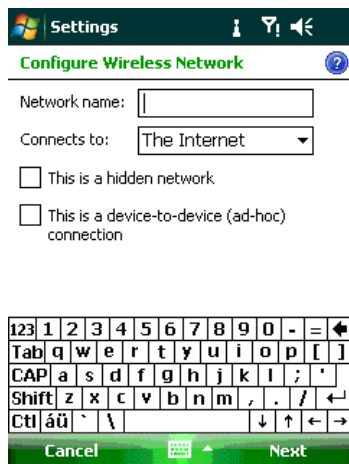

Figure 2-29 New wireless networks configuration

Note: Only one of the two check box works.

2. Enter the name in the Figure 2-32.

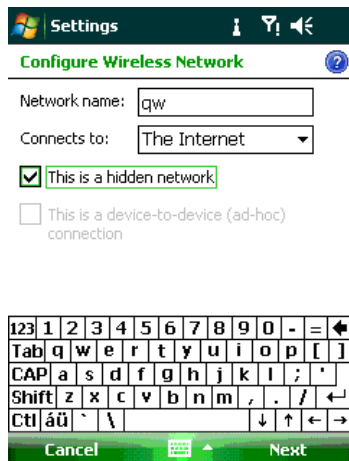

Figure 2-30 New wireless networks configuration

3. Tap Next in the in the Figure 2-33.

Settings

Configure Network Authentication

Authentication: Open

Data Encryption: WEP

The key is automatically provided

Network key:

Key index: 1

Back Next

Figure 2-31 Configure Network Authentication

4. Tap Next in the Figure 2-34.

Settings

Configure Network Authentication

Authentication: Open

Data Encryption: WEP

The key is automatically provided

Network key:

Key index: 1

Back Next

Figure 2-32 Configure Network Authentication

5. Tap Next in the Figure 2-35.

Settings

Configure Network Authentication

Use IEEE 802.1x network access control

EAP type: Smart Card or Certificate

Properties

Back Finish

Figure 2-33 Configure Network Authentication

6. In the **Figure 2-36**, tick the “Use IEEE 802.1x network access control” check box, then tap Finish to finish the network adding.

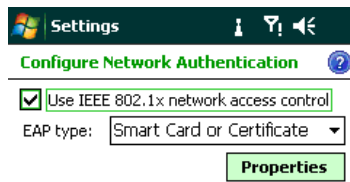

Figure 2-34 *Configure Network Authentication*

Chapter 3 Using GPS

Introduction

The FR6874 includes Global Positioning System (GPS) technology using the Qualcomm chip. GPS technology is based on a worldwide system of GPS satellites orbiting the earth that continuously transmit digital radio signals. These radio signals contain data on the satellites' locations and their exact clock time and are used to determine your location on the earth.



WARNING! When using the FR6874 in a vehicle, it is the user's responsibility to place, secure and use in a manner that will not cause accidents, personal injury or property damage or obstruct their view. It is the responsibility of the driver to operate the vehicle in a safe manner, maintain observation of all driving conditions at all times, and not become distracted by the device to the exclusion of safe driving practices. It is unsafe to operate the controls of the device while driving.

Software Installation

Third-party GPS navigation software is required. Evaluation software is available from various suppliers.

If interested in purchasing GPS navigation software check with the GPS software vendor (before purchasing, downloading, or installing any software) to determine that the application is compatible with the FR6874. Refer to the application's user guide for application installation and setup information.

FR6874 GPS Setup

The GPS-enabled FR6874 uses Microsoft Windows Mobile 6, so the operating system automatically manages access to the GPS receiver to allow multiple programs to simultaneously access GPS data.

Ensure that the following settings are set on the FR6874:

1. Tap **Start > Settings > System > External GPS** icon.
2. In the **Programs** tab, select *GPD1* from the **GPS program port** drop-down list.
3. In the **Hardware** tab, select *COM6* in the **GPS hardware port** drop-down list.

4. Tap **ok** to close the **Setting** window.



NOTE If an application error message appears indicating that the COM port cannot be opened, ensure that a free COM port is selected in the **GPS hardware port** drop-down list.

Operation

Acquiring satellite signals may take a few minutes. It is best to be outside and have a clear, unobstructed view of the sky. Without a clear view, acquisition takes much longer and could result in the FR6874 being unable to compute the initial position quickly. When operating the device indoors access to the GPS signals may be limited or unavailable.



NOTE When using a GPS navigation application, ensure that the FR6874 does not go into suspend mode. If the FR6874 suspends then the power to the GPS radio is removed. Upon resume the GPS receiver must reacquire a valid GPS signal, resulting in a delay of positional information.

GPS Maps on microSD Cards

GPS navigation software vendors may sell maps on microSD cards. If using a microSD card with the GPS navigation software:

1. Remove the Memory Card Cover on the side of the FR6874.
2. Insert the microSD card into the slot.
3. Replace the Memory Card Cover.

Downloading GPS Data

Use this function to download GPS data to enhance GPS performance. This may require additional charge for data connection.

1. Tap **Start > Program > GPSXtra** icon.
2. Entering GPSXtra to download GPS data.

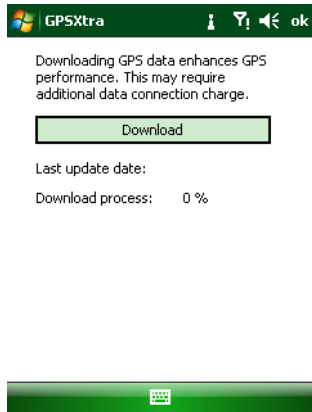

Answering a Phone Call While Using GPS

If you receive a phone call while using your GPS navigation software:

1. Answer the phone call by pressing the **Answer** button.
2. Once you end the phone call, press the **End Call** button to resume the audio on the GPS software.



NOTE Anytime you are using GPS on the FR6874 and you receive a phone call, the audio on the GPS navigation software is muted until you finish the call.

Losing the GPS Signal While in a Vehicle

GPS performance on the FR6874 may be affected if the vehicle has thermal glass windows and windshields, which can block the FR6874 from receiving a GPS signal from satellites. To improve GPS signal strength, place the FR6874 where there is a clear view of the sky. A direct line of sight is required between the FR6874 and the GPS satellites to access information from the satellites.

The Global Positioning System (GPS) is a system that allows the user to track their position anywhere on the earth.

Assisted GPS

GPS can be used in stand-alone or Assisted GPS (A-GPS) modes. A Stand-alone GPS receiver downloads data from GPS satellites. It can take several minutes to get a fix. By using GPS Location servers, A-GPS dramatically improves the performance of the Time To First Fix (TTFF) of GPS receivers by providing them with data that they would ordinarily have to download from the GPS satellites. With the A-GPS data, GPS receivers can operate faster and more reliably.

A-GPS follows the Secure User Plane Location (SUPL) protocol which allows the FR6874 to communicate with a location server. Refer to the EMDK Help file for information on setting up SUPL on the FR6874.

Chapter 4 Using Bluetooth

Introduction

Bluetooth-equipped devices can communicate without wires, using frequency-hopping spread spectrum (FHSS) radio frequency (RF) to transmit and receive data in the 2.4 GHz Industry Scientific and Medical (ISM) band (802.15.1). Bluetooth wireless technology is specifically designed for short-range (30 feet/10 meters) communication and low power consumption.

FR6874s with Bluetooth capabilities can exchange information (e.g., files, appointments, and tasks) with other Bluetooth enabled devices such as phones, and other mobile computers. To use the FR6874 as a modem, create a dial-up modem connection between a computer and FR6874.

Adaptive Frequency Hopping

Adaptive Frequency Hopping (AFH) is a method of avoiding fixed frequency interferers, and can be used with Bluetooth voice. All devices in the piconet (Bluetooth network) must be AFH-capable in order for AFH to work. There is no AFH when connecting and discovering devices. Avoid making Bluetooth connections and discoveries during critical 802.11b communications. AFH for Bluetooth consists of four main sections:

- Channel Classification - A method of detecting an interference on a channel-by-channel basis, or pre-defined channel mask.
- Link Management - Coordinates and distributes the AFH information to the rest of the Bluetooth network.
- Hop Sequence Modification - Avoids interference by selectively reducing the number of hopping channels.
- Channel Maintenance - A method for periodically re-evaluating the channels.

When AFH is enabled, the Bluetooth radio “hops around” (instead of through) the 802.11b high-rate channels. AFH coexistence allows Motorola mobile computers to operate in any infrastructure.

The Bluetooth radio in this FR6874 operates as a Class 2 device power class. The maximum output power is 2.5mW and the expected range is 32.8 feet (10 meters). A definition of ranges based on power class is difficult to obtain due to power and device differences, and whether one measures open space or closed office space.



NOTE It is not recommended to perform Bluetooth wireless technology inquiry when high rate 802.11b operation is required.

Security

The current Bluetooth specification defines security at the link level. Application-level security is not specified. This allows application developers to define security mechanisms tailored to their specific need. Link-level security occurs between devices, not users, while application-level security can be implemented on a per-user basis. The Bluetooth specification defines security algorithms and procedures needed to authenticate devices, and if needed, encrypt the data flowing on the link between the devices. Device authentication is a mandatory feature of Bluetooth while link encryption is optional.

Pairing of Bluetooth devices is accomplished by creating an initialization key that is used to authenticate the devices and create a link key for them. Entering a common PIN number in the devices being paired generates the initialization key. The PIN number is never sent over the air. By default, the Bluetooth stack responds with no key when a key is requested (it is up to user to respond to the key request event). Authentication of Bluetooth devices is based-upon a challenge-response transaction. Bluetooth allows for a PIN number or passkey that is used to create other 128-bit keys used for security and encryption. The encryption key is derived from the link key used to authenticate the pairing devices. Also worthy of note is the limited range and fast frequency hopping of the Bluetooth radios that makes long-distance eavesdropping difficult.

Recommendations are:

- Perform pairing in a secure environment
- Keep PIN codes private and don't store the PIN codes in the mobile computer
- Implement application-level security.

Turning the Bluetooth Radio Mode On and Off

Turn off the Bluetooth radio to save power or if entering an area with radio restrictions (e.g., an airplane). When the radio is off, other Bluetooth devices cannot see or connect to the FR6874. Turn on the Bluetooth radio to exchange information with other Bluetooth devices (within range). Communicate only with Bluetooth radios in close proximity.

✓ **NOTE** To achieve the best battery life turn off radios not in use.

Disabling Bluetooth

To disable Bluetooth, tap **Bluetooth** icon to enter **Wireless Manager**. Tap **Bluetooth** icon to change **on** to **off**. The **Bluetooth** icon changes to indicate that Bluetooth is disabled.

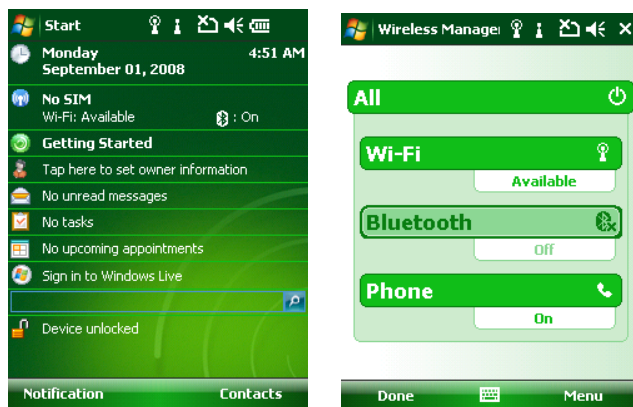

Figure 4-1 *Disable Bluetooth*

Enabling Bluetooth

To enable Bluetooth, tap **Bluetooth** icon to enter **Wireless Manager**. Tap **Bluetooth** icon to change **off** to **on**. The **Bluetooth** icon changes to indicate that Bluetooth is enabled.

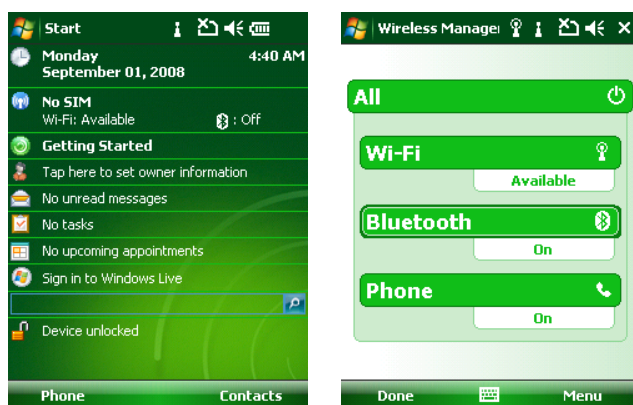

Figure 4-2 *Enable Bluetooth*

Bond New Device(s)

The FR6874 can exchange information with bonded devices.

To find Bluetooth devices in the area:

1. Ensure that Bluetooth is enabled on both devices.
2. Ensure that the Bluetooth device to discover is in discoverable and connectable modes.
3. Ensure that the two devices are within 30 feet (10 meters) of one another.
4. Tap the **Bluetooth** icon to enter **Wireless Manager**. Then tap **Menu**.

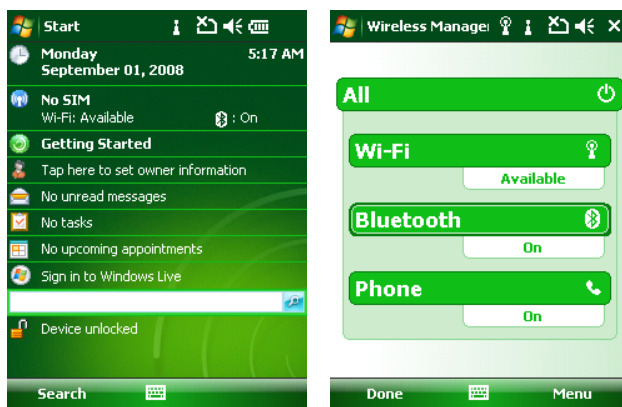

Figure 4-3 Enter Bluetooth Window

5. Tap **Menu** to enter **Settings** window. Then tap Add new device to search for Bluetooth Devices.

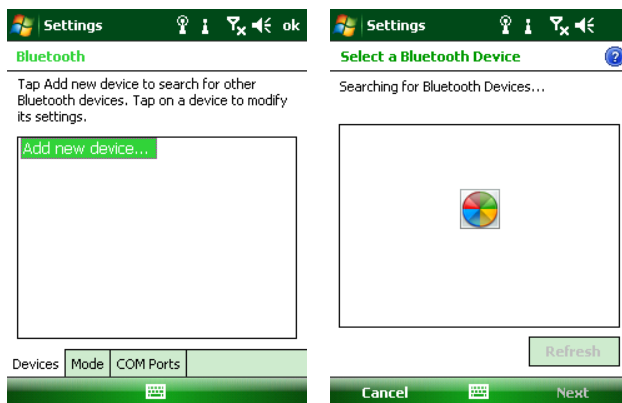

Figure 4-4 Add new device Window

6. After the device appears, tap it and enter a passcode to establish a secure connection with it. Meanwhile enter the passcode on the target device.

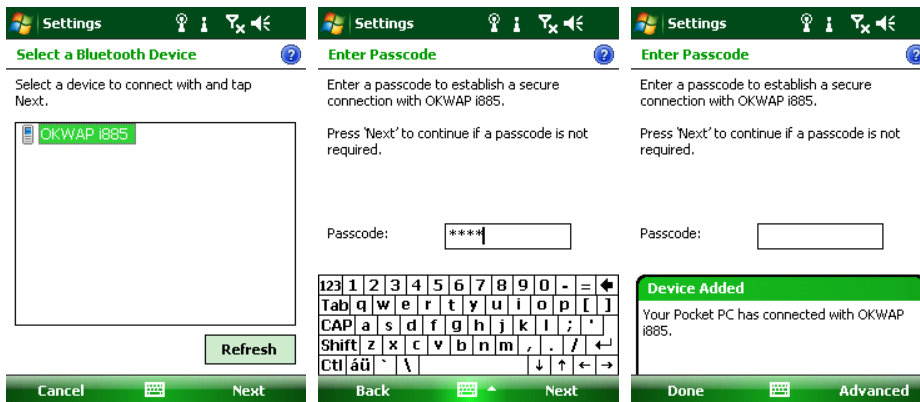

Figure 4-5 Discover Devices Dialog Box

File Transfer Services

To transfer files between the FR6874 and another Bluetooth enabled device, please ensure the FR6874 is discoverable and connectable.

✓ **NOTE** Some devices might not require a PIN. This depends upon the device's authentication.

1. Choose one file as below, tap **Menu > Beam picture** Menu.

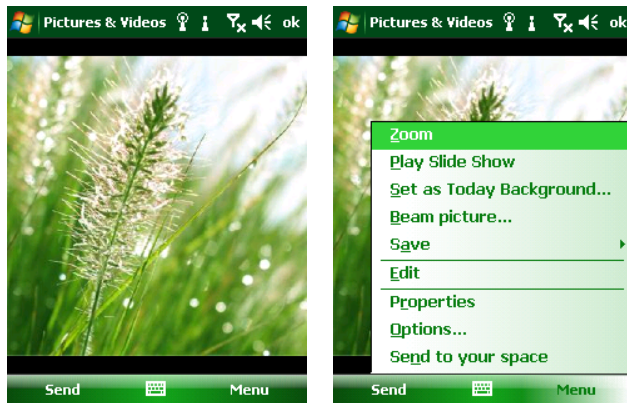

Figure 4-6 Select file

2. Then choose the destination device, and wait till **Done** is showed.

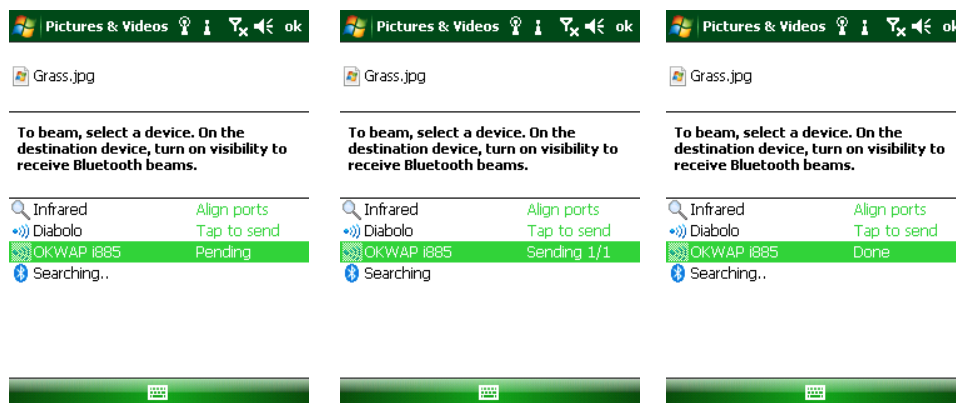

Figure 4-7 Transfer file Window

Bluetooth Settings

Use the **Bluetooth Settings** window to configure the operation of the application. Tap **Menu > Settings**. The **Bluetooth Settings** window appears.

Device Info Tab

Use the Device Info tab to add and bond new devices. Please refer to **Bond new device(s)**.

Mode Tab

Use the **Mode** tab to configure the FR6874's Bluetooth connection modes.

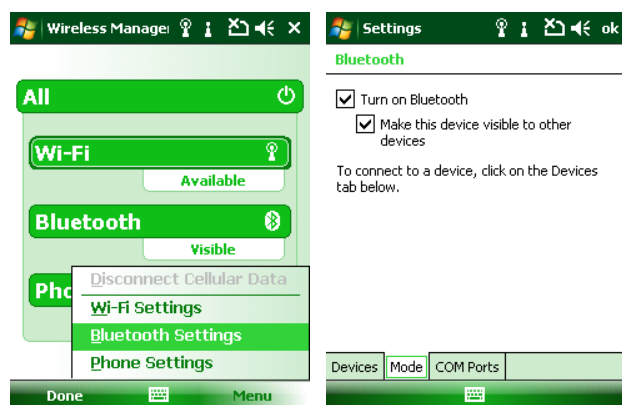

Figure 4-8 BTE Explorer Settings - Device Info Tab

- ✓ 1. Before bonding a new device, make sure to turn on Bluetooth.
- 2. If you want other devices to find your FR6874, please tick "Make this device visible to other devices".

COM Ports Tab

Use the **COM Ports** tab set specific outgoing ports for bonded devices.

1. Tap **New Outgoing Port**.

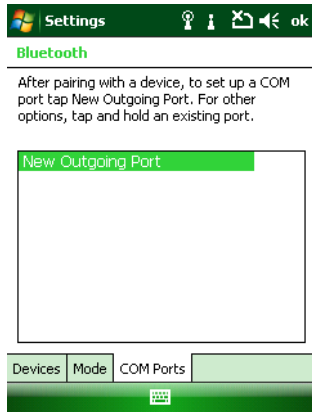

Figure 4-9 Add COM Ports

2. Select the device you want to add. Then tap **Next**.

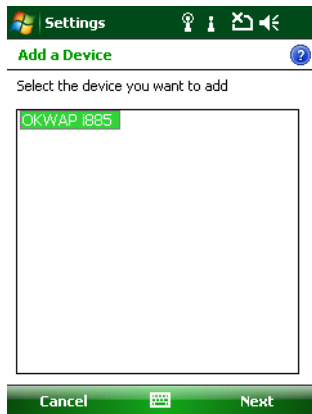

Figure 4-10 Select device

3. Select a port from drop-down list. Then tap **Finish**.

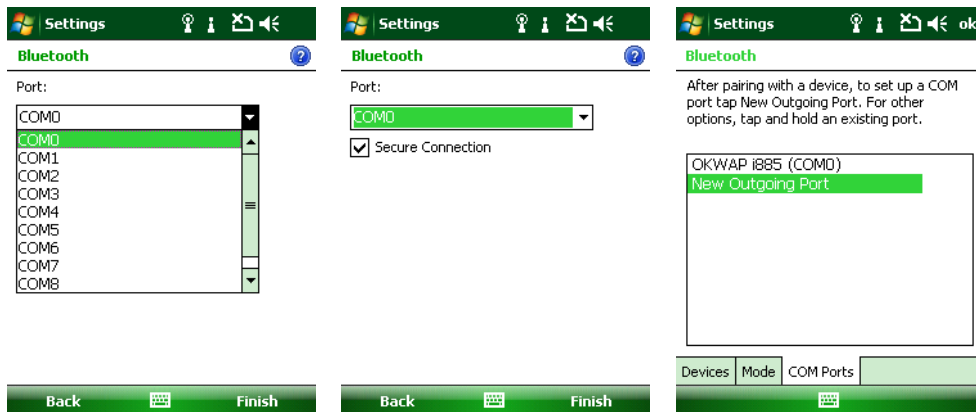

Figure 4-11 Select a Port for device

Chapter 5 Using the Phone

Introduction

Use the FR6874 to make phone calls, set up speed dials, keep track of calls, and send text messages. Your wireless service provider may also provide other services such as voice mail, call forwarding, and caller ID.

Also use the integrated phone to connect to an ISP or work network in order to browse the Web and read e-mail. Connect to the Internet or work network over High-Speed Downlink Packet Access (HSDPA) (FR687476) using Cellular Line, or using the modem specified by the mobile operator. For more information, or to customize the FR6874 phone by changing phone settings, see the *FR6874 Integrator Guide*.

Accessing the Phone Keypad

✓ **NOTE** Keypads vary depending on services and the state of the phone. For example, place calls on hold and use **Swap** to switch active calls on hold. (See *Conference Calling on an FR687476 on page 5-20*.)

Access the keypad regardless of the program in use. Applications on the FR6874 can be in use during a call.



Figure 5-1 Phone Keypads

To access the phone keypad tap **Start > Phone** or press the green phone key on the FR6874's keypad.

To receive calls when the FR6874 is suspended, leave the phone radio turned on and ensure the FR6874 is set to wake with any key.

Turning the Phone On and Off

Windows Mobile 6 devices include **Wireless Manager**, which provides a simple method of enabling and disabling the phone.

To open **Wireless Manager**, tap the **Connectivity** icon.

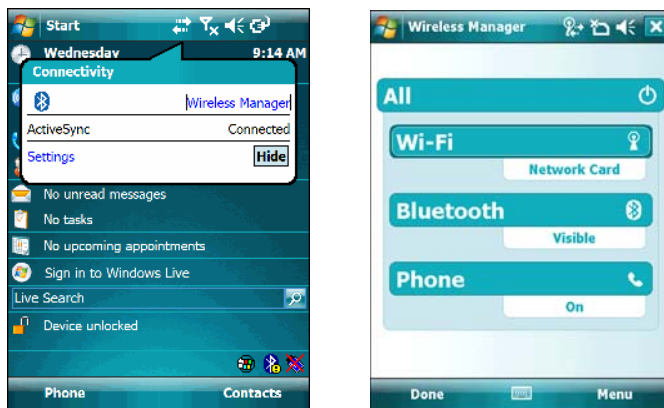

Figure 5-2 Opening Wireless Manager

Select **Wireless Manager**. The **Wireless Manager** window appears.

To toggle on or off the phone, tap blue Phone bar.

To configure settings for a connection, tap **Menu > Phone Settings**.

✓ **NOTE** To receive calls when your device is suspended, leave the phone turned on.

Audio Modes

The FR6874 offers three audio modes for use during phone calls:

- **Handset Mode:** Switches audio to the speaker at the top front of the FR6874, so you can use the FR6874 as a handset. This is the default mode.
- **Speaker Mode:** Use the FR6874 as if on speaker phone. Tap the **Speaker On** button to activate this mode. Tap the **Speaker Off** button to switch back to handset mode.
- **Headset Mode:** Connect a wired or Bluetooth headset to automatically switch audio to the headset.

The FR6874 defaults to handset mode. When a wired headset is plugged into the FR6874 audio connector

or a

Bluetooth headset is configured for use with the FR6874, the earpiece and speakerphone are muted and audio is heard through the headset.

✓ **NOTE** While using a Bluetooth headset during a call, the mobile computer will not go into suspend mode.



Handset Mode



Speaker Mode

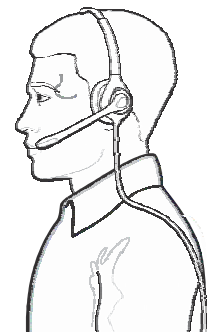

Headset Mode

Figure 5-3 Audio Modes

Using a Wired Headset

You can use a stereo headset for audio communication when using an audio-enabled application. To use a headset, plug the headset jack into the audio connector on the side of the FR6874. Set the FR6874's volume appropriately before putting the headset on. Plugging a headset into the jack mutes the speaker.

For the best audio performance, Motorola recommends a 2.5mm jack headset, see *Accessories on page 1-3*.

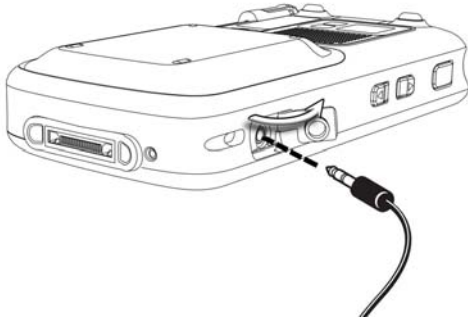

Figure 5-4 *Using a Headset*

Using a Bluetooth Headset

You can use a Bluetooth headset for audio communication when using an audio-enabled application. See [Chapter 4, Using Bluetooth](#) for information on connecting a Bluetooth headset to the FR6874. Set the FR6874's volume appropriately before putting the headset on. When a Bluetooth headset is connected the speakerphone is muted.

It is recommended for phone conversations to use the Bluetooth Hands-free profile instead of the Headset profile. See [Chapter 4, Using Bluetooth](#) for more information.

- ✓ **NOTE** go When using a Bluetooth headset during a call, the FR6874 power button is disabled and the FR6874 will not go into suspend mode. Once the call is completed, the power button functionality is enabled.

The following dialog box displays when a Bluetooth headset connection is established.



Figure 5-5 *WWAN Bluetooth Audio Notification Dialog Box*

Adjusting Audio Volume

Use the Volume Control Slider or the keypad keys to adjust the volume of the ringer when not in a call and the audio volume when in a call.



Figure 5-6 Phone Volume Slider

To adjust the volume tap the **Speaker** icon in the **Title** bar. Move the slider up or down to adjust the volume.

- ✓ **NOTE** Adjust the conversation phone volume during a call. Adjusting the volume while not in a call affects the ring and notification sound levels.

Making a Call

- ✓ **NOTE** You can make emergency calls even when the FR6874 is locked or when a SIM card is not installed. See *Making an Emergency Call on page 5-7* for more information.

With the FR6874, you can make a call from the phone, contacts, speed dial and call history.

Using the Phone

To make a call using the phone keypad:

1. Tap **Start > Phone** or press the green phone key on the FR6874's keypad.
2. From the **Phone** keypad, tap the number to call.
3. Tap **Talk**.
4. Tap **End** to stop dialing or end the call.

- ✓ **NOTE** Alternatively, use the green and red phone keys on the FR6874 keypad to dial (green) and end (red) calls.
- If you tap a wrong number, tap Delete key to erase each subsequent digit of a number. To erase the entire number, tap and hold the Delete key.

Using Contacts

Use Contacts to make a call without looking up or entering the phone number.

To make a call from Contacts:

1. Tap **Start > Contacts**.
2. From the contact list, tap and hold the contact name.

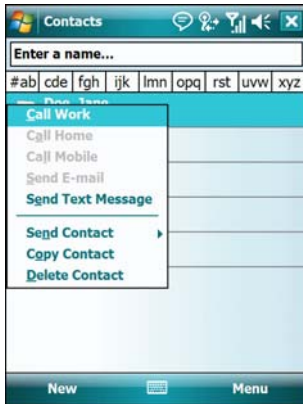

Figure 5-7 *Contacts Menu*

3. Tap **Call Work**, **Call Home** or **Call Mobile**.

✓ **NOTE** To make a call from an open contact, tap the number to call. See On-Device Help for more information about Contacts.

Using Call History

To make a call using Call History:

1. Tap **Start > Phone** or press the green phone key on the FR6874's keypad.
2. From the Phone keypad, tap **Call History**.

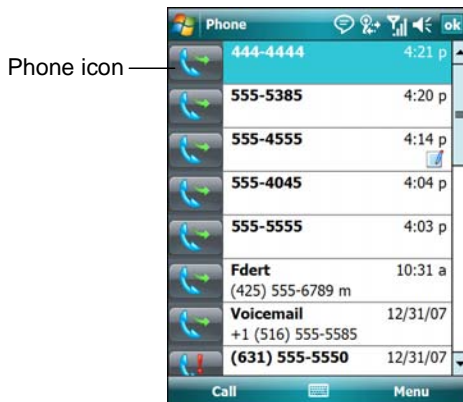

Figure 5-8 *Call History*

3. Tap the phone icon next to the number to begin dialing and return to the phone keypad.
4. Tap **End** or press the red phone key on the FR6874 keypad to stop dialing or end the call.

Making a Speed Dial Call

Use Speed Dial to call someone saved in the speed dial directory.

To make a speed dial call:

1. Tap **Start > Phone** or press the green phone key on the FR6874's keypad.

- From the Phone keypad, tap and hold the speed dial location number assigned to a contact. (To dial a one-digit speed dial location number, tap and hold the speed dial number. To dial a two-digit speed dial location number, tap the first digit and then tap and hold the second digit.) or from the Phone keypad, tap **Speed Dial** and tap the speed dial location number of the desired contact in the list.

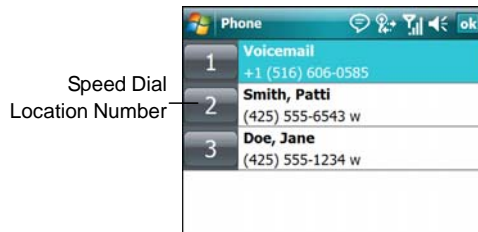

Figure 5-9 Speed Dial Contact List

- To stop dialing or end the call, tap **End** or press the red phone key on the FR6874 keypad.

Making an Emergency Call

Your service provider programs one or more emergency phone numbers, such as 911 or 999, that you can call under any circumstances, even when your phone is locked or the SIM card is not inserted (on FR687476). Your service provider can program additional emergency numbers into your SIM card. However, your SIM card must be inserted in your phone in order to use the numbers stored on it. See your service provider for additional information.

When the alpha-numeric keypad phone is locked, press the Orange key twice to set the keypad to numeric mode and then enter the emergency number.

- ✓ **NOTE** Emergency numbers vary by country. Your phone's pre-programmed emergency number(s) may not work in all locations, and sometimes an emergency call cannot be placed due to network, environmental, or interference issues.

Answering a Call

A dialog box appears on the FR6874 when it receives an incoming call. If the phone is set to ring, a ring tone sounds. Answer or ignore the incoming call.

To answer an incoming call tap **Answer** on the **Phone - Incoming** dialog or press the green phone key on the FR6874 keypad.

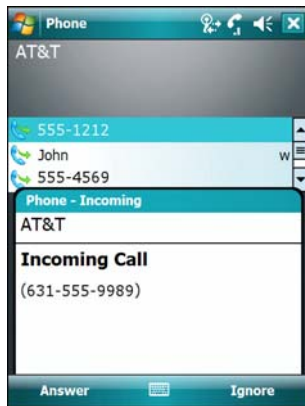

Figure 5-10 *Incoming Call*

To ignore the incoming call tap **Ignore**. This may send the caller to voice mail, depending on the service provider. Otherwise, this presents busy signal to the calling party.

To end the call tap **End** or press the red phone key on the FR6874 keypad.

Incoming Call Features

- If you receive a call while in a call, tap **Wait** to place the call in call waiting.
- You can use other programs on the FR6874 during a call. To switch back to Phone, tap **Talk** or tap **Start > Phone**. Tap **End** to end the call.
- If a caller isn't in your contact list, create a contact during the call or from Call History by tapping **Menu > Save to Contacts**.
- To terminate a call when a second call comes in and answer the waiting call, tap **End** on the Phone keypad to disconnect the active call, then tap **Answer** or press the **Send** key to answer the waiting call.
- To hold the current call and answer a waiting call, tap **Answer** or press the **Send** key to place the current call on hold and answer the incoming call.
- To put a call on hold to call another number or answer an incoming call, tap **Hold** on an FR687476. To move from one call to another, tap **Swap** on an FR687476.

Smart Dialing

Smart Dialing makes it easy to dial a phone number. When you start entering numbers or characters, Smart Dialing automatically searches and sorts the contact entries on the SIM card, in Contacts, and the phone numbers in Call History (including incoming, outgoing, and missed calls). You can then select the desired number or contact from the filtered list to dial.

Open the Phone screen, then tap the keys on the Phone keypad that correspond to the phone number or contact to call. The contact panel lists contacts that match the sequence that you entered.

Smart Dialing starts looking for numbers or contacts that match the sequence entered.

To find a phone number:

- Enter the first one or two digits to find a phone number in Call History.
- Enter the first three digits or more to find a phone number from the saved Contacts and SIM card.

To find a contact name:

- Enter the first letter of a contact's first name or last name. Smart Dialing searches for the letter starting from the first character of a contact name as well as from the character that appears after a space, dash, or underscore in a contact name. For example, if you tap number "2" which is associated with [a, b, c] on the Phone keypad, contact names such as the following will be considered matches: "Smith, Bernard", "Adams, John", "Carlson, Eileen", "Dillon, Albert", "Childs, Larry", "Cooper, Robert" and "Parks, Celine".
- If the matching list is long narrow down the search further by entering another letter. Using the same example above, tap "3" which is associated with (d, e, f), the matching list is narrowed down to the following names: "Smith, Bernard", "Adams, John", and "Parks, Celine".



Figure 5-11 Finding a Contact

To make a call or send a text message using Smart Dialing:

1. Begin entering the first few numbers or characters.
2. In the Smart Dialing panel, use the up and down arrows on the keypad to navigate to the desired contact or phone number.
3. When the correct contact is selected, press **TALK** to make a voice call.
4. To send a text message to the selected contact, tap **Menu > Send Text Message**.
5. To call a different phone number associated with the selected contact, tap the contact name and select the phone number to call.

Muting a Call

During a call, you can mute the microphone so you can hear the person on the line but he or she cannot hear conversation from the microphone. This is useful when there is conversation or background noise on your end.

To mute or unmute a call:

1. Tap **Start > Phone** or press the green phone key on the FR6874's keypad.
2. Make a call.
3. Tap **Mute** on the display to mute the audio. The **Mute** icon appears.

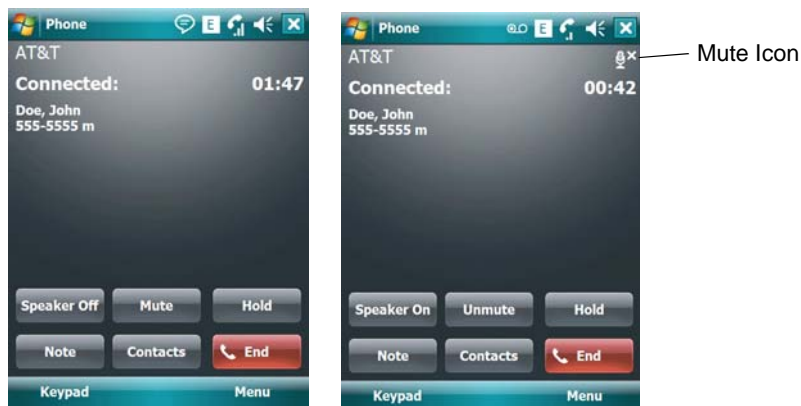

Figure 5-12 Mute Button and Icon

Taking Notes

To create a note during a call, tap **Note** on the display, then enter the note. For more information about creating notes see the Windows On-Device Help.

To access a note created during a call:

1. Tap **Start > Phone** or press the green phone key on the FR6874's keypad.
2. From the Phone keypad, tap **Call History**.
3. Tap and hold the number or the **Note** icon for the phone call entry containing the note.

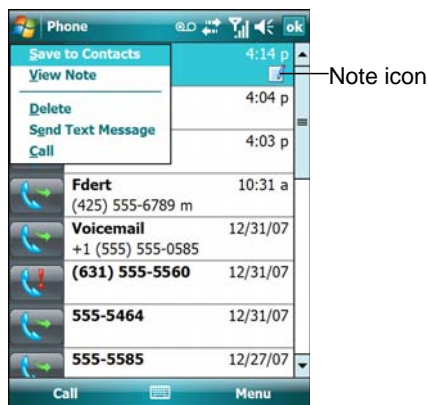

Figure 5-13 Call History - Notes Menu

4. Tap **View Note**.



Figure 5-14 Call History - Notes

5. Tap **ok** to exit.

✓ **NOTE** Also access notes directly from the Notes application by tapping **Start > Notes**.

Using Speed Dial

Create speed dial numbers to dial frequently called numbers with a single tap. Before creating a speed dial entry, ensure the phone number exists in Contacts.

Adding a Speed Dial Entry

To add a speed dial entry from the phone keypad:

1. Ensure the contact and phone number are in the Contacts list.
2. Tap **Start > Phone** or press the green phone key on the FR6874's keypad.
3. Tap **Menu > Speed Dial > Menu > New**.



Figure 5-15 Contacts

4. Tap the desired contact name and number in the list.

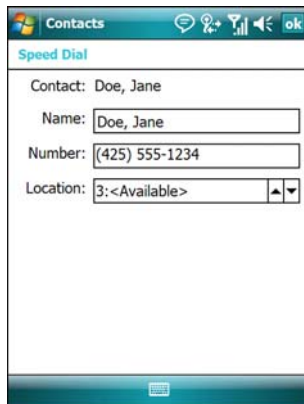

Figure 5-16 Speed Dial Contact Location

5. In the **Location** field, tap the up/down arrows to select an available location to assign as the new speed dial entry. The first speed dial location is reserved for voice mail.
6. Tap **ok** to add the contact to the speed dial list.



Figure 5-17 Speed Dial Contact List

7. Tap **ok** to exit the **Speed Dial Contact List**.

To add a speed dial entry from the **Contacts** window:

1. Tap **Start > Contacts**.

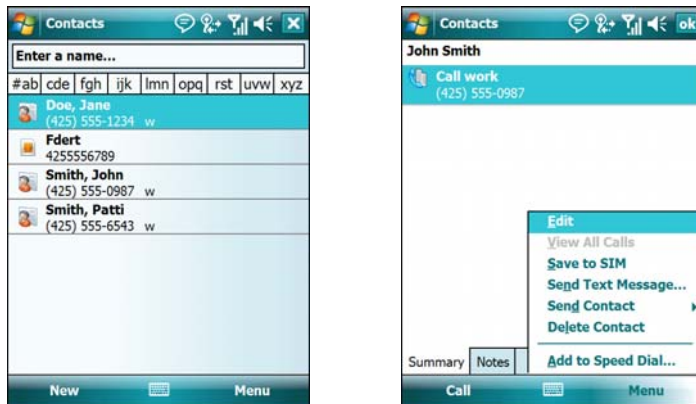

Figure 5-18 *Contacts*

2. Tap a contact name.
3. Tap **Menu > Add to Speed Dial**.



Figure 5-19 *Speed Dial Contact Location*

4. Tap the up/down arrows to select an available location to assign as the new speed dial entry. The first speed dial location is reserved for voice mail.
5. Tap **ok**.

Editing a Speed Dial Entry

1. Tap **Start > Phone** or press the green phone key on the FR6874's keypad.
2. Tap **Menu > Speed Dial**.

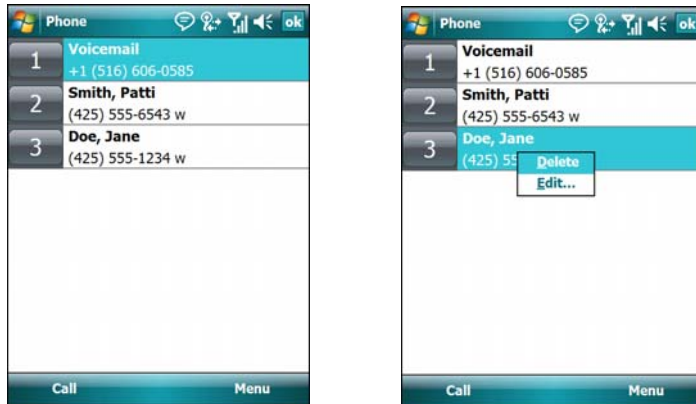

Figure 5-20 Speed Dial Contact List

3. Tap and hold the contact name.
4. Tap **Edit...**
5. Change the name, phone number, or location information.
6. Tap **ok**.

✓ **NOTE** Editing names and phone numbers in **Speed Dial** does not alter contact information in **Contacts (Start > Contacts)**.

Deleting a Speed Dial Entry

1. Tap **Start > Phone** or press the green phone key on the FR6874's keypad.
2. Tap **Menu > Speed Dial**.
3. Tap and hold the contact name.



Figure 5-21 Speed Dial Delete Menu



4. Tap **Delete**.
5. Tap **Yes** to confirm permanently deleting the speed dial entry.

✓ **NOTE** Deleting names and phone numbers in *Speed Dial* does not delete the contact information in **Contacts (Start > Contacts)**.

Using Call History

Use Call History to call someone who was recently called, or recently called in. Call History provides the time and duration of all incoming, outgoing, and missed calls. It also provides a summary of total calls and easy access to notes taken during a call. [Table 4-1](#) lists the call history icons that appear in the **Call History** window.

Table 5-1 *Call History Icons*

Icon	Description
	This icon appears next to the contact information for all outgoing calls.
	This icon appears next to the contact information for all incoming calls.
	This icon appears next to the contact information for all missed calls.

Managing Call History

Change views, reset the call timer, and delete calls to manage the calls stored in Call History.

Changing the Call History View

1. Tap **Start > Phone** or press the green phone key on the FR6874's keypad to display the Phone keypad.
2. From the Phone keypad, tap **Call History**.
3. Tap **Menu > Filter** to show the menu.

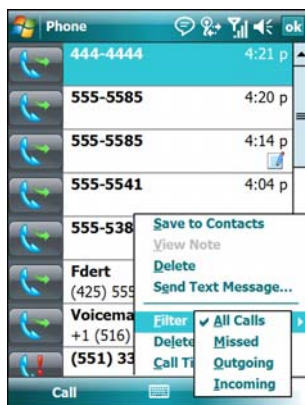

Figure 5-22 *Call History - All Calls/Show Menu*

4. Select a view type from the menu to display only missed calls, outgoing calls, incoming calls, or calls listed alphabetically by caller name.
5. Tap **ok** to exit the **Call History** window.

Resetting the Recent Calls Counter

1. Tap **Start > Phone** or press the green phone key on the FR6874's keypad to display the Phone keypad.
2. From the Phone keypad, tap **Call History**.

3. Tap **Menu**.

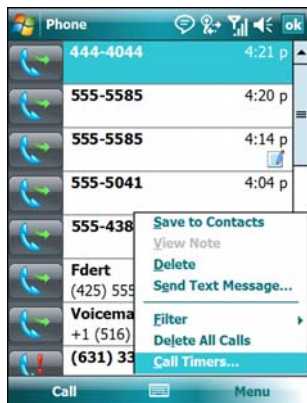

Figure 5-23 Call History - Tools Menu

4. Select **Call Timers...**

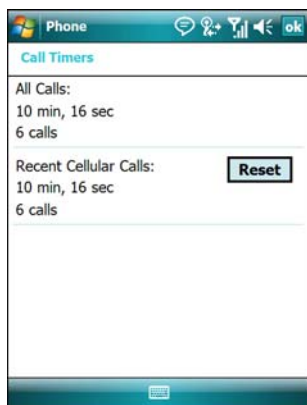

Figure 5-24 Call History - Call Timers

5. Tap **Reset**. (The **All Calls:** counter cannot be reset.)
6. Tap **ok** to exit the **Call Timers** window.

Deleting Call History Items by Call Date

1. Tap **Start** > **Phone** or press the green phone key on the FR6874's keypad to display the Phone keypad.
2. From the Phone keypad, tap **Call History**.
3. Tap **Menu** > **Call Timers...**

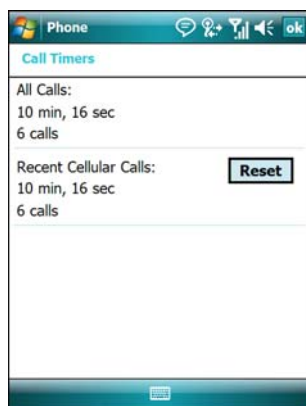

Figure 5-25 Call History - Call Timers

4. In the **Delete call history items older than:** drop-down list select a time period on which to base deletion of stored items.
5. Tap **ok** to exit the **Call Timers** window.

Deleting All Call History Items

1. Tap **Start > Phone** or press the green phone key on the FR6874's keypad to display the Phone keypad.
2. From the Phone keypad, tap **Call History**.
3. Tap **Menu**.

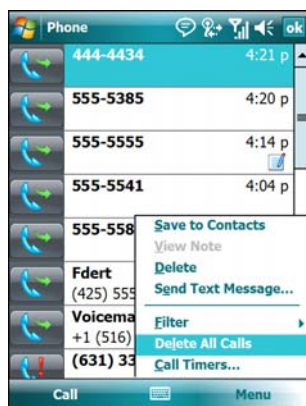

Figure 5-26 Call History - Tools Menu

4. Select *Delete all calls*.

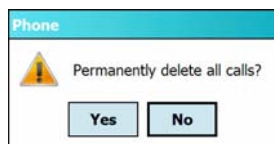

Figure 5-27 Call History - Delete All Dialog

5. Tap **Yes**.
6. Tap **ok** to exit the **Call History** window.

Viewing Call Status

1. Tap **Start** > **Phone** or press the green phone key on the FR6874's keypad to display the Phone keypad.
2. From the Phone keypad, tap **Call History**.
3. Tap an entry. The Call Status window appears.

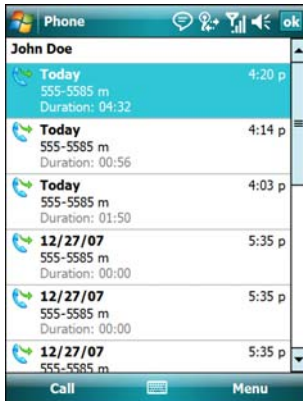

Figure 5-28 Call History - Detail



NOTE When more than one call is on the phone line, only the duration of the first call is recorded.

4. Tap **ok** and then **ok** to exit.

Using the Call History Menu

Use the Call History menu to dial voice mail, access the Activation Wizard, save to contacts, view a note, delete a listing, send an SMS, and make a call.

1. Tap **Start** > **Phone** or press the green phone key on the FR6874's keypad to display the Phone keypad.
2. From the Phone keypad, tap **Call History**.
3. Tap and hold an item in the list.

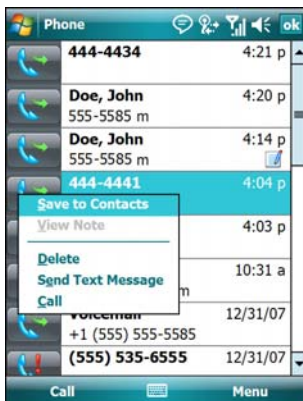

Figure 5-29 Call History - Menu

4. Select an applicable item from the menu, as needed.

5. Depending on the item selected, the appropriate window displays. For example, select **Send SMS** to display the **Inbox** window.
6. Tap **ok** to exit the **Call History** window.

Swapping Calls on an FR687476

To move between two or more phone calls:

1. Tap **Start > Phone** or press the green phone key on the FR6874's keypad to display the Phone keypad.
2. Enter the first phone number and press **Talk**. When the call connects, **Hold** appears on the keypad.



FR687476

Figure 5-30 *Call Swapping - Hold*

3. Tap **Hold** on to place the first number on hold.
4. Enter the second number and tap **Talk**.



Figure 5-31 *Call Conferencing - Conferencing*

5. Tap **Swap** to move from one call to the other.
6. Tap **End** or press the red phone key on the FR6874 keypad to end each call.

Conference Calling on an FR687476



NOTE Conference Calling and the number of conference calls allowed may not be available on all services. Please check with your service provider for Conference Calling availability.

To create a conference phone session with multiple people:

1. Tap **Start > Phone** or press the green phone key on the FR6874's keypad to display the Phone keypad.
2. Enter the first phone number and press **Talk**. When the call connects, **Hold** appears on the keypad.



Figure 5-34 Conference Call - Hold

3. Tap **Hold** to place the first call on hold.
4. Enter the second phone number and tap **Talk**.
5. After the call is answered, tap **Menu > Conference** to place the calls in conference mode.



Figure 5-35 Creating a Conference Call

6. Tap **Hold** to place the conference on hold.
7. Enter another phone number and tap **Talk**.
8. After the call is answered, tap **Menu > Conference** to place all the calls in conference mode.
9. Repeat steps 6 through 8 for up to six phone numbers.
10. Tap **End** or press the red phone key on the FR6874 keypad to end the conference call.



NOTE To speak privately with one party during a conference call, tap **Menu > Private**. To include all parties again, tap **Menu > Conference**.

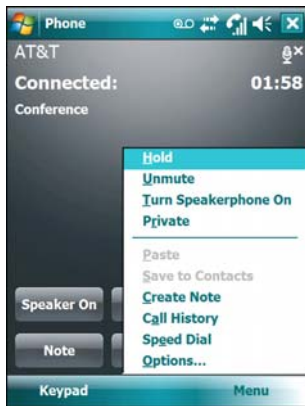

Figure 5-36 *Creating a Private Call*

Text Messaging

Use the **Text Messages** window to send and receive text messages to and from mobile phones. The text can contain words, numbers, or an alphanumeric combination no longer than 160 characters.

Short text messages delivered over mobile networks transmit from the sending FR6874, are stored in a central short message center, then forwarded to the destination mobile device. If the recipient is not available, the message is stored and can be sent later.

Viewing Text Messages

To view a text message:

You can view a text message whether the phone is on or off. When the phone is on, you can view a text message from its notification callout. Tap the **text message notification** icon on the navigation bar to display the message.

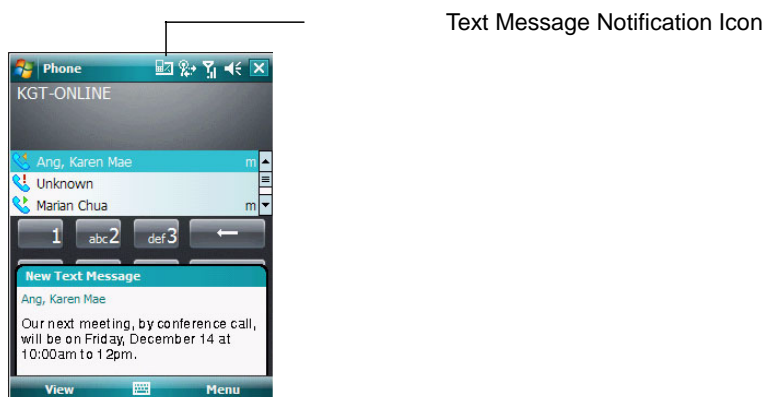

Figure 5-38 *New Text Message Notification*

The Caller Identification feature matches incoming text message numbers with those stored in **Contacts** so you know who is sending you a message. Furthermore, the **New Text Message** dialog box gives you the option to call the sender or save, dismiss, or delete the message.

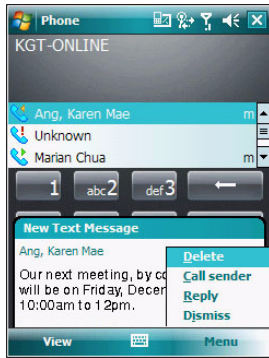

Figure 5-39 *New Text Message Options*

When the phone function is off, you can still view received text message in Messaging:

1. Tap **Start > Messaging > Text Messages**, or on the Today screen, tap **Text Messages**.

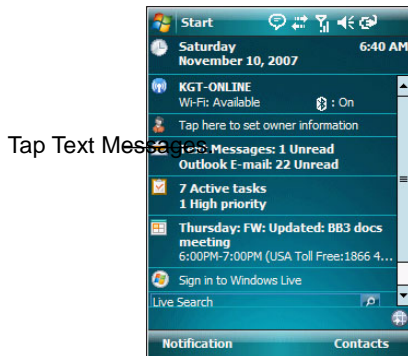

Figure 5-40 *Text Messaging on Today Screen*

The **Messaging** window appears.

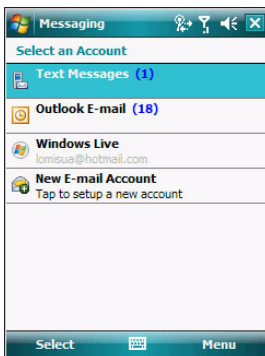
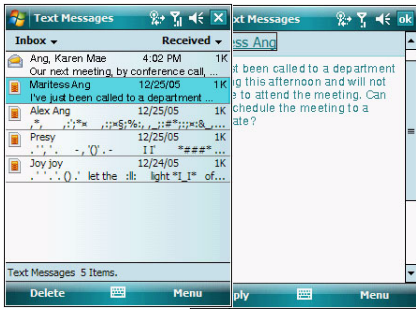

Figure 5-41 *Messaging Window*

2. In the message list, tap a **Text Messages**.



Tap to reply the message.

Figure 5-42 Text Messages List



NOTE If the phone is turned off and you tried to call the sender, send a reply, or forward the message, you are prompted to turn the phone function on.

Sending a Text Message

To create a text message:

1. On the **Phone** screen, select a contact name that you want to send a message to.
2. Tap **Menu > Send Text Message**.



Figure 5-43 Phone Screen Contact List

3. Compose your message.

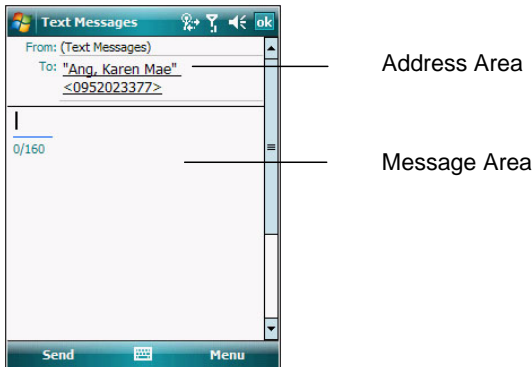

Figure 5-44 Create Text Message

- The auto-correct feature automatically fixes common spelling errors as you type so your messages are more accurate.
- The character counter lets you see and control the size of the message as you compose.

- If you want to know if your text message was received, tap **Menu > Message Options**, then select the **Request SMS** text message delivery notification check box.

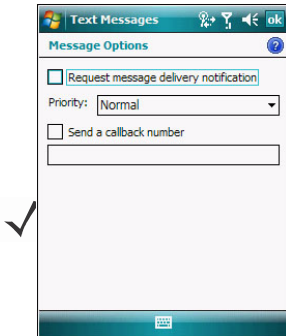

Figure 5-45 *Message Options Window*

4. Tap **Send** when you've finished the message.

If the phone is turned on, your text message is sent. If it's off, you are prompted to turn on the phone. If you do so, the message is sent; otherwise when you tap **ok**, the message is saved in the **Drafts** folder and sent when the phone is turned on.

If you are out of coverage area, the message is saved in the **Drafts** folder and sent when you return to a coverage area.

NOTE On FR687476 devices, the message remains in the **Drafts** folder and has to be manually re-sent when you return to a coverage area.

Chapter 6 Accessories

Introduction

FR6874 accessories, listed below, provide a variety of product support capabilities.

- Single Slot USB/Serial Cradle - Charges the FR6874 main battery and a spare battery. Synchronizes the FR6874 with a host computer through a USB connection.
- Four Slot Battery Charger - Charges spare standard and high capacity batteries.
- Auto Charge Cable - Plugs into a vehicle cigarette lighter to charge the FR6874 while on the road.
- Charge Only Cable - Provides power to the FR6874.
- USB Charging Cable - Provides power to the FR6874 and USB communication with a host computer.
- Headset - Used in noisy environments.

Single Slot USB/Serial Cradle

This section describes how to use a Single Slot USB/Serial cradle with the FR6874. For USB communication setup procedures refer to the *FR6874 Integrator Guide*.

The Single Slot USB/Serial Cradle:

- Provides 5.4 VDC power for operating the FR6874.
- Synchronizes information between the FR6874 and a host computer. Refer to the *FR6874 Integrator Guide* for information on setting up a partnership between the FR6874 and a host computer.
- Charges the FR6874's battery.
- Charges a spare battery.

Charging the FR6874 Battery

Connect the cradle to power. Insert the FR6874 into the slot to begin charging.

Note : Please put the adaptor clip into the cradle before charging.

*Charging LED

Slow Blinking Amber=Charging

Solid Green=Fully Charged
 Fast Blinking Red=Charging Error

*It is recommended that this product be charged for 24 hours before the first use to ensure that the internal battery is fully charged.

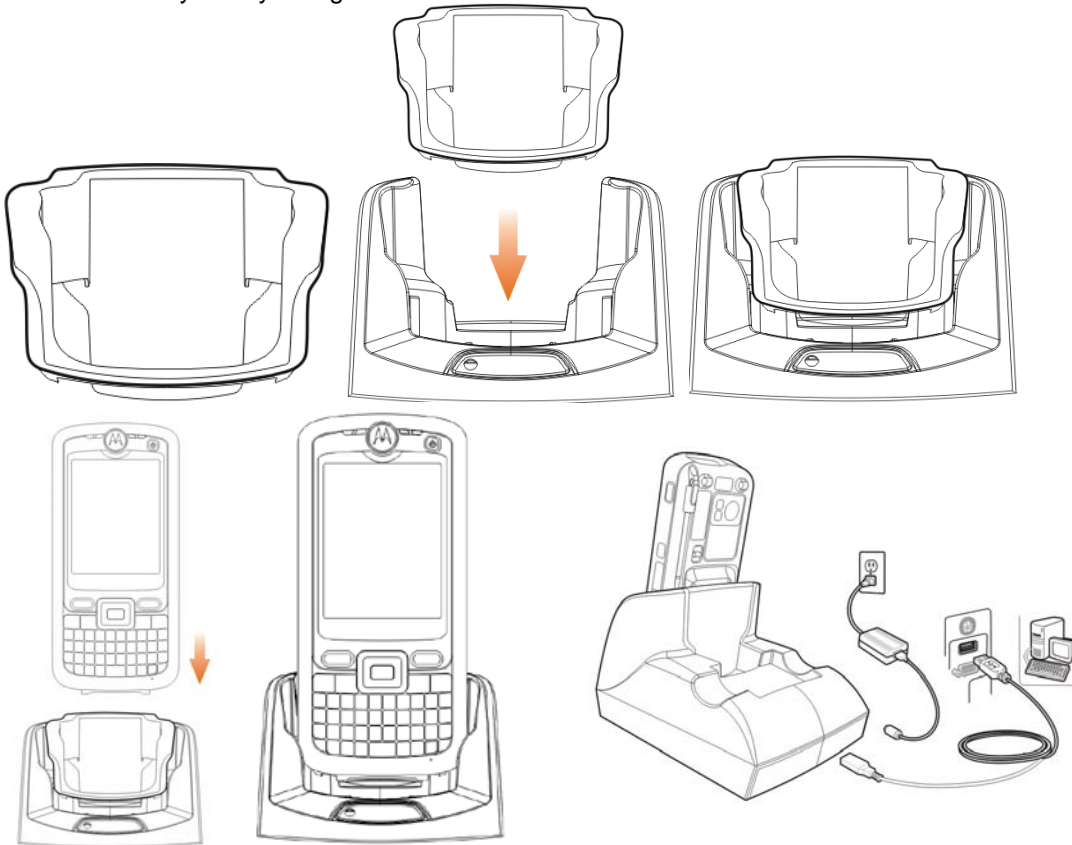

Figure 6-1 FR6874 Battery Charging

Charging the Spare Battery

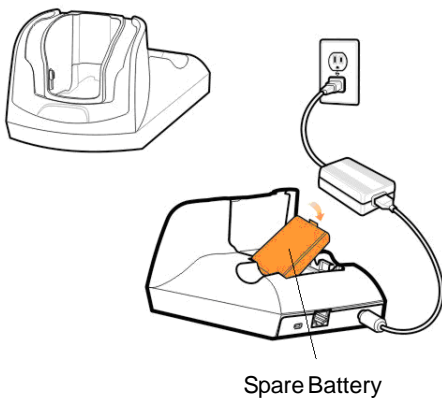

Figure 6-2 Spare Battery Charging

Battery Charging Indicators

The Single Slot USB/Serial Cradle charges the FR6874's main battery and a spare battery simultaneously.

The FR6874's charge LED indicates the status of the battery charging in the FR6874. See [Table 1-2 on page 1-7](#) for charging status indications.

The spare battery charging LED on the cradle indicates the status of the spare battery charging in the cradle. See [Table 6-1](#) for charging status indications.

The 3600 mAh battery fully charges in less than five hours and the 4800 mAh battery fully charges in less than seven hours.

Charging Temperature

Charge batteries in temperatures from 0°C to 45°C (32°F to 114°F). Charging is intelligently controlled by the FR6874

To accomplish this, for small periods of time, the FR6874 or accessory alternately enables and disables battery charging to keep the battery at acceptable temperatures. The FR6874 or accessory indicates when charging is disabled due to abnormal temperatures via its LED. See [Table 1-2 on page 1-7](#) and [Table 6-1](#).

Table 6-1 Spare Battery LED Charging Indicators

Spare Battery LED (on cradle)	Indication
Off	Battery is not charging; battery is not inserted correctly in the cradle; cradle is not powered
Slow Blinking Amber	Spare battery is charging.
Solid Amber	Charging complete.

Headset

Use the headset to communicate via Voice-Over-IP (VOIP) or for audio playback and telephony applications. To connect the headset, remove the plug from the headset jack at the top of the FR6874 and insert the headset connector. Contact a Motorola representative for compatible headsets.

For best performance, Motorola recommends a 2.5mm jack headset, p/n 50-11300-050R.



Figure 6-5 *Headset Connection*

Cables

This section describes how to set up and use the cables. The cables are available with a variety of connection capabilities.

The following communication/charge cables are available:

- USB Client Charge cable (standard-A connector and a barrel receptacle for power)
- Auto charge cable
- Charge only cable.

The following printer cables are available directly from Motorola:

- O'Neil Printer cable
- Zebra Printer cable.

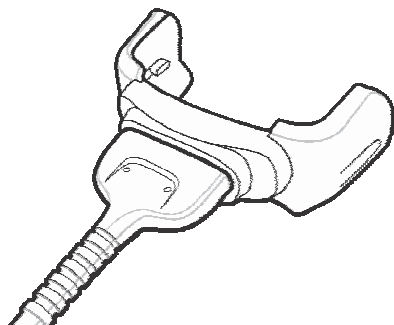

Figure 6-6 *Cables*

Communication/charge cables:

- Provide the FR6874 with operating and charging power when used with the Motorola approved power supply.
- Synchronize information between the FR6874 and a host computer. With customized or third party software, it can also synchronize the FR6874 with corporate databases.
- Provide USB connection through the USB pass-through port for communication with a USB device, such as a host computer. For communication setup procedures, refer to the *FR6874 Integrator Guide*.

Dedicated printer cables provide communication with a printer.

Battery Charging and Operating Power

The communication/charge cables can charge the FR6874 battery and supply operating power. To charge the FR6874 battery:

1. Connect the communication/charge cable power input connector to the Motorola approved power source.
2. Slide the bottom of the FR6874 into the connector end of the communication/charge cable and gently press in until it latches into the FR6874. The FR6874 amber Charge LED indicates the FR6874 battery charging status. The 3600 mAh standard battery charges in less than five hours and the 4800 mAh standard battery charges in less than seven hours. See [Table 1-2 on page 1-7](#) for charging status indications.
3. When charging is complete, remove the cable by gently pulling the FR6874 and the cable apart.

LED Charge Indications

The amber Charge LED on the FR6874 indicates battery charging status. See [Table 1-2 on page 1-7](#) for charging status indications.

Charging Temperature

Charge batteries in temperatures from 0°C to 45°C (32°F to 113°F). Charging is intelligently controlled by the FR6874.

To accomplish this, for small periods of time, the FR6874 or accessory alternately enables and disables battery charging to keep the battery at acceptable temperatures. The FR6874 or accessory indicates when charging is disabled due to abnormal temperatures via its LED. See [Table 1-2 on page 1-7.4](#)

Chapter 7 Maintenance & Troubleshooting

Introduction

This chapter includes instructions on cleaning and storing the FR6874, and provides troubleshooting solutions for potential problems during FR6874 operation.

Maintaining the FR6874

For trouble-free service, observe the following tips when using the FR6874:

- Do not scratch the screen of the FR6874. When working with the FR6874, use the supplied stylus or plastic-tipped pens intended for use with a touch-sensitive screen. Never use an actual pen or pencil or other sharp object on the surface of the FR6874 screen.

Motorola recommends using a screen protector, p/n KT-67525-01R.

- The touch-sensitive screen of the FR6874 is glass. Do not drop the FR6874 or subject it to strong impact.
- Protect the FR6874 from temperature extremes. Do not leave it on the dashboard of a car on a hot day, and keep it away from heat sources.
- Do not store or use the FR6874 in any location that is dusty, damp, or wet.
- Use a soft lens cloth to clean the FR6874. If the surface of the FR6874 screen becomes soiled, clean it with a soft cloth moistened with a diluted window-cleaning solution.
- Periodically replace the rechargeable battery to ensure maximum battery life and product performance. Battery life depends on individual usage patterns.

- A screen protector is applied to the FR6874. Motorola recommends using this to minimize wear and tear. Screen protectors enhance the usability and durability of touch screen displays. Benefits include:
 - Protection from scratches and gouges
 - Durable writing and touch surface with tactile feel
 - Abrasion and chemical resistance
 - Glare reduction
 - Keeping the device's screen looking new
 - Quick and easy installation.

Battery Safety Guidelines

- The area in which the units are charged should be clear of debris and combustible materials or chemicals. Particular care should be taken where the device is charged in a non commercial environment.
- Follow battery usage, storage, and charging guidelines found in the user's guide.
- Improper battery use may result in a fire, explosion, or other hazard.
- To charge the mobile device battery, the battery and charger temperatures must be between +32 °F and +113 °F (0 °C and +45 °C)
- Do not use incompatible batteries and chargers. Use of an incompatible battery or charger may present a risk of fire, explosion, leakage, or other hazard. If you have any questions about the compatibility of a battery or a charger, contact Motorola Enterprise Mobility support.
- For devices that utilize a USB port as a charging source, the device shall only be connected to products that bear the USB-IF logo or have completed the USB-IF compliance program.
- To enable authentication of an approved battery, as required by IEEE1725 clause 10.2.1, all batteries will carry a Motorola hologram. Do not fit any battery without checking it has the Motorola authentication hologram.
- Do not disassemble or open, crush, bend or deform, puncture, or shred.
- Severe impact from dropping any battery-operated device on a hard surface could cause the battery to overheat.
- Do not short circuit a battery or allow metallic or conductive objects to contact the battery terminals.
- Do not modify or remanufacture, attempt to insert foreign objects into the battery, immerse or expose to water or other liquids, or expose to fire, explosion, or other hazard.
- Do not leave or store the equipment in or near areas that might get very hot, such as in a parked vehicle or near a radiator or other heat source. Do not place battery into a microwave oven or dryer.
- Battery usage by children should be supervised.
- Please follow local regulations to promptly dispose of used re-chargeable batteries.
- Do not dispose of batteries in fire.
- Seek medical advice immediately if a battery has been swallowed.
- In the event of a battery leak, do not allow the liquid to come in contact with the skin or eyes. If contact has been made, wash the affected area with large amounts of water and seek medical advice.
- If you suspect damage to your equipment or battery, contact Motorola Enterprise Mobility support to arrange for inspection.

Cleaning



CAUTION Always wear eye protection.

Read warning label on compressed air and alcohol product before using.

If you have to use any other solution for medical reasons please contact Motorola for more information.



WARNING! Avoid exposing this product to contact with hot oil or other flammable liquids. If such exposure occurs, unplug the device and clean the product immediately in accordance with these guidelines.

Materials Required

- Alcohol wipes
- Lens tissue
- Cotton tipped applicators
- Isopropyl alcohol
- Can of compressed air with a tube.

Cleaning the FR6874

Housing

Using the alcohol wipes, wipe the housing including keys and in-between keys.

Display

The display can be wiped down with the alcohol wipes, but care should be taken not to allow any pooling of liquid around the edges of the display. Immediately dried the display with a soft, non-abrasive cloth to prevent streaking.

Scanner Exit Window

Wipe the scanner exit window periodically with a lens tissue or other material suitable for cleaning optical material such as eyeglasses.

Connector

1. Remove the main battery from mobile computer. See *Replacing the Main Battery on page 1-11*.
2. Close battery door.
3. Dip the cotton portion of the cotton tipped applicator in isopropyl alcohol.
4. Rub the cotton portion of the cotton tipped applicator back-and-forth across the connector on the bottom of the FR6874. Do not leave any cotton residue on the connector.
5. Repeat at least three times.
6. Use the cotton tipped applicator dipped in alcohol to remove any grease and dirt near the connector area.
7. Use a dry cotton tipped applicator and repeat steps 4 through 6.

8. Spray compressed air on the connector area by pointing the tube/nozzle about ½ inch away from the surface. CAUTION: Do not point nozzle at yourself and others, ensure the nozzle or tube is away from your face.
9. Inspect the area for any grease or dirt, repeat if required.

Cleaning Cradle Connectors

To clean the connectors on a cradle:

1. Remove the DC power cable from the cradle.
2. Dip the cotton portion of the cotton tipped applicator in isopropyl alcohol.
3. Rub the cotton portion of the cotton tipped applicator along the pins of the connector. Slowly move the applicator back-and-forth from one side of the connector to the other. Do not let any cotton residue on the connector.
4. All sides of the connector should also be rubbed with the cotton tipped applicator.
5. Spray compressed air in the connector area by pointing the tube/nozzle about ½ inch away from the surface. CAUTION: do not point nozzle at yourself and others, ensure the nozzle or tube is pointed away from your face.
6. Ensure that there is no lint left by the cotton tipped applicator, remove lint if found.
7. If grease and other dirt can be found on other areas of the cradle, use lint free cloth and alcohol to remove.
8. Allow at least 10 to 30 minutes (depending on ambient temperature and humidity) for the alcohol to air dry before applying power to cradle.

If the temperature is low and humidity is high, longer drying time is required. Warm temperature and dry humidity requires less drying time.

Cleaning Frequency

The cleaning frequency is up to the customer's discretion due to the varied environments in which the mobile devices are used. They may be cleaned as frequently as required. However when used in dirty environments it may be advisable to periodically clean the scanner exit window to ensure optimum scanning performance.

Troubleshooting

FR6874

Table 7-1 Troubleshooting the FR6874

Problem	Cause	Solution
FR6874 does not turn on.	Lithium-ion battery not charged.	Charge or replace the lithium-ion battery in the FR6874.
	Lithium-ion battery not installed properly.	Install the battery properly. See <i>Installing the Main Battery</i> on page 1-6.
	System crash.	Perform a warm boot. If the FR6874 still does not turn on, perform a cold boot. See <i>Resetting the FR6874</i> on page 2-14.
Rechargeable lithium-ion battery did not charge.	Battery failed.	Replace battery. If the FR6874 still does not operate, perform a warm boot, then a cold boot. See <i>Resetting the FR6874</i> on page 2-14.
	FR6874 removed from cradle while battery was charging.	Insert FR6874 in cradle. The 3600 mAh battery fully charges in less than six hours.
	Extreme battery temperature.	Battery does not charge if ambient temperature is below 0°C (32°F) or above 45°C (113°F).
Cannot see characters on display.	FR6874 not powered on.	Press the Power button.
During data communication, no data transmitted, or transmitted data was incomplete.	FR6874 removed from cradle or disconnected from host computer during communication.	Replace the FR6874 in the cradle, or reattach the communication cable and re-transmit.
	Incorrect cable configuration.	See the system administrator.
	Communication software was incorrectly installed or configured.	Perform setup. Refer to the <i>FR6874 Integrator Guide</i> for details.
No sound.	Volume setting is low or turned off.	Adjust the volume. See <i>Adjusting Volume</i> on page 2-10.

Table 7-1 Troubleshooting the FR6874 (Continued)

Problem	Cause	Solution
FR6874 shuts off.	FR6874 is inactive.	The FR6874 turns off after a period of inactivity. If the FR6874 is running on battery power, set this period from 1 to 5 minutes, in one-minute intervals. If the FR6874 is running on external power, set this period to 1, 2, 5, 10, 15, or 30 minutes. Check the <i>Power</i> window by selecting Start > Settings > System tab and tapping the Power icon. Select the Advanced tab and change the setting for a longer delay before the automatic shutoff feature activates.
	Battery is depleted.	Replace the battery.
	Battery is not inserted properly.	Insert the battery properly. See <i>Installing the Main Battery</i> on page 1-6.
Tapping the window buttons or icons does not activate the corresponding feature.	Screen is not calibrated correctly.	Re-calibrate the screen. See <i>Calibrating the Screen</i> on page 1-8.
	The system is not responding.	Warm boot the system. See <i>Resetting the FR6874</i> on page 2-14.
A message appears stating that the FR6874 memory is full.	Too many files stored on the FR6874.	Delete unused memos and records. If necessary, save these records on the host computer (or use an SD card for additional memory).
	Too many applications installed on the FR6874.	Remove user-installed applications on the FR6874 to recover memory. Select Start > Settings > System tab and tap the Remove Programs icon. Select the unused program and tap Remove .
FR6874 keeps powering down to protect memory contents.	The FR6874's battery is low.	Recharge the battery.
	The internal Bluetooth radio is powered on for a long time.	Because this mode requires battery power, power it off when not needed.

Table 7-1 *Troubleshooting the FR6874 (Continued)*

Problem	Cause	Solution
The FR6874 does not accept scan input.	Scanning application is not loaded.	Load a scanning application on the FR6874. See the system administrator.
	Unreadable bar code.	Ensure the symbol is not defaced.
	Distance between exit window and bar code is incorrect.	Place the FR6874 within proper scanning range.
	FR6874 is not programmed for the bar code.	Program the FR6874 to accept the type of bar code being scanned.
	FR6874 is not programmed to generate a beep.	If the FR6874 does not beep on a good decode, set the application to generate a beep on good decode.
	Battery is low.	If the scanner stops emitting a laser beam upon a trigger press, check the battery level. When the battery is low, the scanner shuts off before the FR6874 low battery condition notification. Note: If the scanner is still not reading symbols, contact the distributor or Motorola.

Bluetooth Connection

Table 7-2 *Troubleshooting Bluetooth Connection*

Problem	Cause	Solution
FR6874 cannot find any Bluetooth devices nearby.	Too far from other Bluetooth devices.	Move closer to the other Bluetooth device(s), within a range of 10 meters.
	The Bluetooth device(s) nearby are not turned on.	Turn on the Bluetooth device(s).
	The Bluetooth device(s) are not in discoverable mode.	Set the Bluetooth device(s) to discoverable mode. If needed, refer to the device's user documentation for help.
When trying to connect a Bluetooth phone and FR6874, the phone thinks a previously paired FR6874 is used.	The phone remembers the name and address of the FR6874 it last paired with via the Bluetooth radio.	Manually delete the pairing device and name from the phone. Refer to the phone's user documentation for instructions.

Single Slot USB/Serial Cradle

Table 7-3 Troubleshooting the Single Slot USB/Serial Cradle

Symptom	Possible Cause	Action
LEDs do not light when FR6874 or spare battery is inserted.	Cradle is not receiving power.	Ensure the power cable is connected securely to both the cradle and to AC power.
	FR6874 is not seated firmly in the cradle.	Remove and re-insert the FR6874 into the cradle, ensuring it is firmly seated.
	Spare battery is not seated firmly in the cradle.	Remove and re-insert the spare battery into the charging slot, ensuring it is firmly seated.

Table 7-3 Troubleshooting the Single Slot USB/Serial Cradle (Continued)

Symptom	Possible Cause	Action
FR6874 battery is not charging.	FR6874 was removed from cradle or cradle was unplugged from AC power too soon.	Ensure cradle is receiving power. Ensure FR6874 is seated correctly. Confirm main battery is charging under Start > Settings > System > Power . The 3600 mAh battery fully charges in less than six hours.
	Battery is faulty.	Verify that other batteries charge properly. If so, replace the faulty battery.
	The FR6874 is not fully seated in the cradle.	Remove and re-insert the FR6874 into the cradle, ensuring it is firmly seated.
	Ambient temperature of the cradle is too warm.	Move the cradle to an area where the ambient temperature is between 0°C (32°F) and 35°C (95°F).
	Extreme battery temperature.	Battery does not charge if ambient temperature is below 0°C (32°F) or above 45°C (113°F).
Spare battery is not charging.	Battery not fully seated in charging slot.	Remove and re-insert the spare battery in the cradle, ensuring it is firmly seated.
	Battery inserted incorrectly.	Re-insert the battery so the charging contacts on the battery align with the contacts on the cradle.
	Battery is faulty.	Verify that other batteries charge properly. If so, replace the faulty battery.
	Ambient temperature of the cradle is too warm.	Move the cradle to an area where the ambient temperature is between 0°C (32°F) and 35°C (95°F).
During data communication, no data transmits, or transmitted data was incomplete.	FR6874 removed from cradle during communications.	Replace FR6874 in cradle and retransmit.
	Incorrect cable configuration.	See the system administrator.

	Communication software is not installed or configured properly.	Perform setup as described in the <i>FR6874 Integrator Guide</i> .
--	---	--

Cables

Table 7-5 *Troubleshooting the Cables*

Symptom	Possible Cause	Action
FR6874 battery is not charging.	FR6874 was disconnected from AC power too soon.	Connect the power cable correctly. Confirm main battery is charging under Start > Settings > System > Power . The 3600 mAh battery fully charges in less than six hours.
	Battery is faulty.	Verify that other batteries charge properly. If so, replace the faulty battery.
	The FR6874 is not fully attached to	Detach and re-attach the power cable to the FR6874, ensuring it is firmly connected.
During data communication, no data transmits, or transmitted data was incomplete.	Cable was disconnected from FR6874 during communications.	Re-attach the cable and retransmit.
	Incorrect cable configuration.	See the system administrator.
	Communication software is not installed or configured properly.	Perform setup as described in the <i>FR6874 Integrator Guide</i> .