

P P T 2 8 0 0 S e r i e s

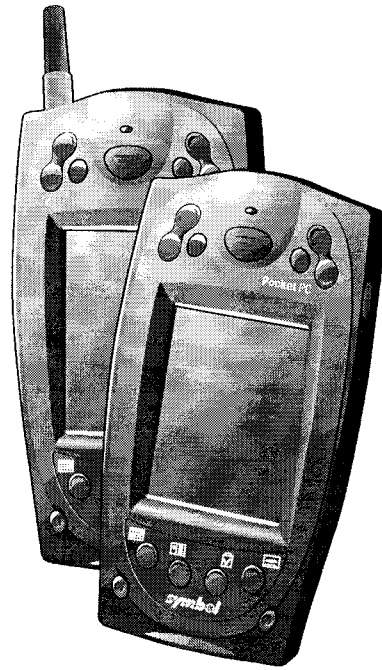

symbol[®]

P P T 2 8 0 0 S e r i e s

© 2001 SYMBOL TECHNOLOGIES, INC. All rights reserved.

Symbol reserves the right to make changes to any product to improve reliability, function, or design.

Symbol does not assume any product liability arising out of, or in connection with, the application or use of any product, circuit, or application described herein.

No license is granted, either expressly or by implication, estoppel, or otherwise under any patent right or patent, covering or relating to any combination, system, apparatus, machine, material, method, or process in which Symbol products might be used. An implied license only exists for equipment, circuits, and subsystems contained in Symbol products.

Symbol is a registered trademark of Symbol Technologies, Inc. Other product names mentioned in this manual may be trademarks or registered trademarks of their respective companies and are hereby acknowledged.

Symbol Technologies, Inc.

One Symbol Plaza

Holtsville, N.Y. 11742-1300

<http://www.symbol.com>

Patents

This product is covered by one or more of the following U.S. and foreign Patents:

U.S. Patent No. 4,460,120; 4,496,831; 4,593,186; 4,603,262; 4,607,156; 4,652,750; 4,673,805; 4,736,095; 4,758,717; 4,816,660; 4,845,350; 4,896,026; 4,897,532; 4,923,281; 4,933,538; 4,992,717; 5,015,833; 5,017,765; 5,021,641; 5,029,183; 5,047,617; 5,103,461; 5,113,445; 5,130,520; 5,140,144; 5,142,550; 5,149,950; 5,157,687; 5,168,148; 5,168,149; 5,180,904; 5,216,232; 5,229,591; 5,230,088; 5,235,167; 5,243,655; 5,247,162; 5,250,791; 5,250,792; 5,260,553; 5,262,627; 5,262,628; 5,266,787; 5,278,398; 5,280,162; 5,280,163; 5,280,164; 5,280,498; 5,304,786; 5,304,788; 5,306,900; 5,321,246; 5,324,924; 5,337,361; 5,367,151; 5,373,148; 5,378,882; 5,396,053; 5,396,055; 5,399,846; 5,408,081; 5,410,139; 5,410,140; 5,412,198; 5,418,812; 5,420,411; 5,436,440; 5,444,231; 5,449,891; 5,449,893; 5,468,949; 5,471,042; 5,478,998; 5,479,000; 5,479,002; 5,479,441; 5,504,322; 5,519,577; 5,528,621; 5,532,469; 5,543,610; 5,545,889; 5,552,592; 5,557,093; 5,578,810; 5,581,070; 5,589,679; 5,589,680; 5,608,202; 5,612,531; 5,619,028; 5,627,359; 5,637,852; 5,664,229; 5,668,803; 5,675,139; 5,693,929; 5,698,835; 5,705,800; 5,714,746; 5,723,851; 5,734,152; 5,734,153; 5,742,043; 5,745,794; 5,754,587; 5,762,516; 5,763,863; 5,767,500; 5,789,728; 5,789,731; 5,808,287; 5,811,785; 5,811,787; 5,815,811; 5,821,519; 5,821,520; 5,823,812; 5,828,050; 5,850,078; 5,861,615; 5,874,720; 5,875,415; 5,900,617; 5,902,989; 5,907,146; 5,912,450; 5,914,478; 5,917,173; 5,920,059; 5,923,025; 5,929,420; 5,945,658; 5,945,659; 5,946,194; 5,959,285; 6,002,918; 6,021,947; 6,036,098; 6,047,892; 6,050,491; 6,053,413; 6,056,200; 6,065,678; 6,067,297; 6,068,190; 6,082,621; 6,084,528; 6,088,482; 6,092,725; 6,101,483; 6,102,293; 6,104,620; 6,114,712; 6,115,678; 6,119,944; 6,123,265; 6,131,814; 6,138,180; 6,142,379; 6,172,478; 6,176,428; 6,178,426; 6,186,400; 6,188,681; D305,885; D341,584; D344,501; D359,483; D362,453; D363,700; D363,918; D370,478; D383,124; D391,250; D405,077; D406,581; D414,171; D414,172; D418,500; D419,548; D423,468; D424,035; D430,158; D430,159; D431,562; D436,104.

Invention No. 55,358; 62,539; 69,060; 69,187 (Taiwan); No. 1,601,796; 1,907,875; 1,955,269 (Japan).

European Patent 367,299; 414,281; 367,300; 367,298; UK 2,072,832; France 81/03938; Italy 1,138,713.

rev. 04/01

FCC RF EXPOSURE INFORMATION

WARNING! *Read this information before using your phone*



In August 1996 the Federal Communications Commission (FCC) of the United States with its action in Report and Order FCC 96-326 adopted an updated safety standard for human exposure to radio frequency electromagnetic energy emitted by FCC regulated transmitters. Those guidelines are consistent with the safety standard previously set by both U.S. and international standards bodies. The design of this phone complies with the FCC guidelines and these international standards.



Use only the supplied or an approved antenna. Unauthorized antennas, modifications, or attachments could impair call quality, damage the phone, or result in violation of FCC regulations.

Do not use the phone with a damaged antenna. If a damaged antenna comes into contact with the skin, a minor burn may result. Please contact your local dealer for replacement antenna.

Body-worn Operation

This device was tested for typical body-worn operations using the belt-clip placed 2.0 cm. from the body. To comply with RF exposure requirements, a minimum separation distance of 2.0 cm. must be maintained between the user's body and the belt-clip/holster, including the antenna. The use of other belt-clip/holsters and other non-tested accessories may not comply with FCC RF Exposure requirements and should be avoided.

Q u i c k R e f e r e n c e

Introduction

Congratulations on your purchase of Symbol Technologies' PPT 2800 Terminal! Its unique combination of features make this product superior for use in a wide range of applications. These features include:

- Pocket size
- Personal Information Management software
- Microsoft® Windows® Pocket PC operating system
- RF communication via Symbol's Spectrum24 wireless network or a wide area network (WAN)
- Printing support
- 1-dimensional scanning capability.

About This Guide

This guide describes how to set up and use the terminal. The term PPT 2800 refers to the batch terminal and the Spectrum24 terminal. Specific topics covered include:

- *Parts of the PPT 2800* on page 2
- *Installing Batteries* on page 4
- *Charging the Battery* on page 5
- *Starting the PPT 2800* on page 8
- *Aligning the Screen* on page 8
- *Using the PPT 2800* on page 9
- *Using the Stylus* on page 10
- *Today Screen* on page 11
- *Navigation Bar and Command Bar* on page 12
- *Input Methods* on page 13
- *Scanning with the PPT 2800* on page 15
- *Resetting Your PPT 2800 Terminal* on page 16
- *Maintaining the PPT 2800* on page 18
- *Troubleshooting* on page 18.

The *PPT 2800 Product Reference Guide* (p/n 72-50931-xx), available from your Reseller or from Symbol Technologies, details the applications available for the PPT 2800.

P P T 2 8 0 0 S e r i e s

Parts of the PPT 2800

Front View

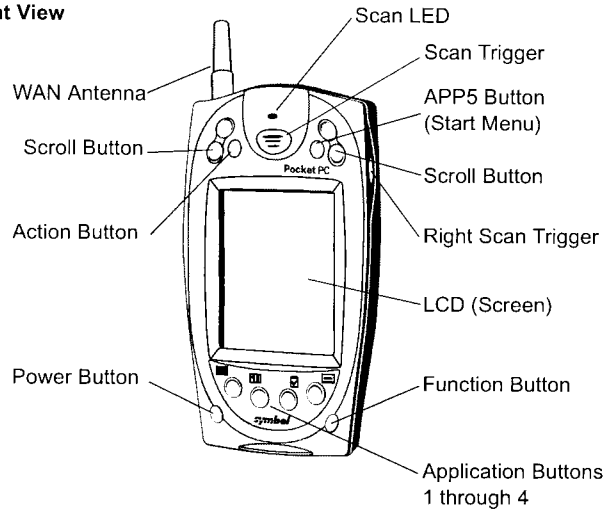

Left View

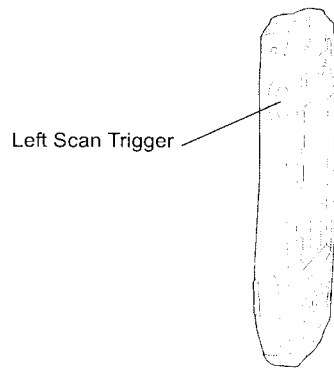

Q u i c k R e f e r e n c e

Parts of the PPT 2800 (continued)

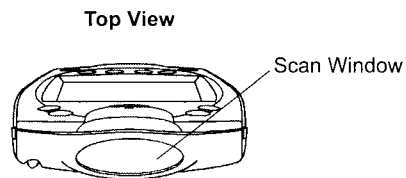
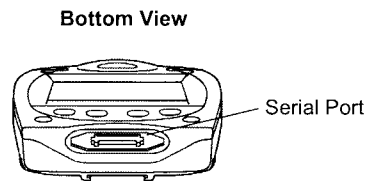
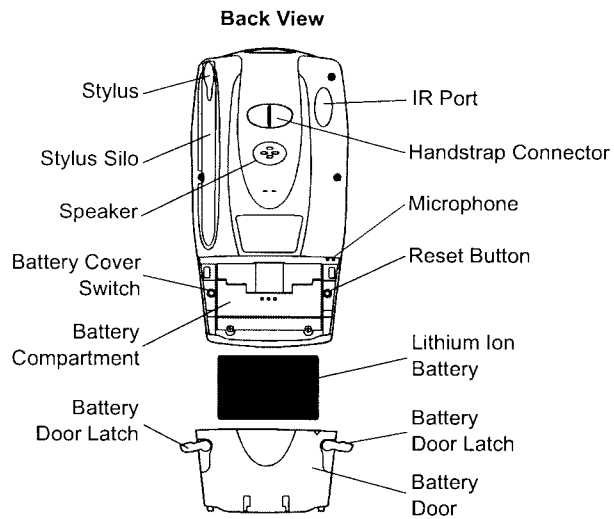

P P T 2 8 0 0 S e r i e s

Installing Batteries

Before using your PPT 2800, install a lithium-ion battery:

1. Open the latches on the battery door and lift the battery door away from the PPT 2800.

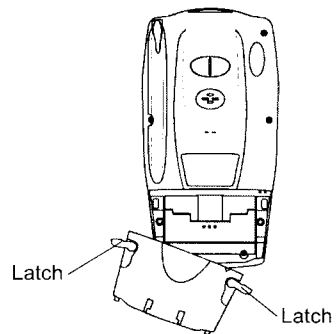

2. Insert the lithium-ion battery in the battery compartment with the battery tether positioned properly (as shown below), making sure the battery snaps into place.

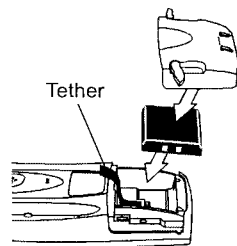

3. Replace the battery cover, pressing down firmly while securing the latches.

Q u i c k R e f e r e n c e

Charging the Battery

Before using your PPT 2800 for the first time, charge the lithium-ion battery in the terminal for about 2 1/2 hours, using the cradle or the synchronization cable. Follow these same procedures to recharge the battery.

Your terminal is equipped with a memory backup battery which automatically charges from the fully-charged lithium-ion battery. This backup battery retains data in memory when the terminal's battery is removed, and takes several hours to charge when you first use your terminal.

Note: If you remove your lithium-ion battery before the back-up battery is fully charged, data may be lost. For this reason, DO NOT remove the battery within the first ten hours of use.

Charging the Battery Using the Cradle

1. Plug the cradle into a wall outlet.
2. Insert the PPT 2800 terminal in the cradle.

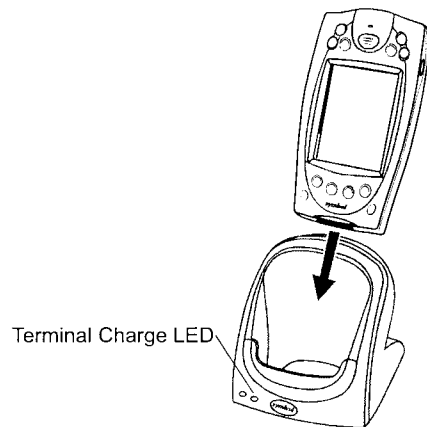

P P T 2 8 0 0 S e r i e s

3. The Terminal Charge LED turns red (may take up to one minute) to indicate charging, then green when the battery is fully charged. The terminal's battery is fully charged after approximately 2 1/2 hours.

Charging a Spare Battery

To recharge a terminal's spare battery, insert it in the spare battery charging slot in the back of the cradle, oriented so the contacts are facing down and toward the back of the cradle. Press the battery down into the slot until firmly seated.

The Spare Battery Charge LED turns red to indicate charging, then green when the battery is fully charged. The battery is fully charged after approximately 2 1/2 hours. See the cradle's *Quick Reference Guide* for more information.

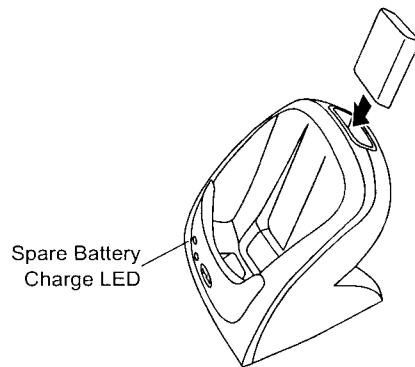

Q u i c k R e f e r e n c e

Charging the Battery Using the Synchronization Cable

1. Insert the cable into the bottom of the terminal.

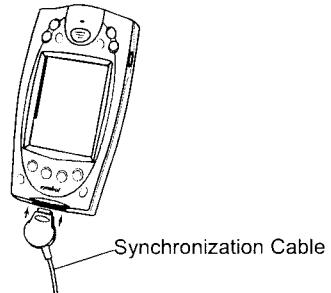

2. Plug the power cable into a wall outlet and plug the other end into the battery charging receptacle on the side of the synchronization cable.

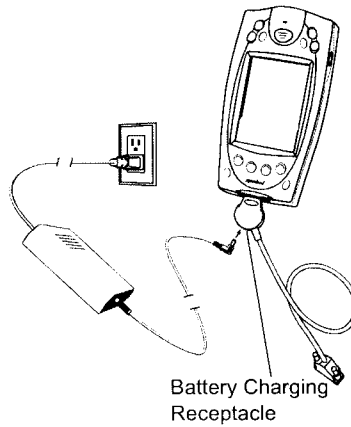

P P T 2 8 0 0 S e r i e s

Starting the PPT 2800

Press the red power button to start the terminal. If the terminal does not power on, perform a hard reset. See *Performing a Hard Reset* on page 17.

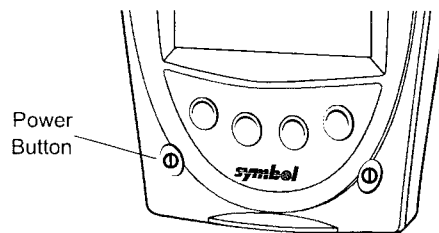

As the terminal initializes its unique Flash File system, the Symbol splash screen displays for about a minute.

When the Welcome screen appears, tap anywhere on the screen to continue to the Align screen. Note that these screens also appear every time you perform a hard reset.

Aligning the Screen

To align your PPT 2800 so the cursor on the touch screen aligns with the tip of your stylus:

1. If necessary, adjust the contrast on the PPT 2800 so the screen is readable. See *Controlling the Contrast/Backlight* on page 9.
2. Remove the stylus from its storage silo on the back of the PPT 2800.

Q u i c k R e f e r e n c e

3. Tap the center of each target that appears on the screen with the tip of the stylus.

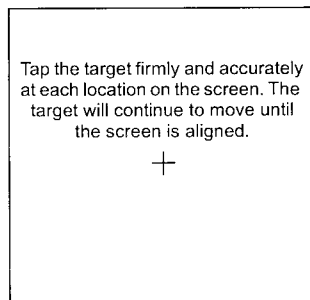

4. Follow the directions on the screen which explain how to use the stylus and pop-up menus, and allow you to set your city and time zone.

Using the PPT 2800

Using the Power Button

Press the power button on the lower left-hand side of the terminal to turn the PPT 2800 on and off.

Controlling the Contrast/Backlight

The Function button, shown below, allows you to adjust the contrast of the screen and control the backlight.

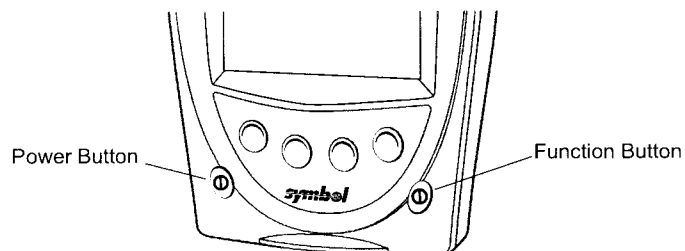

P P T 2 8 0 0 S e r i e s

To adjust the contrast:

1. Press and hold the Function button.
2. Press the “up” scroll button at the top of the terminal to darken the screen, or the “down” scroll button to lighten the screen.

To turn the backlight on or off:

1. Press and hold the Function button.
2. Press any application button.

Using the Stylus

The stylus selects items and enters information. The stylus functions as a mouse.

- **Tap:** Touch the screen once with the stylus to open items and select options.
- **Drag:** Hold the stylus on the screen and drag across the screen to select text and images. Drag in a list to select multiple items.
- **Tap-and-hold:** Tap and hold the stylus on an item to see a list of actions available for that item. On the pop-up menu that appears, tap the action you want to perform.

Q u i c k R e f e r e n c e

Today Screen

When you turn on your terminal for the first time each day (or after 4 hours of inactivity), the Today screen appears. You can also display it by tapping , then Today. On the Today screen, you can see important information for the day.

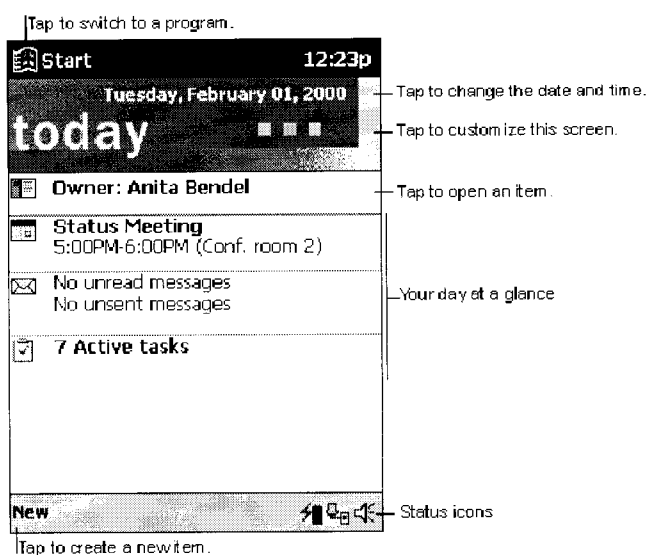

Navigation Bar and Command Bar

The navigation bar at the top of the screen displays the active program and current time, and allows you to switch to programs and close screens. The command bar at the bottom of the screen contains menus and buttons to perform tasks in programs.

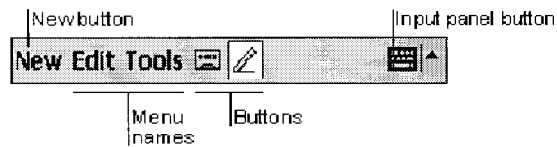
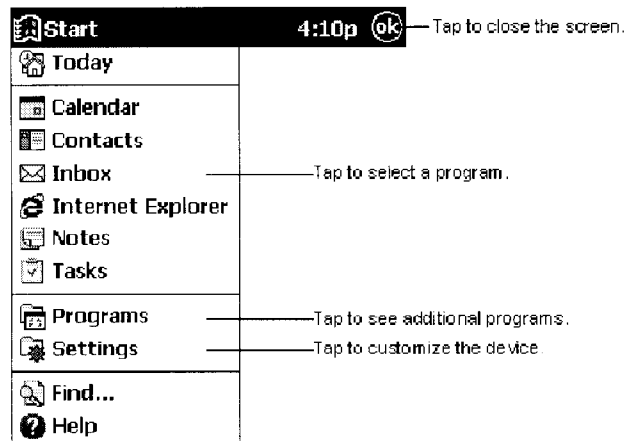

Q u i c k R e f e r e n c e

Input Methods

Enter information in any program by typing with the soft keyboard or writing using Character Recognizer.

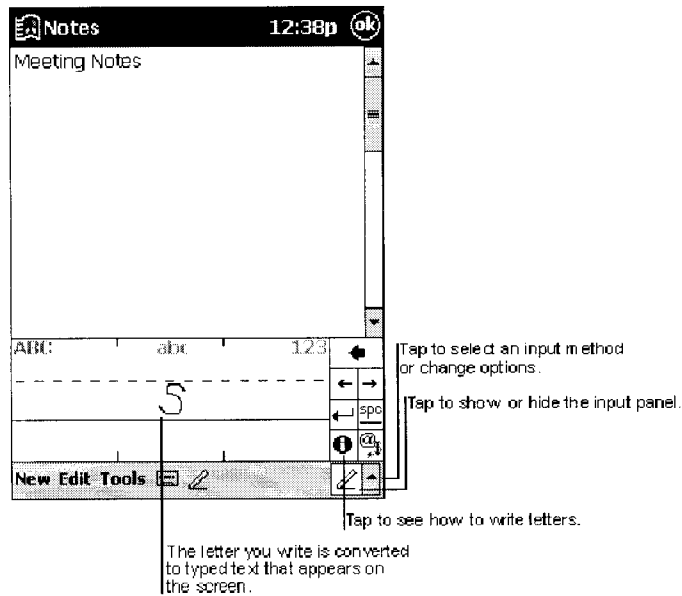

The Character Recognizer input panel is divided into three writing areas. Letters written in the left area (labeled ABC) create uppercase letters and letters written in the middle area (labeled abc) create lowercase letters. The right area (labeled 123) is for writing numbers, symbols, special characters, and punctuation.

The following chart is a partial display of the characters you can write while in lowercase mode (the dot on each character is the starting point for writing). For more information on using Character

P P T 2 8 0 0 S e r i e s

Recognizer and for demos of all characters, tap on the Character Recognizer input panel.

Letter Area				Number/Punctuation Area											
A	a	a		N	n			0	0))			
B	b	b		O	o	o		1	1		+ +	+ +			
C	C			P	p	p		2	2	2	* X	* X			
D	d	d		Q	q	q		3	3		/	/			
E	e			R	r	r		4	L	4	4	L	\		
F	f	f		S	s			5	5	5	? ? ?	? ? ?			
G	g	g		T	t	7	7	f	6	6	!	!			
H	h	h		U	u	u		7	7		@	@			
I	i	i		V	v			8	8		&	&			
J	J	J		W	w	w		9	9		.	.			
K	k	k	K	K	K	K		X	X	X	“	“			
L	L	L	2					Y	Y	Y	-	-			
M	m			Z	z			Z	z						

space	—	enter	—
back space	—	back space	—

Q u i c k R e f e r e n c e

Scanning with the PPT 2800

The PPT 2800 has an integrated scanner which collects data by scanning bar codes. See the *PPT 2800 Product Reference Guide* for information on configuring your terminal for scanning.

To scan bar codes with the PPT 2800:

1. Aim the scanner at the bar code.
2. Press either the right, left, or center scan trigger. Make sure the red scan beam covers the entire bar code. The green scan LED lights and a beep sounds to indicate a successful decode.

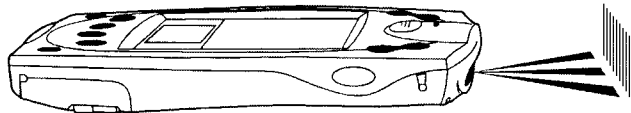

Resetting Your PPT 2800 Terminal

If your PPT 2800 terminal stops responding to input, reset it.

Performing a Soft Reset

A soft reset restarts the terminal and saves all stored records and entries.

Caution: Files that remain open during a soft reset may not be retained.

Caution: DO NOT perform a soft reset if the terminal is suspended. Press the Power button to wake the terminal.

To perform a soft reset, hold down both the up and down scroll buttons, then press the App 4 button.

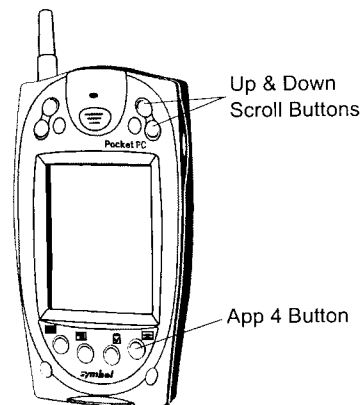

Q u i c k R e f e r e n c e

Performing a Hard Reset

A hard reset also restarts your PPT 2800 terminal, but erases all stored records and entries. *Therefore, never perform a hard reset unless a soft reset does not solve your problem.*

Note: You can restore any data previously synchronized with your computer during the next ActiveSync operation. See the *PPT 2800 Cradle Quick Reference Guide* or the *PPT 2800 Product Reference Guide*.

To perform a hard reset:

1. Remove the battery cover.
2. While holding down the Function button, use the stylus (or similar object *without* a sharp tip) to gently press the reset button.

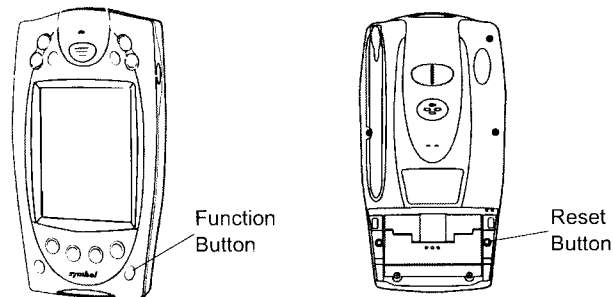

3. Replace the battery cover and press the Power button.
4. As the terminal initializes its unique Flash File system, the Symbol splash screen displays for about a minute.
5. See *Aligning the Screen* on page 8 to perform an initial setup of the terminal.

Note: With a hard reset, Formats, Preferences, and other settings are restored to their factory default settings.

Maintaining the PPT 2800

For trouble-free service, observe the following tips when using your PPT 2800:

- Do not scratch the screen. Use the supplied stylus or plastic-tipped pens intended for use with a touch-sensitive screen. Never use a pen or pencil or other sharp object on the screen.
- Although your PPT 2800 is water and dust resistant, do not expose it to rain or moisture for an extended period of time. Treat your PPT 2800 as you would a pocket calculator or other small electronic instrument.
- The touch-sensitive screen of your PPT 2800 contains glass. Do not drop your PPT 2800 or subject it to strong impact.
- Protect your PPT 2800 from temperature extremes. Do not leave it on the dashboard of a car on a hot day, and keep it away from heat sources.
- Do not store or use your PPT 2800 in any location that is extremely dusty, damp or wet.
- If the surface of the PPT 2800 screen becomes soiled, clean it with a soft cloth moistened with a diluted window-cleaning solution.

Troubleshooting

PPT 2800 terminal does not turn on:

- Adjust the contrast control.
- Make sure batteries are installed properly.
- Replace the batteries. If your PPT 2800 terminal still does not operate, try a soft reset, then a hard reset; see *Resetting Your PPT 2800 Terminal* on page 16.

No sound:

- Check the System Volume slider in the **Sounds & Reminders** properties dialog box (under **Start/Settings**) to make

Q u i c k R e f e r e n c e

sure the volume is not turned down.

PPT 2800 terminal turns itself off:

- Your PPT 2800 terminal turns off after a period of inactivity. This period can be set from one to five minutes, in one-minute intervals. Check the **Power** dialog box (in the **System** tab under **Start/Settings**), and change the setting if you need a longer delay before the automatic shutoff feature activates.

PPT 2800 terminal doesn't recognize my handwriting:

- For your PPT 2800 to recognize handwriting input with the stylus, characters must be written a certain way. See the *PPT 2800 Product Reference Guide* for information about how to write character strokes.
- Make the character strokes in the lower character entry area on the screen — not on the display part of the screen.
- Make sure you are writing upper-case letters in the left-hand side, numbers in the right-hand side, and lower-case letters in the center of the writing area.

Tapping the screen buttons or icons does not activate the corresponding feature:

- Align the screen. Choose **Align Screen** from the **System** tab under **Start/Settings**, or hold down the Function button and press the Action button.

A message appears stating that your PPT 2800 terminal memory is full:

- Delete unused memos and records. You can save these records on your computer.
- Adjust the memory allocation. Select **Start**, then **Settings**, and select the **System** tab. Tap **Memory** and adjust the slider.

P P T 2 8 0 0 S e r i e s

- If you have installed additional applications on your PPT 2800 terminal, remove them to recover memory. Select **Start**, then **Settings**, and select the **System** tab. Tap **Remove Programs**, select the unused program and tap **Remove**.

Beamed data does not transmit:

- Confirm that the PPT 2800 terminals are 5" apart, and there is a clear path between the two devices.
- Adjust the room lighting or move to a different location.

When receiving beamed data an out of memory message appears:

- Your PPT 2800 terminal requires at least twice the amount of memory available as the data you are receiving. For example, if you are receiving a 30K application, you must have at least 60K free.

Your PPT 2800 unit does not accept scan input:

- Verify that the unit is loaded with a scanning application. See your System Administrator.
- Be sure the symbol is not defaced.
- Be sure you are within proper scanning range.
- Be sure the terminal is programmed to accept the type of bar code you are scanning.
- If you are expecting a beep on a good decode and don't hear one, check that the application is set to generate a beep on good decode.
- If the scanner stops emitting a laser beam when you press the trigger, check your battery level. When the battery is low, the scanner shuts off before the terminal notifies you of the low battery condition.

Note: If the scanner is still not reading symbols, contact your distributor or Symbol Technologies.

Q u i c k R e f e r e n c e

END-USER LICENSE AGREEMENT

MICROSOFT WINDOWS FOR POCKET PC

DATA EXCHANGE COMPONENT: MICROSOFT ACTIVESYNC, VERSION 3.1

IMPORTANT-READ CAREFULLY: This End-User License Agreement ("EULA") is a legal agreement between you (either an individual or a single entity) and the manufacturer ("Manufacturer") of the special purpose computing device ("SYSTEM") with which you acquired the Microsoft software product(s) identified above ("SOFTWARE"). The SOFTWARE includes computer software, the associated media, any printed materials, and any "online" or electronic documentation. Any software provided along with the SOFTWARE that is associated with a separate end-user license agreement is licensed to you under the terms of that license agreement. By installing, copying, downloading, accessing, or otherwise using the SOFTWARE, you agree to be bound by the terms of this EULA. If you do not agree to the terms of this EULA, Manufacturer and Microsoft Licensing, Inc. ("MS") are unwilling to license the SOFTWARE to you. In such event, you may not use or copy the SOFTWARE, and you should promptly contact Manufacturer for instructions on return of the unused product(s) in accordance with Manufacturer's return policies.

SOFTWARE LICENSE

The SOFTWARE is protected by copyright laws and international copyright treaties, as well as other intellectual property laws and treaties. The SOFTWARE is licensed, not sold.

1. **GRANT OF LICENSE.** SOFTWARE includes software already installed on the SYSTEM ("SYSTEM Software") and, if included in the SYSTEM package, software contained on the CD-ROM disc labeled "Desktop Software for Microsoft Windows CE Microsoft ActiveSync 3.1" ("Desktop Software"). This EULA grants you the following rights to the SOFTWARE:
 - **SYSTEM Software.** You may use the SYSTEM Software as installed on the SYSTEM.
 - **Desktop Software.** If Desktop Software is included with your SYSTEM, you may install and use the Data Exchange component identified above on one (1) or more computers to exchange information with one (1) or more computing devices that contain a compatible version of the Microsoft Windows CE operating system. For other software component(s) contained in the Desktop Software, you may install and use such components only in accordance with the terms of the printed or online end-user license agreement(s) provided with such component(s). In the absence of an end user license agreement for particular component(s) of the Desktop Software, you may install and use only one (1) copy of such component(s) on the SYSTEM or a single computer with which you use the SYSTEM.
 - **Backup Copy.** If Manufacturer has not included a backup copy of the SYSTEM Software with the SYSTEM, you may make a single backup copy of the SYSTEM Software. You may use the backup copy solely for archival purposes.
 - **Microsoft Outlook 2000.** The following terms apply to your use of Microsoft Outlook 2000 (i) regardless of the information contained in the "Software Installation and Use" section of the online EULA you may install one (1) copy of

P P T 2 8 0 0 S e r i e s

Microsoft Outlook 2000 on one (1) computer to use, exchange data, share data, access, and interact with the SYSTEM, and (ii) the EULA is between Manufacturer (as defined above) and the end user-not between the PC Manufacturer and end user.

2. DESCRIPTION OF OTHER RIGHTS AND LIMITATIONS.

- **Speech/Handwriting Recognition.** If the SOFTWARE includes speech and/or handwriting recognition component(s), you should understand that speech and handwriting recognition are inherently statistical processes; that recognition errors are inherent in the processes; that it is your responsibility to provide for handling such errors and to monitor the recognition processes and correct any errors. Neither Manufacturer nor its suppliers shall be liable for any damages arising out of errors in the speech and handwriting recognition processes.
- **Limitations on Reverse Engineering, Decompilation, and Disassembly.** You may not reverse engineer, decompile, or disassemble the SOFTWARE, except and only to the extent that such activity is expressly permitted by applicable law notwithstanding this limitation.
- **Single SYSTEM.** The SYSTEM Software is licensed with the SYSTEM as a single integrated product. The SYSTEM Software installed in read-only memory ("ROM") of the SYSTEM may only be used as part of the SYSTEM.
- **Single EULA.** The package for the SYSTEM may contain multiple versions of this EULA, such as multiple translations and/or multiple media versions (e.g., in the user documentation and in the software). Even if you receive multiple versions of the EULA, you are licensed to use only one (1) copy of the SYSTEM Software.
- **Rental.** You may not rent or lease the SOFTWARE.
- **Software Transfer.** You may permanently transfer all of your rights under this EULA only as part of a sale or transfer of the SYSTEM, provided you retain no copies, you transfer all of the SOFTWARE (including all component parts, the media and printed materials, any upgrades or backup copies, this EULA and, if applicable, the Certificate(s) of Authenticity), and the recipient agrees to the terms of this EULA. If the SOFTWARE is an upgrade, any transfer must include all prior versions of the SOFTWARE.
- **Termination.** Without prejudice to any other rights, Manufacturer or MS may terminate this EULA if you fail to comply with the terms and conditions of this EULA. In such event, you must destroy all copies of the SOFTWARE and all of its component parts.

3. UPGRADES AND RECOVERY MEDIA.

- **SYSTEM Software.** If the SYSTEM Software is provided by Manufacturer separate from the SYSTEM on media such as a ROM chip, CD-ROM disc(s) or via Web download or other, means, and is labeled "For Upgrade Purposes Only" or "For Recovery Purposes Only," you may install one copy of such SYSTEM Soft-

Q u i c k R e f e r e n c e

ware onto the SYSTEM as a replacement copy for the existing SYSTEM Software and use it in accordance with Section 1 of this EULA.

- **Desktop Software.** If any Desktop Software component(s) is provided by Manufacturer separate from the SYSTEM on CD-ROM disc(s) or via Web download or other means, and labeled "For Upgrade Purposes Only" or "For Recovery Purposes Only", you may (i) install and use one copy of such component(s) on the computer(s) you use to exchange data with the SYSTEM as a replacement copy for the existing Desktop Software component(s).
- 4. **COPYRIGHT.** All title and intellectual property rights in and to the SOFTWARE (including, but not limited to, any images, photographs, animations, video, audio, music, text, and "applets" incorporated into the SOFTWARE), the accompanying printed materials, and any copies of the SOFTWARE, are owned by MS or its suppliers (including Microsoft Corporation). You may not copy the printed materials accompanying the SOFTWARE. All title and intellectual property rights in and to the content which may be accessed through use of the SOFTWARE is the property of the respective content owner and may be protected by applicable copyright or other intellectual property laws and treaties. This EULA grants you no rights to use such content. All rights not specifically granted under this EULA are reserved by MS and its suppliers (including, Microsoft Corporation).
- 5. **EXPORT RESTRICTIONS.** You agree that you will not export or re-export the SOFTWARE to any country, person, or entity subject to U.S. export restrictions. You specifically agree not to export or re export the SOFTWARE: (i) to any country to which the U.S. has embargoed or restricted the export of goods or services, which as of May 1999 include, but are not necessarily limited to, Cuba, Iran, Iraq, Libya, North Korea, Sudan, Syria, and the Federal Republic of Yugoslavia (including Serbia, but not Montenegro), or to any national of any such country, wherever located, who intends to transmit or transport the products back to such country; (ii) to any person or entity who you know or have reason to know will utilize the SOFTWARE or portion thereof in the design, development, or production of nuclear, chemical, or biological weapons; or (iii) to any person or entity who has been prohibited from participating in U.S. export transactions by any federal agency of the U.S. government.
- 6. **NOTE ON JAVA SUPPORT.** The SOFTWARE may contain support for programs written in Java. Java technology is not fault tolerant and is not designed, manufactured, or intended for use or resale as online control equipment in hazardous environments requiring fail-safe performance, such as in the operation of nuclear facilities, aircraft navigation or communication systems, air traffic control, direct life support machines, or weapons systems, in which the failure of Java technology could lead directly to death, personal injury, or severe physical or environmental damage. Sun Microsystems, Inc. has contractually obligated Microsoft Corporation to make this disclaimer.
- 7. **PRODUCT SUPPORT.** Product support for the SOFTWARE is not provided by MS, its parent corporation, Microsoft Corporation, or their affiliates or subsidiaries. For product support, please refer to Manufacturer's support number provided in the documentation for the SYSTEM. Should you have any questions concerning this EULA, or if you desire to contact Manufacturer for any other reason, please

P P T 2 8 0 0 S e r i e s

refer to the address provided in the documentation for the SYSTEM.

FOR THE LIMITED WARRANTIES AND SPECIAL PROVISIONS PERTAINING TO YOUR PARTICULAR JURISDICTION, PLEASE REFER TO YOUR WARRANTY BOOKLET INCLUDED WITH THIS PACKAGE OR PROVIDED WITH THE SOFTWARE PRINTED MATERIALS.

Regulatory Information

Radio Frequency Interference Requirements

This device has been tested and found to comply with the limits for a Class B digital device pursuant to Part 15 of the Federal Communications Commissions Rules and Regulation. These limits are designed to provide reasonable protection against harmful interference when the equipment is operated in a commercial environment. This equipment generates, uses, and can radiate radio frequency energy and, if not installed and used in accordance with the instruction manual, may cause harmful interference to radio communications. Operation of this equipment in a residential area is likely to cause harmful interference in which case the user will be required to correct the interference at his own expense.

However, there is no guarantee that interference will not occur in a particular installation. If the equipment does cause harmful interference to radio or television reception, which can be determined by turning the equipment off and on, the user is encouraged to try to correct the interference by one or more of the following measures:

- Re-orient or relocate the receiving antenna.
- Increase the separation between the equipment and receiver.
- Connect the equipment into an outlet on a circuit different from that which the receiver is connected.
- Consult the dealer or an experienced radio/TV technician for help.

This device complies with FCC Part 15. Operation is subject to the following two conditions: (1) this device may not cause harmful interference and (2) this device must accept any interference received, including interference that may cause undesired operation.

Radio Frequency Interference Requirements - Canada

This device complies with RSS 210 of Industry & Science Canada. Operation is subject to the following two conditions: (1) this device may not cause harmful interference and (2) this device must accept any interference received, including interference that may cause undesired operation.

This Class B digital apparatus complies with Industry Canada Standard ICES-003. Cet appareil numérique de la classe B est conforme à la norme NMB-003 d'Industrie Canada.

Q u i c k R e f e r e n c e

CE Marking and European Union Compliance



Products intended for sale within the European Union are marked with the CE Mark which indicates compliance to applicable Directives and European Norms (EN), as follows. Amendments to these Directives and ENs are included:

Applicable Directives

- Electromagnetic Compatibility Directive 89/336/EEC
- Low Voltage Directive 73/23/EEC

Applicable Standards

- EN 55 022 - Limits and Methods of Measurement of Radio Interference Characteristics of Information technology Equipment
- EN55024:1998: Information technology equipment- Immunity characteristics- Limits and methods of measurement.
- ETS 300-826:1997: Electromagnetic compatibility and radio spectrum matters (ERM);Electromagnetic compatibility (EMC) standard for 2.4Ghz wideband transmission systems and high performance radio local area network (Hiperlan) equipment.
- IEC 1000-4-2:1995/EN 61000-4-2:1995;Electromagnetic Compatibility (EMC) Part 4:Testing and Measurement techniques;Section 4.2:Electrostatic discharge immunity test.
- IEC 1000-4-3:1995/EN61000-4-3:1997, Electromagnetic Compatibility (EMC); Part 4 Testing and measurement techniques;Section 3.Radiated,radio frequency,electromagnetic field immunity test.
- IEC 1000-4-4:1995/EN61000-4-4:1995;Electromagnetic compatibility (EMC) Part 4;Testing and Measurement techniques;Section 4:Testing electrical fast transient,/Burst Immunity.
- IEC 1000-4-5:1995/EN61000-4-5:1995,Electromagnetic compatibility (EMC), Part 4:Testing and Measurement techniques;Section 5:Surge Immunity
- IEC 1000-4-6:1996/EN61000-4-6:1996;Electromagnetic compatibility (EMC), Part 4:Testing and Measurement techniques;Section 6: Immunity to conducted disturbances, induced by radio frequency fields.
- IEC 1000-4-11:1994/EN61000-4-11:1994: Electromagnetic compatibility (EMC), Part 4:Testing and Measurement techniques;Section 11:Voltage Dips, Short Interruptions, and Voltage Variations.
- EN 60 950 + Amd 1 + Amd 2 - Safety of Information Technology Equipment Including Electrical Business Equipment
- EN 60 825-1 (EN 60 825) - Safety of Devices Containing Lasers.

RF Devices

Symbol's RF products are designed to be compliant with the rules and regulations in the locations into which they are sold and will be labeled as required. The majority of Symbol's RF devices are type approved and do not require the user to obtain license or authorization before using the equipment. Any changes or modifications to Symbol

Q u i c k R e f e r e n c e

Laser Devices

Symbol products using lasers comply with US 21CFR1040.10, and IEC825-1:1993, EN60825-1:1994+A11:1996. The laser classification is marked on one of the labels on the product.

Class 1 Laser devices are not considered to be hazardous when used for their intended purpose. The following statement is required to comply with US and international regulations:

Caution: Use of controls, adjustments or performance of procedures other than those specified herein may result in hazardous laser light exposure.

Class 2 laser scanners use a low power, visible light diode. As with any very bright light source, such as the sun, the user should avoid staring directly into the light beam. Momentary exposure to a Class 2 laser is not known to be harmful.

Scanner Labeling

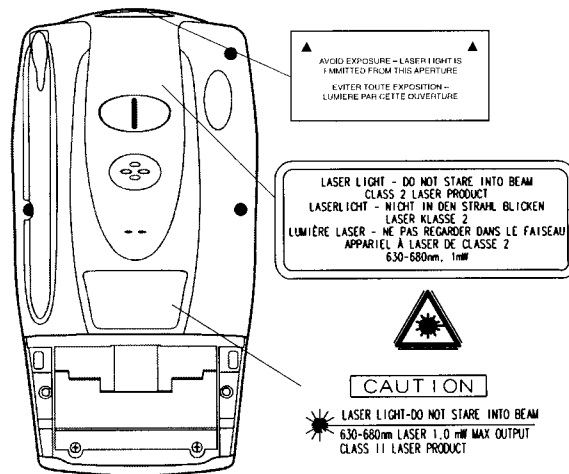

P P T 2 8 0 0 S e r i e s

In accordance with Clause 5, IEC 0825 and EN60825, the following information is provided to the user:

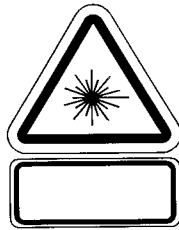

ENGLISH	HEBREW		
CLASS 1	CLASS 1 LASER PRODUCT		רמה 1 מוצר לייזר רמה 1
CLASS 2	LASER LIGHT DO NOT STARE INTO BEAM CLASS 2 LASER PRODUCT		רמה 2 אור לייזר אין להביט אל תוך הזרם מוצר לייזר רמה 2
DANISH	ITALIAN		
KLASSE 1	KLASSE 1 LASERPRODUKT	CLASS 1	PRODOTTO AL LASER DI CLASSE 1
KLASSE 2	LASERLYF SE IKKE IND I STRÅLEN KLASSE 2 LASERPRODUKT	CLASS 2	LUCE LASER NON FISSARE IL RAGGIO/PRODOTTO
AL LASER DI CLASSE 2			
DUTCH	NORWEGIAN		
KLASSE 1	KLASSE-1 LASERPRODUKT	KLASSE 1	LASERPRODUKT, KLASSE 1
KLASSE 2	LASERLICHT NIET IN STRAAL STAREN KLASSE-2 LASERPRODUKT	KLASSE 2	LASERLYS IKKE STIRR INN I LYSSTRÅLEN LASERPRODUKT, KLASSE 2
FINNISH	PORTUGUESE		
LUOKKA 1	LUOKKA 1 LASERTUOTE	CLASSE 1	PRODUTO LASER DA CLASSE 1
LUOKKA 2	LASERVÄLÖ ÄLÄ TUJOTA SADETTÄ LUOKKA 2 LASERTUOTE	CLASSE 2	LUZ DE LASER NÃO FIXAR O RAI0 LUMINOSO PRODUTO LASER DA CLASSE 2
FRENCH	SPANISH		
CLASSE 1	PRODUIT LASER DE CLASSE 1	CLASSE 1	PRODUCTO LASER DE LA CLASE 1
CLASSE 2	LUMIERE LASER NE PAS REGARDER LE RAYON FIXEMENT PRODUIT LASER DE CLASSE 2	CLASSE 2	LUZ LASER NO MIRE FIJAMENTE EL HAZ PRODUCTO LASER DE LA CLASE 2
GERMAN	SWEDISH		
KLASSE 1	LASERPRODUKT DER KLASSE 1	KLASS 1	LASERPRODUKT KLASS 1
KLASSE 2	LASERSTRAHLEN NICHT DIREKT IN DEN LASERSTRAHL SCHAUEN LASERPRODUKT DER KLASSE 2	KLASS 2	LASERLJUS STIRRA INTE MOT STRÅLEN LASERPRODUKT KLASS 2

Q u i c k R e f e r e n c e

Battery Caution

Caution: Danger of explosion if battery is incorrectly replaced. Replace only with the same or equivalent type recommended by the manufacturer. Dispose of used batteries according to the manufacturer's instructions.

P P T 2 8 0 0 S e r i e s

DECLARATION OF CONFORMITY

We, Symbol Technologies, Inc.

of One Symbol Plaza, Holtsville, NY 11742-1300, USA

declare under our sole responsibility that the product

Spectrum24, LA3021, Type II Radio Card

Spectrum24, LA302C, Type II Radio Card

Spectrum24, LA302T, Type II Radio Card

to which this declaration relates, is in conformity with the following standards and/or other normative documents.

ETS 300 328 (November 1996)

ETS 300 826 (November 1997)

EN 60950: 1992 Incl Amdt 1-4, 11

We hereby declare that all essential radio test suites have been carried out and that the above named products is in conformity to all the essential requirements of Directive 1999/5/EC.

The conformity assessment procedure referred to in Article 10(5) and detailed in Annex IV of Directive 1999/5/EC has been followed with the involvement of the following Notified Body(ies):
BABT, Claremont House, 34 Molesey Road, Walton-on-Thames, KT12 4RQ

identification mark: 0168

The equipment will also carry the
Class 2 equipment identifier



The technical documentation relevant to the above equipment can be made available for inspection on application to:

Symbol Technologies EMEA, Symbol Place, Winnersh Triangle, Berkshire, RG 41 5TP, UK

Dornu Narnor

(name)

Director, Regulatory and Technical Sales

(title)

3, May 2000

(signature of authorised person)

(date)

Q u i c k R e f e r e n c e

DECLARATION OF CONFORMITY

We, Symbol Technologies, Inc.
of One Symbol Plaza, Holtsville, NY 11742-1300, USA

declare under our sole responsibility that the product

Spectrum24HR, LA4111, Type II Radio Card
Spectrum24HR, LA411T, Type II Radio Card

to which this declaration relates, is in conformity with the following standards and/or other normative documents.

ETS 300 328 (November 1996)
ETS 300 826 (November 1997)
EN 60950: 1992 Incl Amdt 1-4, 11

We hereby declare that all essential radio test suites have been carried out and that the above named products is in conformity to all the essential requirements of Directive 1999/5/EC.

The conformity assessment procedure referred to in Article 10(5) and detailed in Annex IV of Directive 1999/5/EC has been followed with the involvement of the following Notified Body(ies):
BABT, Claremont House, 34 Molesey Road, Walton-on-Thames, KT12 4RQ

Identification mark: 0168 The equipment will also carry the
Class 2 equipment identifier



The technical documentation relevant to the above equipment can be made available for inspection on application to:

Symbol Technologies EMEA, Symbol Place, Winnersh Triangle, Berkshire, RG 41 5TP, UK

Dornu Narnor
(name)

Director, Regulatory and Technical Sales
(title)

(signature of authorised person)

3, May 2000
(date)

P P T 2 8 0 0 S e r i e s

Q u i c k R e f e r e n c e

Warranty

Symbol Technologies, Inc. ("Symbol") manufactures its hardware products in accordance with industry-standard practices. Symbol warrants that for a period of twelve (12) months from date of shipment, products will be free from defects in materials and workmanship.

This warranty is provided to the original owner only and is not transferable to any third party. It shall not apply to any product (i) which has been repaired or altered unless done or approved by Symbol, (ii) which has not been maintained in accordance with any operating or handling instructions supplied by Symbol, (iii) which has been subjected to unusual physical or electrical stress, misuse, abuse, power shortage, negligence or accident or (iv) which has been used other than in accordance with the product operating and handling instructions. Preventive maintenance is the responsibility of customer and is not covered under this warranty.

Wear items and accessories having a Symbol serial number, will carry a 90-day limited warranty. Non-serialized items will carry a 30-day limited warranty.

Warranty Coverage and Procedure

During the warranty period, Symbol will repair or replace defective products returned to Symbol's manufacturing plant in the US. For warranty service in North America, call the Symbol Support Center at 1-800-653-5350. International customers should contact the local Symbol office or support center. If warranty service is required, Symbol will issue a Return Material Authorization Number. Products must be shipped in the original or comparable packaging, shipping and insurance charges prepaid. Symbol will ship the repaired or replacement product freight and insurance prepaid in North America. Shipments from the US or other locations will be made F.O.B. Symbol's manufacturing plant.

Symbol will use new or refurbished parts at its discretion and will own all parts removed from repaired products. Customer will pay for the replacement product in case it does not return the replaced product to Symbol within 3 days of receipt of the replacement product. The process for return and customer's charges will be in accordance with Symbol's Exchange Policy in effect at the time of the exchange.

Customer accepts full responsibility for its software and data including the appropriate backup thereof.

Repair or replacement of a product during warranty will not extend the original warranty term.

Symbol's Customer Service organization offers an array of service plans, such as on-site, depot, or phone support, that can be implemented to meet customer's special operational requirements and are available at a substantial discount during warranty period.

General

Except for the warranties stated above, Symbol disclaims all warranties, express or implied, on products furnished hereunder, including without limitation implied warranties of merchantability and fitness for a particular purpose. The stated express warranties are in lieu of all obligations or liabilities on part of Symbol for damages, including without limitation, special, indirect, or consequential damages arising out of or in connection with the use or performance of the product. Seller's liability for damages to buyer or others resulting from the use of any product, shall in no way exceed the purchase price of said product, except in instances of injury to persons or property. Some states (or jurisdictions) do not allow the exclusion or limitation of incidental or consequential damages, so the preceding exclusion or limitation may not apply to you.

Service Information

Before you use the unit, it must be configured to operate in your facility's network and run your applications.

If you have a problem running your unit or using your equipment, contact your facility's Technical or Systems Support. If there is a problem with the equipment, they will contact the Symbol Support Center:

United States	1-800-653-5350	Canada	905-629-7226
United Kingdom	0800 328 2424	Asia/Pacific	337-6588
Australia	1-800-672-906	Austria	1-505-5794
Denmark	7020-1718	Finland	9 5407 580
France	01-40-96-52-21	Germany	6074-49020
Italy	2-484441	Mexico	5-520-1835
Netherlands	315-271700	Norway	66810600
South Africa	11-4405668	Spain	9-1-320-39-09
Sweden	84452900		
Latin America Sales Support		1-800-347-0178 Inside US	
		+1-561-483-1275 Outside US	
Europe/Mid-East Distributor Operations		Contact local distributor or call	
		+44 208 945 7360	



72-52773-01
Revision A — May 2001

Symbol Technologies, Inc. One Symbol Plaza Holtsville, NY 11742-1300