

MC55 Quick Start Guide

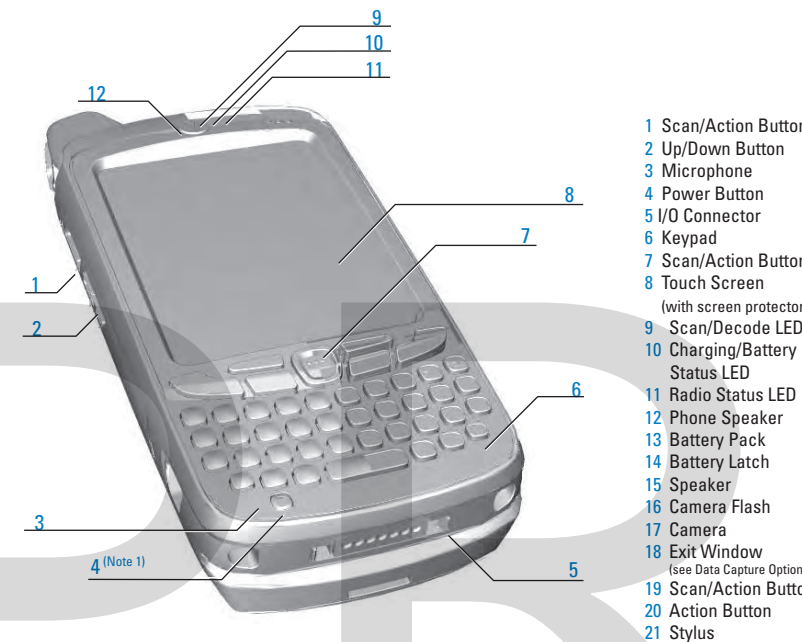

FEATURES



- 1 Scan/Action Button
- 2 Up/Down Button
- 3 Microphone
- 4 Power Button
- 5 I/O Connector
- 6 Keypad
- 7 Scan/Action Button
- 8 Touch Screen (with screen protector)
- 9 Scan/Decode LED
- 10 Charging/Battery Status LED
- 11 Radio Status LED
- 12 Phone Speaker

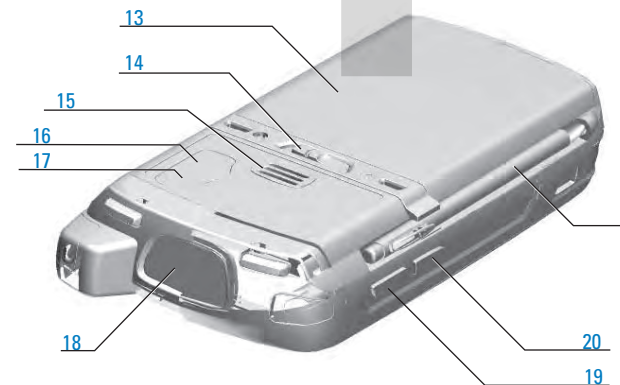

- 13 Battery Pack
- 14 Battery Latch
- 15 Speaker
- 16 Camera Flash
- 17 Camera
- 18 Exit Window (See Data Capture Options)
- 19 Scan/Action Button
- 20 Action Button
- 21 Stylus

Note 1: To reset the MC55, press and hold the Power button for five (5) seconds.



Numeric Keypad

- 1 Talk
- 2 Navigation
- 3 Soft Key
- 4 Scan/Action Button
- 5 End
- 6 Orange Key
- 7 Backlight
- 8 Blue Key
- 9 OK
- 10 Start Menu



Alpha-Numeric Keypad

Blue Key
Use this key to launch applications and select items (shown on the keypad in blue).
> Press the key once to activate this mode followed by another key.

Orange Key
Use this key to access the secondary layer of characters and actions.
> Press the key once to lock the keypad in the Alpha state.
> Press the key a second time to return to the normal state.

Notifications

Charging LED:

- Flashing orange: Battery charging
- Solid orange: Charging complete

GSM Status/Notification LED:

- Fast flashing green: GSM activity
- Solid green: Voice call in progress
- Flashing red: System notification



PIM Keypad

GETTING STARTED - BATTERY INSTALLATION

Insert the Battery

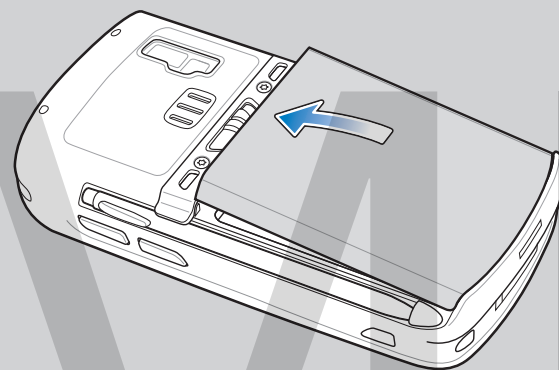

Remove the Battery

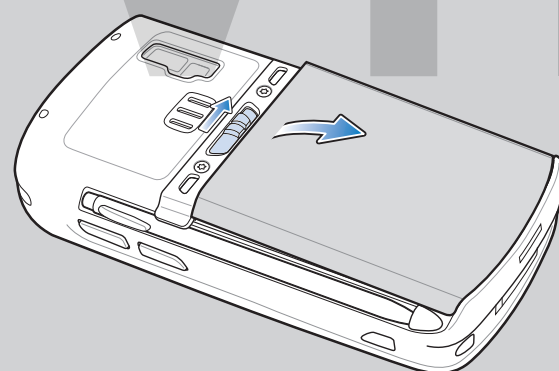

CHARGING

Charge the MC55 24hr*

1-Slot Cradle



4-Slot Battery Charger

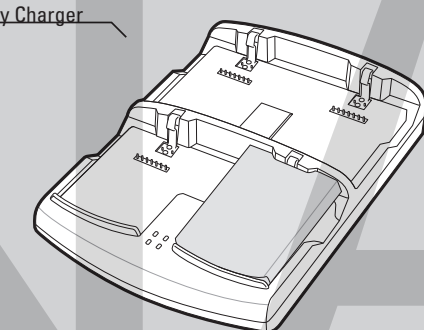

4-Slot Cradle

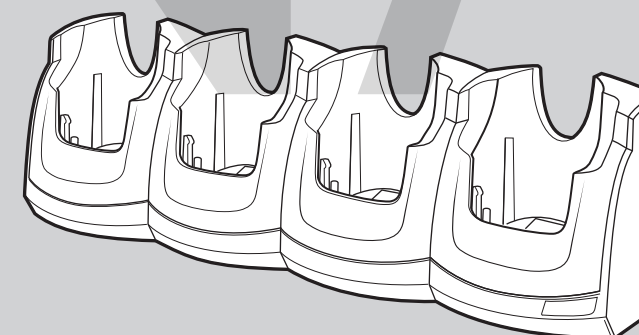

- Charging/Battery Status LED
- Slow Blinking Amber = Charging
- Solid Amber = Fully Charged
- Fast Blinking Amber = Charging Error

* It is recommended that this product be charged for 24 hours before the first use to ensure that the internal battery is fully charged.

PHONE SETUP

SIM Card Installation

1. Remove battery pack.
2. Slide SIM card holder to the left.
3. Lift card holder.
4. Insert SIM card into SIM holder.

NOTE:

The proper position of the SIM card—the card connector (i.e., gold area) should be facing outward with the bevelled corner facing away.

5. Lower the SIM card holder down.
6. Slide SIM card holder to the right to lock into place.
7. Reinstall battery pack.

Enter Your PIN

After installing the SIM card activate your mobile service connection. In most cases, SIM cards are preset with a PIN (Personal Identity Number), provided by your service provider.

1. Press the Power button to turn on the MC55.
2. Tap Start > Phone.
3. Enter the PIN from your service provider.
4. Tap Enter.

Turn On the Phone Function

1. Launch the Wireless Manager application.

- On the Today screen, tap the Wireless Manager icon.
- or
- On the Today screen, tap the signal icon and select Wireless Manager.

2. On the Wireless Manager screen, tap Phone to turn on the phone function. The signal icon changes indicating the MC55 is searching for a mobile connection. This may take a few seconds. The signal icon changes to and to once a mobile connection is established.

Turn Off the Phone Function

1. Launch the Wireless Manager application.

- On the Today screen, tap the Wireless Manager icon.
- or
- On the Today screen, tap the signal icon and select Wireless Manager.

2. On the Wireless Manager screen, tap Phone to turn off phone function.

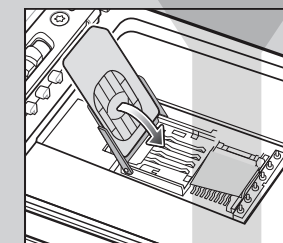
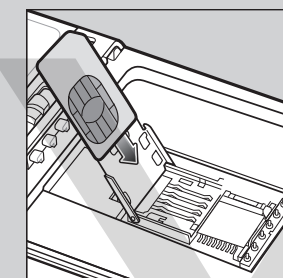
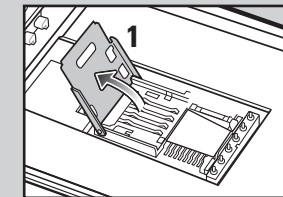

Install ActiveSync®

Download ActiveSync® 4.5 or higher from <http://www.microsoft.com> and follow the instructions to install ActiveSync onto the host computer.

Communicate with Host

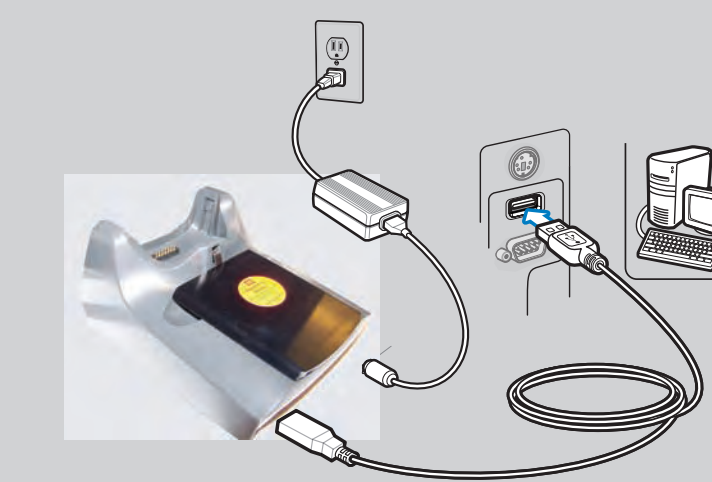

Create a Partnership

Follow the on-screen ActiveSync instructions to establish a connection between the MC55 and the host computer.

COMMUNICATION