

MC55 Quick Start Guide

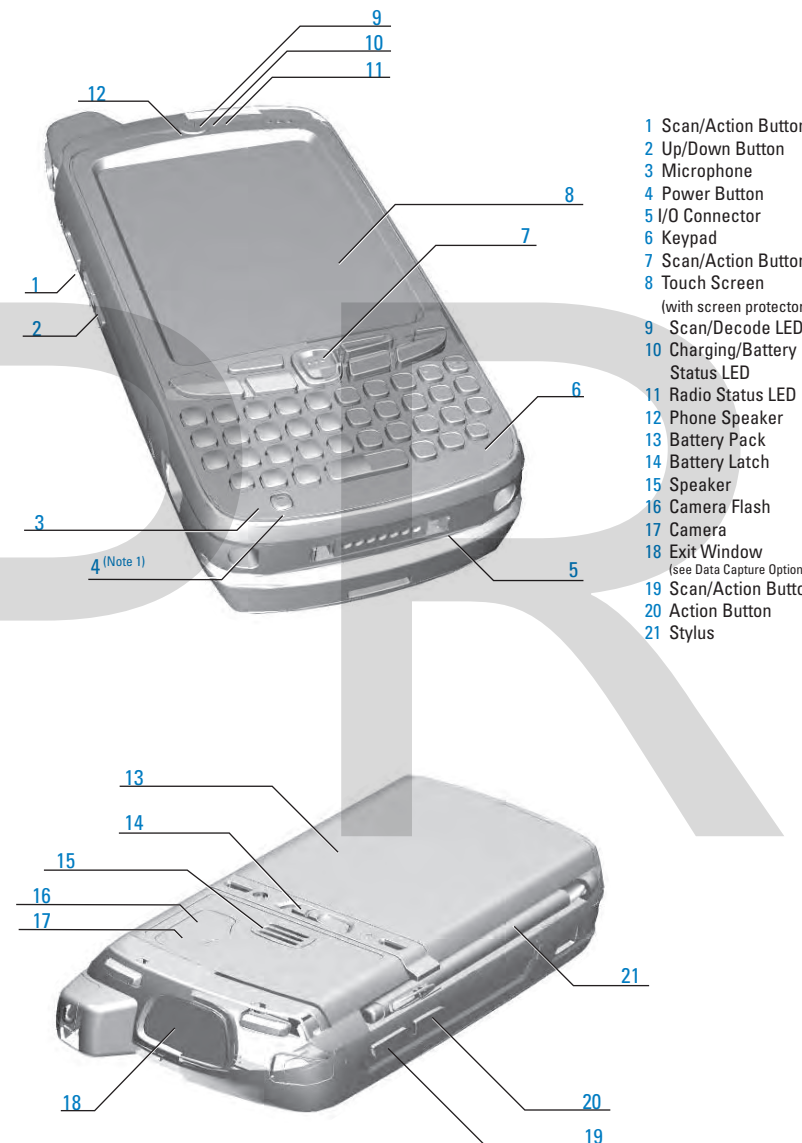

FEATURES



- 1 Scan/Action Button
- 2 Up/Down Button
- 3 Microphone
- 4 Power Button
- 5 I/O Connector
- 6 Keypad
- 7 Scan/Action Button
- 8 Touch Screen (with screen protector)
- 9 Scan/Decode LED
- 10 Charging/Battery Status LED
- 11 Radio Status LED
- 12 Phone Speaker
- 13 Battery Pack
- 14 Battery Latch
- 15 Speaker
- 16 Camera Flash
- 17 Camera
- 18 Exit Window (See Data Capture Options)
- 19 Scan/Action Button
- 20 Action Button
- 21 Stylus

Note 1: To reset the MC55, press and hold the Power button for five (5) seconds.



Numeric Keypad

- 1 Talk
- 2 Navigation
- 3 Soft Key
- 4 Scan/Action Button
- 5 End
- 6 Orange Key
- 7 Backlight
- 8 Blue Key
- 9 OK
- 10 Start Menu



Alpha-Numeric Keypad

Blue Key
Use this key to launch applications and select items (shown on the keypad in blue).
> Press the key once to activate this mode followed by another key.

Orange Key
Use this key to access the secondary layer of characters and actions.
> Press the key once to lock the keypad in the Alpha state.
> Press the key a second time to return to the normal state.

Notifications

Charging LED:

- Flashing orange: Battery charging
- Solid orange: Charging complete

GSM Status/Notification LED:

- Fast flashing green: GSM activity
- Solid green: Voice call in progress
- Flashing red: System notification



PIM Keypad

GETTING STARTED - BATTERY INSTALLATION

Insert the Battery

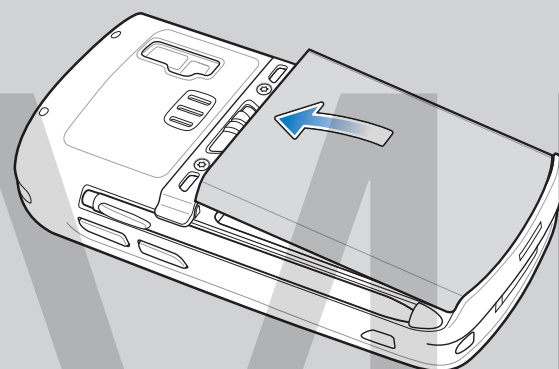

Remove the Battery

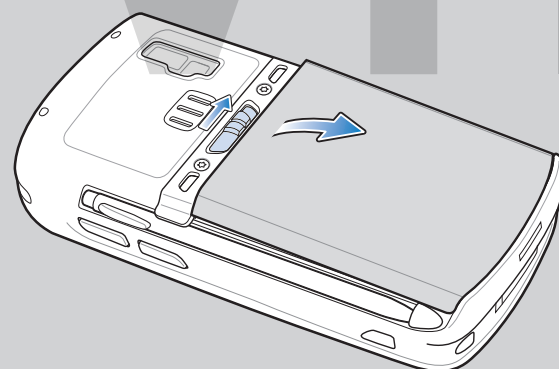

CHARGING

Charge the MC55 24hr*

1-Slot Cradle



4-Slot Battery Charger

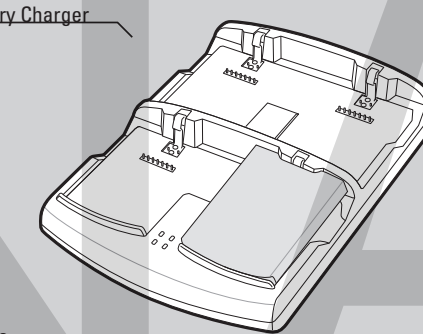

4-Slot Cradle

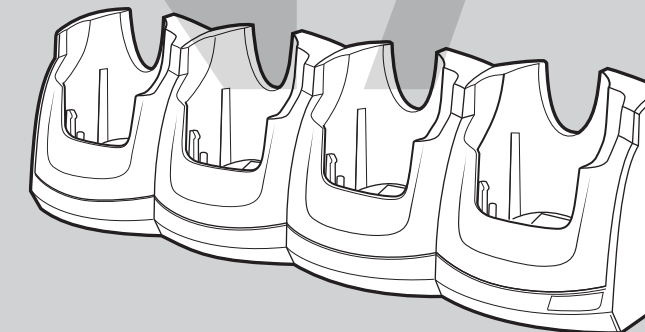

- **Charging/Battery Status LED**
Slow Blinking Amber = Charging
Solid Amber = Fully Charged
Fast Blinking Amber = Charging Error

* It is recommended that this product be charged for 24 hours before the first use to ensure that the internal battery is fully charged.

PHONE SETUP

SIM Card Installation

1. Remove battery pack.
2. Slide SIM card holder to the left.
3. Lift card holder.
4. Insert SIM card into SIM holder.

NOTE:

The proper position of the SIM card—the card connector (i.e., gold area) should be facing outward with the bevelled corner facing away.

5. Lower the SIM card holder down.
6. Slide SIM card holder to the right to lock into place.
7. Reinstall battery pack.

Enter Your PIN

After installing the SIM card activate your mobile service connection. In most cases, SIM cards are preset with a PIN (Personal Identity Number), provided by your service provider.

1. Press the Power button to turn on the MC55.
2. Tap Start > Phone.
3. Enter the PIN from your service provider.
4. Tap Enter.

Turn On the Phone Function

1. Launch the Wireless Manager application.

- On the Today screen, tap the Wireless Manager icon.
or
- On the Today screen, tap the signal icon and select Wireless Manager.

2. On the Wireless Manager screen, tap Phone to turn on the phone function. The signal icon changes indicating the MC55 is searching for a mobile connection. This may take a few seconds. The signal icon changes to and to once a mobile connection is established.

Turn Off the Phone Function

1. Launch the Wireless Manager application.

- On the Today screen, tap the Wireless Manager icon.
or
- On the Today screen, tap the signal icon and select Wireless Manager.

2. On the Wireless Manager screen, tap Phone to turn off phone function.

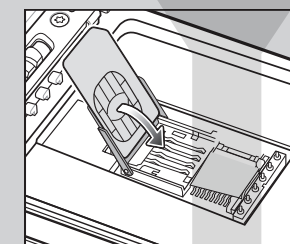
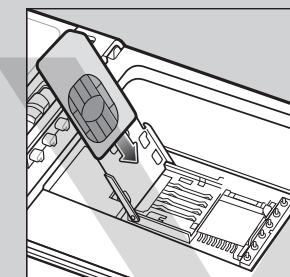
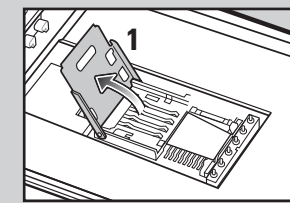

Install ActiveSync®

Download ActiveSync® 4.5 or higher from <http://www.microsoft.com> and follow the instructions to install ActiveSync onto the host computer.

Communicate with Host

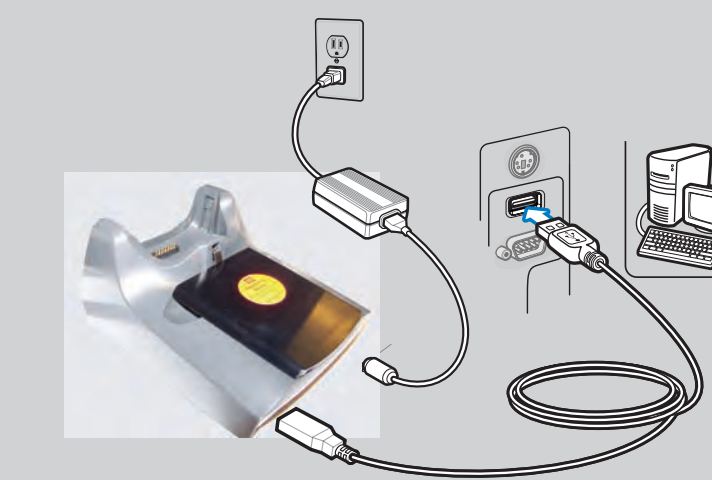

Create a Partnership

Follow the on-screen ActiveSync instructions to establish a connection between the MC55 and the host computer.

COMMUNICATION

More Information on the MC55

Visit the Motorola Web site at <http://www.motorola.com/MC55>

Setting up, using and troubleshooting the MC55

MC55 User Guide

MC55 Integrator Guide

Available at: <http://www.motorola.com/MC55>

Additional Software

Check Motorola web site for approved applications.

<http://www.motorola.com/MC55>

Connecting and synchronizing with the host computer

ActiveSync® Help on the host computer. To view help, start ActiveSync®,

Click Help - Microsoft ActiveSync Help.

Information on using programs on the MC55

Tap Start – Help within the specific program.

Service and Warranty

MC55 Regulatory Guide



Motorola, Inc.
One Motorola Plaza Holtsville, New York 11742-1300, USA

MOTOROLA and the Stylized M Logo and Symbol and the Symbol logo are registered in the U.S. Patent and Trademark Office. All other product or service names are the property of their respective owners. © Motorola, Inc. 2008



72-108862-01 Rev. 1 — June 2008

ACCESSORIES

Screen Protector

Motorola recommends the use of a screen protector to minimize wear and tear. Screen protectors enhance the usability and durability of touch screen displays. Benefits include:

- Protection from scratches and gouges
- Durable writing and touch surface with tactile feel
- Abrasion and chemical resistance
- Glare reduction
- Keeping the device's screen looking like new
- Quick and easy installation.

Not using a screen protector can affect your warranty coverage. An initial screen protector is already applied to your MC55. Contact your local account manager or Motorola, Inc. for more information and purchasing details. Part number: KT-67525-01R Screen Protector 3/pk.

MicroSD Card Installation

1. Remove battery pack.
2. Slide SIM card holder to the left.
3. Lift card holder.
4. Lift microSD card holder.
5. Insert microSD card into card holder.

NOTE:

The proper position of the microSD card—the card connector (i.e., gold area) should be facing inward.

6. Close the microSD card holder.
7. Close the SIM card holder.
8. Slide the SIM card holder to the right to lock into place.
9. Reinstall battery pack.

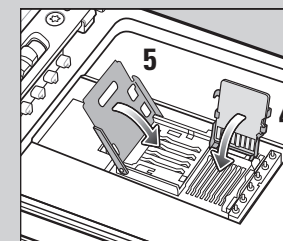
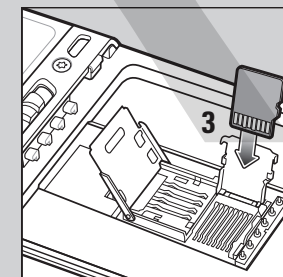
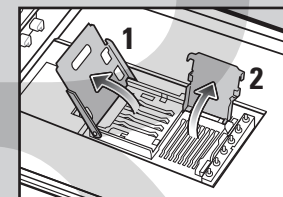

Single-slot USB Cradle

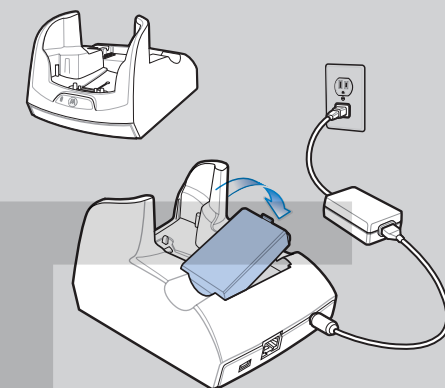

Four-slot Battery Charger

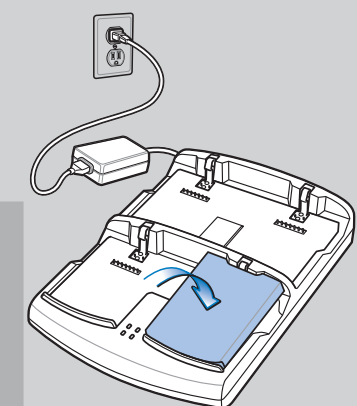

Auto Charge Cable

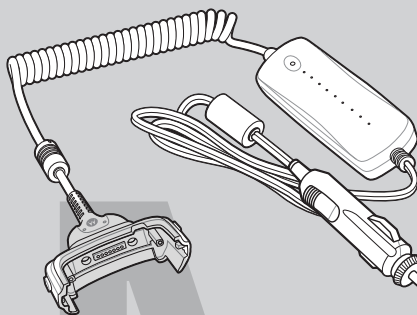

USB/Charge Cable

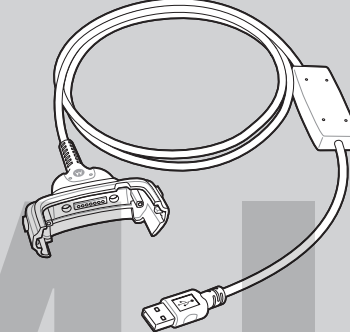

Four-slot Charge Only Cradle

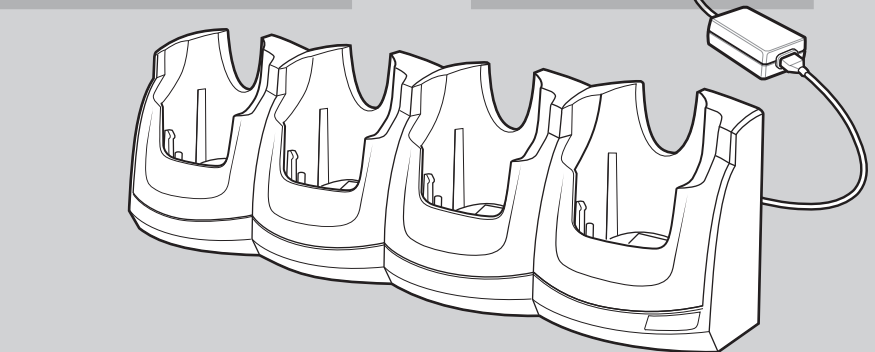

Vehicle Cradle

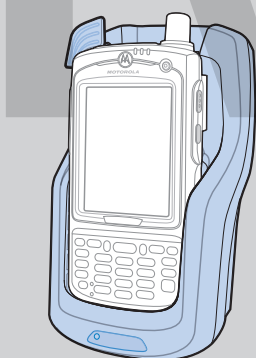

Vehicle Holder

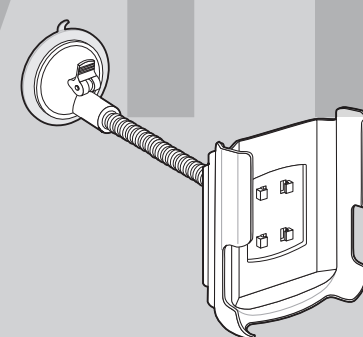

DATA CAPTURE OPTIONS

Laser Scanning

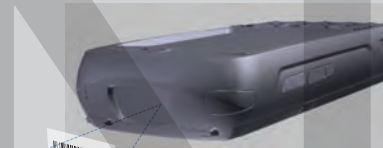

Imaging

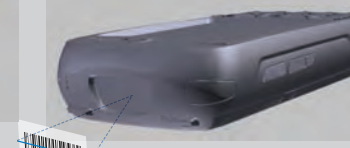

Camera Decode



1. Launch a bar code reading application on the MC55.
2. Point the MC55 toward the bar code.
3. Press the Scan button.
4. In the image window align the red target over the bar code. When the MC55 decodes the bar code the target turns green.
5. Release the Scan button.

Camera Photo

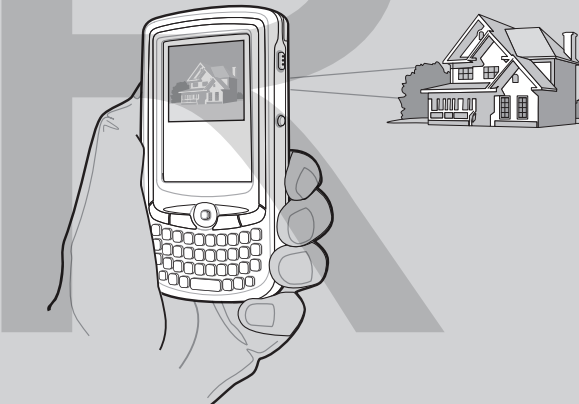

GPS Information

When using the GPS feature of the MC55:

- Acquiring satellite signals may take a few minutes. It is best to be outside and have a clear, unobstructed view of the sky.
- Without a clear view, acquisition takes much longer and could result in the MC55 being unable to compute the initial position quickly.
- Obtain a satellite fix before moving.
- Shutdown GPS application when not in use.

AVOID EXTREME WRIST ANGLES

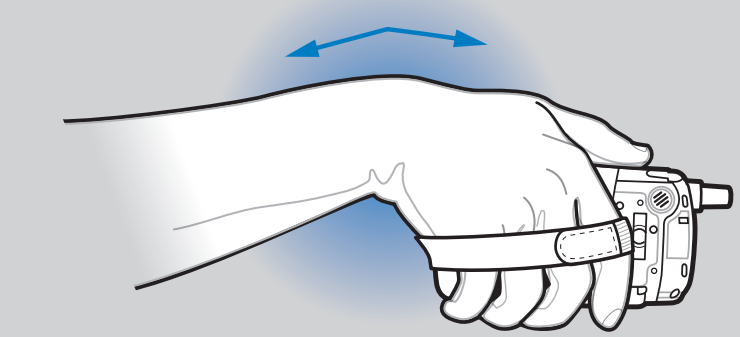
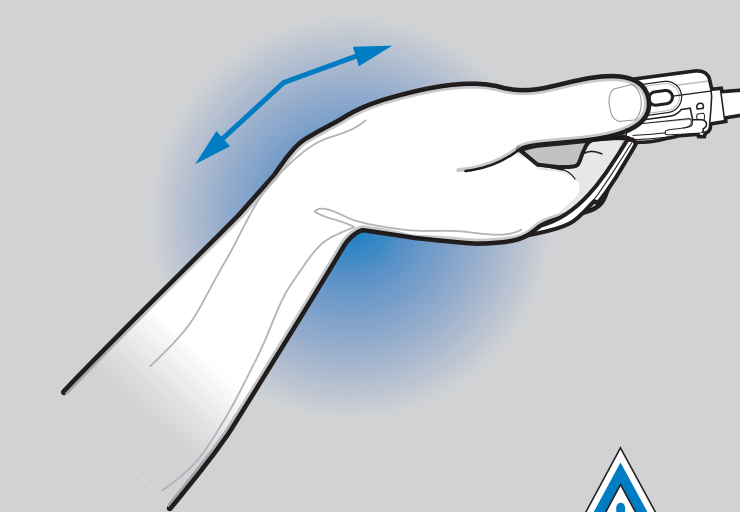

<http://www.motorola.com/MC55>