

P D T 8 1 0 0 S e r i e s



symbol[®]

P D T 8 1 0 0 S e r i e s

© 2001 SYMBOL TECHNOLOGIES, INC. All rights reserved.

Symbol reserves the right to make changes to any product to improve reliability, function, or design.

Symbol does not assume any product liability arising out of, or in connection with, the application or use of any product, circuit, or application described herein.

No license is granted, either expressly or by implication, estoppel, or otherwise under any patent right or patent, covering or relating to any combination, system, apparatus, machine, material, method, or process in which Symbol products might be used. An implied license only exists for equipment, circuits, and subsystems contained in Symbol products.

Symbol and the Symbol logo are registered trademarks of Symbol Technologies, Inc. Other product names mentioned in this manual may be trademarks or registered trademarks of their respective companies and are hereby acknowledged.

Symbol Technologies, Inc.
One Symbol Plaza
Holtsville, N.Y. 11742-1300
<http://www.symbol.com>

Patents

This product is covered by one or more of the following U.S. and foreign Patents:

U.S. Patent No. 4,460,120; 4,496,831; 4,593,186; 4,603,262; 4,607,156; 4,652,750;
4,673,805; 4,736,095; 4,758,717; 4,816,660; 4,845,350; 4,896,026; 4,897,532; 4,923,281;
4,933,538; 4,992,717; 5,015,833; 5,017,765; 5,021,641; 5,029,183; 5,047,617; 5,103,461;
5,113,445; 5,130,520; 5,140,144; 5,142,550; 5,149,950; 5,157,687; 5,168,148; 5,168,149;
5,180,904; 5,216,232; 5,229,591; 5,230,088; 5,235,167; 5,243,655; 5,247,162; 5,250,791;
5,250,792; 5,260,553; 5,262,627; 5,262,628; 5,266,787; 5,278,398; 5,280,162; 5,280,163;
5,280,164; 5,280,498; 5,304,786; 5,304,788; 5,306,900; 5,321,246; 5,324,924; 5,337,361;
5,367,151; 5,373,148; 5,378,882; 5,396,053; 5,396,055; 5,399,846; 5,408,081; 5,410,139;
5,410,140; 5,412,198; 5,418,812; 5,420,411; 5,436,440; 5,444,231; 5,449,891; 5,449,893;
5,468,949; 5,471,042; 5,478,998; 5,479,000; 5,479,002; 5,479,441; 5,504,322; 5,519,577;
5,528,621; 5,532,469; 5,543,610; 5,545,889; 5,552,592; 5,557,093; 5,578,810; 5,581,070;
5,589,679; 5,589,680; 5,608,202; 5,612,531; 5,619,028; 5,627,359; 5,637,852; 5,664,229;
5,668,803; 5,675,139; 5,693,929; 5,698,835; 5,705,800; 5,714,746; 5,723,851; 5,734,152;
5,734,153; 5,742,043; 5,745,794; 5,754,587; 5,762,516; 5,763,863; 5,767,500; 5,789,728;
5,789,731; 5,808,287; 5,811,785; 5,811,787; 5,815,811; 5,821,519; 5,821,520; 5,823,812;
5,828,050; 5,850,078; 5,861,615; 5,874,720; 5,875,415; 5,900,617; 5,902,989; 5,907,146;
5,912,450; 5,914,478; 5,917,173; 5,920,059; 5,923,025; 5,929,420; 5,945,658; 5,945,659;
5,946,194; 5,959,285; 6,002,918; 6,021,947; 6,036,098; 6,047,892; 6,050,491; 6,053,413;
6,056,200; 6,065,678; 6,067,297; 6,068,190; 6,082,621; 6,084,528; 6,088,482; 6,092,725;
6,101,483; 6,102,293; 6,104,620; 6,114,712; 6,115,678; 6,119,944; 6,123,265; 6,131,814;
6,138,180; 6,142,379; 6,172,478; 6,176,428; 6,178,426; 6,186,400; 6,188,681; D305,885;
D341,584; D344,501; D359,483; D362,453; D363,700; D363,918; D370,478; D383,124;
D391,250; D405,077; D406,581; D414,171; D414,172; D418,500; D419,548; D423,468;
D424,035; D430,158; D430,159; D431,562; D436,104.

Invention No. 55,358; 62,539; 69,060; 69,187 (Taiwan); No. 1,601,796; 1,907,875;
1,955,269 (Japan).

European Patent 367,299; 414,281; 367,300; 367,298; UK 2,072,832; France 81/03938;
Italy 1,138,713.

rev. 04/01

FCC RF EXPOSURE INFORMATION

WARNING! *Read this information before using your phone*



In August 1996 the Federal Communications Commission (FCC) of the United States with its action in Report and Order FCC 96-326 adopted an updated safety standard for human exposure to radio frequency electromagnetic energy emitted by FCC regulated transmitters. Those guidelines are consistent with the safety standard previously set by both U.S. and international standards bodies. The design of this phone complies with the FCC guidelines and these international standards.



Use only the supplied or an approved antenna. Unauthorized antennas, modifications, or attachments could impair call quality, damage the phone, or result in violation of FCC regulations.

Do not use the phone with a damaged antenna. If a damaged antenna comes into contact with the skin, a minor burn may result. Please contact your local dealer for replacement antenna.

Body-worn Operation

This device was tested for typical body-worn operations with the Holster providing a minimal spacing of 2.5 cm. from the body to the back of the terminal/antenna. To maintain compliance with FCC RF exposure compliance requirements, use only belt-clips, holsters or similar accessories that maintain a 2.5 cm. separation distance between the user's body and the back of the terminal, including the antenna. The use of third-party belt-clips, holsters and similar accessories should not contain metallic components in its assembly. The use of accessories that do not satisfy these requirements may not comply with FCC RF exposure compliance requirements, and should be avoided.

Q u i c k R e f e r e n c e

Introduction

Congratulations on your purchase of Symbol Technologies' PDT 8100 Terminal! Its unique combination of features make this product superior for use in a wide range of applications. These features include:

- Personal Information Management software
- Microsoft® Windows® Pocket PC operating system
- RF communication via Symbol's Spectrum24 wireless network or a wide area network (WAN)
- 1-dimensional scanning capability
- 28-key, 37-key, or 47-key keyboard
- Touch screen
- Printing support
- IrDA-compliant interface for printing and communications.

About This Guide

This guide describes how to set up and use the terminal. The term PDT 8100 refers to the batch 1D scanning terminal, and the Spectrum24 terminal. Specific topics covered include:

- Parts of the PDT 8100 Series on page 3
- Installing Batteries on page 5
- Charging the Battery on page 6
- 15-Pin Serial Port Connector on page 9
- Attaching the Handstrap on page 9
- Inserting a Compact Flash Card on page 10
- Removing a Compact Flash Card on page 11
- Starting the PDT 8100 on page 11
- Aligning the Screen on page 12
- Using the PDT 8100 on page 13
- Using the Keyboard on page 14
- Using the Stylus on page 19
- Today Screen on page 20
- Navigation Bar and Command Bar on page 21
- Input Methods on page 22

P D T 8 1 0 0 S e r i e s

- Scanning with the PDT 8100 on page 24
- Resetting Your PDT 8100 Terminal on page 24
- Host Communications on page 26
- Maintaining the PDT 8100 on page 27
- Troubleshooting on page 28.

The *PDT 8100 Product Reference Guide* (p/n 72-50932-xx), available from your Reseller or from Symbol Technologies, details the applications available for the PDT 8100.

Accessories

Each PDT 8100 requires one 1550 mAh lithium-ion battery. The following optional accessories are available from Symbol Technologies:

- Additional lithium-ion battery
- Stylus for performing pen functions
- Cables:
 - Serial charging cable
 - DEX cable
 - Autocharge cable
 - Snap-on printer cable
- Single-slot cradle
- Four-slot cradle
- Vehicle cradle
- IrDA compliant printer
- Magnetic stripe reader
- Clip on modem module
- Carrying case.

Q u i c k R e f e r e n c e

Parts of the PDT 8100 Series

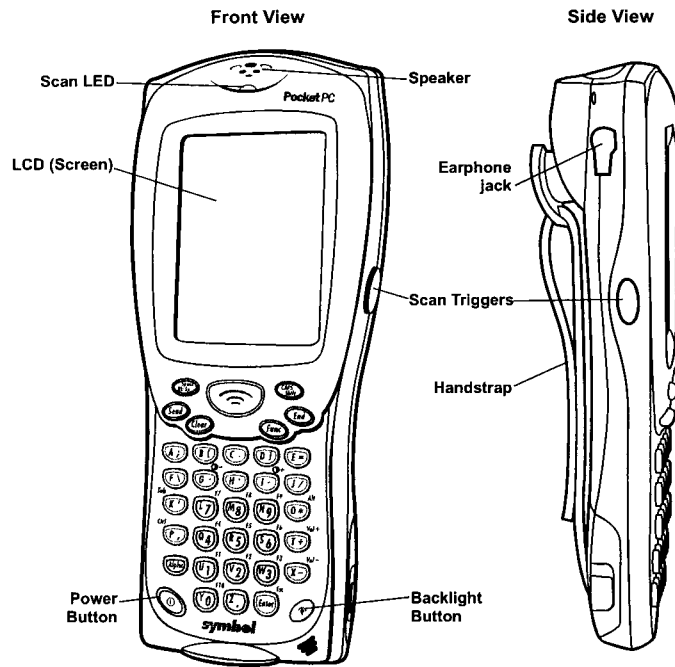

Top View

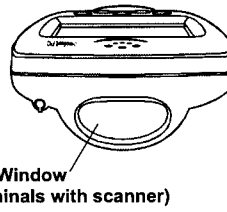

P D T 8 1 0 0 S e r i e s

Parts of the PDT 8100 Series (continued)

Back View

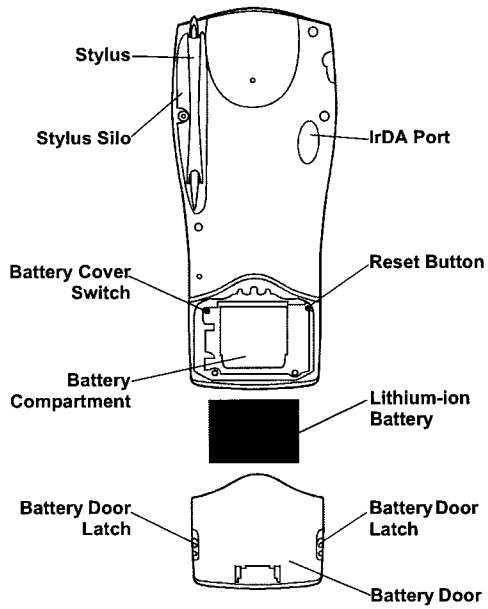

Bottom View

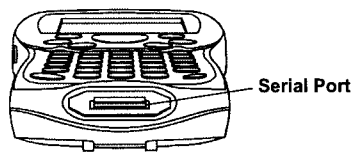

Q u i c k R e f e r e n c e

Installing Batteries

1. Slide the latches on the battery door up and lift the battery door away from the PDT 8100.

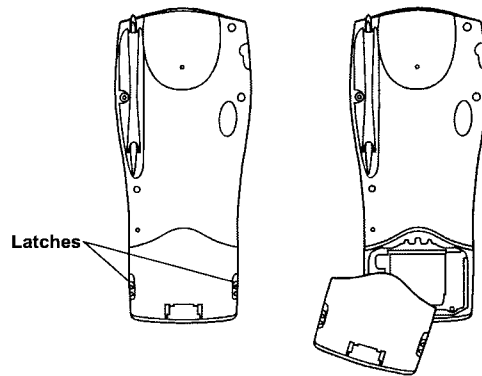

2. Insert the lithium-ion battery in the battery compartment with the battery tether positioned properly (as shown below), making sure the battery snaps into place.

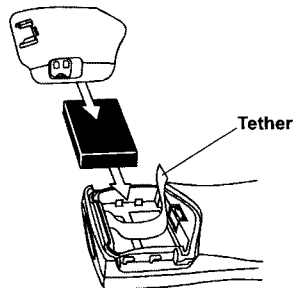

3. Replace the battery cover, pressing down firmly along the top edge while sliding the latches down into the locked position.

P D T 8 1 0 0 S e r i e s

Charging the Battery

Before using your PDT 8100 for the first time, charge the lithium-ion battery in the terminal for about 2 1/2 hours, using the CRD 8100 Cradle or the Synchronization Cable. Follow these same procedures to recharge the battery.

Your terminal is equipped with a memory backup battery which automatically charges from the fully-charged lithium-ion battery. This backup battery retains data in memory when the terminal's battery is removed, and takes several hours to charge when you first use your terminal.

Note: If you remove your lithium-ion battery before the backup battery is fully charged, data may be lost. For this reason, DO NOT remove the battery within the first ten hours of use.

Charging the Battery Using the CRD 8100 Cradle

1. Set up the cradle according to the procedures in the *CRD 8100 Quick Reference Guide*.

Q u i c k R e f e r e n c e

2. Insert the PDT 8100 terminal in the cradle.

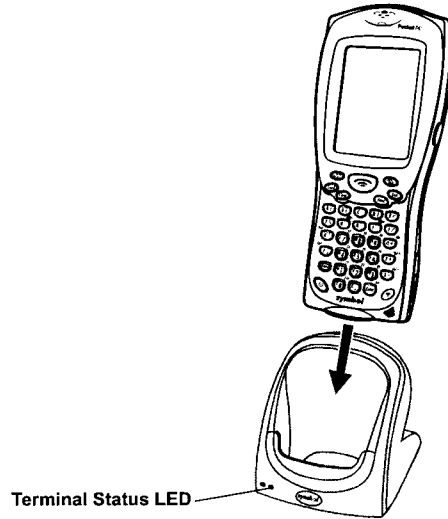

3. The Terminal Status LED turns red (may take up to one minute) to indicate charging, then turns off when the battery is fully charged. The terminal's battery is fully charged after approximately 2 1/2 hours.

Charging a Spare Battery

To recharge a spare battery, insert it in the spare battery charging slot in the back of the cradle, so the contacts are facing down and towards the back of the cradle. Press the battery down into the slot until firmly seated.

The Spare Battery LED turns red to indicate charging, then green when the battery is fully charged. The battery is fully charged after

P D T 8 1 0 0 S e r i e s

approximately 2 1/2 hours. See the *CRD 8100-1000S Quick Reference Guide* (p/n 72-50974-xx) for more information.

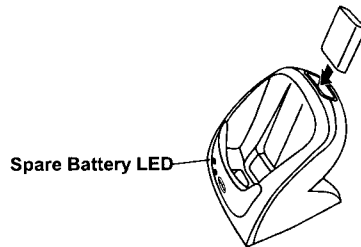

Charging the Battery Using the Synchronization Cable

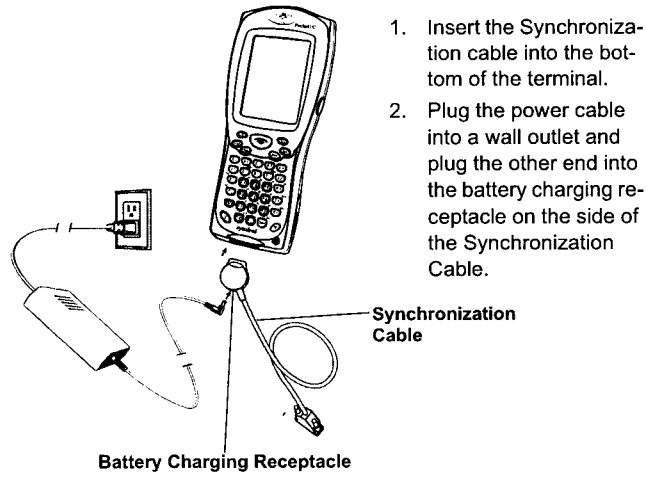

Q u i c k R e f e r e n c e

15-Pin Serial Port Connector

To connect to the Micro-D RS-232 port at the top of the terminal, use an ITT Cannon brand mil-spec connector (MDM-15SSB) with captivated jack screws (mil p/n M83513/5-6) to protect the connector's contacts from damage during insertion and removal.

Attaching the Handstrap

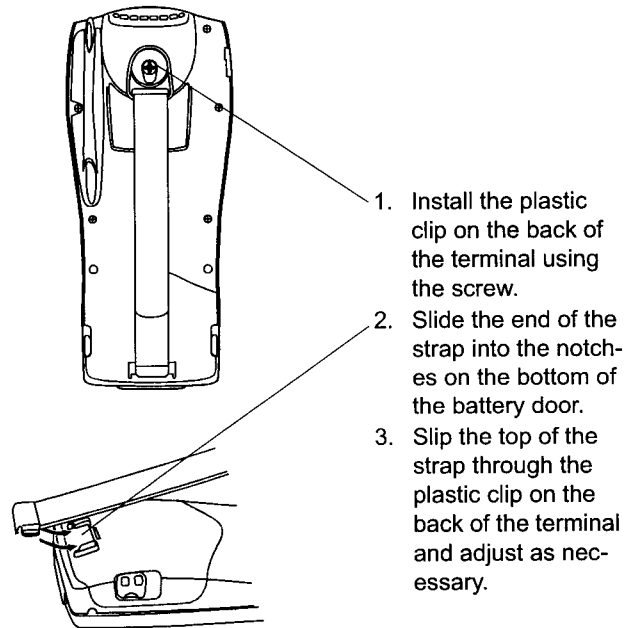

Inserting a Compact Flash Card

The PDT 8100 contains a slot for a standard compact flash card, which includes a locking mechanism that prevents the card from coming loose if the PDT 8100 is dropped. Insert the compact flash card carefully to ensure it engages this locking mechanism.

1. Open the battery door and remove the battery.
2. Remove the flash card cover at the top of the battery compartment by pulling the top out, and lifting the cover up.



3. Insert the flash card into the compartment with the pins facing forward, and the main label facing down. It only fits one way. The two metal tabs on the locking mechanism will prevent you from pushing the card all the way in.

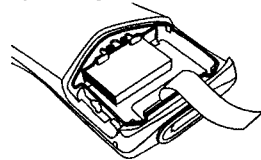

4. To fit the card into place, push down and in at the same time, so that the lip of the compact flash card slips *under* the tabs of the locking mechanism.
5. Replace the flash card cover by inserting the bottom first, and pressing the top in.

Note: After you insert or remove a compact flash card, you must replace the flash card cover or the terminal will not function.

6. Reinsert the battery and battery door.
7. Perform a soft reset (see Performing a Soft Reset on page 24).

Q u i c k R e f e r e n c e

Removing a Compact Flash Card

1. Open the battery door and remove the battery and flash card cover.
2. Use the stylus to press the flash card release button inside the flash card compartment.

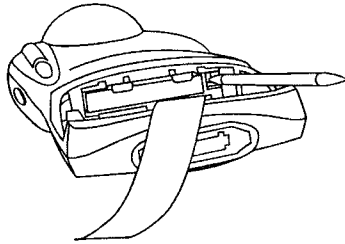

Starting the PDT 8100

Press the red power button to turn the PDT 8100 on and off. If the terminal does not power on, perform a hard reset. See Performing a Hard Reset on page 25.

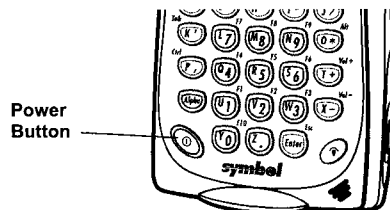

As the terminal initializes its unique Flash File system, the Symbol splash screen displays for about 10 seconds. When the Welcome screen appears, tap anywhere on the screen to continue to the Align screen. Note that these screens also appear every time you perform a hard reset.

P D T 8 1 0 0 S e r i e s

Aligning the Screen

To align your PDT 8100 so the cursor on the touch screen aligns with the tip of your stylus:

1. If necessary, adjust the contrast on the PDT 8100 so the screen is readable. See Controlling the Backlight on page 13.
2. Remove the stylus from its storage silo on the back of the PDT 8100.
3. Tap the center of each target that appears on the screen with the tip of the stylus.

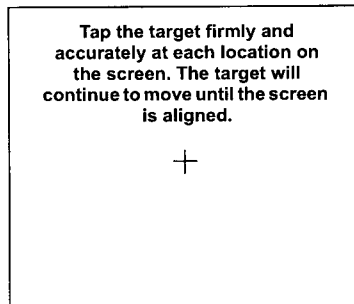

4. Follow the directions on the screen which explain how to use the stylus and pop-up menus, and allow you to set your city and time zone.

Q u i c k R e f e r e n c e

Using the PDT 8100

Controlling the Backlight

Turn the backlight on and off by pressing the Backlight button.

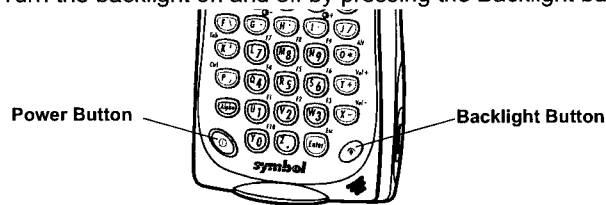

Adjusting the Contrast

Keyboard	Keys	Description
28-key	Function + "1"	Decrease contrast (lighten the screen)
	Function + "2"	Increase contrast (darken the screen)
37-key	Function + "G"	Decrease contrast (lighten the screen)
	Function + "I"	Increase contrast (darken the screen)
47-key	Function + "Y"	Decrease contrast (lighten the screen)
	Function + "W"	Increase contrast (darken the screen)

Using the Keyboard

Note: Key functions can be changed by an application. Your keyboard may not function exactly as described. For more detailed keyboard information, refer to the *PDT 8100 Product Reference Guide*.

Using the 28-Key Keyboard

The 28-key keyboard uses an alphanumeric keypad that produces the 26-character alphabet (A-Z), numbers (0-9), and assorted characters. The keyboard is color-coded to indicate which modifier key (Alpha-Numeric, **Func**) to press to produce a particular character or action. The keyboard default is numeric, producing numbers.

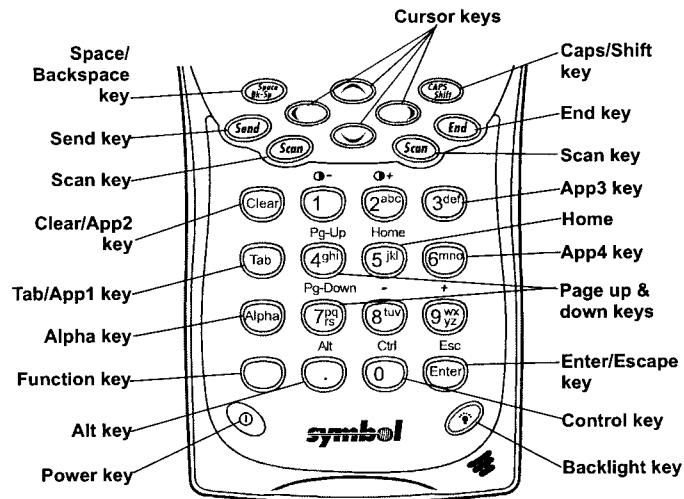

Q u i c k R e f e r e n c e

Key	Action
<p>Note: Press Func, then another key to produce the value or function above that key. See individual key descriptions in this table for additional Function key usage.</p>	
Alpha	Press Alpha to toggle between alpha and numeric mode. In alpha mode, pressing a key produces the yellow letter on that key; in numeric mode, pressing a key produces the number in gray.
App3	Press Func + 3 to activate the APP3 key.
App4	Press Func + 6 to activate the APP4 key.
Backlight	See Controlling the Backlight on page 13.
Caps/Shift	Press Shift when in alpha mode, then another key to capitalize the letter on that key. Press Func + Shift to toggle All Caps on and off. Func + Shift also erases all entered data from the screen.
Clear/App2	Press Clear to clear the screen. Press Func + Clear to activate the APP2 key.
Contrast	See Adjusting the Contrast on page 13.
Cursor	Press cursor keys to move the cursor left, right, up and down on the screen. Press Func + up cursor to raise the volume. Press Func + down cursor to lower the volume.
End	Press End to move the cursor to the end of a line.
Enter/Escape	Press Enter after entering data or a command. Press Func + Enter to partially or completely escape from an application level or screen.
Power	See Starting the PDT 8100 on page 11.
Scan	Press Scan to scan bar codes. (Also use right and left scan triggers.)
Send	The Send key is application dependent.
Space/Back-space	Press Func + Bk-Sp to enter a blank space. Press Bk-Sp to erase information entered on the display, one character at a time.
Tab/App1	Press Tab to move from field to field. Press Func + Tab to activate the APP1 key.

P D T 8 1 0 0 Series

Using the 37-Key Keyboard

The 37-key keyboard uses an alphanumeric keypad that produces the 26-character alphabet (A-Z), numbers (0-9), and assorted characters. The keyboard is color-coded to indicate which modifier key (Alpha-Numeric, **Func**) to press to produce a particular character or action. The keyboard default is numeric, producing the gray number or white character on that key.

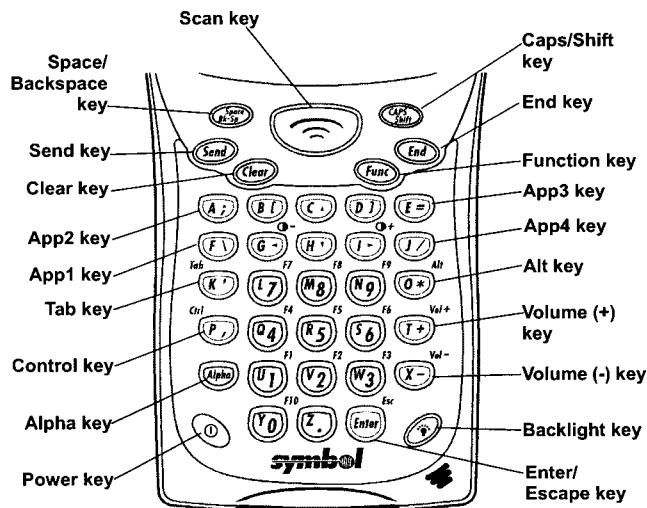

Key	Action
Note: Press Func , then another key to produce the value or function above that key. See individual key descriptions in this table for additional Function key usage.	
Alpha	Press Alpha to toggle between alpha and numeric mode. In alpha mode, pressing a key produces the yellow letter on that key; in numeric mode, pressing a key produces the number in gray or character in white.
App3	Press Func + E to activate the APP3 key.

Q u i c k R e f e r e n c e

Key	Action
App4	Press Func + J to activate the APP4 key.
Backlight	See Controlling the Backlight on page 13.
Caps/Shift	Press Shift when in alpha mode, then another key to capitalize the letter on that key. Press Func + Shift to toggle All Caps on and off. Func + Shift also erases all entered data from the screen.
Clear	Press Clear to clear the screen.
Contrast	See Adjusting the Contrast on page 13.
Cursor keys: C, G, H, I	Press cursor keys to move the cursor left, right, up and down on the screen.
End	Press End to move the cursor to the end of a line.
Escape/Enter	Press Enter after entering data or a command. Press Func + Enter to partially or completely escape from an application level or screen.
Power	See Starting the PDT 8100 on page 11.
Scan	Press Scan to scan bar codes. (Also use right and left scan triggers.)
Send	The Send key is application dependent.
Space/Back-space	Press Func + Bk-Sp to enter a blank space. Press Bk-Sp to erase information entered on the display, one character at a time.

Using the 47-Key Keyboard

The 47-key keyboard uses an alphanumeric keypad that produces the 26-character alphabet (A-Z), numbers (0-9), and assorted characters. The keyboard is color-coded to indicate which modifier key (Alpha-Numeric, **Func**) to press to produce a particular character or action. The keyboard default is the key value, producing the gray number or lower case yellow letter on that key.

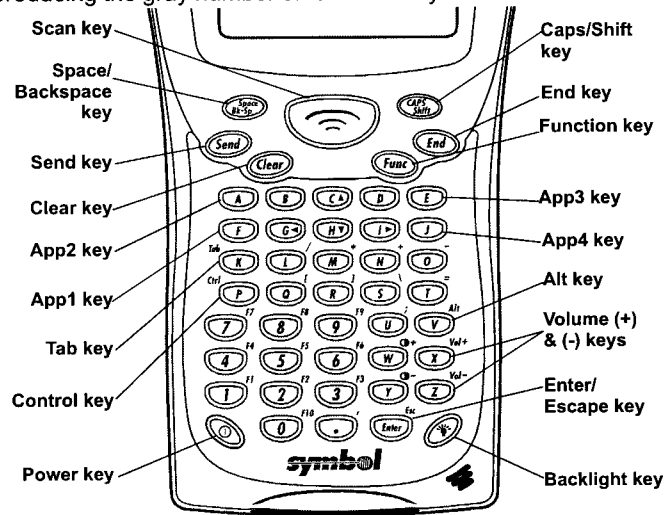

Key	Action
Note: Press Func , then another key to produce the value or function above that key. See individual key descriptions in this table for additional Function key usage.	
App3	Press Func + E to activate the APP3 key.
App4	Press Func + J to activate the APP4 key.
Backlight	See Controlling the Backlight on page 13.

Q u i c k R e f e r e n c e

Key	Action
Caps/Shift	Press Shift when in alpha mode, then another key to capitalize the letter on that key. Press Func + Shift to toggle All Caps on and off. Func + Shift also erases all entered data from the screen.
Clear	Press Clear to clear the screen.
Contrast	See Adjusting the Contrast on page 13.
Cursor keys: C, G, H, I	Press cursor keys to move the cursor left, right, up and down on the screen.
End	Press End to move the cursor to the end of a line.
Escape/Enter	Press Enter after entering data or a command. Press Func + Enter to partially or completely escape from an application level or screen.
Power	See Starting the PDT 8100 on page 11.
Scan	Press Scan to scan bar codes. (Also use right and left scan triggers.)
Send	The Send key is application dependent.
Space/Back-space	Press Func + Bk-Sp to enter a blank space. Press Bk-Sp to erase information entered on the display, one character at a time.

Using the Stylus

The stylus selects items and enters information. The stylus functions as a mouse.

- **Tap:** Touch the screen once with the stylus to open items and select options.
- **Drag:** Hold the stylus on the screen and drag across the screen to select text and images. Drag in a list to select multiple items.
- **Tap-and-hold:** Tap and hold the stylus on an item to see a list of actions available for that item. On the pop-up menu that appears, tap the action you want to perform.

Today Screen

When you turn on your terminal for the first time each day (or after 4 hours of inactivity), the Today screen appears. You can also display it by tapping , then Today. On the Today screen, you can see important information for the day.

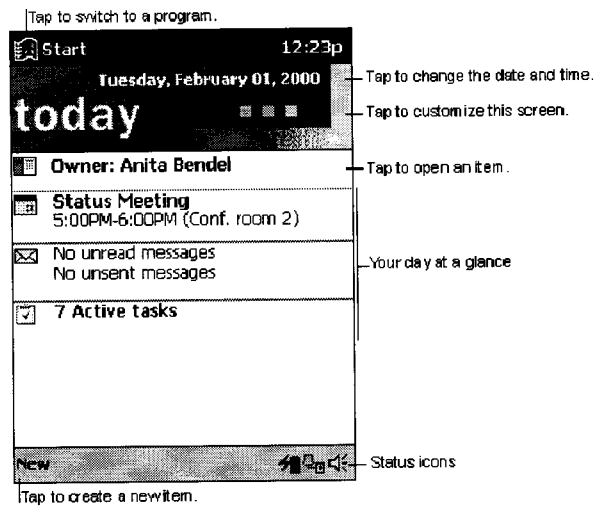

Q u i c k R e f e r e n c e

Navigation Bar and Command Bar

The navigation bar at the top of the screen displays the active program and current time, and allows you to switch to programs and close screens. The command bar at the bottom of the screen contains menus and buttons to perform tasks in programs.

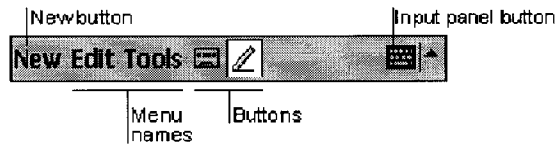
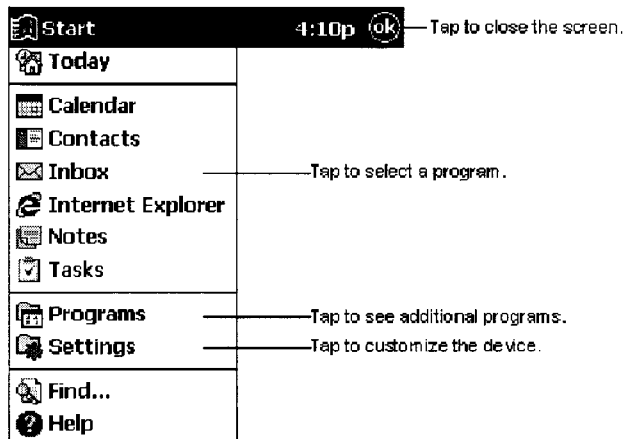

Input Methods

Enter information in any program by typing with the 28-, 37-, or 47-key keyboard, the soft keyboard, or writing using Character Recognizer.

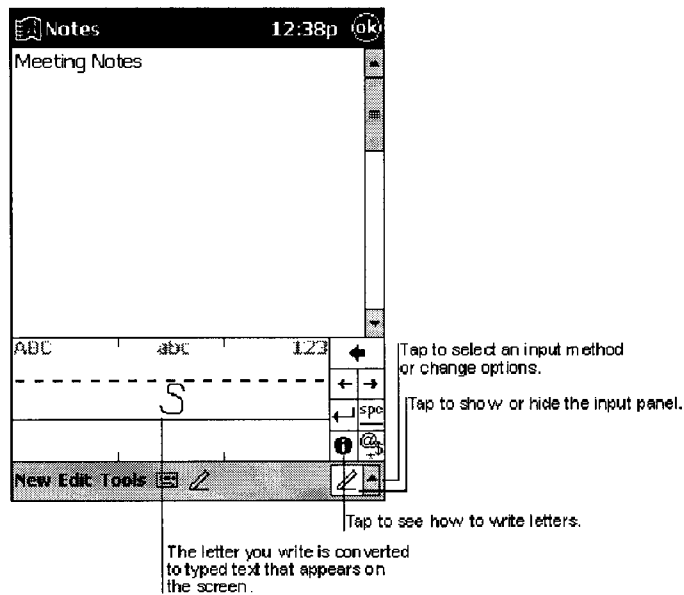

The Character Recognizer input panel is divided into three writing areas. Letters written in the left area (labeled ABC) create uppercase letters and letters written in the middle area (labeled abc) create lowercase letters. The right area (labeled 123) is for writing numbers, symbols, special characters, and punctuation. The following chart is a partial display of the characters you can write while in lowercase mode (the dot on each character is the starting point for writing). For more information on using Character

Q u i c k R e f e r e n c e

Recognizer and for demos of all characters, tap on the Character Recognizer input panel.

Letter Area										Number/Punctuation Area									
A	aa				N	nn				0	0))			
B	bb				O	oo				1	1				+	+			
C	cc				P	pp				2	2 2				*x	*x			
D	dd				Q	qq				3	3				/	/			
E	ee				R	rr				4	4 4 4 4				\	\			
F	ff				S	ss				5	5 5 5				? 7 7	? 7 7			
G	gg				T	t 7 7 7 7				6	6				!	!			
H	hh				U	uu				7	7				@	@			
I	ii				V	vv				8	8				&	&			
J	jj				W	ww				9	9				'	'			
K	k k k k				X	x x x				>	>				“	“			
L	l l l				Y	y y y				•	•				-	-			
M	m				Z	z				((

space	_____
back space	_____→

enter	_____↑
back space	_____→

P D T 8 1 0 0 S e r i e s

Scanning with the PDT 8100

The PDT 8100 has an integrated scanner which collects data by scanning bar codes. See the *PDT 8100 Product Reference Guide* for information on configuring your terminal for scanning.

To scan bar codes with the PDT 8100:

1. Aim the scanner at the bar code.
2. Press the scan trigger. Ensure the red scan beam covers the entire bar code. The green scan LED lights and a beep sounds to indicate a successful decode.

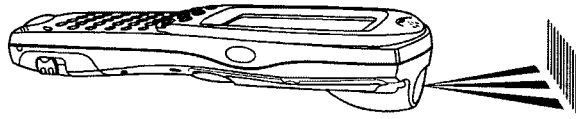

Resetting Your PDT 8100 Terminal

If your PDT 8100 terminal stops responding to input, reset it.

Performing a Soft Reset

A soft reset restarts the terminal and saves all stored records and entries.

Caution: Files that remain open during a soft reset may not be retained.

DO NOT perform a soft reset if the terminal is suspended. Press the Power button to wake the terminal; if the terminal does not turn on, perform a soft reset.

Q u i c k R e f e r e n c e

To perform a soft reset:

Keyboard	Keys
28-key	Backlight + Down Arrow + Function
37-key	Backlight + Alpha + Function
47-key	Backlight + End + Function

Performing a Hard Reset

A hard reset also restarts your PDT 8100 terminal, but erases all stored records and entries. *Therefore, never perform a hard reset unless a soft reset does not solve your problem.*

Note: You can restore any data previously synchronized with your computer during the next ActiveSync operation. See the *CRD 8100 Quick Reference Guide* or the *PDT 8100 Product Reference Guide*.

To perform a hard reset on the terminal:

1. Remove the battery cover.
2. While holding down the Function key, use the stylus (or similar object *without* a sharp tip) to gently press the reset button.

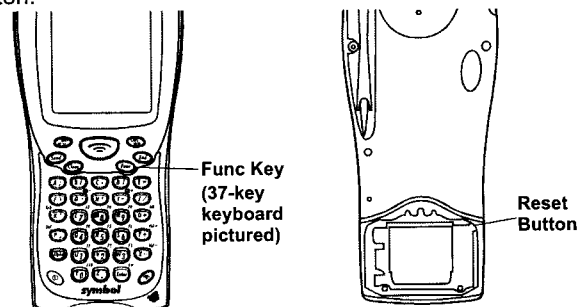

3. Replace the battery cover and press the Power button.
4. As the terminal reboots, the Symbol splash screen displays for about 10 seconds.

P D T 8 1 0 0 S e r i e s

5. Realign the screen as described on page 12.

Note: With a hard reset, Formats, Preferences, and other settings are restored to their factory default settings.

Host Communications

The PDT 8100 Series terminal can communicate with a host PC either directly through its communications port using an RS-232 serial cable, the cradle, or wirelessly via the Spectrum24[®] wireless LANs. For more information on setting up and performing wireless communications with your PDT 8100 Series terminal, refer to the *PDT 8100 Series Product Reference Guide*.

Using the RS-232 Serial Cable

To connect the RS-232 serial cable for host communication:

1. Connect the RS-232 serial communication cable's connector to the adapter cable's connector.
2. Plug the adapter cable's subminiature connector into the serial communication port on the bottom of the terminal.
3. Plug the other end of the RS-232 serial communication cable into the host PC.
4. Begin host communication as specified by your application.

Using the Cradle

To communicate through the cradle:

1. Ensure all connections between the cradle and the host computer are secure. See the *Quick Reference Guide* that shipped with your cradle for instructions on setting up the cradle.
2. Power on the host computer, the cradle, and the terminal.
3. Insert the terminal into the cradle.
4. Begin host communications as specified by your application.

Communicating with Printers

To print from a standard printer:

Q u i c k R e f e r e n c e

1. Attach an RS-232 serial cable to the serial port in the bottom of the PDT 8100.
2. Attach the other end of the cable to the serial port on the printer.
3. Run your application's print function.

To print from an IrDA-compliant printer:

1. Point the IrDA port on the back of the PDT 8100 at the IrDA port on the printer, at a maximum distance of 39 inches (1 meter).
2. Run the application's print function.

Note: The PDT 8100 must have software configured to communicate with the printer you are using.

Maintaining the PDT 8100

To maintain your PDT 8100 in good working order:

- Do not scratch the screen. Use the supplied stylus or plastic-tipped pens intended for use with a touch-sensitive screen. Never use a pen or pencil or other sharp object on the screen.
- Although your PDT 8100 is water and dust resistant, do not expose it to rain or moisture for an extended period of time. Treat your PDT 8100 as you would a pocket calculator or other small electronic instrument.
- The touch-sensitive screen of your PDT 8100 contains glass. Do not drop your PDT 8100 or subject it to strong impact.
- Protect your PDT 8100 from temperature extremes. Do not leave it on the dashboard of a car on a hot day, and keep it away from heat sources.
- Do not store or use your PDT 8100 in any location that is extremely dusty, damp or wet.
- If the surface of the PDT 8100 screen becomes soiled, clean it with a soft cloth moistened with a diluted window-cleaning solution.

P D T 8 1 0 0 Series

Troubleshooting

Problem	Cause	Solution
PDT 8100 does not turn on.	Lithium-ion battery not charged.	Charge or replace the lithium-ion battery in the PDT 8100.
	Lithium-ion battery not installed properly.	Ensure battery is installed properly.
	System crash.	Perform a hard reset. See Resetting Your PDT 8100 Terminal on page 24.
Rechargeable lithium-ion battery did not charge.	Battery failed.	Replace battery. If your PDT 8100 terminal still does not operate, try a soft reset, then a hard reset; see Resetting Your PDT 8100 Terminal on page 24.
	PDT 8100 removed from cradle while battery was charging.	Insert PDT 8100 in cradle and begin charging. The lithium-ion battery requires up to 4 hours to recharge fully.
Cannot see characters on display.	PDT 8100 not powered on.	Press the PWR key.
	Contrast not adjusted properly.	To adjust the contrast on your PDT 8100 terminal, see Adjusting the Contrast on page 13.

Q u i c k R e f e r e n c e

Problem	Cause	Solution
Fail to communicate with IrDA printer.	Distance from printer is more than 1 meter (39 inches).	Bring the terminal closer to the printer and attempt communications again.
	Obstruction interfered with communication.	Check the path to ensure no objects were in the way.
	Application is not enabled to run IrDA printing.	Printer support must be included with the application to run IrDA printing on the terminal. See your System Administrator.
During data communication, no data was transmitted, or transmitted data was incomplete.	Terminal removed from cradle or unplugged from host PC during communications.	Replace the terminal in the cradle, or replace the Synchronization cable, and re-transmit.
	Incorrect cable configuration.	See your System Administrator.
	Communication software was incorrectly installed or configured.	Perform setup as described in the <i>PDT 8100 Product Reference Guide</i> .
No sound is audible.	Volume setting is low or turned off.	Check the System Volume slider in the Sounds & Reminders properties dialog box (under Start/Settings) to make sure the volume is not turned down.

P D T 8 1 0 0 S e r i e s

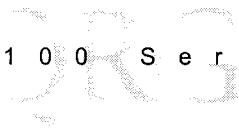

Problem	Cause	Solution
PDT 8100 turns itself off.	PDT 8100 is inactive.	Your PDT 8100 turns off after a period of inactivity. This period can be set from one to five minutes, in one-minute intervals. Check the Power dialog box (in the System tab under Start/Settings), and change the setting if you need a longer delay before the automatic shutoff feature activates.
PDT 8100 doesn't recognize my handwriting.	Character strokes written incorrectly with the stylus.	For your PDT 8100 to recognize handwriting input with the stylus, characters must be written a certain way. See the <i>PDT 8100 Product Reference Guide</i> for information about how to write character strokes.
	Character strokes written on the wrong part of the LCD screen.	Make the character strokes in the lower character entry area on the screen — not on the display part of the screen.
	Lower-case and upper-case letters, and numbers written on the wrong parts of the LCD screen.	Make sure you are writing lower-case letters in the left-hand side, numbers in the right-hand side, and upper-case letters in the center of the writing area.
Tapping the screen buttons or icons does not activate the corresponding feature.	LCD screen not aligned correctly.	Align the screen. Choose Align Screen from the System tab under Start/Settings , or hold down the Function button and press the Action button.

Q u i c k R e f e r e n c e

Problem	Cause	Solution
A message appears stating that your PDT 8100 terminal memory is full.	Too many files stored on the terminal.	Delete unused memos and records. You can save these records on your computer.
	Memory allocation too low.	Adjust the memory allocation. Select Start , then Settings , and select the System tab. Tap Memory and adjust the slider.
	Too many applications installed on the terminal.	If you have installed additional applications on your PDT 8100, remove them to recover memory. Select Start , then Settings , and select the System tab. Tap Remove Programs , select the unused program and tap Remove .
Beamed data does not transmit.	PDT 8100 terminals too close together.	Confirm that the PDT 8100 terminals are 5" apart, and there is a clear path between the two devices.
	Insufficient room lighting.	Adjust the room lighting or move to a different location.
When receiving beamed data an out of memory message appears.	Not enough free memory available for receiving data.	Your PDT 8100 terminal requires at least twice the amount of memory available as the data you are receiving. For example, if you are receiving a 30K application, you must have at least 60K free.

P D T 8 1 0 0 S e r i e s

Problem	Cause	Solution
Your PDT 8100 terminal does not accept scan input.	Scanning application is not loaded.	Verify that the unit is loaded with a scanning application. See your System Administrator.
	Unreadable bar code.	Be sure the symbol is not defaced.
	Distance between exit window and bar code is incorrect.	Be sure you are within proper scanning range.
	Terminal is not programmed for the bar code.	Be sure the terminal is programmed to accept the type of bar code you are scanning.
	Terminal is not programmed to generate a beep.	If you are expecting a beep on a good decode and don't hear one, check that the application is set to generate a beep on good decode.
	Battery is low.	If the scanner stops emitting a laser beam when you press the trigger, check your battery level. When the battery is low, the scanner shuts off before the terminal notifies you of the low battery condition. Note: If the scanner is still not reading symbols, contact your distributor or Symbol Technologies.

Q u i c k R e f e r e n c e

END-USER LICENSE AGREEMENT

MICROSOFT WINDOWS FOR POCKET PC
DATA EXCHANGE COMPONENT: MICROSOFT ACTIVESYNC, VERSION 3.1
IMPORTANT-READ CAREFULLY: This End-User License Agreement ("EULA") is a legal agreement between you (either an individual or a single entity) and the manufacturer ("Manufacturer") of the special purpose computing device ("SYSTEM") with which you acquired the Microsoft software product(s) identified above ("SOFTWARE"). The SOFTWARE includes computer software, the associated media, any printed materials, and any "online" or electronic documentation. Any software provided along with the SOFTWARE that is associated with a separate end-user license agreement is licensed to you under the terms of that license agreement. By installing, copying, downloading, accessing, or otherwise using the SOFTWARE, you agree to be bound by the terms of this EULA. If you do not agree to the terms of this EULA, Manufacturer and Microsoft Licensing, Inc. ("MS") are unwilling to license the SOFTWARE to you. In such event, you may not use or copy the SOFTWARE, and you should promptly contact Manufacturer for instructions on return of the unused product(s) in accordance with Manufacturer's return policies.

SOFTWARE LICENSE

The SOFTWARE is protected by copyright laws and international copyright treaties, as well as other intellectual property laws and treaties. The SOFTWARE is licensed, not sold.

1. **GRANT OF LICENSE.** SOFTWARE includes software already installed on the SYSTEM ("SYSTEM Software") and, if included in the SYSTEM package, software contained on the CD-ROM disc labeled "Desktop Software for Microsoft Windows CE Microsoft ActiveSync 3.1" ("Desktop Software"). This EULA grants you the following rights to the SOFTWARE:
 - **SYSTEM Software.** You may use the SYSTEM Software as installed on the SYSTEM.
 - **Desktop Software.** If Desktop Software is included with your SYSTEM, you may install and use the Data Exchange component identified above on one (1) or more computers to exchange information with one (1) or more computing devices that contain a compatible version of the Microsoft Windows CE operating system. For other software component(s) contained in the Desktop Software, you may install and use such components only in accordance with the terms of the printed or online end-user license agreement(s) provided with such component(s). In the absence of an end user license agreement for particular component(s) of the Desktop Software, you may install and use only one (1) copy of such component(s) on the SYSTEM or a single computer with which you use the SYSTEM.
 - **Backup Copy.** If Manufacturer has not included a backup copy of the SYSTEM Software with the SYSTEM, you may make a single backup copy of the SYSTEM Software. You may use the backup copy solely for archival purposes.
 - **Microsoft Outlook 2000.** The following terms apply to your use of Microsoft Outlook 2000 (i) regardless of the information contained in the "Software Installation and Use" section of the online EULA you may install one (1) copy of Microsoft Outlook 2000 on one (1) computer to use, exchange data, share data, access, and interact with the SYSTEM, and (ii) the EULA is between Manufacturer (as defined above) and the end user-not between the PC Manufacturer and end user.

2. DESCRIPTION OF OTHER RIGHTS AND LIMITATIONS.

- **Speech/Handwriting Recognition.** If the SOFTWARE includes speech and/or handwriting recognition component(s), you should understand that speech and handwriting recognition are inherently statistical processes; that recognition errors are inherent in the processes; that it is your responsibility to provide for handling such errors and to monitor the recognition processes and correct any errors. Neither Manufacturer nor its suppliers shall be liable for any damages arising out of errors in the speech and handwriting recognition processes.
- **Limitations on Reverse Engineering, Decompilation, and Disassembly.** You may not reverse engineer, decompile, or disassemble the SOFTWARE, except and only to the extent that such activity is expressly permitted by applicable law notwithstanding this limitation.
- **Single SYSTEM.** The SYSTEM Software is licensed with the SYSTEM as a single integrated product. The SYSTEM Software installed in read-only memory ("ROM") of the SYSTEM may only be used as part of the SYSTEM.
- **Single EULA.** The package for the SYSTEM may contain multiple versions of this EULA, such as multiple translations and/or multiple media versions (e.g., in the user documentation and in the software). Even if you receive multiple versions of the EULA, you are licensed to use only one (1) copy of the SYSTEM Software.
- **Rental.** You may not rent or lease the SOFTWARE.
- **Software Transfer.** You may permanently transfer all of your rights under this EULA only as part of a sale or transfer of the SYSTEM, provided you retain no copies, you transfer all of the SOFTWARE (including all component parts, the media and printed materials, any upgrades or backup copies, this EULA and, if applicable, the Certificate(s) of Authenticity), and the recipient agrees to the terms of this EULA. If the SOFTWARE is an upgrade, any transfer must include all prior versions of the SOFTWARE.
- **Termination.** Without prejudice to any other rights, Manufacturer or MS may terminate this EULA if you fail to comply with the terms and conditions of this EULA. In such event, you must destroy all copies of the SOFTWARE and all of its component parts.

3. UPGRADES AND RECOVERY MEDIA.

- **SYSTEM Software.** If the SYSTEM Software is provided by Manufacturer separate from the SYSTEM on media such as a ROM chip, CD-ROM disc(s) or via Web download or other, means, and is labeled "For Upgrade Purposes Only" or "For Recovery Purposes Only," you may install one copy of such SYSTEM Software onto the SYSTEM as a replacement copy for the existing SYSTEM Software and use it in accordance with Section 1 of this EULA.
- **Desktop Software.** If any Desktop Software component(s) is provided by Manufacturer separate from the SYSTEM on CD-ROM disc(s) or via Web download or other means, and labeled "For Upgrade Purposes Only" or "For Recovery Purposes Only", you may (i) install and use one copy of such component(s) on the computer(s) you use to exchange data with the SYSTEM as a replacement copy for the existing Desktop Software component(s).

Q u i c k R e f e r e n c e

4. **COPYRIGHT.** All title and intellectual property rights in and to the SOFTWARE (including, but not limited to, any images, photographs, animations, video, audio, music, text, and "applets" incorporated into the SOFTWARE), the accompanying printed materials, and any copies of the SOFTWARE, are owned by MS or its suppliers (including Microsoft Corporation). You may not copy the printed materials accompanying the SOFTWARE. All title and intellectual property rights in and to the content which may be accessed through use of the SOFTWARE is the property of the respective content owner and may be protected by applicable copyright or other intellectual property laws and treaties. This EULA grants you no rights to use such content. All rights not specifically granted under this EULA are reserved by MS and its suppliers (including, Microsoft Corporation).
5. **EXPORT RESTRICTIONS.** You agree that you will not export or re-export the SOFTWARE to any country, person, or entity subject to U.S. export restrictions. You specifically agree not to export or re export the SOFTWARE: (i) to any country to which the U.S. has embargoed or restricted the export of goods or services, which as of May 1999 include, but are not necessarily limited to, Cuba, Iran, Iraq, Libya, North Korea, Sudan, Syria, and the Federal Republic of Yugoslavia (including Serbia, but not Montenegro), or to any national of any such country, wherever located, who intends to transmit or transport the products back to such country; (ii) to any person or entity who you know or have reason to know will utilize the SOFTWARE or portion thereof in the design, development, or production of nuclear, chemical, or biological weapons; or (iii) to any person or entity who has been prohibited from participating in U.S. export transactions by any federal agency of the U.S. government.
6. **NOTE ON JAVA SUPPORT.** The SOFTWARE may contain support for programs written in Java. Java technology is not fault tolerant and is not designed, manufactured, or intended for use or resale as online control equipment in hazardous environments requiring fail-safe performance, such as in the operation of nuclear facilities, aircraft navigation or communication systems, air traffic control, direct life support machines, or weapons systems, in which the failure of Java technology could lead directly to death, personal injury, or severe physical or environmental damage. Sun Microsystems, Inc. has contractually obligated Microsoft Corporation to make this disclaimer.
7. **PRODUCT SUPPORT.** Product support for the SOFTWARE is not provided by MS, its parent corporation, Microsoft Corporation, or their affiliates or subsidiaries. For product support, please refer to Manufacturer's support number provided in the documentation for the SYSTEM. Should you have any questions concerning this EULA, or if you desire to contact Manufacturer for any other reason, please refer to the address provided in the documentation for the SYSTEM.

FOR THE LIMITED WARRANTIES AND SPECIAL PROVISIONS PERTAINING TO YOUR PARTICULAR JURISDICTION, PLEASE REFER TO YOUR WARRANTY BOOKLET INCLUDED WITH THIS PACKAGE OR PROVIDED WITH THE SOFTWARE PRINTED MATERIALS.

Ergonomic Recommendations

Caution: In order to avoid or minimize the potential risk of ergonomic injury follow the recommendations below. Consult with your local Health & Safety Manager to ensure that you are adhering to your company's safety programs to prevent employee injury.

- Reduce or eliminate repetitive motion

P D T 8 1 0 0 S e r i e s

- Maintain a natural position
- Reduce or eliminate excessive force
- Keep objects that are used frequently within easy reach
- Perform tasks at correct heights
- Reduce or eliminate vibration
- Reduce or eliminate direct pressure
- Provide adjustable workstations
- Provide adequate clearance
- Provide a suitable working environment
- Improve work procedures.

Regulatory Information

Radio Frequency Interference Requirements

For a Class B Device:

Note: This equipment has been tested and found to comply with the limits for a Class B digital device, pursuant to Part 15 of the FCC rules. These limits are designed to provide reasonable protection against harmful interference in a residential installation. This equipment generates, uses, and can radiate radio frequency energy and, if not installed and used in accordance with the instruction manual, may cause harmful interference to radio communications. However there is no guarantee that interference will not occur in a particular installation. If the equipment does cause harmful interference to radio or television reception, which can be determined by turning the equipment off and on, the user is encouraged to try to correct the interference by one or more of the following measures:

- Re-orient or relocate the receiving antenna
- Increase the separation between the equipment and receiver
- Connect the equipment into an outlet on a circuit different from that to which the receiver is connected
- Consult the dealer or an experienced radio/TV technician for help.

Radio Frequency Interference Requirements - Canada

This device complies with RSS 210 of Industry & Science Canada. Operation is subject to the following two conditions: (1) this device may not cause harmful interference and (2) this device must accept any interference received, including interference that may cause undesired operation.

This Class B digital apparatus complies with Canadian ICES-003.

Cet appareil numérique de la classe B est conforme à la norme NMB-003 du Canada.

Power Supply

Note: Use only a Symbol-approved power supply (*p/n 50-14000-107*) output rated 9 Vdc and minimum 2A. The power supply is certified to EN60950 with SELV outputs.

Hinweis: Benutzen Sie nur eine Symbol Technologies genehmigt Stromversorgung (*p/n 50-14000-107*) in den Ausgabe: 9 Vdc und minimum 2A. Die Stromversorgung ist bescheinigt nach EN60950 mit SELV Ausgaben.

Q u i c k R e f e r e n c e

CE Marking and European Union Compliance



Products intended for sale within the European Union are marked with the CE Mark which indicates compliance to applicable Directives and European Normes (EN), as follows. Amendments to these Directives or ENs are included:

Applicable Directives

- Electromagnetic Compatibility Directive 89/336/EEC
- Low Voltage Directive 73/23/EEC.

Applicable Standards

- EN 55022:1998, Limits and Methods of Measurement of Radio Disturbance Characteristics of Information Technology Equipment
- EN 55024:1998; Information Technology Equipment - Immunity characteristics - Limits and methods of measurement
- IEC 1000-4-2:1995; Electromagnetic compatibility (EMC); Part 4: Testing and measurement techniques; Section 4.2: Electrostatic discharge immunity test
- IEC 1000-4-3:1997; Electromagnetic Compatibility (EMC); Part 4: Testing and measurement techniques; Section 3. Radiated, radio frequency, electromagnetic field immunity test
- IEC 1000-4-4:1995; Electromagnetic compatibility (EMC); Part 4: Testing and measurement techniques; Section 4: Testing electrical fast transient,/Burst immunity
- IEC 1000-4-5:1995; Electromagnetic compatibility (EMC), Part 4: Testing and measurement techniques; Section 5: Surge Immunity
- IEC 1000-4-6:1996; Electromagnetic compatibility (EMC), Part 4: Testing and measurement techniques; Section 6: Immunity to conducted disturbances, induced by radio frequency fields
- IEC 1000-4-11:1994; Electromagnetic compatibility (EMC), Part 4: Testing and measurement techniques; Section 11: Voltage Dips, Short Interruptions, and Voltage Variations
- EN 60950 + A1+A2+A3+A4+A11 - Safety of Information Technology Equipment Including Electrical Business Equipment
- EN 60825 - Safety of Devices Containing Lasers.

GSM Regulatory Warnings

Emergency Calls

Please contact your service provider for information about the availability of Emergency Calls.

The GSM version supports Emergency Calls with or without a SIM card fitted. However, as for any other voice call, you must be registered on a GSM network. If you are outside the coverage of a GSM network, or another factor such as insufficient power occurs, then Emergency Call will not work.

The procedure for generating an Emergency Call will depend on the application/ service currently in use and the network you are connected to. It is recommended that you familiarize yourself with the appropriate procedures required to generate an Emergency Call.

When connected to the Emergency Operator you should have details of your telephone number and location on hand.

P D T 8 1 0 0 S e r i e s

Safety Information

The GSM version gives off radio frequency signals in the 900 MHz, 1800 MHz and 1900 MHz frequency bands. The following recommendations are in line with guidelines concerning public exposure to radio frequency electromagnetic energy, issued by various European and International agencies.

Unlike a mobile phone, the transmitter antenna on the GSM version would not (under normal circumstances) be close to the head, and therefore high field strength is not usually encountered. The use of the GSM version is similar to using a mobile phone with a hands-free unit. However, take care to avoid placing any part of your body in proximity to the GSM version antenna when the GSM radio is switched on. In particular, it is recommended that you do not grasp the antenna while the GSM version is operating as this will not only significantly degrade its performance, but also expose your hand to the maximum radio frequency power emitted by the GSM version.

Safety on the Road

The GSM version should not be used by the driver of a vehicle when in motion. Always safely park your vehicle before turning your attention to your device. Always adequately secure your device in a moving vehicle, and do not leave it loose on a passenger seat. Remember that in the event of a sudden stop an unsecured device could cause injury to any occupants as well as damage to the vehicle. If your vehicle has an airbag, do not place any objects, including your device, in the area around the airbag or where the airbag deploys. Any item propelled by an activated airbag could cause serious injury and damage.

When receiving calls on a public highway, mobile units are not permitted to use "warning" devices, which permit the vehicles' horn to sound or the light to flash.

Safety on Aircraft

You are required by law to switch off all electrical apparatus when boarding and leaving an aircraft and at any other time when instructed to do so by a member of the crew. You are not allowed to use any mobile phone, as well as the GSM version, at any time when on board an aircraft, as such use may constitute a danger. In such circumstances please ensure that your GSM version is switched off, disabling attempts to log onto networks.

Pacemakers

It is recommended by pacemaker manufacturers that a minimum of 20cm (8 inches) be maintained between a handheld wireless phone and a pacemaker to avoid any possible interference with the pacemaker. These recommendations are consistent with the independent research by and recommendations of Wireless Technology Research.

Persons with pacemakers:

- Should always keep the phone more than 20cm (8 inches) from their pacemaker when the phone is turned on
- Should not carry the phone in a breast pocket
- Should use the ear opposite the pacemaker to minimize the potential for interference.

If you have any reason to suspect that interference is taking place turn off the GSM version immediately. This may be achieved most rapidly by switching off the device using its on/off button.

Q u i c k R e f e r e n c e

Hearing Aids

Some digital wireless phones may interfere with some hearing aids. In the event of such interference you may want to consult your hearing aid supplier to discuss solutions.

Other Medical Devices

The GSM version transmits radio frequency energy and as such has the potential to interfere with inadequately protected medical devices. Consult your physician or the manufacturer of the device to see if any particular device has sufficient protection. It is good practice to completely turn off the GSM version within a hospital or other medical facility where sensitive medical equipment is in use. In some countries, this is a legal requirement applying to all mobile phones and related equipment.

Effect on Vehicles

RF signals may affect improperly installed or inadequately shielded electronic systems in motor vehicles (including safety systems). Check with the manufacturer or its representative regarding your vehicle. You should also consult the manufacturer of any equipment that has been added to your vehicle.

Posted Facilities

Switch off the GSM version in any facility where posted notices require mobile phones to be switched off.

Potentially Hazardous Atmospheres

Do not take a GSM version into any area with a potentially hazardous atmosphere. The GSM version is not rated for use in such environments and therefore such use may pose a threat of explosion.

Such areas are often, but not always, clearly marked. They may include below decks on boats; chemical transfer or storage facilities; fuel filling stations; areas where fuel odors are present such as in a tent or caravan where cooking or heating by bottled gas is taking place; fuel transfer or storage facilities; vehicles using liquid petroleum gas (lpg); areas where the air contains concentrations of grain, dust or metal powders; and any area where you would normally be advised to turn off your vehicle engine.

Blasting Areas

To avoid interference with any blasting operations, turn off your GSM version when in a blasting area and other areas where the use of radio equipment is prohibited. Obey all signs and instructions.

Laser Devices

Symbol products using lasers comply with US 21CFR1040.10, and IEC825-1:1993, EN60825-1:1994+A11:1996. The laser classification is marked on one of the labels on the product.

Class 1 Laser devices are not considered to be hazardous when used for their intended purpose. The following statement is required to comply with US and international regulations:

Caution: Use of controls, adjustments or performance of procedures other than those specified herein may result in hazardous laser light exposure.

Class 2 laser scanners use a low power, visible light diode. As with any very bright light source, such as the sun, the user should avoid staring directly into the light beam.

Momentary exposure to a Class 2 laser is not known to be harmful.

P D T 8 1 0 0 S e r i e s

Scanner Labeling

<p>CAUTION</p> <p>LASER LIGHT: DO NOT STARE INTO BEAM 630nm-680nm LASER 1.0 MILLIWATT MAX OUTPUT CLASS II LASER PRODUCT</p> 	<p>LASER LIGHT DO NOT STARE INTO BEAM CLASS II LASER PRODUCT LASERSTRAHLUNG NICHT IN DEN STRAHL BLICKEN LASERKLASSE 2 LUMIÈRE LASER NE PAS REGARDER DANS LE FAISCEAU APPAREIL À LASER DE CLASSE 2 630 - 680nm, 1mW</p>
<p>SEE QUICK REFERENCE GUIDE FOR PATENT COVERAGE AND LISTING</p>	
<p>COMPLIES WITH 21CFR1040.10, IEC 60825-1:1996-01/EN60825-1:1994 + A11:1996 *DANGER - Laser light when open. AVOID DIRECT EYE EXPOSURE ATTENTION - LUMIÈRE LASER EN CAS D'OUVERTURE. EXPOSITION DANGEREUSE AU FAISCEAU VORSICHT - LASERLICHT, WENN ABDECKUNG GEÖFFNET, NICHT DEM STRAHL AUSSETZEN*</p>	

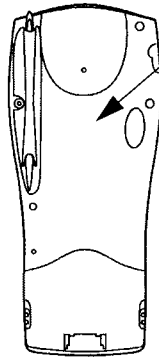

Q u i c k R e f e r e n c e

In accordance with Clause 5, IEC 825 and EN60825, the following information is provided to the user:



<p>ENGLISH CLASS 1 CLASS 2 CLASS 1 CLASS 2</p>	<p>CLASS 1 LASER PRODUCT LASER LIGHT DO NOT STARE INTO BEAM CLASS 2 LASER PRODUCT</p>	<p>HEBREW</p>	<p>מוצר לייזר רמה 1 רמה 1 אור לייזר רמה 2 אין להביט אל תוך הורם מוצר לייזר רמה 2</p>
<p>DANISH / DANSK KLASSE 1 KLASSE 2 KLASSE 1 KLASSE 2</p>	<p>KLASSE-1 LASERPRODUKT LASERLYF SE IKKE IND I STRÅLEN KLASSE-2 LASERPRODUKT</p>	<p>ITALIAN / ITALIANO CLASSE 1 CLASSE 2 CLASSE 1 CLASSE 2</p>	<p>PRODOTTO AL LASER DI CLASSE 1 LUCE LASER NON FISSARE IL RAGGIOPRODOTTO AL LASER DI CLASSE 2</p>
<p>DUTCH / NEDERLANDS KLASSE 1 KLASSE 2 KLASSE 1 KLASSE 2</p>	<p>KLASSE-1 LASERPRODUKT LASERLICHT NIET IN STRAAL STAREN KLASSE-2 LASERPRODUKT</p>	<p>NORWEGIAN / NORSK KLASSE 1 KLASSE 2 KLASSE 1 KLASSE 2</p>	<p>LASERPRODUKT, KLASSE 1 LASERLYS IKKE STIRR INN I LYSSTRÅLEN LASERPRODUKT, KLASSE 2</p>
<p>FINNISH / SUOMI LUOKKA 1 LUOKKA 2 LUOKKA 1 LUOKKA 2</p>	<p>LUOKKA 1 LASERTUOTE LASERVALO ÄLÄ TUJOTA SÄDETTÄ LUOKKA 2 LASERTUOTE</p>	<p>PORTUGUESE / PORTUGUÊS CLASSE 1 CLASSE 2 CLASSE 1 CLASSE 2</p>	<p>PRODUTO LASER DA CLASSE 1 LUZ DE LASER NÂO FIXAR O RAIO LUMINOSO PRODUTO LASER DA CLASSE 2</p>
<p>FRENCH / FRANÇAIS CLASSE 1 CLASSE 2 CLASSE 1 CLASSE 2</p>	<p>PRODUIT LASER DE CLASSE 1 LUMIERE LASER NE PAS REGARDER LE RAYON FIXEMENT PRODUIT LASER DE CLASSE 2</p>	<p>SPANISH / ESPAÑOL CLASE 1 CLASE 2 CLASE 1 CLASE 2</p>	<p>PRODUCTO LASER DE LA CLASE 1 LUZ LASER NO MIRE FIJAMENTE EL HAZ PRODUCTO LASER DE LA CLASE 2</p>
<p>GERMAN / DEUTCH KLASSE 1 KLASSE 2 KLASSE 1 KLASSE 2</p>	<p>LASERPRODUKT DER KLASSE 1 LASERSTRAHLEN NICHT DIREKT IN DEN LASERSTRAHL SCHAUEN LASERPRODUKT DER KLASSE 2</p>	<p>SWEDISH / SVENSKA KLASS 1 KLASS 2 KLASS 1 KLASS 2</p>	<p>LASERPRODUKT KLASS 1 LASERLJUS STIRRA INTE MOT STRÅLEN LASERPRODUKT KLASS 2</p>

RF Devices

Symbol's RF products are designed to be compliant with the rules and regulations in the locations into which they are sold and will be labeled as required. The majority of Symbol's RF devices are type approved and do not require the user to obtain license or authorization before using the equipment. Any changes or modifications to Symbol Technologies equipment not expressly approved by Symbol Technologies could void the user's authority to operate the equipment.

The Spectrum24 equipment is intended for use throughout the European Economic Area, but its authorization for use in France is restricted as follows:

- **PAN European Frequency Range:** 2.400 - 2.4835 GHz, identified by -EU suffix to the model number found on the product label

Q u i c k R e f e r e n c e

DECLARATION OF CONFORMITY

We, Symbol Technologies, Inc.
of One Symbol Plaza, Holtsville, NY 11742-1300, USA

declare under our sole responsibility that the product(s)
Spectrum24, LA3021, Type II Radio Card
Spectrum24HR, LA4111, Type II Radio Card
Spectrum24HR, LA4121, Type II Radio Card

to which this declaration relates, is in conformity with the following standards and/or other normative documents.
ETS 300 328 (November 1996)
ETS 300 826 (November 1997)
EN 60950: 1992 Incl Amdt 1-4, 11

We hereby declare that all essential radio test suites have been carried out and that the above named product(s) is in conformity with all the essential requirements of Directive 1999/5/EC.

The conformity assessment procedure referred to in Article 10(5) and detailed in Annex IV of Directive 1999/5/EC has been followed with the involvement of the following Notified Body(ies):
BABT, Claremont House, 34 Molesey Road, Walton-on-Thames, KT12 4RQ

Identification mark: 0168 The equipment will also carry the Class 2 equipment identifier 

The technical documentation relevant to the above equipment can be made available for inspection on application to:
Symbol Technologies EMEA, Symbol Place, Winnersh Triangle, Berkshire, RG 41 5TP, UK

Dornu Narnor
(name)

Director, Regulatory and Technical Sales
(title)

(signature of authorised person)

3, May 2000
(date)

P D T 8 1 0 0 S e r i e s

Q u i c k R e f e r e n c e

Warranty

Symbol Technologies, Inc. ("Symbol") manufactures its hardware products in accordance with industry-standard practices. Symbol warrants that for a period of twelve (12) months from date of shipment, products will be free from defects in materials and workmanship.

This warranty is provided to the original owner only and is not transferable to any third party. It shall not apply to any product (i) which has been repaired or altered unless done or approved by Symbol, (ii) which has not been maintained in accordance with any operating or handling instructions supplied by Symbol, (iii) which has been subjected to unusual physical or electrical stress, misuse, abuse, power shortage, negligence or accident or (iv) which has been used other than in accordance with the product operating and handling instructions. Preventive maintenance is the responsibility of customer and is not covered under this warranty.

Wear items and accessories having a Symbol serial number will carry a 90-day limited warranty. Non-serialized items will carry a 30-day limited warranty.

Warranty Coverage and Procedure

During the warranty period, Symbol will repair or replace defective products returned to Symbol's manufacturing plant in the US. For warranty service in North America, call the Symbol Support Center at 1-800-653-5350. International customers should contact the local Symbol office or support center. If warranty service is required, Symbol will issue a Return Material Authorization Number. Products must be shipped in the original or comparable packaging, shipping and insurance charges prepaid. Symbol will ship the repaired or replacement product freight and insurance prepaid in North America. Shipments from the US or other locations will be made F.O.B. Symbol's manufacturing plant.

Symbol will use new or refurbished parts at its discretion and will own all parts removed from repaired products. Customer will pay for the replacement product in case it does not return the replaced product to Symbol within 3 days of receipt of the replacement product. The process for return and customer's charges will be in accordance with Symbol's Exchange Policy in effect at the time of the exchange.

Customer accepts full responsibility for its software and data including the appropriate backup thereof.

Repair or replacement of a product during warranty will not extend the original warranty term.

Symbol's Customer Service organization offers an array of service plans, such as on-site, depot, or phone support, that can be implemented to meet customer's special operational requirements and are available at a substantial discount during warranty period.

General

Except for the warranties stated above, Symbol disclaims all warranties, express or implied, on products furnished hereunder, including without limitation implied warranties of merchantability and fitness for a particular purpose. The stated express warranties are in lieu of all obligations or liabilities on part of Symbol for damages, including without limitation, special, indirect, or consequential damages arising out of or in connection with the use or performance of the product. Seller's liability for damages to buyer or others resulting from the use of any product, shall in no way exceed the purchase price of said product, except in instances of injury to persons or property. Some states (or jurisdictions) do not allow the exclusion or limitation of incidental or consequential damages, so the preceding exclusion or limitation may not apply to you.

Service Information

Before you use the unit, it must be configured to operate in your facility's network and run your applications.

If you have a problem running your unit or using your equipment, contact your facility's Technical or Systems Support. If there is a problem with the equipment, they will contact the Symbol Support Center:

United States ¹	1-800-653-5350 1-631-738-2400	Canada	905-629-7226
United Kingdom	0800 328 2424	Asia/Pacific	337-6588
Australia	1-800-672-906	Austria/Österreich	1-505-5794
Denmark/Danmark	7020-1718	Finland/Suomi	9 5407 580
France	01-40-96-52-21	Germany/Deutschland	6074-49020
Italy/Italia	2-484441	Mexico/México	5-520-1835
Netherlands/Nederland	315-271700	Norway/Norge	66810600
South Africa	11-4405668	Spain/España	+913244000
Sweden/Sverige	84452900		
Latin America Sales Support	1-800-347-0178 Inside US +1-561-483-1275 Outside US		
Europe/Mid-East Distributor Operations	Contact local distributor or call +44 208 945 7360		

¹Customer support is available 24 hours a day, 7 days a week.

For the latest version of this guide go to:<http://www.symbol.com/manuals>.

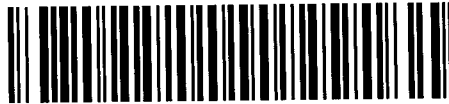

72-52269-01
Revision A — June 2001

Symbol Technologies, Inc. One Symbol Plaza Holtsville, NY 11742-1300