

© 2006 SYMBOL TECHNOLOGIES, INC. All rights reserved.

Symbol reserves the right to make changes to any product to improve reliability, function, or design. Symbol does not assume any product liability arising out of, or in connection with, the application or use of any product, circuit, or application described herein. No license is granted, either expressly or by implication, estoppel, or otherwise under any patent right or patent, covering or relating to any combination, system, apparatus, machine, material, method, or process in which Symbol products might be used. An implied license exists only for equipment, circuits, and subsystems contained in Symbol products.

Symbol and the Symbol logo are registered trademarks of Symbol Technologies, Inc. Other product names mentioned in this manual may be trademarks or registered trademarks of their respective companies and are hereby acknowledged.

Symbol Technologies, Inc.
One Symbol Plaza
Holtsville, N.Y. 11742-1300
<http://www.symbol.com>

Patents

This product is covered by one or more of the patents listed on the website:
<http://www.symbol.com/patents>.

Warranty

Subject to the terms of Symbol's hardware warranty statement, the WT4070/90 wearable terminal is warranted against defect in workmanship and materials for a period of twelve months from the date of shipment. For the complete Symbol hardware product warranty statement, go to: <http://www.symbol.com/warranty>.



72-86718-01
Revision A — August 2006

Ergonomic Recommendations

CAUTION In order to avoid or minimize the potential risk of ergonomic injury follow the recommendations below. Consult with your local Health & Safety Manager to ensure that you are adhering to your company's safety programs to prevent employee injury.

- Reduce or eliminate repetitive motion
- Maintain a neutral postures
- Reduce or eliminate excessive force
- Keep objects that are used frequently within easy reach
- Perform tasks at correct heights
- Reduce or eliminate vibration
- Reduce or eliminate direct pressure
- Provide adjustable workstations
- Provide adequate clearance
- Provide a suitable working environment
- Improve work procedures
- Alternate hands whenever possible when performing a repetitive task.

Regulatory Information

All Symbol devices are designed to be compliant with rules and regulations in locations they are sold and will be labeled as required.

Regulatory Information is available in French, Italian, German, Spanish (Spain), Portuguese, Japanese, Korean, Russian and Simplified Chinese. Please see following website:

<http://www.symbol.com/services/manuals/> and look for your specific product.

Any changes or modifications to Symbol Technologies equipment, not expressly approved by Symbol Technologies, could void the user's authority to operate the equipment.

CAUTION Only use Symbol approved and UL Listed accessories, battery packs and battery chargers.

Do NOT attempt to charge damp/wet mobile computers or batteries. All components must be dry before connecting to an external power source.

This product contains Bluetooth® Complimentary Subsystems:

- BT ID: B02413
- BT ID: B01825

Country Approvals

Regulatory markings are applied to the device signifying the radio(s) are approved for use in the following countries: United States, Canada, Australia, New Zealand and Europe ^{1,2}.

Please refer to the Symbol Declaration of Conformity (DoC) for details of other country markings. This is available at <http://www2.symbol.com/doc/>.

Note¹: For 2.4GHz Products: Europe includes, Austria, Belgium, Czech Republic, Croatia, Cyprus, Denmark, Estonia, Finland, France, Germany, Greece, Hungary, Iceland, Ireland, Italy, Latvia, Liechtenstein, Lithuania, Luxembourg, Malta, Netherlands, Norway,

Poland, Portugal, Slovak Republic, Slovenia, Spain, Sweden, Switzerland and the United Kingdom.

CAUTION Operation of the device without regulatory approval is illegal.

Warnings for Use of Wireless Devices

Please observe all warning notices with regard to the usage of wireless devices.

Potentially Hazardous Atmospheres

You are reminded of the need to observe restrictions on the use of radio devices in fuel depots, chemical plants etc. and areas where the air contains chemicals or particles (such as grain, dust, or metal powders) and any other area where you would normally be advised to turn off your vehicle engine.

Safety in Aircraft

Switch off your wireless device whenever you are instructed to do so by airport or airline staff. If your device offers a 'flight mode' or similar feature, consult airline staff as to its use in flight.

Safety in Hospitals

Wireless devices transmit radio frequency energy and may affect medical electrical equipment.

Wireless devices should be switched off wherever you are requested to do so in hospitals, clinics or healthcare facilities. These requests are designed to prevent possible interference with sensitive medical equipment.

Pacemakers

Pacemaker manufacturers recommended that a minimum of 15 cm (6 inches) be maintained between a handheld wireless device and a pacemaker to avoid potential interference with the pacemaker. These recommendations are consistent with independent research and recommendations by Wireless Technology Research.

Persons with Pacemakers

- Should ALWAYS keep the device more than 15cm (6 inches) from their pacemaker when turned ON.
- Should not carry the device in a breast pocket.
- Should use the ear furthest from the pacemaker to minimize the potential for interference.
- If you have any reason to suspect that interference is taking place, turn OFF your device.

Hearing Aids

The wireless device may interfere with some hearing aids. In the event of interference you may want to consult your hearing aid supplier to discuss solutions.

Other Medical Devices

Please consult your physician or the manufacturer of the medical device, to determine if the operation of your wireless product may interfere with the medical device.

FCC / EU RF Exposure Guidelines

Safety Information

The device complies with Internationally recognized standards covering Specific Absorption Rate (SAR) related to human exposure to electromagnetic fields from radio devices.

Reducing RF Exposure - Use Properly

It is advisable to use the device only in the normal operating position.

Wearable Devices

This device was tested for typical body-worn operation. Use only Symbol tested and approved belt-clips, holsters, and similar accessories to ensure FCC Compliance. The use of third-party belt-clips, holsters, and similar accessories may not comply with FCC RF exposure compliance requirements, and should be avoided.

Laser Devices

Complies with 21CFR1040.10 and 1040.11 except for deviations pursuant to Laser Notice No. 50, dated July 26, 2001, and with EN60825-1:1994+A1:2002+A2:2001 and IEC60825-1:1993+A1:1997+A2:2001.

The laser classification is marked on one of the labels on the device.

Class 1 Laser devices are not considered to be hazardous when used for their intended purpose. The following statement is required to comply with US and international regulations:

Caution: Use of controls, adjustments or performance of procedures other than those specified herein may result in hazardous laser light exposure.

Class 2 laser scanners use a low power, visible light diode. As with any very bright light source, such as the sun, the user should avoid staring directly into the light beam. Momentary exposure to a Class 2 laser is not known to be harmful.

COMPLIES WITH 21CFR1040.10AND 1040.11 EXCEPT FOR DEVIATIONS PURSUANT TO LASER NOTICE NO. 50, DATED JULY 26, 2001, AND WITH EN60825-1:1994+A1:2002+A2:2001 and IEC60825-1:1993+A1:1997+A2:2001. THIS CLASS B DIGITAL APPARATUS COMPLIES WITH CANADIAN ICES-103. CET APPAREIL NUMERIQUE DE LA CLASSE B EST CONFORME A LA NORME NMB-003 DU CANADA.



Batteries

Please follow the local regulations when disposing of re-chargeable batteries.

Taiwan - Recycling



EPA (Environmental Protection Administration) requires dry battery producing or importing firms in accordance with Article 15 of the Waste Disposal Act are required to indicate the recycling marks on the batteries used in sales, giveaway or promotion. Contact a qualified Taiwanese recycler for proper battery disposal.

Wireless Devices - Countries

Country Roaming

This device incorporates the International Roaming feature (IEEE802.11d) which will ensure the product operates on the correct channels for the particular country of use.

Radio Frequency Interference Requirements-FCC



Note: This equipment has been tested and found to comply with the limits for a Class B digital device, pursuant to Part 15 of the FCC rules. These limits are designed to provide reasonable protection against harmful interference in a residential installation. This equipment generates, uses and can radiate radio frequency energy and, if not installed and

used in accordance with the instructions, may cause harmful interference to radio communications. However there is no guarantee that interference will not occur in a particular installation. If this equipment does cause harmful interference to radio or television reception, which can be determined by turning the equipment off and on, the user is encouraged to try to correct the interference by one or more of the following measures:

- Reorient or relocate the receiving antenna
- Increase the separation between the equipment and receiver
- Connect the equipment into an outlet on a circuit different from that to which the receiver is connected
- Consult the dealer or an experienced radio/TV technician for help.

Radio Transmitters (Part 15)

This device complies with Part 15 of the FCC Rules. Operation is subject to the following two conditions: (1) this device may not cause harmful interference, and (2) this device must accept any interference received, including interference that may cause undesired operation.

Radio Frequency Interference Requirements - Canada

This Class B digital apparatus complies with Canadian ICES-003.

Cet appareil numérique de la classe B est conforme à la norme NMB-003 du Canada.

Radio Transmitters

This device complies with RSS 210 of Industry & Science Canada. Operation is subject to the following two conditions: (1) this device may not cause harmful interference and (2) this device must accept any interference received, including interference that may cause undesired operation.

Label Marking: The Term "IC:" before the radio certification only signifies that Industry Canada technical specifications were met.

CE Marking and European Economic Area (EEA)

The use of 2.4 GHz RLAN's, for use through the EEA, have the following restrictions:

- Maximum radiated transmit power of 100 mW EIRP in the frequency range 2.400 -2.4835 GHz
- France, outside usage is restricted to 2.4 - 2.454 GHz.
- Italy requires a user license for outside usage.

Bluetooth® Wireless Technology for use through the EEA has the following restrictions:

- Maximum radiated transmit power of 100mW EIRP in the frequency range 2.400 -2.4835 GHz
- France, outside usage is restricted to 10mW EIRP
- Italy requires a user license for outside usage.

Statement of Compliance

Symbol Technologies, Inc., hereby, declares that this device is in compliance with the essential requirements and other relevant provisions of Directives 1999/5/EC, 89/336/EEC and 73/23/EEC. Declaration of Conformities may be obtained from <http://www2.symbol.com/doc/>.

Battery Information

Symbol rechargeable battery packs are designed and constructed to the highest standards within the industry.

However, there are limitations to how long a battery can operate or be stored before needing replacement. Many factors affect the actual life cycle of a battery pack, such as heat, cold, harsh environmental conditions and severe drops.

When batteries are stored over six (6) months, some irreversible deterioration in overall battery quality may occur. Store batteries discharged in a dry, cool place, removed from the equipment to prevent loss of capacity, rusting of metallic parts and electrolyte leakage. When storing batteries for one year or longer, they should be charged and discharged at least once a year. If an electrolyte leakage is observed, avoid any contact with affected area and properly dispose of the battery. Batteries must be charged within the 32° to 104° F (0° to +40° C) ambient temperature range.

Replace the battery when a significant loss of run time is detected.

Standard warranty period for all Symbol batteries is 30 days, regardless if the battery was purchased separately or included as part of the mobile computer or bar code scanner. For more information on Symbol batteries, please visit: <http://mysymbolcare.symbol.com/battery/batbasics1.html>

RF Exposure Statement :

This EUT is compliance with SAR for general population / uncontrolled exposure limits in ANSI/IEEE C95.1-1999 and had been tested in accordance with the measurement methods and procedures specified in OET Bulletin 65 Supplement C



Waste Electrical and Electronic Equipment (WEEE)

English: For EU Customers: All products at the end of their life must be returned to Symbol for recycling. For information on how to return product, please go to: http://www.symbol.com/environmental_compliance.

Čeština: Pro zákazníky z EU: Všechny produkty je nutné po skončení jejich životnosti vrátit společnosti Symbol k recyklaci. Informace o způsobu vrácení produktu najdete na webové stránce: http://www.symbol.com/environmental_compliance.

Dansk: Til kunder i EU: Alle produkter skal returneres til Symbol til recirkulering, når de er udtjente. Læs oplysningerne om returnering af produkter på: http://www.symbol.com/environmental_compliance.

Deutsch: Für Kunden innerhalb der EU: Alle Produkte müssen am Ende ihrer Lebensdauer zum Recycling an Symbol zurückgesandt werden. Informationen zur Rücksendung von Produkten finden Sie unter http://www.symbol.com/environmental_compliance.

Eesti: EL klientidele: kõik tooted tuleb nende eluea lõppedes tagastada taaskasutamise eesmärgil Symbol'ile. Lisainformatsiooni saamiseks toote tagastamise kohta külastage palun aadressi: http://www.symbol.com/environmental_compliance.

Español: Para clientes en la Unión Europea: todos los productos deberán entregarse a Symbol al final de su ciclo de vida para que sean reciclados. Si desea más información sobre cómo devolver un producto, visite: http://www.symbol.com/environmental_compliance.

Ελληνικά: Για πελάτες στην Ε.Ε.: Όλα τα προϊόντα, στο τέλος της διάρκειας ζωής τους, πρέπει να επιστρέφονται στην Symbol για ανακύκλωση. Για περισσότερες πληροφορίες σχετικά με την επιστροφή ενός προϊόντος, επισκεφθείτε τη διεύθυνση http://www.symbol.com/environmental_compliance στο διαδίκτυο.

Français : Clients de l'Union Européenne : Tous les produits en fin de cycle de vie doivent être retournés à Symbol pour recyclage. Pour de plus amples informations sur le retour de produits, consultez : http://www.symbol.com/environmental_compliance.

Italiano: per i clienti dell'UE: tutti i prodotti che sono giunti al termine del rispettivo ciclo di vita devono essere restituiti a Symbol al fine di consentirne il riciclaggio. Per informazioni sulle modalità di restituzione, visitare il seguente sito Web: http://www.symbol.com/environmental_compliance.

Latviešu: ES klientiem: visi produkti pēc to kalpošanas mūža beigām ir jānododā atpakaļ Symbol direktorātai pārstrādei. Lai iegūtu informāciju par produktu nododāšanu Symbol, lūdzim, skatīt: http://www.symbol.com/environmental_compliance.

Lietuvių: ES vartotojams: visi gaminiai, pasibaigus jų eksploatacijos laikui, turi būti gražinti utilizuoti į kompaniją „Symbol“. Daugiau informacijos, kaip gražinti gamini, rasite: http://www.symbol.com/environmental_compliance.

Magyar: Az EU-ban vásárlóknak: Minden tönkrement termékét a Symbol vállalathoz kell eljuttatni újrahasznosítás céljából. A termék visszajuttatásának módjával kapcsolatos tudnivalókról látogasson el a http://www.symbol.com/environmental_compliance weboldalra.

Malti: Għal klijenti fl-UE: il-prodotti kollha li jkun wasslu fl-aħthar tal-hajja ta' l-użu tagħhom, iridu jiġu mramati għand Symbol għar-riċiklaġġ. Għal aktar taġrif dwar kif għandek tirritorna l-prodotti, jekk jogħġbok zur: http://www.symbol.com/environmental_compliance.

Nederlands: Voor klanten in de EU: alle producten dienen aan het einde van hun levensduur naar Symbol te worden teruggezonden voor recycling. Raadpleeg http://www.symbol.com/environmental_compliance voor meer informatie over het terugzenden van producten.

Polski: Klienci z obszaru Unii Europejskiej: Produkty wycofane z eksploatacji należy zwrócić do firmy Symbol w celu ich utylizacji. Informacje na temat zwrotu produktów znajdują się na stronie internetowej http://www.symbol.com/environmental_compliance.

Português: Para clientes da UE: todos os produtos no fim de vida devem ser devolvidos à Symbol para reciclagem. Para obter informações sobre como devolver o produto, visite: http://www.symbol.com/environmental_compliance.

Slovenski: Za kupce v EU: vsi izdelki se morajo po poteku življenjske dobe vrniti podjetju Symbol za reciklažo. Za informacije o vračilu izdelka obiščite: http://www.symbol.com/environmental_compliance.

Slovenščina: Pre zăkaznikov z krajaj EU: Všetky výrobky musia byť po uplynutí doby ich životnosti vrátené spoločnosti Symbol na recykláciu. Blíže informácie o vrátení výrobkov nájdete na: http://www.symbol.com/environmental_compliance.

Suomi: Asiakaat Euroopan unionin alueella: Kaikki tuotteet on palautettava kierrätettäväksi Symbol-yhtiöön, kun tuotetta ei enää käytetä. Lisätietoja tuotteen palauttamisesta on osoitteessa http://www.symbol.com/environmental_compliance.

Svenska: För kunder inom EU: Alla produkter som uppnått sin livslängd måste returneras till Symbol för återvinning. Information om hur du returnerar produkten finns på http://www.symbol.com/environmental_compliance.

WRIST MOUNT/WEARABLE TERMINAL INSTALLATION

Wrist Mount Installation

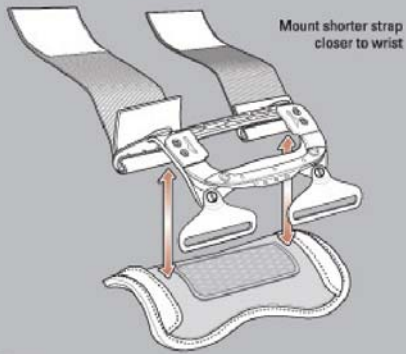

Terminal Installation



Mounting on Left or Right Wrist



Terminal Removal

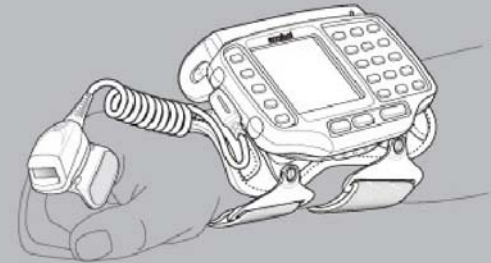
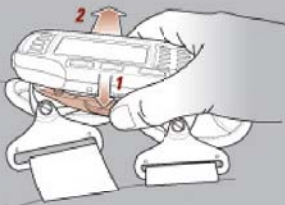

SCANNER FINGER MOUNT

AVOID EXTREME WRIST ANGLES

AVOID BENDING AND REACHING

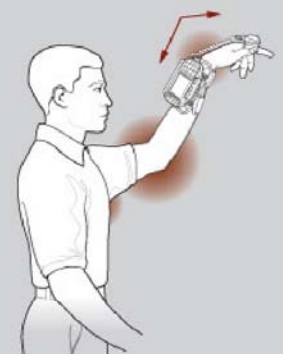
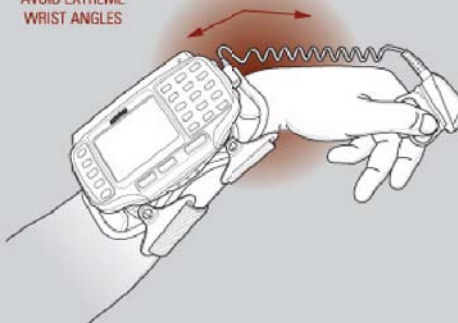
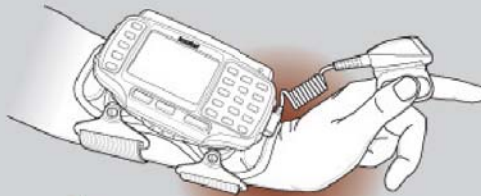
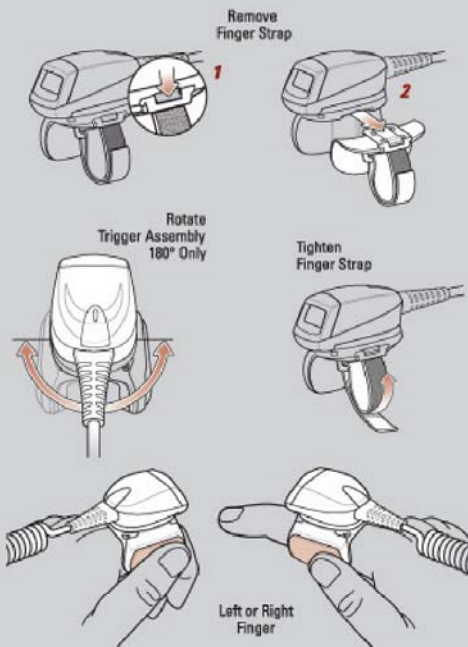

OPTIMUM BODY POSTURE

Low Scanning



Upright Scanning

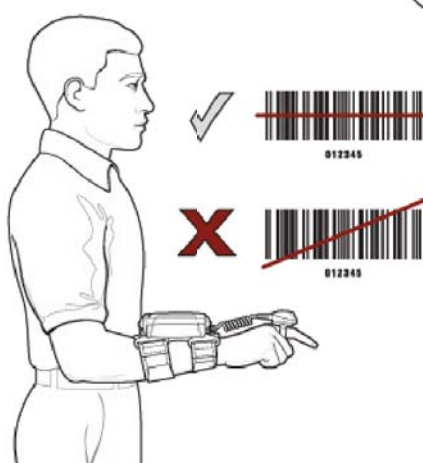

High Scanning

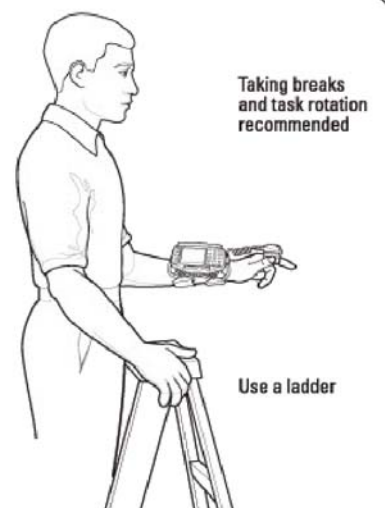

POST IN WORK AREA



72-98717-01
Rev A August 2006

<http://www.symbol.com/wt4090>

© Symbol Technologies, Inc. All rights reserved. Symbol® is a registered trademark and Symbol, The Enterprise Mobility Company, is a trademark of Symbol Technologies, Inc.

WT4070/90

Recommended Usage Guide

symbol
The Enterprise Mobility Company™

WT4070/90

Quick Start Guide

<http://www.symbol.com/wt4090>
See User Guide for more information

FEATURES

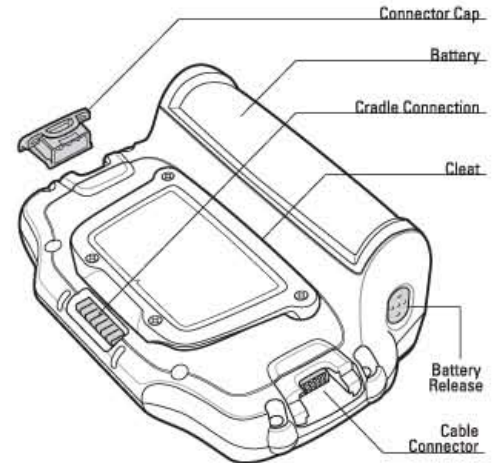

Battery Installation and Removal

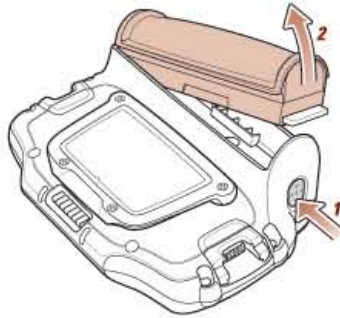
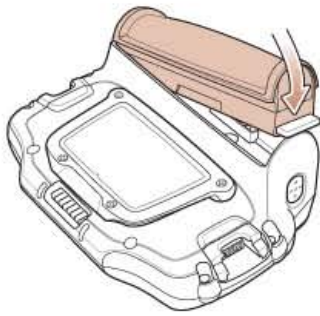

Parts of Wrist Mount

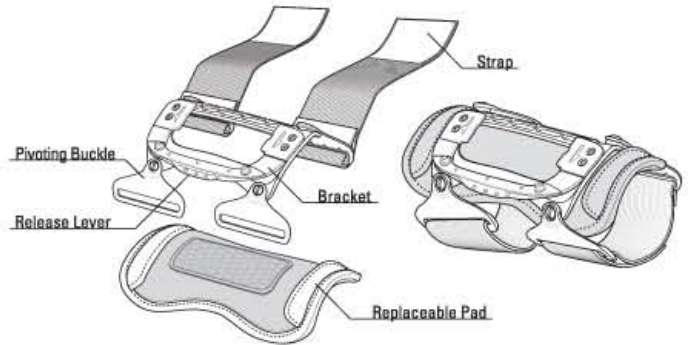

ACCESSORY INSTALLATION

Headset Adapter



Connecting Accessory to Terminal

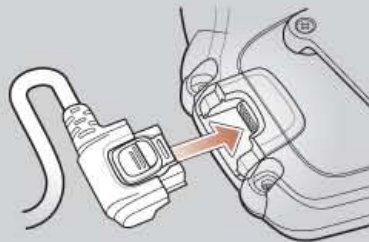

Disconnecting Accessory From Terminal



CHARGING INSTRUCTIONS

☉ = LED Indicator Location Slow Flash = Normal Charge Solid Amber = Full Charge Fast Flash = Charging Error

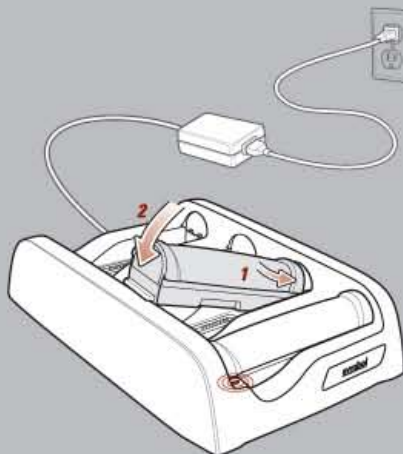

Four Slot Spare Battery Charger

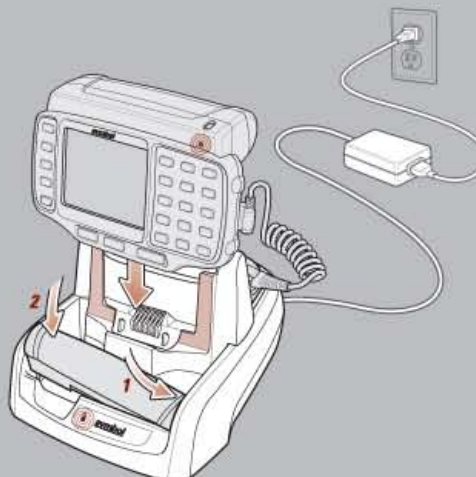

Single Slot USB Cradle

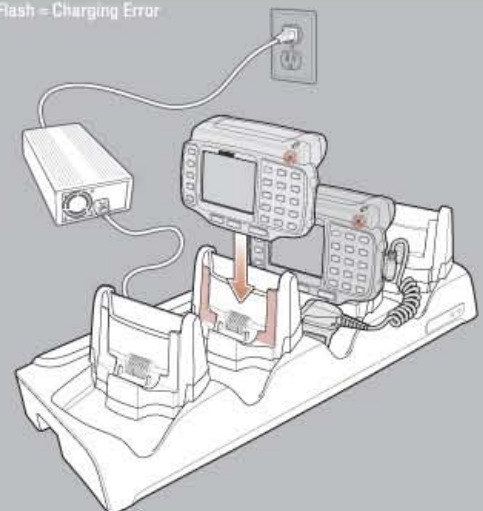

Four Slot Ethernet Cradle