

# **User's Guide**

## **Wireless RF Keyboard & Mouse**

**HQXAKM-7500**

**HQXAGM-9600**





### **R&TTE Compliance Statement**

This equipment complies with all the requirements of the DIRECTIVE 1999/5/EC OF THE EUROPEAN PARLIAMENT AND THE COUNCIL OF 9 March 1999 on radio equipment and telecommunication terminal equipment and the mutual recognition of their conformity (R&TTE).

### **Safety**

This equipment is designed with the utmost care for the safety of those who install and use it. However, special attention must be paid to the dangers of electric shock and static electricity when working with electrical equipment. All guidelines of this manual and of the computer manufacturer must therefore be allowed at all times to ensure the safe use of the equipment.

### **EU Countries Intended for Use**

The ETSI version of this device is intended for home and office use in Austria, Belgium, Denmark, Finland, France, Germany, Greece, Ireland, Italy, Luxembourg, The Netherlands, Portugal, Spain, Sweden, and United Kingdom.

### **EU Countries Not Intended for Use**

None

### **Federal Communications Commission Radio (FCC) Statement**

This equipment has been tested and found to comply with the limits for a Class B digital device, pursuant to Part 15 of the FCC Rules. These limits are designed to provide reasonable protection against harmful interference in a residential installation. This equipment generates, uses, and can radiate radio frequency energy and if not installed and used in accordance with the instruction manual may cause harmful interference to radio communications. However, there is no guarantee that interference will not occur in a particular installation. If this equipment does cause harmful interference to radio or television reception, which can be determined by turning the equipment off and on, the user is encouraged to try to correct the interference by one or more of the following measures:

- Reorient or relocate the receiving antenna.
- Increase the separation between the equipment and receiver.
- Connect the equipment into an outlet on a circuit different from that to which the receiver is connected.
- Consult the dealer or an experienced radio TV technician for help.

Note: the manufacturer is not responsible for any radio or tvinterference caused by unauthorized modifications to this equipment. such modifications could void the user's authority to operate the equipment.

## Table of Contents

<b>INTRODUCTION .....</b>	<b>1</b>
PACKAGE CONTENTS .....	2
SYSTEM REQUIREMENTS.....	2
FEATURES .....	2
<b>MAINBOARD AND MOUSE COMPONENTS .....</b>	<b>3</b>
WIRELESS RF KEYBOARD .....	3
WIRELESS RF MOUSE .....	4
RF RECEIVER.....	4
<b>INSERTING BATTERIES.....</b>	<b>5</b>
MOUSE.....	5
KEYBOARD.....	6
<b>SETTING UP YOUR KEYBOARD AND MOUSE .....</b>	<b>7</b>
<b>INSTALLING THE SOFTWARE.....</b>	<b>9</b>
MOUSE.....	9
KEYBOARD.....	11
<b>USING THE SOFTWARE .....</b>	<b>15</b>
iWARE MOUSE .....	15
MULTIMEDIA KEYBOARD .....	17
<b>TROUBLESHOOTING.....</b>	<b>20</b>
<b>A WORD ABOUT ERGONOMICS .....</b>	<b>22</b>

# Introduction

Congratulations on your purchase of the Wireless RF Keyboard & Mouse, which combines an innovative ergonomic design with all the features and convenience of wireless technology:

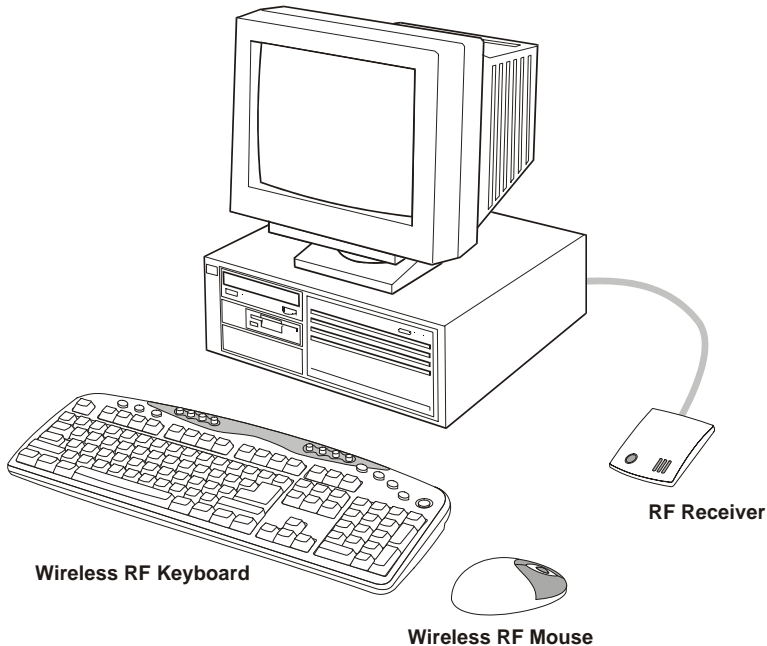

The Wireless RF Keyboard has advanced multimedia features that enable you to play audio CDs, VCDs, DVDs, and MPEG files. You can use the keyboard hot keys to raise, lower and mute audio.

Other hot keys let you open your default Web browser and refresh Web pages, browse forward and backwards, open a search page, and send e-mail. There are also hot keys for launching the Windows calculator and entering power savings mode.

The bundled software further enhances your keyboard by supplying an onscreen display (OSD) and onscreen menus to control audio and Web functions.

The Wireless RF Mouse has a scroll wheel/middle button that can be assigned various functions such as Web page or word processing software scrolling, or launching applications such as Windows Explorer.

## **Package Contents**

After you have unpacked the Wireless RF Keyboard & Mouse, check the contents to make sure the following items are included.

- One Wireless RF Mouse
- One Wireless RF Keyboard
- One RF receiver
- Two AAA alkaline batteries (for the mouse)
- Two AA alkaline batteries (for the keyboard)
- This quick guide

If any of the above items are missing or appear damaged, contact your dealer immediately. Do not throw the shipping carton away in case you need to ship your Wireless RF Keyboard & Mouse.

## **System Requirements**

To use the mouse software and the hot keys on your multimedia keyboard, you need the following:

- Windows ME/2000/98/95/NT 4.0 or later
- PS/2 mouse and keyboard ports
- Sound Blaster compatible sound card (for CD/VCD/DVD, and MPEG operation)
- CD-ROM drive (for software installation and CD/VCD operation)
- DVD-ROM drive (for DVD operation)

## **Features**

- Wireless radio frequency (RF) technology
- Scroll wheel mouse enables scrolling in Web pages and text editors
- Onscreen display (OSD) provides status information
- Keyboard multimedia and Web hot keys provide convenient access to often used commands
- Plug and Play compliant
- Compatible with Windows ME/2000/98/95/NT4.0

# Mainboard and Mouse Components

## Wireless RF Keyboard

The following illustration shows the Wireless RF Keyboard and hot keys:

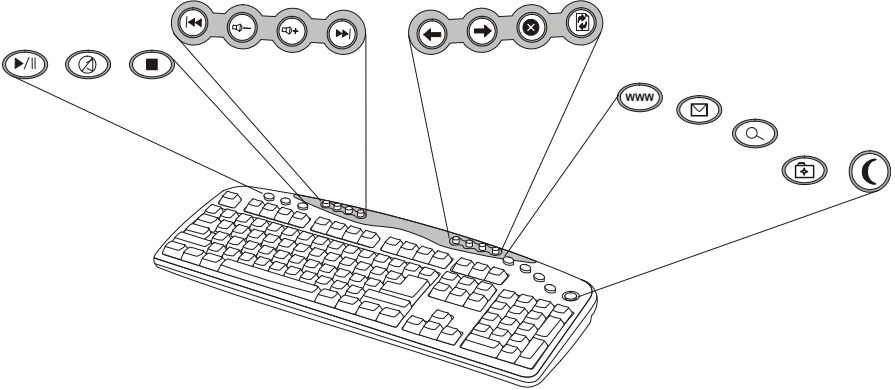

Button	Function	Button	Function
	<b>Play/Pause:</b> plays or pauses a CD/DVD/VCD		<b>Forward:</b> goes to the next page in your Web browser
	<b>Mute:</b> turns off the audio output		<b>Stop:</b> stops loading a Web page
	<b>Stop:</b> stops playing a CD/DVD/VCD		<b>Refresh:</b> reloads the Web page
	<b>Next Track:</b> searches backward through tracks on a CD/DVD/VCD		<b>World Wide Web:</b> opens your default Web browser
	<b>Volume Down:</b> decreases audio volume		<b>E-mail:</b> launches the default e-mail application
	<b>Volume Up:</b> increases audio volume		<b>Search:</b> opens a search window in Netscape or Windows IE
	<b>Previous Track:</b> searches forwards through tracks on a CD/DVD/VCD		<b>My Favorite:</b> opens the IE favorites folder, or the Netscape bookmarks folder
	<b>Back:</b> goes to the previous page in your Web browser		<b>Suspend:</b> enters the computer into power saving mode

## Wireless RF Mouse

The following illustration shows the RF mouse components:

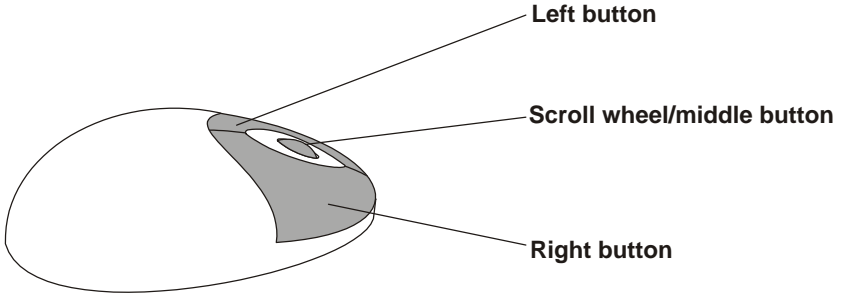

## RF Receiver

The following illustration shows the RF receiver components:

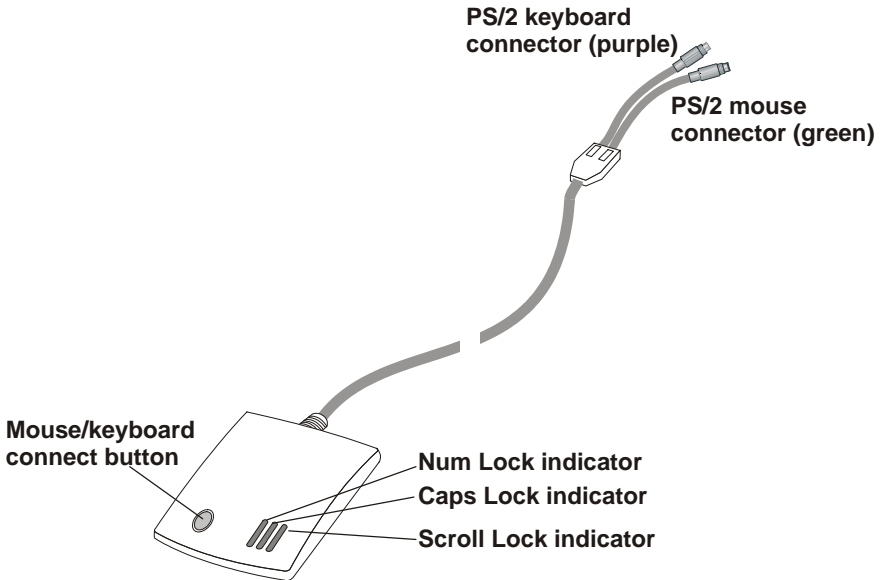



## Inserting Batteries

The keyboard and mouse both require batteries to operate. The mouse uses two AAA batteries and the keyboard uses two AA batteries. Refer to the following instructions and illustrations for inserting the batteries:

### Mouse

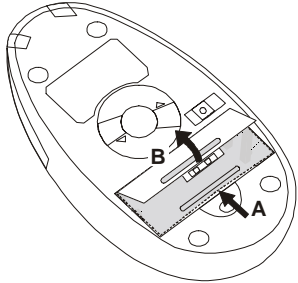
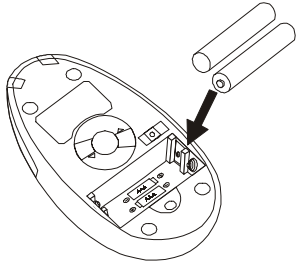
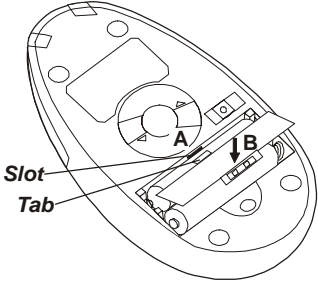
1. Turn the mouse over.	
2. Open the battery compartment. Press the edge (A) with your thumb and pull up (B).	
3. Insert two AAA batteries into the compartment. Ensure that you orient the batteries according to the polarity markings inside the battery compartment.	
4. Replace the battery compartment cover. Insert the tab into the slot (A) and flip the cover into place (B).	

## Keyboard

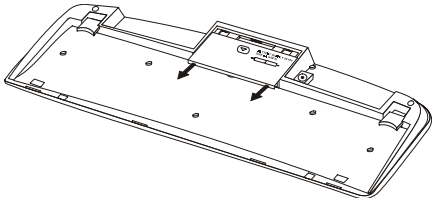
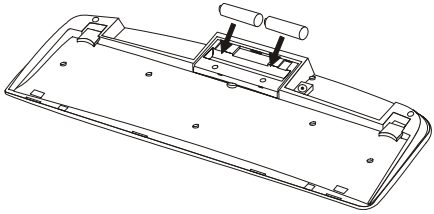
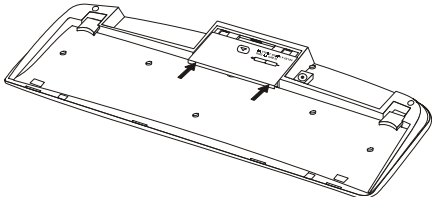
1. Turn the keyboard over.	
2. Open the battery compartment. Slide the cover in the direction of the arrows.	
3. Insert two AA batteries into the compartment. Ensure that you orient the batteries according to the polarity markings inside the battery compartment.	
4. Replace the battery compartment cover.	

# Setting up Your Keyboard and Mouse

Your RF keyboard and mouse connect to the PS/2 keyboard and mouse ports on your computer.

---

**Note!** Insert the keyboard and mouse batteries before setting up the keyboard and mouse. Refer to the previous section.

---

Refer to the following instructions and illustrations to connect the keyboard and mouse to your PC:

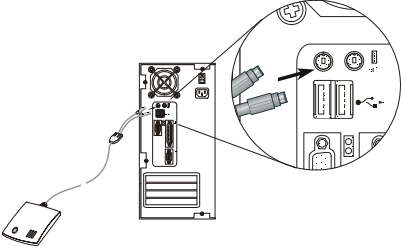
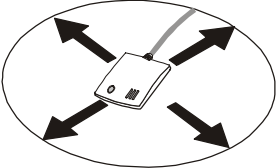
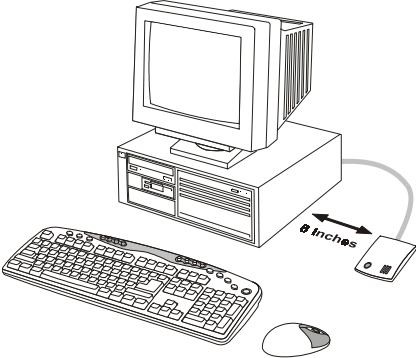
<ol style="list-style-type: none"><li>1. Turn off your computer.</li><li>2. Plug the purple PS/2 connector on the RF receiver cable into the PS/2 keyboard port on your computer.</li><li>3. Plug the green PS/2 connector on the RF receiver cable into the PS/2 mouse port on your computer.</li></ol>	
<ol style="list-style-type: none"><li>4. Place the RF receiver in a good location.</li></ol>	<p>Place the receiver at least 8 inches (20 cm) from electrical devices such as the computer or monitor.</p> 
<ol style="list-style-type: none"><li>5. Place the keyboard and the mouse in the proper location for your computer.</li></ol> <hr/> <p><b>Note!</b> Refer to the section on ergonomics later in the quick guide for more information on setting up your workstation.</p> <hr/>	

6. Turn on the computer.

7. Press the RF receiver connect button (A), and then use a pen tip or bent paper clip to press the keyboard connect switch (B) and the mouse connect switch (C).

---

*Note! Repeat Step 7 when connecting the Wireless RF Keyboard & Mouse for the first time and after replacing the batteries.*

---

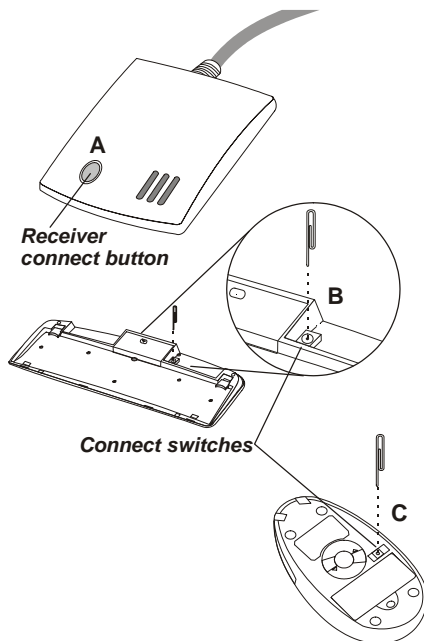

Ensure that the mouse and keyboard are working. If they do not respond to mouse movement or keystrokes, repeat Step 7 to ensure that a connection has been made. If they still are not working, refer to the Troubleshooting section at the end of this guide.

# Installing the Software

The RF mouse and multimedia keyboard come with software to enhance their function. The software is located on the bundled CD.

---

*Note! Connect your Wireless RF Keyboard & Mouse before installing the software. Refer to the previous section.*

---

Insert the software CD into the CD-ROM drive. The autoinstallation screen appears. A menu provides you with the option of installing the mouse and keyboard.

Follow these instructions to install the keyboard and mouse software:





## Mouse

1. From the software CD install menu, click Install Mouse. The iWare mouse installation program starts. Click **Next**.



2. Select "3 Button Wheel Mouse," and click **Next**.



<p>3. Select "PS2 Port" and click <b>Next</b>.</p>	
<p>4. Click <b>Next</b> to accept the default directory or browse to the desired directory.</p>	
<p>5. Click <b>Next</b> to accept the default folder or type a new folder name.</p>	
<p>6. Click <b>Next</b> to start copying files to your computer.</p>	

7. Click **Finish** to complete the installation.



When the computer has restarted, an iWare mouse icon appears in the taskbar.

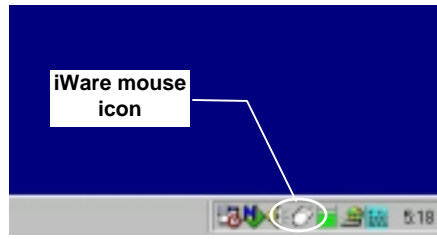

## Keyboard

1. From the software CD install menu, click Install Keyboard. The keyboard installation program starts and you are prompted to choose a setup language. Choose your language and click **Next**.

The MediaKey Setup Wizard begins.

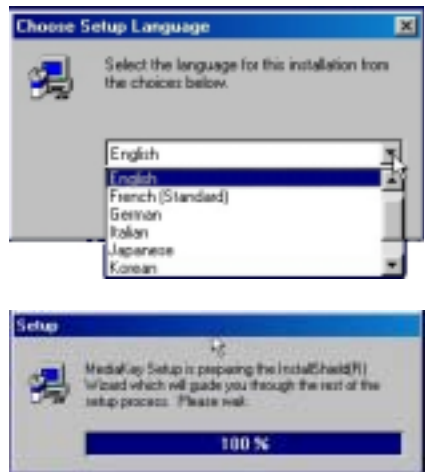

2. Click **Next** to continue the setup program.



3. Read the Software License Agreement and click **Yes**.



4. Enter your name, company name if desired, and your serial number. The serial number is located on the software CD case. Click **Next**.





5. Click **Next** to accept the default location or browse to a new location.



6. Click **Next** to accept the default folder or type a new folder name.



The setup program copies files to the computer.





7. Click **Finish** to complete the installation.

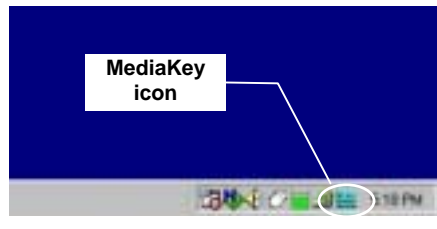

When the setup program has finished installing the multimedia software, a MediaKey icon appears in the taskbar.



## Using the Software

After your computer restarts, the iWare Mouse icon  and the Multimedia Keyboard icon  appear at the lower right side of your screen in the taskbar:

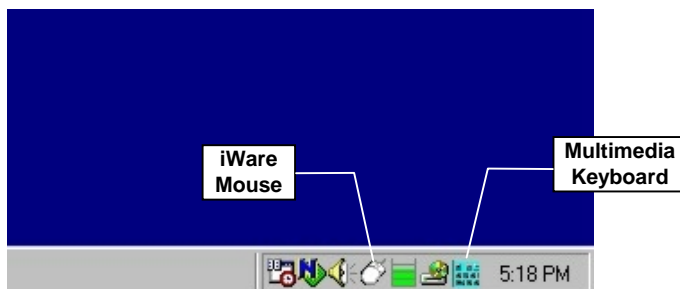

The following sections briefly describe the iWare Mouse and Multimedia Keyboard software. For detailed information on the Multimedia Keyboard software, refer to the Multimedia Keyboard online help.

### iWare Mouse

Double-click the iWare Mouse icon in the taskbar to open the iWare Mouse Setting screen. The following table describes the iWare Settings:

 A screenshot of the 'iWare Settings' window. The window has a title bar 'iWare Settings' and a menu bar 'Wheel   Status   About'. The main area is divided into two sections: 'Wheel Mode' and 'Wheel Speed'. Under 'Wheel Mode', there are two radio buttons: 'System default (Intelli-Mouse mode)' and 'Enhance scroll mode'. Under 'Wheel Speed', there is a 'Speed' slider and two checkboxes: 'Use scroll wheel' (checked) and 'Disable program scroll lock'. At the bottom, there are 'OK', 'Cancel', and 'Apply' buttons.	<h3><u>Wheel Tab</u></h3> <p><b>Wheel Mode</b></p> <p>These two items define the operation of the scroll wheel:</p> <ul style="list-style-type: none"><li>• <b>System default (Intelli-Mouse) mode:</b> this option sets the wheel scrolling function as Microsoft's Intelli-Mouse standard.</li><li>• <b>Enhance scroll mode:</b> enables enhanced scroll mode.</li></ul> <hr/> <p><i>Note! Experiment with these two modes; after some practice, choose the mode to best suit your work habits.</i></p> <hr/>
---	---

	<p><b>Wheel Speed</b></p> <p>These items enable you to set how fast the page scrolls on the screen:</p> <ul style="list-style-type: none"> <li>• <b>Scroll # lines per scroll unit:</b> sets the number of text lines that the page will scroll.</li> <li>• <b>Scroll one page per scroll unit:</b> sets the screen to scroll one complete page at a time.</li> </ul>
--	---

	<p><b>Button Tab</b></p> <p>Enables you to set the middle button function. Choose the function from the drop-down list.</p>
---	---

	<p><b>About Tab</b></p> <p>Provides the iWare software version. Refer to this screen when updating the software to ensure that you have the most recent version.</p>
--	--





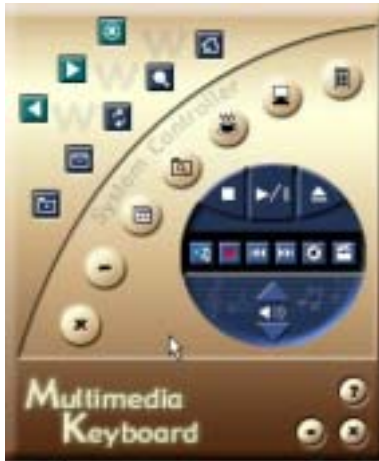

## Multimedia Keyboard

Double-click the Multimedia Keyboard icon  in the taskbar to open the Multimedia Keyboard utility:













The following table briefly describes the button functions:

### Web Browser and File Functions

	<b>WWW Stop:</b> click this button to stop downloading the current Web page.
	<b>WWW Forward:</b> click this button to go to the next Web page.
	<b>WWW Back:</b> click this button to go to the previous Web page.
	<b>WWW Home:</b> click this button to launch the default Internet browser application and go to the default home page.
	<b>WWW Search:</b> in IE 4.X and higher, clicking this button opens a search window. In Netscape 4.X and higher, clicking this button goes to the default search Web site.
	<b>WWW Refresh:</b> click this button to reload the current Web page.

	<b>E-mail:</b> click this button to launch the default mail application.
	<b>WWW Favorite:</b> in IE 4.X and higher, clicking this button opens My Favorites. In Netscape 4.X and higher, clicking this button opens a Bookmark Window.
	<b>Calculator:</b> click this button to open and close the Windows calculator.
	<b>My Computer:</b> click this button to open a My Computer window.
	<b>Screen Saver:</b> click this button to launch the default screen saver.
	<b>File Explorer:</b> click this button to open a file explorer window.
	<b>Switch:</b> click this button to switch between different application windows.
	<b>Minimize Window:</b> click this button to minimize the current window.
	<b>Close Window:</b> click this button to close the current window.
	<b>Help:</b> click this button to launch the Multimedia Keyboard help file.
	<b>Minimize:</b> click this button to send the Multimedia Keyboard Window to the task bar.
	<b>Close:</b> click this button to close the Multimedia Keyboard screen.

## Multimedia Key Functions

	<b>CD Stop:</b> click this button to stop playing a CD/DVD/VCD.
	<b>Play/Pause:</b> click this button to play or pause a CD/DVD/VCD.
	<b>Eject:</b> click this button to eject a CD/DVD/VCD.
	<b>Rewind:</b> click this button to search backward through a CD/DVD/VCD.
	<b>Record:</b> click this button to launch the Microsoft Recorder.
	<b>Pre Track:</b> click this button to go to the previous track on a CD/DVD/VCD.
	<b>Next Track:</b> click this button to go to the next track on a CD/DVD/VCD.
	<b>Mute:</b> click this button to turn off the audio.
	<b>Playlist:</b> click this button to manage your playlists.
	<b>Volume Up/Down:</b> click these buttons to raise and lower the volume.

---

*Note! When the play button  is clicked, the application automatically detects the type of media in the CD-ROM drive (AVI, MPEG, MOV, or audio) and begins playing the media. If an audio or video CD is not detected, a dialog box opens to help you select the file to play.*

*If two CD-ROM drives are installed on the computer, the default drive is selected.*

---

# Troubleshooting

## **Wireless RF Keyboard & Mouse not detected**

If the keyboard and mouse don't respond to activity, follow these steps:

1. Ensure that the receiver cable is properly connected to the PS/2 mouse and keyboard ports (refer to Setting up Your Keyboard and Mouse on page 7). Ensure that the purple connector is connected to the keyboard port, and the green connector is connected to the mouse port.
2. Ensure that the batteries have been installed correctly (refer to Inserting Batteries page 5).
3. Ensure that there are no IRQ or I/O address conflicts. Refer to your operating system user's manual for information on resolving IRQ and I/O address conflicts.
4. Ensure that you have established a connection between the RF receiver and the keyboard/mouse (refer to Setting up Your Keyboard and Mouse on page 7).

## **Wireless RF Keyboard & Mouse don't work after changing batteries**

If the keyboard and mouse don't respond to activity after replacing the batteries, follow these steps:

1. Ensure that the batteries have been installed correctly (refer to Inserting Batteries page 5).
2. Ensure that the batteries are not discharged.
3. Ensure that you have established a connection between the RF receiver and the keyboard/mouse (refer to Setting up Your Keyboard and Mouse on page 7).

## **Cursor doesn't move properly on the screen**

If the cursor doesn't move or the motion is erratic, follow these steps:

1. Ensure that you have established a connection between the RF receiver and the keyboard/mouse (refer to Setting up Your Keyboard and Mouse on page 7).
2. Change the position of the RF receiver. There should be a distance of at least 8 inches (20 cm) between the receiver and any electrical appliance (such as speakers, the monitor, or the computer).
3. Ensure that the mouse batteries are not discharged. If they are discharged replace them (refer to Inserting Batteries page 5).



4. Clean the mouse ball and rollers.
  - a. Remove the retainer ring on the bottom of the mouse (press in the direction of the arrow on the retainer-ring cover).
  - b. Remove the ball from the compartment.
  - c. Wipe the ball with a clean, lint-free cloth.
  - d. Blow into the ball compartment to dislodge dust and lint.
  - e. If the rollers inside the ball compartment have dirt on them, clean the rollers using a cotton swab moistened with isopropyl rubbing alcohol.
  - f. Replace the ball and retainer ring.

**After pressing the sleep button, the computer doesn't wake up**

After pressing the sleep button to place the computer into suspend mode, the computer doesn't wake up after pressing another key (other than the sleep button).

There may be a problem with power management. Some systems are unable to wake up after being placed into suspend mode.

Follow these steps to fix this problem:

1. Refer to your computer hardware documentation regarding power-management operation.
2. Ensure that the power-management settings for your operating system are correct, as described in Windows Help.

## A Word about Ergonomics

*Ergonomics* is the study of how people with their different physical characteristics and ways of functioning relate to their working environment (the furnishings and machines they use). The goal of Ergonomics is to incorporate comfort, efficiency, and safety into the design of keyboards, computer desks, chairs, and other items in an effort to prevent physical discomfort and health problems in the working environment.

If your budget permits, buy ergonomically designed furniture such as chairs, shelves, and desks that fit your physical characteristics and work methods.

You can create an ergonomically improved workstation without spending much money. Following are a few tips to help you work effectively without a lot of physical discomfort:

- Keep your forearms, wrists, and hands in a relaxed position, with your elbows at your side.
- Position the keyboard and mouse so that you do not have to reach for them.
- Don't strike the keys too hard; type with a soft touch.
- Keep your thighs parallel to the floor and your feet flat on the floor or on a footrest.
- Use a chair that provides good back support.
- Try to place the monitor so that there is little glare from the sun on the monitor.
- Walk around the room every hour.
- Every half-hour look away from the computer screen for a few minutes.
- Vary your tasks throughout the day.
- Avoid resting your wrists on sharp edges.