

iN·Command™

CONTROL SYSTEMS

JRVCS105

RV CONTROL AND MONITORING SYSTEM

Installation and Operation Manual

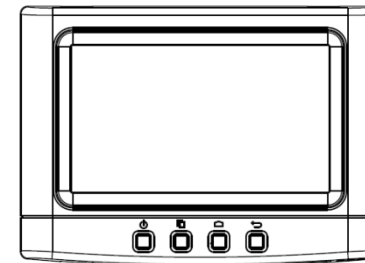
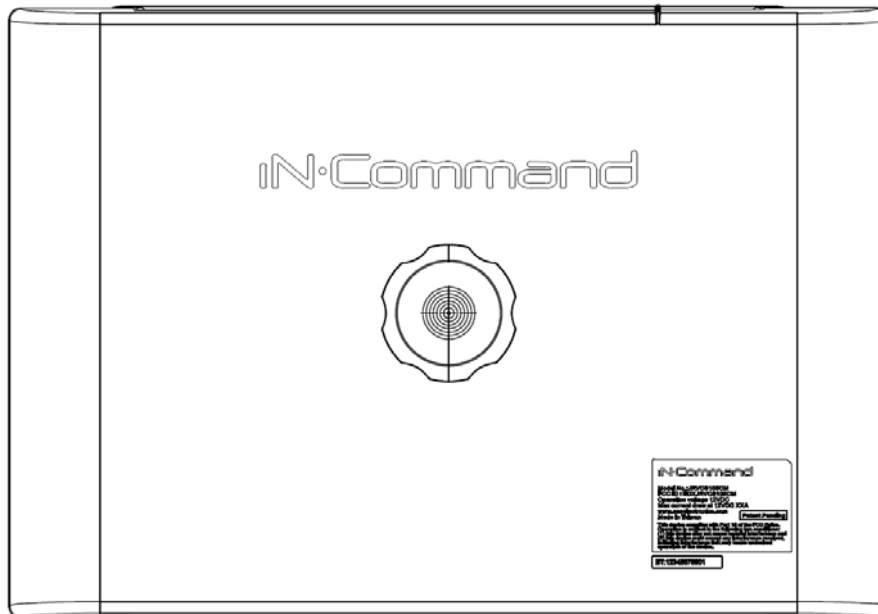

TABLE OF CONTENTS

Table of Contents	2
Introduction	4
Thank You!	4
Features	4
Precautions	4
Packing List	錯誤! 尚未定義書籤。
Installation	5
Tools and Supplies	5
Disconnecting the Battery	5
Selecting the Mounting Location	5
Mounting the Display Commander (DC)	5
Wiring Terminal List	6
BCM and DC Wiring Diagram	7
SETUP MENU LIST	8
SAFETY LOCK OUT	9
Troubleshooting	錯誤! 尚未定義書籤。
Override Switches	錯誤! 尚未定義書籤。
Display Commander Buttons	11
Specifications	12
FCC Notes	12
Passcode Protection	13
Menu:	14
Text Editing	14
Scroll List Editing	15
Tanks	15
Lights	15
Slides	16
Awnings	16
Passcode	17
Set Passcode Timer	18
Change Passcode	18
Clear Passcode	18
Pairing a Mobile Device to DC	19
Checking Active Bluetooth Session	22

Software Update 24
Reset: Floor Plan 26
System Calibration 27

INTRODUCTION

Thank You!

Thank you for choosing iN-Command. We hope you will find the instructions in this owner's manual clear and easy to follow. If you take a few minutes to look through it, you'll learn how to use all the features of your new JRVCS105 for maximum enjoyment.

Features

Features of Jensen JRVCS105 system include:

- Simultaneous control by up to three Android Devices and one iOS Device
- Control two zones of Interior Lighting
- Monitor all water tank levels
- Control and monitor the Water Heater (switches between LP or AC)
- Control and monitor the Water Pump
- Control Awning
- Control Electric Slides
- Control Jacks (non-automatic function)
- Monitor Battery Voltage with Low Voltage Alert

Precautions

- **Use the Proper Power Supply.**
This product is designed to operate with a 12 volt DC, negative ground battery system (the standard system in a North American vehicle).
- **Use Authorized Service Centers.**
Do not attempt to disassemble or adjust this precision product; contact a professional for assistance.
- **Avoid Moisture.**
To reduce the risk of fire or electric shock, do not expose this equipment to rain or moisture.
- **Avoid Cleaning Products.**
The front of this unit should only be cleaned with a slightly damp cloth. Do not use cleaning products.
- **Use Recommended Accessories.**
TO REDUCE THE RISK OF FIRE OR ELECTRIC SHOCK AND ANNOYING INTERFERENCE, USE ONLY THE RECOMMENDED ACCESSORIES.

Packing List



1 Cover, 1 Thumb Screw

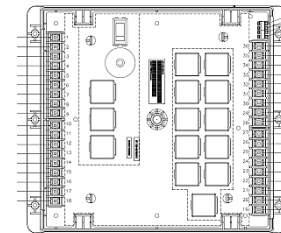

1 Body Control Module (BCM)

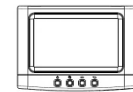

1 Display Commander (DC)

INSTALLATION

It's a good idea to read all of the instructions before beginning the installation. We recommend having your Jensen JRVCS105 installed by a reputable RV dealership

Tools and Supplies

You will need these tools and supplies to install your JRVCS105:

- Phillips screwdriver
- #2 square drive bit
- Wire cutters and strippers
- Electrical tape
- Volt meter/test light
- Crimping tool
- Fork Crimp connectors
- 10 gauge wire for power and slide connections
- 14 and 18 gauge wire for all other connections
- Four #8 PH (0.164" x 0.75") screws for the DC
- Six #8 PH (0.164" x 1.0") screws for the BCM

Disconnecting the Battery

To prevent a short circuit, be sure to turn off 12V power and remove the negative (-) battery cable prior to installation.

Selecting the Mounting Location

Select a mounting location, taking care to avoid the following:

- Places exposed to heat-radiating appliances such as electric heaters
- Adjacent to other equipment that radiates heat
- Under thermostats
- Poorly-ventilated or dusty places
- Moist or humid locations

Mounting the Display Commander (DC)

- Use the mounting hole diagram to measure and cut a mounting hole, allowing space below for future programming and behind for ventilation
- Route power and transmit wires through the hole and connect
- Check and ensure correct operation
- Mount the unit using four #8 PH (0.164" x 0.75") screws
- Attach Trim ring

CUTOUT FOR DISPLAY COMMANDER (DC)

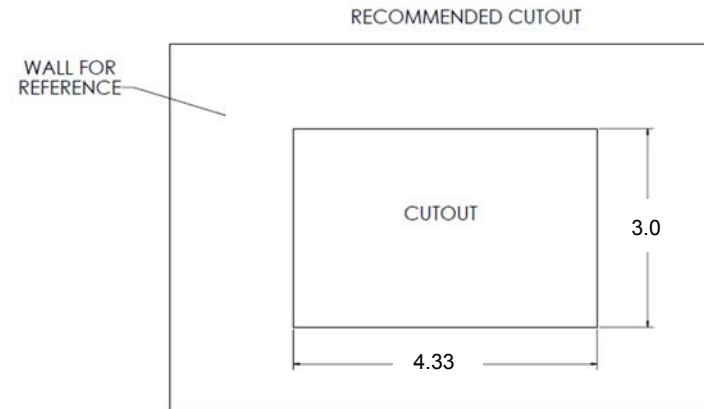

NOTE: Before cutting the mounting hole, make sure the area behind the mounting location is clear of wires, fuel and vacuum or water lines; ensure there is at least a 2.75" clearance below the Display Commander to allow for programming by USB stick.

WIRING TERMINAL LIST

The wiring diagram depicts all the wiring connections required for proper operation of the unit.

The TX (transmit) and RX (receive) wires from the BCM to DC are reversed at each device (the BCM transmits and the DC receives, and vice versa).

BODY CONTROL MODULE (BCM) CONNECTIONS

PIN NO.	WIRE GAUGE	DESCRIPTION
1	18 AWG	FRESH TANK 1 (IN)
2	18 AWG	BLACK TANK 1 (IN)
3	18 AWG	BLACK TANK 2 (IN)
4	18 AWG	GRAY TANK 1 (IN)
5	18 AWG	GRAY TANK 2 (IN)
6	18 AWG	GRAY TANK 3 (IN)
7	18 AWG	TANK COMMON 7V (OUT)
8	14 AWG	LIGHT GROUPS +12V (IN)
9	14 AWG	LIGHT GROUP 1 - 12V (GND)
10	14 AWG	LIGHT GROUP 1 +12V (OUT)
11	14 AWG	LIGHT GROUP 2 -12V (GND)
12	14 AWG	LIGHT GROUP 2 +12V (OUT)
13	14 AWG	AWNING LIGHT -12V (GND)
14	14 AWG	AWNING LIGHT +12V (OUT)
15	18 AWG	WATER HEATER FAULT
16	18 AWG	WATER HEATER GROUND
17	18 AWG	WATER HEATER ON (GAS)
18	18 AWG	WATER HEATER ON (ELECTRIC)

PIN NO.	WIRE GAUGE	DESCRIPTION
19	16 AWG	TRAVEL LOCK +12V (IN)
20	14 AWG	WATER PUMP +12V (OUT)
21	14 AWG	WATER PUMP -12V (GND)
22	14 AWG	WATER PUMP +12V (IN)
23	12 AWG	MOTOR 5 -12V (IN)
24	12 AWG	MOTOR 5 +12V (OUT)
25	10 AWG	MOTOR 4 -12V (IN)
26	10 AWG	MOTOR 4 +12V (OUT)
27	10 AWG	MOTOR 3 -12V (IN)
28	10 AWG	MOTOR 3 +12V (OUT)
29	10AWG	MOTOR 2 -12V (IN)
30	10 AWG	MOTOR 2 +12V (OUT)
31	10 AWG	MOTOR 1 -12V (IN)
32	10 AWG	MOTOR 1 +12V (OUT)
33	10 AWG	CHASSIS GROUND (IN)
34	10 AWG	MOTOR FEED+12V (IN)
35	10 AWG	BCM +12V (IN)
36	N/A	NONE

BCM AND DC WIRING DIAGRAM

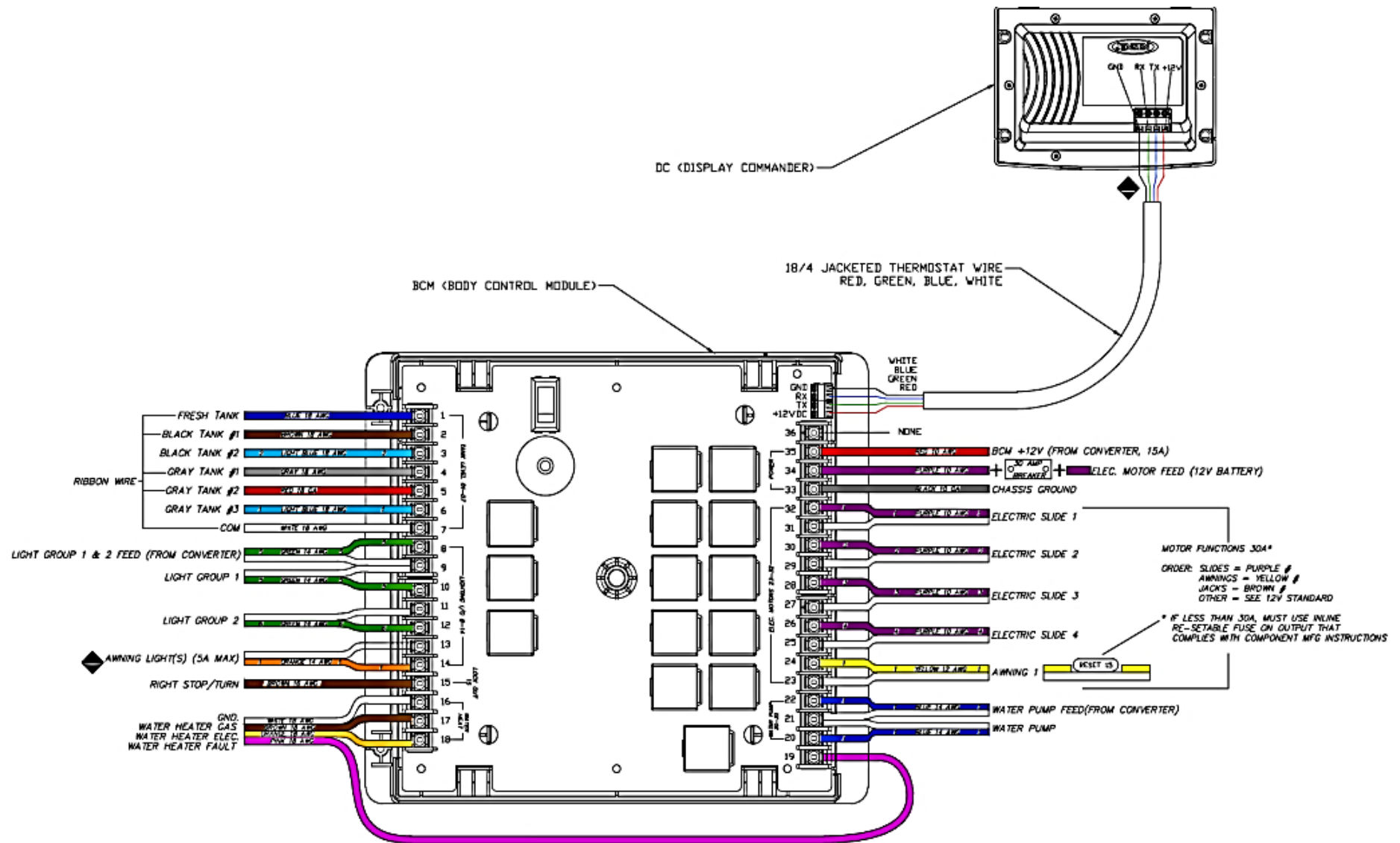

SETUP MENU LIST

Tanks, light groups, and motor functions can be added or removed.

Motor functions may include slides, awnings, jacks, or any motor that may be controlled with a momentary switch.

Refer to the Wiring Diagram and Terminal List when installing new equipment. The BCM may not include relays for non-OEM functions. Basic automotive 1505 relays (12VDC Coil, 40/30A 14VDC Contact) can be purchased for installation and repair.

ITEM	SELECTION
Black Water Tank 2	No, Yes
Gray Water Tank 2	No, Yes
Grey Water Tank 3	No, Yes
Light Group 1	No, Yes
Light Group 2	No, Yes
Awning Light	No, Yes
Motor 1	No, Yes
Motor 2	No, Yes
Motor 3	No, Yes
Motor 4	No, Yes
Motor 5	No, Yes

SAFETY LOCKOUT

IN-Command is equipped with a Safety Lockout feature to ensure certain system functions are unavailable during transit.

When the Brake or Right Turn Signal on the tow vehicle is activated, IN-Command will lock down all motorized functions. A red button, with Travel Lock in white text, will appear on the DC and mobile devices will display “Travel Lock On” in red letters. All motor functions will cease to actuate and Disable will be written on their buttons.

The lights, water pump, water heater, and sensors will continue to function.

To turn the Travel Lock off, ensure 12VDC is not going to the Travel Lock system by removing the 7-way connector from the tow vehicle and press the “Unlock” button on the Display Commander inside the RV.

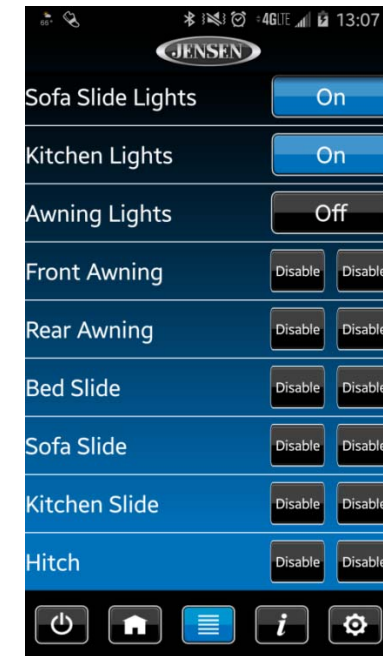
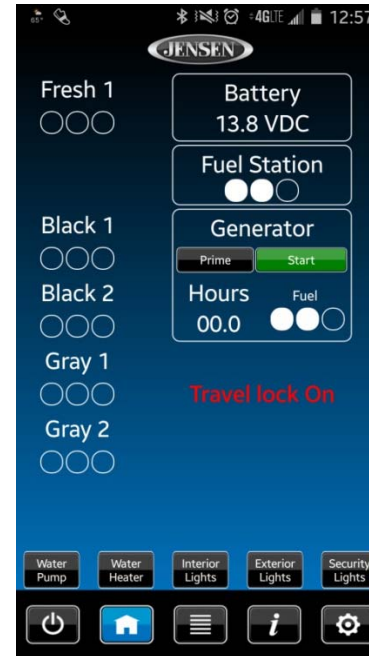

Travel Lock on a handheld device app

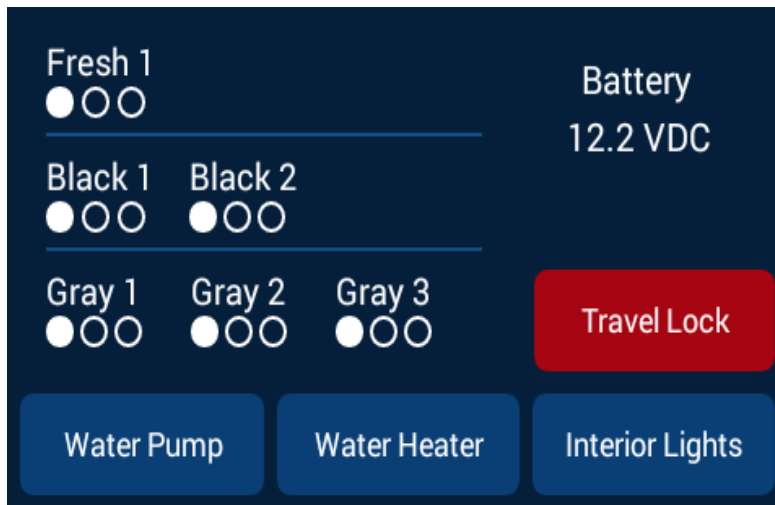

Travel Lock on the Display Commander

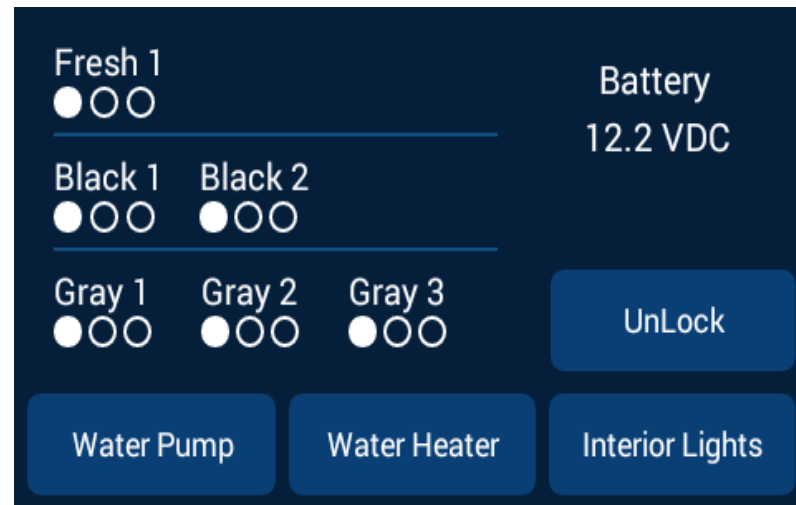

TROUBLESHOOTING

Symptom	Solution
Display Commander (DC) will not turn ON or the touch screen will not function	Press Reset Button on BCM
	Check main fuse in Distribution Panel.
	Check 12V+ on wire to DC (RED wire).
	Check Ground wire to DC.
No power to the Body Control Module (BCM)	Try cycling power at Distribution Panel.
	Check if the Red power LED is off.
	Check the fuse in the Distribution Panel.
	Check 12V+ on wire at pin 35. Check Ground wire at pin 33.
	Ensure Pin 7 is NOT grounded
DC screen flashing on and off after installation	Cycle power to the BCM and DC
	Ensure the wires to the BCM and DC are connected and there is 12V
	Ensure the wires to the BCM and DC are not damaged or pinched
	Ensure the Battery is charged
Electric Motors do not move	Check 12V+ at Pin 34. Ensure the relay activates*.
Travel Lock on	Ensure 12V+ is removed from Pin 15.
*Relay not activating	Replace the 1505 relay with one from an unused circuit by gently pulling it off the board, or install a new one.

If an issue is unable to be resolved using the above methods, contact **ASA Electronics Technical Support** at 1-877-845-8750 or email them at info@asaelectronics.com

OVERRIDE SWITCH

The Body Control Module has an override switch and knob. The knob below the switch corresponds to a motor function made by the Display Commander and Handheld Devices App. The switch and knob actuate all the motor functions on the RV.

To use the override switches, locate the switch on the BCM. Turn the knob underneath the switch to select the component. Press up or down on the switch. The switch is momentary and will activate the component only while pressed in either direction.

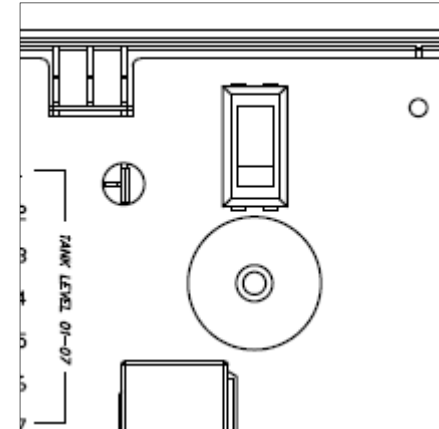

DISPLAY COMMANDER BUTTONS

The DC (Display Commander) has 4 buttons on the front of it.

From left to right, they are:

- Power
- Pages
- Home
- Return

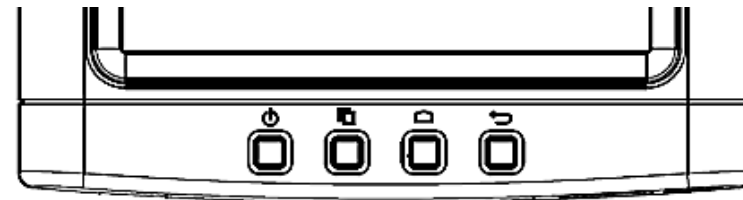

The Power Button turns the DC on and off (long press) and revives it (short press). The Pages Button navigates forward through the system. The Home Button returns you to the Home page. The Return Button returns you to the previous page.

SPECIFICATIONS

Display Commander (DC)

Operating Voltage	12VDC
Maximum Current Draw	1.5A@9VDC
Minimum Operating Voltage	9VDC
Maximum Operating Voltage	16VDC

Body Control Module (BCM)

Operating Voltage	12VDC
Maximum Current Draw	8.5A@12VDC
Minimum Operating Voltage	9VDC
Maximum Operating Voltage	16VDC

JRVCS105 System

EPROM Non-Volatile Memory	YES
Bluetooth Version	4.0 BLE

General

Body Control Module	14.9" (W) x 10.4" (D) x 1.8" (H)
Display Commander	5.2" (W) x 3.8" (D) x 1.5" (H)

FCC Notes

WARNING! Changes or modifications to this unit not expressly approved by the party responsible for compliance could void the user's authority to operate the equipment.

NOTE: This equipment has been tested and found to comply with the limits for a Class B digital device, pursuant to Part 15 of the FCC Rules. These limits are designed to provide reasonable protection against harmful interference in a residential installation.

This equipment generates, uses and can radiate radio frequency energy and, if not installed and used in accordance with the instructions, may cause harmful interference to radio communications.

However, there is no guarantee that interference will not occur in a particular installation. If this equipment does cause harmful interference to radio or television reception, which can be determined by turning the equipment off and on, the user is encouraged to try to correct the interference by one or more of the following measures:

- Increase the separation between the equipment and receiver.
- Connect the equipment into an outlet on a circuit different from that to which the receiver is connected.
- Consult the dealer or an experienced radio/TV technician for help.

PASSCODE PROTECTION

A passcode is required to access the system. On first using the system, you are required to enter and confirm a new passcode.

Confirm the new passcode.

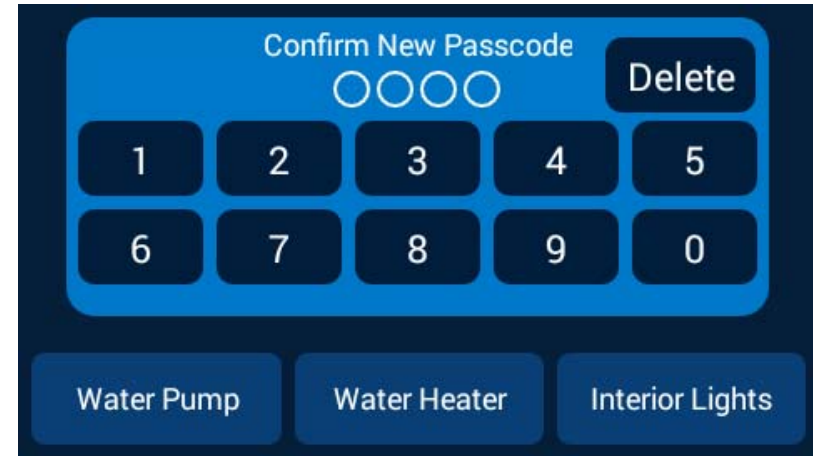
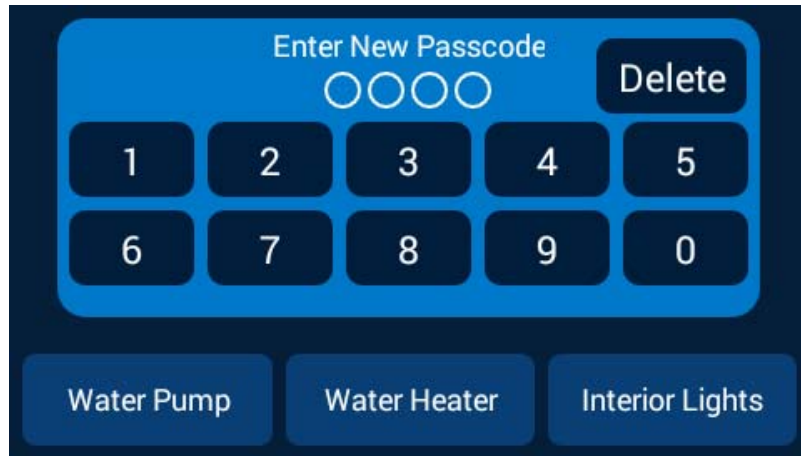

MENU:

From the Menu screen you can:

- Edit IN-Command function text
- Reposition functions
- Enable/disable functions
-
- See the status of IN-Command
- Connect devices with Bluetooth
- Change the passcode
- Reset the floor plan
-
- And view IN-Command's legal documents and customer support information

The Setup button is used by the manufacturer.

Text Editing

1. Press the "Pages" button 2 times.



2. Long press the intended text, e.g., "Motor 1".



3. A device rename window will open. Press "OK" after completing the text editing.
Note: Editing the text on the DC will not change the text on a device's app.

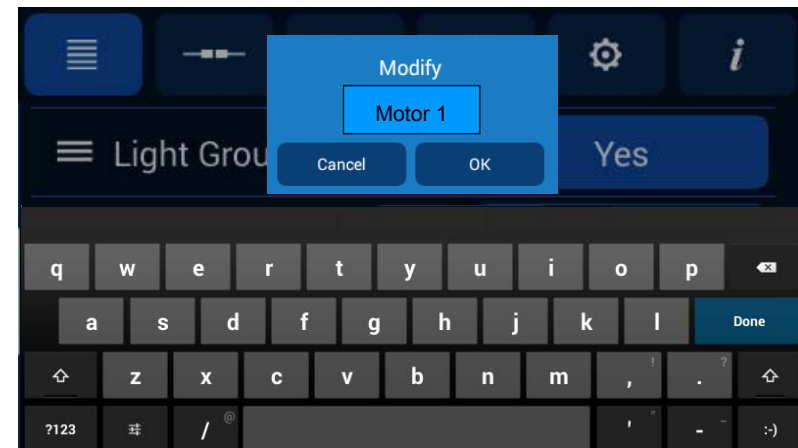

Scroll List Editing

1. Push the "Pages" button twice.

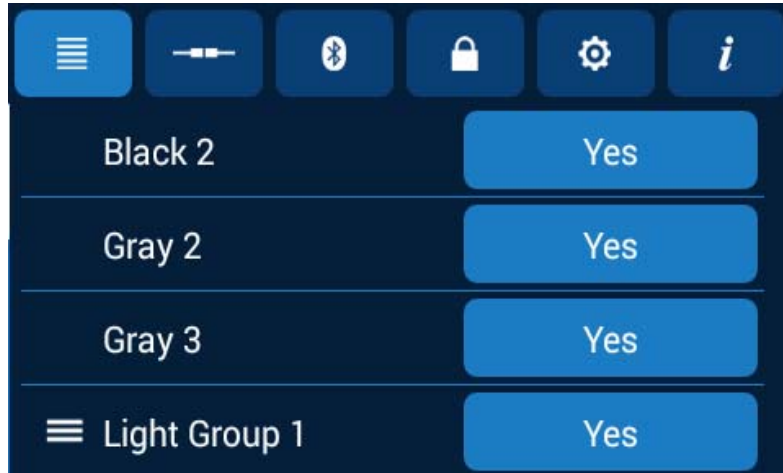

2. Press and hold the "≡" icon before the device name and drag to move the device to a new location, "Motor 1" is shown as an example.



Tanks

Black water tanks, and Gray water tanks can be added to the system.

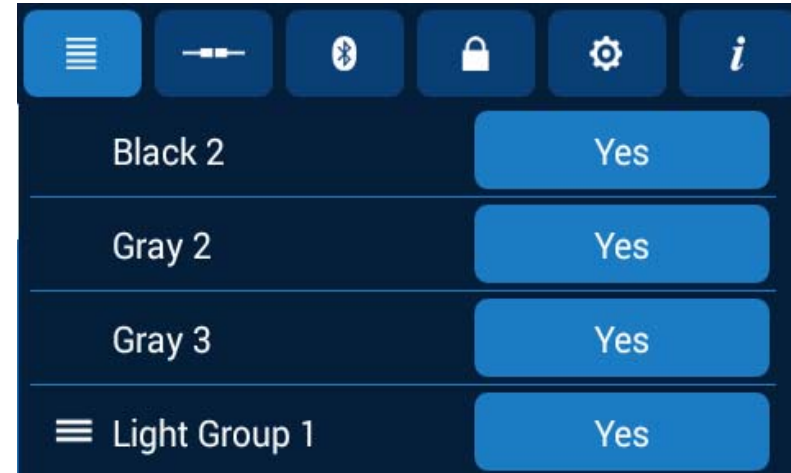

Lights

Light Groups can be added to the system.



Slides

Slides can be added to the system.



Awnings

Awnings can be added to the system.



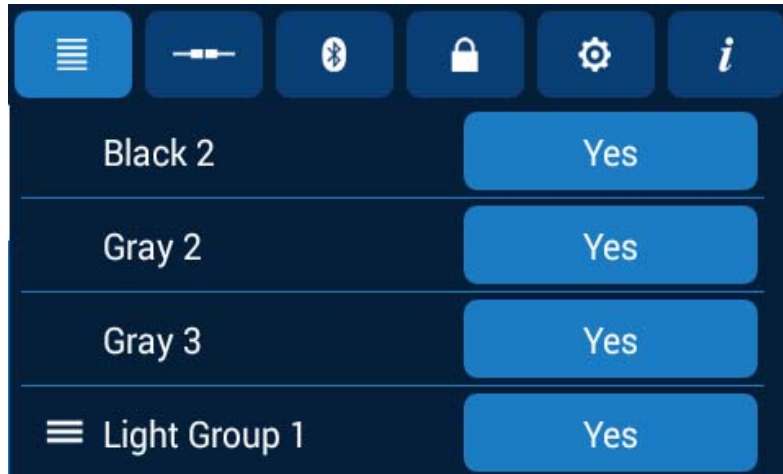

Passcode

1. Push the "Pages" button twice.

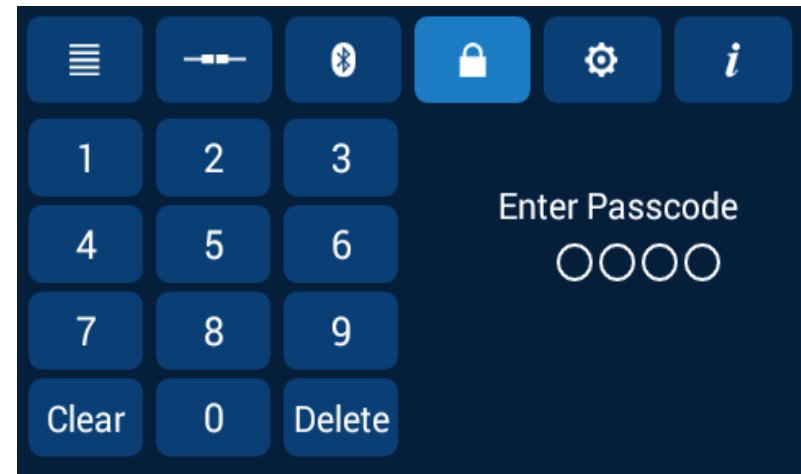

3. To change Passcode you will need to enter the current passcode.



2. Press "  " to enter passcode setup.

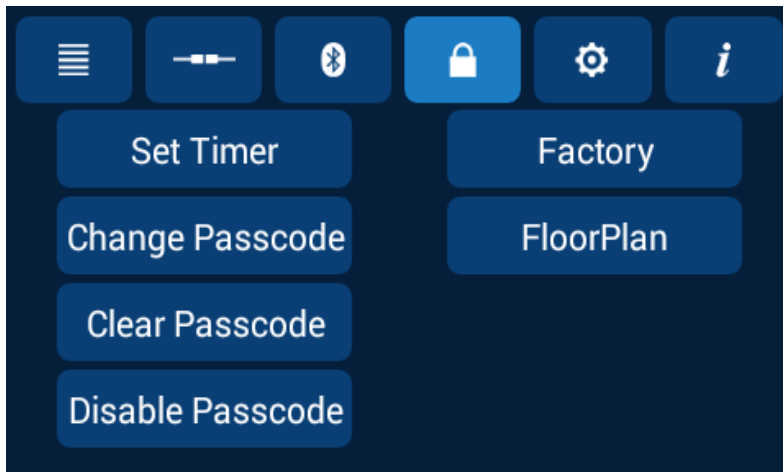

Set Passcode Timer

Press the “Set Timer” button to select the idle time to activate the passcode protection.

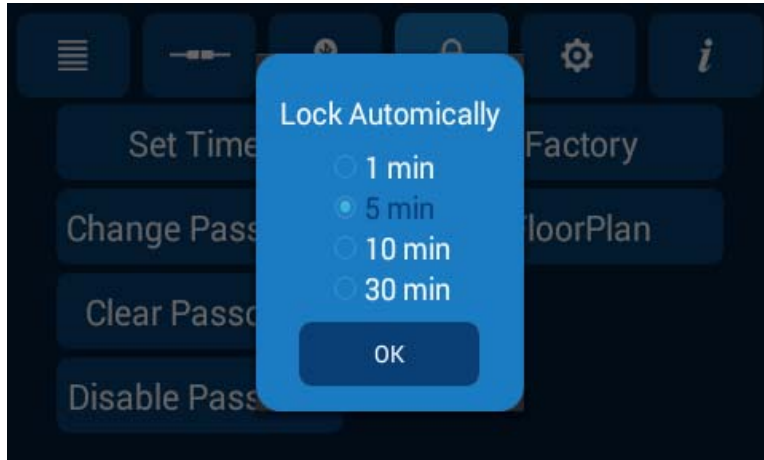

Change Passcode

1. Press the “Change Passcode” button to change to a new passcode.
2. Enter the new passcode.

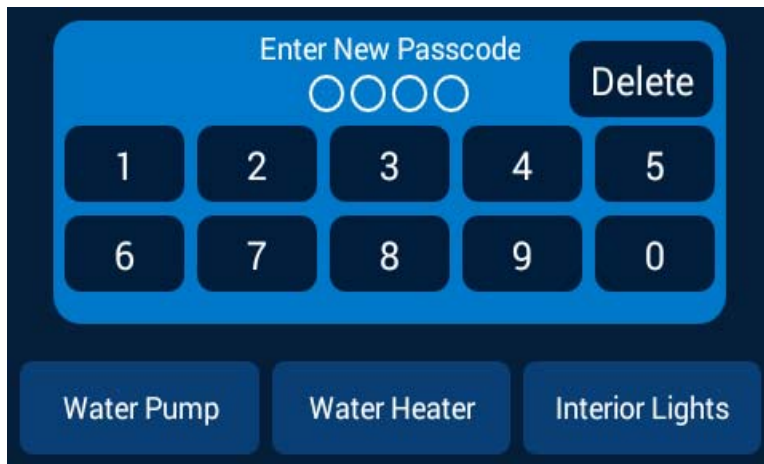

3. Confirm new passcode.

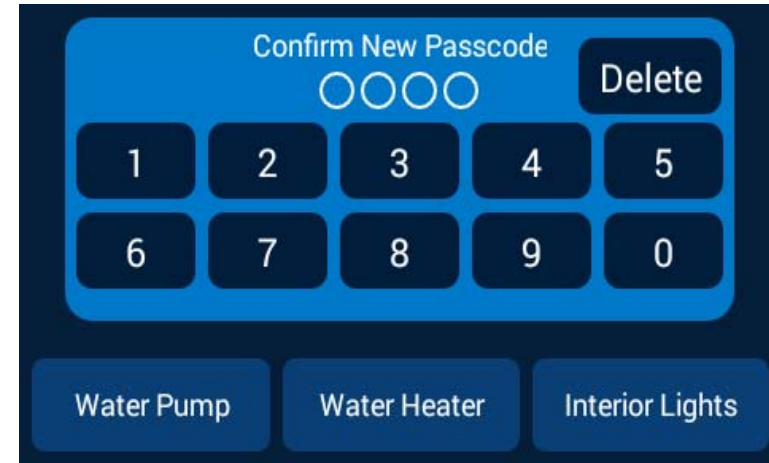

Clear Passcode

Press the “Clear Passcode” button to clear the passcode. This will restart the APP, take the user to the End-User License Agreement, and have the user setup a new passcode.

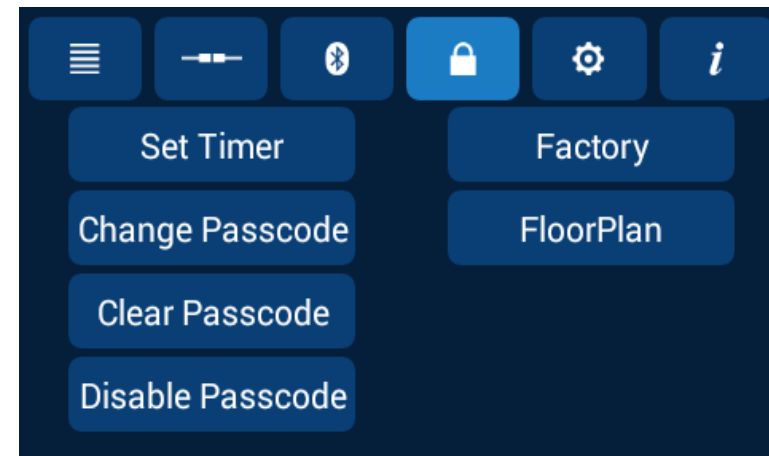

MOBILE DEVICES:

iN-Command is able to pair to Android and iOS devices using the iN-Command App. Visit the Google Play and Apple App stores on your mobile device to download and use the iN-Command App.

Seven mobile devices are able to be paired iN-Command at one time, but only 1 iOS and 3 Android devices are able to be **actively** paired at the same time; meaning, 3 Android devices and 1 iOS device can all actively control the iN-Command functions.

To use another device not actively paired to iN-Command, 1 device needs to shut down its iN-Command App to allow another device to actively pair. To do this simply select the power button on the App, shut down the App in the device's settings menu, or press "Disconnect" on the DC's Connections page.

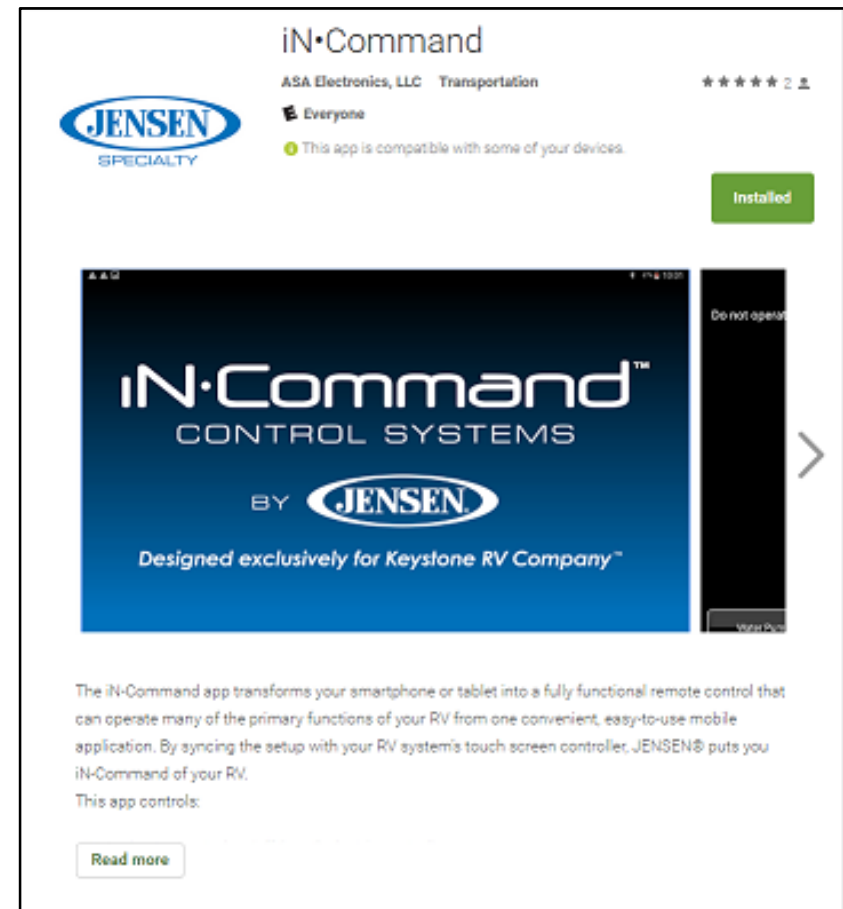

Pairing a Mobile Device to DC

1. On the DC:

1.1 Push the “Pages” button 2 times.

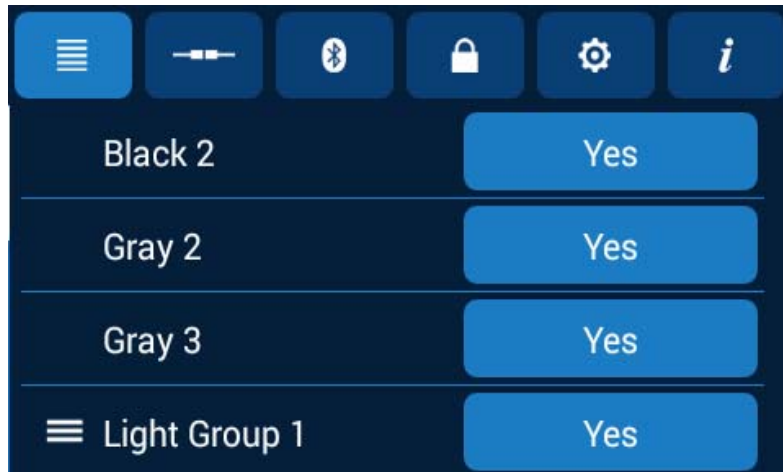

1.2 Select “”. Press “Scan” to start scanning for unpaired devices.

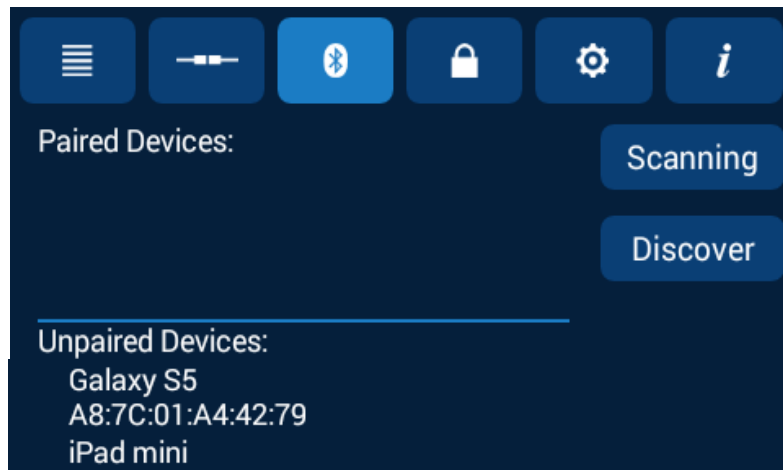

1.3 Or press “Discover” for the DC to become “visible” to other devices for 300 seconds. Press “Allow”.

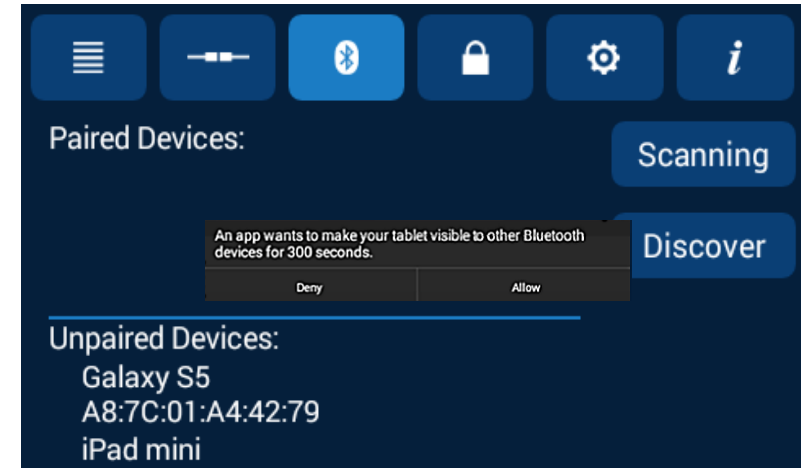

2. On the Mobile Device:

2.1 Press "Bluetooth" on the "Setup" page to find the DC device.

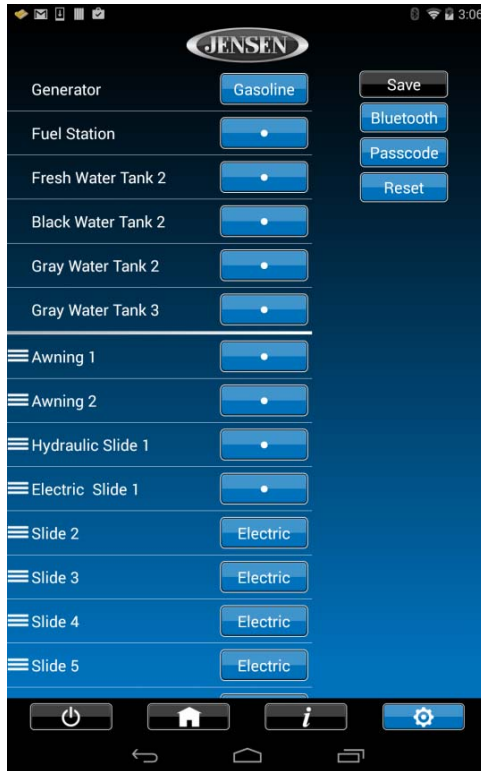

2.2 The Mobile APP will scan for the DC device.

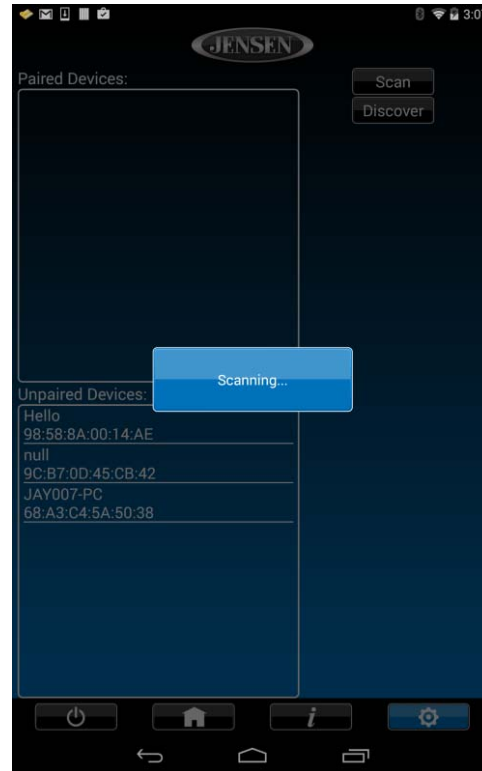

2.3 The DC will be displayed in the Unpaired Devices list in the format "JENSENDCXXXXXX". Press the DC device in the list to pair with it.

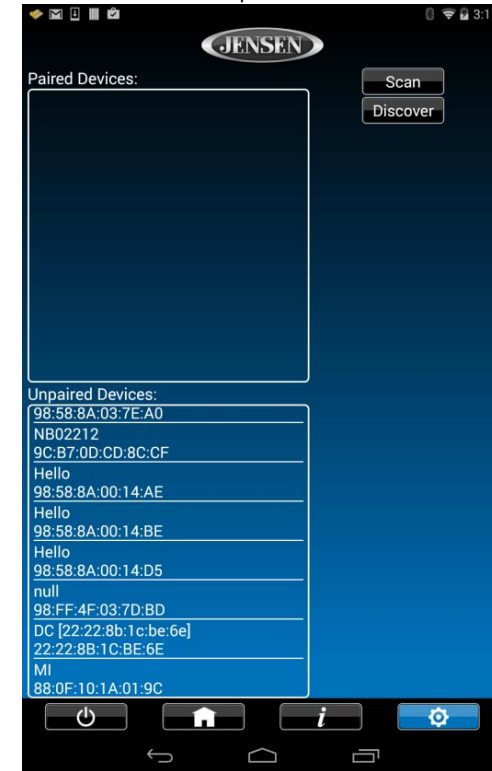

- 3.1 On the DC, a request message will appear. Press “Pair” to start the BT pairing and concurrently accept the pairing on the Mobile device.

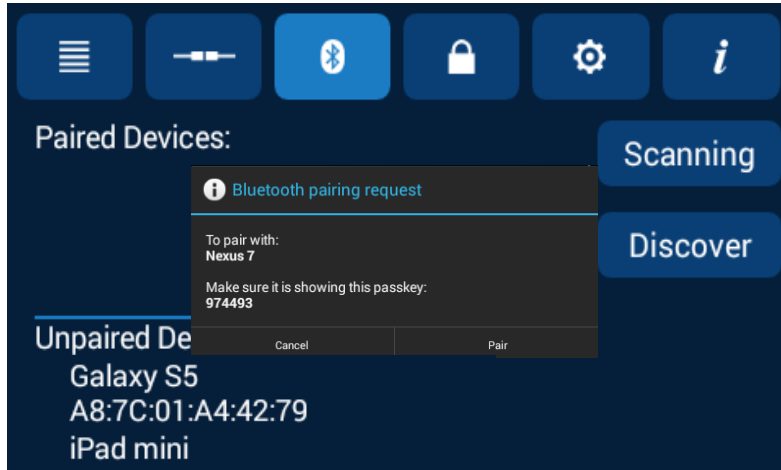

- 3.2 The DC now shows the Mobile device is paired.

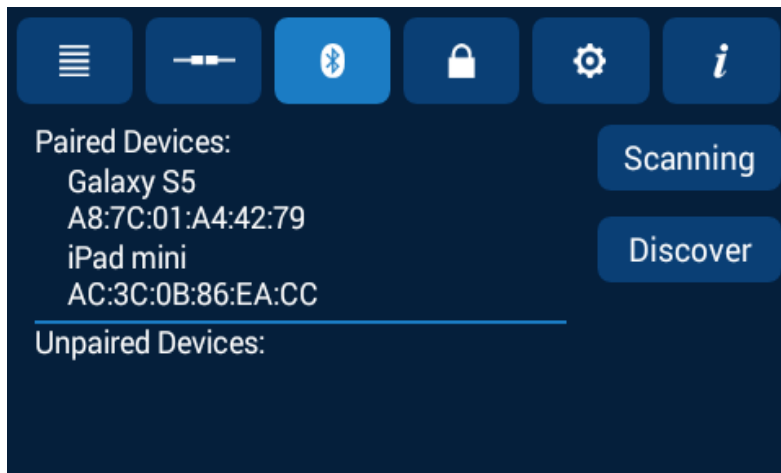

Setting the Floor Plan on the Mobile Device

- 1.1 After Pairing the mobile Device, go to the settings menu on that device and select “Reset”.



- 1.2 Select “Floor Plan”. This will change the home screen, configure the mobile device’s buttons, and populate the function list.



CHECKING FOR AN ACTIVE BLUETOOTH SESSION

1. Push the “Pages” button 2 times and select the connections, or “”, menu. This page shows the current Actively Paired handheld devices.

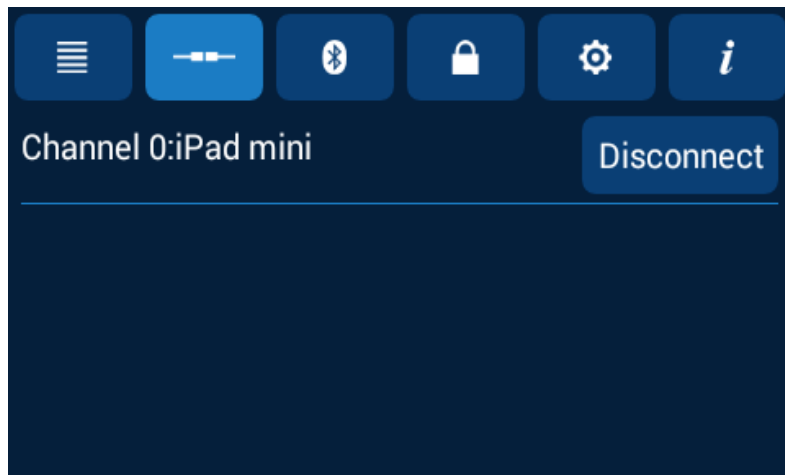

To disconnect a handheld device, press “Disconnect”, or simply shut down the device’s app.

This function is used to disconnect a device that is not actively being used, and to allow another device to be connected.

SOFTWARE UPDATE *

Software updates include floorplan redesigns and app version updates.

Insert USB drive with software update into the USB port located underneath the bottom right corner of the DC. The system will look for specific file names for software updates.

- File name: "JRVCS1_AP Vxxxx.apk" → DC APP update, (xxxx is version number)
- File name: "JRVCS1_CM Vxxxx.bin" → BCM update, (xxxx is version number)
- File name: "update.zip" → DC Android OS update
- File name: "xxxxxx.xml" → Floor Plan update

1. The system must be updated in the following order to prevent loss of communication between the DC and BCM.
 1. Update DC
 2. Update BCM
 3. Update APP
2. Push the "Pages" button twice. Select the Settings, or "  "page. Enter the Engineering Passcode**

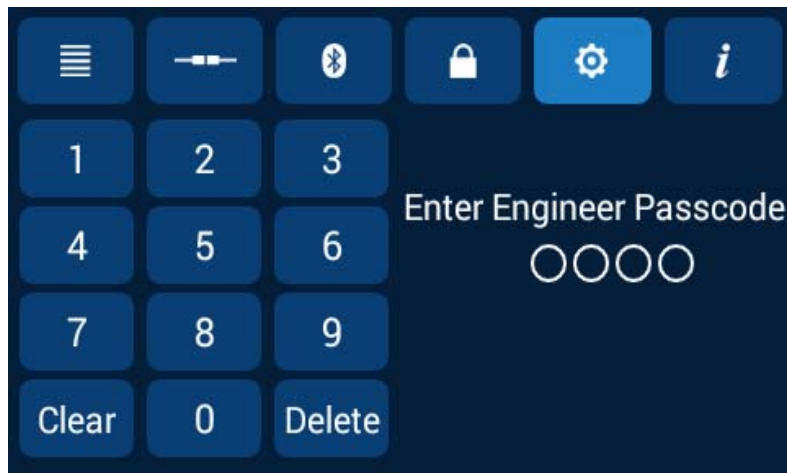

3. The Settings menu will appear. Press the "Update" button next to the Version, or "Select" next to Floor Plan.

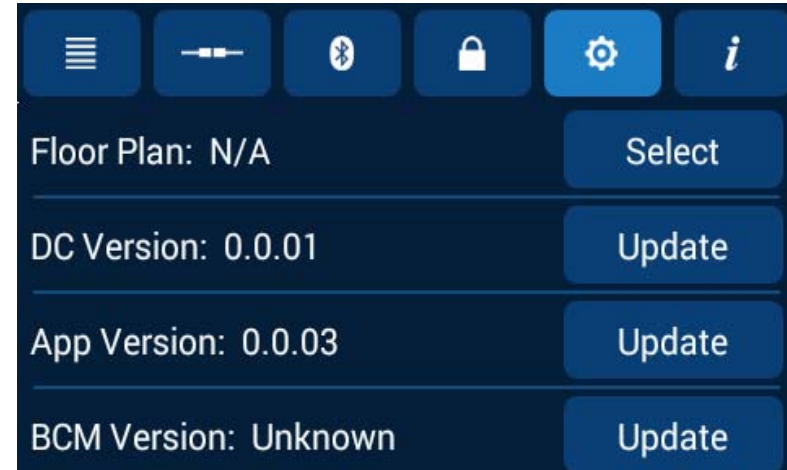

4. A confirmation screen will appear. Press "Update", "Install", or "OK" depending on the program being updated. The DC may restart.

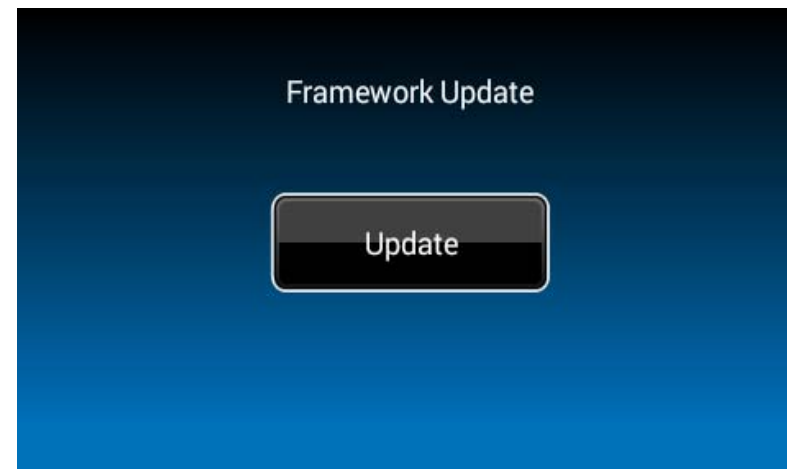

5.1 After the update is completed, press the “Home” button, and then return the Settings Page

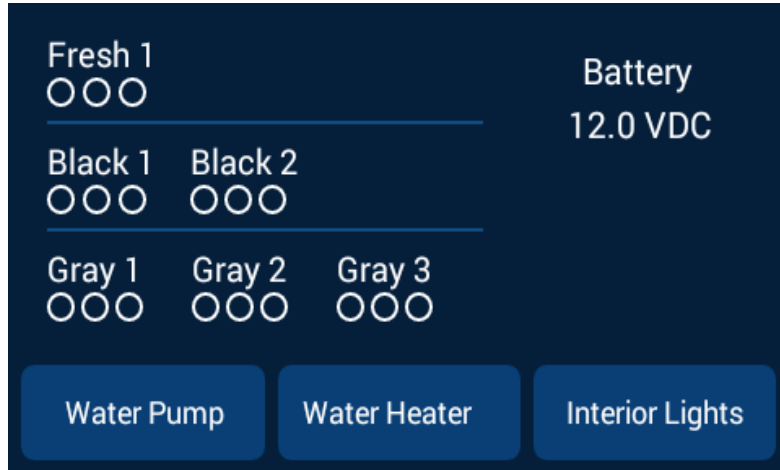

5.2 Ensure the updated program displays correctly

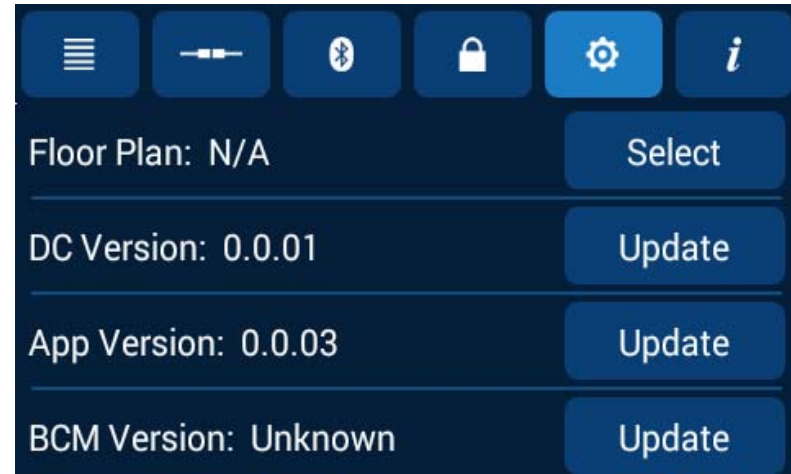

*If a software update is needed, go to <http://www.asaelectronics.com//in-command>

** The Engineering Passcode is used by the manufacturer for programming and troubleshooting purposes. Should there be a software issue, call ASA Electronics Technical Support at 1-877-845-8750 or email them at info@asaelectronics.com

Reset: Floor Plan

To reset the floor plan, removing customizations, press the "Pages" button twice.

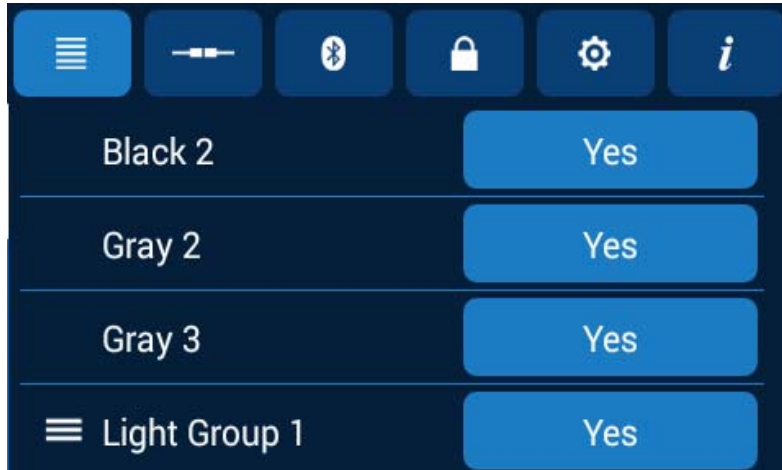

1. Select the Passcode page and enter the current passcode.

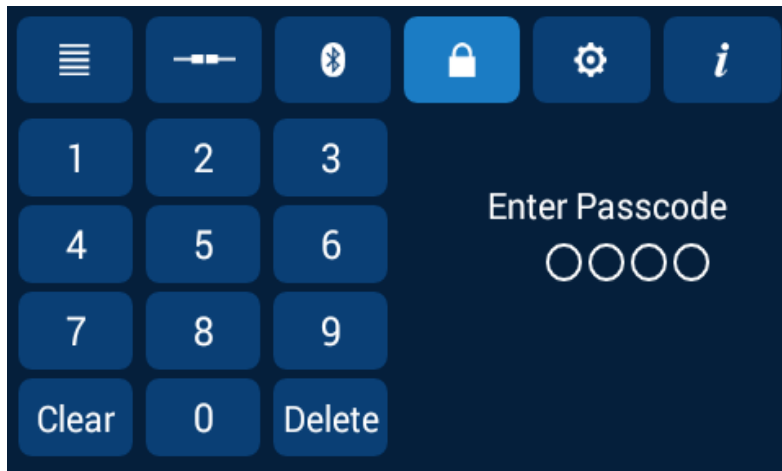

2. Select one of the two options to restore to a previous state. **Current settings will be lost.**
 - Floor Plan: restore to previous floor plan setting.
 - Factory: restore to default setting.

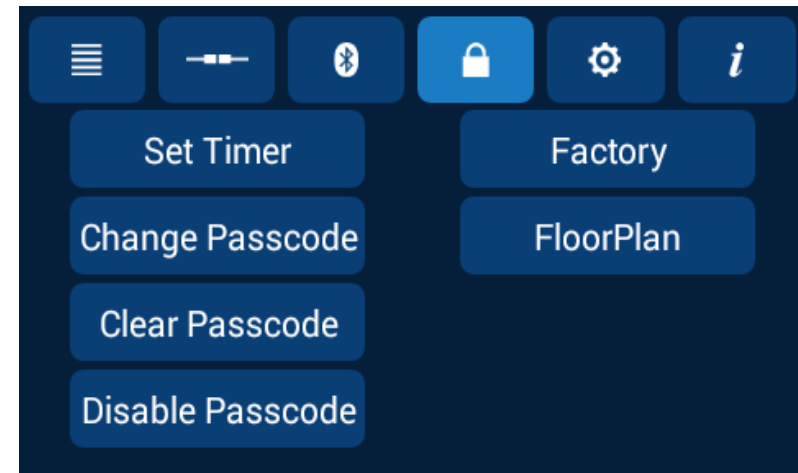

3. Select "Floor Plan".

SYSTEM CALIBRATION*

1. Push the "Pages" button 2 times and select the Settings Menu. Enter the Engineer Passcode.**

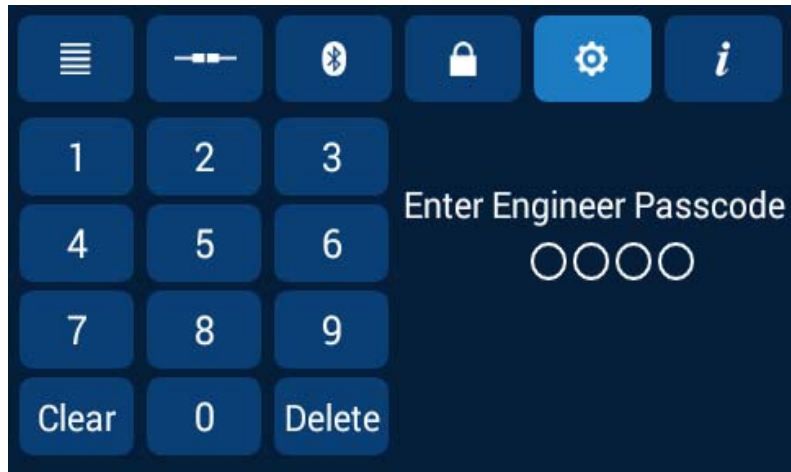

3. Enter admin passcode to proceed.**

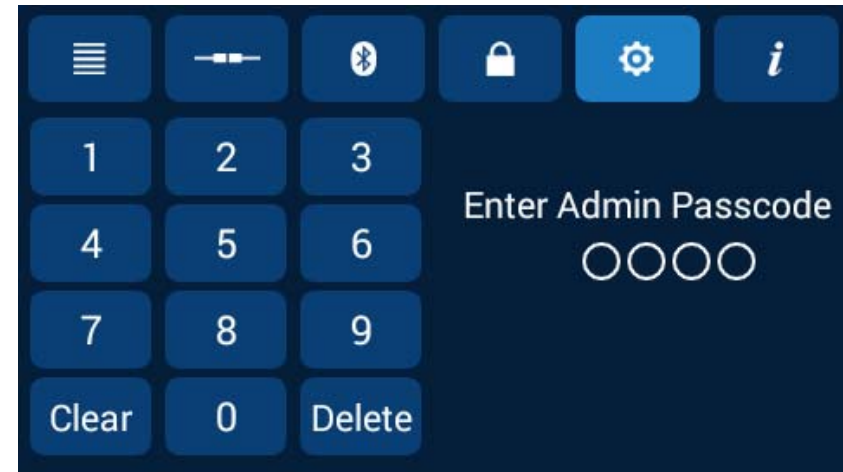

2. Scroll to the bottom of the page and select "Admin".

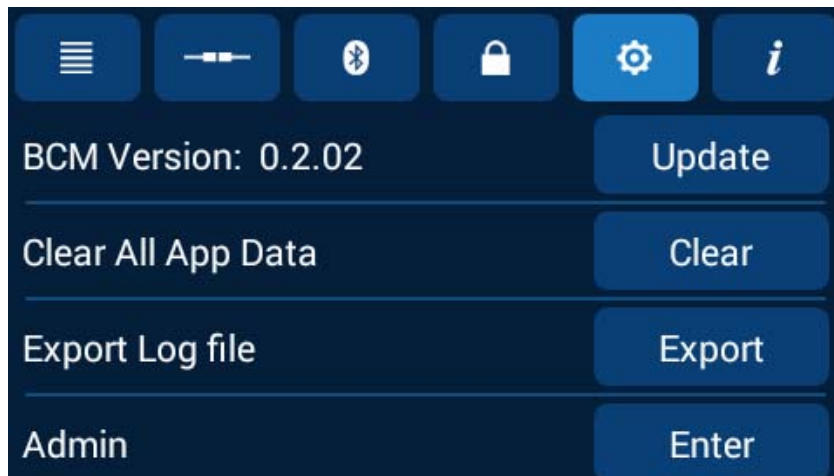

4. Select the device that needs to be calibrated.

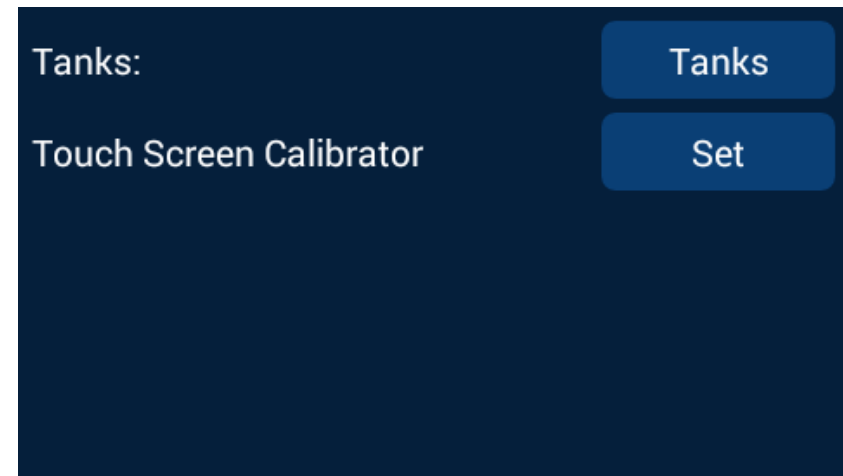

5. Select "Tanks" to set resistor reference value for every tank.



6. After setting the values, return to previous screen and select "OK" to save the change.

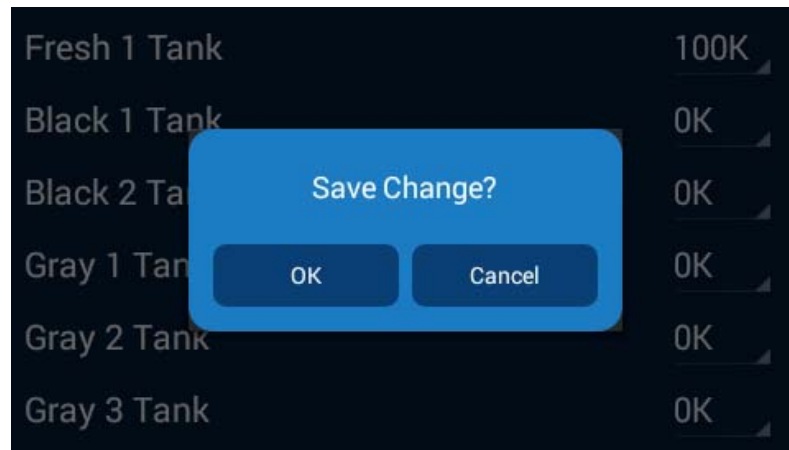

7. To calibrate the Touch Screen, select "Set". Follow the instructions. The DC will restart after calibration.



*The system should be calibrated by the manufacturer and only need to be accessed for troubleshooting.

** The Administration Passcode is used by the manufacturer for programming and troubleshooting purposes. Should there be a calibration issue, call ASA Electronics Technical Support at 1-877-845-8750 or email them at info@asaelectronics.com



ASA Electronics Corporation
www.asaelectronics.com
www.jensenrvidirect.com
©2015 ASA Electronics Corporation