

Bluetooth[®] Module

EYSMJCS (RF+Baseband (Class 2) USB)

User's Manual

In case you adopt this module and design some appliance, please ask for the latest specifications from the local sales office.

We wish the customer to request the Specification Report when the design for the mass production begins because the content of this Data Report might change without a previous notice to the customer.

The *Bluetooth*[®] word mark and logos are owned by the *Bluetooth* SIG, Inc. and any use of such marks by TAIYO YUDEN CO., LTD. is under license.

EYSMJCSTAIYO YUDEN Confidential
& Tentative**Document constituent list**

Control name	Control No.	Document Page
General Items	HD-AG-A071063	1/3 – 3/3
Absolute maximum ratings	HD-AM-A071063	1/1
Electrical characteristics	HD-AE-A071063	1/3- 3/3
Electrical characteristics	HD-AE-B071063	1/2 - 2/2
Electrical characteristics	HD-AE-C071063	1/13 - 13/13
Electrical characteristics	HD-AE-D071063	1/10- 10/10
Circuit schematic	HD-MC-A071063	1/1
Outline / Appearance	HD-AD-A071063	1/1
Outline / Appearance	HD-AD-B071063	1/1
Pin Layout	HD-BA-A071063	1/1

Rev. record

24-Aug.-2007> Ver.0.1

EYSMJCSTAIYO YUDEN Confidential
& Tentative

Control No. HD-AG-A071063	(1/3)	Control name General Items
------------------------------	-------	-------------------------------

Scope

This specification (“Specification”) applies to the hybrid IC “**EYSMJCS**” for use **Bluetooth**[®] module (“Product”) manufacture by TAIYO YUDEN Co., Ltd. (“TAIYO YUDEN”)

1. User’s Code: **EYSMJCS** (USB I/F Support)
Type: EYSMJCS
2. Function: Radio frequency transfer Module (power class 2). **Bluetooth**[®] standard Ver 2.0+EDR conformity
3. Application: Laptop PC
4. Structure: Hybrid IC loaded with silicon monolithic semiconductor
5. Outline: FFC/FPC Connector Type
6. Marking: TBD
7. Features:
 - Bluetooth**[®] 2.0+EDR conformity
 - USB Interface
 - Point-to-Multipoint (7 Slaves)
 - Encryption
 - Hold, Sniff and Park Mode
 - Supported Link Type: ACL
 - AFH
 - EDR (Enhanced Data Rate)
8. Packing: TBD
9. Terminal: Data input-output (6pin Cable Connector)
RF input-output (Antenna)
10. Mount: TBD
11. Notes:
 - a. Any question arising from this Specification shall be solved through mutual discussion by the parties hereof.
 - b. This Product is not designed for radiation durable and should not be used under the circumstance of radiation.

Control No. HD-AG-A071063	(2/3)	Control name General Items
------------------------------	-------	-------------------------------

- c. The operating conditions of this Product are as shown in this Specification. Please note that TAIYO YUDEN shall not be liable for a failure and/or abnormality which is caused by use under the conditions other than the operating conditions hereof.
- d. This Product mentioned in this Specification is manufactured for use in Laptop PC. Before using this Product in any special equipment (such as medical equipment, space equipment, air craft, disaster prevention equipment), where higher safety and reliability are duly required, the applicability and suitability of this Product must be fully evaluated by the customer at its sole risk to ensure correct and safety operation of those special equipments. Also, evaluation of the safety function of this Product even for use in general electronics equipment shall be thoroughly made and when necessary, a protective circuit shall be added in design stage, all at the customer's sole risk.
- e. TAIYO YUDEN warrants only that this Product is in conformity with this Specification for one year after purchase and shall in no event give any other warranty.
- f. The warranty period shall be one year.
- g. Communication between this Product and others might not be established nor maintained depending upon radio environment or operating conditions of this Product and other **Bluetooth**[®] products.
- h. This Product is designed for use in products which comply with **Bluetooth**[®] Specifications (Ver 2.0+EDR) ("Bluetooth Specifications"). TAIYO YUDEN disclaims and is not responsible for any liability concerning infringement by this Product under any intellectual property right owned by third party in case the customer uses this Product in any product which does not comply with Bluetooth Specifications (the "non-complying products"). Furthermore, TAIYO YUDEN warrants only that this Product complies with this Specification and does not grant any other warranty including warranty for application of the non-complying products.
- i. TAIYO YUDEN does not render updating or upgrading service for the firmware in the Module.
- j. In order to take tests for getting the certification of each country's Radio Law with a device incorporating this module, it is necessary to make the software in Host to put the module into test condition. Please contact TAIYO YUDEN for farther details.
- k. Please evaluate adequately our module incorporated to your products before mass production.
- l. This Product operates in the unlicensed ISM band at 2.4GHz. In case this Product is used around the other wireless devices which operate in same frequency band of this Product, there is a possibility that interference occurs between this Product and such other devices. If such interference occurs, please stop the operation of other devices or relocate this Product before using this Product or do not use this Product around the other wireless devices.

EYSMJCSTAIYO YUDEN Confidential
& Tentative

Control No. HD-AG-A071063	(3/3)	Control name General Items
------------------------------	-------	-------------------------------

m. Containment of hazardous substance in this Product

*Pb (Lead) : Non use

*Additional RoHS regulation substance (Cd.Hg.Cr+6.PBB.PBDE) :Non use

n. In addition when this Product is used under environmental conditions such as over voltage which are not guaranteed ,it may be destroyed in short mode. To ensure the security of customer's product, please add an extra fuse or/and a protection circuit for over voltage.

p. In some cases, TAIYO YUDEN may use replacements as component parts of Products. Such replacement shall apply only to component part of Products, which TAIYO YUDEN deems it possible to replace or substitute according to (i) Scope provided in this Specification (e.g. Official Standard (Type Approvals, Bluetooth LOGO etc.)) and (ii) Quality of Products. TAIYO YUDEN also ensures traceability of such replacement on production lot basis.

r. Do not alter Hardware and/or Software of this Product.

Please note that TAIYO YUDEN shall not be liable for any problem if it is caused by customer's alteration of Hardware or/and Software without Taiyo Yuden's prior approvals.

<p>This module is still under development, thus specifications do not guarantee both the quality and reliability at the time of shipment. Since the specifications and mass production of the module are not confirmed either, the contents of the technical notes are subject to change without any prior notice.</p>
--

EYSMJCSTAIYO YUDEN Confidential
& Tentative

Control No. HD-AM-A 071063 (1/1)	Control name Absolute maximum ratings
-------------------------------------	--

Absolute maximum ratings

Item	Symbol	Rating				Remark
		Min.	Typ.	Max.	Unit	
Supply voltage	VDD	-0.3		3.6	V	Ta=25 degrees C, GND reference
Input voltage	Vin	-0.3		VDD+0.3	V	I/O terminals except USB interface

Recommendation operating range

Item	Symbol	Rating				Remark
		Min.	Typ.	Max.	Unit	
Supply voltage	VDD	3.15	3.3	3.45	V	
Supply voltage ripple and spike noise	VDD_rn			(30)	mVp-p	Note 1
Operation temperature range	Topr	0	25	70	Degrees C	Humidity=40%RH Note 2
Storage temperature range	Tstg	-30	25	85	Degrees C	Humidity=40%RH Note 3

Notes:

- To fill the standard of "Supply voltage ripple and spike noise", the capacitor, which has the capacity of 2.2uF or more, should be put in the terminal VDD outside as a bypass capacitor .
- Operating temperature range is set to satisfy products electrical characteristics in the short term.
In terms of product life cycle when it is used in condition of varying from TYP standard in the long term, please refer to the reliability condition.
- Storage temperature range is the condition for transportation and storage in temporary.

EYSMJCSTAIYO YUDEN Confidential
& Tentative

Control No. HD-AE-A071063	(1/3)	Control name Electrical characteristics
------------------------------	-------	--

Electrical characteristic**DC Specifications**

The Specification applies for Topr.= 25 degrees C, VDD=3.3V

No.	Parameter	Condition	Symbol	Min.	Typ.	Max.	Unit	Remark
1	Normal supply voltage		VDD	3.15	3.3	3.45	V	
2	Input Low Voltage 1	/RESET, PIOX	VIL1	-0.3		0.8	V	
3	Input Low Voltage 2	USB_D+, USB_D-	VIL2	-		0.8	V	
4	Input High Voltage 1	/RESET, PIOX	VIH1	0.7xVDD		VDD+0.3	V	
5	Input High Voltage 2	USB_D+, USB_D-	VIH2	2.0		-	V	
6	Output Low Voltage 1	PIOX	VOL1	-		0.4	V	IOL=4mA
7	Output Low Voltage 2	USB_D+, USB_D-	VOL2	-		0.3	V	
8	Output High voltage 1	PIOX	VOH1	VDD-0.4		-	V	IOH=-4mA
9	Output High voltage 2	USB_D+, USB_D-	VOH2	2.8		-	V	
10	Peak current	Continuous Rx	Iccp1		(42)	(120)	mA	Notes 3, 4
11	Average current1	Sniff mode (Slave only)	Icca1		(10)	-	mA	Notes 1, 3, 4
12	Average current2	Standby mode	Icca2		(9)	-	mA	Notes 3, 4
13	Average current3	Send DM1packet (Master)	Icca3		(36)	-	mA	Notes 3, 4
14	Average current4	Receive DM1packet (Slave)	Icca4		(37)	-	mA	Notes 3, 4
15	Average current5	Hold mode (Slave only)	Icca5		(9)	-	mA	Notes 3, 4
16	Average current6	Park mode (Slave only)	Icca6		(9)	-	mA	Notes 2, 3, 4

Notes:

- Sniff mode parameter.
 - Max interval 0050h
 - Min interval 0010h
 - Attempt 0005h
 - Timeout 0005h
- Park mode parameter.
 - Max interval 0100h
 - Min interval 0010h
- The consumption current might fluctuate with the condition of radio communication, host performance and test circuit.
- The value may fluctuate several (mA) depending on Firmware version.

EYSMJCSTAIYO YUDEN Confidential
& Tentative

Control No. HD-AE-A071063 (2/3)	Control name Electrical characteristics
------------------------------------	--

AC Specifications

The Specification applies for Topr.= 25 degrees C, VDD=3.3V

No.	Parameter	Condition	Symbol	Min	Typ	Max	Unit	Remark
1	VDD Rise Time from 0V to 3.15V		t1	0		2	ms	Note 1
2	VDD= 3.15V to /RESET High		t2	10			ms	Note 2
3	/RESET High to Module Ready		t3		(100)	3000	ms	Notes 3, 4
4	/RESET Pulse Width		t4	6			ms	
5	DETACH High to USB I/F High-Z		t5			130	ms	
6	DETACH Low to USB I/F Active		t6	0		10	ms	
7	/RESET High to /RESET Low		t7	3000			ms	Note 5
8	/RESET Low to USB_I/F High-Z		t8	0		10	ms	
9	Module Active to /RESET Low		t9	0			ms	Note 5
10	/RESET Low to VDD_3.3V Off		t10	0			ms	

Notes:

1. This module has an internal flash memory and a function to erase/sort unnecessary data if certain HCI commands are issued and consume more than a certain level of free space in the flash memory. This operation occurs at every module initialization (power-on).

If supply voltage becomes non-defined states during initialization or writing in flash memory, data in flash memory might be destroyed. If the data in flash memory is destroyed, module will not work correctly. Therefore please be sure to stabilize power source before /RESET release.

In addition please design module peripheral circuits to avoid temporary blackout of power source during operation. Please refer HD-AE-C 071063 for HCI command which rewrites flash memory data.

2. Input /RESET signal of 10ms and more in condition of VDD_3.3V at over 3.15V.
3. When the module is ready to accept the command, its module outputs the "0F 04 00 01 00 00" (Hex) USB to the Data Line. After that, please access to the module.
4. The Typ. is a reference value. The value may change depending on the firmware version and conditions of use.
5. You don't need to wait t6 if you confirm that this module has output "0F 04 00 01 00 00" (Hex).

EYSMJCS

TAIYO YUDEN Confidential
& Tentative

Control No. HD-AE-A071063	(3/3)	Control name Electrical characteristics
------------------------------	-------	--

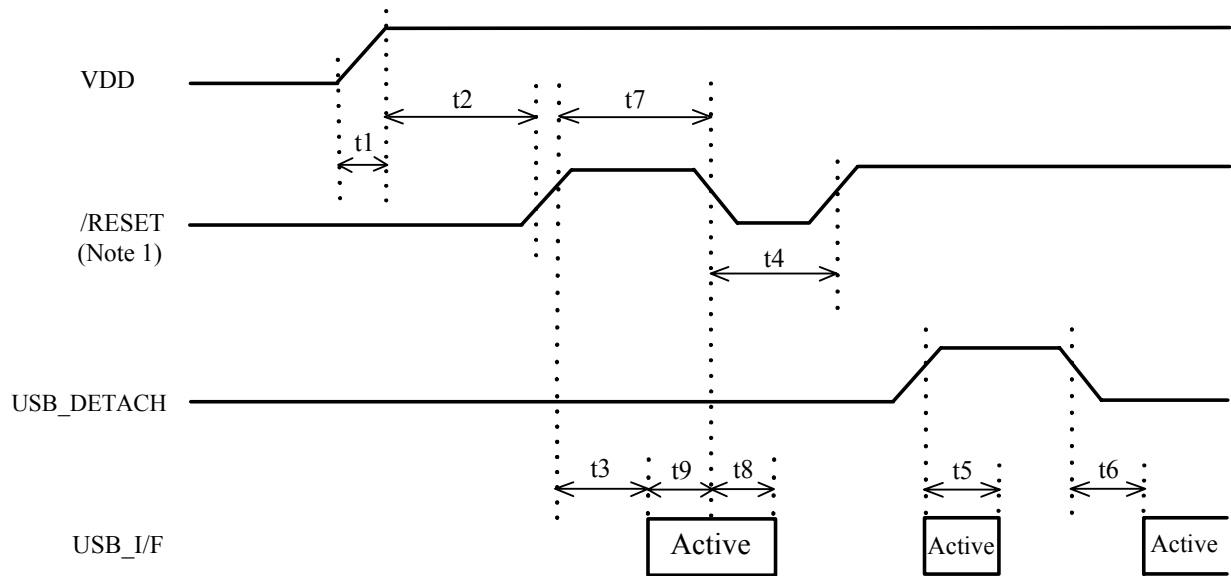

Timing Diagram for Power Up Sequence

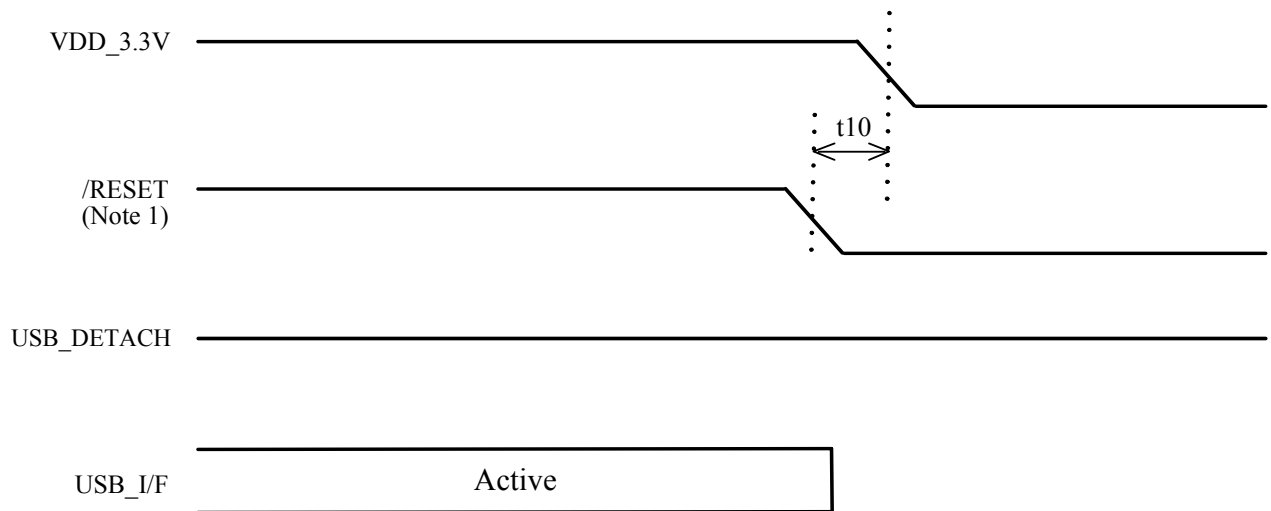

Timing Diagram for Power Down Sequence

EYSMJCSTAIYO YUDEN Confidential
& Tentative

Control No. HD-AE-B071063	(1/2)	Control name Electrical characteristics
------------------------------	-------	--

RF Specifications at Basic Rate

The Specification applies for Ta=25 degrees C, VDD=3.3V

No.	Parameter	Condition	Symbol	Min	Typ	Max	Unit	Remark
1	Frequency band		FREQ	2400		2483.5	MHz	
2	Tx power		PO	-6	0	+4	dBm	
3	Modulation characteristics 1	dF1: F0(11110000)	M1	140		175	kHz	
4	Modulation characteristics 2	dF2: AA(10101010)	M4	115			kHz	
5	Modulation characteristics 3	dF2/dF1	MC	0.8				
6	In-band spurious emission 2	2MHz(M-N =2)	ISE1			-20	dBm	
7	In-band spurious emission 3	3MHz or greater (M-N >=3)	ISE2			-40	dBm	
8	Initial Carrier Frequency		ICF	-75		+75	kHz	
9	Frequency Drift 1	DH1	FD1	-25		+25	kHz	
10	Frequency Drift 2	DH3,DH5	FD2	-40		+40	kHz	
11	Drift rate	DH1,DH3,DH5	DR			400	Hz/us	
12	C/I co-channel		CIC			11	dB	-60dBm
13	C/I 1MHz		CI1			0	dB	-60dBm
14	C/I 2MHz		CI2			-30	dB	-60dBm
15	C/I >= 3MHz		CI3			-40	dB	-67dBm
16	C/I Image		CI4			-9	dB	-3MHz offset -67dBm
17	C/I Image +/- 1MHz		CI5			-20	dB	-67dBm
18	Out-of-Band Blocking 1	30MHz to 2000MHz f=2460MHz	OBB1			-10	dBm	BER<=0.1 %
19	Out-of-Band Blocking 2	2000 to 2399MHz f=2460MHz	OBB2			-27	dBm	BER<=0.1 %
20	Out-of-Band Blocking 3	2484 to 3000MHz f=2460MHz	OBB3			-27	dBm	BER<=0.1 %
21	Out-of-Band Blocking 4	3000MHz to 12.75GHz f=2460MHz	OBB4			-10	dBm	BER<=0.1 %
22	Maximum Input Level		MAXP	-20			dBm	BER<=0.1 %
23	20dB Bandwidth		B20			1	MHz	
24	Sensitivity-single	DH1	SEN1			-70	dBm	BER<=0.1 %
25	Sensitivity-multi	DH3,DH5	SEN2			-70	dBm	BER<=0.1 %

EYSMJCSTAIYO YUDEN Confidential
& Tentative

Control No. HD-AE-B071063	(2/2)	Control name Electrical characteristics
------------------------------	-------	--

RF Specifications at EDR

The Specification applies for Ta=25 degrees C, VDD =3.3V

No.	Parameter	Condition	Symbol	Min	Typ	Max	Unit	Remark
1	RMS DEVM 1	Pai/4DQPSK	RDE1			0.20		
2	RMS DEVM 2	8DPSK	RDE2			0.13		
3	Peak DEVM 1	Pai/4DQPSK	PDE1			0.35		
4	Peak DEVM 2	8DPSK	PDE2			0.25		
5	99% DEVM 1	Pai/4DQPSK	D991			0.30		
6	99% DEVM 2	8DPSK	D992			0.20		
7	EDR In-band spurious emission 1	M-N =1	EISE1	26			dB	
8	EDR In-band spurious emission 2	M-N =2	EISE2			-20	dBm	
9	EDR In-band spurious emission 3	M-N =3	EISE3			-40	dBm	
10	EDR Initial Carrier Frequency		EICF	-75		+75	kHz	
11	EDR Drift		ED	-10		+10	kHz	
12	Relative transmit power	PDPSK	RTP	PGFSK -4		PGFSK +1	dB	
13	Actual Sensitivity Level	2-DH5(3-DH5) 16000000bit	ESEN			-70	dBm	BER= 10 ⁻⁴
14	BER Floor Performance	2-DH5(3-DH5) 160000000bit	FSEN			-60	dBm	BER= 10 ⁻⁵
15	C/I co-channel	2-DH5	2CIC			13	dB	-60dBm
16	C/I 1MHz	2-DH5	2CI1			0	dB	-60dBm
17	C/I 2MHz	2-DH5	2CI2			-30	dB	-60dBm
18	C/I >= 3MHz	2-DH5	2CI3			-40	dB	-67dBm
19	C/I Image	2-DH5	2CI4			-7	dB	-67dBm -3MHz offset
20	C/I Image +/- 1MHz	2-DH5	2CI5			-20	dB	-67dBm
21	C/I co-channel	3-DH5	3CIC			21	dB	-60dBm
22	C/I 1MHz	3-DH5	3CI1			5	dB	-60dBm
23	C/I 2MHz	3-DH5	3CI2			-25	dB	-60dBm
24	C/I >= 3MHz	3-DH5	3CI3			-33	dB	-67dBm
25	C/I Image	3-DH5	3CI4			0	dB	-67dBm -3MHz offset
26	C/I Image +/- 1MHz	3-DH5	3CI5			-13	dB	-67dBm
27	Maximum Input Level	2-DH5(3-DH5)	EMAX P	-20			dBm	

Note:

Bluetooth® standard Ver 2.0+EDR conformity

EYSMJCSTAIYO YUDEN Confidential
& Tentative

Control No. HD-AE-C071063 (1/13)	Control name Electrical characteristics
-------------------------------------	--

Supported HCI Commands / HCI Events

The **Bluetooth**® functions of this module is as written in the attached PICS. Depending on firmware version Upgrade, the **Bluetooth**® functions are subject to change without notice.

HCI COMMAND LIST

Firmware Version 21e (Build3164)

Command Description	OpCode	Group (Hex)	Command (Hex)	Parameters	Returns	Status	Notes
---------------------	--------	-------------	---------------	------------	---------	--------	-------

LINK CONTROL**Inquiry**

HCI_Inquiry	0x0401	1	1	LAP		Yes	
				Inquiry Length			
				Num Responses			
HCI_Inquiry_Cancel	0x0402	1	2		Status	Yes	
HCI_Periodic_Inquiry_Mode	0x0403	1	3	Max Period Length	Status	Yes	
				Min Period Length			
				LAP			
				Inquiry Length			
HCI_Exit_Periodic_Inquiry_Mode	0x0404	1	4	Num Responses	Status	Yes	

Connection Management

HCI_Create_Connection	0x0405	1	5	BD ADDR		Yes	a,b
				Packet Type			
				Page Scan Repetition Mode			
				Page Scan Mode			
				Clock Offset			
				Allow Role Switch			
HCI_Disconnect	0x0406	1	6	Connection Handle		Yes	b
				Reason			
HCI_Add_SCO_Connection	0x0407	1	7	SCO Handle		Yes	b,c,d,j,p
				Packet Type			
HCI_Create_Connection_Cancel	0x0408	1	8	BD ADDR	Status BD_ADDR	Yes	l
HCI_Accept_Connection_Request	0x0409	1	9	BD ADDR Role		Yes	
HCI_Reject_Connection_Request	0x040A	1	A	BD ADDR		Yes	
HCI_Change_Connection_Packet_Type	0x040F	1	F	Connection Handle		Yes	
				Packet Type			
HCI_Setup_Synchronous_Connection	0x0428	1	28	Connection Handle		Yes	l,m,o,p
				Transmit Bandwidth			
				Receive Bandwidth			
				Max Latency			
				Voice Setting			
				Retransmission Effort			
				Packet Type			
HCI_Accept_Synchronous_Connection_Request	0x0429	1	29	BD ADDR		Yes	l,m,o
				Transmit Bandwidth			
				Receive Bandwidth			
				Max Latency			
				Content Format			
				Retransmission Effort			
HCI_Reject_Synchronous_Connection_Request	0x042A	1	2A	BD ADDR		Yes	l,m,o
				Reason			

EYSMJCSTAIYO YUDEN Confidential
& Tentative

Control No. HD-AE-C071063	(2/13)	Control name Electrical characteristics
------------------------------	--------	--

Authentication / Pairing

HCI_Link_Key_Request_Reply	0x040B	1	B	BD ADDR	Status	Yes	
				Link Key	BD ADDR		
HCI_Link_Key_Request_Negative_Reply	0x040C	1	C	BD ADDR	Status	Yes	
					BD ADDR		
HCI_PIN_Code_Request_Reply	0x040D	1	D	BD ADDR	Status	Yes	
				PIN Code Length	BD ADDR		
				PIN Code			
HCI_PIN_Code_Request_Negative_Reply	0x040E	1	E	BD ADDR	Status	Yes	
					BD ADDR		
HCI_Authentication_Requested	0x0411	1	11	Connection Handle		Yes	
HCI_Change_Connection_Link_Key	0x0415	1	15	Connection Handle		Yes	

Encryption

HCI_Set_Connection_Encryption	0x0413	1	13	Connection Handle		Yes	
				Encryption Enable			
HCI_Master_Link_Key	0x0417	1	17	Key Flag		Yes	

Remote Information

HCI_Remote_Name_Request	0x0419	1	19	BD ADDR		Yes	
				Page Scan Repetition Mode			
				Page Scan Mode			
				Clock Offset			
HCI_Remote_Name_Request_Cancel	0x041A	1	1A	BD_ADDR	Status	Yes	1
					BD_ADDR		
HCI_Read_Remote_Supported_Features	0x041B	1	1B	Connection Handle		Yes	
HCI_Read_Remote_Extended_Features	0x041C	1	1C	Connection Handle		Yes	1
				Page Number			
HCI_Read_Remote_Version_Information	0x041D	1	1D	Connection Handle		Yes	
HCI_Read_Clock_Offset	0x041F	1	1F	Connection Handle		Yes	
HCI_Read_LMP_Handle	0x0420	1	20	Connection Handle	Status	Yes	1
					Connection Handle		
					LMP_Handle		
					Reseved		

EYSMJCSTAIYO YUDEN Confidential
& Tentative

Control No. HD-AE-C071063	(3/13)	Control name Electrical characteristics
------------------------------	--------	--

LINK POLICY

HCI_Hold_Mode	0x0801	2	1	Connection Handle		Yes	
				Hold Mode Max Interval			
				Hold Mode Min Interval			
HCI_Sniff_Mode	0x0803	2	3	Connection Handle		Yes	
				Sniff Mode Max Interval			
				Sniff Mode Min Interval			
				Sniff Attempt			
HCI_Exit_Sniff_Mode	0x0804	2	4	Connection Handle		Yes	
HCI_Park_State	0x0805	2	5	Connection Handle		Yes	k
				Beacon Max Interval			
				Beacon Min Interval			
HCI_Exit_Park_State	0x0806	2	6	Connection Handle		Yes	k
HIC_QoS_Setup	0x0807	2	7	Connection Handle		Yes	e,m
				Flags			
				Service Type			
				Token Rate			
				Peak Bandwidth			
				Latency			
HCI_Role_Discovery	0x0809	2	9	Connection Handle	Status	Yes	
				Connection Handle	Current Role		
HCI_Switch_Role	0x080B	2	B	BD ADDR		Yes	
HCI_Read_Link_Policy_Settings	0x080C	2	C	Connection Handle	States	Yes	
					Connection Handle		
					Link Policy Settings		
HCI_Write_Link_Policy_Settings	0x080D	2	D	Connection Handle	States	Yes	
					Connection Handle		
					Link Policy settings		
HCI_Read_Default_Link_Policy_Settings	0x080E	2	E		Status	Yes	l
					Default Link Policy Settings		
HCI_Write_Default_Link_Policy_Settings	0x080F	2	F	Default Link Policy Settings	Status	Yes	l
HCI_Flow_Specification	0x0810	2	10	Connection Handle		No	l,m
				Flags			
				Flow direction			
				Service Type			
				Token Rate			
				Token Bucket Size			
				Peak Bandwidth			
				Access Latency			

EYSMJCSTAIYO YUDEN Confidential
& Tentative

Control No. HD-AE-C071063	(4/13)	Control name Electrical characteristics
------------------------------	--------	--

HOST CONTROLLER & BASEBAND

HCI_Set_Event_Mask	0x0C01	3	1	Event Mask	States	Yes	
HCI_Reset	0x0C03	3	3		States	Yes	
HCI_Set_Event_Filter	0x0C05	3	5	Filter Type	States	Yes	
				Filter Condition Type			
				Condition			
HCI_Flush	0x0C08	3	8	Connection Handle	States	Yes	
					Connection Handle		
HCI_Read_PIN_Type	0x0C09	3	9		States	Yes	
HCI_Write_PIN_Type	0x0C0A	3	A	PIN Type	States	Yes	
HCI_Create_New_Unit_Key	0x0C0B	3	B		States	Yes	
HCI_Read_Stored_Link_Key	0x0C0D	3	D	BD ADDR	States	Yes	
				Read All Flag	Max Num Keys		
					Num Keys Read		
HCI_Write_Stored_Link_Key	0x0C11	3	11	Num Keys To Write	States	Yes	n
				BD ADDR [I]	Num Keys Written		
				Link Key [I]			
HCI_Delete_Stored_Link_Key	0x0C12	3	12	BD ADDR	States	Yes	n
				Delete All Flag	Num Keys Deleted		
HCI_Write_Local_Name	0x0C13	3	13	Local Name	States	Yes	f,k
HCI_Read_Local_Name	0x0C14	3	14		States	Yes	
					Local Name		
HCI_Read_Connection_Accept_Timeout	0x0C15	3	15		States	Yes	
					Conn Accept Timeout		
HCI_Write_Connection_Accept_Timeout	0x0C16	3	16	Conn Accept Timeout	States	Yes	
HCI_Read_Page_Timeout	0x0C17	3	17		States	Yes	
					Page Timeout		
HCI_Write_Page_Timeout	0x0C18	3	18	Page Timeout	States	Yes	
HCI_Read_Scan_Enable	0x0C19	3	19		States	Yes	
					Scan Enable		
HCI_Write_Scan_Enable	0x0C1A	3	1A	Scan Enable	States	Yes	
HCI_Read_Page_Scan_Activity	0x0C1B	3	1B		States	Yes	
					Page Scan Interval		
					Page Scan Window		
HCI_Write_Page_Scan_Activity	0x0C1C	3	1C	Page Scan Interval	States	Yes	
				Page Scan Window			
HCI_Read_Inquiry_Scan_Activity	0x0C1D	3	1D		States	Yes	
					Inquiry Scan Interval		
					Inquiry Scan Window		
HCI_Write_Inquiry_Scan_Activity	0x0C1E	3	1E	Inquiry Scan Interval	States	Yes	
				Inquiry Scan Window			
HCI_Read_Authentication_Enable	0x0C1F	3	1F		States	Yes	
					Authentication Enable		
HCI_Write_Authentication_Enable	0x0C20	3	20	Authentication Enable	States	Yes	
HCI_Read_Encryption_Mode	0x0C21	3	21		States	Yes	
					Encryption Mode		
HCI_Write_Encryption_Mode	0x0C22	3	22	Encryption Mode	States	Yes	
HCI_Read_Class_of_Device	0x0C23	3	23		States	Yes	
					Class of Device		
HCI_Write_Class_of_Device	0x0C24	3	24	Class of Device	States	Yes	
HCI_Read_Voice_Setting	0x0C25	3	25		States	Yes	
					Voice Setting		
HCI_Write_Voice_Setting	0x0C26	3	26	Voice Channel setting	States	Yes	

EYSMJCS

TAIYO YUDEN Confidential
& Tentative

Control No. HD-AE-C071063	(5/13)	Control name Electrical characteristics
------------------------------	--------	--

HCI_Read_Automatic_Flush_Timeout	0x0C27	3	27	Connection Handle	States Connection Handle Flush Timeout	Yes	
HCI_Write_Automatic_Flush_Timeout	0x0C28	3	28	Connection Handle Flash Timeout	States Connection Handle	Yes	
HCI_Read_Num_Broadcast_Retransmission	0x0C29	3	29		States	Yes	
HCI_Write_Num_Broadcast_Retransmission	0x0C2A	3	2A	Num Broadcast Retransmission	States	Yes	
HCI_Read_Hold_Mode_Activity	0x0C2B	3	2B		States Hold Mode Activity	Yes	
HCI_Write_Hold_Mode_Activity	0x0C2C	3	2C	Hold Mode Activity	States	Yes	
HCI_Read_Transmit_Power_Level	0x0C2D	3	2D	Connection Handle Type	States Connection Handle Power Level	Yes	
HCI_Read_Synchronous_Flow_Control_Enable	0x0C2E	3	2E		States Synchronous Flow Control Enable	No	c,d,k
HCI_Write_Synchronous_Flow_Control_Enable	0x0C2F	3	2F	Synchronous Flow Control Enable	States	No	c,d,k
HCI_Set_Controller_To_Host_Flow_Control	0x0C31	3	31	Flow Control Enable	States	Yes	k
HCI_Host_Buffer_Size	0x0C33	3	33	Host ACL Data Packet Length Host SCO Data Packet Length Host Total Num ACL Data Packets Host Total Num SCO Data Packets	States	Yes	
HCI_Host_Number_Of_Completed_Packets	0x0C35	3	35	Number of Handles Connection handle [I] Host Num of Completed Packets [I]		Yes	
HCI_Read_Link_Supervision_Timeout	0x0C36	3	36	Connection Handle	States Connection Handle Link Supervision Timeout	Yes	
HCI_Write_Link_Supervision_Timeout	0x0C37	3	37	Connection Handle Link Supervision Timeout	States Connection Handle	Yes	
HCI_Read_Number_Of_Support_IAC	0x0C38	3	38		States Num Support IAC	Yes	
HCI_Read_Current_IAC_LAP	0x0C39	3	39		States Num Current IAC IAC LAP [I]	Yes	
HCI_Write_Current_IAC_LAP	0x0C3A	3	3A	Num Current IAC IAC LAP [I]	States	Yes	
HCI_Read_Page_Scan_Period_Mode	0x0C3B	3	3B		States Page Scan Period Mode	Yes	
HCI_Write_Page_Scan_Period_Mode	0x0C3C	3	3C	Page Scan Period Mode	States	Yes	
HCI_Read_Page_Scan_Mode	0x0C3D	3	3D		States Page Scan Mode	Yes	j
HCI_Write_Page_Scan_Mode	0x0C3E	3	3E	Page Scan Mode	States	Yes	h,j
HCI_Set_AFH_Host_Channel_Classification	0x0C3F	3	3F	AH Host Channel Classification	Status	Yes	l

EYSMJCSTAIYO YUDEN Confidential
& Tentative

Control No. HD-AE-C071063	(6/13)	Control name Electrical characteristics
------------------------------	--------	--

HCI_Read_Inquiry_Scan_Type	0x0C42	3	42		Status	Yes	1
					Inquiry Scan Type		
HCI_Write_Inquiry_Scan_Type	0x0C43	3	43	Inquiry Scan Type	Status	Yes	1
					Status		
HCI_Read_Inquiry_Mode	0x0C44	3	44		Inquiry Mode	Yes	1
HCI_Write_Inquiry_Mode	0x0C45	3	45	Inquiry Mode	Status	Yes	1
					Status		
HCI_Read_Page_Scan_Type	0x0C46	3	46		Page Scan Type	Yes	1
HCI_Write_Page_Scan_Type	0x0C47	3	47	Page Scan Type	Status	Yes	1
					Status		
HCI_Read_AFH_Channel_Assessment_Mode	0x0C48	3	48		AFH Channel Assessment Mode	Yes	1
HCI_Write_AFH_Channel_Assessment_Mode	0x0C49	3	49	AFH Channel Assessment Mode	Status	Yes	1

INFORMATIONAL PARAMETERS

HCI_Read_Local_Version_Information	0x1001	4	1		Status	Yes	
					HCI Version		
					HCI Revision		
					LMP Version		
					Manufacturer Name		
HCI_Read_Local_Supported_Commands	0x1002	4	2		LMP Subversion	Yes	1
					Status		
HCI_Read_Local_Supported_Features	0x1003	4	3		Supported Commands	Yes	
					LMP Features		
HCI_Read_Local_Extended_Features	0x1004	4	4	Page number	Status	Yes	1
					Page number		
					Maximum Page Number		
					Extended LMP Features		
HCI_Read_Buffer_Size	0x1005	4	5		Status	Yes	
					HC ACL Data Packet Length		
					HC Synchronous Data Packet Length		
					HC Total Num ACL Data Packet		
					HC Total Num Synchronous Data Packe		
HCI_Read_Country_Code	0x1007	4	7		Status	Yes	j
					Country Code		
HCI_Read_BD_ADDR	0x1009	4	9		Status	Yes	
					BD ADDR		

EYSMJCSTAIYO YUDEN Confidential
& Tentative

Control No. HD-AE-C071063	(7/13)	Control name Electrical characteristics
------------------------------	--------	--

STAUS PARAMETERS

HCI_Read_Failed_Contact _Counter	0x1401	5	1	Connection Handle	Status	Yes	
					Connection handle		
					Failed Contact Counter		
HCI_Reset_Failed_Contact _Counter	0x1402	5	2	Connection Handle	Status	Yes	
					Connection handle		
HCI_Read_Link_Quality	0x1403	5	3	Connection Handle	Status	Yes	k
					Connection Handle		
					Link Quality		
HCI_Read_RSSI	0x1405	5	5	Connection Handle	Status	Yes	
					Connection Handle		
					RSSI		
HCI_Read_AFH_Channel_Map	0x1406	5	6	Connection Handle	Status	Yes	l
					Connection Handle		
					AFH Mode		
					AFH Channel Map		
HCI_Read_Clock	0x1407	5	7	Which Clock	Status	Yes	l
				Connection Handle	Connection Handle		
					AFH Mode		
					AFH Channel Map		

TESTING

HCI_Read_Loopback_Mode	0x1801	6	1		States	Yes	
					Loopback Mode		
HCI_Write_Loopback_Mode	0x1802	6	2	Loopback Mode	States	Yes	g,i
HCI_Enable_Device_Under_Test _Mode	0x1803	6	3		States	Yes	

EYSMJCSTAIYO YUDEN Confidential
& Tentative

Control No. HD-AE-C071063	(8/13)	Control name Electrical characteristics
------------------------------	--------	--

Notes:

- a) Up to seven connections: a slave of up to two masters, and/or a master of up to seven slave.
Some operations restricted or non-functional in a scatternet.
- b) Chip resource limits constrain the rate at which ACL and SCO connections can be made and broken to approximately 20 per 15 seconds. The time limit can be configured.
- b) Up to three SCO links. Each SCO link can be routed over the chip's PCM interface or over HCI/BCSP.
Preliminary Support for SCO over USB or H4 is in place, but testing has been light.
- d) No HCI SCO Host Controller to Host flow control support.
No HCI SCO Host to Host Controller flow control support.
- e) Limited support for "best effort" and "guaranteed" Qos only.
- f) Initial device name taken from PS Keys, and so is maintained through a reset/reboot.
- g) HCI Reset does not work if the device is in local loopback mode.
- h) Optional Paging schemes are not supported.
- i) Remote ACL loopback sometimes deadlocks when the device's flow control mechanisms assert to each other.
- j) Bluetooth v1.1 specification command, deprecated in the v1.2 specification, or later; support retained for backwards compatibility.
- k) Bluetooth v1.1 specification command, renamed in the v1.2 specification, or later.
Park Mode ---> Park State
Exit Park Mode ---> Exit Park State
Set Host Controller To Host Flow Control ---> Set Controller To Host Flow Control
Change Local Name ---> Write Local Name
Read SCO Flow Control Enable ---> Read Synchronous Flow Control Enable
Write SCO Flow Control Enable ---> Write Synchronous Flow Control Enable
Get Link Quality ---> Read Link Quality
- l) Command not in the Bluetooth v1.1 specification.
- m) Underlying Flow_Specification functionality the same as for QoS_Setup.
- n) Command which rewrites FROM in module
- p) CVSD not available with 3EV3 or 3EV5 EDR packets.
- q) HCI Setup Synchronous Connection command does not support HV1, HV2 and HV3 Packet Type. If you want to use those Packet Types, please use HCI Add SCO connection command.

Control No. HD-AE-C071063	(9/13)	Control name Electrical characteristics
------------------------------	--------	--

HCI EVENT LIST

Event Description	OpCode	Parameters	Status	Notes
-------------------	--------	------------	--------	-------

Inquiry

Inquiry_Complete	0x01	Status	Yes	
Inquiry_Result	0x02	Num Responses	Yes	
		BD ADDR [I]		
		Page Scan Repetition Mode [I]		
		Page Scan Period Mode [I]		
		Page Scan Mode [I]		
		Class of Device [I]		
Inquiry_Result_with_RSSI	0x22	Clock Offset [I]	Yes	b
		Num Responses		
		BD ADDR [I]		
		Page Scan Repetition Mode [I]		
		Page Scan Period Mode [I]		
		Page Scan Mode [I]		
		Class of Device [I]		
RSSI [I]				

Connection Management

Connection_Complete	0x03	Status	Yes	
		Connection Handle		
		BD ADDR		
		Link Type		
Connection_Request	0x04	Encryption Mode	Yes	
		BD ADDR		
		Class of Device		
Disconnection_Complete	0x05	Link Type	Yes	
		Status		
		Connection Handle		
Synchronous_Connection_Complete	0x2C	Reason	Yes	b
		Status		
		Connection Handle		
		BD ADDR		
		Link Type		
		Transmission Interval		
		Retransmission Window		
		Rx Packet Length		
Tx Packet Length				
Synchronous_Connection_Changed	0x2D	Air Mode	Yes	b
		Status		
		Connection Handle		
		Transmission Interval		
		Retransmission Window		
Rx Packet Length				
		Tx Packet Length		

Control No. HD-AE-C071063	(10/13)	Control name Electrical characteristics
------------------------------	---------	--

Authentication / Pairing

Authentication _Complete	0x06	Status	Yes	
		Connection Handle		
Return _Link _Keys	0x15	Num Keys	Yes	
		BD ADDR [I]		
		Link Key [I]		
PIN _Code _Request	0x16	BD ADDR	Yes	
Link _Key _Request	0x17	BD ADDR	Yes	
Link _Key _Notification	0x18	BD ADDR	Yes	
		Link Key		

Encryption

Encryption _Change	0x08	Status	Yes	
		Connection Handle		
		Encryption Enable		
Change _Connection _Link _Key _Complete	0x09	Status	Yes	
		Connection Handle		
Master _Link _Key _Complete	0x0A	Status	Yes	
		Connection Handle		
		Key Flag		

Remote Information

Remote _Name _Request _Complete	0x07	Status	Yes	
		BD ADDR		
		Remote Name		
Read _Remote _Supported _Features _Complete	0x0B	Status	Yes	
		Connection Handle		
		LMP Features		
Read _Remote _Version _Information _Complete	0x0C	Status	Yes	
		Connection Handle		
		LMP Version		
		Manufacture Name		
Read _Remote _Extended _Features _Complete	0x23	LMP Subversion	Yes	b
		Status		
		Connection Handle		
		Page Number		
		Maximum page number		
Extended LMP Features				

Control No. HD-AE-C071063	(11/13)	Control name Electrical characteristics
------------------------------	---------	--

Link Policy

QoS_Setup_Complete	0x0D	Status	Yes	
		Connection Handle		
		Flags		
		Service Type		
		Token Rate		
		Peak Bandwidth		
		Latency		
Role_Change	0x12	Status	Yes	
		BD ADDR		
		New Role		
Mode_Change	0x14	Status	Yes	
		Connection Handle		
		Current Mode		
		Interval		
Flow_Specification_Complete	0x21	Status	Yes	b,c
		Connection Handle		
		Flags		
		Flow direction		
		Service Type		
		Token Rate		
		Token Bucket Size		
		Peak Bandwidth		
Access Latency				

General

Command_Complete	0x0E	Num HCI Command Packets	Yes	
		Command Opcode		
		Return Parameters		
Command_Status	0x0F	Status	Yes	
		Num HCI Command Packets		
		Command Opcode		
Hardware_Error	0x10	Hardware Code	Yes	
Number_Of_Completed_Packets	0x13	Number of Handles	Yes	
		Connection Handle [I]		
		HC Num HCI Data Packets [I]		
Data_Buffer_Overflow	0x1A	Link Type	No	a
Max_Slots_Change	0x1B	Connection Handle	Yes	
		LMP Max Slots		
Read_Clock_Offset_Complete	0x1C	Status	Yes	
		Connection Handle		
		Clock Offset		

Host Controller & Baseband

Flush_Occurred	0x11	Connection Handle	Yes	
Loopback_Command	0x19	HCI Command Packet	Yes	
Connection_Packet_Type_Change	0x1D	Status	Yes	
		Connection Handle		
		Packet Type		
QoS_Violation	0x1E	Connection Handle	No	
Page_Scan_Mode_Change	0x1F	BD ADDR	No	d
		Page Scan Mode		
Page_Scan_Repetition_Mode_Change	0x20	BD ADDR	Yes	
		Page Scan Repetition Mode		

EYSMJCSTAIYO YUDEN Confidential
& Tentative

Control No. HD-AE-C071063	(12/13)	Control name Electrical characteristics
------------------------------	---------	--

Notes:

- a) Significance and expected recovery procedure is ill defined.
- b) Event not in the Bluetooth v1.1 specification.
- c) Event provoked by local Flow Specification command, even through the command is not implemented.
- d) Optional paging schemes not supported. Bluetooth v1.1 specification only.

Control No. HD-AE-C071063	(13/13)	Control name Electrical characteristics
------------------------------	---------	--

Module Stack

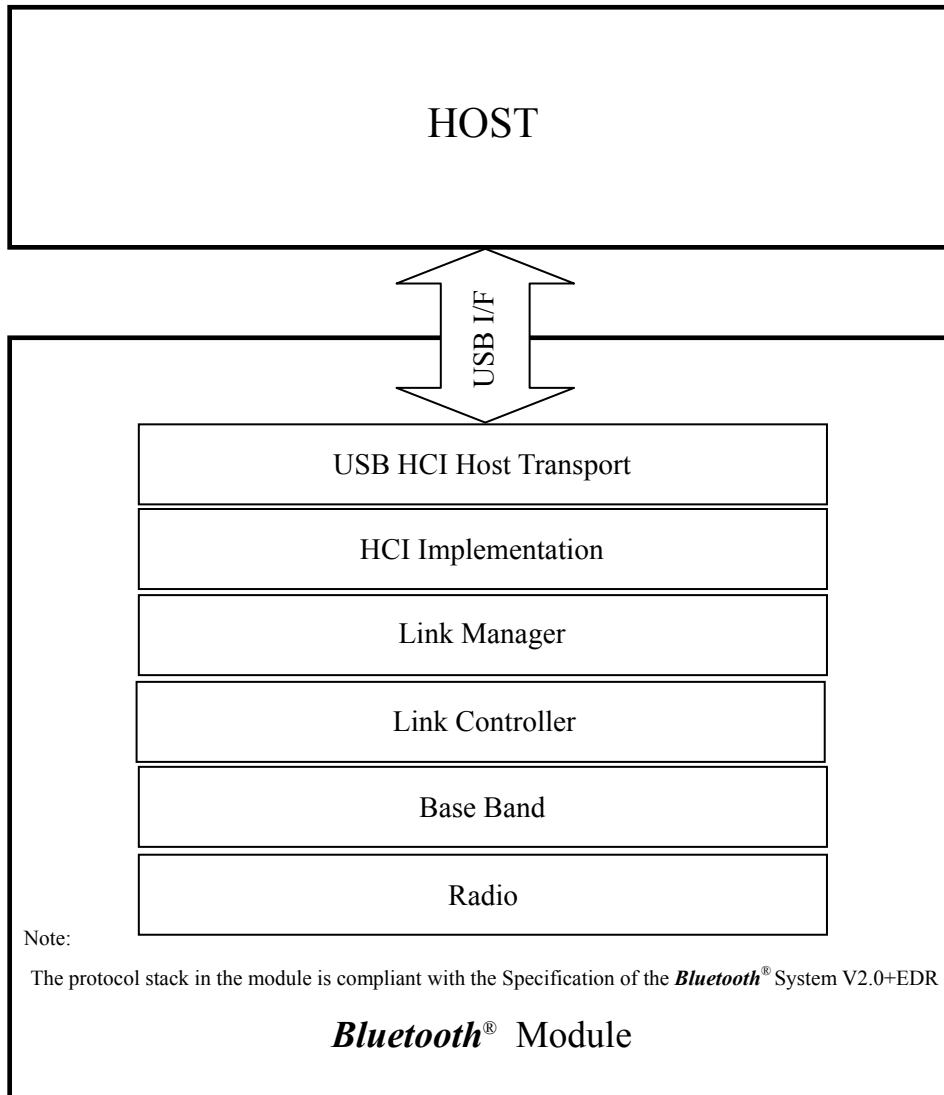

Control No. HD-AE-D071063	(1/10)	Control name Electrical characteristics
------------------------------	--------	--

PICS for Firmware Version 21d (Build3059)

The **Bluetooth**[®] functions of this module are as below. Depending on firmware version upgrade, the **Bluetooth**[®] functions are subject to change without notice.

SUMMARY**Table 2-1: Controller Core Specification**

Item	Specification Name	Support
1	Core Spec Version 1.1, Adopted 5 Feb 2001 (Ver. 1.1)	No
2	Core Spec Version 1.2, Adopted 5 Nov 2003 (Ver. 1.2)	No
3	Core Spec Version 2.0, Adopted 4 Nov 2004 (Ver. 2.0)	No
4	Core Spec Version 2.0 + EDR, Adopted 4 Nov 2004(Ver. 2.0 + EDR)	Yes

Table 2-2: EDR Features

Prerequisite: 2-1/4 (Ver. 2.0 + EDR)

Item	Feature	Support
1	EDR for asynchronous transports (single slot)	Yes
2	EDR for asynchronous transports (multi-slot)	Yes
3	EDR for synchronous transports	Yes

RF**RF Capabilities (based on PICS proforma for Radio):****Table A.1: RF Capabilities**

Item	Capability	Status	Support	Values	
				Allowed	Supported
1	Power Class (1,2 or 3)	M	Yes	1 .. 3	2
2	Power Control	C.1	Yes	-	-
3	1-slot packets supported	M	Yes	-	-
4	3-slot packets supported	O	Yes	-	-
5	5-slot packets supported	O	Yes	-	-
6	79 Channels	M	Yes	-	-
7	Support for GFSK modulation	M	Yes	-	-
8	Support for $\pi/4$ -DQPSK modulation	C.2	Yes	-	-
9	Support for 8DPSK modulation	C.3	Yes	-	-

C.1: Mandatory to support if Power Class 1 is supported, optional to support if Power Class 2 or 3 is supported.

C.2: Mandatory if SUMMARY, 2-1/4 is claimed; Optional if SUMMARY, 2-1/3 is claimed; Excluded otherwise.

C.3: Mandatory if SUMMARY, 2-1/4 is claimed; Else Optional if (RF, 1/8 AND SUMMARY, 2-1/3) is claimed;

Excluded otherwise.

Control No. HD-AE-D071063	(2/10)	Control name Electrical characteristics
------------------------------	--------	--

Baseband**Baseband Capabilities (based on PICS proforma for Baseband)****Table B.1: Physical Channel**

Item	Capability	Status	Support
1	Support frequency band and 79 RF channels	M	Yes
2	Adaptive Frequency Hopping Kernel	M	Yes

Table B.1a: Modulation schemes

Item	Capability	Status	Support
1	Basic Data Rate, 1 Mbps payload data rate	M	Yes
2	Enhanced Data Rate, 2 Mbps payload data rate	C.1	Yes
3	Enhanced Data Rate, 3 Mbps payload data rate	C.2	Yes

C.1: Mandatory if (SUMMARY, 2-1/4) is claimed; Optional if (SUMMARY, 2-1/3) is claimed; Excluded otherwise.

C.2: Mandatory if (SUMMARY, 2-1/4) is claimed; Optional if (BB, 1a/2 AND SUMMARY, 2-1/3) is claimed;

Excluded otherwise.

Table B.2: Link Types

Item	Capability	Status	Support
1	Support of ACL link	M	Yes
2	Support of SCO link	O	Yes
3	Support of eSCO link	O	Yes
4	Support of Enhanced Data Rate ACL links	C.1	Yes
5	Support of Enhanced Data Rate eSCO links	C.2	Yes

C.1: Mandatory IF (SUMMARY, 2-2/1 OR SUMMARY, 2-2/2) is claimed;

ELSE Optional IF (SUMMARY, 2-1/3 OR SUMMARY, 2-1/4) is claimed; Excluded otherwise.

C.2: Mandatory IF SUMMARY, 2-2/3 is claimed; ELSE Optional IF (SUMMARY, 2-1/3 OR SUMMARY, 2-1/4) is claimed;

Excluded otherwise.

Table B.3: SCO Link Support

Prerequisite: B.2/2 (Support of SCO link)

Item	Capability	Status	Support	Values	
				Allowed	Supported
1	SCO links to same Slave	C.1	Yes	1 .. 3	3
2	SCO links to different Slaves	O	Yes	1 .. 3	3
3	SCO links from same Master	C.1	Yes	1.. 3	3
4	SCO links from different Masters	O	No	2	-

C.1: Mandatory to support at least 1 link.

Prerequisite: B.2/3 (Support of eSCO link)

Item	Capability	Status	Support	Values	
				Allowed	Supported
5	eSCO links to same Slave	C.2	Yes	(1 .. 6)	6
6	eSCO links to different Slaves	O	Yes	(2 .. 5)	3
7	eSCO links from same Master	C.2	Yes	(1 .. 6)	6
8	eSCO links from different Masters	O	No	(2 ..)	-

C.2: Mandatory to support at least 1 link.

Control No. HD-AE-D071063	(3/10)	Control name Electrical characteristics
------------------------------	--------	--

Table B.4: Common Packet Types

Item	Capability	Status	Support
1	Support of ID packet type	M	Yes
2	Support of NULL packet type	M	Yes
3	Support of POLL packet type	M	Yes
4	Support of FHS packet type	M	Yes
5	Support of DM1 packet type	M	Yes

Table B.5: ACL Packet Types

Item	Capability	Status	Support
1	Support of DH1 packet type	M	Yes
2	Support of DM3 packet type	O	Yes
3	Support of DH3 packet type	O	Yes
4	Support of DM5 packet type	O	Yes
5	Support of DH5 packet type	O	Yes
6	Support of AUX1 packet type	O	Yes

Table B.5a: Enhanced Data Rate ACL packet types

Prerequisite: B.2/4 (Support of Enhanced Data Rate ACL links)

Item	Capability	Status	Support
1	Support 2-DH1 packet type	C.1	Yes
2	Support 2-DH3 packet type	C.2	Yes
3	Support 2-DH5 packet type	C.2	Yes
4	Support 3-DH1 packet type	C.3	Yes
5	Support 3-DH3 packet type	C.4	Yes
6	Support 3-DH5 packet type	C.5	Yes

C.1: Mandatory IF (SUMMARY, 2-2/1 OR SUMMARY, 2-2/2) is claimed; ELSE Optional IF BB, 1a/2 is claimed;

Excluded otherwise.

C.2: Mandatory IF SUMMARY, 2-2/2 is claimed; ELSE Optional IF BB, 1a/2 is claimed; Excluded otherwise.

C.3: Mandatory IF (SUMMARY, 2-2/1 OR SUMMARY, 2-2/2) is claimed; ELSE Optional IF BB 1a/3 is claimed;

Excluded otherwise.

C.4: Mandatory IF SUMMARY, 2-2/2 is claimed; ELSE Optional IF (BB, 5a/2 AND BB, 5a/4) is claimed;

Excluded otherwise.

C.5: Mandatory IF SUMMARY 2-2/2 is claimed; ELSE Optional IF (BB, 5a/3 AND BB, 5a/4) is claimed; Excluded otherwise.

Table B.6: SCO and eSCO Packet Types

Prerequisite for items 1-4: B.2/2 (Support of SCO link)

Item	Capability	Status	Support
1	Support of HV1 packet type	M	Yes
2	Support of HV2 packet type	O	Yes
3	Support of HV3 packet type	O	Yes
4	Support of DV packet type	M	Yes

Prerequisite for items 5-7: B.2/3 (Support of eSCO link)

Item	Capability	Status	Support
5	Support of EV3 packet type	M	Yes
6	Support of EV4 packet type	O	Yes
7	Support of EV5 packet type	O	Yes

Control No. HD-AE-D071063	(4/10)	Control name Electrical characteristics
------------------------------	--------	--

Table B.6a: Enhanced Data Rate eSCO packet types

Prerequisite: B.2/5 (Support of Enhanced Data Rate eSCO links)

Item	Capability	Status	Support
1	Support 2-EV3 packet type	C.1	Yes
2	Support 2-EV5 packet type	C.2	Yes
3	Support 3-EV3 packet type	C.3	Yes
4	Support 3-EV5 packet type	C.4	Yes

C.1: Mandatory IF SUMMARY, 2-2/3 is claimed; ELSE Optional IF BB, 1a/2 is claimed; Excluded otherwise.

C.2: Optional IF BB, 1a/2 is claimed; Excluded otherwise.

C.3: Mandatory IF SUMMARY, 2-2/3 is claimed; ELSE Optional IF BB, 1a/3 is claimed; Excluded otherwise.

C.4: Optional IF BB, 1a/3 is claimed; Excluded otherwise.

Table B.7: Page Procedures

Item	Capability	Status	Support
1	Support paging	M	Yes
2	Support page scan	M	Yes
3			
4			
5	Supports Interlaced Scan during page scan	O	Yes

Table B.8: Paging Schemes

Item	Capability	Status	Support
1	Supports mandatory scan mode)	M	Yes

Table B.9: Paging Modes

Item	Capability	Status	Support
1	Supports paging mode R0	C.1	Yes
2	Supports paging mode R1	C.1	Yes
3	Supports paging mode R2	C.1	Yes

C.1: At least one of the paging scan modes must be supported.

Table B.9 (b): Paging Train Repetition

Item	Capability	Status	Support
1	Supports Npage \geq 1	O	Yes
2	Supports Npage \geq 128	O	Yes
3	Supports Npage \geq 256	M	Yes

Note: The master should use Npage \geq 256 unless it knows what SR mode the slave uses.**Table B.10: Inquiry Procedures**

Item	Capability	Status	Support
1	Support inquiry	O	Yes
2	Inquiry scan with first FHS	O	Yes
3			
4			
5	Supports the dedicated inquiry access code	O	Yes
6	Supports Interlaced Scan during inquiry scan	O	Yes

Control No. HD-AE-D071063	(5/10)	Control name Electrical characteristics
------------------------------	--------	--

Table B.11: Piconet Capabilities

Item	Capability	Status	Support	Values	
				Allowed	Supported
1	Broadcast messages	O	Yes	N/A	-
2	Point-to-multipoint connections	O	Yes	(2 .. 7)	7

Table B.12: Scatternet Capabilities

Item	Capability	Status	Support
1	Act as Master in one piconet and as Slave in another piconet	O	Yes
2	Act as Slave in more than one piconet	O	Yes

Table B.13: Synchronous Coding Schemes

Prerequisite: B.2/2 (SCO link Support)

Item	Capability	Status	Support
1	A-law	O	Yes
2	u-law	O	Yes
3	CVSD	O	Yes
4	Transparent Synchronous Data	O	Yes

Link Manager**Link Manager Capabilities (based on PICS proforma for Link Manager)****Table C.1: Response Messages**

Item	Capability	Status	Support
1	Accept message	M	Yes
2	Reject message	M	Yes

Table C.2: Supported Features

Item	Capability	Status	Support
1	3-slot packets	O	Yes
2	5-slot packets	O	Yes
3	Encryption	O	Yes
4	Slot offset	O	Yes
5	Timing accuracy	O	Yes
6	Role switch (Master/Slave)	O	Yes
7	Hold mode	O	Yes
8	Sniff mode	O	Yes
9	Park mode	O	Yes
10	Power Control	C.1	Yes
11	Channel quality driven data rate	O	Yes
12	SCO link	O	Yes
13	RSSI	O	Yes
14	Broadcast encryption	O	Yes
15	eSCO link	O	Yes
16	Adaptive frequency hopping	M	Yes
17	Enhanced Data Rate ACL	C.2	Yes
18	Enhanced Data Rate eSCO	C.3	Yes

C.1: If Power Class 1 is supported (RF, 1/1=1) then Mandatory, else Optional.

C.2: Mandatory IF (SUMMARY 2-2/1 OR SUMMARY 2-2/2) is claimed;

ELSE Optional IF (SUMMARY 2-1/3 OR SUMMARY 2-1/4) is claimed; Excluded otherwise.

C.3: Mandatory IF SUMMARY 2-2/3 is claimed; ELSE Optional IF (SUMMARY 2-1/3 OR SUMMARY 2-1/4) is claimed; Excluded otherwise.

Control No. HD-AE-D071063	(6/10)	Control name Electrical characteristics
------------------------------	--------	--

Table C.3: Authentication

Item	Capability	Status	Support
1	Initiate authentication before connection completed	O	Yes
2	Initiate authentication after connection completed	O	Yes
3	Respond to authentication request	M	Yes

Table C.4: Pairing

Item	Capability	Status	Support
1	Initiate pairing before connection completed	O	Yes
2	Initiate pairing after connection completed	O	Yes
3	Respond to pairing request	M	Yes
4	Use fixed PIN and request responder to initiator switch	C.1	Yes
5	Use variable PIN	C.1	Yes
6	Accept initiator to responder switch	C.2	Yes

C.1: Mandatory to support at least one of Pairing /4 and Pairing /5.

C.2: Mandatory to support if Pairing /5 AND (Pairing /1 OR Pairing /2) is supported.

Table C.5: Link Keys

Item	Capability	Status	Support
1	Creation of link key - Unit Key	C.1	Yes
2	Creation of link key - Combination Key	C.1	Yes
3	Initiate change of link key	O	Yes
4	Accept change of link key	M	Yes
5			
6			
7	Accept pairing with Unit Key	O	Yes

C.1: Mandatory to support at least one of the key types.

Table C.6: Encryption

Prerequisite: C.2/3 (Encryption supported)

Item	Capability	Status	Support
1	Initiate encryption	O	Yes
2	Accept encryption requests	M	Yes
3			
4			
5	Key size negotiation	M	Yes
6	Start encryption	M	Yes
7	Accept start of encryption	M	Yes
8	Stop encryption	M	Yes
9	Accept stop of encryption	M	Yes

Table C.7: Clock Offset Information

Item	Capability	Status	Support
1	Request clock offset information	O	Yes
2	Respond to clock offset requests	M	Yes

Control No. HD-AE-D071063	(7/10)	Control name Electrical characteristics
------------------------------	--------	--

Table C.8: Slot Offset Information

Prerequisite: C.2/4 (Slot offset)

Item	Capability	Status	Support
1	Send slot offset information	C.1	Yes

C.1: Mandatory to support if support if Role Switch/1 (Master/Slave switch) otherwise optional.

Table C.9: Timing Accuracy Information

Prerequisite: C.2/5 (Timing accuracy)

Item	Capability	Status	Support
1	Request timing accuracy information	O	Yes
2	Respond to timing accuracy information requests	M	Yes

Table C.10: LM Version Information

Item	Capability	Status	Support
1	Request LM version information	O	Yes
2	Respond to LM version information requests	M	Yes

Table C.11: Feature Support

Item	Capability	Status	Support
1	Request supported features	C.1	Yes
2	Respond to supported features requests	M	Yes
3	Request extended features mask	C.2	Yes
4	Respond to extended features Request	C.2	Yes

C.1: Mandatory to support if any of the optional features in Supported Features /1-3, Supported Features /5, Supported Features /7-12, Supported Features /14-16, Adaptive Frequency Hopping /1 is requested by the IUT otherwise optional.

C.2: Mandatory if a feature requiring another features page is supported, otherwise optional.

Table C.12: Name Information

Item	Capability	Status	Support
1	Request name information	O	Yes
2	Respond to name requests	M	Yes

Table C.13: Role Switch

Prerequisite: C.2/6 (Role switch)

Item	Capability	Status	Support
1	Request Master Slave switch	O	Yes
2	Accept Master Slave switch requests	M	Yes

Table C.14: Detach

Item	Capability	Status	Support
1	Detach connection	M	Yes

Control No. HD-AE-D071063	(8/10)	Control name Electrical characteristics
------------------------------	--------	--

Table C.14a: Setting up and Removing Enhanced Data Rate ACL Connection

Item	Capability	Status	Support
1	Enter Enhanced Data Rate	C.1	Yes
2	Exit Enhanced Data Rate	C.1	Yes

C.1: Mandatory if LMP, 2/17 supported, otherwise excluded.

Table C.14b: Setting up and Removing Enhanced Data Rate eSCO Connection

Item	Capability	Status	Support
1	Enter and exit eSCO using Enhanced Data Rate Packets	C.1	Yes

C.1: Mandatory if LMP, 2/18 supported, otherwise excluded.

Table C.15: Hold mode

Prerequisite: 2/7 (Hold mode)

Item	Capability	Status	Support
1	Force hold mode	O	Yes
2	Request hold mode	C.1	Yes
3	Respond to hold mode requests	M	Yes
4	Accept forced hold mode	M	Yes

C.1: Mandatory to support if LMP, 15 /1 (Force hold mode) is supported, otherwise optional.

Table C.16: Sniff mode

Prerequisite: C.2/8 (Sniff mode)

Item	Capability	Status	Support
1			
2	Request sniff mode	O	Yes
3	Respond to sniff mode requests (renegotiate or reject)	M	Yes
4			
5	Request un-sniff	C.1	Yes
6	Accept un-sniff requests	M	Yes

C.1: If LMP, 16/2 (Request sniff mode) is supported then mandatory to support, otherwise optional.

Table C.17: Park mode

Prerequisite: C.2/9 (Park Mode)

Item	Capability	Status	Support
1			
2	Request park mode	O	Yes
3	Respond to park mode requests	M	Yes
4			
5	Set up broadcast scan window	O	Yes
6	Accept changes to the broadcast scan window	M	Yes
7	Modify beacon parameters	O	Yes
8	Accept modification of beacon parameters	M	Yes
9	Request Unpark using PM_ADDR	C.1	Yes
10	Request Unpark using BD_ADDR	C.1	Yes
11	Slave requested Unpark	O	Yes
12	Accept Unpark using PM_ADDR	M	Yes
13	Accept Unpark using BD_ADDR	M	Yes

C.1: If LMP, 17/3 (Respond to park mode requests) is supported then at least one of LMP, 17 /9

(Unpark using PM_ADDR) or LMP, 17/10 (Unpark using BD_ADDR) is mandatory to support, otherwise optional.

Control No. HD-AE-D071063	(9/10)	Control name Electrical characteristics
------------------------------	--------	--

Table C.18: Power Control

Prerequisite: C.2/13 (RSSI)

Item	Capability	Status	Support
1	Request to increase power	M	Yes
2	Request to decrease power	M	Yes

Prerequisite: C.2/10 (Power control)

Item	Capability	Status	Support
3	Respond when max power reached	M	Yes
4	Respond when min power reached	M	Yes

Table C.19: Link supervision Timeout

Item	Capability	Status	Support
1	Set link supervision timeout value	O	Yes
2	Accept link supervision timeout setting	M	Yes

Table C.20: Quality of Service

Item	Capability	Status	Support
1	Channel quality driven change between DM and DH packet types	C.1	Yes
2	Force/Request change of Quality of Service	M	Yes
3	Request change of Quality of Service	M	Yes

C.1: Mandatory to support if support of LMP, 2 /11 is stated in the feature request, otherwise optional.

Table C.21: SCO Links

Prerequisite: C.2/12 (SCO link)

Item	Capability	Status	Support
1	Initiate SCO links, as Master	O	Yes
2	Initiate SCO links, as Slave	O	Yes
3	Accept SCO links	O	Yes
4	Remove SCO link, as Master	C.1	Yes
5	Remove SCO link, as Slave	C.2	Yes
6	Negotiate SCO link parameters, as Master	C.3	Yes
7	Negotiate SCO link parameters, as Slave	C.4	Yes

C.1: Mandatory to support if LMP, 21 /1 (Initiating SCO links, as Master) is supported, otherwise optional.

C.2: Mandatory to support if LMP, 21 /2 (Initiating SCO links, as Slave) is supported, otherwise optional.

C.3: Mandatory to support if LMP, 21 /1 (Initiating SCO links, as Master) or LMP, 21/3 (Accept SCO links) is supported, otherwise optional.

C.4: Mandatory to support if LMP, 21 /2 (Initiating SCO links, as Slave) or LMP, 21/3 (Accept SCO links) is supported, otherwise optional. Comments:

Table C.22: Multi-Slot Packages

Item	Capability	Status	Support
1	Accept maximum allowed number of slots to be used	C.1	Yes
2	Request maximum number of slots to be used	C.1	Yes
3	Accept request of maximum number of slots to be used	C.1	Yes

C.1: Mandatory to support if LMP, 2 /1 and/or LMP, 2 /2 is supported in the feature request, otherwise optional.

Control No. HD-AE-D071063	(10/10)	Control name Electrical characteristics
------------------------------	---------	--

Table C.23: Paging Scheme

Item	Capability	Status	Support
1	Request page mode to use	O	Yes
2	Accept suggested page mode	O	Yes
3	Request page scan mode to use	O	Yes
4	Accept suggested page scan mode	O	Yes

Table C.24: Connection Establishment

Item	Capability	Status	Support
1	Create connection for higher layers	M	Yes
2	Respond to requests to establish connections for higher layers	M	Yes
3	Indicate that link set-up is completed	M	Yes

Table C.25: Test Mode

Item	Capability	Status	Support
1	Activate test mode	O	Yes
2	Ability to reject activation of test mode if test mode is disabled	M	Yes
3	Control test mode	O	Yes
4	Ability to reject test mode control commands if test mode is disabled.	M	Yes

Table C.26: Adaptive Frequency Hopping

Prerequisite: C.2/20 (AFH)

Item	Capability	Status	Support
1	Support of AFH switch as master	O	Yes
2	Support of AFH switch as slave	M	Yes
3	Support of Channel Classification reporting as master	C.1	Yes
4	Support of Channel Classification reporting as slave	C.2	Yes
5	Support channel classification from host	C.3	Yes
6	Support of Channel Classification	O	Yes

C.1: Optional if LMP, 26/6 is supported, otherwise excluded.

C.2: Mandatory if LMP, 26/6 is supported, otherwise excluded.

C.3: Mandatory if LMP, 26/1 or LMP, 26/4 is supported, otherwise optional.

Notes:

This Data Report is based on "1846_BC4-Ext_RF.ICS-2.0.E.0", "1847_HCISStack2.0EDR_BB.ICS-2.0.E.0",
"1848_HCISStack2.0EDR_LMP.ICS-2.0.E.0" and "SUM.ICS-2.0.E.4".

EYSMJCS

TAIYO YUDEN Confidential
& Tentative

Control No. HD-MC-A071063 (1/1)	Control name Circuit Schematic
------------------------------------	-----------------------------------

Block Diagram

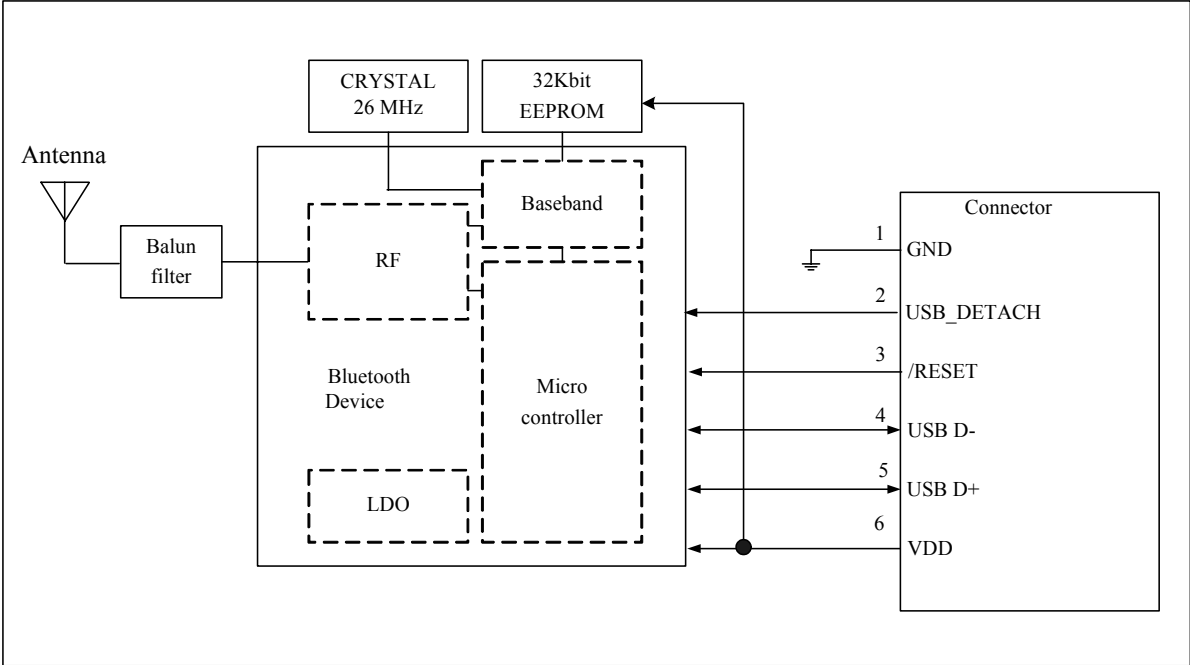



EYSMJCS

TAIYO YUDEN Confidential
& Tentative

Control No. HD-AD-B071063 (1/1)	Control name Outline/Appearance
------------------------------------	------------------------------------

Indication label

Label1 Case-side (ケース側 1 枚目)

Product Number:EYSMJCS		
EYSMJCSFX		
 201 WW 07215204	CA46920-0316 01A	
Taiyo Yuden Co.,Ltd.	A B C D E F G H I J K	

Label2 Case-side (ケース側 2 枚目)

IC: 4389B-EYSMJCS	
FCC ID:RYYEYSMJCS	XXX-XXXXXXXX

Label3 Back-side (基板側)

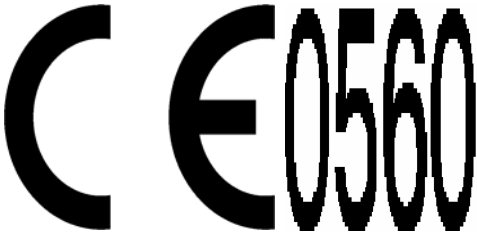
	LOT.No 00037AAAAAAA
---	------------------------

Material: PET (UL969) / Label color : White

EYSMJCSTAIYO YUDEN Confidential
& Tentative

Control No. HD-BA-A071063	(1/1)	Control name Pin Layout
------------------------------	-------	----------------------------

Pin Descriptions

Terminal No.	Terminal name	Input/Output	Description	Remark
1	GND	-	Ground	
2	PIO2/USB_DETACH	Input	DETACH signal input Low USB connect High USB disconnect	Note 1
3	/RESET	Input	Active low RESET signal with internal weak pull-up	Note 2
4	USB_D-	Input/Output	USB data (Negative) input-output	
5	USB_D+	Input/Output	USB data (Positive) input-output	
6	VDD	Input	DC3.3V Power supply	Note 3

Notes:

1. Strength pull-downs (pull-ups) are equivalent to a few kOhms resistance, but are more accurately modeled as a 40uA current drain (source).
2. Weak pull-ups can be thought of 1M Ohm connections to VDD, but are more accurately modeled as a -1uA current source.
3. Pin 6 (VDD) is used for power supply of BT module. To fill the standard of "Supply voltage ripple and spike noise", the capacitor, which has the capacity of 2.2uF or more, should be put in the terminal VDD outside as a bypass capacitor.

FCC Regulatory Information

CAUTION: To maintain compliance with FCC's RF exposure guidelines, use only the supplied antenna. Unauthorized antenna, modification, or attachments could damage the transmitter and may violate FCC regulations.

This device complies with Part 15 of the FCC Rules. Operation is subject to the following two conditions:

- (1) This device may not cause harmful interference.
- (2) This device must accept any interference received, including interference that may Cause undesired operation.

Canada Regulatory Information

Operation is subject to the following two conditions:

- (1) this device may not cause interference, and
- (2) this device must accept any interference, including interference that may cause undesired operation of the device.

L'utilisation de ce dispositif est autorisée seulement aux conditions suivantes :

- (1) il ne doit pas produire de brouillage et
- (2) l'utilisateur du dispositif doit être prêt à accepter tout brouillage radioélectrique reçu, même si ce brouillage est susceptible de compromettre le fonctionnement du dispositif.

R&TTE Directive Information**CE 0560**

Hereby Taiyo Yuden Co., Ltd., declares that this Complete Class2 Bluetooth Module (Model No.: EYSMJCS) is in compliance with the essential requirements and other relevant provisions of Directive 1999/5/EC

Caution

Please note that this users manual should not be provided to end-users.

Notice

At the use of our Module, following is required to be shown under the responsibility of the manufacture who integrates it into their device.

The following sentence has to be displayed on the outside of the device in which the module is installed:

"Contains Transmitter Module FCC ID: RYYEYSMJCS ", or "Contains IC: 4389B-EYSMJCS "

FCC Regulatory information

CAUTION: To maintain compliance with FCC's RF exposure guidelines, use only the supplied antenna. Unauthorized antenna, modification, or attachments could damage the transmitter and may violate FCC regulations.

This device complies with Part 15 of the FCC Rules. Operation is subject to the following two conditions:

- (1) This device may not cause harmful interference.
- (2) This device must accept any interference received, including interference that may Cause undesired operation.

Canada Regulatory information

Operation is subject to the following two conditions:

- (3) this device may not cause interference, and
- (4) this device must accept any interference, including interference that may cause undesired operation of the device.

L'utilisation de ce dispositif est autorisée seulement aux conditions suivantes :

- (3) il ne doit pas produire de brouillage et l'utilisateur du dispositif doit être prêt à accepter tout brouillage radioélectrique reçu, même si ce brouillage est susceptible de compromettre le fonctionnement du dispositif.

R&TTE Directive information

C E 0560

Hereby [Name of manufacture(*)], declares that this [type of equipment(*)] is in compliance with the essential requirements and other relevant provisions of Directive 1999/5/EC

(*) Note: Please write in your company name and type of equipment into [].