OPERATI ON
MANUAL

New Wetness Sensing System RX69W1
For monitoring purpose in USA

By Nippon Kodoshi Corporation
September 4,1998

Table of Contents

DESCRIPTION	3
Overview.....	4
Specifications.....	5
Location and Function of Controls	
Transmitter Introduction.....	6
Sensor Introduction.....	7
Transmitter and Sensor Operating.....	8
Sensor Installation to a disposal diaper.....	9
Transponder Introduction.....	10
Receiver Introduction.....	11
Receiver Operating.....	13
Inside Views, Dip-SW Setting.....	14
Transmitter Inside View.....	14
Transmitter Dip-SW Setting.....	15
Transponder Inside View.....	16
Transponder Dip-SW Setting.....	17
Receiver Inside View.....	19
Receiver Test Mode 1.....	20
Receiver Test Mode 2 (Melody).....	23
Pager Controller Protocol.....	24
Clone Mode.....	26
Transmitter Clone Mode.....	26
Transponder Clone Mode.....	31
Receiver Clone Mode.....	33

FCC PART 15 CLASS B MANUAL **DESCRIPTION**

NOTICE

This equipment has been tested and found to comply with the limits for a Class B digital device, pursuant to Part 15 of the FCC Rules. These limits are designed to provide reasonable protection against harmful interference in a residential installation.

This equipment generates, uses and can radiate radio frequency energy and, if not installed and used in accordance with the instruction, may cause harmful interference to radio communications. However, there is no guarantee that interference will not occur in a particular installation. If this equipment does cause harmful interference to radio or television reception, which can be determined by turning the equipment off and on, the user is encouraged to try to correct the interference by one or more of the following measures:

- Reorient or relocate the receiving antenna
- Increase the separation between the equipment and receiver.
- Connect the equipment into an outlet on a circuit different from that to which the receiver is connected.
- Consult the dealer or an experienced radio/TV technician for help.

FCC WARNING

Changes or modifications not expressly approved by the party responsible for compliance could void the user's authority to operate the equipment.

[1] Wetness Sensing System

(1) Overview

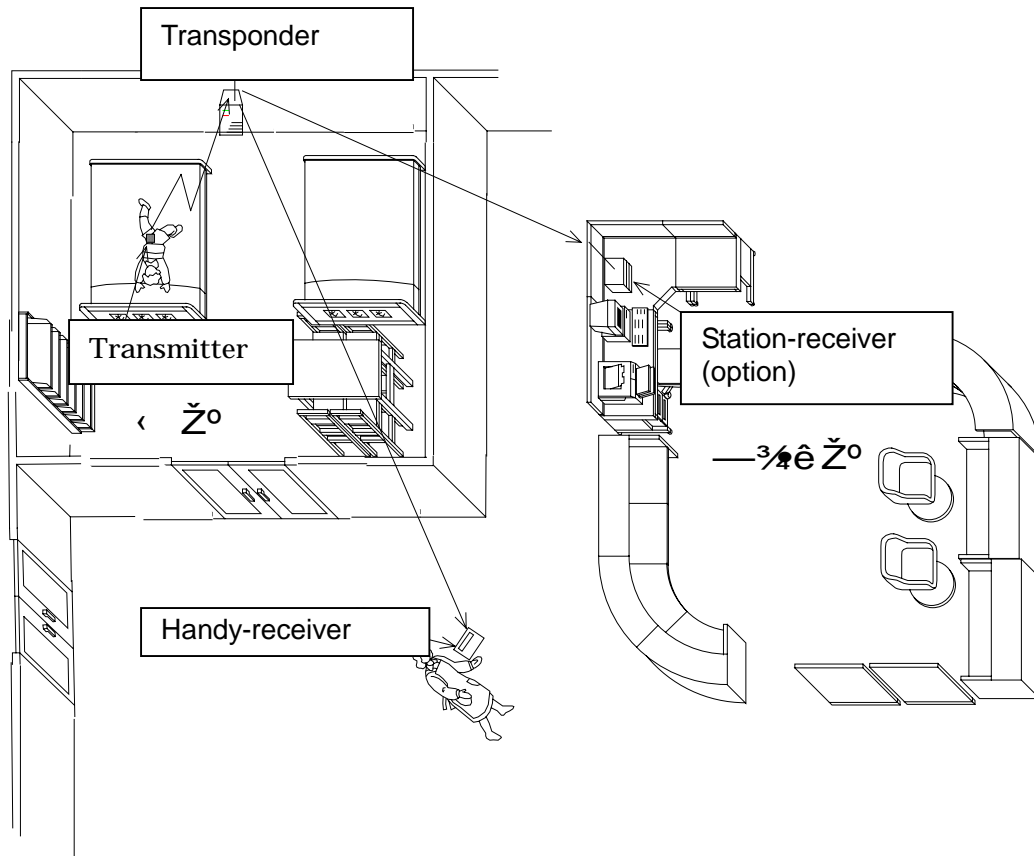

This Wetness Sensing System is comprised with transmitters, transponders and receivers, which inform caregivers of sensing moisture in a diaper. Once wetness sensor incorporated into diaper is aware of moisture, the transmitter including sensor puts out the signal to the transponder and then to the receiver.

□ □ Specifications

■ □ TRANSMITTER

- Frequency
- RF Output Power
- Frequency stability
- Identification
- Modulation system
- Maximum Deviation
- Power Source
- Battery Life
- 318.125M, 318.500M, 318.875M, 319.250MHz
- 2400 μ V/m (67.6dBm) at 3 m
- \pm 0.001□
- Area ID1 □99, Individual ID 1 □99
- Variable reactance frequency modulation
- \pm 4 kHz
- 3V (lithium battery CR2032)
- about 3 months (dropped to 2.5V)

■ □ TRANSPONDER

- Receive system
- Receiving Frequency 1
- Receiving Frequency 2
- Sensitivity
- Intermediate frequencies
- Transmitting Frequency
- RF output power
- Frequency stability
- Modulation system
- Maximum Deviation
- Power supply requirement
- Battery Life
- Double-conversion superheterodyne
- 318.125M, 318.500M, 318.875M, 319.250MHz
- 314.500M~314.725MHz(25kHz step)
- -113dBm for 12dB SINAD
- 1st 21.7MHz
- 2nd □450kHz
- 314.500M~314.725MHz(25kHz step)
- 2250 μ V/m (at 3 m)
- \pm 0.001□
- Variable reactance frequency modulation
- \pm 4 kHz
- DC,AC9V □0.1A AC adaptor
- about 12 hours

■ □ RECEIVER

- Receive system
- Receiving Frequency 1
- Receiving Frequency 2
- Sensitivity
- Intermediate frequencies
- Frequency stability
- Power supply requirement
- Battery Life
- Double-conversion superheterodyne
- 318.125M, 318.500M, 318.875M, 319.250MHz
- 314.500M~314.725MHz(25kHz step)
- -113dBm for 12dB SINAD
- 1st 21.7MHz
- 2nd □450kHz
- \pm 0.001□
- DC,AC9V □0.3A AC adaptor
- about 5 hours

□ □ Location and Function of Controls

Transmitter Introduction

(1) overview

Sensing devise (sensor) is connected to transmitter. Once sensing devise senses moisture, transmitter will send signal to transponder.

() Each Designation

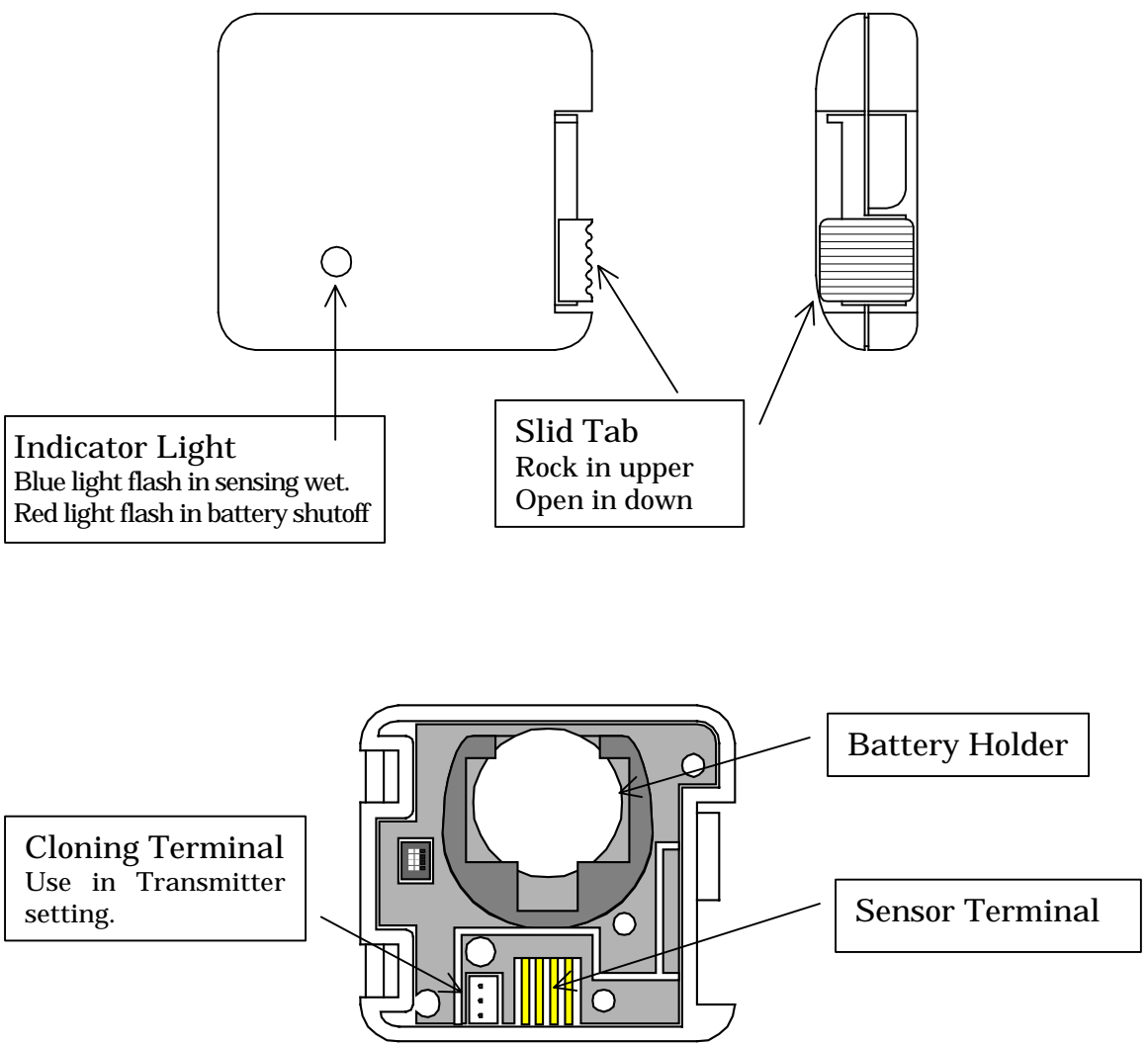

Sensor Introduction

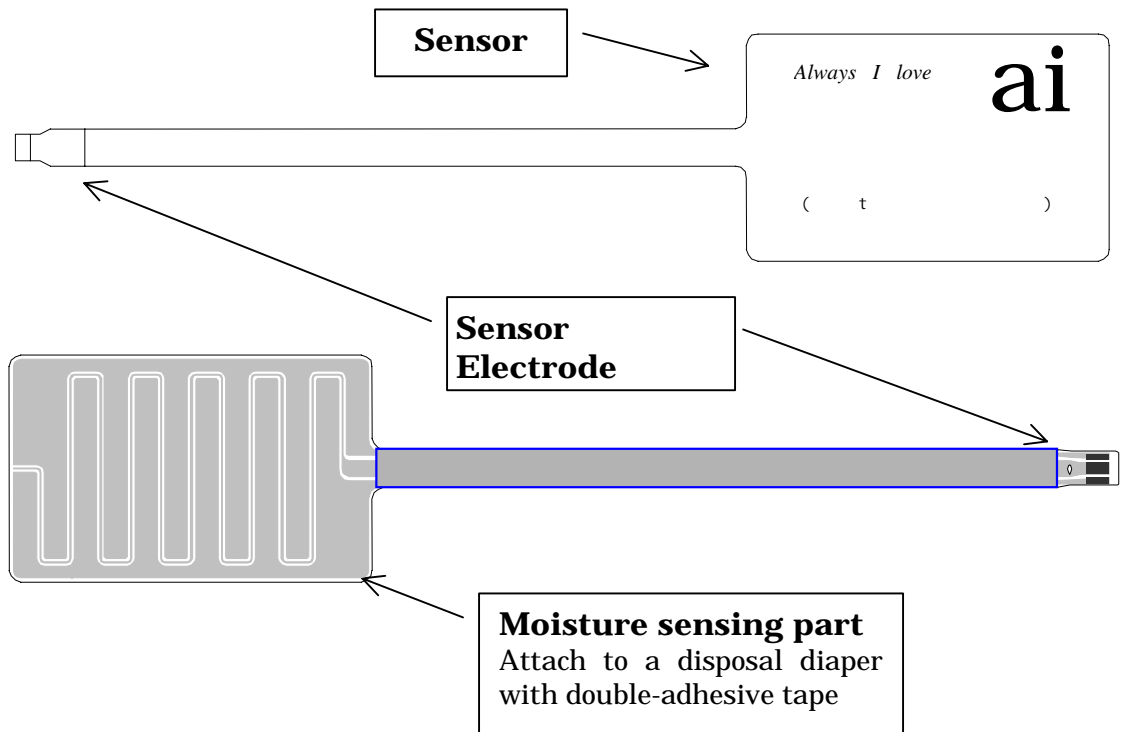

Transmitter and Sensor Operating

Open-Close Operation

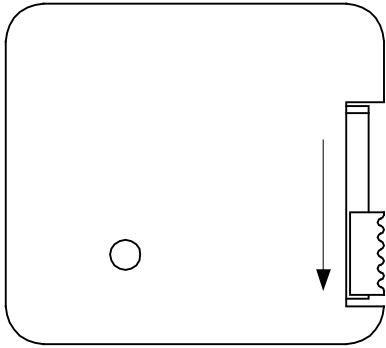

To open this case, release the lock by sliding this tab underneath.
To lock the case is sliding this tab upward in closed status.

Method of Battery desorption and Sensor Attachment

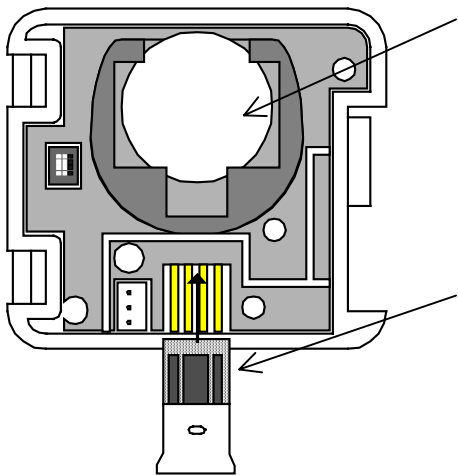

Battery desorption

Installation

Cant the battery slowly.

Disinstallation

Push the battery upward.

Sensor Installation

Put the Sensor into the connector deeply and embed in guide pin from above to prevent to drop out.

Sensor Installation to Disposal Diaper

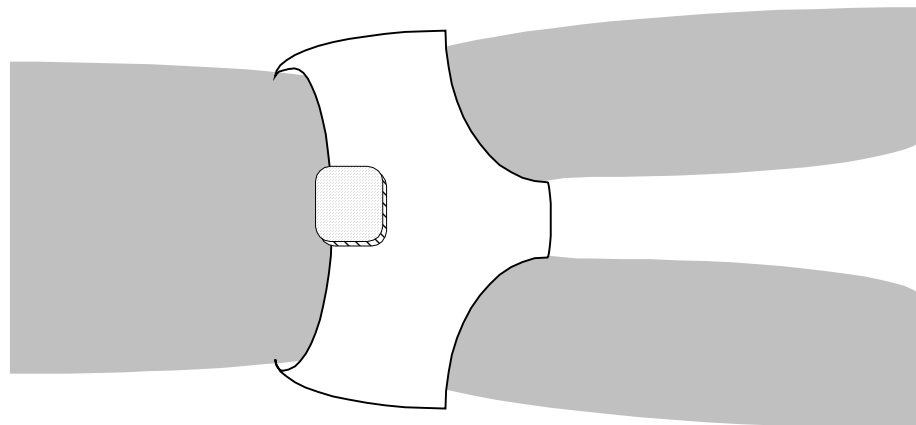
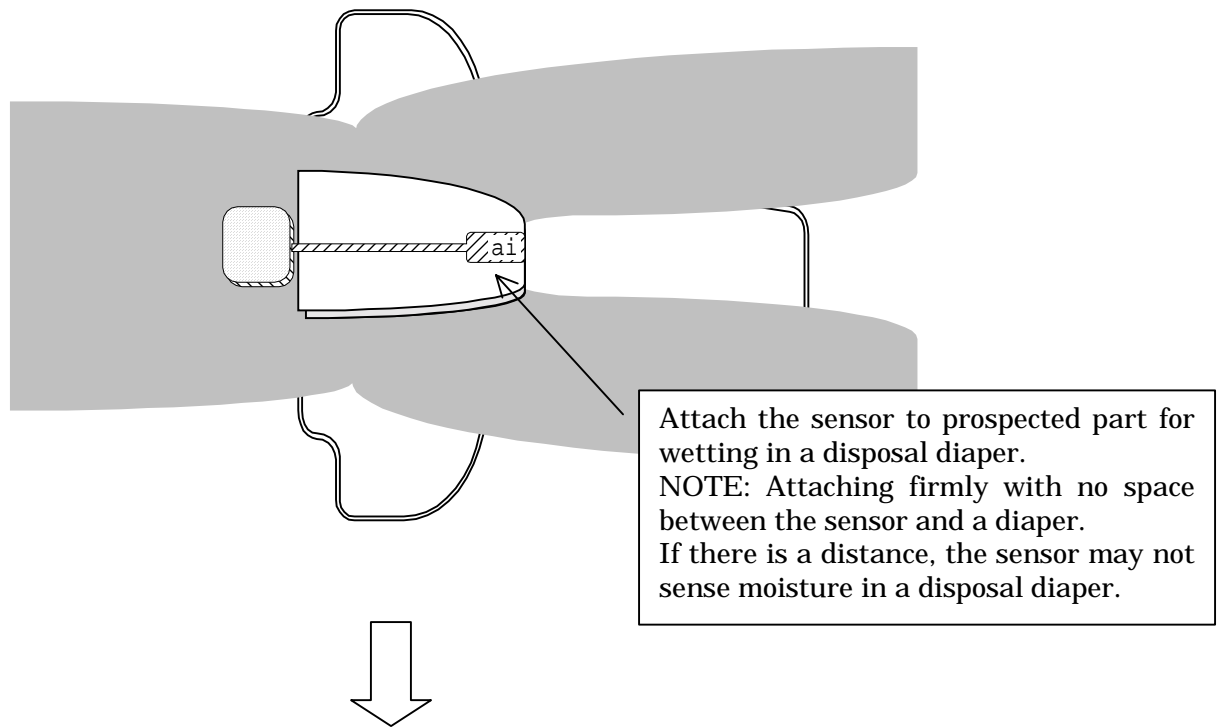
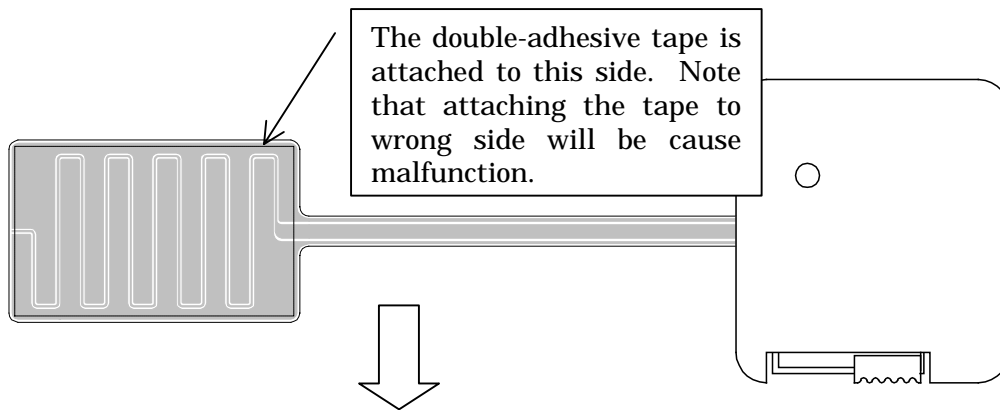

After attach the sensor, put the cover on a diaper and then fix the

transmitter.

Transponder Introduction

Overview

Transponder receives signal from Transmitter and then transmits to Receiver. It transmits the signal received from Transmitter to another Transponder.

Each Designation

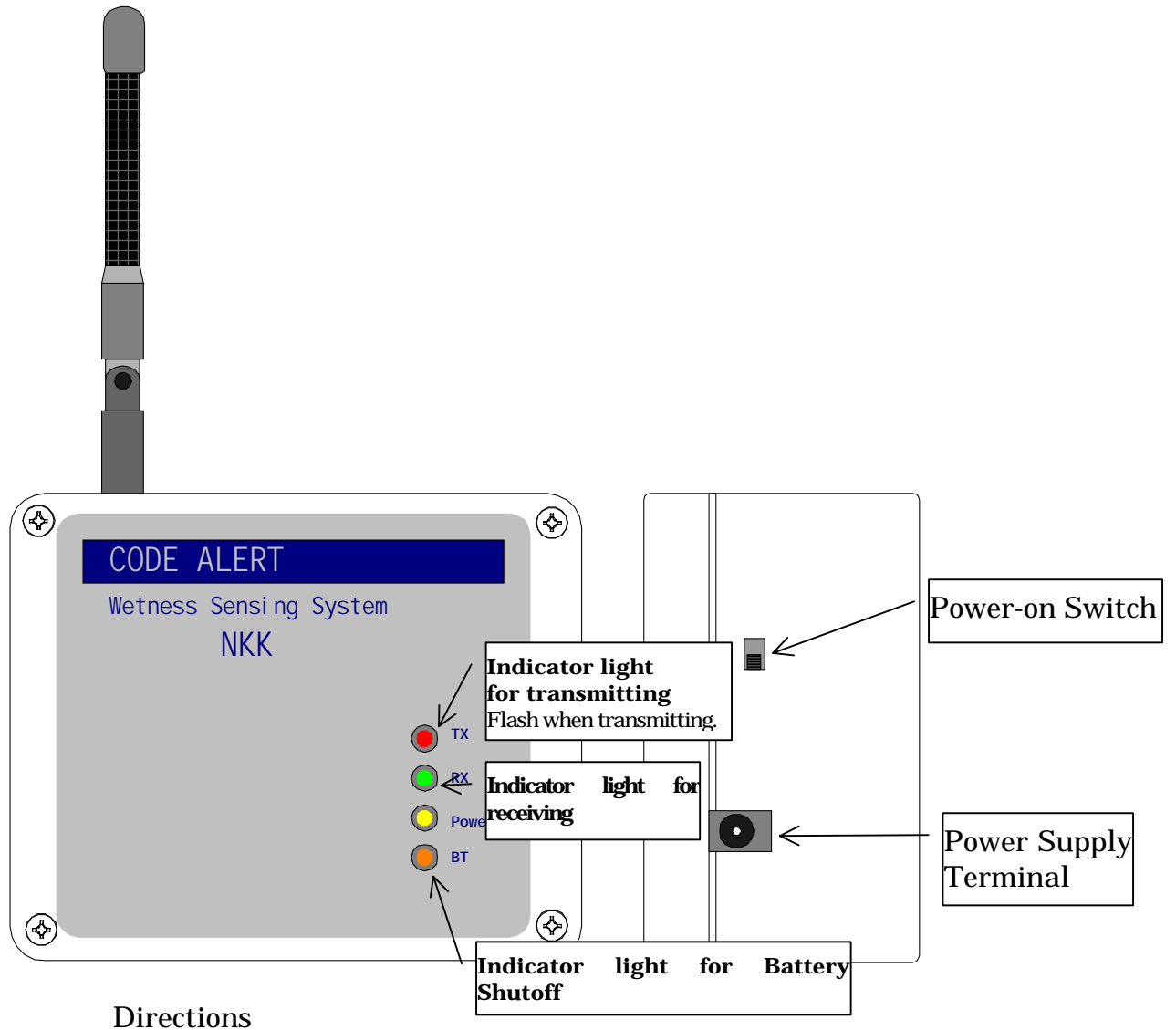

The transponder is located in the signal receivable area from Transmitter.

Receiver Introduction

1. Overview

When the receiver receives signal from the transponder, it informs caregivers of received signal information (e.g. sense moisture or battery shutoff) by alarm of melodies and display.

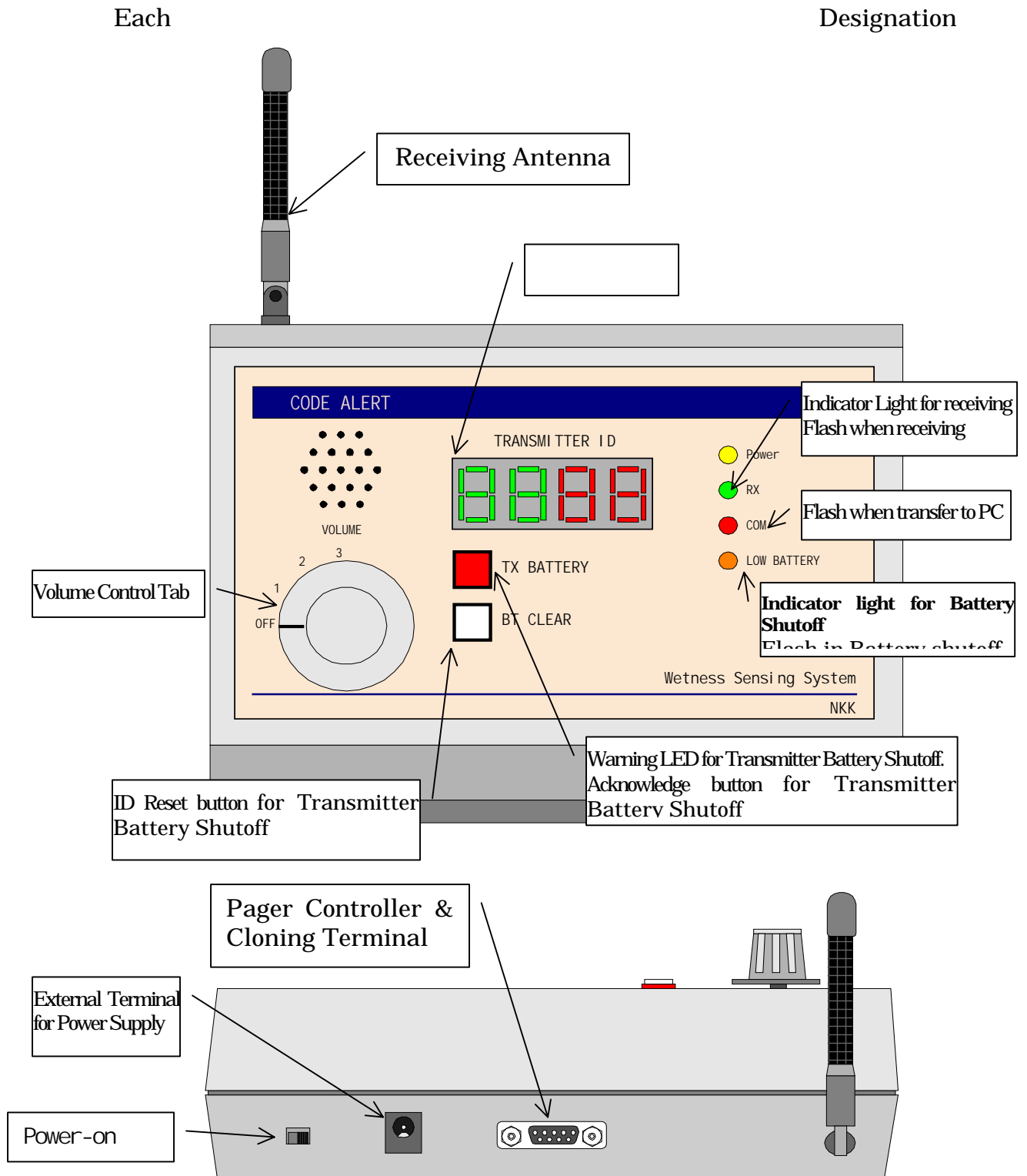

a.

1 Display Receiver Battery Shutoff

- When the battery of receiver run down, LED will flash.

Information Display

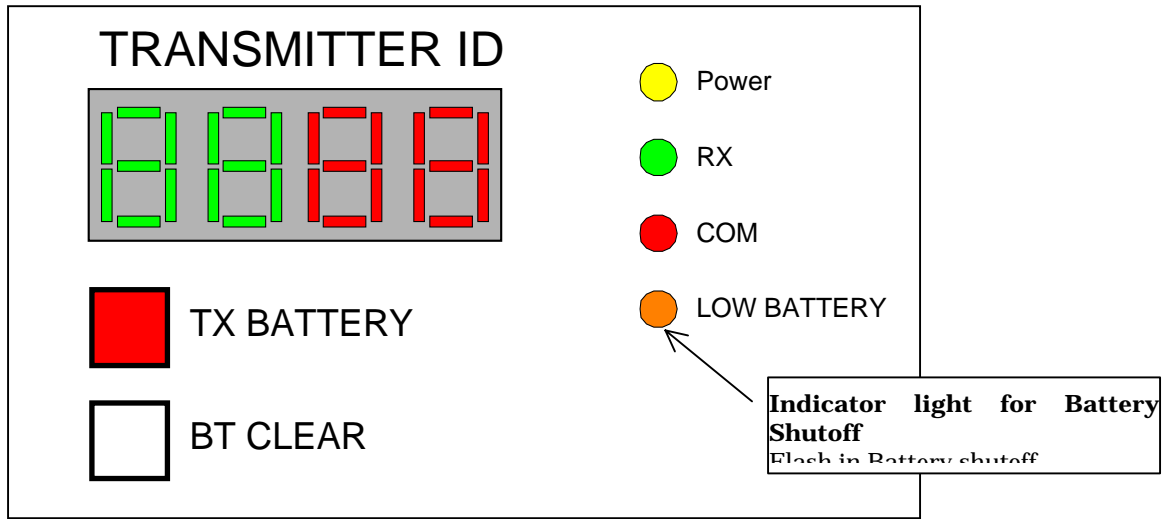

- When receiving the signal of sensing moisture in a diaper, it displays Area ID in right two-digit and transmitter ID in left two-digit. (NOTE: In case of sensing multiple IDs, it displays those IDs in turn.)

(Example of Display 1)

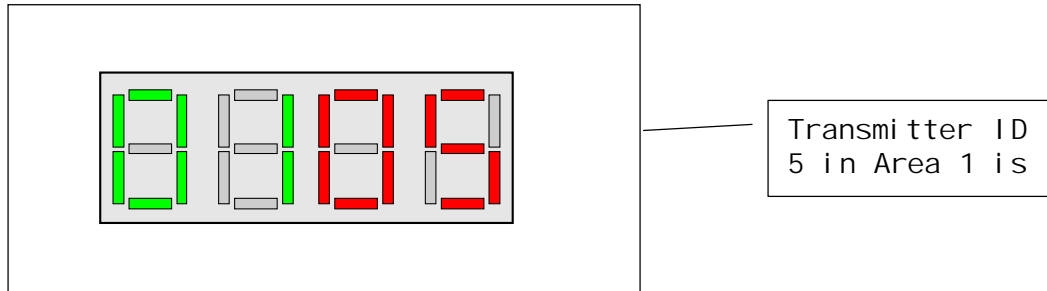

Example of Display 2

When flashing "Warning LED for Battery Shutoff", push "Acknowledge button for Transmitter Battery Shutoff", [shaded box] is displayed.

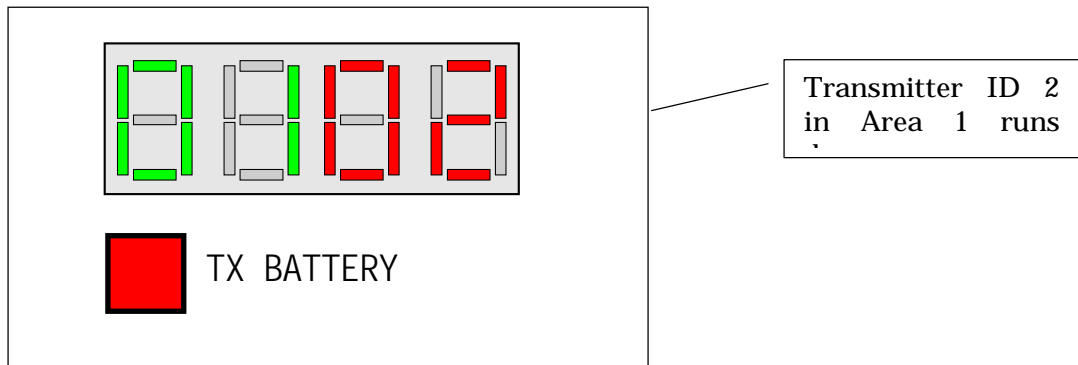

7 Receiver Operation

Turning on power, current receiving channel for the transmitter is displayed in 7 segment Display with red LED and current receiving channel for the transponder in 7 segment display with green LED, like  for 5sec, after that it will clear the ID.

When the transmitter senses moisture in a diaper, the receiver displays Area ID and Transmitter ID and puts melodies on.

Once Transmitter IDs are received, it continues displaying these IDs till the signal from the transmitter is cut off for 30sec. Those IDs will be cleared automatically when the signal is aborted (i.e. it displays those IDs till the diaper attached the sensor is changed.).

1 Volume Control SW

It changes Volume of melodies as four stage (large, middle, small and OFF).

2 TX BATTERY SW LED

Square red LED flashes in Transmitter Battery Shutoff.

Transmitter ID which runs out is displayed during pushing this SW. (In case of detecting multiple IDs, it displays those IDs in turn.)

3 BT CLEAR SW

Battery Shutoff LED will be lighted out and its IDs will be cleared after checking which ID is detected by pushing TX Battery SW and changing the battery.

NOTE: Be sure to clear detected IDs after changing the battery

4 Power Supply

AC adapter more than 0.3A, 9V(DC, AC) is available.

In electricity failure, this system can work about for 5 hours by using built-in rechargeable battery.

3 Inside Views, Dip-SW Setting

Transmitter Inside View

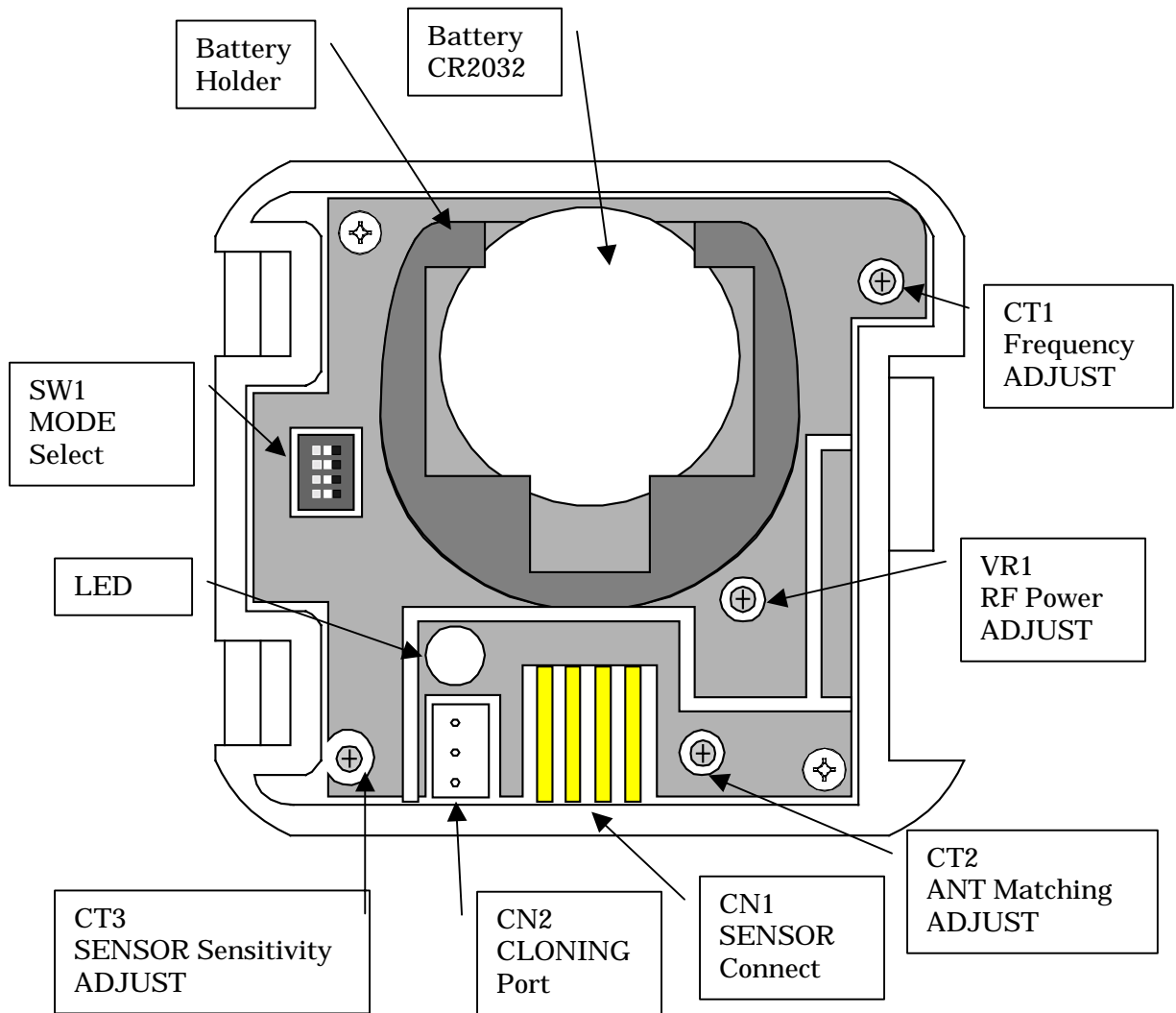
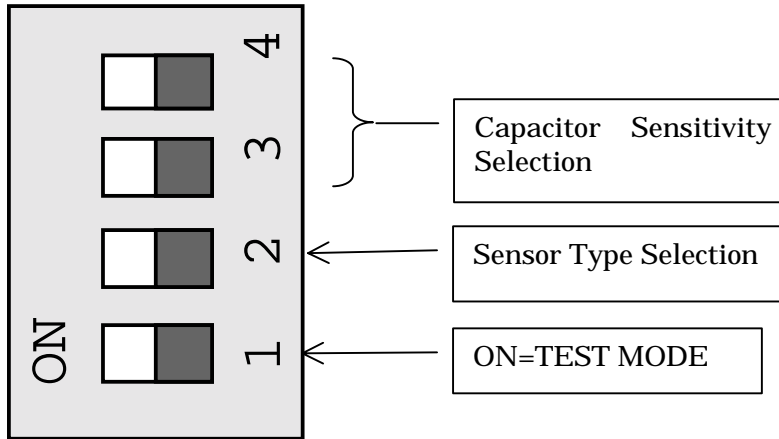

Fig.3-1 TRANSMITTER

Transmitter Dip-SW Setting

SW1 MODE SELECT



TEST MODE SELECTION SW1-1

SW1-1 is ON when turning on power, it will enter into Test Mode.

It will be transferred data continuously in the Test Mode. To stop the continuous transfer is turning SW1-1 off in Test Mode.

Turning on power again with SW1-1 OF enters into Normal Mode.

□ SENSOR TYPE SELECTION □ SW1-2 □

SW1-2	SENSOR TYPE
OFF	Capacitor type Sensor
ON	Resistor type Sensor

Capacitor Sensitivity Selection □ SW1-3,4 □

SW1-3	SW1-4	Capacitor Sensitivity
OFF	OFF	Maximum Sensitivity about □3.5pF
ON	OFF	Middle Sensitivity about □4.5pF
OFF	ON	Lower Sensitivity about □5.5pF
ON	ON	Minimum Sensitivity about □6.5pF

Transponder Inside View

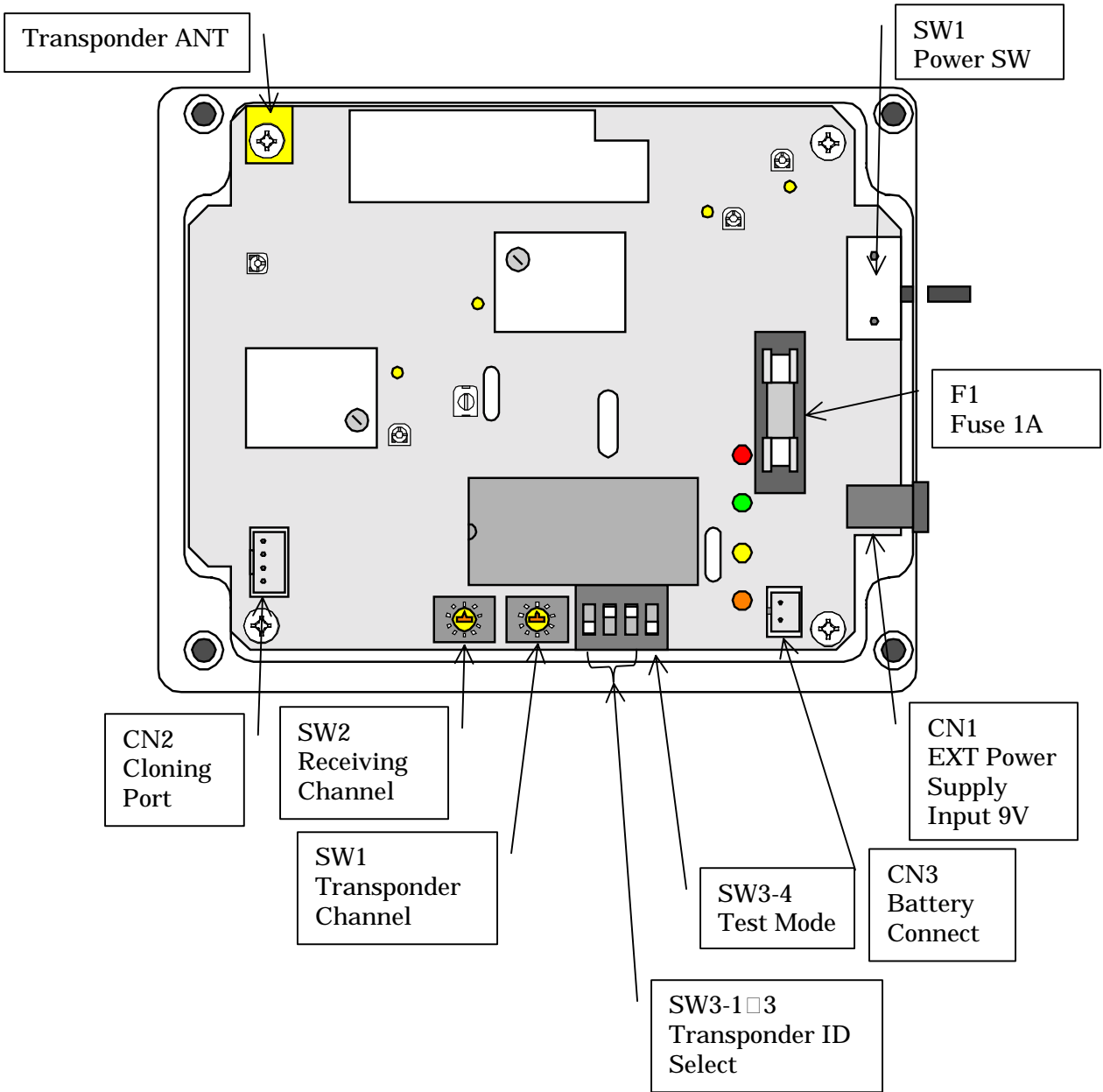
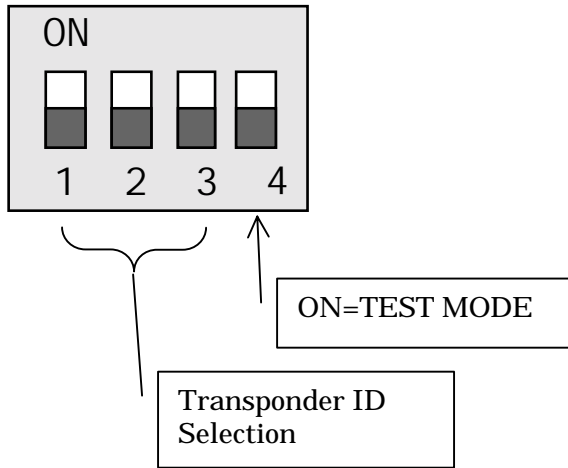

Fig.3-2 TRANPONDER

Transponder Dip-SW Setting

SW MODE SELECT



TEST MODE SELECT SW3-4

SW1-1 is ON when turning on power, it will enter into Test Mode.

Data will be received continuously in the Test Mode. When SW3-1 is OFF, it receives data at Transmitter receiving frequency. When SW3-1 is ON, it receives data at Transponder receiving frequency. In that case, if RSSI is ON green LED will be flashed, if N-DET is ON red LED will be flashed.

In Test Mode, changing SW3-4 into OFF will be in Transfer Mode. At that time, if SW3-1 is OFF it transfers only carrier wave, if ON it transfers ID continuously.

Restart with SW3-4 OFF, it returns to normal mode.

Transponder ID Selection SW3-1 3

SW3-1	SW3-2	SW3-3	ID
OFF	OFF	OFF	1
ON	OFF	OFF	2
OFF	ON	OFF	3
ON	ON	OFF	4
OFF	OFF	ON	5
ON	OFF	ON	6
OFF	ON	ON	7
ON	ON	ON	8

NOTE: In case of connecting multiple transponders, be sure not to set same Transponder IDs.

□ Receiving Channel Selection SW2

Receiving channel means receiving frequency when receiving the signal from Transmitter.

SW2	Receiving CH	Receiving Frequency
0	1 CH	318.125MHz
1	2 CH	318.500MHz
2	3 CH	318.875MHz
3	4 CH	319.250MHz

NOTE: It is impossible to receive the signal if the transmission wave has no accordance with receiving wave.

□ Transponder Channel Selection SW1

Transponder Channel means identical frequency at which multiple Transponders transfers and receives mutually.

SW1	Transponder CH	Transponder Frequency
0	1 CH	314.500MHz
1	2 CH	314.525MHz
2	3 CH	314.550MHz
3	4 CH	314.575MHz
4	5 CH	314.600MHz
5	6 CH	314.625MHz
6	7 CH	314.650MHz
7	8 CH	314.675MHz
8	9 CH	314.700MHz
9	10 CH	314.725MHz

Receiver Inside View

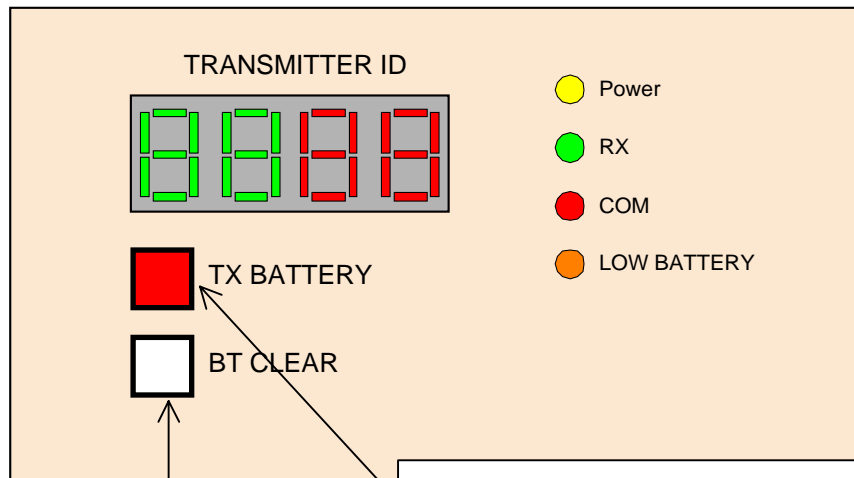
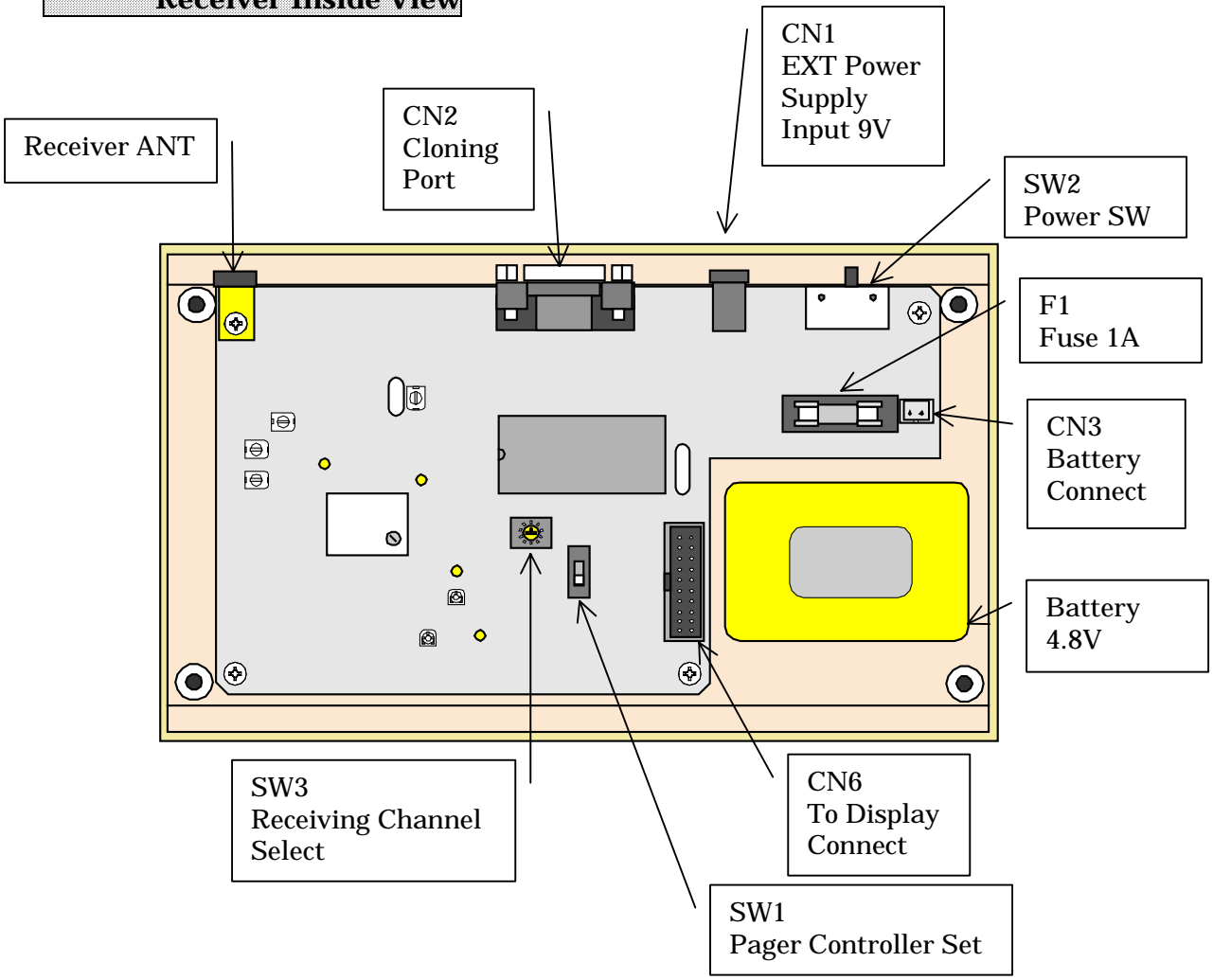

BT CLEAR SW
ID Reset button for Transmitter
Battery Shutoff

TX BATTERY SW
Warning LED for Transmitter Battery Shutoff.
Acknowledge button for Transmitter Battery
Shutoff

Receiver Test Mode 1

TEST MODE SELECT

When **Power SW** is ON in pushing **BT CLEAR SW** on Front Panel, it will be Test MODE 1.

First, when **BT CLEAR SW** is pushing is displayed in 7segment LED for 1sec and then the LED of RX, COM and TX BATTERY is flashed sequentially.

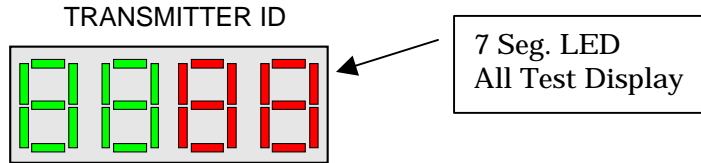

Second, it displays the receiving channel of transmitter and transponder which are in memory, like 0102 Transponder = 1CH, Transmitter = 2CH .

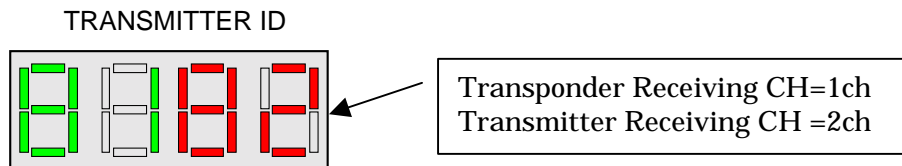

When **BT CLEAR SW** is released, it will be in Transponder receiving acknowledge Mode. Transponder receiving channel is displayed in left side LED with green and RSSI Level radio field intensity is displayed in right side LED with red.

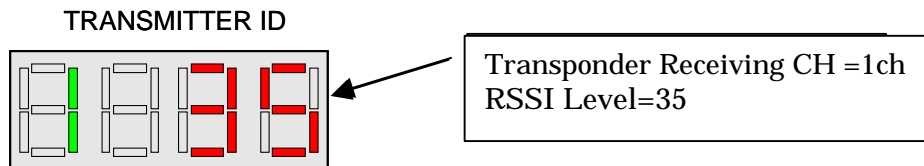

When RSSI is ON RSSI 40 , RX LED is flashed with green and when N-DET is ON, COM LED is flashed with red.

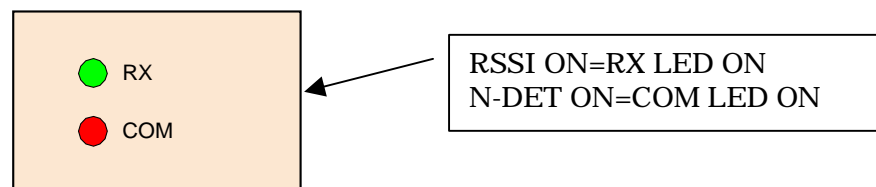

To change the Transponder receiving channel is switching over SW3 of Rotary Dip SW in the Main Board to target channel, and then push the TX BATTERY SW in the Front Panel to memory the setting.

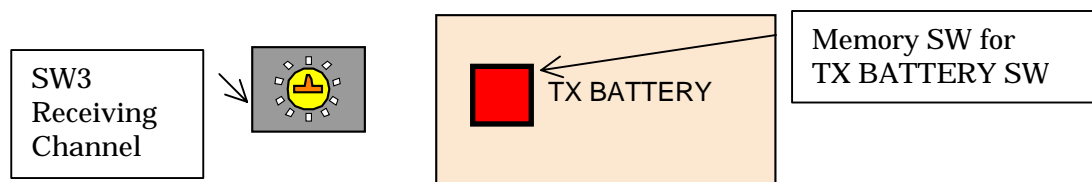

Transponder Channel Select SW3

Transponder Channel means receiving frequency when receiving the signal from Transponder.

SW1	Transponder CH	Transponder Frequency
0	1 CH	314.500MHz
1	2 CH	314.525MHz
2	3 CH	314.550MHz
3	4 CH	314.575MHz
4	5 CH	314.600MHz
5	6 CH	314.625MHz
6	7 CH	314.650MHz
7	8 CH	314.675MHz
8	9 CH	314.700MHz
9	10 CH	314.725MHz

After pushing **BT CLEAR SW** in Front panel again, it will be in Transmitter receiving acknowledging Mode. Current Transponder receiving channel is displayed in left side LED with green and RSSI Level radio field intensity is displayed in right side LED with red.

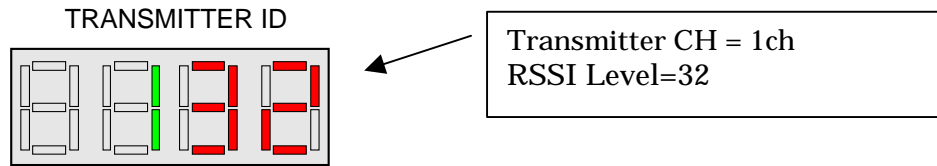

When RSSI is ON RSSI 40 , RX LED is flashed with green and when N-DET is ON, COM LED is flashed with red.

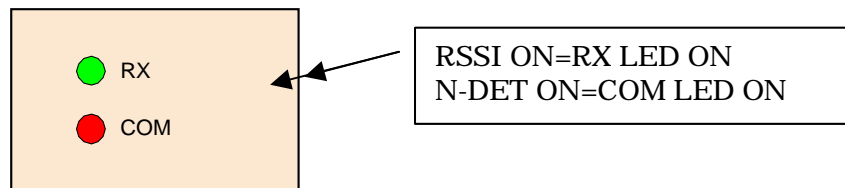

To change the Transponder receiving channel is switching over SW3 of Rotary Dip SW in the Main Board to target channel, and then push the TX BATTERY SW in the Front Panel to memory the setting.

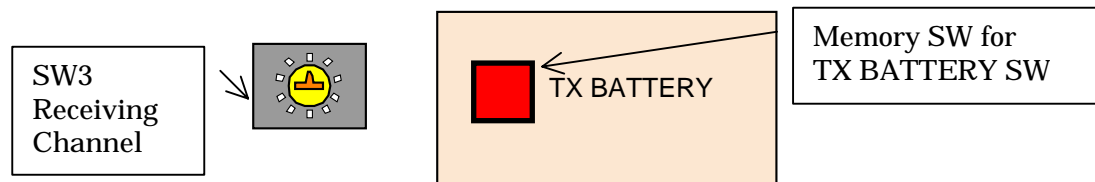

-
-
- Transmitter Receiving Channel Select SW3
Receiving channel means receiving frequency when receiving the signal from Transmitter.

SW3	Receiving CH	Transmitter Receiving Frequency
0	1 CH	318.125MHz
1	2 CH	318.500MHz
2	3 CH	318.875MHz
3	4 CH	319.250MHz

NOTE: It is impossible to receive the signal if the transmission wave has no accordance with the receiving wave.

It returns to normal mode by restart.

Receiver Test Mode 2 (Melody Test)

When **POWER SW** is ON in pushing **BT CLEAR SW** and **TX BATTERY SW** on Front Panel simultaneously, it will enter into Test MODE 2.

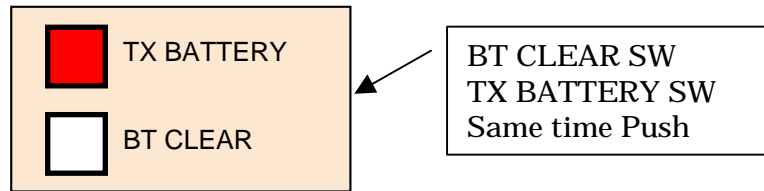

First, when **BT CLEAR SW** and **TX BATTERY SW** is pushing, **00** is displayed in 7segment LED for 1sec and then the LED of RX, COM and TX BATTERY is flashed sequentially.

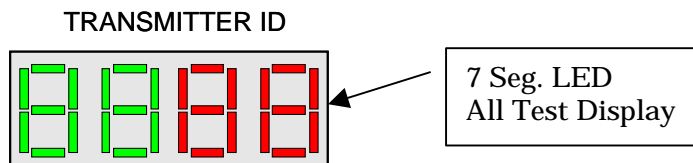

The display of 7 Seg. LED is cleared after 2sec.

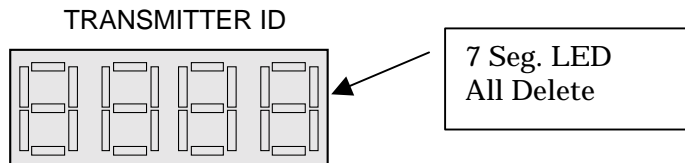

Second, release **BT CLEAR SW** and **TX BATTERY SW**, and push **BT CLEAR SW** once. It displays Melody Number **01** in 7 seg. LED with red and sounds the melody of Yankee Doodle from a loudspeaker only once except that Volume Control is OFF

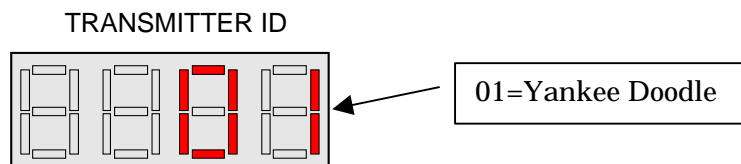

In addition, if **BT CLEAR SW** is pushed again, it displays Melody Number **02** in 7 seg. LED with red and sounds the melody of Oh Bury Me Not On The Lone Prairie only once.

Each time **BT CLEAR SW** is pushed, it sounds 16 melodies and 1 audible alarm to test these sounds.

It returns to normal mode by restart.

Pager Controller Protocol

In case of using PAGER CONTROLLER, SW1 in Main Board should be ON.



If the SW1 is ON without connecting Pager Controller by mistake or Pager Controller power is OFF, it alarms sound each 30sec.

1. Pager Controller communication Form

BAUD RATE	9600BPS
DATA BIT	8-BIT
PARITY	NONE
STOP BIT	1BIT

2.Data Format

Start BIT (1bit)	DATA (8bit)	Stop BIT (1bit)
---------------------	----------------	--------------------

3.RS-232-C Connector

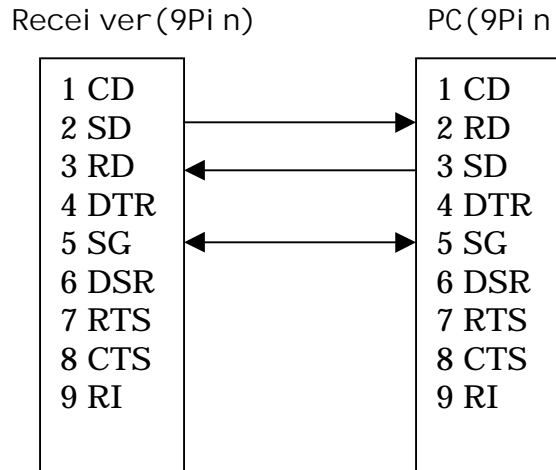

4. Communications Protocol

	[PC]	[Receiver]
<p>[Sensing Data Transfer]</p> <p>The Receiver transfers sensing information and battery shutoff information. It transfers the data periodically each 5sec.</p>		<p>_____</p> <p>_____</p> <p>... [BCC][CR]</p> <p>Transmitter ID (4-digits) which is sensing moisture or battery shutoff is transferred after [:][K], and then Transmitter status ("1" = Sensing moisture, "2" = Battery shutoff, "3" = "1" and "2") is transferred as single-digit. When multiple IDs or status is transferred, they are broken by _____ and added [BCC][CR] at the end. When there are nothing of _____ transmitting information, [K][BCC][CR] are transferred.</p>

BCC Calculating Methods

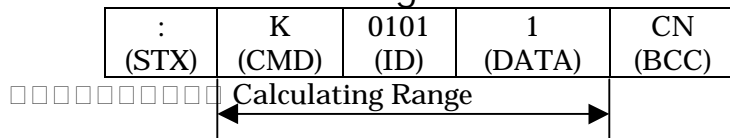

It gets the SUM from CMD to DATA and divides into MSB 4bits and LSB 4bits, and then adds 40H and converts into 2 bytes word as hexadecimal.

Example 1

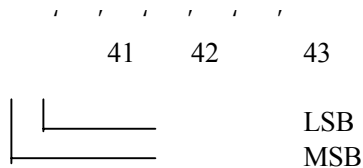

Example 2

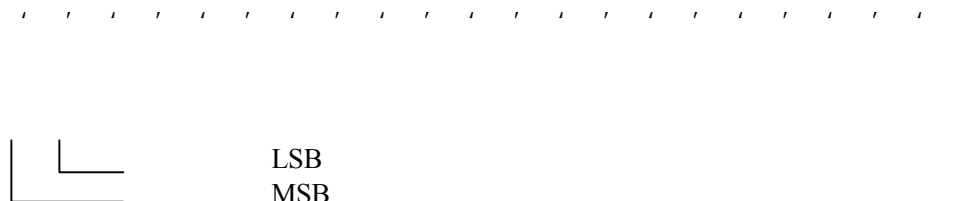

ID Types

Transmitter ID

Transmitter ID "0608" is 4-digit number, first 2-digit is Area ID and last two-digit is individual unique ID.

□ 16 types of Area ID □ "01" □ "16" ("01" □ "10" [Hex])

□ 99 types of Unique ID □ "01" □ "99" ("01" □ "63" [Hex])

□ □ □ □ □ □ □ □ □ □ □ □

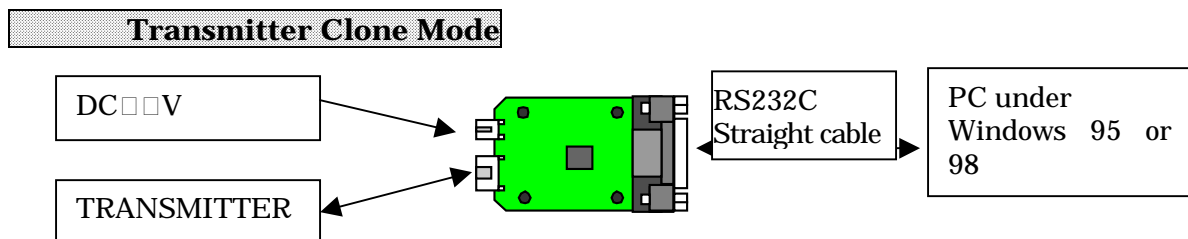

Fig.4-1 CONNECTION OF CLONING UNIT

Connect the cloning unit like above chart, and start up PC and then run "Hyper Terminal" of Windows accessory.



Fig.4.2 Initial window of Hyper Terminal

After running Hyper Terminal, the following window will open. Set as below.

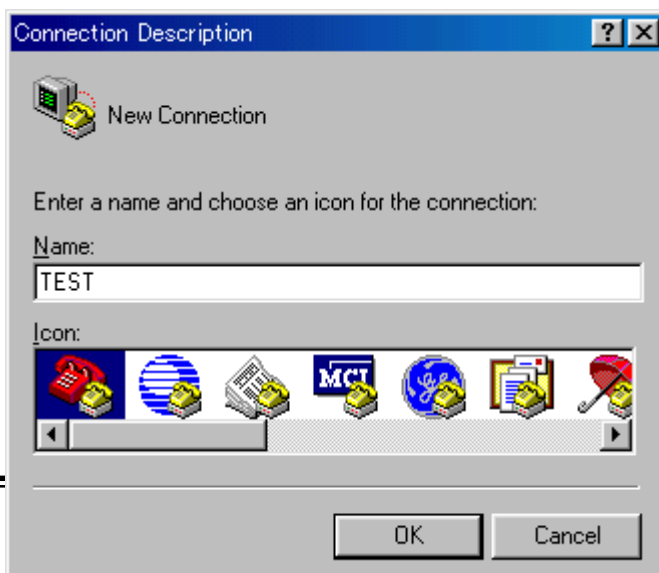

Fig.4-3-1 Start-up window of Hyper Terminal

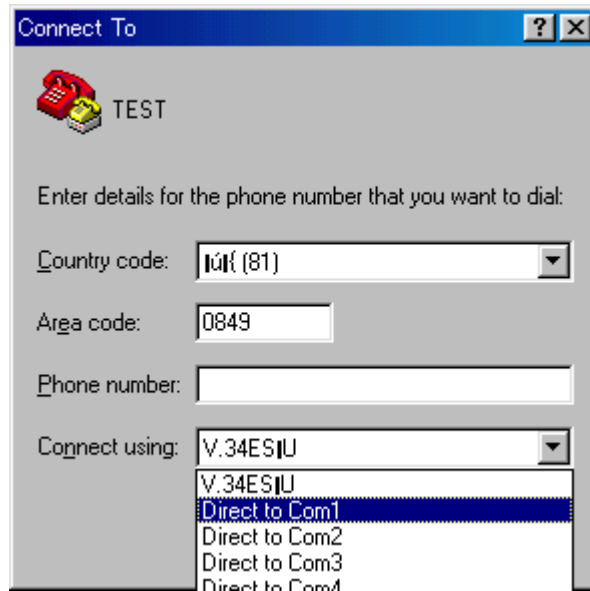

Fig.4-3-2 Setting window of COM PORT



Fig.4-3-3 Setting window of COM PORT

The following Transmitter start-up screen (Fig.4-4) will be displayed after setting Communication Port and Communication protocol and insert a battery.

```
##### TX69W01 Ver.1.0 #####  
  
**** << Current Mode Status >> ****  
  
Current Detection=[ Capacitor ]  
1.ID No. = 0112  
2.Resistor Detection Time = 3 (s)  
3.Capacitor Detection Time = 10 (s)  
4.Transmission Qty = 01  
5.STOP Time = 10 (s)  
6.Serial Modulation Qty = 06  
  
Change Mode Set = [C] ? Execute = [Enter] ?  
(Note: No Key, Auto Execute after 5 sec.)
```

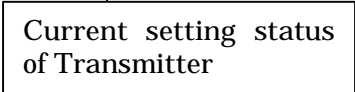

Fig.4-4 Transmitter start-up screen

At this point when pushing **C** key within 5sec, the following screen (Fig.4-5) is displayed and Mode Set can be changed. Pushing **Enter** key terminates the setting.

```
**** << Current Mode Status >> ****  
  
Current Detection=[ Capacitor ]  
1.ID No. = 0112  
2.Resistor Detection Time = 3 (s)  
3.Capacitor Detection Time = 10 (s)  
4.Transmission Qty = 01  
5.STOP Time = 10 (s)  
6.Serial Modulation Qty = 06  
  
**** << Mode Set >> ****  
  
[1] = Country Select  
[2] = ID No.  
[3] = Resistor Detection Time  
[4] = Capacitor Detection Time  
[5] = Transmission Qty  
[6] = STOP Time  
[7] = Serial Modulation Qty  
[0] = END  
  
Select [1]-[7],[0] and Press [Enter]  
>
```



Fig.4-5 Mode Set for Transmitter

Country Set (Select [] in Fig. 4-5)

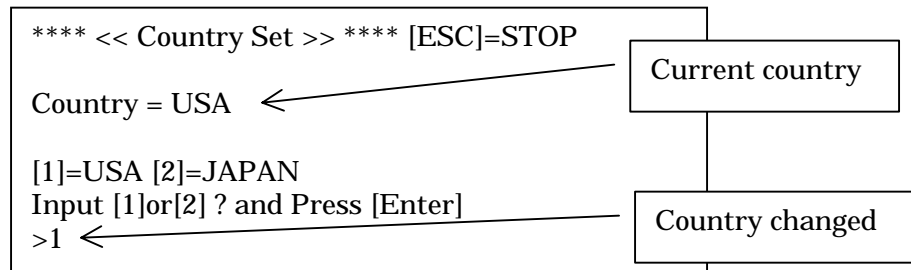

Fig.4-6 Country Set

Transmitter ID Set (Select [] in Fig.4-5)

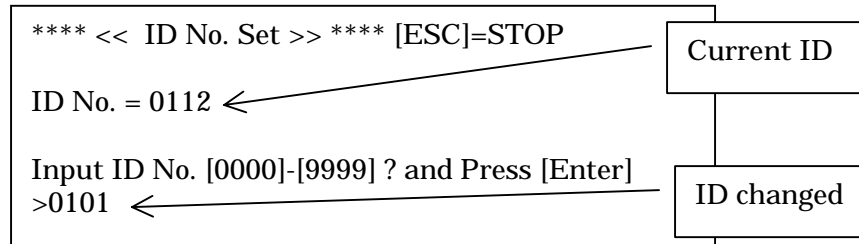

Fig.4-7 Transmitter ID Set

Setting of Resistor Detection Time. (Select [] in Fig.4-5)

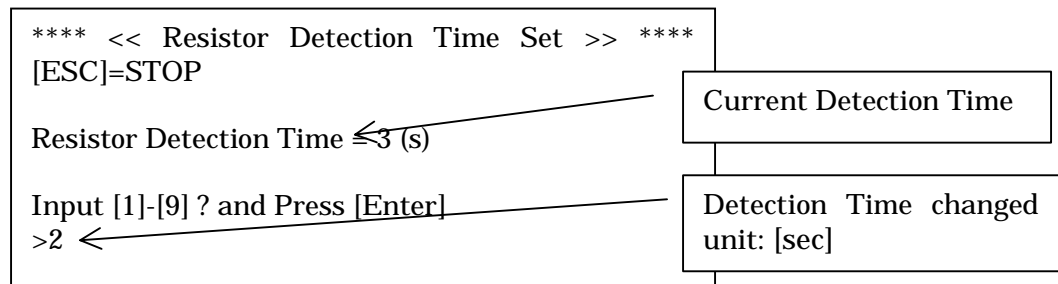

Fig.4-8 Setting of Resistor Detection Time

Setting of Capacitor Detection Time. (Select [] in Fig.4-5)

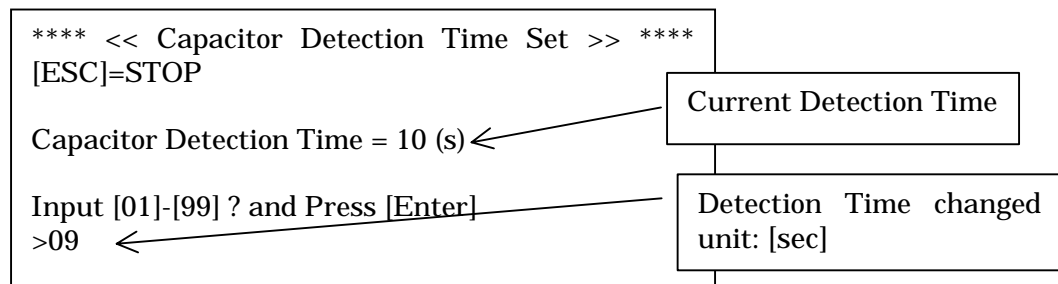

Fig.4-9 Setting of Capacitor Detection Time

Setting of Transmission number of times. (Select [] in Fig.4-5)

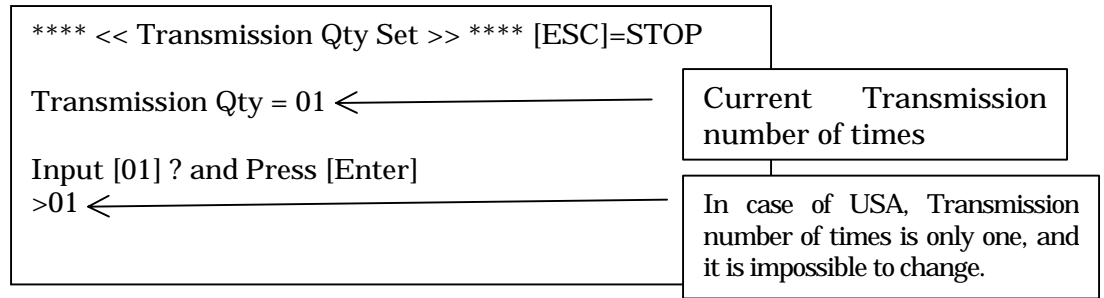

Fig.4-10 Setting of Transmission number of times

Setting of Transmission Stop Time. (Select [] in Fig.4-5)

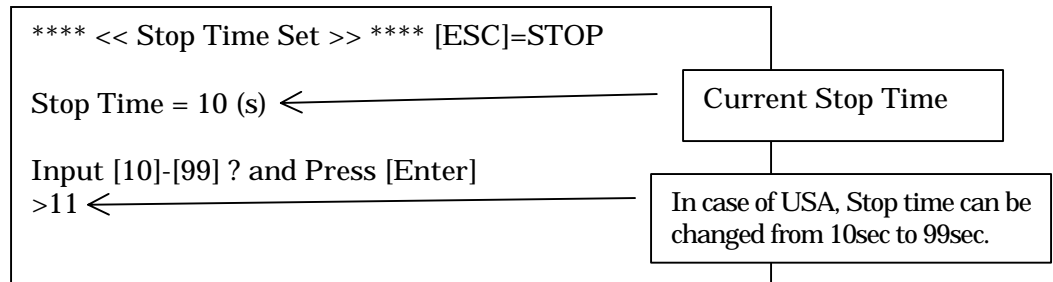

Fig.4-11 Setting of Transmission Stop Time

Setting of Modulation number of times. (Select [] in Fig.4-5)

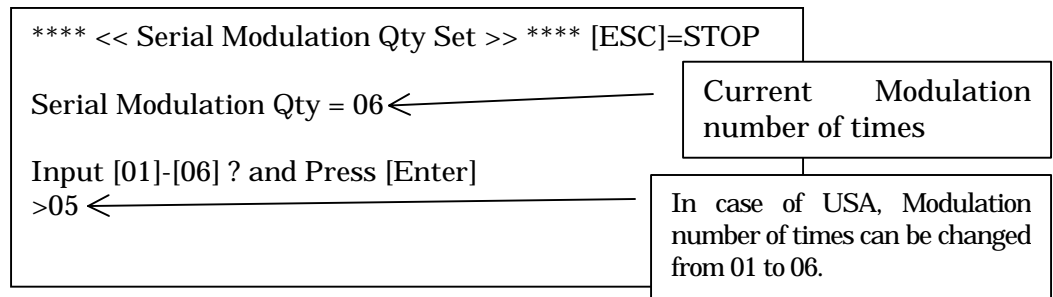

Fig.4-12 Setting of Modulation number of times

Select [] in Fig. 4-5, and then CLONING MODE will be terminated. After terminated CLONING MODE, it returns to Normal Mode.

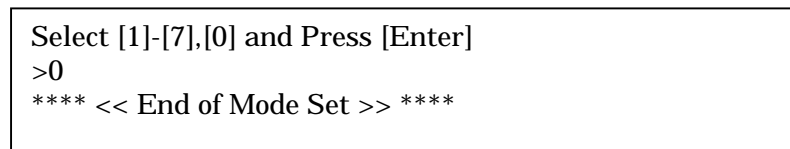

Fig.4-13 CLONING MODE Termination

Transponder Clone Mode

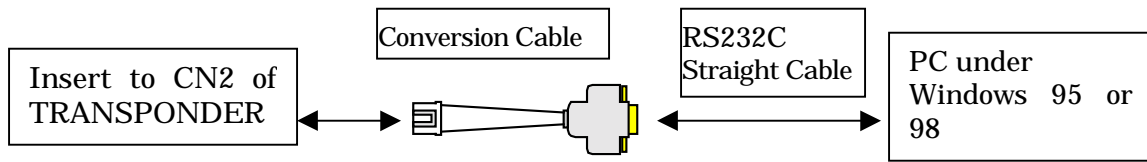

Fig.4-14 CONNECTION OF CLONING UNIT

Connect the cloning unit like above chart, and start up PC and then run “Hyper Terminal” of Windows accessory.

When TRANSPONDER turned ON, the following screen (Fig.4-15) is displayed.

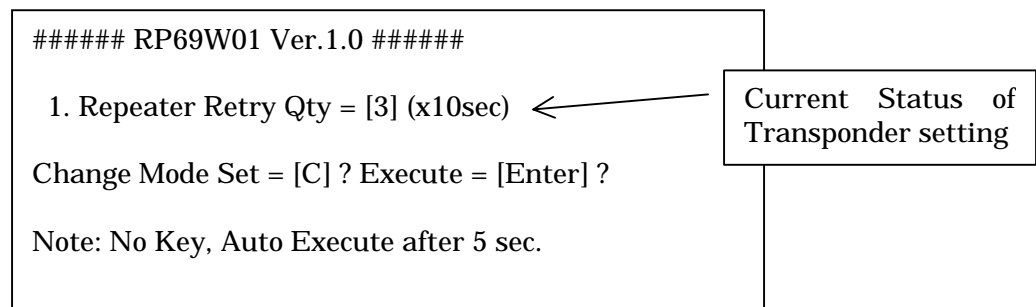

Fig.4-15 Transponder set-up screen

At this point when pushing **C** key within 5sec, the following screen (Fig.4-16) is displayed and Mode Set can be changed. Pushing **Enter** key terminates the setting.

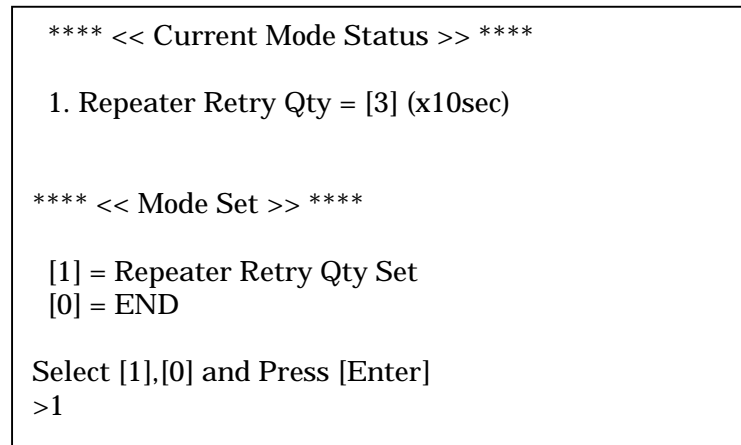

Fig.4-16 Setting for Transponder

Setting of Transponder Re-try number of times (Select [] in Fig.4-16)

It means even the signal from Transponder is aborted, it holds IDs for re-try number of times multiplied by 10sec.

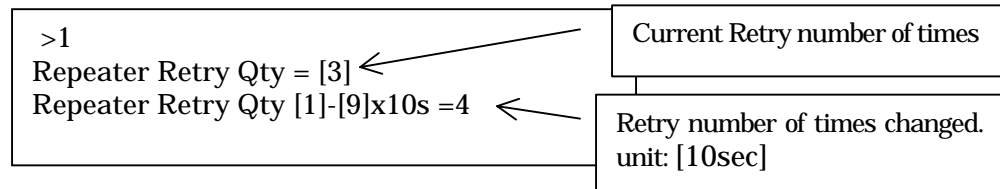

Fig.4-17 Setting of Transponder Re-try number of times

Select [] in Fig. 4-5, and then CLONING MODE will be terminated.
After terminated CLONING MODE, it returns to Normal Mode.

```
**** << Mode Set >> ****

[1] = Repeater Retry Qty Set
[0] = END

Select [1],[0] and Press [Enter]
>0
Mode set end.
```

Fig.4-18 CLONING MODE Termination

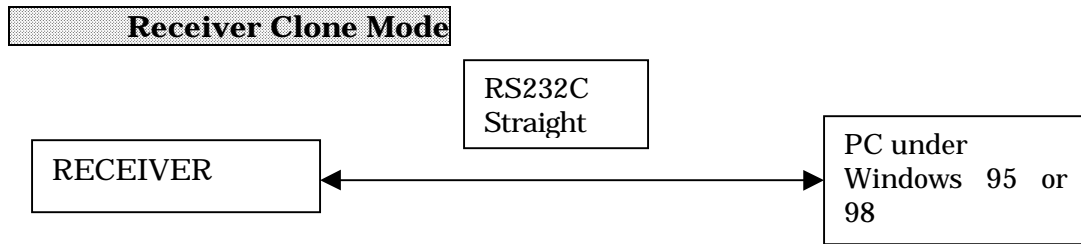

Fig.4-19 CONNECTION OF CLONING UNIT

Connect the cloning unit like above chart, and start up PC and then run “Hyper Terminal” of Windows accessory.

When Receiver turned ON, the following screen (Fig.4-20) is displayed.

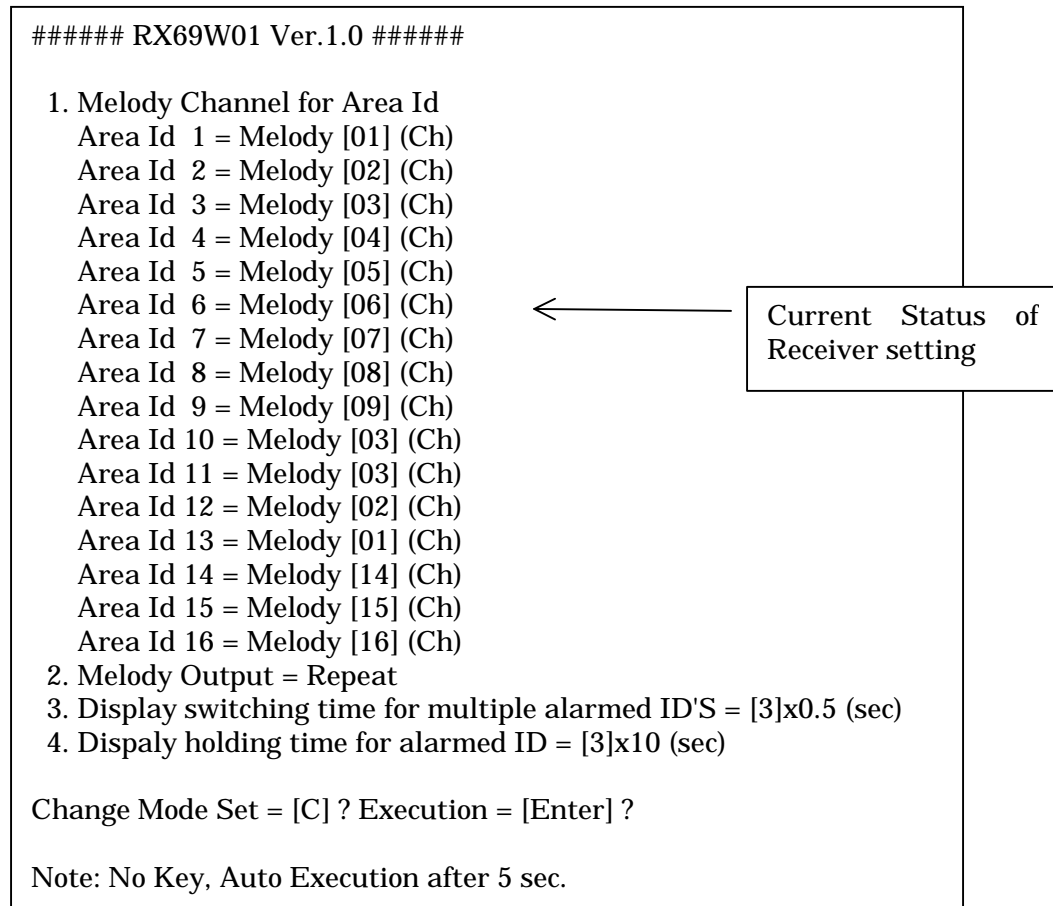

Fig.4-20 Initial screen of Receiver

At this point when pushing **C** key within 5sec, the following screen (Fig.4-5) is displayed and Mode Set can be changed. Pushing **Enter** key terminates the setting.

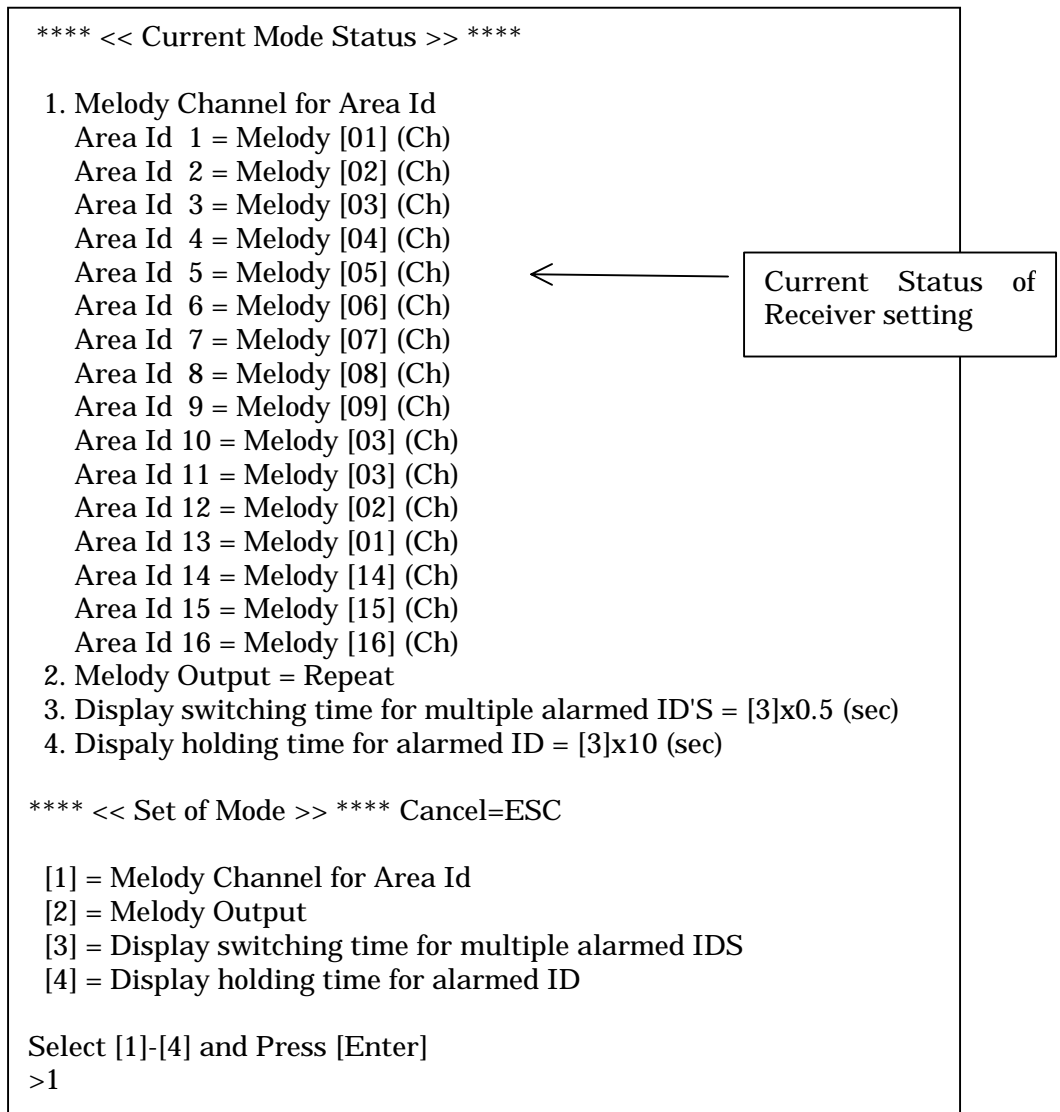

Fig.4-21 Mode Set for Receiver

Setting Melody Channel for Area ID (Select [] in Fig.4-21)

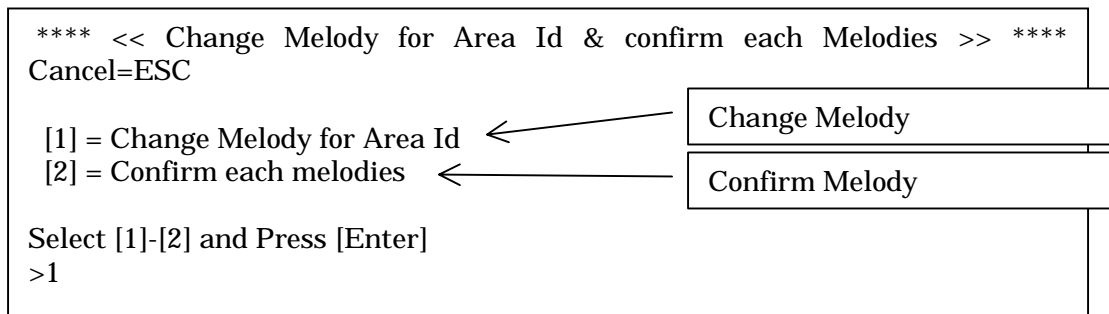

Fig.4-22 Setting Melody Channel for Area ID

Change Melody for Area Id (Select [] in Fig.4-22)

**** << Change Melody for Area Id >> **** Cancel=ESC

[01] = Setting Area Id 1
[02] = Setting Area Id 2
[03] = Setting Area Id 3
[04] = Setting Area Id 4
[05] = Setting Area Id 5
[06] = Setting Area Id 6
[07] = Setting Area Id 7
[08] = Setting Area Id 8
[09] = Setting Area Id 9
[10] = Setting Area Id 10
[11] = Setting Area Id 11
[12] = Setting Area Id 12
[13] = Setting Area Id 13
[14] = Setting Area Id 14
[15] = Setting Area Id 15
[16] = Setting Area Id 16

Select [01]-[16] and Press [Enter]

>01 ← Area ID for changing

Fig.4-23 Setting Melody Channel for Area ID

Change Melody for Area Id (Select [] in Fig.4-23)

```
**** << Change Melody for Area Id >> **** Cancel=ESC  
  
**** << Melody Name >> ****  
  
[01] = Yankee Doodle  
[02] = Oh Bury Me Not On The Lone Prairie  
[03] = Oh! Susanna  
[04] = Under The Spreading Chestnut Tree  
[05] = Grandfathers Clock  
[06] = Chitty Chitty Bang Bang  
[07] = De Camptown Races  
[08] = If Youre Happy And You Know It, Clap Your Hands  
[09] = Mary Had A Little Lamb  
[10] = Edelweiss  
[11] = Bridge Over Troubled Water  
[12] = I have Been Working On The Railroad  
[13] = Do-Re-Mi  
[14] = One Sunny Day  
[15] = Aloha Oe  
[16] = Battle Hymn of The Republic  
[17] = Alarm  
  
Select [01]-[17] and Press [Enter]  
  
Area Id 1 = Melody [01] (Ch)  
  
Melody Channel for Area Id 1 =>01
```

List of Melody name

Melody ID No. changed

The diagram shows a terminal window with a list of 17 melodies. A box labeled 'List of Melody name' has an arrow pointing to the list. Below the list, the text 'Area Id 1 = Melody [01] (Ch)' is shown. A box labeled 'Melody ID No. changed' has an arrow pointing to the text 'Melody Channel for Area Id 1 =>01'.

Fig.4-24 Setting Melody Channel for Area ID

Confirm each melodies (Select [] Confirm in Fig.4-22)

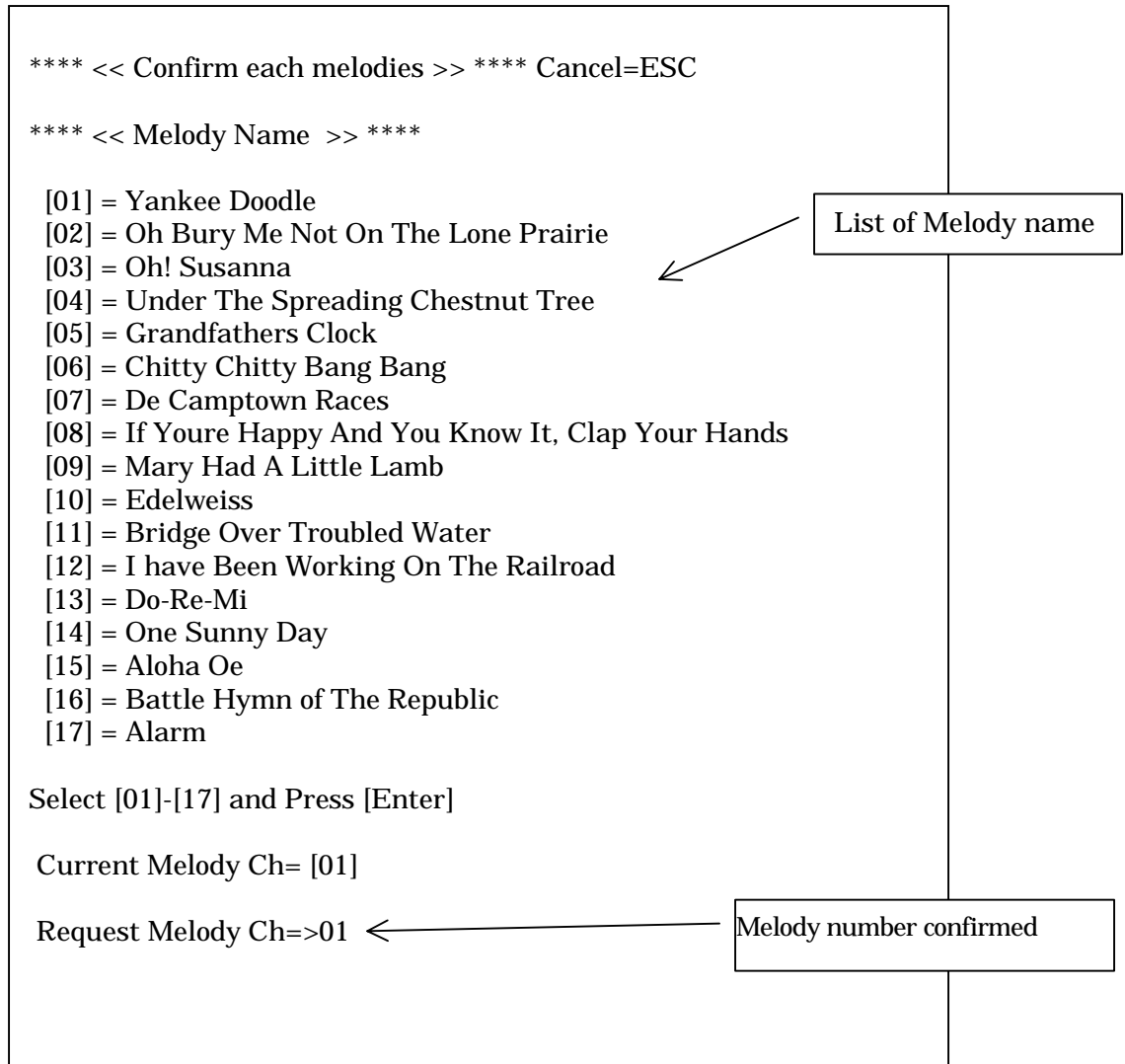

Fig.4-24 Melody Confirmation

Setting of Melody Output Method (Select [] in Fig.4-21)

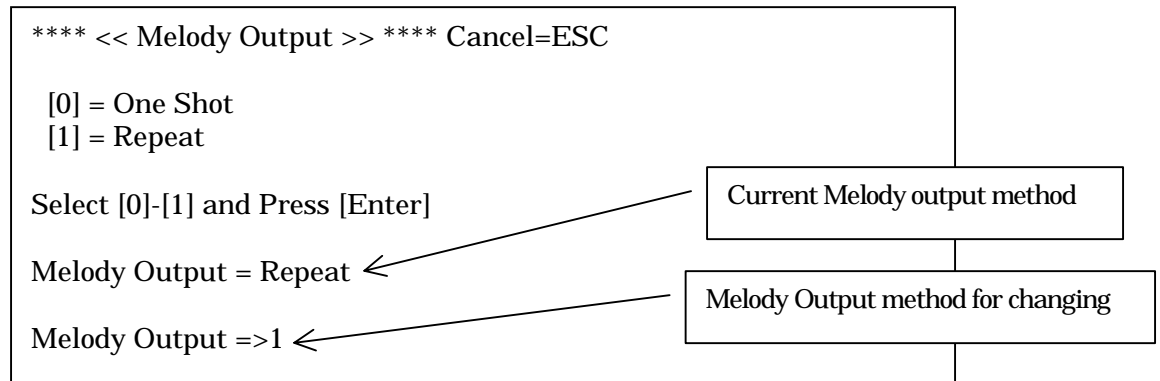

Fig.4-25 Melody output method Set

Display switching time for multiple ID's Set (Select [] in Fig.4-21)

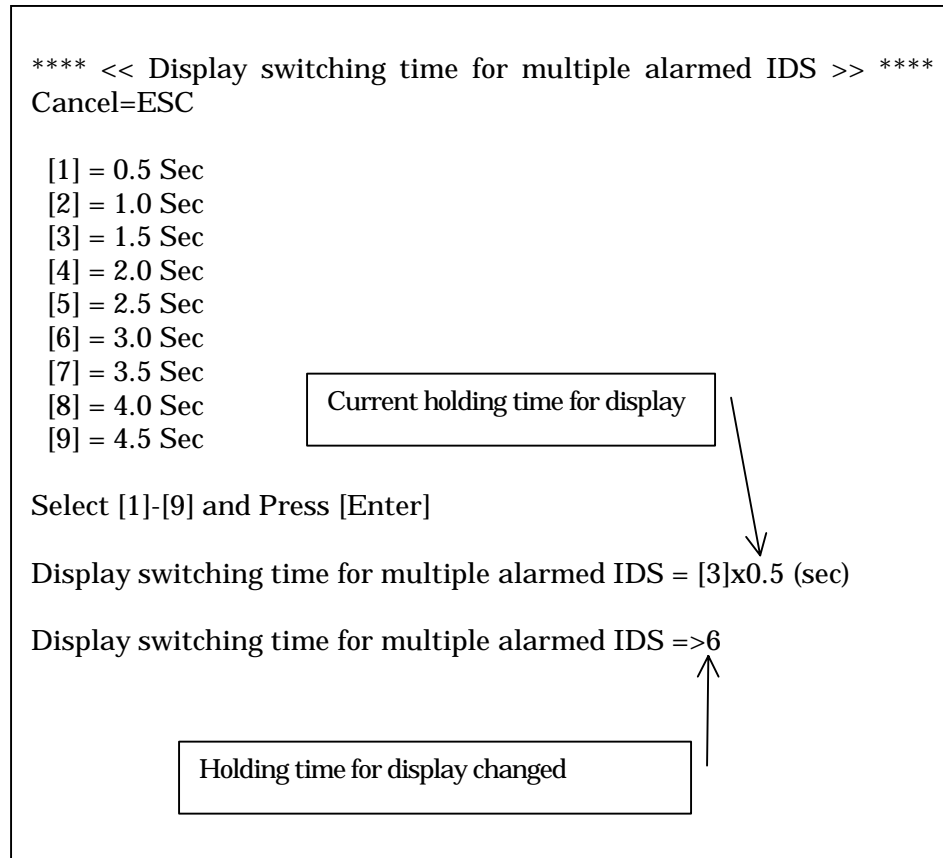

Fig.4-26 Changing Display holding time for Multiple IDs

Display holding time for alarmed ID Set (Select [] in Fig.4-21)

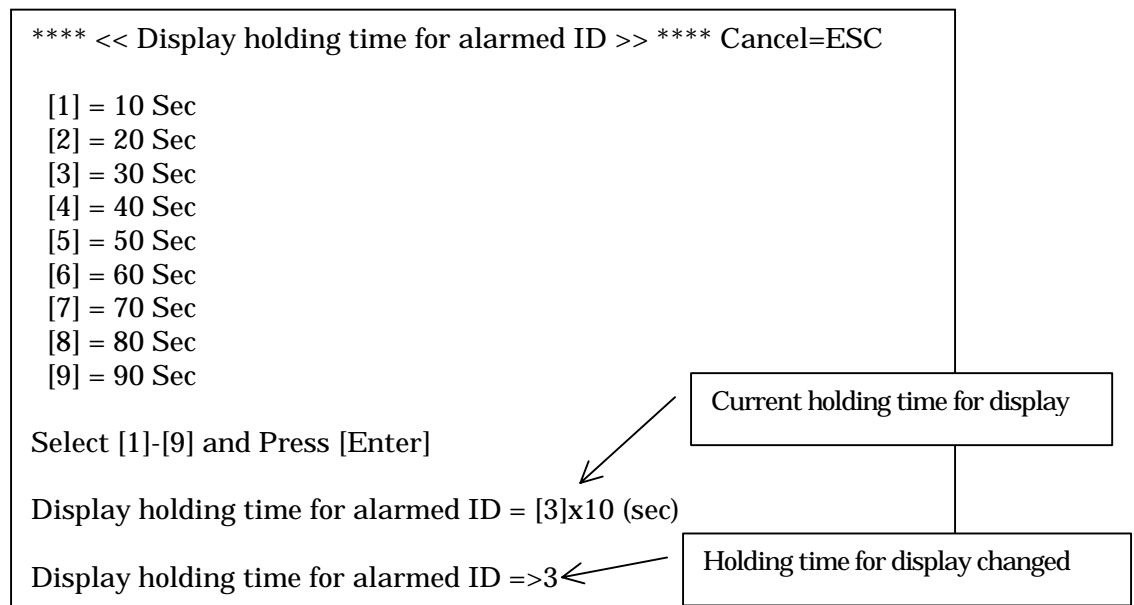

Fig.4-27 Changing Display holding time

Push [Esc] in Fig. 4-21, and then CLONING MODE will be terminated.
After terminated CLONING MODE, it returns to Normal Mode.

```
**** << Set of Mode >> **** Cancel=ESC

[1] = Melody Channel for Area Id
[2] = Melody Output
[3] = Display switching time for multiple alarmed IDS
[4] = Display holding time for alarmed ID

Select [1]-[4] and Press [Enter]
>
**** << End of Mode Set >> ****
```

Fig.4-28 CLONING MODE Termination