



**HTZ-BD52**  
**HTZ-BD32**  
**HTZ-BD92HW**  
**HTZ-BD82HF**

Blu-ray Disc surround system  
Système Home-Cinéma Blu-ray Disc  
sistema surround de Blu-ray Disc

**XV-BD422W**  
**XV-BD122W**  
**XV-BD922FSW**  
**XV-BD822FSW**

Blu-ray Disc receiver  
Système Home-Cinéma Blu-ray Disc  
receptor de Blu-ray Disc

**S-BD422W**  
**S-BD122**  
**S-BD922HW**  
**S-BD822HF**

Speaker System  
Enceintes acoustiques  
Sistemas de parlantes

**S-BD922SW**

Subwoofer  
Enceinte d'extrêmes graves  
Altavoz de subgraves

ENGLISH

FRANÇAIS

ESPAÑOL

Register your product on

<http://www.pioneerelectronics.com> (US)  
<http://www.pioneerelectronics.ca> (Canada)

- **Protect your new investment**  
The details of your purchase will be on file for reference in the event of an insurance claim such as loss or theft.
- **Receive free tips, updates and service bulletins on your new product**  
Your input helps us continue to design products that meet your needs.
- **Improve product development**  
Your input helps us continue to design products that meet your needs.
- **Receive a free Pioneer newsletter**  
Registered customers can opt in to receive a monthly newsletter.

Enregistrez votre produit sur le site Web:

<http://www.pioneerelectronics.com> (US)  
<http://www.pioneerelectronics.ca> (Canada)

- **Protégez votre nouveau matériel**  
Les renseignements relatifs à votre matériel seront conservés pour référence en cas de sinistre, tel que la perte ou le vol.
- **Recevez des conseils, des informations d'entretien et de mise à jour sur votre nouveau matériel**  
Votre participation nous aide à concevoir des produits qui répondent à vos besoins.
- **Contribuez au développement de nos produits**  
Votre participation nous aide à concevoir des produits qui répondent à vos besoins.
- **Recevez gratuitement le bulletin d'informations de Pioneer**  
Les clients enregistrés peuvent, s'ils le désirent, recevoir un bulletin d'informations mensuel.

Operating instructions  
Mode d'emploi  
Manual de instrucciones

## Safety Information

Thank you for buying this Pioneer product.

Please read through these operating instructions so you will know how to operate your model properly.

After you have finished reading the instructions, put them away in a safe place for future reference.

### IMPORTANT



The lightning flash with arrowhead symbol, within an equilateral triangle, is intended to alert the user to the presence of uninsulated "dangerous voltage" within the product's enclosure that may be of sufficient magnitude to constitute a risk of electric shock to persons.

### CAUTION

RISK OF ELECTRIC SHOCK  
DO NOT OPEN

#### CAUTION:

TO PREVENT THE RISK OF ELECTRIC SHOCK, DO NOT REMOVE COVER (OR BACK). NO USER-SERVICEABLE PARTS INSIDE. REFER SERVICING TO QUALIFIED SERVICE PERSONNEL.



The exclamation point within an equilateral triangle is intended to alert the user to the presence of important operating and maintenance (servicing) instructions in the literature accompanying the appliance.

D3-4-2-1-1\_A1\_En

When using this product, confirm the safety information shown on the bottom of the unit.

D3-4-2-2-4\_B1\_En

### CAUTION

This product is a class 1 laser product classified under the Safety of laser products, IEC 60825-1:2007.

CLASS 1 LASER PRODUCT

D58-5-2-2a\_A1\_En

### VENTILATION CAUTION

When installing this unit, make sure to leave space around the unit for ventilation to improve heat radiation (at least 10 cm at top, 10 cm at rear, and 10 cm at each side).

### WARNING

Slots and openings in the cabinet are provided for ventilation to ensure reliable operation of the product, and to protect it from overheating. To prevent fire hazard, the openings should never be blocked or covered with items (such as newspapers, table-cloths, curtains) or by operating the equipment on thick carpet or a bed.

D3-4-2-1-7b\*\_A1\_En

### WARNING

This equipment is not waterproof. To prevent a fire or shock hazard, do not place any container filled with liquid near this equipment (such as a vase or flower pot) or expose it to dripping, splashing, rain or moisture.

D3-4-2-1-3\_A1\_En

### WARNING

Before plugging in for the first time, read the following section carefully.

**The voltage of the available power supply differs according to country or region. Be sure that the power supply voltage of the area where this unit will be used meets the required voltage (e.g., 230 V or 120 V) written on the rear panel.**

D3-4-2-1-4\*\_A1\_En

### Operating Environment

Operating environment temperature and humidity: +5 °C to +35 °C (+41 °F to +95 °F); less than 85 %RH (cooling vents not blocked)

Do not install this unit in a poorly ventilated area, or in locations exposed to high humidity or direct sunlight (or strong artificial light)

D3-4-2-1-7c\*\_A1\_En

## IMPORTANT SAFETY INSTRUCTIONS

- 1) Read these instructions.
- 2) Keep these instructions.
- 3) Heed all warnings.
- 4) Follow all instructions.
- 5) Do not use this apparatus near water.
- 6) Clean only with dry cloth.
- 7) Do not block any ventilation openings. Install in accordance with the manufacturer's instructions.
- 8) Do not install near any heat sources such as radiators, heat registers, stoves, or other apparatus (including amplifiers) that produce heat.
- 9) Do not defeat the safety purpose of the polarized or grounding-type plug. A polarized plug has two blades with one wider than the other. A grounding type plug has two blades and a third grounding prong. The wide blade or the third prong are provided for your safety. If the provided plug does not fit into your outlet, consult an electrician for replacement of the obsolete outlet.
- 10) Protect the power cord from being walked on or pinched particularly at plugs, convenience receptacles, and the point where they exit from the apparatus.
- 11) Only use attachments/accessories specified by the manufacturer.
- 12) Use only with the cart, stand, tripod, bracket, or table specified by the manufacturer, or sold with the apparatus. When a cart is used, use caution when moving the cart/apparatus combination to avoid injury from tip-over.



- 13) Unplug this apparatus during lightning storms or when unused for long periods of time.
- 14) Refer all servicing to qualified service personnel. Servicing is required when the apparatus has been damaged in any way, such as power-supply cord or plug is damaged, liquid has been spilled or objects have fallen into the apparatus, the apparatus has been exposed to rain or moisture, does not operate normally, or has been dropped.

D3-7-13-69\_En

### NOTE:

This equipment has been tested and found to comply with the limits for a Class B digital device, pursuant to Part 15 of the FCC Rules. These limits are designed to provide reasonable protection against harmful interference in a residential installation. This equipment generates, uses, and can radiate radio frequency energy and, if not installed and used in accordance with the instructions, may cause harmful interference to radio communications. However, there is no guarantee that interference will not occur in a particular installation. If this equipment does cause harmful interference to radio or television reception, which can be determined by turning the equipment off and on, the user is encouraged to try to correct the interference by one or more of the following measures:

- Reorient or relocate the receiving antenna.
- Increase the separation between the equipment and receiver.
- Connect the equipment into an outlet on a circuit different from that to which the receiver is connected.
- Consult the dealer or an experienced radio/TV technician for help.

D8-10-1-2\_A1\_En

**WARNING:** Handling the cord on this product or cords associated with accessories sold with the product may expose you to chemicals listed on proposition 65 known to the State of California and other governmental entities to cause cancer and birth defect or other reproductive harm.

**Wash hands after handling.**

D36-P5\_B1\_En

This Class B digital apparatus complies with Canadian ICES-003.

D8-10-1-3\_A1\_En

If the AC plug of this unit does not match the AC outlet you want to use, the plug must be removed and appropriate one fitted. Replacement and mounting of an AC plug on the power supply cord of this unit should be performed only by qualified service personnel. If connected to an AC outlet, the cut-off plug can cause severe electrical shock. Make sure it is properly disposed of after removal. The equipment should be disconnected by removing the mains plug from the wall socket when left unused for a long period of time (for example, when on vacation).

D3-4-2-2-1a\_A1\_En

#### CAUTION

The **⏻** **STANDBY/ON** switch on this unit will not completely shut off all power from the AC outlet. Since the power cord serves as the main disconnect device for the unit, you will need to unplug it from the AC outlet to shut down all power. Therefore, make sure the unit has been installed so that the power cord can be easily unplugged from the AC outlet in case of an accident. To avoid fire hazard, the power cord should also be unplugged from the AC outlet when left unused for a long period of time (for example, when on vacation).

D3-4-2-2-2a\*\_A1\_En

#### Condensation

If the player is moved suddenly from a cold place into a warm room (in winter, for example) or if the temperature in the room in which the player is installed rises suddenly due to a heater, etc., water droplets (condensation) may form inside (on operating parts and the lens). When condensation is present, the player will not operate properly and playback is not possible. Let the player stand at room temperature for 1 or 2 hours with the power turned on (the time depends on the extent of condensation). The water droplets will dissipate and playback will become possible. Condensation can also occur in the summer if the player is exposed to the direct wind from an air-conditioner. If this happens, move the player to a different place.

S005\_A1\_En

This product is for general household purposes. Any failure due to use for other than household purposes (such as long-term use for business purposes in a restaurant or use in a car or ship) and which requires repair will be charged for even during the warranty period.

K041\_A1\_En

#### POWER-CORD CAUTION

Handle the power cord by the plug. Do not pull out the plug by tugging the cord and never touch the power cord when your hands are wet as this could cause a short circuit or electric shock. Do not place the unit, a piece of furniture, etc., on the power cord, or pinch the cord. Never make a knot in the cord or tie it with other cords. The power cords should be routed such that they are not likely to be stepped on. A damaged power cord can cause a fire or give you an electrical shock. Check the power cord once in a while. When you find it damaged, ask your nearest PIONEER authorized service center or your dealer for a replacement.

S002\*\_A1\_En

#### WARNING

To prevent a fire hazard, do not place any naked flame sources (such as a lighted candle) on the equipment.

D3-4-2-1-7a\*\_A1\_En

#### IMPORTANT NOTICE

THE MODEL NUMBER AND SERIAL NUMBER OF THIS EQUIPMENT ARE ON THE REAR OR BOTTOM. RECORD THESE NUMBERS IN THE SPACE BELOW FOR FUTURE REFERENCE.

MODEL NO. \_\_\_\_\_  
SERIAL NO. \_\_\_\_\_

D36-AP9-2\_A1\_En

#### The Safety of Your Ears is in Your Hands

Get the most out of your equipment by playing it at a safe level – a level that lets the sound come through clearly without annoying blaring or distortion and, most importantly, without affecting your sensitive hearing. Sound can be deceiving. Over time, your hearing “comfort level” adapts to higher volumes of sound, so what sounds “normal” can actually be loud and harmful to your hearing. Guard against this by setting your equipment at a safe level BEFORE your hearing adapts.

#### ESTABLISH A SAFE LEVEL:

- Set your volume control at a low setting.
- Slowly increase the sound until you can hear it comfortably and clearly, without distortion.
- Once you have established a comfortable sound level, set the dial and leave it there.

#### BE SURE TO OBSERVE THE FOLLOWING GUIDELINES:

- Do not turn up the volume so high that you can't hear what's around you.
- Use caution or temporarily discontinue use in potentially hazardous situations.
- Do not use headphones while operating a motorized vehicle; the use of headphones may create a traffic hazard and is illegal in many areas.

S001a\_A1\_En



**WARNING**

Changes or modifications not expressly approved by the party responsible for compliance could void the user's authority to operate the equipment.

**NOTE :** THE MANUFACTURER IS NOT RESPONSIBLE FOR ANY RADIO OR TV INTERFERENCE CAUSED BY UNAUTHORIZED MODIFICATIONS TO THIS EQUIPMENT. SUCH MODIFICATIONS COULD VOID THE USER'S AUTHORITY TO OPERATE THE EQUIPMENT.

**FCC warning**

This device complies with Part 15 of the FCC Rules. Operation is subject to the following two conditions: (1) this device may not cause harmful interference, and (2) this device must accept any interference received, including interference that may cause undesired operation.

**FCC RF Radiation Exposure Statement**

This equipment complies with FCC RF radiation exposure limits set forth for an uncontrolled environment. This device and its antenna must not be co-located or operating in conjunction with any other antenna or transmitter.

"To comply with FCC RF exposure compliance requirements, this grant is applicable to only Mobile Configurations. The antennas used for this transmitter must be installed to provide a separation distance of at least 20 cm from all persons and must not be co-located or operating in conjunction with any other antenna or transmitter."

**Canada IC warning**

This device complies with Industry Canada licence-exempt RSS standard(s). Operation is subject to the following two conditions: (1) this device may not cause interference, and (2) this device must accept any interference, including interference that may cause undesired operation of the device.

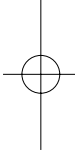
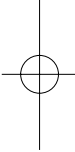

**Cautions on 3D Viewing**

- **If you should experience any fatigue or discomfort while viewing 3D images, stop viewing them.**
- **Children, particularly those under 6, may be more prone to sensitivity, so guardians should watch for any signs of fatigue or discomfort.**
- **When viewing 3D images, rest periodically.**

Extended viewing of 3D images without rest periods could cause fatigue or discomfort.

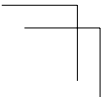

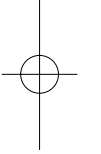
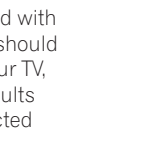
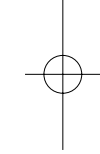

### Notes on Copyrights

- Because AACS (Advanced Access Content System) is approved as content protection system for Blu-ray Disc format, similar to use of CSS (Content Scramble System) for DVD format, certain restrictions are imposed on playback, analog signal output, etc., of AACS protected contents. The operation of this product and restrictions on this product may vary depending on your time of purchase as those restrictions may be adopted and/or changed by AACS after the production of this product.
  - Furthermore, BD-ROM Mark and BD+ are additionally used as content protection systems for Blu-ray Disc format, which imposes certain restrictions including playback restrictions for BD-ROM Mark and/or BD+ protected contents. To obtain additional information on AACS, BD-ROM Mark, BD+, or this product, please contact an authorized Customer Service Center.
  - Many BD-ROM/DVD discs are encoded with copy protection. Because of this, you should only connect your player directly to your TV, not to a VCR. Connecting to a VCR results in a distorted picture from copy-protected discs.
  - This item incorporates copy protection technology that is protected by U.S. patents and other intellectual property rights of Rovi Corporation. Reverse engineering and disassembly are prohibited.
  - Under the U.S. Copyright laws and Copyright laws of other countries, unauthorized recording, use, display, distribution, or revision of television programs, videotapes, BD-ROM discs, DVDs, CDs and other materials may subject you to civil and/or criminal liability.
- 
- 
- 

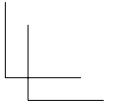
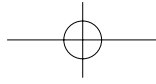
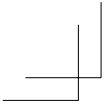

### **Important Notice for TV colour system**

The colour system of this player differs according to currently playing discs.

For example, when the player plays the disc recorded in the NTSC colour system, the image is output as an NTSC signal.

Only the multi system colour TV can receive all signals output from the player.

- If you have a PAL colour system TV, you will see just distorted images when using discs or video contents recorded in NTSC.
- The multi system colour TV changes the colour system automatically according to input signals. In case that the colour system is not changed automatically, turn it off and then on to see normal images on screen.
- Even if the disc recorded in NTSC colour system are well displayed on your TV, these may not be recorded correctly on your recorder.

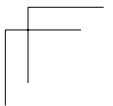
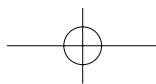
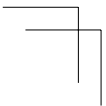
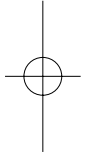
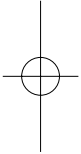

# Table of Contents

## 1 Before you start

---

- 8 Introduction
- 8 – Supplied accessories
- 8 – Accessories of speaker box (BCS-727)
- 8 – Accessories of speaker (BCS-323)
- 8 – Accessories of speaker (BCS-HW929)
- 9 – Accessories of speaker (BCS-HF828)
- 9 – Accessories of speaker (BCS-SB626)
- 9 – Accessories of speaker (BCS-FS525)
- 10 – Putting the batteries in the remote control
- 10 – Software update
- 11 – Types of discs/files that can be played
- 17 – Trademarks and licenses
- 18 Remote control
- 20 Front panel
- 21 Rear panel
- 21 – BCS-727/BCS-323
- 21 – BCS-HW929/BCS-HF828/BCS-SB626/BCS-FS525

## 2 Connecting

---

- 22 Assemble the speakers
- 22 – Speaker setup for BCS-727
- 23 – Wall mounting the speaker for BCS-727
- 24 – Additional notes on speaker for BCS-727
- 24 – Positioning the system for BCS-727
- 25 – Speaker setup for BCS-323
- 25 – Wall mounting the speaker for BCS-323
- 26 – Additional notes on speaker for BCS-323
- 26 – Positioning the system for BCS-323
- 27 – Speaker setup for BCS-HW929
- 28 – Wall mounting the speaker for BCS-HW929
- 29 – Additional notes on speaker for BCS-HW929
- 29 – Positioning the system for BCS-HW929
- 30 – Speaker setup for BCS-HF828
- 32 – Wall mounting the speakers for BCS-HF828
- 33 – Additional notes on speaker for BCS-HF828
- 33 – Positioning the system for BCS-HF828
- 34 – Speaker setup for BCS-SB626

- 35 – Wall mounting the speaker for BCS-SB626
- 36 – Additional notes on speaker placement for BCS-SB626
- 36 – Positioning the system for BCS-SB626
- 37 – Speaker setup for BCS-FS525
- 39 – Wall mounting the speakers for BCS-FS525
- 40 – Additional notes on speaker placement for BCS-FS525
- 41 – Positioning the system for BCS-FS525
- 42 Connecting to Your TV
- 42 – HDMI connection
- 43 – ARC (Audio Return Channel) function
- 43 – Video connection
- 44 Antenna connection
- 44 Connections with external device
- 44 – AUX connection
- 45 – PORTABLE IN connection
- 45 – OPTICAL IN 1/2 connection
- 46 – HDMI IN 1/2 connection
- 46 – Connecting optional *Bluetooth*® ADAPTER
- 47 Connecting to your Home Network
- 47 – Wired network connection
- 48 – Wireless network connection
- 48 – Wireless network setup
- 49 – WPS setup (Wi-Fi Protected Setup)
- 51 USB device connection

## 3 Getting Started

---

- 52 Making settings using the Setup Navigator menu
- 53 Operating the TV with the player's remote control
- 54 – TV preset code list

## 4 Playback

---

- 55 Playing discs or files
- 56 – Forward and reverse scanning
- 56 – Playing specific chapters, tracks or files
- 56 – Skipping content
- 56 – Playing in slow motion
- 56 – Step forward and step reverse
- 56 – Playing a specific section within a title or track repeatedly (A-B Repeat)
- 56 – Playing repeatedly (Repeat Play)



- 57 – Playing in the desired order (Programmed Play)
- 57 – Making bookmarks
- 57 – Zoom
- 58 – Playing photos as slideshows
- 58 – Switching the camera angles
- 58 – Switching the subtitles
- 59 – Switching the audio
- 59 – Switching the CD/SACD playback area
- 59 – Displaying the disc information
- 60 – Enjoying BONUSVIEW or BD-LIVE
- 61 – Playback functions
- 62 Using the TOOLS menu
- 62 – Playing from a specific time (Time Search)
- 63 – Playing a specific title, chapter, track or file (Search)
- 63 – Playing specified range of discs, titles or chapter (track/file) in random order
- 63 – Continuing playback from a specified position (Continued Viewing Playback)

## 5 Playback from Home Media Gallery

---

- 64 About Home Media Gallery
- 64 – About network playback
- 66 DLNA Search
- 66 Disc/USB playback
- 66 – Playing back image files
- 67 Playing in the desired order (Playlist)
- 67 – Adding tracks/files
- 67 – Playing the playlist
- 67 – Deleting tracks/files from the playlist

## 6 Playing the web contents

---

- 68 Available web contents
- 68 Playing the items

## 7 Other Operating

---

- 69 Recording Audio CD to a USB device
- 70 iPod/iPhone playback
- 70 – Connecting your TV
- 71 – Playing your iPod/iPhone
- 72 Radio Operations

- 72 – Listening to the radio
- 72 – Presetting the radio stations
- 72 – Deleting all the saved stations
- 72 – Improving poor FM reception
- 72 – Seeing information about a radio station
- 73 *Bluetooth*® ADAPTER for Wireless Enjoyment of Music
- 73 – Wireless music play
- 73 – Listen to music on a *Bluetooth* wireless technology enabled device
- 74 Karaoke
- 75 Sound

## 8 Advanced settings

---

- 76 Changing the settings
- 76 – Operating the initial setup screen
- 83 – Software updating
- 84 – Restoring all the settings to the factory default settings
- 85 – Language code table and country/area code table

## 9 Troubleshooting

---

- 86 – Picture
- 87 – Sound
- 87 – Playback
- 88 – Control function
- 88 – Network
- 89 – Others

## 10 Appendix

---

- 90 Specifications
- 94 Maintenance
- 94 – Handling the unit
- 94 – Notes on discs
- 95 Important Information Relating to Network Services

1

2

3

4

5

6

7

8

9

10

1

Before you start

## Chapter 1 Before you start

### Introduction

#### Supplied accessories

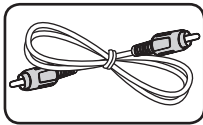

Video cable (1)

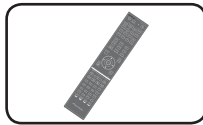

Remote control (1)

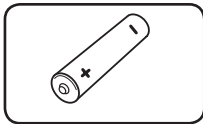

Battery (2)

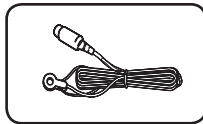

FM antenna (1)

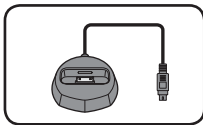

iPod cradle (1)

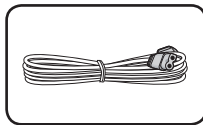

Power cord

- Warranty card (1)
- Operating instructions (This document)

#### Accessories of speaker box (BCS-727)

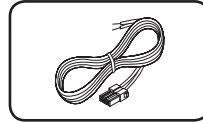

Speaker cables (4)

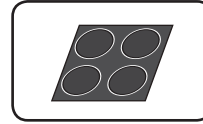

Non-skid pads (1)

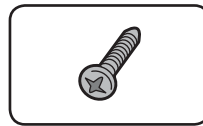

Screws M4 x 16 (16)  
(They are used to fix to the base and lower cabinet.)

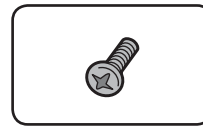

Screws M4 x 12 (8)  
(They are used to fix the upper and lower cabinet.)

#### Accessories of speaker (BCS-323)

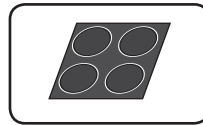

Non-skid pads (5)

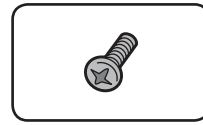

Screws M4x12  
[Taping type] (5)  
(These screws are used to fix the speakers to the stands.)

#### Accessories of speaker (BCS-HW929)

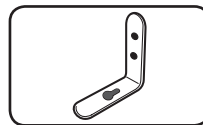

Bracket (2)

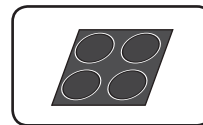

Large non-skid pads (1)

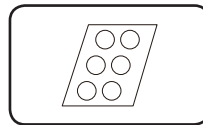

Non-skid pads (1)

- Wire stays (4)

### Accessories of speaker (BCS-HF828)

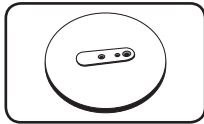

Base (2)

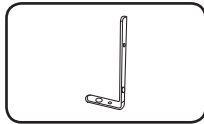

Stand arm (2)

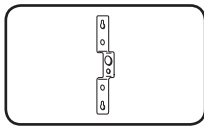

Bracket (2)

- Screw (Bind head) (2)
- Screw (Flat head) (4)
- Hexagonal nut (2)
- Seal (1)

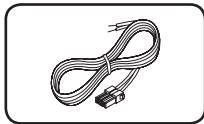

Speaker cable (1)

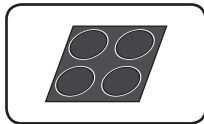

Large non-skid pads (1)

### Accessories of speaker (BCS-SB626)

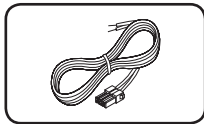

Speaker cable (1)

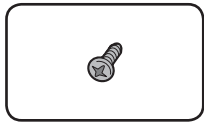

Screws (2)



Speaker stand bases (2)

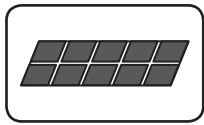

Small non-skid pads (1)

### Accessories of speaker (BCS-FS525)

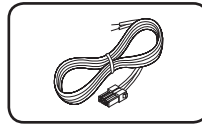

Speaker cable (3)

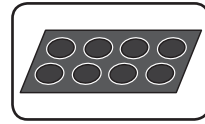

Small non-skid pads (1)

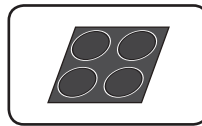

Large non-skid pads (1)

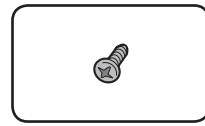

Small screws (8)

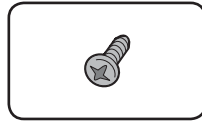

Large screws (4)



Speaker stand bases (2)

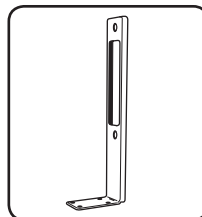

Large poles (2)

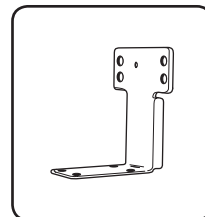

Small poles (2)

#### WARNING

Store small parts out of the reach of children and infants. If accidentally swallowed, contact a doctor immediately.

1

Before you start

## Putting the batteries in the remote control

### 1. Open the rear cover.

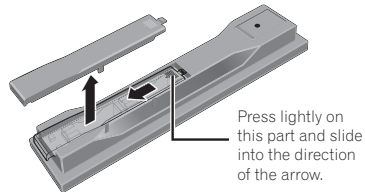

### 2. Insert the batteries (AAA/R03 x 2).

Insert as indicated by the ⊕/⊖ marks into the battery compartment.

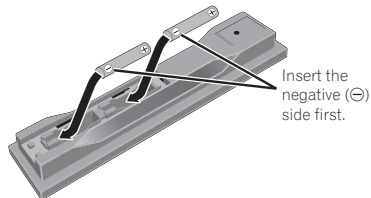

### 3. Close the rear cover.

Close securely (a click should be heard).

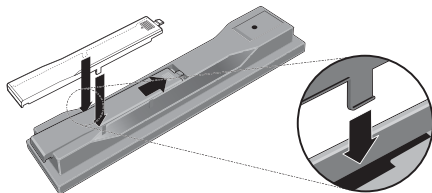

The batteries included with the player have been provided to allow you to check product operation and may not last long. We recommend using alkaline batteries that have a longer life.

### ! WARNING

- Do not use or store batteries in direct sunlight or other excessively hot place, such as inside a car or near a heater. This can cause batteries to leak, overheat, explode or catch fire. It can also reduce the life or performance of batteries.

### ! Caution

- Do not use any batteries other than the ones specified. Also, do not use a new battery together with an old one.
- When loading the batteries into the remote control, set them in the proper direction, as indicated by the polarity marks (⊕ and ⊖).
- Do not heat batteries, disassemble them, or throw them into flames or water.
- Batteries may have different voltages, even if they look similar. Do not use different kinds of batteries together.
- To prevent leakage of battery fluid, remove the batteries if you do not plan to use the remote control for a long period of time (1 month or more). If the fluid should leak, wipe it carefully off the inside of the case, then insert new batteries. If a battery should leak and the fluid should get on your skin, flush it off with large quantities of water.
- When disposing of used batteries, please comply with governmental regulations or environmental public institution's rules that apply in your country/area.

## Software update

Product information on this player is provided on the Pioneer website. Check this website for update and service information on your Blu-ray disc player.

*IN Europe:*

<http://www.pioneer.eu/>

*IN U.K.:*

<http://www.pioneer.eu/>  
<http://www.pioneer.co.uk/>

*IN Russia:*

<http://www.pioneer.eu/>  
<http://www.pioneer-rus.ru/>

*IN Hong Kong:*

<http://www.pioneerhongkong.com.hk/>

*IN Singapore:*

<http://www.pioneer.com.sg/firmwaredownload>

*IN Australia:*

<http://www.pioneer.com.au/>









## Types of discs/files that can be played

### Playable discs

Discs with the logo marks below indicated on the disc label, package or jacket can be played.

#### Caution

- Only the discs that have been finalized can be played.

Disc type	Logo	Application format					
		BDMV	BDAV	DVD-Video	DVD VR	CD-DA DTS-CD	DATA-DISC <sup>1</sup>
BD <sup>2</sup>	BD-ROM			X	X	X	X
	BD-R		✓	✓	X	X	X
	BD-RE	<i>Blu-ray Disc</i> <sup>TM</sup>	✓	✓	X	X	X
DVD	DVD-ROM						
			✓	X	✓	X	✓
							
	DVD-R <sup>2,3,4</sup>		✓ <sup>6</sup>	✓ <sup>7</sup>	✓	✓	X
	DVD-RW <sup>3,7</sup>		✓ <sup>6</sup>	✓ <sup>7</sup>	✓	✓	X
	DVD+R <sup>2,3</sup>		✓	X	✓	X	✓
	DVD+RW <sup>3</sup>		✓	X	✓	X	✓
CD	CD-DA (Audio CD) <sup>5</sup>		X	X	X	X	✓
							
	CD-R <sup>3</sup>		X	X	X	X	✓
	CD-RW <sup>3</sup>		X	X	X	X	✓
	CD-ROM		X	X	X	X	✓

1. Discs on which video, image or audio files are recorded. This player does not support multisession discs or multiborder recording.
2. Including dual-layered discs.
3. Finalize them before playing them on this player.
4. DVD-R for Authoring discs (3.95 and 4.7 GB) cannot be played.
5. Including the AVCHD format.
6. Including the AVCREC format.
7. Version 1.0 DVD-RW discs cannot be played.
8. Including Video CDs.

- "Blu-ray Disc", "Blu-ray" and "Blu-ray Disc" logo are trademarks of Blu-ray Disc Association.
-  is a trademark of DVD Format/Logo Licensing Corporation.

#### ❖ Discs that cannot be played

- HD DVDs
- DVD-RAM discs

It is possible that some discs other than the ones listed above may not be playable either.

#### ! Note

- Some discs cannot be played, even if one of the logo marks on the previous page is indicated.
- To play 8 cm discs, set the disc in the 8 cm disc depression in the center of the disc tray. No adapter is necessary. 8 cm BD-ROMs cannot be played.

#### ❖ About playback of unauthorized copies

##### Cinavia Notice

This product uses Cinavia technology to limit the use of unauthorized copies of some commercially-produced film and videos and their soundtracks. When a prohibited use of an unauthorized copy is detected, a message will be displayed and playback or copying will be interrupted.

More information about Cinavia technology is provided at the Cinavia Online Consumer Information Center at <http://www.cinavia.com>. To request additional information about Cinavia by mail, send a postcard with your mailing address to: Cinavia Consumer Information Center, P.O. Box 86851, San Diego, CA, 92138, USA.

*Copyright 2004-2010 Verance Corporation. Cinavia™ is a Verance Corporation trademark. Protected by U.S. Patent 7,369,677 and worldwide patents issued and pending under license from Verance Corporation. All rights reserved.*

#### ❖ About audio formats

The following audio formats are supported on this player:

- Dolby TrueHD
- Dolby Digital Plus
- Dolby Digital
- DTS-HD Master Audio
- DTS-HD High Resolution Audio
- DTS Digital Surround
- MPEG audio (AAC)
- Linear PCM

*Manufactured under license from Dolby Laboratories. Dolby and the double-D symbol are trademarks of Dolby Laboratories.*

*Manufactured under license under U.S. Patent Nos: 5,956,674; 5,974,380; 6,226,616; 6,487,535; 7,392,195; 7,272,567; 7,333,929; 7,212,872 & other U.S. and worldwide patents issued & pending. DTS-HD, the Symbol, & DTS-HD and the Symbol together are registered trademarks & DTS-HD Master Audio | Essential is a trademark of DTS, Inc. Product includes software. © DTS, Inc. All Rights Reserved.*

#### ❖ Playing BDs

- BDs (BDMV) compatible with the formats below can be played.
  - Blu-ray Disc Read-Only (ROM) Format Version 2
  - Blu-ray Disc Recordable (R) Format Version 2
  - Blu-ray Disc Rewritable (RE) Format Version 3

This player supports BD-ROM Profile 5.



*"Blu-ray 3D" and "Blu-ray 3D" logo are trademarks of Blu-ray Disc Association.*

BONUSVIEW functions such as playback of secondary video (Picture-in-Picture) and secondary audio can be used. The data used with the BONUSVIEW functions (the secondary video (Picture-in-Picture) and secondary audio data) may be stored in the storage. For details on secondary video and secondary audio playback, refer to the disc's instructions.

## BONUS VIEW™

"BONUSVIEW" is trademark of Blu-ray Disc Association.

BD-LIVE functions such as downloading movie trailers or additional audio and subtitle languages and playing on-line games can be enjoyed over the Internet. The data downloaded with the BD-LIVE function (trailers, etc.) is stored in the storage. Refer to the disc's instructions for details about BD-LIVE functions.



"BD-LIVE" logo is trademark of Blu-ray Disc Association.

With BD-ROMs, it is possible to use BD-J (Java) applications to create highly interactive titles, for example including games.



Oracle and Java are registered trademarks of Oracle and/or its affiliates. Other names may be trademarks of their respective owners.

- BDs (BD-RE) compatible with the formats below can be played.
  - Blu-ray Disc Recordable (R) Format Version 1
  - Blu-ray Disc Rewritable (RE) Format Version 2

### ❖ Playing DVDs



This label indicates playback compatibility with DVD-RW discs recorded in VR format (Video Recording format). However, for discs recorded with a record-only-once encrypted program, playback can only be achieved using a CPRM compatible device.

The AVCHD is a high definition (HD) digital video camera recorder format recording high-definition onto certain media by using highly efficient codec technologies.



"AVCHD" and the "AVCHD" logo are trademarks of Panasonic Corporation and Sony Corporation.

### ❖ About region numbers

Blu-ray Disc Player and BD-ROM or DVD-Video discs are assigned region numbers according to the region in which they are sold.

This player's region numbers are:

- BD-ROM:
  - Europe, Australia and New Zealand models: B
  - Russia models: C
  - Others: A
- DVD-Video:
  - Europe models: 2
  - Australia and New Zealand models: 4
  - Russia models: 5
  - Others: 3

Discs not including these numbers cannot be played. Discs playable on this player are as shown below.

- BDs:
  - Europe, Australia and New Zealand models: B (including B) and ALL
  - Russia models: C (including C) and ALL
  - Others: A (including A) and ALL
- DVDs:
  - U.K. models: 2 (including 2) and ALL
  - Australia and New Zealand models: 4 (including 4) and ALL
  - Russia models: 5 (including 5) and ALL
  - Others: 3 (including 3) and ALL

1

Before you start

❖ **Playing CDs**

Regarding copy protected CDs: This player is designed to conform to the specifications of the Audio CD format. This player does not support the playback or function of discs that do not conform to these specifications.

❖ **DualDisc playback**

A DualDisc is a two-sided disc, one side of which contains DVD content - video, audio, etc. - while the other side contains non-DVD content such as digital audio material.

The DVD side of a DualDisc can be played on this player.

The non-DVD, audio side of the disc is not compatible with this player.

It is possible that when loading or ejecting a DualDisc, the opposite side to that being played will be scratched. Scratched discs may not be playable.

For more detailed information on the DualDisc specification, please refer to the disc manufacturer or disc retailer.

❖ **Playing discs created on computers or BD/DVD recorders**

- It may not be possible to play discs recorded using a computer due to the application settings or computer's environment settings. Record discs in a format playable on this player. For details, contact the dealer.
- It may not be possible to play discs recorded using a computer or a BD/DVD recorder, if burn quality is not good due to characteristics of the disc, scratches, dirt on the disc, dirt on the recorder's lens, etc.

❖ **About video, audio, and image files and folders**

Audio and image files can be played on this player when the folders on the disc or USB device are created as described below.

Example of folder structure:

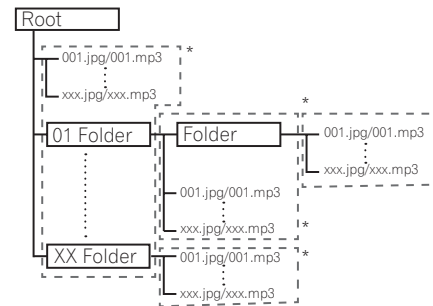

\* The number of folders and files within a single folder (including the root directory) is limited to a maximum of 256. Also, keep the number of folder layers to a maximum of 5.

! **Note**

- The file and folder names displayed on this player may differ from those displayed on a computer.



## Playable files

Video, image and audio files recorded on BDs, DVDs, CDs or USB devices can be played.

### ! Caution

- In DVD, only the one recorded by the ISO 9660 file system can be played.
- Some files may not be playable.
- For some files, it may not be possible to use certain functions during playback.
- It may not be possible to play some files, even if they have the extension of a file playable on this player.
- Files protected by DRM (Digital Rights Management) cannot be played (not including DivX VOD files).

### ❖ Supported video file formats

- **Real RMVB (Only for ASEAN and Taiwan models)**



*Real RMVB logo is a trademark or a registered trademark of RealNetworks, Inc.*

- **DivX Plus HD**

DivX Certified<sup>®</sup> to play DivX<sup>®</sup> and DivX PlusTM HD (H.264/MKV) video up to 1080p HD including premium content.

ABOUT DIVX VIDEO: DivX<sup>®</sup> is a digital video format created by DivX, Inc. This is an official DivX Certified<sup>®</sup> device that plays DivX video. Visit [divx.com](http://divx.com) for more information and software tools to convert your files into DivX video.

ABOUT DIVX VIDEO-ON-DEMAND: This DivX Certified<sup>®</sup> device must be registered in order to play purchased DivX Video-on-Demand (VOD) movies. To obtain your registration code, locate the DivX VOD section in your device setup menu. Go to [vod.divx.com](http://vod.divx.com) for more information on how to complete your registration.



*DivX<sup>®</sup>, DivX Certified<sup>®</sup>, DivX PlusTM HD and associated logos are trademarks of DivX, Inc. and are used under license.*

### ! Note

- This DivX<sup>®</sup> Certified device must be registered in order to play DivX Video-on-Demand (VOD) content. First generate the DivX VOD registration code for your device and submit it during the registration process. Important: DivX VOD content is protected by a DivX DRM (Digital Rights Management) system that restricts playback to registered DivX Certified devices. If you try to play DivX VOD content not authorized for your device, the message **Authorization Error** will be displayed and your content will not be played. Learn more at [www.divx.com/vod](http://www.divx.com/vod).
  - This player's DivX VOD registration code can be checked at **HOME MENU → Initial Setup → Playback → DivX(R) VOD DRM → Registration Code** (page 78).
  - The number of views is restricted for some DivX VOD files. When such files are played on this player, the remaining number of views is displayed. Files for which the remaining number of views has reached 0 cannot be played (**This DivX rental has expired is displayed**). Files for which the number of views is not restricted can be played as many times as you like (the remaining number of views is not displayed).

## ❖ Table of Playable Files

Playable files (Extensions)	Playable media			File specifications
	BD-R/RE/-R DL/ RE DL/-R LTH, DVD-R/RW/-R DL/ +R/+RW/+R DL, CD-R/RW	USB devices <sup>1</sup>	Network <sup>2</sup>	
MP3 (.mp3)	✓	✓	✓	Sampling frequencies: Up to 48 kHz Bit rate: Up to 320 kbps Audio type: MPEG-1 Audio Layer 3
WMA (.wma)	✓	✓	✓	Sampling frequencies: Up to 48 kHz Bit rate: Up to 192 kbps Audio type: WMA version 9
LPCM (.wav)	✓	✓	✓	Sampling frequencies: Up to 192 kHz Quantization bitrate: 16 bit Channel: 2ch
FLAC (.flac)	✓	✓	✗	Sampling frequencies: Up to 192 kHz Quantization bitrate: 16 bit, 24 bit Channel: 2ch
JPEG (.jpg/.jpeg)	✓	✓	✓	Maximum resolution: 4 000 x 3 000 pixels
DivX (.avi/.divx/.mkv)	✓	✓	✓	Supported versions: Through DivX® PLUS HD Maximum resolution: Up to 1 920 x 1 080 (DivX® PLUS HD) Up to 1 280 x 720 (MKV)
MP4 (.mp4)	✓	✓	✓	Maximum resolution: Up to 1 920 x 1 080 Video: MPEG4, MPEG-4 AVC (level 4.1) Audio: AAC, MP3
WMV (.wmv)	✓	✓	✓	Maximum resolution: Up to 1 280 x 720 Video: WMV9, WMV9AP (VC-1) Audio: WMA
AVI (.avi)	✓	✓	✓	Maximum resolution: Up to 1 920 x 1 080 Video: MPEG4 Audio: MP3, AAC, AC-3
RMVB <sup>3</sup> (.rm/.rmvb)	✓	✓	✗	Maximum resolution: Up to 1 280 x 720 Video: RealVideo® Audio: RealAudio®, AAC

1. This unit supports FAT16, FAT32 and NTFS file systems.

2. A requirement for playing files as a DMP. For details, see page 64.

3. Only for ASEAN and Taiwan models.

## ! Note

- Depending on the file structure and server capacity, it may not be possible to play certain files, even for files indicated on the table of playable files above.
- Copyright-protected files and contents recorded from digital broadcasts (satellite, cable or digital terrestrial) cannot be played via LAN.
- Files protected by DRM (Digital Rights Management) cannot be played.
- AVCHD contents cannot be played via LAN.

## Trademarks and licenses

# HDMI

HDMI, the HDMI logo, and High-Definition Multimedia Interface are trademarks or registered trademarks of HDMI Licensing LLC in the United States and other countries.



Manufactured under license from Dolby Laboratories. "Dolby" and the double-D symbol are trademarks of Dolby Laboratories.



Manufactured under license under U.S. Patent Nos: 5,956,674; 5,974,380; 6,226,616; 6,487,535; 7,392,195; 7,272,567; 7,333,929; 7,212,872 & other U.S. and worldwide patents issued & pending. DTS-HD, the Symbol, & DTS-HD and the Symbol together are registered trademarks & DTS-HD Master Audio | Essential is a trademark of DTS, Inc. Product includes software. © DTS, Inc. All Rights Reserved.



DLNA®, the DLNA Logo and DLNA CERTIFIED® are trademarks, service marks, or certification marks of the Digital Living Network Alliance.



The Wi-Fi CERTIFIED Logo is a certification mark of the Wi-Fi Alliance.



The Wi-Fi Protected Setup Mark is a trademark of the Wi-Fi Alliance.

# x.v.Colour x.v.Color

"x.v.Colour", **x.v.Colour** and **x.v.Color** are trademarks of Sony Corporation.



"Made for iPod" and "Made for iPhone" mean that an electronic accessory has been designed to connect specifically to iPod, or iPhone, respectively, and has been certified by the developer to meet Apple performance standards. Apple is not responsible for the operation of this device or its compliance with safety and regulatory standards. Please note that the use of this accessory with iPod or iPhone may affect wireless performance.

*iPhone, iPod, iPod classic, iPod nano, and iPod touch are trademarks of Apple Inc., registered in the U.S. and other countries.*



YouTube™ is a trademark of Google Inc.



Picasa™ Web Albums is a trademark of Google Inc.

This product includes technology owned by Microsoft Corporation and cannot be used or distributed without a license from Microsoft Licensing, Inc.

1

Before you start

1

Before you start

## Remote control

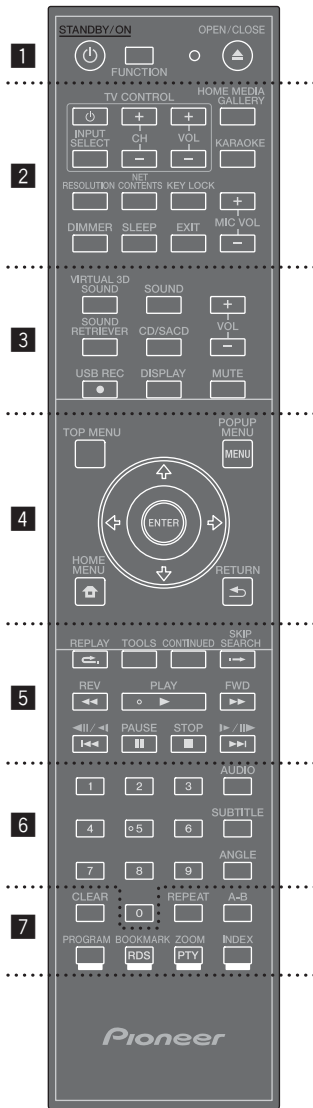

..... 1 .....

**⏻ (STANDBY/ON):** Press to turn the power on and off.

**FUNCTION:** Changes the input source or function.

**When switching while viewing the display window on the player**

1. The input source switches every time the **FUNCTION** is pressed.
2. Select the desired input source and press **ENTER**.

**When switching while viewing the TV or monitor**

1. Press **FUNCTION** to display the [Source Menu].
2. The input source switches every time the **FUNCTION** is pressed. You can also use the cursor **←/→** to switch the input source.
3. Select the desired input source and press **ENTER**.

\* The Source Menu screen can also be displayed by [**HOME MENU**] → [**Source Menu**] and pressing **ENTER**.

**▲ OPEN/CLOSE:** Opens and closes the disc tray.

..... 2 .....

**TV Control Buttons:** See page 53.

**HOME MEDIA GALLERY:** See page 64.

**KARAOKE:** Press to display the Karaoke Settings screen.

**RESOLUTION:** Sets the output resolution for HDMI (See page 77).

**NET CONTENTS:** Enhances the picture quality of network video contents.

**KEY LOCK:** See page 19.

**MIC VOLUME:** Adjust mic volume.

**DIMMER:** Dims the light on the unit.

**SLEEP:** Sets a certain period of time after which the unit will switch to off.

**EXIT:** See page 68.

..... 3 .....

**VIRTUAL 3D SOUND:** Switch VIRTUAL 3D SOUND effects. (See page 75)

**SOUND:** Switches to Sound settings. (See page 75).

**VOL +/- :** Adjusts speaker volume.

**SOUND RETRIEVER:** Switches Sound Retriever setting.

**CD/SACD:** See page 59.

● **USB REC:** Records an audio.

**DISPLAY:** Displays or exits On- Screen Display.

**MUTE:** Mute the unit.

• • • • • **4** • • • • •

**TOP MENU:** Press to display the top menu of the BD-ROM or DVD-Video.

**POPUP MENU/MENU:** Press to display the BD-ROM or DVD-Video menus.

▲/▼/◀/▶ (up/ down/ left/ right): Used to navigate on-screen displays.

**ENTER:** Acknowledges menu selection.

🏠 **HOME MENU:** Displays or exits the [Home Menu].

↩ **RETURN:** Press to return to the previous screen.

• • • • • **5** • • • • •

**REPLAY:** Press to jump back 10 seconds when ⏮-REPLAY is pressed during playback.

**TOOLS:** See page 62.

**CONTINUED:** Use to continue playback from a specified position.

**SKIP SEARCH:** Press to skip 30 seconds ahead when **SKIP SEARCH** is pressed during playback.

⏮/⏪/⏩/⏭: See page 56.

**PLAY (▶):** Starts playback.

**REV/FWD (◀◀/▶▶):** See page 56.

**PAUSE (⏸):** Pauses playback.

**STOP (■):** Stops playback or recording.

• • • • • **6** • • • • •

**0-9 numerical buttons:** Selects numbered options in a menu or inputs letters in the keypad menu.

**AUDIO:** See page 59.

**SUBTITLE:** See page 58.

**ANGLE:** See page 58.

• • • • • **7** • • • • •

**CLEAR:** Press to clear the numeric number, etc.

**REPEAT:** See page 56.

**A-B:** See page 56.

**Color buttons:** Use these to navigate BD-ROM menus.

**PROGRAM:** Registers FM radio stations.

**BOOKMARK (RDS):** Create a BOOKMARK (page 57). When FM TUNER is selected, switches RDS information (page 72).

**ZOOM (PTY):** Will zoom in or zoom out. When this button is pressed while the FM tuner is selected, the PTY value will switch.

**INDEX:** Slideshow playback (page 58).

❖ **Keylock function**

You can set the keylock to prevent accidental operations.

This function allows TVs compatible with control function with HDMI to also perform a Key Lock on the player.

Press and hold **KEYLOCK** for more than 2 seconds.

- Each time you perform this operation, the function is activated or deactivated.
- If you try to operate the player while the keylock function is set, LOCK lights on the front panel display.



Before you start

1

Before you start

## Front panel

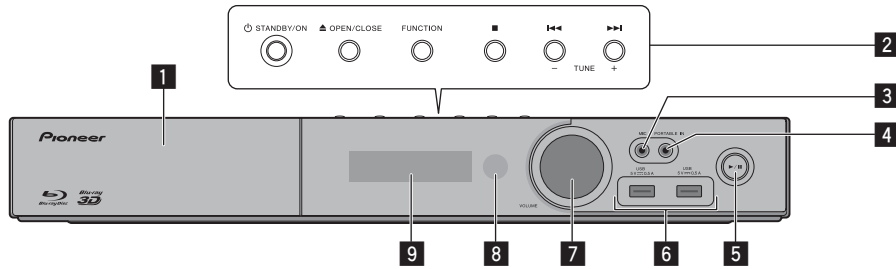

**1** Disc tray

**2** Operation buttons

⏻ (STANDBY/ON)

Switches the unit ON or OFF.

**Note**

If the power does not turn OFF, pressing the ⏻ (STANDBY/ON) button for more than 5 seconds reboots the unit and the operation becomes possible.

▲ (OPEN/CLOSE)

**FUNCTION**

Changes the input source or function.

**When switching while viewing the display window using the button on the front panel**

1. The input source switches every time the **FUNCTION** is pressed.
2. Select the desired input source and press **▶/|| (PLAY/PAUSE)**.

■ (STOP)

⏮/⏭ (SKIP)

-TUNE + (Radio tuning)

**3** MIC

**4** PORTABLE

**5** ▶/|| (PLAY/PAUSE)

**6** USB port

**7** Volume control

**8** Remote control sensor

Point the remote control to this, then operate it within approximately 7 m. The player may have trouble capturing remote control signals if there is a fluorescent light nearby. If this happens, move the player away from the fluorescent light.

**9** Display Window

## Rear panel

### BCS-727/BCS-323

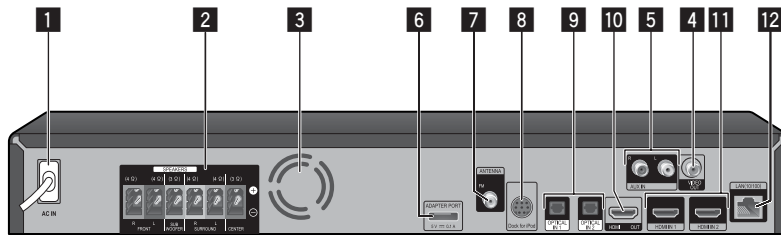

### BCS-HW929/BCS-HF828/BCS-SB626/BCS-FS525

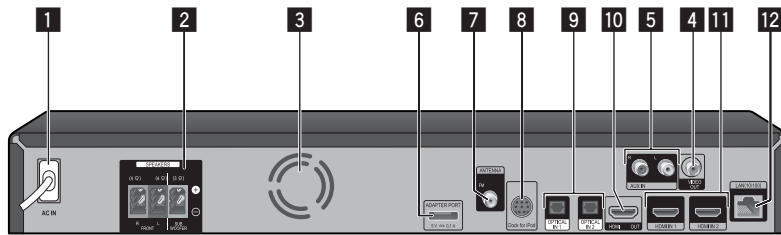

- |  |   |
|--|---|
| <ul style="list-style-type: none"> <li><b>1</b> AC IN<br/>Plug into the power source.</li> <li><b>2</b> SPEAKERS connectors</li> <li><b>3</b> Cooling Fan</li> <li><b>4</b> VIDEO OUT</li> <li><b>5</b> AUX IN (L/R)</li> <li><b>6</b> ADAPTER PORT</li> <li><b>7</b> Antenna Connector</li> </ul> | <ul style="list-style-type: none"> <li><b>8</b> iPod<br/>Connect to the furnished iPod cradle.</li> <li><b>9</b> OPTICAL IN 1/2</li> <li><b>10</b> HDMI OUT</li> <li><b>11</b> HDMI IN 1/2</li> <li><b>12</b> LAN port</li> </ul> |
|--|---|

1  
Before you start

## Chapter 2 Connecting

### Assemble the speakers

#### Speaker setup for BCS-727

##### Preparing the speakers

1. Connect the wires to the player.

Insert the cables connected to the player to the same colored connector on the speaker.

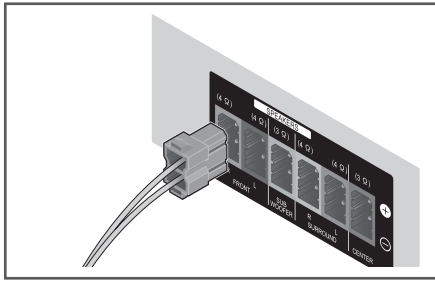

##### ⚠ Caution

- These speaker terminals carry **HAZARDOUS LIVE voltage**. To prevent the risk of electric shock when connecting or disconnecting the speaker cables, disconnect the power cord before touching any uninsulated parts.
- Do not connect any speakers other than those supplied to this system.
- Do not connect the supplied speakers to any amplifier other than the one supplied with this system. Connection to any other amplifier may result in malfunction or fire.

2. Attach the non-skid pads to the base of each speaker.

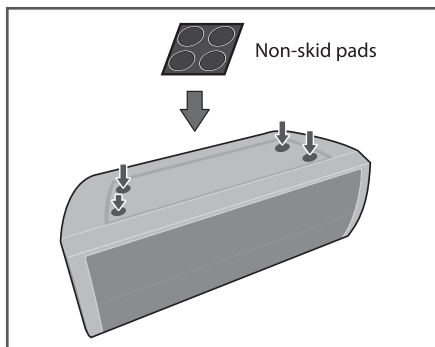

3. Mount the front/surround speaker.

- ① Pass the speaker cable through the cable hole on the side of the base.

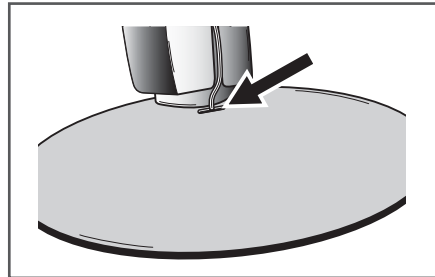

- ② Insert the lower cabinet to the base so that the cable hole is positioned at the backside.

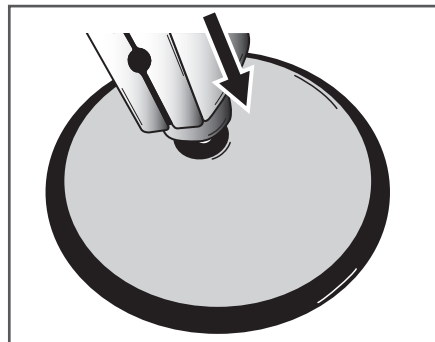

- ③ Fix the base to the lower cabinet from the underside, using the four screws (M4 x 16).

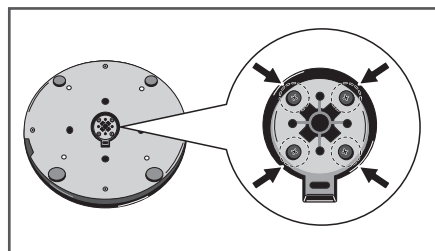



- ④ Insert the upper cabinet to the lower cabinet.

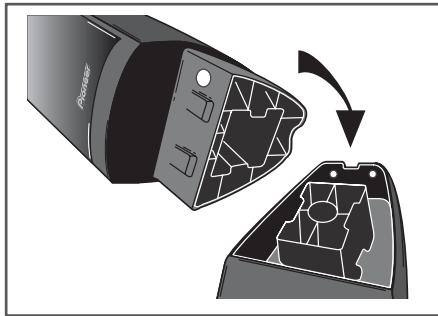

- ⑤ Fix the upper cabinet and the lower cabinet from the backside of the speaker using the two screws (M4 x 12).

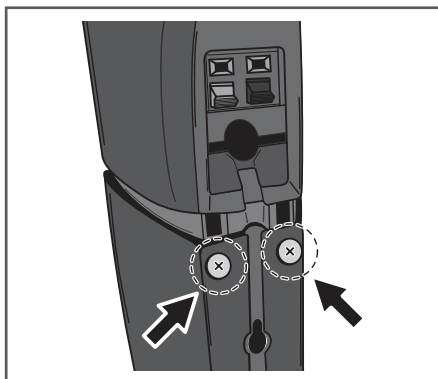

**! Caution**

- Be careful not to tighten screws excessively. If excessive force is used to tighten screws, the threads of screw and/or nut may be damaged. Use a middle-sized manual screwdriver during assembly. Do not use power screwdrivers or oversized screwdrivers that may exert excessive force on the screws and nuts. Confirm that no foreign matter is stuck to the base or the lower cabinet during assembly. If the unit is assembled with foreign matter stuck between the base and lower cabinet, the unit may not be assembled securely, resulting in tipping or falling.
- Do not stand on the speaker stand base of the tall speaker to push or swing the speaker. The speaker may fall and break, or someone may be injured. Pay special attention to children.

**Wall mounting the speaker for BCS-727**

The center speaker have a mounting hole which can be used to mount the speaker on the wall.

**Before mounting**

Remember that the speaker system is heavy and that its weight could cause the screws to work loose, or the wall material to fail to support it, resulting in the speaker falling. Make sure that the wall you intend to mount the speakers on is strong enough to support them. Do not mount on plywood or soft surface walls.

Mounting screws are not supplied. Use screws suitable for the wall material and support the weight of the speaker.

**! Caution**

- If you are unsure of the qualities and strength of the wall, consult a professional for advice.
- Pioneer is not responsible for any accidents or damage that result from improper installation.

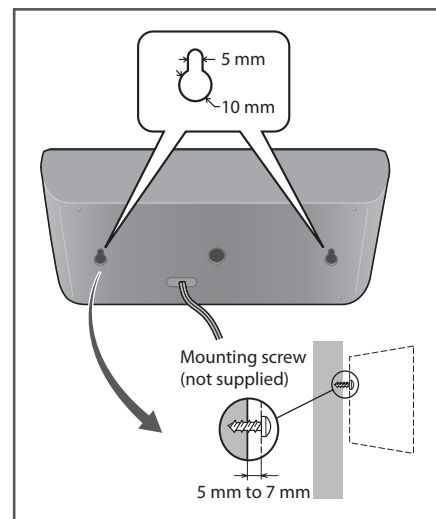

## Additional notes on speaker for BCS-727

Install the main front left and right speakers at an equal distance from the TV.

### Precautions:

The center speaker supplied with this system are magnetically shielded. However, depending on the installation location, color distortion may occur if the speaker is installed extremely close to the screen of a television set. If this case happens, turn the power switch of the television set OFF, and turn it ON after 15 min. to 30 min. If the problem persists, place the speaker system away from the television set.

The subwoofer is not magnetically shielded and so should not be placed near a TV or monitor. Magnetic storage media (such as floppy discs and tape or video cassettes) should also not be kept close to the subwoofer.

Do not attach the subwoofer to a wall or ceiling. They may fall off and cause injury.

## Positioning the system for BCS-727

The following illustration shows an example of positioning the system. Note that the illustrations in these instructions differ from the actual unit for explanation purposes. For the best possible surround sound, all the speakers other than the subwoofer should be placed at the same distance from the listening position (A).

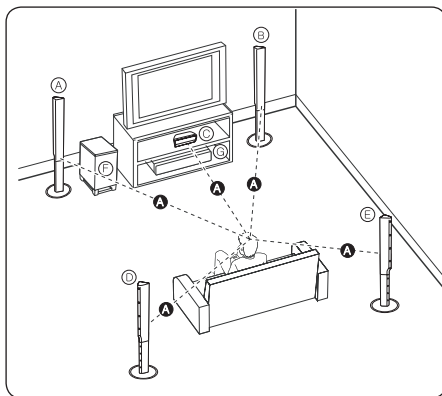

### (A) Front left speaker (L)/

### (B) Front right speaker (R):

Place the front speakers to the sides of the monitor or screen and as flush with the screen surface as possible.

### (C) Center speaker:

Place the center speaker below or in front of the monitor or screen.

### (D) Surround left speaker (L)/

### (E) Surround right speaker (R):

Place these speakers behind your listening position, facing slightly inwards.

### (F) Subwoofer:

The position of the subwoofer is not so critical, because low bass sounds are not highly directional. But it is better to place the subwoofer near the front speakers. Turn it slightly toward the center of the room to reduce the wall reflections.

### (G) Unit

### ! Caution

- Be careful to make sure children do not put their hands or any objects into the \*subwoofer duct.  
\*subwoofer duct: A hole for plentiful bass sound on subwoofer cabinet (enclosure).
- Place the centre speaker at a safe distance from the child's reach.  
Otherwise it may result in the speaker falling down and causing personal injury and/or property damage.
- The speakers contain magnet parts, so color irregularity may occur on the TV screen (CRT) or PC monitor screen. Please use the speakers away from the TV screen (CRT) or PC monitor screen.

## Speaker setup for BCS-323

### Preparing the speakers

1. Connect the wires to the player.

Insert the cables connected to the player to the same colored connector on the speaker.

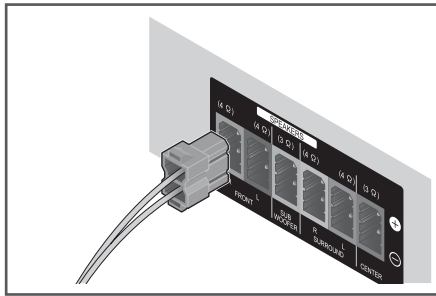

#### ⚠ Caution

- These speaker terminals carry **HAZARDOUS LIVE voltage**. To prevent the risk of electric shock when connecting or disconnecting the speaker cables, disconnect the power cord before touching any uninsulated parts.
  - Do not connect any speakers other than those supplied to this system.
  - Do not connect the supplied speakers to any amplifier other than the one supplied with this system. Connection to any other amplifier may result in malfunction or fire.
2. Attach the non-skid pads to the base of each speaker.

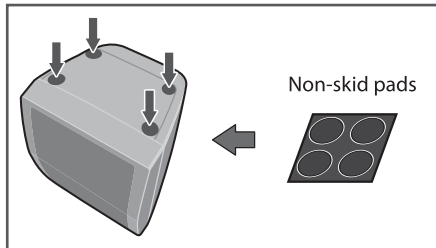

## Wall mounting the speaker for BCS-323

All speakers have a mounting hole which can be used to mount the speaker on the wall.

### Before mounting

Remember that the speaker system is heavy and that its weight could cause the screws to work loose, or the wall material to fail to support it, resulting in the speaker falling. Make sure that the wall you intend to mount the speakers on is strong enough to support them. Do not mount on plywood or soft surface walls.

Mounting screws are not supplied. Use screws suitable for the wall material and support the weight of the speaker.

#### ⚠ Caution

- If you are unsure of the qualities and strength of the wall, consult a professional for advice.
- Pioneer is not responsible for any accidents or damage that result from improper installation.

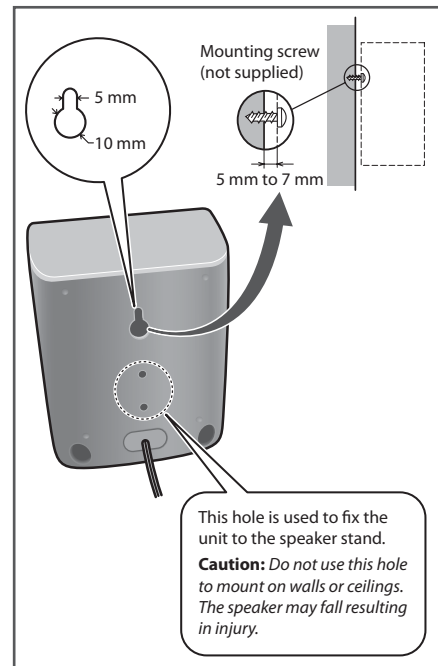

## Additional notes on speaker for BCS-323

Install the main front left and right speakers at an equal distance from the TV.

### Precautions:

The center speaker supplied with this system are magnetically shielded. However, depending on the installation location, color distortion may occur if the speaker is installed extremely close to the screen of a television set. If this case happens, turn the power switch of the television set OFF, and turn it ON after 15 min. to 30 min. If the problem persists, place the speaker system away from the television set.

The subwoofer is not magnetically shielded and so should not be placed near a TV or monitor. Magnetic storage media (such as floppy discs and tape or video cassettes) should also not be kept close to the subwoofer.

Do not attach the subwoofer to a wall or ceiling. They may fall off and cause injury.

## Positioning the system for BCS-323

The following illustration shows an example of positioning the system. Note that the illustrations in these instructions differ from the actual unit for explanation purposes. For the best possible surround sound, all the speakers other than the subwoofer should be placed at the same distance from the listening position (A).

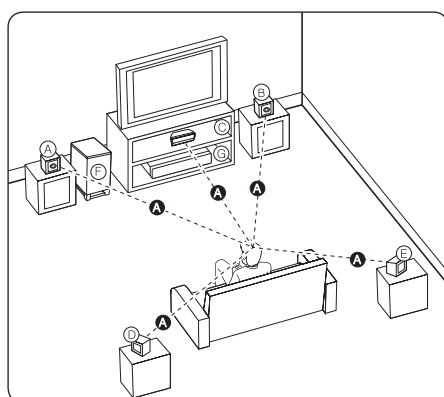

### Ⓐ Front left speaker (L)/

### Ⓑ Front right speaker (R):

Place the front speakers to the sides of the monitor or screen and as flush with the screen surface as possible.

### Ⓒ Center speaker:

Place the center speaker below or in front of the monitor or screen.

### Ⓓ Surround left speaker (L)/

### Ⓔ Surround right speaker (R):

Place these speakers behind your listening position, facing slightly inwards.

### Ⓕ Subwoofer:

The position of the subwoofer is not so critical, because low bass sounds are not highly directional. But it is better to place the subwoofer near the front speakers. Turn it slightly toward the center of the room to reduce the wall reflections.

### Ⓖ Unit

### ⚠ Caution

- Be careful to make sure children do not put their hands or any objects into the \*subwoofer duct. \*subwoofer duct: A hole for plentiful bass sound on subwoofer cabinet (enclosure).
- Place the centre speaker at a safe distance from the child's reach. Otherwise it may result in the speaker falling down and causing personal injury and/or property damage.
- The speakers contain magnet parts, so color irregularity may occur on the TV screen (CRT) or PC monitor screen. Please use the speakers away from the TV screen (CRT) or PC monitor screen.

## Speaker setup for BCS-HW929

### Preparing the speakers

1. Attach the non-skid pads to the base of each speaker.

#### For front speaker:

Use the supplied adhesive to attach six pads to the base (bottom) of speaker.

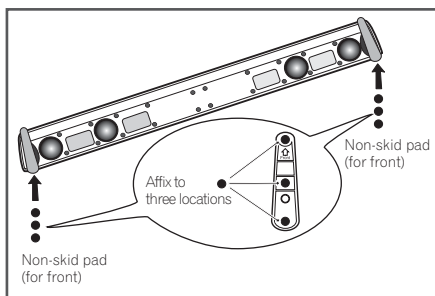

#### For subwoofer:

Use the supplied adhesive to attach four large pads to the base of subwoofer.

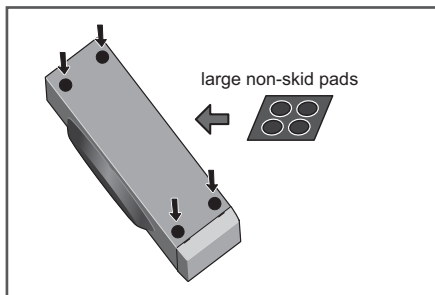

2. Connect the wires to the player.

Insert the cables connected to the player to the same colored connector on the speaker.

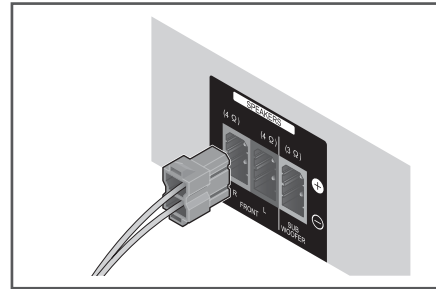

2

Connecting

### Caution

- Do not connect any speakers other than those supplied to this system.
- Do not connect the supplied speakers to any amplifier other than the one supplied with this system. Connection to any other amplifier may result in malfunction or fire.
- Please connect the speaker cable of subwoofer (purple) to orange of the player.
- These speaker terminals carry **HAZARDOUS LIVE voltage**. To prevent the risk of electric shock when connecting or disconnecting the speaker cables, disconnect the power cord before touching any uninsulated parts.

## Wall mounting the speaker for BCS-HW929

### Before mounting

- Remember that the speaker system is heavy and that its weight could cause the screws to work loose, or the wall material to fail to support it, resulting in the speaker falling. Make sure that the wall you intend to mount the speaker on is strong enough to support them. Do not mount on plywood or soft surface walls.
- Mounting screws are not supplied. Use screws suitable for the wall material and support the weight of the speaker.

### ⚠ Caution

- If you are unsure of the qualities and strength of the wall, consult a professional for advice.
- Pioneer is not responsible for any accidents or damage that result from improper installation.

#### 1 Remove the base plates.

The base plates are held in position by the use of 2-sided tape. While holding the leg in place, strongly press the base plate in the direction indicated by the arrow to remove the base plate. Be careful not to damage the front speaker while doing this.

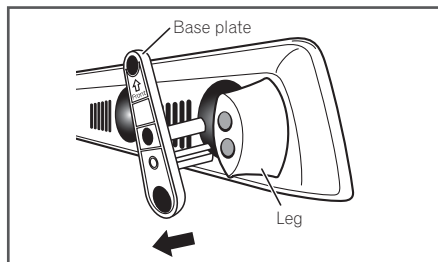

2. Using the two screws removed in step 1, fasten the wall mounting fixtures to the speaker.

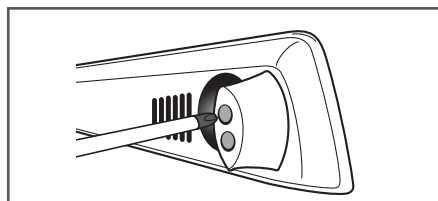

3. Using the two screws removed in step 1, fasten the wall mounting fixtures to the speaker.

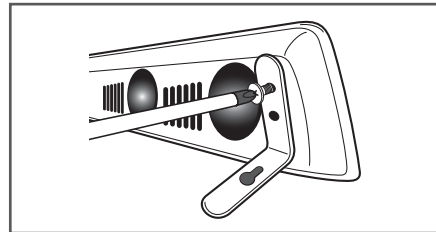

4. Affix the supplied wire stays to the top of the unit as shown and collect the cable there.

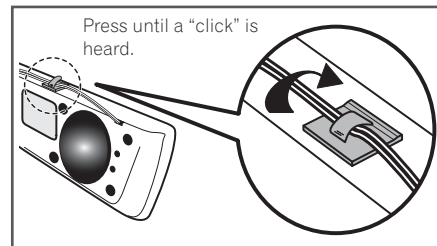

5. Mount on wall.

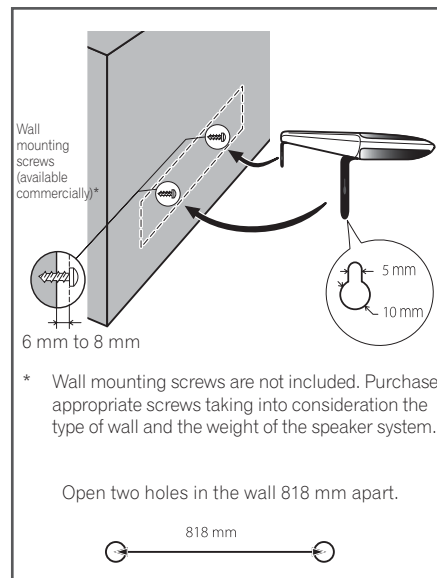

Open two holes in the wall 818 mm apart.



## Additional notes on speaker for BCS-HW929

Install the front speaker below the TV, in the center position.

### Precautions:

Make sure that all the bare speaker wire is twisted together and inserted fully into the speaker terminal. If any of the bare speaker wire touches the back panel it may cause the power to cut off as a safety measure.

The front speaker and subwoofer are not magnetically shielded and so should not be placed near a TV or monitor. Magnetic storage media (such as floppy discs and tape or video cassettes) should also not be kept close to the front speaker and subwoofer.

Do not attach the subwoofer to a wall or ceiling. They may fall off and cause injury.

## Positioning the system for BCS-HW929

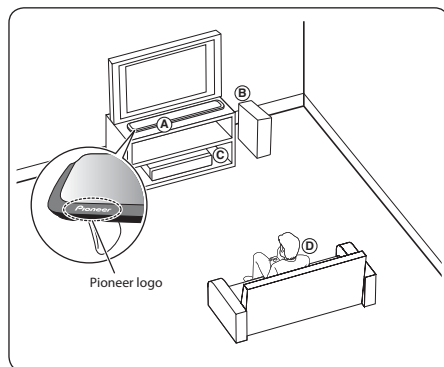

### Ⓐ Front speaker

The front speaker should be installed so as to reflect sound off the television screen, thus producing the Sound Wing's characteristic breadth of sound. When installing the speaker, orient the unit so that front speaker's top edge is pointed up, then bring it closer to the television screen so that the Pioneer logo is oriented as shown in the accompanying illustration.

### Ⓑ Subwoofer:

The position of the subwoofer is not so critical, because low bass sounds are not highly directional. But it is better to place the subwoofer near the front speaker. Turn it slightly toward the center of the room to reduce the wall reflections.

### Ⓒ Unit

### Ⓓ Listening position

### ⚠ Caution

- Be careful to make sure children do not put their hands or any objects into the \*subwoofer duct. \*subwoofer duct: A hole for plentiful bass sound on subwoofer cabinet (enclosure).
- The speakers contain magnetic parts, so colour irregularity may occur on the TV screen (CRT) or PC monitor screen. Please use the speakers away from the TV screen (CRT) or PC monitor screen.
- Do not stand on the speaker, nor hang it from another object, since it may fall or be otherwise damaged. Be especially careful if infants are present, and do not allow them to hold to or lean on the unit.

## Speaker setup for BCS-HF828

### Preparing the speakers

#### For subwoofer:

Use the supplied adhesive to attach four large pads to the base of subwoofer.

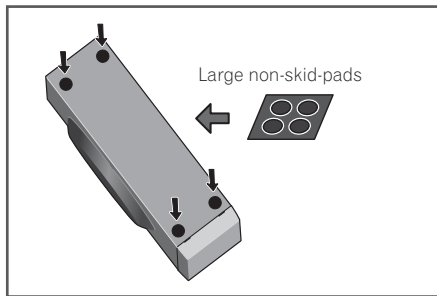

#### For front speakers:

Assembling the speaker stands and securing your front speakers.

#### For horizontal installation:

##### ! Caution

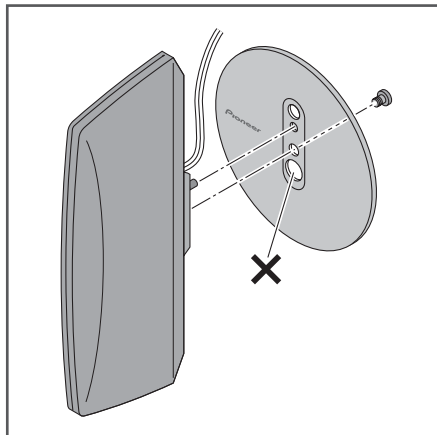

1. Align the rotation stop lug with the hole in the base.



2. Fasten the speaker to the base use the horizontal mounting screw from the back side of the base.

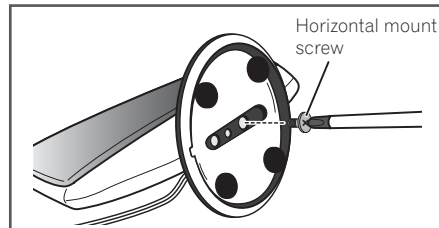

#### For vertical installation

##### ! Caution

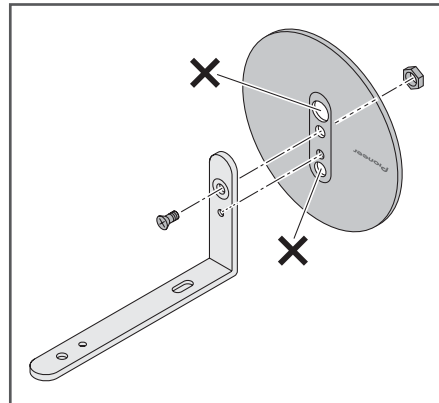

1. Align the vertical mounting stay with the hole in the base.
2. Fasten the vertical mount stay to the base using the vertical mount bolt and hex nut. Be sure the hex nut fits into the hexagonal groove in the bottom of the base.

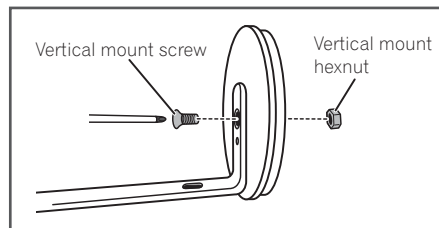



3. Affix the seal on the screw head.

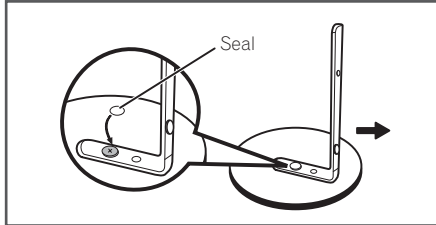

4. Align the speaker's rotation stop lug with the hole in the vertical stay.

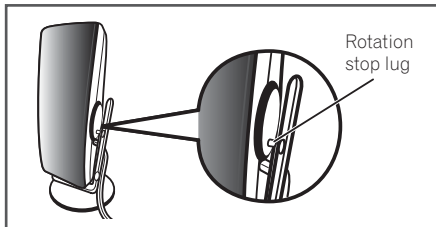

5. Fasten the speaker to the vertical stay, using the vertical mount screw.

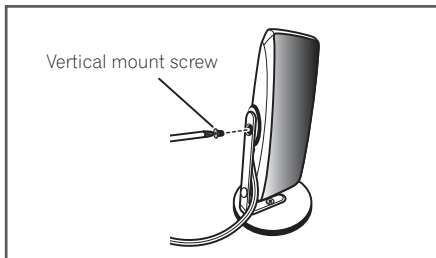

6. Connect the wires to the player.

Insert the cables connected to the player to the same colored connector on the speaker.

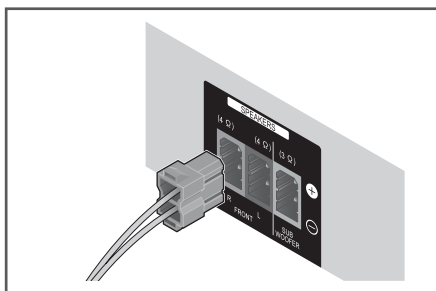

**Caution**

- Do not connect any speakers other than those supplied to this system.
- Do not connect the supplied speakers to any amplifier other than the one supplied with this system. Connection to any other amplifier may result in malfunction or fire.
- Please connect the speaker cable of subwoofer (purple) to orange of the player.
- These speaker terminals carry **HAZARDOUS LIVE voltage**. To prevent the risk of electric shock when connecting or disconnecting the speaker cables, disconnect the power cord before touching any uninsulated parts.

## Wall mounting the speakers for BCS-HF828

### Before mounting

- Remember that the speaker system is heavy and that its weight could cause the screws to work loose, or the wall material to fail to support it, resulting in the speaker falling. Make sure that the wall you intend to mount the speakers on is strong enough to support them. Do not mount on plywood or soft surface walls.
- Mounting screws are not supplied. Use screws suitable for the wall material and support the weight of the speaker.

### ⚠ Caution

- If you are unsure of the qualities and strength of the wall, consult a professional for advice.
- Pioneer is not responsible for any accidents or damage that result from improper installation.

- Use the vertical mounting screw to fasten the wall mounting fixture to the speaker system.

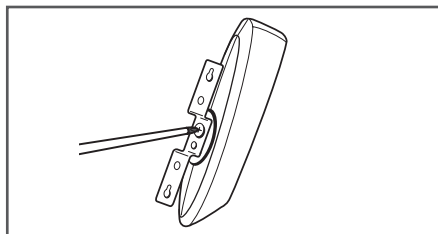

- Attach to wall.

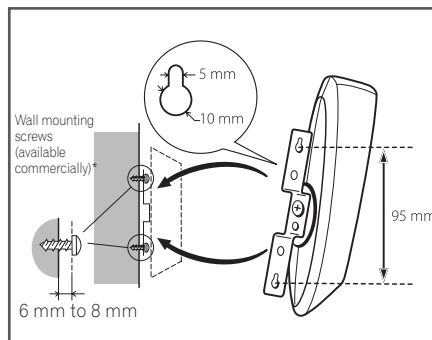

- \* Wall mounting screws are not included. Purchase appropriate screws taking into consideration the type of wall and the weight of the speaker system.

Open two holes in the wall 95 mm apart.

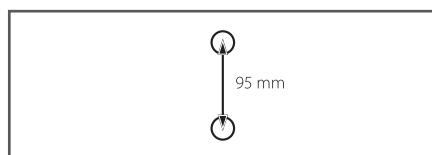

### When mounting the unit on speaker stand

Use the accessory bracket when mounting the unit on any speaker stand or base other than those provided.

Use M5 screws for installation. Mounting screws are not provided.

Follow the instructions accompanying your selected speaker stand or base.

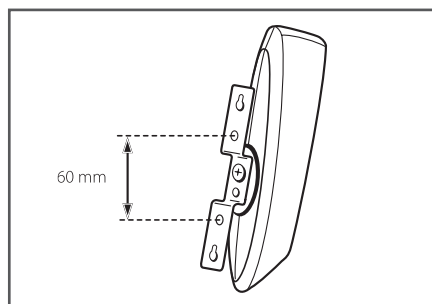

## Additional notes on speaker for BCS-HF828

Install the main front left and right speakers at equal distance from the TV.

### Precautions:

Make sure that all the bare speaker wire is twisted together and inserted fully into the speaker terminal. If any of the bare speaker wire touches the back panel it may cause the power to cut off as a safety measure.

The front speakers and subwoofer are not magnetically shielded and so should not be placed near a TV or monitor. Magnetic storage media (such as floppy discs and tape or video cassettes) should also not be kept close to the front speakers and subwoofer.

Do not attach the subwoofer to a wall or ceiling. They may fall off and cause injury.

## Positioning the system for BCS-HF828

The following illustration shows an example of positioning the system. Note that the illustrations in these instructions differ from the actual unit for explanation purposes. For the best possible surround sound, all the speakers other than the subwoofer should be placed at the same distance from the listening position (A).

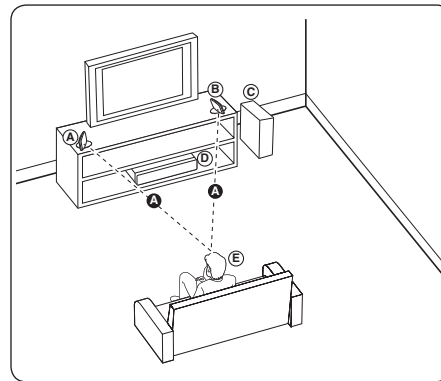

Ⓐ Front left speaker (L)/

Ⓑ Front right speaker (R):

Can be mounted vertically or horizontally.

Ⓒ Subwoofer:

The position of the subwoofer is not so critical, because low bass sounds are not highly directional. But it is better to place the subwoofer near the front speakers. Turn it slightly toward the center of the room to reduce the wall reflections.

Ⓓ Unit

Ⓔ Listening position

### ⚠ Caution

- Be careful to make sure children do not put their hands or any objects into the \*subwoofer duct.  
\*subwoofer duct: A hole for plentiful bass sound on subwoofer cabinet (enclosure).
- The speakers contain magnetic parts, so colour irregularity may occur on the TV screen (CRT) or PC monitor screen. Please use the speakers away from the TV screen (CRT) or PC monitor screen.

## Connecting to Your TV

Make one of the following connections, depending on the capabilities of your existing equipment.

- HDMI connection (page 42)
- Video connection (page 43)

### ! Note

- Depending on your TV and other equipment you wish to connect, there are various ways you could connect the player. Use only one of the connections described in this manual.
- Please refer to the manuals of your TV, stereo system or other devices as necessary to make the best connections.
- Make sure the player is connected directly to the TV. Tune the TV to the correct video input channel.
- Do not connect your player via your VCR. The image could be distorted by the copy protection system.

## HDMI connection

If you have a HDMI TV or monitor, you can connect it to this player using a HDMI cable (High Speed HDMI™ Cable). Connect the HDMI terminal on the player to the HDMI terminal on a HDMI compatible TV or monitor.

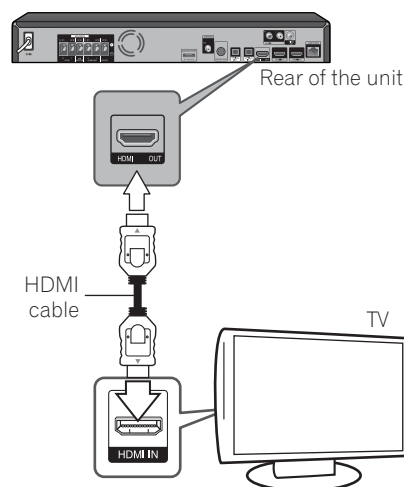

Set the TV's source to HDMI (refer to TV's Operating Instructions).

Connecting the player and the TV using the HDMI cable alone does not enable you to hear the audio from the device. Please also connect by either the optical cable (page 45) or the analog audio cable (page 44).

### When connected to a DVI device

- **It is not possible to connect DVI devices (computer displays, for example) that are not compatible with HDCP.** HDCP is a specification to protect audiovisual content across the DVI/HDMI interface.
- No audio signals are output. Connect using an audio cable, etc.
- This player is designed for connection with HDMI compatible devices. When connected to a DVI device, it may not operate properly depending on the DVI device.

## ARC (Audio Return Channel) function

The ARC function enables an HDMI capable TV to send the audio stream to HDMI OUT of this player.

To use this function:

- Your TV must support the ARC function.
- The setting method of ARC may differ depending on the TV. For details about ARC function, refer to your TV manual.
- You must use the HDMI cable (High Speed HDMI™ Cable).
- You must connect with the HDMI IN of TV that supports the ARC function using the HDMI OUT on this player.
- You can connect only one Home Theater to TV compatible with ARC.
- The ARC function does not warrant that the function works in all cases even if the above conditions are satisfied.
- When you use the ARC function, CEC (Consumer Electronics Control) may work. If you do not want to use CEC, you can stop it work by setting **[HDMI Control Off]** on Home Menu. In this case, it is needed to connect TV and this player by an optical cable to send the audio stream to this player. Power on the unit when using CEC function. CEC does not operate during Standby mode.

## Video connection

Connect the **VIDEO OUT** terminal on the player to the video in terminal on the TV using a video cable. You can hear the sound through the system's speakers.

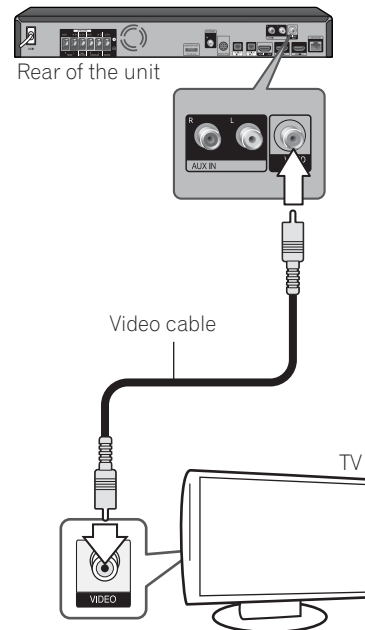

## Antenna connection

Connect the supplied antenna for listening to the radio.

2  
Connecting

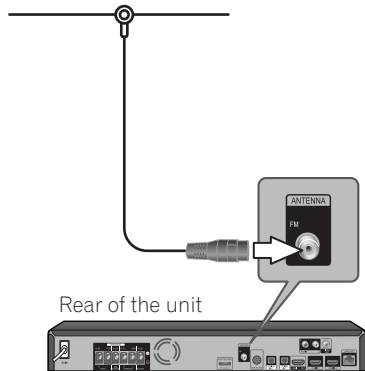

### ! Note

- After connecting the FM wire antenna, keep it as horizontal as possible. Be sure to fully extend the FM wire antenna.

## Connections with external device

### AUX connection

You can enjoy the sound from an external component through the speakers of this system.

Connect the analog audio output terminals of your component into the AUX L/R (INPUT) on this unit. And then select the **[AUX]** option by pressing **FUNCTION** and **ENTER**.

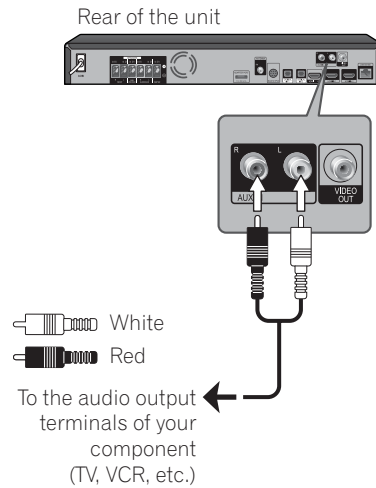

### PORTABLE IN connection

You can enjoy the sound from your portable audio player through the speakers of this system.

Connect the headphones (or line out ) terminal of the portable audio player into the PORTABLE socket of this unit. And then select the [Portable In] option by pressing **FUNCTION** and **ENTER**.

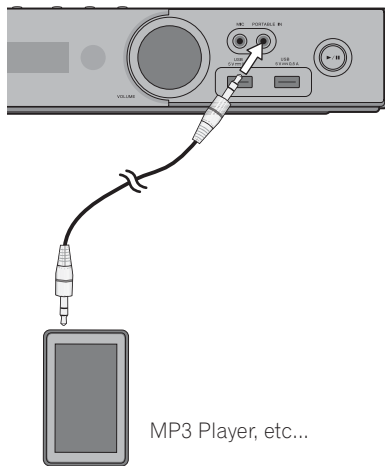

### OPTICAL IN 1/2 connection

You can enjoy the sound from your component with a digital optical connection through the speakers of this system.

Connect the optical output terminal of your component into the **OPTICAL IN 1** or **2** terminal on the unit. And then select the [Optical IN 1/2] option by pressing **FUNCTION** and **ENTER**.

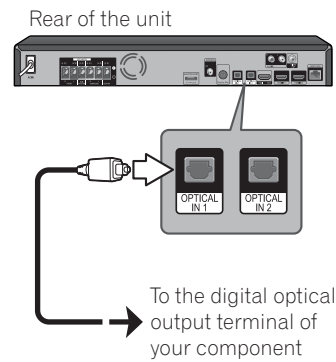

## HDMI IN 1/2 connection

You can enjoy the pictures and sound from your component through this connection. Connect the HDMI OUT terminal of your component into the **HDMI IN 1** or **2** terminal on this unit. And then select the **[HDMI IN 1/2]** option by pressing **FUNCTION** and **ENTER**.

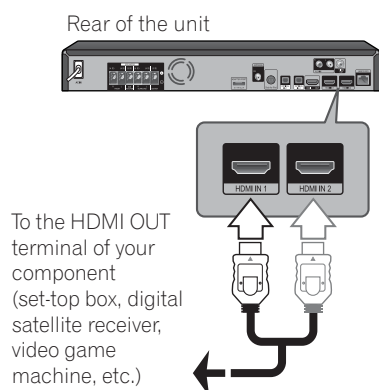

### ! Note

- You cannot change the video resolution in the HDMI IN 1/2 mode. Change the video resolution of the connected component.
- If the video output signal is abnormal when your personal computer is connected to HDMI IN 1/2 terminal, change the resolution of your personal computer to 576p, 720p, 1080i or 1080p.
- The video signal from the HDMI input cannot be output from the component or composite video outputs.

## Connecting optional Bluetooth® ADAPTER

When the *Bluetooth* ADAPTER (Pioneer Model No. AS-BT100 or AS-BT200) is connected to this unit, a product equipped with *Bluetooth* wireless technology (portable cell phone, digital music player, etc.) can be used to listen to music wirelessly.

Connect a *Bluetooth* ADAPTER to the ADAPTER PORT terminal on the rear panel.

\*For instructions on playing the *Bluetooth* wireless technology device, see Pairing the *Bluetooth* ADAPTER and *Bluetooth* wireless technology device on page 73.

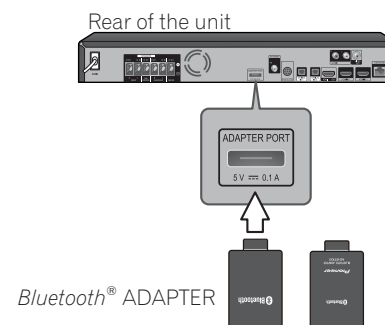

### ! Note

- Do not move the unit while the *Bluetooth* ADAPTER is connected. Doing so could cause damage or faulty contact.



## Connecting to your Home Network

This player can be connected to a local area network (LAN) via the LAN port on the rear panel or the internal wireless module. By connecting the unit to a broadband home network, you have access to services such as BD-LIVE interactivity and Online content services.

### Wired network connection

Using a wired network provides the best performance, because the attached devices connect directly to the network and are not subject to radio frequency interference.

Please refer to the documentation for your network device for further instructions.

Connect the player's LAN port to the corresponding port on your Modem or Router using a commercially available LAN or Ethernet cable.

#### **Note**

- When plugging or unplugging the LAN cable, hold the plug portion of the cable. When unplugging, do not pull on the LAN cable but unplug while pressing down on the lock.
- Do not connect a modular phone cable to the LAN port.
- Since there are various connection configurations, please follow the specifications of your telecommunication carrier or internet service provider.
- If you want to access content from PCs or DLNA servers, this player must be connected to the same local area network with them via a router.

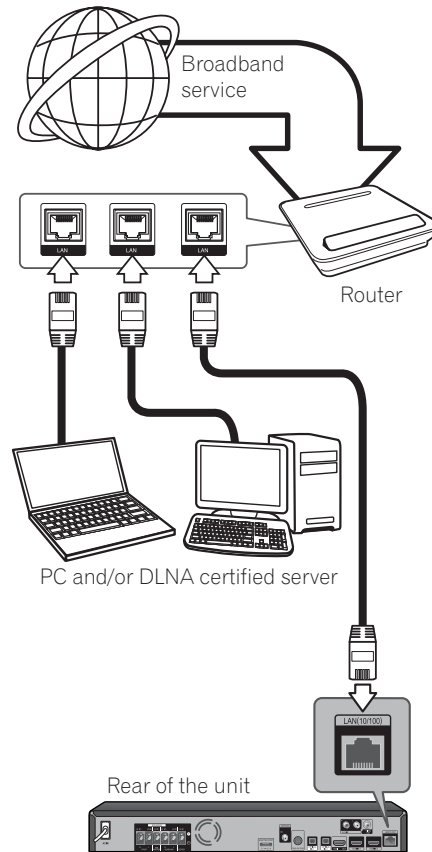

## Wireless network connection

Another connection option is to use an Access Point or a wireless router. The network configuration and connection method may vary depending on the equipment in use and the network environment.

This player is equipped with an IEEE 802.11n (Single band, 2.4 GHz band) wireless module, which also supports the 802.11b/g standards. For the best wireless performance, we recommend using a IEEE 802.11n certified Wi-Fi network (access point or wireless router).

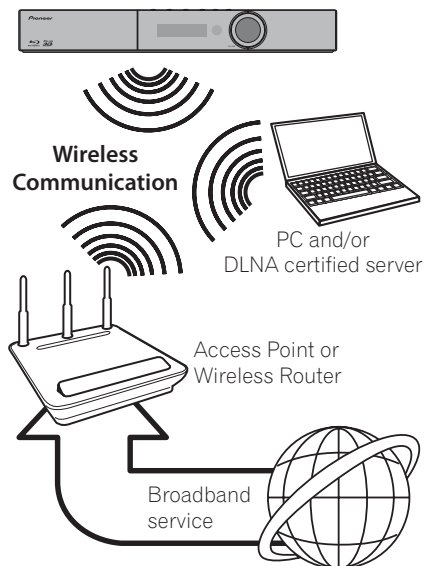

Refer to the setup instructions supplied with your access point or wireless router for detailed connection steps and network settings.

For best performance, a direct wired connection from this player to your home network's router or cable/DSL modem is always the best option. If you do choose to use the wireless option, note that performance can sometimes be affected by other electronic devices in the home.

## Wireless network setup

For the wireless network connection, the player needs to be set up for network communication. This adjustment can be done from the **[Setup]** menu. Adjust the **[NETWORK]** setting as follow. Setting up the access point or the wireless router is required before connecting the player to the network.

### Preparation

Before setting the wireless network, you need to:

- connect the broadband internet to the wireless home network.
  - set the access point or wireless router.
  - note the SSID and security code of the network.
1. Select **[Initial Setup]** → **[Network]** → **[Interface]** → **[Wireless]** and press **ENTER**.
  2. Select **[Initial Setup]** → **[Network]** → **[Wireless Setting]** → **[Next Screen]** and press **ENTER**.
  3. Select **[Yes]** and press **ENTER** to continue. The new connection settings reset the current network settings.
  4. **[Wireless Setting]** menu is displayed. Use **▲/▼** to select **[Scan]**. Then select **[Next]** using the **←/→** and press **ENTER**.
  5. The player scans the all available access points or wireless routers within range and display them as a list. Use **▲/▼** to select an access point or wireless router on the list, and then press **ENTER**.  
If you have security on your access point or wireless router, verify that the WEP or WPA key that was entered into the player matches the router's information exactly. You need to input the security code as necessary.
  6. Use the direction button, select the password, the button upon the Clear can change it to capital letter, lower case or symbol. Press the Enter end it. Select the Next button.
  7. If it connects success, it will display connection success and IP is obtained.

**Note**

- WEP security mode generally have 4 keys available on an access point or wireless router's setting. If your access point or wireless router use WEP security, enter the security code of the key "No.1" to connect on your home network.
- An Access Point is a device that allows you to connect to your home network wirelessly.

**[Scan]** – The player scans the all available access points or wireless routers within range and display them as a list.

**[Manual]** – Your access point may not be broadcasting its access point name (SSID). Check your router settings through your computer and either set your router to broadcast SSID, or manually enter the access point name (SSID) in **[Manual]**.

**[Auto]** – If your access point or wireless router that supports the Push Button Configuration method, select this option and press the Push Button on your access point or wireless router within 120 counts. You do not need to know the access point name (SSID) and security code of your access point or wireless router.

**Note**

- If there is no DHCP server on the network and you want to set the IP address manually, Please refer to "Setting the IP address". (Page 80)

## WPS setup (Wi-Fi Protected Setup)

### WPS connection setting

WPS is abbreviation of Wi-Fi Protected Setup. A standard established by the Wi-Fi Alliance industry group for a function allowing settings related to interconnection of WPS compatible wireless LAN devices and encryption to be made with simple operations.

This unit supports push-button configuration and PIN code configuration.

#### PBC (Push Button Configuration)

Connection settings are made automatically simply by pressing the WPS buttons on the WPS compatible wireless LAN device. This is the simplest way of making the settings, and is possible when the WPS compatible wireless LAN device is equipped with WPS button.

#### PIN Input

Connection settings are made by inputting the 8-digit PIN code shown on the main display to the access point to which you selected. Follow the instructions shown in Connecting using PIN code configuration on the right.

When performing wireless settings set **[Initial Setup]** → **[Network]** → **[Interface]** to **[Wireless]**.

**1. Press HOME MENU.**

The **HOME MENU** screen is displayed.

**2. Use cursor buttons to select [Initial Setup] and press ENTER.**

The **Initial Setup** screen is displayed.

**3. Select [Initial Setup] → [Network] → [Wireless Setting] → [Next Screen] and press ENTER.**

A confirmation screen is displayed.

**4. Use ←/→ to select Yes, then press ENTER.**

The **Wireless Setting** screen is displayed.

**5. Use ↑/↓ to select Auto, then press ENTER.**

The **WPS Setting** screen is displayed.

**6. Use ↑/↓ to switch between [=PBC] or [=PIN] screens.**

When connecting using PBC go to step 7.  
When connecting using PIN go to step 8.

**7. When connecting using PBC (Push Button), on the [=PBC] screen use ←/→ to select NEXT, then press ENTER.**

Then press the WPS button on the access point within 120 seconds.

**8. When connecting using PIN confirm the PIN Code on the [=PIN] screen. Use cursor ←/→ to select NEXT, then press ENTER.**

**9. Enter into the access point the PIN Code that you confirmed in step 8 above.**

The PIN Code input method differs depending on the LAN device used. For details, consult the operating instructions accompanying your LAN device.

**Notes on Network Connection:**

- Many network connection problems during set up can often be fixed by re-setting the router or modem. After connecting the player to the home network, quickly power off and/or disconnect the power cord of the home network router or cable modem. Then power on and/or connect the power cord again.
- Depending on the internet service provider (ISP), the number of devices that can receive internet service may be limited by the applicable terms of service. For details, contact your ISP.
- Our company is not responsible for any malfunction of the player and/or the internet connection feature due to communication errors/malfunctions associated with your broadband internet connection, or other connected equipment.
- The features of BD-ROM discs made available through the Internet Connection feature are not created or provided by our company, and our company is not responsible for their functionality or continued availability. Some disc related material available by the Internet Connection may not be compatible with this player. If you have questions about such content, please contact the producer of the disc.
- Some internet contents may require a higher bandwidth connection.
- Even if the player is properly connected and configured, some internet contents may not operate properly because of internet congestion, the quality or bandwidth of your internet service, or problems at the provider of the content.
- Some internet connection operations may not be possible due to certain restrictions set by the Internet service provider (ISP) supplying your broadband Internet connection.
- Any fees charged by an ISP including, without limitation, connection charges are your responsibility.
- A 10 Base-T or 100 Base-TX LAN port is required for wired connection to this player. If your internet service does not allow for such a connection, you will not be able to connect the player.
- You must use a Router to use xDSL service.

- ADSL modem is required to use DSL service and a cable modem is required to use cable modem service. Depending on the access method of and subscriber agreement with your ISP, you may not be able to use the internet connection feature contained in this player or you may be limited to the number of devices you can connect at the same time. (If your ISP limits subscription to one device, this player may not be allowed to connect when a PC is already connected.)
- The use of a "Router" may not be allowed or its usage may be limited depending on the policies and restrictions of your ISP. For details, contact your ISP directly.
- The wireless network operate at 2.4 GHz radio frequencies that are also used by other household devices such as cordless telephone, *Bluetooth*<sup>®</sup> devices, microwave oven, and can be affected by interference from them.
- Turn off all unused network equipment in your local home network. Some devices may generate network traffic.
- For the purpose of the better transmission, placing the player from the access point as close as possible.
- In some instances, placing the access point or wireless router at least 0.45 m above the floor may improve the reception.
- Move closer to the access point if possible or re-orient the player so there is nothing between it and the access point.
- The reception quality over wireless depends on many factors such as type of the access point, distance between the player and access point, and the location of the player.
- Set your access point or wireless router to Infrastructure mode. Ad-hoc mode is not supported.

## USB device connection

This player can play movie, music and photo files contained in the USB device.

1. Insert a USB device to the USB port until it fits into place.

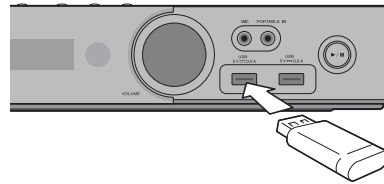

### ! Note

- This player supports USB device/external HDD formatted in FAT16, FAT32 and NTFS when accessing files (music, photo, movie). However, for BD-LIVE and Audio CD recording, only FAT16 and FAT32 formats are supported. Use the USB device/external HDD formatted in either FAT16 or FAT32 when using BD-LIVE and Audio CD recording.
- The USB device can be used for the local storage for enjoying BD-LIVE discs with Internet.
- This unit can support up to 8 partitions of the USB device.
- Do not extract the USB device during operation (play, etc.).
- A USB device which requires additional program installation when you have connected it to a computer, is not supported.
- USB device: USB device that supports USB1.1 and USB2.0.
- Movie, music and photo files can be played. For details of operations on each file, refer to relevant pages.
- Regular back up is recommended to prevent data loss.
- If you use a USB extension cable, USB HUB or USB Multi-reader, the USB device may not be recognized.
- Some USB device may not work with this unit.
- Digital camera and mobile phone are not supported.
- USB Port of the unit cannot be connected to PC. The unit cannot be used as a storage device.
- If more than one USB device is connected, the number displayed for the USB device may change depending on the type of device connected or circumstance. To confirm USB device number, go to [HOME MENU] → [Home Media Gallery].

## Chapter 3 Getting Started

### Making settings using the Setup Navigator menu

Be sure to perform these settings when using the player in the following situations.

- When you use the player for the first time.
- After **Initial Setup** format.
- After updating the player's software.

#### ⚠ Caution

- Before turning on the power, check that the connections between the player and other devices are correct. Also, turn on the power of the devices connected to the player before turning on the player's power.
- When using a Pioneer Flat Screen TV or front projector compatible with the Control function, set Control to On on the connected device before turning on the player's power.

#### ! Note

- When a Pioneer Flat Screen TV or front projector compatible with the Control function is connected to the player using an HDMI cable, the player is automatically set to the optimum picture quality for the connected device.

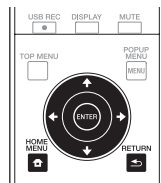

#### 1. Turn on the TV's power and switch the input.

See the TV's operating instructions for the details of operating the TV.

#### 2. Turn on the player's power.

Press **STANDBY/ON**.

Check that the Setup Navigator menu is displayed.

#### ❖ If the Setup Navigator menu is not displayed

- ▶ Press **HOME MENU** to display the Home Menu, select Initial Setup → Setup Navigator → Start, then press **ENTER**.

#### 3. Start Setup Navigator.

Press **ENTER**.

- Setup Navigator starts.

#### 4. Select the OSD language.

Use **▲/▼** to select, then press **ENTER**.

When a Pioneer Flat Screen TV that is compatible with Control function is connected to this player's **HDMI OUT** terminal, language settings are imported from the Pioneer Flat Screen TV's language settings before **Setup Navigator** begins.

#### 5. Select the appropriate output resolution for the connected TV.

Use **▲/▼** to select, then press **ENTER**.

#### 6. Select the appropriate aspect for the connected TV.

Use **▲/▼** to select, then press **ENTER**.

#### 7. Close the Setup Navigator menu.

Press **ENTER**.

- Setup Navigator finishes and the setting is stored.
- Press **RETURN** to go back to the previous screen.

## Operating the TV with the player's remote control

When the manufacturer code for your brand of TV is set on the player's remote control, the TV can be operated using the player's remote control.

### ⚠ Caution

- For some models it may not be possible to operate the TV with the player's remote control, even for TVs of brands listed on the manufacturer code list.
- The setting may be restored to the default after the batteries are replaced. If this happens, reset it.

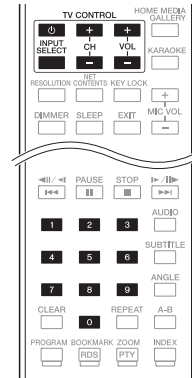

### 1. Input the 2-digit manufacturer code.

Press the number buttons (0 to 9) to input the code while pressing **TV CONTROL** .

#### ! Note

- The factory default setting is 00 (PIONEER).
- If you make a mistake when inputting the code, release **TV CONTROL**  then start over from the beginning.
- When there are multiple codes for a manufacturer, try inputting them in the indicated order until the TV can be operated.

### 2. Check that the TV can be operated.

Operate the TV using **TV CONTROL**.

 – Press to turn the TV's power on and off.

**INPUT SELECT** – Press to switch the TV's input.

**CH +/-** – Press to select the TV channel.

**VOL +/-** – Press to adjust the volume.

## TV preset code list

### Manufacturer Code(s)

<b>PIONEER</b> 00, 31, 32, 07, 36, 42, 51, 22	<b>FRONTECH</b> 31, 42, 46	<b>MAGNAVOX</b> 07, 10, 03, 12, 29	<b>SALORA</b> 31, 32, 42, 43
<b>ACURA</b> 44	<b>FRONTECH/PROTECH</b> 32	<b>MANESTH</b> 39, 46	<b>SAMBERS</b> 49
<b>ADMIRAL</b> 31	<b>FUJITSU</b> 48	<b>MARANTZ</b> 07	<b>SAMSUNG</b> 07, 38, 44, 46, 69, 70
<b>AIWA</b> 60	<b>FUNAI</b> 40, 46, 58	<b>MARK</b> 07	<b>SANYO</b> 35, 45, 48, 21, 14, 91
<b>AKAI</b> 32, 35, 42	<b>GBC</b> 32, 42	<b>MATSUI</b> 07, 39, 40, 42, 44, 47, 48	<b>SBR</b> 07, 34
<b>AKURA</b> 41	<b>GE</b> 00, 01, 08, 07, 10, 11, 17, 02, 28, 18	<b>MCMICHAEL</b> 34	<b>SCHAUB LORENZ</b> 42
<b>ALBA</b> 07, 39, 41, 44	<b>GEC</b> 07, 34, 48	<b>MEDIATOR</b> 07	<b>SCHNEIDER</b> 07, 41, 47
<b>AMSTRAD</b> 42, 44, 47	<b>GELOSO</b> 32, 44	<b>MEMOREX</b> 44	<b>SEG</b> 42, 46
<b>ANITECH</b> 44	<b>GENERAL</b> 29	<b>METZ</b> 31	<b>SEI</b> 32, 40, 49
<b>ASA</b> 45	<b>GENEXXA</b> 31, 41	<b>MINERVA</b> 31, 53	<b>SELECO</b> 31, 42
<b>ASUKA</b> 41	<b>GOLDSTAR</b> 10, 23, 21, 02, 07, 50	<b>MITSUBISHI</b> 09, 10, 02, 21, 31	<b>SHARP</b> 02, 19, 27, 67, 90
<b>AUDIOGONIC</b> 07, 36	<b>GOODMANS</b> 07, 39, 47, 48, 56	<b>MULTITECH</b> 44, 49	<b>SIAREM</b> 32, 49
<b>BASIC LINE</b> 41, 44	<b>GORENJE</b> 38	<b>NEC</b> 59	<b>SIEMENS</b> 31
<b>BAUR</b> 31, 07, 42	<b>GPM</b> 41	<b>NECKERMANN</b> 31, 07	<b>SINUDYNE</b> 32, 39, 40, 49
<b>BEKO</b> 38	<b>GRAETZ</b> 31, 42	<b>NEI</b> 07, 42	<b>SKANTIC</b> 43
<b>BEON</b> 07	<b>GRANADA</b> 07, 35, 42, 43, 48	<b>NIKKAI</b> 05, 07, 41, 46, 48	<b>SOLAVOX</b> 31
<b>BLAUPUNKT</b> 31	<b>GRADIENTE</b> 30, 57	<b>NOBLIKO</b> 49	<b>SONOKO</b> 07, 44
<b>BLUE SKY</b> 41	<b>GRANDIN</b> 18	<b>NOKIA</b> 32, 42, 52	<b>SONOLOR</b> 31, 35
<b>BLUE STAR</b> 18	<b>GRUNDIG</b> 31, 53	<b>NORDMENDE</b> 32, 36, 51, 52	<b>SONTEC</b> 07
<b>BPL</b> 18	<b>HANSEATIC</b> 07, 42	<b>OCEANIC</b> 31, 32, 42	<b>SONY</b> 04
<b>BRANDT</b> 36	<b>HCM</b> 18, 44	<b>ORION</b> 32, 07, 39, 40	<b>SOUNDWAVE</b> 07
<b>BTC</b> 41	<b>HINARI</b> 07, 41, 44	<b>OSAKI</b> 41, 46, 48	<b>STANDARD</b> 41, 44
<b>BUSH</b> 07, 41, 42, 44, 47, 56	<b>HISAWA</b> 18	<b>OSO</b> 41	<b>STERN</b> 31
<b>CASCADE</b> 44	<b>HITACHI</b> 31, 33, 34, 36, 42, 43, 54, 06, 10, 24, 25, 18	<b>OSUME</b> 48	<b>SUSUMU</b> 41
<b>CATHAY</b> 07	<b>HUANYU</b> 56	<b>OTTO VERSAND</b> 31, 32, 07, 42	<b>SYSLINE</b> 07
<b>CENTURION</b> 07	<b>HYPSON</b> 07, 18, 46	<b>PALLADIUM</b> 38	<b>TANDY</b> 31, 41, 48
<b>CGB</b> 42	<b>ICE</b> 46, 47	<b>PANAMA</b> 46	<b>TASHIKO</b> 34
<b>CIMLINE</b> 44	<b>IMPERIAL</b> 38, 42	<b>PANASONIC</b> 31, 07, 08, 42, 22	<b>TATUNG</b> 07, 48
<b>CLARIVOX</b> 07	<b>INDIANA</b> 07	<b>PATHO CINEMA</b> 42	<b>TEC</b> 42
<b>CLATRONIC</b> 38	<b>INGELEN</b> 31	<b>PAUSA</b> 44	<b>TELEAVIA</b> 36
<b>CONDOR</b> 38	<b>INTERFUNK</b> 31, 32, 07, 42	<b>PHILCO</b> 32, 42	<b>TELEFUNKEN</b> 36, 37, 52
<b>CONTEC</b> 44	<b>INTERVISION</b> 46, 49	<b>PHILIPS</b> 31, 07, 34, 56, 68	<b>TELETECH</b> 44
<b>CROSLEY</b> 32	<b>ISUKAI</b> 41	<b>PHOENIX</b> 32	<b>TENSAI</b> 40, 41
<b>CROWN</b> 38, 44	<b>ITC</b> 42	<b>PHONOLA</b> 07	<b>THOMSON</b> 36, 51, 52, 63
<b>CRYSTAL</b> 42	<b>ITT</b> 31, 32, 42	<b>PROFEX</b> 42, 44	<b>THORN</b> 31, 07, 42, 45, 48
<b>CYBERTRON</b> 41	<b>JEC</b> 05	<b>PROTECH</b> 07, 42, 44, 46, 49	<b>TOMASHI</b> 18
<b>DAEWOO</b> 07, 44, 56	<b>JVC</b> 13, 23	<b>QUELLE</b> 31, 32, 07, 42, 45, 53	<b>TOSHIBA</b> 05, 02, 26, 21, 53
<b>DAINICHI</b> 41	<b>KAISUI</b> 18, 41, 44	<b>R-LINE</b> 07	<b>TOWADA</b> 42
<b>DANSAI</b> 07	<b>KAPSCH</b> 31	<b>RADIO SHACK</b> 10, 23, 21, 02	<b>ULTRAVOX</b> 32, 42, 49
<b>DAYTON</b> 44	<b>KENDO</b> 42	<b>RBM</b> 53	<b>UNIDEN</b> 92
<b>DECCA</b> 07, 48	<b>KENNEDY</b> 32, 42	<b>RCA</b> 01, 10, 15, 16, 17, 18, 61, 62, 09	<b>UNIVERSUM</b> 31, 07, 38, 42, 45, 46, 54
<b>DIXI</b> 07, 44	<b>KORPEL</b> 07	<b>REDIFFUSION</b> 32, 42	<b>VESTEL</b> 07
<b>DUMONT</b> 53	<b>KOYODA</b> 44	<b>REX</b> 31, 46	<b>VICTOR</b> 13
<b>ELIN</b> 07	<b>LEYCO</b> 07, 40, 46, 48	<b>ROADSTAR</b> 41, 44, 46	<b>VOXSON</b> 31
<b>ELITE</b> 41	<b>LIESENK&amp;TTER</b> 07	<b>SABA</b> 31, 36, 42, 51	<b>WALTHAM</b> 43
<b>ELTA</b> 44	<b>LOEWE</b> 07	<b>SAISHO</b> 39, 44, 46	<b>WATSON</b> 07
<b>EMERSON</b> 42	<b>LUXOR</b> 32, 42, 43		<b>WATT RADIO</b> 32, 42, 49
<b>ERRES</b> 07	<b>M-ELECTRONIC</b> 31, 44, 45, 54, 56, 07, 36, 51		<b>WHITE WESTINGHOUSE</b> 07
<b>FERGUSON</b> 07, 36, 51	<b>MAGNADYNE</b> 32, 49		<b>YOKO</b> 07, 42, 46
<b>FINLANDIA</b> 35, 43, 54	<b>MAGNAFON</b> 49		<b>ZENITH</b> 03, 20
<b>FINLUX</b> 32, 07, 45, 48, 53, 54			
<b>FIRSTLINE</b> 40, 44			
<b>FISHER</b> 32, 35, 38, 45			
<b>FORMENTI</b> 32, 07, 42			



## Chapter 4 Playback

### Playing discs or files

This section describes the player's main operations.

For the types of discs and files that can be played, see page 11. Video, image and audio files recorded on discs are played with the Home Media Gallery (page 64).

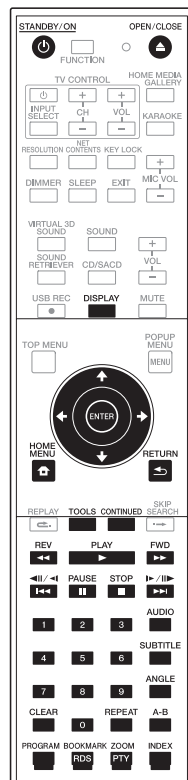

1. Press **STANDBY/ON** to turn on the power.  
Turn the TV's power on and switch its input beforehand.
2. Press **OPEN/CLOSE** to open the disc tray and load the disc.

#### ! Note

- Load the disc with the printed side facing up.
- Several dozen seconds are required to read the disc. Once reading is completed, the type of disc is displayed on the player's front panel display.
- When a BD with usage restrictions set by a BD recorder is loaded, the PIN code input screen appears. In this case, input your PIN code.

#### 3. Press **▶ PLAY** to play the disc.

- To pause, press **II PAUSE** during playback.
- To stop, press **■ STOP** during playback.

#### ! Note

- Some discs start playing automatically when the disc tray is closed.
- DVD-Video discs have parental lock features. Input the password registered in the player's settings to unlock the parental lock. For details, see page 82.

#### ❖ If the disc menu is displayed

For some discs, the disc menu is displayed automatically when playback starts. The contents of the disc menu and the way to operate depend on the disc.

#### ❖ Resuming playback from where it was stopped (resume playback function)

- When **■ STOP** is pressed during playback, the point at which the disc stopped is stored in the memory. When **▶ PLAY** is pressed after that, playback resumes from that point.
- To cancel the resume playback function, press **■ STOP** while playback is stopped.

#### ! Note

- The resume playback function is canceled automatically in the following cases:
  - When the disc tray is opened.
  - When the file list window is switched.
  - When the power is turned off. (For BDs and DVDs this does not cancel the resume playback function.)
- When you want to continue playback from a position you specify to be played next time, see Continuing playback from a specified position (Continued Viewing Playback) on page 63.
- The resume playback function cannot be used for some discs.

## Forward and reverse scanning

- ▶ **During playback, press ◀◀REV or ▶▶FWD.**
  - The scanning speed switches each time the button is pressed. The speed steps depend on the disc or file (the speed is displayed on the TV screen).
- ❖ **To resume normal playback**
- ▶ **Press ▶ PLAY.**

## Playing specific chapters, tracks or files

- ▶ **During playback, input the number of the chapter/track/file you want to select.**
  - Use the number buttons (0 to 9) to input the number, then press **ENTER**.
  - Press **CLEAR** to clear the values you have input.

## Skipping content

- ▶ **During playback, press I◀◀ or ▶▶I.**
  - When ▶▶I is pressed, the playback skips ahead to the beginning of the next chapter/track/file.
  - When I◀◀ is pressed while a video or audio file is playing, the playback skips back to the beginning of the currently playing chapter/track/file. Press twice to skip back to the beginning of the previous chapter/track/file.
  - When I◀◀ is pressed while an image file is playing, playback returns to the previous file.

## Playing in slow motion

- ▶ **While playback is paused, press and hold ◀II/◀I or I▶/I▶.**
  - The speed switches each time the button is pressed (the speed is displayed on the TV screen).
- ❖ **To resume normal playback**
- ▶ **Press ▶ PLAY.**

## Step forward and step reverse

- ▶ **While playback is paused, press ◀II/◀I or I▶/I▶.**
  - The picture moves a step forward or reverse each time the button is pressed.
- ❖ **To resume normal playback**
- ▶ **Press ▶ PLAY.**

## Playing a specific section within a title or track repeatedly (A-B Repeat)

Use this procedure to play a specific section within a title or track repeatedly.

- 1 During playback, press A-B to select the starting point.**
  - A- is displayed on the TV screen.
- 2. During playback, press A-B to select the ending point.**
  - A-B Repeat playback starts.

### ❖ To cancel A-B Repeat play

- Press **A-B** during the A-B Repeat play.

### ! Note

- A-B Repeat play is canceled in the following cases:
  - When you search outside of the repeat range.
  - When you start other Repeat Play or Random Play.

## Playing repeatedly (Repeat Play)

Use this procedure to play the currently playing disc, title, chapter, track or file repeatedly.

- ▶ **During playback, press REPEAT.**
  - Each time you press **REPEAT** the type of repeat modes changes as shown below.
    - BD**  
Current chapter → Current title
    - DVD**  
Current chapter → Current title → All titles
    - CD/Video file/Audio file/Image file**  
Current track/file → All tracks/All files in folder

❖ **To cancel Repeat Play**

- Press **REPEAT** several times during Repeat Play.

! **Note**

- Repeat Play is canceled in the following cases:
  - When you search outside the repeat range.
  - When you start other Repeat Play or Random Play.

**Playing in the desired order (Programmed Play)****1 During playback, press PROGRAM.**

- The program screen is displayed.

**2. Select the program number.**

Use  $\uparrow/\downarrow$  to select, then press **ENTER**.

**3. Select the title you want to play.**

Use  $\uparrow/\downarrow$  to select, then press  $\rightarrow$ .

**4. Select the chapter you want to play.**

Use  $\uparrow/\downarrow$  to select, then press **ENTER**.

**5. Press  $\blacktriangleright$  PLAY.**

- Playback starts.

❖ **Editing the program****1. Select the program number you want to edit, then press ENTER.****2. Select title/chapter, then press ENTER.**❖ **Deleting the program****▶ Select the program number you want to delete, then press CLEAR.**

- To delete all the programs, press  $\leftarrow$  **RETURN**.

! **Note**

- When you use audio CDs for Programmed Play, enter the track number in step 3.
- This function does not work with BDs.

**Making bookmarks**

You can make bookmarks on the video currently playing and play back the scene later.

**▶ During playback, press BOOKMARK.**

- The bookmark is made.
- Maximum number of bookmarks are 12.

❖ **Playing the bookmarked scene****1. Press and hold BOOKMARK for a few seconds.**

- The list of bookmarks is displayed.

**2. Select the bookmark you want to play.**

Use  $\leftarrow/\rightarrow$  to select, then press **ENTER**.

❖ **Deleting the bookmark****▶ Select the bookmark you want to delete, then press CLEAR.**

- Bookmarks may not be allowed to make for some discs.
- Bookmarks are canceled in the following cases:
  - When the player's power turned off.
  - When the disc tray is opened.

**Zoom****▶ During playback, press ZOOM.**

- Each time you press **ZOOM**, the zoom level changes as shown below.

Zoom 2x  $\rightarrow$  Zoom 3x  $\rightarrow$  Zoom 4x  $\rightarrow$   
Zoom 1/2  $\rightarrow$  Zoom 1/3  $\rightarrow$  Zoom 1/4  $\rightarrow$   
Normal (not displayed)

! **Note**

- This function does not work with some discs.

## Playing photos as slideshows

This function plays the photos, switching them automatically.

- ▶ **During playback, press INDEX.**
  - Display the thumbnail of image files. The maximum number is 12 at once.
  - If you select one of the image and press **ENTER**, slideshow will start from the image you selected.

### ❖ Rotating/inverting photos

When a slideshow is playing or paused, the display switches as shown below when the **↕/↔/↔** buttons are pressed.

- ▶ button: Rotates 90° clockwise
- ◀ button: Rotates 90° counterclockwise
- ↔ button: Flips horizontally
- ↕ button: Flips vertically

## Switching the camera angles

For BD-ROM and DVD-Video discs on which multiple angles are recorded, the angles can be switched during playback.

- ▶ **During playback, press ANGLE.**
  - The current angle and total number of recorded angles are displayed on the TV screen. To switch the angles, press **ANGLE** again.
  - The angles can also be switched by selecting **Angle** from the **TOOLS** menu.
  - If the angles are not switched when **ANGLE** is pressed, switch them from the disc menu screen.

## Switching the subtitles

For discs or files on which multiple subtitles are recorded, the subtitles can be switched during playback.

### ⚠ Caution

- The subtitles cannot be switched for discs recorded by a DVD or BD recorder. Also refer to the operating instructions for the device used for recording.

### ▶ During playback, press SUBTITLE.

- The current subtitle and total number of recorded subtitles are displayed on the TV screen. To switch the subtitle, press **SUBTITLE** again.
- The subtitles can also be switched by selecting **Subtitle** from the **TOOLS** menu.
- If the subtitles are not switched when **SUBTITLE** is pressed, switch them from the disc menu screen.

### ❖ Turning the subtitles off

- ▶ **Press SUBTITLE several times or select Subtitle from the TOOLS menu to switch the setting to Off.**

### ❖ About displaying external subtitle files while playing DivX media files

In addition to the subtitles recorded in DivX media files, this player also supports the display of external subtitle files. If a file has the same name as that of a DivX media file aside from the file extension and the extension is one of the extensions listed below, the file is treated as an external subtitle file. Note that DivX media files and external subtitle files must be located in the same folder.

Only one external subtitle file can be displayed on this player. Use a computer, etc., to delete any external subtitle files you do not want to display from the disc.

### ⚠ Note

- Depending on the file, the external subtitles may not be displayed properly.

## Switching the audio

For discs or files on which multiple audio streams/channels are recorded, audio streams/channels can be switched during playback.

▶ **During playback, press AUDIO.**

- The current audio and total number of recorded audio streams are displayed on the TV screen. To switch the audio, press **AUDIO** again.
- The audio can also be switched by selecting **Audio** from the **TOOLS** menu.
- If the audio is not switched when **AUDIO** is pressed, switch it from the disc menu screen.

## Switching the CD/SACD playback area

**1. Select the area you want to play.**

In the stop mode, press **CD/SACD**. The playback area switches on the front panel display window each time the button is pressed.

[CD AREA] → [SACD 2CH] → [SACD MCH]  
→ (back to beginning)

- During playback, press **■** twice to cancel continuous play before selecting the playback area.

**2. Open the disc tray.**

Press the **▲ OPEN/CLOSE** button.

**3 Close the disc tray.**

Press the **▲ OPEN/CLOSE** button. Once the disc is loaded, the playback area switches.

## Displaying the disc information

▶ **Press DISPLAY.**

The disc information appears on the TV screen. To switch off the information display, press **DISPLAY** again.

The information display differs between during playback and when playback is stopped.

## Enjoying BONUSVIEW or BD-LIVE

This player is compatible with BD-Video BONUSVIEW and BD-LIVE.

When using BD-Video discs compatible with BONUSVIEW, you can enjoy such functions as secondary video (picture in picture) (page 62) and secondary audio (page 62). With BD-Video discs supporting BD-LIVE, special video images and other data can be downloaded from the Internet.

Data recorded on BD video and downloaded from BD-LIVE is stored on the USB flash drive (external memory). To enjoy these functions, connect a USB flash drive (minimum 1 GB capacity, 2 GB or greater recommended) supporting USB 2.0 High Speed (480 Mbit/s) to the USB port.

4

Playback

- When you insert or remove a USB flash drive, be sure to turn the player's power off.
- To recall data stored in the USB flash drive, first insert the disc media that was being used at the time the data was downloaded (if a different disc is loaded, the data stored on the USB flash drive cannot be played).
- If a USB flash drive containing other data (previously recorded) is used, the video and audio may not play back properly.
- Do not disconnect the USB flash drive while playback is in progress.
- Some time may be required for the data to load (read/write).

### Caution

- It may not be possible to use the BONUSVIEW and BD-LIVE functions if there is insufficient space on the USB flash drive. In this case, refer to Erasing data that has been added to BDs and application data on page 81 for erasing the Virtual Package data and the BD-LIVE data in the USB flash drive.

### Note

- Operation of USB flash drives is not guaranteed.
- Playback of BD-LIVE function data differs depending on the disc used. For details, consult the user instructions supplied with the disc.
- To enjoy the BD-LIVE function, a network connection and settings are required (pages 47 and 80).
- BD-LIVE is a function that provides for connection to the Internet. Discs supporting the BD-LIVE function may send ID codes identifying this player and the disc to the contents provider via the Internet.

## Playback functions

The functions that can be used differ according to the type of disc and file. In some cases, some of the functions cannot be used. Check the usable functions on the table below.

Function <sup>1</sup>	Disc/file type									
	BD-ROM	BD-R /-RE	DVD-Video	DVD-R /-RW (VR format)	AVCREC	AVCHD	Video file	Image file	Audio file	Audio CD
Forward and reverse scanning <sup>2</sup>	✓ <sup>3</sup>	✓ <sup>3</sup>	✓ <sup>3</sup>	✓ <sup>3</sup>	✓ <sup>3</sup>	✓ <sup>3</sup>	✓ <sup>3</sup>	✗	✓ <sup>4</sup>	✓ <sup>4</sup>
Playing specific titles, chapters or tracks	✓	✓	✓	✓	✓	✓	✗	✗	✗	✓
Skipping content	✓	✓	✓	✓	✓	✓	✓ <sup>6</sup>	✓	✓	✓
Slow motion play <sup>2,5</sup>	✓	✓	✓	✓	✓	✓	✓ <sup>7</sup>	✓	✗	✗
Step forward and step reverse <sup>2</sup>	✓	✓	✓	✓	✓	✓	✓	✓	✗	✗
A-B Repeat play <sup>2</sup>	✓	✓	✓	✓	✓	✓	✓	✓	✓	✓
Repeat Play	✓	✓	✓	✓	✓	✓	✓	✓	✓	✓
Zoom	✓	✓	✓	✓	✓	✓	✓	✓	✗	✗
Angle <sup>8</sup>	✓	✗	✓	✗	✗	✗	✗	✗	✗	✗
Subtitle <sup>9</sup>	✓	✓	✓	✓	✓	✓	✓	✗	✗	✗
Audio <sup>10</sup>	✓	✓	✓	✓	✓	✓	✓	✗	✗	✗
Disc information	✓	✓	✓	✓	✓	✓	✓	✓	✓	✓

1. Some functions may not work for some discs or files, even if indicated [✓] on the table.
2. For some discs, normal playback resumes automatically when the chapter switches.
3. No sound is produced during forward and reverse scanning.
4. Sound is produced during forward and reverse scanning.
5.
  - No sound is output during slow motion playback.
  - It is not possible to switch the speed during reverse slow motion playback.
6. Reverse slow motion playback is not possible.
7. Reverse step playback is not possible.
8. Angle mark is displayed for scenes at which multiple angles are recorded if **Angle Mark** is set to **On** (page 78).
9.
  - The types of recorded subtitles depend on the disc and file.
  - In some cases, the subtitle may switch or the switching screen provided on the disc may be displayed immediately, without the current subtitle or the total number of subtitles recorded on the disc being displayed.
10. The types of recorded audio streams depend on the disc and file.

## Using the TOOLS menu

Various functions can be called out according to the player's operating status.

### 1. Display the TOOLS menu.

Press **TOOLS** during playback.

### 2. Select and set the item.

Use **▲/▼** to select, then press **ENTER**.

#### ! Note

- Items that cannot be changed are displayed in gray. The items that can be selected depend on the player's status.

#### ❖ To change the setting of the selected item

Use **▲/▼** to change.

#### ❖ To close the TOOLS menu

Press **TOOLS**.

#### ❖ TOOLS menu item list

Item	Description
Title	Display the title information for the currently playing disc and total number of titles on the disc. Also select the title you want to play. (See the following description.)
Chapter (track/file) <sup>1</sup>	Display the information for the currently playing chapter (track/file) and total number of chapters in the disc. Also select the chapter (track/file) you want to play. (See the following description.)
Time	Display the elapsed or remaining time. Also enter the time from which you want to start playback. (See the following description.)
Mode	Switch the play mode (page 63).
Audio	Switch the audio.
Angle	Switch the BD-ROM/DVD-Video disc's camera angle.
Subtitle	Switch the subtitle language.
Code Page	Switch the subtitle code page.
Second Video <sup>2</sup>	Switch the BD-ROM's secondary video (Picture-in-Picture).
Second Audio <sup>3</sup>	Switch the BD-ROM's secondary audio.
Bitrate	Display the bitrate of the audio/video/secondary video/secondary audio.
Still off	Switch off the BD-ROM's still picture.

Item	Description
Ins Search	Skip forward 30 seconds.
Ins Replay	Skip backward 10 seconds.
Slide Show	Switch the playback speed while playing the picture slide show.
Transition	Change the style of the slide show while playing the picture slide show.

- One of these types of information is displayed, depending on the type of disc.
- Secondary video mark is displayed for scenes at which secondary video is recorded if **PIP Mark** is set to **On** (page 78).
- Secondary audio mark is displayed for scenes at which secondary audio is recorded if **Secondary Audio Mark** is set to **On** (page 78).

#### ! Note

- Selectable items depend on the type of disc.
- The types of recorded secondary audio streams depend on the disc and file.
- Some discs do not include secondary audio/secondary video.
- In some cases, the secondary audio/secondary video may switch or the switching screen provided on the disc may be displayed immediately, without the current secondary audio/secondary video or the total number of secondary audio/secondary video streams recorded on the disc being displayed.

## Playing from a specific time (Time Search)

### 1. Select Time.

Use **▲/▼** to select, then press **ENTER**.

### 2. Input the time.

Use the number buttons (0 to 9) to input the time.

- To play from 45 minutes, input **0, 0, 4, 5, 0** and **0**, then press **ENTER**.
- To play from 1 hour 20 minutes, input **0, 1, 2, 0, 0** and **0**, then press **ENTER**.
- Press **CLEAR** to clear the values you have input.

### 3. Starting playback from the specified time.

Press **ENTER**.



## Playing a specific title, chapter, track or file (Search)

- 1. Select Title or Chapter (track/file).**  
Use **▲/▼** to select, then press **ENTER**.
- 2. Input the Title or Chapter (track/file) number.**  
Use the number buttons (0 to 9) or **▲/▼** to input the number.
  - To search for title 32, input **3** and **2**, then press **ENTER**.
  - Press **CLEAR** to clear the values you have input.
- 3. Starting playback from the specified title, chapter or track.**  
Press **ENTER**.

## Playing specified range of discs, titles or chapter (track/file) in random order

You can select from 2 types of random playback.

- 1. Select Play Mode.**  
Use **▲/▼** to select, then press **ENTER**.
- 2. Select the playing mode.**  
Use **▲/▼** to select, then press **ENTER**.

### ❖ Random play

The specified range of discs, titles or chapter (track/file) is played in random order. The same item may be played consecutively.

### ❖ Shuffle play

The specified range of discs, titles or chapter (track/file) is played in random order. Each item is played once.

## Continuing playback from a specified position (Continued Viewing Playback)

This function allows you to continue playback from a position you specify to be played next time, even after turning the power off.

### ❖ Setting

- ▶ During playback, press CONTINUED at the position from which you want to start continued viewing playback.**  
The elapsed playing time at the specified position is displayed on the TV screen.

### ❖ Playing

- 1. Press ► PLAY to play the title for which you have set continued viewing playback.**  
The continued viewing playback confirmation screen appears.
- 2. Use ◀▶ to select Yes, then press ENTER.**  
Playback starts from the specified position.

### ! Note

- The continued viewing playback setting is canceled when **▲ OPEN/CLOSE** is pressed.
- Continued viewing playback may not work properly with some discs.

## Chapter 5 Playback from Home Media Gallery

### About Home Media Gallery

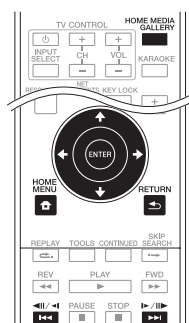

5

Playback from Home Media Gallery



This player's Home Media Gallery function allows you to display a list of input sources and start playback. This chapter describes setup and playback procedures required to enjoy these features. When you play the files stored on your computer or the components on the network, it is advisory that you also refer to the operation manual supplied with your network component.

The input sources that can be played from Home Media Gallery are as shown below.

- BD-R/RE (BD-RE format) discs
- DVD-R/RW (VR format) discs
- Audio CDs (CD-DA, SACD and DTS CDs)
- DVD/CDs on which only data files of video, image or audio files, etc. are recorded.
- USB device
- Files on the network servers (on the PCs or components connected to the player via LAN interface.)

#### ! Note

- The Home Media Gallery allows you to play files on media servers connected to the same Local Area Network (LAN) as the unit.

- The following files are allowed to be played from Home Media Gallery:
  - PCs running Microsoft Windows Vista or XP with Windows Media Player 11 installed
  - PCs running Microsoft Windows 7 with Windows Media Player 12 installed
  - DLNA-compatible digital media servers (on PCs or other components)
 Files stored in a PC or DMS (Digital Media Server) as described above can be played by Digital Media Player (DMP). The player supports the use of such DMP.
- To play back audio files stored on components on the network, you must turn on the DHCP server function of your router. In case your router does not have the built-in DHCP server function, it is necessary to set up the network manually. Otherwise, you cannot play back files stored on components on the network. See page 80.

### About network playback

The network playback function of this unit uses the following technologies:

#### ❖ Windows Media Player

See Windows Media Player 11/Windows Media Player 12 above for more on this.

#### ❖ Windows Media DRM

Microsoft Windows Media Digital Rights Management (WMDRM) is a platform to protect and securely deliver content for playback on computers, portable devices and network devices. Home Media Gallery functions as a WMDRM 10 for networked devices. WMDRM protected content can only be played on media servers supporting WMDRM.

Content owners use WMDRM technology to protect their intellectual property, including copyrights. This device uses WMDRM software to access WMDRM protected content. If the WMDRM software fails to protect the content, content owners may ask Microsoft to revoke the software's ability to use WMDRM to play or copy protected content. Revocation does not affect unprotected content. When you download licenses for protected content, you agree that Microsoft may include a revocation list with the licenses. Content owners may require you to upgrade WMDRM to access their content. If you decline an upgrade, you will not be able to access content that requires the upgrade. This product is protected by certain intellectual property rights of Microsoft.

Use or distribution of such technology outside of this product is prohibited without a license from Microsoft.

❖ **DLNA**



*DLNA CERTIFIED® Audio Player*

The Digital Living Network Alliance (DLNA) is a cross-industry organization of consumer electronics, computing industry and mobile device companies. Digital Living provides consumers with easy sharing of digital media through a wired or wireless network in the home.

The DLNA certification logo makes it easy to find products that comply with the DLNA Interoperability Guidelines. This unit complies with DLNA Interoperability Guidelines v1.5. When a PC running DLNA server software or a DLNA compatible device is connected to this player, some setting changes of software or other devices may be required. Please refer to the operating instructions for the software or device for more information.

*DLNA®, the DLNA Logo and DLNA CERTIFIED® are trademarks, service marks, or certification marks of the Digital Living Network Alliance.*

❖ **Content playable over a network**

- Even when encoded in a compatible format, some files may not play correctly.
- Some functions may not be supported depending on the server type or version used.
- Supported file formats vary by server. As such, files not supported by your server are not displayed on this unit. For more information check with the manufacturer of your server.

❖ **Disclaimer for Third Party Content**

Access to content provided by third parties requires a high speed Internet connection and may also require account registration and a paid subscription.

Third party content services may be changed,

suspended, interrupted, or discontinued at any time without notice, and Pioneer disclaims any liability in connection with such occurrences.

Pioneer does not represent or warrant that content services will continue to be provided or available for a particular period of time, and any such warranty, express or implied, is disclaimed.

❖ **About playback behavior over a network**

- Playback may stall when the PC is switched off or any media files stored on it are deleted while playing content.
- If there are problems within the network environment (heavy network traffic, etc.) content may not be displayed or played properly (playback may be interrupted or stalled). For best performance, a 10BASE-T/100BASE-TX connection between the player and the PC is recommended.
- If several clients are playing simultaneously, as the case may be, playback is interrupted or stalled.
- Depending on the security software installed on a connected PC and the setting of such software, network connection may be blocked.

Pioneer is not responsible for any malfunction of the player and/or the Home Media Gallery features due to communication errors/malfunctions associated with your network connection and/or your PC, or other connected equipment. Please contact your PC manufacturer or Internet service provider.

*Windows Media is either a registered trademark or trademark of Microsoft Corporation in the United States and/or other countries.*

*This product includes technology owned by Microsoft Corporation and cannot be used or distributed without a license from Microsoft Licensing, Inc.*

*Microsoft®, Windows®7, Windows®Vista, Windows®XP, Windows®2000, Windows®Millennium Edition, Windows®98, and WindowsNT® are either registered trademarks or trademarks of Microsoft Corporation in the United States and/or other countries.*

## DLNA Search

Playing back the files stored on the components connected to the player via network.

- 1. Press HOME MEDIA GALLERY to display the Home Media Gallery.**  
The Home Media Gallery can also be displayed by selecting Home Media Gallery from Home Menu, then pressing **ENTER**.
- 2. Select DLNA Search.**  
Use **▲/▼** to select, then press **ENTER**.
- 3. Select the server which contains the file you want to play.**
- 4. Select the file you want to play.**  
Use **▲/▼** to select, then press **ENTER**.

### ! Note

- This player does not support DTCP-IP.
- Recorded files and contents that are protected by digital copyright protection cannot be played via LAN interface.

5

Playback from Home Media Gallery

## Disc/USB playback

- 1. Press HOME MEDIA GALLERY to display the Home Media Gallery.**  
The Home Media Gallery can also be displayed by selecting Home Media Gallery from Home Menu, then pressing **ENTER**.
- 2. Select Disc or USB.**  
Use **▲/▼** to select, then press **ENTER**.
- 3. Select Photo/Music/Video/AVCHD.**  
Use **▲/▼** to select, then press **ENTER**.
  - This step is not for the discs that have been recorded with BDAV/VR/AVCREC format.
  - To play files in AVCHD format on a USB device, create a folder named "AVCHD" on the USB device, then copy the "BDMV" folder containing which the files to be played into the "AVCHD" folder.
- 4. Select the title/track or file you want to play.**  
Use **▲/▼** to select, then press **ENTER**.  
Playback starts from the selected title/track or file.
  - If the file you want to play is in the folder, select the folder that contains the file first.

## Playing back image files

### ❖ About Slideshow

A display of the files on the disc or in the folder switches automatically.

### ! Note

- When playing an audio CD (CD-DA/SACD/DTS-CD), the Now Playing screen is displayed.
- Some BD-R/-RE discs have playback protection. To cancel the protection, input the password set for the disc.
- It may take a few seconds before playback starts. This is normal.
- It may not be possible to play some files properly.
- The number of views may be restricted.
- Depending on the connected devices and conditions, some time may be required for playback to start and for the image to switch.

## Playing in the desired order (Playlist)

The discs that can add tracks and files to the Playlist are as shown below.

- DVDs/CDs/USB devices on which audio files are recorded

### Adding tracks/files

Use this procedure to add tracks and files, and create the **Playlist**.

- 1. Press HOME MEDIA GALLERY to display the Home Media Gallery.**  
The Home Media Gallery can also be displayed by selecting Home Media Gallery from Home Menu, then pressing **ENTER**.
- 2. Select Disc or USB.**  
Load the disc beforehand.  
Use **▲/▼** to select, then press **ENTER**.
- 3. Select the track/file to be added.**  
Use **▶** to select.
- 4. Press POP UP MENU to display the POP UP MENU menu.**
- 5. Select Add to Playlist to add to Playlist.**  
Use **▲/▼** to select, then press **ENTER**.  
The track or file selected in step 3 is added to the **Playlist**.
  - To add more tracks or files, repeat steps 3 to 5.

## Playing the playlist

- 1. Press HOME MEDIA GALLERY to display the Home Media Gallery.**  
The Home Media Gallery can also be displayed by selecting Home Media Gallery from Home Menu, then pressing **ENTER**.
- 2. Select Playlist.**  
Use **▲/▼** to select, then press **ENTER**.
- 3. Select the track/file to be played.**  
Use **▲/▼** to select, then press **ENTER**.  
Playback starts from the selected track/file and continues until the end of the list is reached. Use **◀◀/▶▶** to play the previous or next track/file. The Now Playing screen is displayed.

## Deleting tracks/files from the playlist

- 1. Select the track/file to be deleted, then press POP UP MENU to display the POP UP MENU menu.**
- 2. Use ▲/▼ to select Remove from Playlist, then press ENTER.**

## Chapter 6 Playing the web contents

You can enjoy some streaming contents on the Internet with the player.

### Available web contents

- YouTube (MPEG4 AVC H.264)
- Picasa

#### ! Note

##### About YouTube

- YouTube videos of the following sizes can be played.
  - Standard quality (400 x 226 pixels, 200 kbps)
  - Medium quality (480 x 360 pixels, 512 kbps)
  - High quality (854 x 480 pixels, 900 kbps)
  - HD (720p) (1280 x 720 pixels, 2 Mbps)
  - HD (1080p) (1920 x 1080 pixels, 4 Mbps)
- This player supports the YouTube Leanback service. The Youtube Leanback service is only available in English for now. Refer to YouTube Help at <http://www.google.com/support/youtube/> for further information.
- YouTube videos for mobile phones cannot be played.
- Some YouTube videos cannot be played.

##### About Picasa

- Picasa is available only in English. Refer to instructions at <http://picasa.google.com/support/> for details.
  - Register your user name and password on the PC before you use Picasa Web Albums.
  - When you access Picasa from this player for the first time, select the New User icon and enter your registered user name and password.
- Depending on the Internet connection environment, it may not be possible to play web contents properly.
- To access to web contents, this player requires a broadband Internet connection. A contract with an Internet provider is required for a broadband Internet connection.
- Access to content provided by third parties requires a high speed Internet connection and may also require account registration and a paid subscription. Third party content services may be changed, suspended, interrupted, or discontinued at any time without notice, and Pioneer disclaims any liability in connection with such occurrences. Pioneer does not represent or warrant that content services will continue to be provided or available for a particular period of time, and any such warranty, express or implied, is disclaimed.
- Disc playback and this function cannot be used at the same time.

## Playing the items

#### ! Caution

You must connect the player to the Internet beforehand. See Connecting to the network through LAN interface on page 47 for the details.

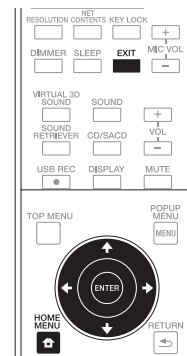

#### 1. Display the selection screen.

The selection screen can be selected by pressing **HOME MENU** then selecting Web Contents → Desired web content.

#### 2. Select the type of web contents.

Use **▲/▼** to select, then press **ENTER**.

#### 3. Press **▲/▼** to select the item you want to play, then press **ENTER**.

To stop playback, press **EXIT**. Playback of the video stops and the Home Menu screen reappears.

## Chapter 7 Other Operating

### Recording Audio CD to a USB device

You can record audio CD to a USB device using this player.

#### 1. Insert an USB device into the USB port on the front panel.

##### ! Note

- Please connect only one USB device.

#### 2. Open the disc tray and place an Audio CD on the tray.

Press **▲ OPEN/CLOSE**.

#### 3. Close disc tray.

When **▲ OPEN/CLOSE** is pressed, playback will start automatically.

- If playback does not start automatically, press the **▶ PLAY** on the remote or **▶/||** (PLAY/PAUSE) on the device to start playback.

#### 4. Press USB REC during CD playback. [CD RIP] will be displayed.

#### 5. Select the song or the Track No. you want to record.

If you are recording all the songs on the CD use **▲/▼/◀/▶** to select **[Select all]** and press **ENTER**.

If you are selecting a Track to record use **▲/▼/◀/▶** to select the Track No. and press **ENTER**.

- If there are more than one Track you want to record, repeat the step for 5.
- If you want to delete a selected Track use **▲/▼/◀/▶** to select **[Select None]** and press **ENTER**.

#### 6. Set the recording speed

Use **▲/▼/◀/▶** to select **[Speed]** and press **ENTER**.

- The recording speed will change each time **ENTER** is pressed. The recording speed will change as shown below.

**Normal:** when recording while listening to the music.

**Fast:** will record at approx 4x speed. You cannot listen to the music.

#### 7. Start recording.

Use **▲/▼/◀/▶** to select **[Start]** and press **ENTER** to start recording.

#### 8. Exit CD recording display.

Use **▲/▼/◀/▶** to select **[Cancel]** then press **ENTER** after recording has finished.

##### ! Note

- Use cursor **▲/▼/◀/▶** to select **[Bitrate]** then press **ENTER** to change the Bitrate setting. The set speed will change each time **[Bitrate]** is pressed. The set value can be selected from those shown below.  
**[64kps] → [96kps] → [128kps] → [192kps] → [256kps] → [320kps]**

## iPod/iPhone playback

Merely by connecting your iPod/iPhone to this unit, you can enjoy high-quality sound from your iPod/iPhone. This unit can also be connected to a television set, letting you view images from your iPod/iPhone.

Playback and volume level setting for iPod/iPhone music and images can be performed from this unit or the iPod/iPhone itself.

- The iPod nano 6G cannot play back video, but can play slide shows only.
  - This system has been developed and tested for the software version of iPod/iPhone indicated on the website of Pioneer (<http://pioneer.jp/homeav/support/ios/eu/>).
  - Installing software versions other than indicated on the website of Pioneer to your iPod/iPhone may result in incompatibility with this system.
  - When using an iPod/iPhone not supported by this unit, use a commercially available cable to connect the iPod/iPhone to the PORTABLE IN connector of this unit.
  - Before connecting the iPod, turn this unit off and reduce the volume of this unit to its minimum.
1. Connect the cradle so that the mark ▼ is downwards. Put your iPod/iPhone on it. Connect the iPod/iPhone firmly. If you turn this unit on, your iPod/iPhone is automatically turned on and recharging starts.

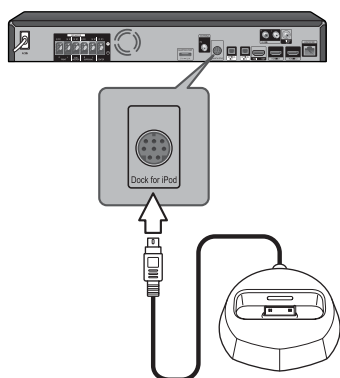

### ! Note

- Pioneer does not guarantee that this unit plays iPod/iPhone models other than the ones specified.
- Some functions may be restricted depending on the model or software version.
- iPod/iPhone is licensed for reproduction of non-copyrighted materials or materials the user is legally permitted to reproduce.
- Features such as the equalizer cannot be controlled using this system, and we recommend switching the equalizer off before connecting.
- Pioneer cannot under any circumstances accept responsibility for any direct or indirect loss arising from any inconvenience or loss of recorded material resulting from iPod/iPhone failure.
- For detailed instructions on using the iPod/iPhone, please refer to the manual supplied with the iPod/iPhone.

## Connecting your TV

To watch iPod/iPhone images on a television, connect it using a composite video cable.

When an iPod/iPhone is connected to this unit, the TV output setting of the iPod/iPhone is automatically set to 'ON'.

### ! Note

- Some iPod allow the TV output setting to be changed while connected.
- When the iPod/iPhone is disconnected from this unit, the iPod/iPhone's TV output setting returns to its original state.



## Playing your iPod/iPhone









### Caution

- When your iPod/iPhone is connected to this unit and you wish to operate the iPod/iPhone directly, be sure to hold the iPod/iPhone steady with the other hand to prevent malfunctions due to faulty contacts.

### 1. Connect your iPod/iPhone.

To connect your iPod/iPhone, see Connecting your iPod/iPhone on page 70.

### 2. Press **FUNCTION** to select iPod as the input source and press **ENTER**.

Button	What it does
 PLAY	Starts normal playback.
 PAUSE	Pauses playback.
 STOP	Pauses playback.
 PREV	Press to skip to the start of the current file, then previous files.
 NEXT	Press to skip to the next file.
	Press to start fast reverse scanning.
	Press to start fast forward scanning.
MENU	Use to access the iPod/iPhone menu.
 /ENTER	Use to control the iPod/iPhone menu.

## Important

- If this unit cannot play your iPod/iPhone, perform the following troubleshooting checks:
  - Check whether the iPod/iPhone is supported by this unit.
  - Reconnect the iPod/iPhone to the unit. If this doesn't seem to work, try resetting your iPod/iPhone.
  - Check the iPod/iPhone software is supported by this unit.
- If the iPod/iPhone cannot be operated, check the following items:
  - Is the iPod/iPhone connected correctly? Reconnect the iPod/iPhone to the unit.
  - Is the iPod/iPhone experiencing a hangup? Try resetting the iPod/iPhone, and reconnect it to the unit.

### Note

- When input is switched from iPod to another function, iPod/iPhone playback is temporarily stopped.

## Radio Operations

Be sure that FM aerial is connected. (Refer to the page 44)

### Listening to the radio

1. Press **FUNCTION** until FM appears in the display window and press **ENTER**.  
The last received station is tuned in.
2. Scanning will start when either the **▶▶** or the **◀◀** button is pressed.  
or  
Press **▲/▼** repeatedly.  
or  
Press **◀▶** on the front panel of the player repeatedly.
3. Adjust the volume by rotating **VOLUME** on the front panel or by pressing **VOL +** or **VOL -** on the remote control repeatedly.

### Presetting the radio stations

You can preset 50 stations for FM.

Before tuning, make sure that you have turned down the volume.

1. Press **FUNCTION** until FM appears in the display window and press **ENTER**.  
The last received station is tuned in.
2. Select the desired frequency by using **▲/▼**.
3. Press **PROGRAM** a preset number will flash in the display window.
4. Press **◀/▶** to select the preset number you want.
5. Press **PROGRAM**.  
The station is stored.
6. Repeat the steps 2 to 5 to store other stations.
7. You can select the stored station by pressing **◀/▶**.

### Deleting all the saved stations

1. Press and hold **STOP** for two seconds.  
**[ERASE ALL]** will flash up on the display window.
2. Press **STOP** to erase all of the saved radio stations.

### Improving poor FM reception

Press **AUDIO** on the remote control. This will change the tuner from stereo to mono and usually improve the reception.

### Seeing information about a radio station

The FM tuner is supplied with the RDS (Radio Data System) facility. This shows information about the radio station being listened to. Press **BOOKMARK (RDS)** repeatedly to cycle through the various data types:

<b>PS</b>	(Programme Service Name) The name of the channel will appear in the display.
<b>PTY</b>	(Programme Type Recognition) The programme type (e.g. Jazz or News) will appear in the display.
<b>RT</b>	(Radio Text) A text message contains special information from the broadcast station. This text may scroll across the display.

You can search the radio stations by programme type by pressing **BOOKMARK (RDS)**. The display will show the last **PTY** in use. Press **ZOOM (PTY)** one or more times to select your preferred programme type. Press and hold **◀/▶**. The tuner will search automatically. When a station is found the search will stop.

## Bluetooth® ADAPTER for Wireless Enjoyment of Music

- *Bluetooth* wireless technology enabled device: cell phone
- *Bluetooth* wireless technology enabled device: Digital music player
- Device not equipped with *Bluetooth* wireless technology: Digital music player + *Bluetooth* audio transmitter (sold commercially)

### Wireless music play

When the *Bluetooth* ADAPTER (Pioneer Model No. AS-BT100 or AS-BT200) is connected to this unit, a product equipped with *Bluetooth* wireless technology (portable cell phone, digital music player, etc.) can be used to listen to music wirelessly. Also, by using a commercially available transmitter supporting *Bluetooth* wireless technology, you can listen to music on a device not equipped with *Bluetooth* wireless technology. The AS-BT100 and AS-BT200 model supports SCMS-T contents protection, so music can also be enjoyed on devices equipped with SCMS-T type *Bluetooth* wireless technology.

- With the AS-BT100, some functions may not be available on this unit.
- It must be necessary that the *Bluetooth* wireless technology enabled device supports A2DP profiles.

#### ! Note

- Pioneer does not guarantee proper connection and operation of this unit with all *Bluetooth* wireless technology enabled devices.
- About one minute is required between turning the power on and completion of startup.

## Listen to music on a *Bluetooth* wireless technology enabled device

### Pairing of the unit and a *Bluetooth* wireless technology enabled device. (Initial registration)

Prior to starting pairing, make sure that the *Bluetooth* function on your *Bluetooth* wireless technology enabled device is turned on. Please see the user manual of your *Bluetooth* wireless technology enabled device for more details. The pairing operation only needs to be performed once, and then is not required again.

#### 1. Press **FUNCTION** and change input to **BLUETOOTH** and press **ENTER**.

After **[BLUETOOTH]** is displayed in the unit's display window, **[READY]** will then be displayed.

#### 2. Operate the *Bluetooth* wireless technology enabled device and perform pairing.

When a *Bluetooth* wireless technology enabled device searches for this unit, some *Bluetooth* wireless technology enabled devices will display a list of supported devices on their display section. This unit will be displayed as *Bluetooth* ADAPTER **[AS-BT100]** or **[AS-BT200]**.

#### 3. Enter the **PIN code**.

Pin code: 0000

This unit cannot be set with any PIN code other than 0000.

#### 4. When the unit and a *Bluetooth* wireless technology enabled device are successfully paired, **[SINK]** will be displayed in the unit's display window.

#### ! Note

- The pairing method may differ depending on the type of *Bluetooth* wireless technology enabled device.

#### 5. Playback music using the *Bluetooth* wireless technology enabled device.

Please see the user manual of your *Bluetooth* wireless technology enabled device for details on how to playback music.

**Note**

- This unit does not support AVRCP.
- This unit does not support Mono Headset Profile (Hands Free Profile).
- A *Bluetooth* wireless technology enabled device cannot be operated by this unit.
- This unit cannot be used to listen to one seg sounds on a *Bluetooth* wireless technology enabled device. Music contents protected by SCMS-T cannot be listened to.
- Only one *Bluetooth* wireless technology enabled device may be paired with this unit; multiple pairing is not possible.
- You may be unable to use the *Bluetooth* function, depending on the type of *Bluetooth* wireless technology enabled device.
- When not connected by *Bluetooth*, [READY] will be displayed in the unit's display window.
- Other electro-magnetic waves may cause interference with the connection, causing the sound to cut out.
- If medical equipment, microwaves, wireless LAN routers etc. on the same frequency cause malfunction to occur, the *Bluetooth* connection will be lost.
- Even if the distance between the *Bluetooth* wireless technology enabled device and the unit is less than 10 meters, if there are other obstacles in between the two of them then you will be unable to connect the *Bluetooth* wireless technology enabled device.
- If an obstacle comes between the *Bluetooth* wireless technology enabled device and the unit to interrupt communication, the *Bluetooth* connection will be lost.
- If the *Bluetooth* wireless technology enabled device and the unit move apart then sound quality will fall, and if they move beyond the operating range the *Bluetooth* connection will be lost.
- If the power to the unit is cut or the *Bluetooth* wireless technology enabled device is moved more than 10 meters from the unit, the *Bluetooth* connection will be lost.

## Karaoke

- 1. Press KARAOKE on the remote control.**  
Karaoke Setup under Initial Setup will be displayed on the TV screen.
- 2. Turn the Karaoke Switch on.**  
Select [Karaoke Setup] → [Karaoke Switch] → [On] using cursor and press ENTER.
- 3. Adjust microphone volume.**  
Select [Karaoke Setup] → [Microphone] → [Mic Volume] using cursor and press ENTER. Use ←/→ to adjust the microphone volume. Press RETURN to finish.
- 4. Adjust microphone echo.**  
Select [Karaoke Setup] → [Microphone] → [Mic Echo] using cursor and press ENTER. Use cursor ←/→ to adjust the microphone echo. Press RETURN to finish.
- 5. Switch Vocal Cancel on or off.**  
Use cursor to select [Karaoke Setup] → [Vocal Cancel] → [On] or [Off] and press ENTER.

**Note**

- Karaoke can only be used with disc playback or USB playback.
- Depending on the song, Voice Cancel may not be effective.
- When inserting the MIC terminal, support the top of the unit with your hand to prevent it from moving.

## Sound

Press **SOUND** on the remote control to display the sound select menu on the TV screen.

Use cursor button to make a selection, then press **ENTER**.

Setting	Options	Explanation	
Sound Retriever	Off	A WMA or MP3 file is played with high sound quality. This is only valid for files with the extension ".wma" or ".mp3". The effect depends on the file. Try different settings, and choose the one providing the best effect.	
	Low		
	High		
Equalizer	Add a variety of effects to the output sound. Select a mode that suits your personal tastes.		
	Original	Enjoy a relaxing and natural sound.	
	News	This mode is suited to the news.	
	Gaming	This mode is suited to video games.	
	Movie	This mode is suited to movies.	
Surround	Music	This mode is suited to music.	
	Off	Virtual 3D Sound: Has the effect of creating a 3D sound space.	
	Virtual 3D Min		Effect is minimum
	Virtual 3D Mid		Effect is moderate
	Virtual 3D Max	Effect is maximum	
	5 Speaker Mode1 (BCS-727/BCS-323)	The sound from the front speakers will also be output by the rear speakers. This mode is valid in both 2 channel audio source and 5.1 channel audio source.	
	5 Speaker Mode2 (BCS-727/BCS-323)	The same sound will be output from the 5 speakers other than the sub woofer. This mode is valid in both 2 channel audio source and 5.1 channel audio source.	
Dolby PL II Movie (BCS-727/BCS-323)	Dolby Pro Logic II enables you to play stereo source on 5.1-channel. This mode is valid in 2 channel audio source.		
Sound Wing Mode (BCS-HF828 Only)	Dolby PL II Music (BCS-727/BCS-323)		
	Off	HVT speakers make it possible to enjoy a broader-ranging sound.	
Audio Sync	On		
	Adjust the delay between image and sound. Use <b>←/→</b> to adjust.		

## Chapter 8 Advanced settings

### Changing the settings

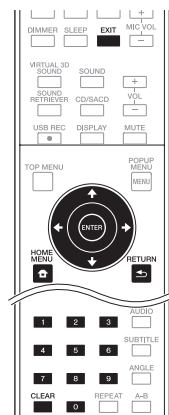

### Operating the initial setup screen

1. **When playback is stopped, display the Home Menu screen.**  
Press **HOME MENU**.
  2. **Select and set Initial Setup.**  
Use **▲/▼** to select, then press **ENTER**.
  3. **Select the item and change the setting.**  
Use **▲/▼/◀/▶** to select, then press **ENTER**.
- ❖ **Closing the Initial Setup screen**  
Press **HOME MENU** or **RETURN**.

**Note**

- The items that can be selected depend on the player's status.
- In Options, the factory default settings are indicated in bold.

Setting	Options	Explanation
TV Screen	16:9 Full	Select this when connecting to a wide (16:9) TV.
	<b>16:9 Normal</b>	Select this when connected to a wide (16:9) TV. 4:3 pictures are displayed with vertical black bars along the sides.
	4:3 Pan&Scan	Select this when connecting to a 4:3 screen TV and playing a 16:9 video. The video will be played with the left and right sides of the image cut off to display on the 4:3 screen. (This function works if the disc is labeled for 4:3PS.)
	4:3 Letterbox	Select this when connecting to a 4:3 screen TV and playing a 16:9 video. The video will be played with black bands at the top and bottom.
Video Adjust	The quality of the playback picture can be adjusted according to the TV you are using (page 80).	
Sharpness	High	Choose the level of sharpness.
	Middle	
	<b>Low</b>	
Video Mode	<b>Standard</b>	Choose the video output mode.
	Vivid	
	Cinema	
	Custom	
Noise Reduction	• CTI (Color Transient Improvement): Provides images with clearer color contours.	
	<b>0</b>	Choose the level of noise reduction.
	1	
	2	
3		
Net Contents Mode	<b>Off</b>	Select this to automatically correct compressed video files on the network, a disc or a USB device and play them with a more natural picture quality.
	On	

Setting	Options	Explanation	
Audio Output	DRC (Dynamic Range Control)	<b>Off</b>	Select this to output audio signals without using the DRC function.
		On	Select this to adjust the range between the loudest and softest sounds (dynamic range) for playback at average volume. Use this when it is hard to hear dialog or when watching movies at midnight.
		Auto	Select to switch the DRC setting On/Off automatically according to the input audio signal from the disc. This only affects Dolby TrueHD signals.
			<ul style="list-style-type: none"> <li>This affects such audio signals as Dolby Digital, Dolby TrueHD, and Dolby Digital Plus.</li> <li>Depending on the disc, the effect may be weak.</li> </ul>
Speaker Setup		Adjust the Trim (output level) and Delay (distance from viewers) of the speakers. Please see "Adjust speaker settings" for more details (page 80).	
Test Tone		Output a test tone from the speakers.	
HDMI	Color Space	RGB	Select this to output the video signals as RGB signals. Choose this if the colors seem too faint and the black seems too bright.
		YCbCr	Select this to output the video signals as YCbCr 4:4:4 signals.
		<b>YCbCr 422</b>	Select this to output the video signals as YCbCr 4:2:2 signals.
		Full RGB	Select this to output the video signals as RGB signals. Choose this if the colors seem too dense and all the dark colors are displayed in a uniform black.
Resolution	<b>Auto</b>	Select this to choose the resolution of the video signals output from the <b>HDMI OUT</b> terminal automatically.	
	480i/576i	Output the video signals from the <b>HDMI OUT</b> terminal with the selected resolution.	
	480P/576P	The resolution can be changed by pressing <b>RESOLUTION</b> , but Auto cannot be selected.	
	720P		
	1080i		
	1080P		
HDMI Audio Out		Bitstream	Select this to output HDMI audio signals directly.
		<b>PCM</b>	Select this to output HDMI audio signals converted to 2-channel audio signals.
		Re encode	When a BD containing secondary audio and interactive audio is played, the two audio signals are mixed and converted to Dolby Digital audio or DTS audio for output.
		Off	Select this when you do not want to output the audio signal from the HDMI output terminal.
Control		<b>On</b>	Select this to control the player with the remote control of the connected AV device using an HDMI cable. Also refer to page 42.
		Off	Select this when you do not want to control the player with the remote control of the connected AV device using an HDMI cable.
HDMI Deep Color		30bits	Select this when outputting the video signals with 30-bit color.
		36bits	Select this when outputting the video signals with 36-bit color.
		<b>Off</b>	Select this when outputting the video signals with normal 24-bit color.
HDMI 1080P 24Hz		<b>On</b>	Select this when Resolution is set to <b>Auto</b> or 1080P and outputting 1080p/24 video signals to a TV compatible with 1080p/24.
		Off	Select this when Resolution is set to 1080P and outputting 1080p/60 video signals to a TV compatible with 1080p/60.
HDMI 3D		<b>Auto</b>	With 3D discs, the disc is played with 3D images.
		Off	3D images are not played.
3D Notice		<b>Yes</b>	This sets whether or not to display the 3D notice when playing 3D images.
		No	

## 78 Advanced settings

En

Setting	Options	Explanation	
Network	IP Setting	Select this to set the IP address of the player and DNS server (page 80).	
	Proxy Server	Only set the proxy server if so instructed by your Internet service provider (page 81).	
	Information	Displays the values of the MAC address, IP address, subnet mask, default gateway, DNS server (primary) and DNS server (secondary).	
	Connection Test	Select this to test the network connection (page 81).	
	Internet Connection	<b>Enable</b>	Select this when connecting to the Internet.
		Disable	Select this when not connecting to the Internet.
	BD-Live Connection	<b>Permitted</b>	All discs are allowed to connect to BD-LIVE.
		Partial Permitted	Only discs whose safety has been confirmed are allowed to connect to BD-LIVE.
		Prohibited	No disc is allowed to connect to BD-LIVE.
	DLNA	<b>Enable</b>	Select this when connecting to DLNA server.
Disable		Select this when not connecting to DLNA server.	
Interface	<b>Ethernet</b>	Select when using a LAN cable to connect to the network.	
	Wireless	Select when connecting wirelessly to the network.	
Wireless Setting	Perform settings for a wireless network connection. (page 48).		
Language	OSD	available languages Choose a language for the on-screen displays from the listed languages.	
	Audio	available languages Choose a language from the listed languages to set the default audio language for BD-ROM and DVD-Video playback.	
	* For some discs, it may not be possible to change to the selected language.		
	If a language not recorded on the BD/DVD is set, one of the recorded languages is automatically selected for playback.		
	Subtitle	available languages Choose a language from the listed languages to set the default subtitle language for BD-ROM and DVD-Video playback.	
	* For some discs, it may not be possible to change to the selected language.		
If a language not recorded on the BD/DVD is set, one of the recorded languages is automatically selected for playback.			
Menu	available languages	Choose a language from the listed languages to set the default language for BD-ROM and DVD-Video menus.	
	* For some discs, it may not be possible to change to the selected language.		
	If a language not recorded on the BD/DVD is set, one of the recorded languages is automatically selected for playback.		
Playback	Angle Mark	<b>On</b>	Select this to display the angle mark on the TV screen (page 58).
		Off	Select this if you do not want to display the angle mark on the TV screen.
	PIP Mark	<b>On</b>	Select this to display the PIP mark on the TV screen.
		Off	Select this if you do not want to display the PIP mark on the TV screen.
	Secondary Audio Mark	<b>On</b>	Select this to display the secondary audio mark on the TV screen (page 62).
		Off	Select this if you do not want to display the secondary audio mark on the TV screen.
DivX(R) VOD DRM	Registration Code	Displays the player's registration code required to play DivX VOD files (page 15).	
Internet Setting	<b>Permitted</b>	Web contents can be watched without entering the password.	
	Partial Permitted	The password must be entered to watch web contents.	
	Prohibited	No web contents can be watched.	
Disc Auto Playback	<b>On</b>	Discs are played automatically after they are loaded.	
	Off	Loaded discs do not start playing automatically.	
Last Memory	<b>On</b>	Select this to save the point at which you last stopped playback, even after the disc tray is opened or you switch to the standby mode.	
	Off	Select this when you want to use only Continue Viewing Play (page 63).	
PBC (Play Back Control)	<b>On</b>	Select this to play Video-CDs (version 2.0) compatible with PBC using the disc menu.	
	Off	Select this to play Video-CDs (version 2.0) compatible with PBC without using the disc menu.	
Setup Navigator	Start making the settings using the Setup Navigator menu. For details, see page 52.		



	Setting	Options	Explanation
Security	Change Password		Register (change) the password for parental lock settings or for unlocking to play DVD-Videos with the parental lock feature (page 82).
	Parental Control		Change the player's parental lock level (page 82).
	Country Code		Change the Country/Area code (page 82).
Options	Screen Saver	Off	The screen saver is not activated.
		<b>1 min</b>	The screen saver will be activated if no operation has been performed for more than one minute/two minutes/three minutes. Operating the remote control can deactivate the screen saver.
		2 min	
		3 min	
	Auto Power Off	Off	Select this if you do not want the power to turn off automatically.
		10 min	The power will be automatically turned off if no operation has been performed for more than 10 minutes/20 minutes/30 minutes.
		20 min	
		<b>30 min</b>	
	Quick Start	On	Select to shorten the required time to boot up.
		<b>Off</b>	Select to perform normal bootup.
Update	Disc	Select the method of software updating. (page 83)	
	USB Storage		
	Network		
Load Default		Restore the settings to the factory default.	
System Information		Check the system version number.	
Disc Auto Update	<b>On</b>	Display the software update screen when the disc with the player's update file is loaded.	
	Off	The software update screen must be displayed manually. (page 83)	
BUDA	BUDA Information	Display and set up the BUDA data on the connected USB device.	
	BUDA Setup		
Karaoke Setup	Karaoke Switch	<b>Off</b>	Select when not using Karaoke.
		On	Select when using Karaoke.
	Micphone Setup	Mic Volume 1	Select to adjust the volume of your microphone. Use ◀/▶ to perform the adjustment on the mic volume adjustment screen.
		Mic Echo	Select to adjust the level of microphone echo. Use ◀/▶ to perform the adjustment on the mic echo adjustment screen.
	Vocal Cancel	<b>Off</b>	Select when you want Vocal Cancel off.
On		Select when you want Vocal Cancel on.	

❖ **Adjusting the video****1. Select and set Display Setting → Video Adjust → Next Screen.**

Use **▲/▼** to select, then press **ENTER**.

**2. Select the item and change the setting.**

Use **▲/▼** to select the item, then use **◀/▶** to change the setting. Once the setting is completed, press **↵** **RETURN** to close the settings screen.

Item	Description
Brightness	Select this to adjust the TV screen's brightness.
Contrast	Select this to adjust the TV screen's contrast.
Hue	Select this to adjust the color (green and red) balance of the TV screen.
Saturation	Select this to adjust the TV screen's saturation.

❖ **Adjust speaker settings****1. Select and confirm Audio Output → Speaker Setup → Next Screen****2. A picture of speakers will be shown on the screen. Select the speaker using cursor and press ENTER.****3. Use ▲/▼ to select Trim or Delay and then press ENTER.****4. Use cursor ◀/▶ to adjust the setting, then press ENTER.**❖ **Adjust speaker settings while listening to a sound****1. Select and confirm Audio Output → Test Tone → Next Screen.****2. A test tone will be output. The speakers will switch automatically.****3. A picture of speakers will be shown on the screen. Press ENTER when the speaker you wish to adjust to is focused.****4. Use ▲/▼ to select Trim or Delay and then press ENTER.****5. Use ◀/▶ to adjust the setting, then press ENTER.**❖ **Setting the IP address****1. Select and set Network → IP Setting → Next Screen.**

Use **▲/▼** to select, then press **ENTER**.

**2. Set IP address.**

Use **▲/▼/◀/▶** to set the IP address of the player or DNS server, then press **ENTER**.

• **Auto Set IP Address**

**On** – The player's IP address is obtained automatically. Select this when using a broadband router or broadband modem that has a DHCP (Dynamic Host Configuration Protocol) server function. This player's IP address will automatically be allocated from the DHCP server.

**Off** – The player's IP address must be set manually. Use the number buttons (0 to 9) to input the IP address, subnet mask and default gateway.

! **Note**

- For information on the DHCP server function, refer to the operating instructions for the network device.
- You may need to contact your Internet service provider or network administrator when inputting the IP address manually.

### ❖ Setting the proxy server

Only set the proxy server if so instructed by your Internet service provider.

#### 1. Select and set Network → Proxy Server → Next Screen.

Use **▲/▼** to select, then press **ENTER**.

#### 2. Select and set Use or Not use at Proxy Server.

Use **◀/▶** to change, then press **↓**.

- **Use** – Select this when using a proxy server.
- **Not use** – Select this when not using a proxy server.

If you have selected **Use**, proceed to step 3.

#### 3. Select and set Server Select Method.

Use **◀/▶** to change, then press **↓**.

- **IP Address** – Input the IP address.
- **Server Name** – Input the server name.

#### 4. Input IP Address or Server Name.

Use the number buttons (0 to 9) to input the number if you select IP address in step 3.

Use **◀/▶** to move the cursor.

When Server Name is selected in step 3, use the number buttons (0 to 9) to launch the software keyboard. Now use **▲/▼/◀/▶** to select characters and items, then press **ENTER** to input.

#### 5. Input Port Number.

Press **↓**, then use the number buttons (0 to 9) to input the number.

#### 6. Press ENTER to set.

### ❖ Displaying the network settings

#### ▶ Select and set Network → Information → Next Screen.

Use **▲/▼** to select, then press **ENTER**.

The MAC address, IP address, subnet mask, default gateway and DNS server (primary and secondary) settings are displayed.

When **Auto Set IP Address** is set to On, the values obtained automatically are displayed.

#### ! Note

- **[0.0.0.0]** is displayed when each IP address has not been set.

### ❖ Testing the network connection

#### ▶ Select and set Network → Connection Test → Start.

Use **▲/▼** to select, then press **ENTER**.

**[Network is OK.]** is displayed once the test is completed. If any other message is displayed, check the connections and/or settings (pages 47 and 80).

### ❖ Changing to other language at language setting

#### 1. Select and set Language.

Use **▲/▼** to select, then press **ENTER**.

#### 2. Select and set OSD, Audio, Subtitle or Menu

Use **▲/▼** to select, then press **ENTER**.

#### 3. Select and set the desired language.

Use **▲/▼** to select, then press **ENTER**.

#### ! Note

- If a language not recorded on the BD/DVD is set, one of the recorded languages is automatically selected and played.

### ❖ Erasing data that has been added to BDs and application data

Use this procedure to erase data that has been added to BDs (data downloaded with the BD-LIVE function and data used with the BONUSVIEW function) and application data.

#### ! Caution

- Some time is required to erase the data.
- Do not unplug the power cord while data is being erased.

#### 1. Select and set BUDA → BUDA Setup.

Use **▲/▼** to select, then press **ENTER**.

#### 2. Select and set Fmt buda.

Press **ENTER**.

**❖ Registering or Changing the password**

Use this procedure to register or change the code number required for the Parental Lock settings.

**About default password of this unit**

The default password is [0000].

- This unit might ask you to enter a password when you change the password.
- If you reset this unit, your password is simultaneously changed to the default setting.

**1. Select and set Security → Change Password → Next Screen.**

Use **▲/▼** to select, then press **ENTER**.

**2. Input the password.**

Use the number buttons (0 to 9) to input the number, then press **ENTER** to set.  
Use **◀/▶** to move the cursor.

**3. Re-input the password.**

Use the number buttons (0 to 9) to input the number, then press **ENTER** to set.  
Use **◀/▶** to move the cursor.

- To change the password, input the previously registered password, then input the new password.

**! Note**

- We recommend making a note of the password.
- If you have forgotten the password, reset the player to the factory default setting, then register the password again (page 84).

**❖ Changing the Parental Lock level for viewing DVDs/BD-ROMs**

Some DVD-Video discs containing scenes of violence, for example, have Parental Lock levels (check the indications on the disc's jacket or elsewhere). To restrict viewing these discs, set the player's level to the level lower than the discs.

**1. Select and set Security → Parental Control → Next Screen.**

Use **▲/▼** to select, then press **ENTER**.

**2. Input the password.**

Use the number buttons (0 to 9) to input the number, then press **ENTER** to set.  
Use **◀/▶** to move the cursor.

**3. Change the level.**

Use **◀/▶** to change, then press **ENTER** to set.

**! Note**

- The level can be set to Off or between Level1 and Level8. When set to Off, viewing is not restricted.

**❖ Changing the Country/Area code****1. Select and set Security → Country Code → Next Screen.**

Use **▲/▼** to select, then press **ENTER**.

**2. Input the password.**

Use the number buttons (0 to 9) to input the number, then press **ENTER** to set.  
Use **◀/▶** to move the cursor.

**3. Change the country/area code.**

Use **◀/▶** to change, then press **ENTER** to set. Refer to page 85.

## Software updating

The player's software can be updated using one of the methods shown below.

- Connecting to the Internet.
- Using a disc.
- Using a USB flash drive.

Product information on this player is provided on the Pioneer website. Check the website shown on page 10 for update and service information on your Blu-ray disc player.

### Caution

- Do not unplug the power cord or remove the USB flash drive/disc during software updating. Also, do not press the reset button during updating. Otherwise, the updating will be aborted and malfunction may occur with the player.
- There are two processes for software updating, downloading and updating. Both processes may take a certain period of time.
- Other operations are defeated during software updating. Furthermore, updating process cannot be canceled.

## ❖ Updating connecting to the Internet

### Note

- Depending on the Internet connection conditions, downloading may take a long time.
- Steps **1** to **5** are the operations performed by the user (they are intended to download the software from the Internet).
- Steps **6** to **8** are the operations performed (automatically) by the player (they are intended to update the software).

#### **1. Connect to the Internet.**

#### **2. When playback is stopped, display the Home Menu screen.**

Press  HOME MENU.

#### **3. Select and set Initial Setup.**

Use  to select, then press ENTER.

#### **4. Select and set Options → Update → Network → Start.**

Use  to select, then press ENTER.

#### **5. Select and set Start.**

Press ENTER.

#### **6. Downloading of the software start.**

The software download status is displayed on the screen.

- Depending on the Internet connection conditions, software downloading may take a certain period of time.

#### **7. Updating starts.**

- Software updating may take a certain period of time.

#### **8. Updating completes.**

This unit automatically restarts.

### ❖ Updating using a USB flash drive/disc

#### ! Note

- When an update file is provided on the Pioneer website, use your computer to download it onto a USB flash drive or disc. Carefully read the instructions on downloading update files provided on the Pioneer website.
- Store the update file in the root directory of the USB flash drive or disc. Do not store it within a folder.
- Do not put any files other than the update file on the USB flash drive or disc.
- To update using a disc, use a CD-R or CD-RW disc.
- The player supports USB flash drive formatted in FAT32/16. When formatting a USB flash drive on your computer, do so with the settings below.
  - File system: FAT32
  - Allocation unit size: Default allocation size
- Only store the most recent update file on the USB flash drive or disc.
- Do not use a USB extension cable to connect a USB flash drive to the player. Using a USB extension cable may prevent the player from performing correctly.
- Steps **1** to **5** are the operations performed by the user.
- Steps **6** to **7** are the operations performed (automatically) by the player (they are intended to update the software).

- 1. Plug in the USB flash drive or load the disc on which the update file is stored.**
- 2. When playback is stopped, display the Home Menu screen.**  
Press **HOME MENU**.
- 3. Select and set Initial Setup.**  
Use **▲/▼** to select, then press **ENTER**.
- 4. Select and set Options → Update → Disc or USB Storage → Start.**  
Use **▲/▼** to select, then press **ENTER**.
- 5. Select and set Yes.**  
Use **▲/▼/◀/▶** to select **Yes**, then press **ENTER**.
- 6. Updating starts.**
  - Software updating may take a certain period of time.
- 7. Updating completes.**

### Restoring all the settings to the factory default settings

- 1. Check that the player's power is turned on.**
- 2. When playback is stopped, display the Home Menu screen.**  
Press **HOME MENU**.
- 3. Select and set Initial Setup.**  
Use **▲/▼** to select, then press **ENTER**.
- 4. Select and set Options → Load Default → Next Screen.**  
Use **▲/▼** to select, then press **ENTER**.
- 5. Select and set OK.**  
Use **◀/▶** to select, then press **ENTER**.

#### ! Note

- After restoring all the settings to the factory default settings, use **Setup Navigator** to reset the player (page 52).

## Language code table and country/area code table

### ❖ Language code table

Language name, language code, input code

Abkhazian, <b>ab/abk</b> , 0102	French, <b>fr/fra</b> , 0618	Malagasy, <b>mg/mlg</b> , 1307	Slovenian, <b>sl/slv</b> , 1912
Afar, <b>aa/aa</b> , 0101	Galician, <b>gl/glg</b> , 0712	Malay, <b>ms/msa</b> , 1319	Somali, <b>so/som</b> , 1915
Afrikaans, <b>af/af</b> , 0106	Georgian, <b>ka/kat</b> , 1101	Malayalam, <b>ml/mal</b> , 1312	Sotho, Southern, <b>st/sot</b> , 1920
Albanian, <b>sq/sqi</b> , 1917	German, <b>de/deu</b> , 0405	Maltese, <b>mt/mit</b> , 1320	Spanish, <b>es/spa</b> , 0519
Amharic, <b>am/amh</b> , 0113	Greek, <b>el/ell</b> , 0512	Maori, <b>mi/mri</b> , 1309	Sundanese, <b>su/sun</b> , 1921
Arabic, <b>ar/ara</b> , 0118	Guarani, <b>gn/grn</b> , 0714	Marathi, <b>mr/mar</b> , 1318	Swahili, <b>sw/swa</b> , 1923
Armenian, <b>hy/hye</b> , 0825	Gujarati, <b>gu/guj</b> , 0721	Mongolian, <b>mn/mon</b> , 1314	Swati, <b>ss/ssw</b> , 1919
Assamese, <b>as/asm</b> , 0119	Hausa, <b>ha/hau</b> , 0801	Moldavian, <b>mo/mol</b> , 1315	Swedish, <b>sv/swe</b> , 1922
Aymara, <b>ay/aym</b> , 0125	Hebrew, <b>iw/heb</b> , 0923	Nauru, <b>na/nau</b> , 1401	Tagalog, <b>tl/tgl</b> , 2012
Azerbaijani, <b>az/aze</b> , 0126	Hindi, <b>hi/hin</b> , 0809	Nepali, <b>ne/nep</b> , 1405	Tajik, <b>tg/tgk</b> , 2007
Bashkir, <b>ba/bak</b> , 0201	Hungarian, <b>hu/hun</b> , 0821	Norwegian, <b>no/nor</b> , 1415	Tamil, <b>ta/tam</b> , 2001
Basque, <b>eu/eus</b> , 0521	Icelandic, <b>is/isl</b> , 0919	Occitan, <b>oc/oci</b> , 1503	Tatar, <b>tt/tat</b> , 2020
Belarusian, <b>be/bel</b> , 0205	Indonesian, <b>in/ind</b> , 0914	Oriya, <b>or/ori</b> , 1518	Telugu, <b>te/tel</b> , 2005
Bengali, <b>bn/ben</b> , 0214	Interlingua, <b>ia/ina</b> , 0901	Oromo, <b>om/orm</b> , 1513	Thai, <b>th/tha</b> , 2008
Bihari, <b>bh/bih</b> , 0208	Interlingue, <b>ie/ile</b> , 0905	Panjabi, <b>pa/pan</b> , 1601	Tibetan, <b>bo/bod</b> , 0215
Bislama, <b>bi/bis</b> , 0209	Inupiaq, <b>ik/ikp</b> , 0911	Persian, <b>fa/fas</b> , 0601	Tigrinya, <b>ti/tir</b> , 2009
Breton, <b>br/bre</b> , 0218	Irish, <b>ga/gle</b> , 0701	Polish, <b>pl/pol</b> , 1612	Tonga (Tonga Islands), <b>to/ton</b> , 2015
Bulgarian, <b>bg/bul</b> , 0207	Italian, <b>it/ita</b> , 0920	Portuguese, <b>pt/por</b> , 1620	Tsonga, <b>ts/tso</b> , 2019
Burmese, <b>my/mya</b> , 1325	Japanese, <b>ja/jpn</b> , 1001	Pushto, <b>ps/pus</b> , 1619	Tswana, <b>tn/tsn</b> , 2014
Catalan, <b>ca/cat</b> , 0301	Javanese, <b>iw/jav</b> , 1023	Quechua, <b>qu/que</b> , 1721	Turkmen, <b>tk/tuk</b> , 2011
Central Khmer, <b>km/khm</b> , 1113	Kalaallisut, <b>kl/kal</b> , 1112	Romanian, <b>ro/ron</b> , 1815	Turkish, <b>tr/tur</b> , 2018
Chinese, <b>zh/zho</b> , 2608	Kannada, <b>kn/kan</b> , 1114	Romansch, <b>rm/roh</b> , 1813	Twi, <b>tw/twi</b> , 2020
Corsican, <b>co/cos</b> , 0315	Kashmiri, <b>ks/kas</b> , 1119	Rundi, <b>rn/run</b> , 1814	Ukrainian, <b>uk/ukr</b> , 2111
Croatian, <b>hr/hrv</b> , 0818	Kazakh, <b>kk/kaz</b> , 1111	Russian, <b>ru/rus</b> , 1821	Urdu, <b>ur/urd</b> , 2118
Czech, <b>cs/ces</b> , 0319	Kinyarwanda, <b>rw/kin</b> , 1823	Samoan, <b>sm/smo</b> , 1913	Uzbek, <b>uz/uzb</b> , 2126
Danish, <b>da/dan</b> , 0401	Kirghiz, <b>ky/kir</b> , 1125	Sango, <b>sg/sag</b> , 1907	Vietnamese, <b>vi/vie</b> , 2209
Dutch, <b>nl/nld</b> , 1412	Korean, <b>ko/kor</b> , 1115	Sanskrit, <b>sa/san</b> , 1901	Volapuk, <b>vo/vol</b> , 2215
Dzongkha, <b>dz/dzo</b> , 0426	Kurdish, <b>ku/kur</b> , 1121	Scottish Gaelic, <b>gd/gla</b> , 0704	Welsh, <b>cy/cym</b> , 0325
English, <b>en/eng</b> , 0514	Lao, <b>lo/lao</b> , 1215	Serbian, <b>sr/srp</b> , 1918	Western Frisian, <b>fy/fry</b> , 0625
Esperanto, <b>eo/epo</b> , 0515	Latin, <b>la/lat</b> , 1201	Serbo-Croatian, <b>sh/---</b> , 1908	Wolof, <b>wo/wol</b> , 2315
Estonian, <b>et/est</b> , 0520	Latvian, <b>lv/lav</b> , 1222	Shona, <b>sn/sna</b> , 1914	Xhosa, <b>xh/xho</b> , 2408
Finnish, <b>fi/fin</b> , 0609	Lingala, <b>ln/lin</b> , 1214	Sindhi, <b>sd/snd</b> , 1904	Yiddish, <b>ji/yid</b> , 1009
Fijian, <b>fj/fji</b> , 0610	Lithuanian, <b>lt/lit</b> , 1220	Sinhalese, <b>si/sin</b> , 1909	Yoruba, <b>yo/yor</b> , 2515
Faroese, <b>fo/fao</b> , 0615	Macedonian, <b>mk/mkd</b> , 1311	Slovak, <b>sk/slk</b> , 1911	Zulu, <b>zu/zul</b> , 2621

### ❖ Country/area code table

Country/Area name, Country/Area code, input code

Anguilla, <b>ai</b> , 0109	Estonia, <b>ee</b> , 0505	Luxembourg, <b>lu</b> , 1221	Slovakia, <b>sk</b> , 1911
Antigua and Barbuda, <b>ag</b> , 0107	Finland, <b>fi</b> , 0609	Macedonia, the Former	Slovenia, <b>si</b> , 1909
Argentina, <b>ar</b> , 0118	France, <b>fr</b> , 0618	Yugoslav Republic of, <b>mk</b> , 1311	Spain, <b>es</b> , 0519
Armenia, <b>am</b> , 0113	Georgia, <b>ge</b> , 0705	Malaysia, <b>my</b> , 1325	Suriname, <b>sr</b> , 1918
Australia, <b>au</b> , 0121	Germany, <b>de</b> , 0405	Malta, <b>mt</b> , 1320	Sweden, <b>se</b> , 1905
Austria, <b>at</b> , 0120	Greece, <b>gr</b> , 0718	Mexico, <b>mx</b> , 1324	Switzerland, <b>ch</b> , 0308
Azerbaijan, <b>az</b> , 0126	Greenland, <b>gl</b> , 0712	Moldova, Republic of, <b>md</b> , 1304	Taiwan, Province of China, <b>tw</b> , 2023
Bahamas, <b>bs</b> , 0219	Grenada, <b>gd</b> , 0704	Monaco, <b>mc</b> , 1303	Tajikistan, <b>tj</b> , 2010
Barbados, <b>bb</b> , 0202	Guyana, <b>gy</b> , 0725	Montserrat, <b>ms</b> , 1319	Thailand, <b>th</b> , 2008
Belarus, <b>by</b> , 0225	Haiti, <b>ht</b> , 0820	Netherlands, <b>nl</b> , 1412	Trinidad and Tobago, <b>tt</b> , 2020
Belgium, <b>be</b> , 0205	Hong Kong, <b>hk</b> , 0811	New Zealand, <b>nz</b> , 1426	Tunisia, <b>tn</b> , 2014
Belize, <b>bz</b> , 0226	Hungary, <b>hu</b> , 0821	Norway, <b>no</b> , 1415	Turkey, <b>tr</b> , 2018
Bermuda, <b>bm</b> , 0213	Iceland, <b>is</b> , 0919	Pakistan, <b>pk</b> , 1611	Turkmenistan, <b>tm</b> , 2013
Brazil, <b>br</b> , 0218	India, <b>in</b> , 0914	Peru, <b>pe</b> , 1605	Turks and Caicos Islands, <b>tc</b> , 2003
Bulgaria, <b>bg</b> , 0207	Indonesia, <b>id</b> , 0904	Philippines, <b>ph</b> , 1608	Ukraine, <b>ua</b> , 2101
Canada, <b>ca</b> , 0301	Ireland, <b>ie</b> , 0905	Poland, <b>pl</b> , 1612	United Kingdom, <b>gb</b> , 0702
Cayman Islands, <b>ky</b> , 1125	Israel, <b>il</b> , 0912	Portugal, <b>pt</b> , 1620	United States, <b>us</b> , 2119
Chile, <b>cl</b> , 0312	Italy, <b>it</b> , 0920	Puerto Rico, <b>pr</b> , 1618	Uruguay, <b>uy</b> , 2125
China, <b>cn</b> , 0314	Jamaica, <b>jm</b> , 1013	Romania, <b>ro</b> , 1815	Uzbekistan, <b>uz</b> , 2126
Colombia, <b>co</b> , 0315	Japan, <b>jp</b> , 1016	Russian Federation, <b>ru</b> , 1821	Venezuela, <b>ve</b> , 2205
Croatia, <b>hr</b> , 0818	Kazakhstan, <b>kz</b> , 1126	Saint Kitts and Nevis, <b>kn</b> , 1114	Virgin Islands, British, <b>vg</b> , 2207
Cyprus, <b>cy</b> , 0325	Korea, Republic of, <b>kr</b> , 1118	Saint Lucia, <b>lc</b> , 1203	
Czech Republic, <b>cz</b> , 0326	Kyrgyzstan, <b>kg</b> , 1107	Saint Vincent and the Grenadines, <b>vc</b> , 2203	
Denmark, <b>dk</b> , 0411	Latvia, <b>lv</b> , 1222	San Marino, <b>sm</b> , 1913	
Dominica, <b>dm</b> , 0413	Liechtenstein, <b>li</b> , 1209	Singapore, <b>sg</b> , 1907	
Dominican Republic, <b>do</b> , 0415	Lithuania, <b>lt</b> , 1220		

## Chapter 9

# Troubleshooting

Incorrect operation is often mistaken for trouble or malfunction. If you think that there is something wrong with this component, check the points below. Sometimes the trouble may lie in another component. Inspect the other components and electrical appliances being used. If the trouble cannot be rectified even after checking the points below, ask your nearest Pioneer authorized service center or your dealer to carry out repair work.

### Picture

Problem	Check	Remedy
No picture is displayed or the picture is not displayed properly.	Is the video cable properly connected?	<ul style="list-style-type: none"> <li>Connect the cable properly according to the connected devices (page 42).</li> <li>Disconnect the cable (video/audio cable or HDMI cable), then reinsert it firmly and all the way in.</li> </ul>
	Is the video cable damaged?	If the cable is damaged, replace it with a new one.
	Is the input setting on the connected TV right?	Read the operating instructions for the connected components and switch to the proper input.
	Is the output video resolution properly set?	Press <b>RESOLUTION</b> to switch the video resolution output from the <b>HDMI OUT</b> terminal (page 18).
	<ul style="list-style-type: none"> <li>Is the player connected with an HDMI cable other than a High Speed HDMI® cable (with a Standard HDMI® cable)?</li> <li>Are you using an HDMI cable with a built-in equalizer?</li> </ul>	1080p or Deep Color video signals may not be output properly, depending on the HDMI cable being used or the player's settings. If you wish to output the video signals with 1080p or Deep Color, connect the TV using a High Speed HDMI® cable without a built-in equalizer, then reset the player using the <b>Setup Navigator</b> (page 52).
No picture is displayed or picture is not output in high definition when playing BDs.	Is a DVI device connected?	The picture may not be displayed properly if a DVI device is connected.
	Is <b>Color Space</b> properly set?	Change the <b>Color Space</b> setting (page 77).
<ul style="list-style-type: none"> <li>Picture is disturbed during playback.</li> <li>Picture is dark.</li> </ul>		<ul style="list-style-type: none"> <li>With some discs, it may not be possible to output the video signals from the VIDEO output terminal. In this case, connect using an HDMI cable (page 42).</li> <li>This player supports Rovi analog copy protection technology. With some TVs (such as with built-in video deck), the picture will not be displayed properly when the copy protected DVD title is played. This is not a malfunction.</li> <li>If the player and TV are connected via a DVD recorder/video deck, etc., the picture will not be displayed properly due to analog copy protection. Connect the player and TV directly.</li> </ul>
	<ul style="list-style-type: none"> <li>Picture is stretched.</li> <li>Picture is cropped.</li> <li>Aspect ratio cannot be switched.</li> </ul>	Is the TV's aspect ratio properly set? Is <b>TV Screen</b> properly set?
Picture is interrupted.		The picture may be interrupted when the resolution of the recorded video signal switches. Press <b>RESOLUTION</b> to select a setting other than <b>Auto</b> (page 77).
Blu-ray 3D disc playback does not output 3D views.		<ul style="list-style-type: none"> <li>Connect the player to your TV with HDMI cable (High Speed HDMI™ Cable).</li> <li>Your TV may not support "HDMI 3D mandatory format".</li> </ul>



## Sound

Problem	Check	Remedy
<ul style="list-style-type: none"> <li>No sound is output.</li> <li>Sound is not output properly.</li> </ul>	<ul style="list-style-type: none"> <li>Is the disc played back in slow motion?</li> <li>Is the disc played back in fast forward or fast reverse?</li> </ul>	No sound is output during slow motion play and forward and reverse scanning.
	Are the cables properly connected?	<ul style="list-style-type: none"> <li>Connect the cable properly according to the connected devices (page 42).</li> <li>Insert the cable firmly and all the way in.</li> </ul>
	Is the audio cable damaged?	If the cable is damaged, replace it with a new one.
	Is <b>Audio Output</b> properly set?	Set Audio Output properly, according to the connected device (page 77).
Multi-channel sound is not output.	Are the connected components properly set?	Read the operating instructions for the connected components and check the volume, input, speaker settings, etc.
	Is multi-channel sound selected?	Use the menu screen or <b>AUDIO</b> to switch the disc's sound to multi-channel.
No sound from surround or center speaker.		<ul style="list-style-type: none"> <li>Check to confirm that the speakers are connected properly.</li> <li>Check the volume setting in the <b>Speaker Setup</b> for Audio Menu menu (page 77).</li> </ul>
No sound from the sub-woofer.		When the audio signal being played has no bass component, no sound will come from the sub-woofer. Check the volume setting in the <b>Speaker Setup</b> for Audio Menu (page 77).
Excessive noise during radio reception.		<ul style="list-style-type: none"> <li>Connect an antenna and set to the best reception position.</li> <li>Set an FM antenna outside the house.</li> <li>Turn power off the electric devices that may be causing the noise or move these devices away from this unit.</li> </ul>

## Playback

Problem	Check	Remedy
<ul style="list-style-type: none"> <li>Disc does not play.</li> <li>Disc tray opens automatically.</li> </ul>	Is the disc one that is playable on this player?	Check whether the disc is one that can be played on this player (page 11).
	Is the file one that is playable on this player?	<ul style="list-style-type: none"> <li>Check whether the file is one that can be played on this player (page 15).</li> <li>Check whether or not the file is damaged.</li> </ul>
	Is the disc scratched?	It may not be possible to play scratched discs.
	Is the disc dirty?	Clean the disc (page 94).
	Is there a piece of paper or sticker attached to the disc?	The disc may be warped and unplayable.
	Is the disc properly set in the disc tray?	<ul style="list-style-type: none"> <li>Set the disc with the printed side facing up.</li> <li>Set the disc properly in the depression in the disc tray.</li> </ul>
Picture freezes and the front panel and remote control buttons stop working.	Is the region number correct?	See page 13 for the region numbers of discs that can be played on this player.
		<ul style="list-style-type: none"> <li>Press <b>(■) STOP</b> to stop playback, then restart playback.</li> <li>If the playback cannot be stopped, press <b>⏻ STANDBY/ON</b> on the player's front panel to turn off the power, then turn the power back on.</li> <li>Press <b>⏻ STANDBY/ON</b> on the player for more than 5 seconds. The unit reboots, and the operation becomes possible.</li> </ul>
The subtitles cannot be switched.		The subtitles cannot be switched for discs recorded on a DVD or BD recorder.
After a disc is inserted, <b>Loading</b> stays displayed and playback does not start.	Are there too many files recorded on the disc?	When a disc on which files are recorded is inserted, depending on the number of files recorded on the disc, loading may take several dozen minutes.
<b>(■)</b> is displayed in file names, etc.		The characters that cannot be displayed on this player are displayed in <b>(■)</b> .
A message indicating low memory appears while playing a BD-ROM disc.		<ul style="list-style-type: none"> <li>Connect a USB device (page 51).</li> <li>Erase the data stored on the connected USB device from <b>BUDA Setup</b> (page 81).</li> </ul>

## Control function

Problem	Check	Remedy
Control function does not work.	Is the HDMI cable properly connected?	To use the Control function, connect the Flat Screen TV to the <b>HDMI OUT</b> terminal (page 42).
	Is the HDMI cable you are using a High Speed HDMI® Cable?	Use a High Speed HDMI® Cable. The Control function may not work properly if an HDMI cable other than a High Speed HDMI® Cable is used.
	Is this player connected to the TV using an HDMI cable to watch the picture?	If video signals are being output from a terminal other than the <b>HDMI OUT</b> terminal, the Control function does not work. Connect to the TV using an HDMI cable (page 42).
	Does the connected device support the Control function?	<ul style="list-style-type: none"> <li>The Control function will not work with devices of other brands that do not support the Control function, even when connected using an HDMI cable.</li> <li>The Control function will not work if devices that do not support the Control function are connected between the Control-compatible device and the player.</li> <li>See page 16.</li> <li>Even when connected to a Pioneer product compatible with the Control function, some of the functions may not work.</li> </ul> <p>Also refer to the operating instructions for the connected device.</p>
	Is Control set to On on the connected device?	<p>Set Control to On on the connected device. The Control function operates when Control is set to On for all devices connected to the <b>HDMI OUT</b> terminal.</p> <p>Once connections and settings of all the devices are finished, be sure to check that the player's picture is output to the Flat Screen TV. (Also, check after changing the connected devices and connecting and/or disconnecting HDMI cables.) If the player's picture is not being output to the Flat Screen TV, the Control function may not work properly.</p> <p>For details, refer to the operating instructions of the connected device.</p>

## Network

Problem	Check	Remedy
<ul style="list-style-type: none"> <li>BD-LIVE function (connection to the Internet) cannot be used.</li> <li>"No valid id file found!" is displayed when I try to update the software.</li> </ul>		<p>Perform <b>Connection Test</b> (page 81). If "Networks is OK." is displayed, check the proxy server settings (page 81). Also, there may be a problem with the Internet connection. Contact your Internet service provider.</p>
Software updating is slow.		Depending on the Internet connection and other conditions, some time may be required to update the software.
A message other than "Networks is OK." is displayed when <b>Connection Test</b> is performed.	Is "Network is FAILED." displayed?	<ul style="list-style-type: none"> <li>Check that this player and the Ethernet hub (or router with a hub functionality) are properly connected.</li> <li>If the IP address is obtained using the DHCP server function, check the setting is correct at the <b>Information</b> (page 78). For details on the DHCP server function, see the operating instructions for the Ethernet hub (or router with a hub functionality).</li> <li>Set the IP address manually.</li> <li>Check the operation and settings of the DHCP server function of the Ethernet hub (or router with hub functionality). For details on the DHCP server function, see the operating instructions for the Ethernet hub (or router with a hub functionality).</li> <li>If this player has been set manually, reset the IP address of this player or other components.</li> </ul>
	Is the Ethernet hub (or router with a hub functionality) operating properly?	<ul style="list-style-type: none"> <li>Check the settings and operation the Ethernet hub (or router with a hub functionality). For details, see the operating instructions for the Ethernet hub.</li> <li>Reboot the Ethernet hub (or router with a hub functionality).</li> </ul>

## Others

Problem	Check	Remedy
Power does not turned on.	Is the power cord properly connected?	<ul style="list-style-type: none"> <li>Plug the power cord securely into the power outlet.</li> <li>Unplug the power cord, wait several seconds, then plug the power cord back in.</li> </ul>
Power turns OFF without warning		<b>Auto Power Off</b> is set. The display will move to screen saver mode in 5 minutes and will automatically power OFF in about 30 minutes.
The player's power turns off automatically.	Is <b>Control</b> set to <b>On</b> ?	The player's power may turn off together with the power of the TV connected to the <b>HDMI OUT</b> terminal. If you do not want the player's power to turn off when the TV's power is turned off, set <b>Control</b> to <b>Off</b> (page 77).
The player's power turns on automatically.	Is <b>Control</b> set to <b>On</b> ?	The player's power may turn on together with the power of the TV connected to the <b>HDMI OUT</b> terminal. If you do not want the player's power to turn on when the TV's power is turned on, set <b>Control</b> to <b>Off</b> (page 77).
Cannot be operated with the remote control.	Are you operating the remote control from a point too far away from the player?	Operate from within 7 m of the remote control sensor.
	Are the batteries dead?	Replace the batteries (page 10).
Settings I have made have been cleared.	<ul style="list-style-type: none"> <li>Have you disconnected the power cord while the player's power was on?</li> <li>Has there been a power failure?</li> </ul>	Always press <b>STANDBY/ON</b> on the player's front panel or <b>STANDBY/ON</b> on the remote control, check that POWER OFF has turned off from the player's front panel display and wait for more than 10 seconds before disconnecting the power cord. Be particularly careful when the power cord is connected to the AC outlet on another device because the player turns off in conjunction with the device.
USB (external storage) device does not work with this player properly.	Is the USB device properly connected?	<ul style="list-style-type: none"> <li>Turn the player's power off, then turn the power back on.</li> <li>Turn the player's power off, then reconnect the external storage device (page 51).</li> </ul>
	Is the USB device connected via an extension cable?	Do not use an extension cable. The player may not work properly with it.
	Is the external storage device connected to the USB port via a memory card reader or <b>USB</b> hub?	External storage device may not work if connected to the <b>USB</b> port via a memory card reader or USB hub.
	Does the external storage device contain multiple partitions?	External storage devices may not be recognized if they contain multiple partitions.
		Some external storage devices may not operate.
	Is the external storage device write-protected?	Turn the player's power off, then disable the write-protection.
	Is the external storage device's file system FAT16 or FAT32?	Only external storage devices with a FAT16 or FAT32 file system can be used. Turn the player's power off, then turn the power back on.
Display window is dark		Press the <b>DIMMER</b> on the remote and select the desired display brightness.

## Chapter 10

# Appendix

## Specifications

General for HTZ-BD52/HTZ-BD32	
Power requirements	AC 120 V, 50 Hz/60 Hz
Power consumption	190 W (In Standby mode: Less than 0.5 W)
Dimensions (W x H x D)	Approx. 430 mm x 345 mm x 63 mm
Net Weight (Approx.)	3.4 kg
Operating temperature	5 °C to 35 °C
Operating humidity	5 % to 85 %

General for HTZ-BD92HW/HTZ-BD82HF	
Power requirements	AC 120 V, 50 Hz/60 Hz
Power consumption	105 W (In Standby mode: Less than 0.5 W)
Dimensions (W x H x D)	Approx. 430 mm x 345 mm x 63 mm
Net Weight (Approx.)	3.3 kg
Operating temperature	5 °C to 35 °C
Operating humidity	5 % to 85 %

Inputs/Outputs	
VIDEO OUT	1.0 V (p-p), 75 Ω, sync negative, RCA jack x 1
HDMI IN/OUT (video/audio)	19 pin (HDMI®/™ Connector)
ANALOG AUDIO IN	2.0 Vrms (1 kHz, 0 dB), 600 Ω, RCA jack (L, R) x 1
DIGITAL IN (OPTICAL)	3 V (p-p), Optical jack x 2 (48 kHz, 96 kHz sampling)
PORTABLE IN	0.5 Vrms (3.5 mm stereo jack)
ADAPTER PORT	5 V, 100 mA
MIC	Mic jack x 1
USB	4 pin A Type x 2

Tuner	
FM Tuning Range	87.5 MHz to 108.0 MHz
Antenna input	75 Ω unbalanced

Amplifier for HTZ-BD52/HTZ-BD32	
Power output (RMS) THD 30 %	
Total	1100 W
Front	170 W × 2 (4 Ω)
Center	250 W (3 Ω)
Rear	170 W × 2 (4 Ω)
Sub-Woofer	250 W (3 Ω)

Amplifier for HTZ-BD92HW/HTZ-BD82HF	
Power output (RMS) THD 30 %	
Total	550 W
Front	170 W × 2 (4 Ω)
Sub-Woofer	250 W (3 Ω)

System	
Laser	Semiconductor laser
Signal system	Standard PAL/NTSC colour TV system
LAN port	Ethernet jack x 1, 10BASE-T / 100BASE-TX
Wireless LAN (internal antenna)	Integrated IEEE 802.11n (2.4 GHz band) wireless networking access, compatible with 802.11b/g Wi-Fi networks.
Bus Power Supply (USB)	DC 5 V  500 mA

Speakers for HTZ-BD52			
S-BD422			
• Front (Left/ Right)			
Type	2 Way	Net Dimensions (W x H x D)	250 mm x 1110 mm x 250 mm
Impedance Rated	4 Ω	Net Weight	3.5 kg
• Surround speaker (Left/ Right)			
Type	1 Way	Net Dimensions (W x H x D)	250 mm x 1110 mm x 250 mm
Impedance Rated	4 Ω	Net Weight	3.4 kg
• Center speaker			
Type	1 Way	Net Dimensions (W x H x D)	230 mm x 80 mm x 90 mm
Impedance Rated	3 Ω	Net Weight	0.7 kg
• Subwoofer			
Type	1 Way	Net Dimensions (W x H x D)	130.5 mm x 420 mm x 375 mm
Impedance Rated	3 Ω	Net Weight	4.4 kg

Speakers for HTZ-BD32			
<b>S-BD122</b>			
• Front/Surround speaker (Left/ Right)			
Type	1 Way	Net Dimensions (W x H x D)	95 mm x 80 mm x 90 mm
Impedance Rated	4 Ω	Net Weight	0.3 kg
• Center speaker			
Type	1 Way	Net Dimensions (W x H x D)	230 mm x 80 mm x 90 mm
Impedance Rated	3 Ω	Net Weight	0.7 kg
• Subwoofer			
Type	1 Way	Net Dimensions (W x H x D)	130.5 mm x 420 mm x 375 mm
Impedance Rated	3 Ω	Net Weight	4.4 kg

Speakers for HTZ-BD92HW			
<b>S-BD922HW</b>			
• Front speaker			
Type	2 Way	Net Dimensions (W x H x D)	900 mm x 66 mm x 93 mm
Impedance Rated	4 Ω	Net Weight	1.6 kg
<b>S-BD922HW</b>			
• Subwoofer			
Type	1 Way	Net Dimensions (W x H x D)	130.5 mm x 420 mm x 375 mm
Impedance Rated	3 Ω	Net Weight	4.4 kg

Speakers for HTZ-BD82HF			
<b>S-BD822HF</b>			
• Front speaker (Left/ Right)			
Type	2 Way	Net Dimensions (W x H x D)	207 mm x 100 mm x 100 mm (lengthwise putting) 100 mm x 225 mm x 100 mm (side putting)
Impedance Rated	4 Ω	Net Weight	0.4 kg
• Subwoofer			
Type	1 Way	Net Dimensions (W x H x D)	130.5 mm x 420 mm x 375 mm
Impedance Rated	3 Ω	Net Weight	4.4 kg

- Design and specifications are subject to change without notice.

## Maintenance

### Handling the unit

#### When shipping the unit

Please save the original shipping carton and packing materials. If you need to ship the unit, for maximum protection, re-pack the unit as it was originally packed at the factory.

Keeping the exterior surfaces clean

- Do not use volatile liquids such as insecticide spray near the unit.
- Wiping with strong pressure may damage the surface.
- Do not leave rubber or plastic products in contact with the unit for a long period of time.

#### Cleaning the unit

To clean the player, use a soft, dry cloth. If the surfaces are extremely dirty, use a soft cloth lightly moistened with a mild detergent solution. Do not use strong solvents such as alcohol, benzine, or thinner, as these might damage the surface of the unit.

#### Maintaining the unit

The unit is a high-tech, precision device. If the optical pick-up lens and disc drive parts are dirty or worn, the picture quality could be diminished. For details, please contact your nearest authorized service center.

## Notes on discs

### Handling discs

Do not touch the playback side of the disc. Hold the disc by the edges so that fingerprints do not get on the surface. Never stick paper or tape on the disc.

### Storing discs

After playing, store the disc in its case. Do not expose the disc to direct sunlight or sources of heat and never leave it in a parked car exposed to direct sunlight.

### Cleaning discs

Fingerprints and dust on the disc can cause poor picture quality and sound distortion. Before playing, clean the disc with a clean cloth. Wipe the disc from the center to out.

Do not use strong solvents such as alcohol, benzine, thinner, commercially available cleaners, or anti-static spray intended for older vinyl records.

## Important Information Relating to Network Services

All information, data, documents, communications, downloads, files, text, images, photographs, graphics, videos, webcasts, publications, tools, resources, software, code, programs, applets, widgets, applications, products and other content ("Content") and all services and offerings ("Services") provided or made available by or through any third party (each a "Service Provider") is the sole responsibility of the Service Provider from whom it originated.

The availability of and access to Content and Services furnished by the Service Provider through the PIONEER Device are subject to change at any time, without prior notice, including, but not limited to the suspension, removal or cessation of all or any part of the Content or Services.

Should you have any inquiry or problem related to the Content or Services, you may refer to the Service Provider's website for the most up-to-date information. PIONEER is neither responsible nor liable for customer service related to the Content and Services. Any question or request for service relating to the Content or Services should be made directly to the respective Content and Service Providers.

Please note that PIONEER is not responsible for any Content or Services provided by the Service Provider or any changes to, removal of, or cessation of such Content or Services and does not warrant or guaranty the availability of or access to such Content or Services.



## Consignes de sécurité

Nous vous remercions d'avoir acquis un produit Pioneer.

Veuillez lire attentivement ce mode d'emploi afin de connaître la manière d'utiliser l'appareil comme il convient. Cela fait, conservez le mode d'emploi de façon à pouvoir vous y référer en cas de nécessité.

### IMPORTANT



Ce symbole de l'éclair, placé dans un triangle équilatéral, a pour but d'attirer l'attention de l'utilisateur sur la présence, à l'intérieur du coffret de l'appareil, de "tensions dangereuses" non isolées d'une grandeur suffisante pour représenter un risque d'électrocution pour les êtres humains.

### ATTENTION

DANGER D'ELECTROCUTION  
NE PAS OUVRIR

**ATTENTION :**  
POUR ÉVITER TOUT RISQUE D'ÉLECTROCUTION, NE PAS ENLEVER LE COUVERCLE (NI LE PANNEAU ARRIÈRE). AUCUNE PIÈCE RÉPARABLE PAR L'UTILISATEUR NE SE TROUVE À L'INTÉRIEUR. CONFIER TOUT ENTRETIEN À UN PERSONNEL QUALIFIÉ UNIQUEMENT.



Ce point d'exclamation, placé dans un triangle équilatéral, a pour but d'attirer l'attention de l'utilisateur sur la présence, dans les documents qui accompagnent l'appareil, d'explications importantes du point de vue de l'exploitation ou de l'entretien.

D3-4-2-1-1\_A1\_Fr

Lorsque vous utilisez ce produit, vérifiez les informations concernant la sécurité sous l'appareil.

D3-4-2-2-4\_B1\_Fr

### ATTENTION

Cet appareil est un produit laser de Classe 1, classé selon l'article IEC 60825-1:2007 relatif à la Sécurité des produits laser.

APPAREIL À LASER DE CLASSE 1

D58-5-2-2a\_A2\_Fr

### PRÉCAUTION DE VENTILATION

Lors de l'installation de l'appareil, veillez à laisser un espace suffisant autour de ses parois de manière à améliorer la dissipation de chaleur (au moins 10 cm sur le dessus, 10 cm à l'arrière et 10 cm de chaque côté).

### AVERTISSEMENT

Les fentes et ouvertures du coffret sont prévues pour la ventilation, pour assurer un fonctionnement stable de l'appareil et pour éviter sa surchauffe. Pour éviter les risques d'incendie, ne bouchez jamais les ouvertures et ne les recouvrez pas d'objets, tels que journaux, nappes ou rideaux, et n'utilisez pas l'appareil posé sur un tapis épais ou un lit.

D3-4-2-1-7b\*\_A1\_Fr

### AVERTISSEMENT

Cet appareil n'est pas étanche. Pour éviter les risques d'incendie et de décharge électrique, ne placez près de lui un récipient rempli d'eau, tel qu'un vase ou un pot de fleurs, et ne l'exposez pas à des gouttes d'eau, des éclaboussures, de la pluie ou de l'humidité.

D3-4-2-1-3\_A1\_Fr

### AVERTISSEMENT

Avant de brancher l'appareil pour la première, lisez attentivement la section suivante.

**La tension de l'alimentation électrique disponible varie selon le pays ou la région. Assurez-vous que la tension du secteur de la région où l'appareil sera utilisé correspond à la tension requise (par ex. 230 V ou 120 V), indiquée sur le panneau arrière.**

D3-4-2-1-4\*\_A1\_Fr

### Milieu de fonctionnement

Température et humidité du milieu de fonctionnement : De +5 °C à +35 °C (de +41 °F à +95 °F) ; Humidité relative inférieure à 85 % (orifices de ventilation non obstrués)

N'installez pas l'appareil dans un endroit mal ventilé ou un lieu soumis à une forte humidité ou en plein soleil (ou à une forte lumière artificielle).

D3-4-2-1-7c\*\_A1\_Fr

## CONSIGNES DE SÉCURITÉ IMPORTANTES

- 1) Lire attentivement ces instructions.
- 2) Conserver ces instructions.
- 3) Lire toutes les mises en garde.
- 4) Suivre toutes les instructions.
- 5) Ne pas utiliser cet appareil près d'une source d'eau.
- 6) Ne nettoyer qu'avec un chiffon sec.
- 7) Ne pas bloquer les événements d'aération. Installer l'appareil selon les instructions du fabricant.
- 8) Ne pas installer l'appareil près d'un appareil de chauffage tel qu'un radiateur, une résistance électrique, une cuisinière ou tout dispositif émettant de la chaleur (y compris un amplificateur).
- 9) Pour des raisons de sécurité, ne pas modifier la fiche polarisée ou celle de mise à la terre. Une fiche polarisée est une fiche à deux lames, dont une plus large que l'autre. Une fiche de mise à la terre est une fiche à deux lames avec une broche de masse. La lame plus large ou la broche de masse procure une protection accrue. Si ce genre de fiche ne peut être inséré dans une prise de courant, adressez-vous à un électricien pour faire remplacer la prise.
- 10) S'assurer que le cordon est placé à un endroit où il ne risque pas d'être piétiné ou coincé et faire particulièrement attention aux fiches et prises.
- 11) N'utiliser que les accessoires ou périphériques recommandés par le fabricant.
- 12) N'utiliser l'appareil qu'avec un chariot, meuble, trépied, support ou table recommandé par le fabricant ou vendu avec l'appareil. Si un chariot est utilisé, le déplacer avec le plus grand soin afin d'éviter de le renverser.
- 13) Débrancher cet appareil en cas d'orage ou s'il ne doit pas être utilisé pendant longtemps.
- 14) Confier l'appareil à un technicien qualifié pour toute réparation. Une réparation s'impose lorsque l'appareil a été endommagé, par exemple lorsque le cordon d'alimentation ou la fiche est endommagé, du liquide a été renversé ou un objet est tombé dans l'appareil, l'appareil a été exposé à la pluie ou à une humidité excessive, ou bien encore l'appareil fonctionne mal ou est tombé.



P1-42-2\_Fr

Cet appareil numérique de la Classe B est conforme à la norme NMB-003 du Canada.

D8-10-1-3\_A1\_Fr

Si la fiche d'alimentation secteur de cet appareil ne convient pas à la prise secteur à utiliser, la fiche doit être remplacée par une appropriée. Ce remplacement et la fixation d'une fiche secteur sur le cordon d'alimentation de cet appareil doivent être effectués par un personnel de service qualifié. En cas de branchement sur une prise secteur, la fiche de coupure peut provoquer une sérieuse décharge électrique. Assurez-vous qu'elle est éliminée correctement après sa dépose. L'appareil doit être déconnecté en débranchant sa fiche secteur au niveau de la prise murale si vous prévoyez une période prolongée de non utilisation (par exemple avant un départ en vacances).

D3-4-2-1a\_A1\_Fr

#### ATTENTION

L'interrupteur **⏻** **STANDBY/ON** de cet appareil ne coupe pas complètement celui-ci de sa prise secteur. Comme le cordon d'alimentation fait office de dispositif de déconnexion du secteur, il devra être débranché au niveau de la prise secteur pour que l'appareil soit complètement hors tension. Par conséquent, veillez à installer l'appareil de telle manière que son cordon d'alimentation puisse être facilement débranché de la prise secteur en cas d'accident. Pour éviter tout risque d'incendie, le cordon d'alimentation sera débranché au niveau de la prise secteur si vous prévoyez une période prolongée de non utilisation (par exemple avant un départ en vacances).

D3-4-2-2a\*\_A1\_Fr

#### Condensation

Si vous transportez sans transition le lecteur d'un endroit froid dans un pièce chaude (en hiver, par exemple), ou si la température de la pièce où se trouve le lecteur augmente rapidement, des gouttelettes d'eau (condensation) peuvent se former à l'intérieur du lecteur (sur les pièces et la lentille). En cas de condensation, le lecteur ne fonctionne pas correctement et la lecture n'est pas possible. Laissez le lecteur en service pendant 1 ou 2 heures à la température ambiante (pour que l'humidité ait le temps de s'évaporer). Les gouttelettes d'eau se dissiperont et la lecture sera de nouveau possible.

De la condensation peut aussi se former en été si le lecteur est exposé à l'air d'un climatiseur. Dans ce cas, éloignez le lecteur du climatiseur.

S005\_A1\_Fr

Ce produit est destiné à une utilisation domestique générale. Toute panne due à une utilisation autre qu'à des fins privées (comme une utilisation à des fins commerciales dans un restaurant, dans un autocar ou sur un bateau) et qui nécessite une réparation sera aux frais du client, même pendant la période de garantie.

K041\_A1\_Fr

#### NOTE IMPORTANTE SUR LE CABLE D'ALIMENTATION

Tenir le câble d'alimentation par la fiche. Ne pas débrancher la prise en tirant sur le câble et ne pas toucher le câble avec les mains mouillées. Cela risque de provoquer un court-circuit ou un choc électrique. Ne pas poser l'appareil ou un meuble sur le câble. Ne pas pincer le câble. Ne pas faire de noeud avec le câble ou l'attacher à d'autres câbles. Les câbles d'alimentation doivent être posés de façon à ne pas être écrasés. Un câble abîmé peut provoquer un risque d'incendie ou un choc électrique. Vérifier le câble d'alimentation de temps en temps. Contacter le service après-vente PIONEER le plus proche ou le revendeur pour un remplacement.

S002\*\_A1\_Fr

#### AVERTISSEMENT

Pour éviter les risques d'incendie, ne placez aucune flamme nue (telle qu'une bougie allumée) sur l'appareil.

D3-4-2-1-7a\_A1\_Fr

#### La protection de votre ouïe est entre vos mains

Pour assurer le rendement optimal de votre matériel et – plus important encore – la protection de votre ouïe, réglez le volume à un niveau raisonnable. Pour ne pas altérer votre sens de la perception, le son doit être clair mais ne produire aucun vacarme et être exempt de toute distorsion. Votre ouïe peut vous jouer des tours. Avec le temps, votre système auditif peut en effet s'adapter à des volumes supérieurs, et ce qui vous semble un « niveau de confort normal » pourrait au contraire être excessif et contribuer à endommager votre ouïe de façon permanente. Le réglage de votre matériel à un volume sécuritaire AVANT que votre ouïe s'adapte vous permettra de mieux vous protéger.

#### CHOISISSEZ UN VOLUME SÉCURITAIRE:

- Réglez d'abord le volume à un niveau inférieur.
- Montez progressivement le volume jusqu'à un niveau d'écoute confortable ; le son doit être clair et exempt de distorsions.
- Une fois que le son est à un niveau confortable, ne touchez plus au bouton du volume.

#### N'OUBLIEZ PAS DE RESPECTER LES DIRECTIVES SUIVANTES:

- Lorsque vous montez le volume, assurez-vous de pouvoir quand même entendre ce qui se passe autour de vous.
- Faites très attention ou cessez temporairement l'utilisation dans les situations pouvant s'avérer dangereuses.
- N'utilisez pas des écouteurs ou un casque d'écoute lorsque vous opérez un véhicule motorisé ; une telle utilisation peut créer des dangers sur la route et est illégale à de nombreux endroits.

S001a\_A1\_Fr



### AVERTISSEMENT

Toutes transformations ou modifications non expressément autorisées par l'autorité responsable de la conformité de l'appareil pourraient faire perdre à l'utilisateur son droit d'utiliser cet appareil.

**REMARQUE :** LE FABRICANT NE SAURA ÊTRE TENU RESPONSABLE DE TOUTE INTERFÉRENCE NUISIBLE AUX COMMUNICATIONS RADIO ET/OU TÉLÉVISION PROVOQUÉE PAR TOUTE MODIFICATION NON AUTORISÉE APPORTÉE À CET APPAREIL. DE TELLES MODIFICATIONS POURRAIENT ANNULER LE DROIT DE L'UTILISATEUR D'UTILISER L'APPAREIL.

### Avertissement FCC

Cet appareil est conforme à la section 15 de la réglementation FCC. Le fonctionnement est soumis aux deux conditions suivantes : (1) cet appareil ne peut causer d'interférences nuisibles et (2) il doit accepter toute interférence reçue, notamment celles pouvant entraîner un dysfonctionnement.

### Déclaration de la FCC sur l'exposition aux rayonnements RF

Cet appareil est conforme aux réglementations de la FCC sur les limites d'exposition aux rayonnements électromagnétiques établies pour un environnement non contrôlé. Cet appareil et son ou ses antennes ne doivent pas être installés ou utilisés conjointement avec une autre antenne ou un autre émetteur.

"Pour respecter les exigences d'exposition aux rayonnements RF de la FCC, cet accord n'est applicable qu'aux configurations mobiles. Les antennes utilisées pour cet émetteur doivent être installées de manière à offrir une distance de séparation d'au moins 20 cm de toutes personnes et ne doivent pas être situées ni fonctionner en conjonction avec une autre antenne ou un autre émetteur."



### Avertissement de l'agence Industrie Canada

Cet appareil est conforme aux normes RSS exemptes de licence d'Industrie Canada. Le fonctionnement est soumis aux deux conditions suivantes : (1) cet appareil ne peut causer d'interférences nuisibles et (2) il doit accepter toute interférence reçue, notamment celles pouvant entraîner un dysfonctionnement de l'appareil.

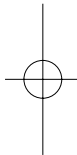

### Précautions concernant le visionnage en 3D

- **Si vous ressentez une fatigue ou une gêne pendant le visionnage d'images en 3D, cessez de les regarder.**
- **Les enfants, en particulier ceux de moins de 6 ans, sont plus sensibles à la fatigue et les personnes en charge doivent surveiller tout signe de fatigue ou de gêne.**
- **Pendant le visionnage d'images en 3D, faites régulièrement des pauses.**

Le visionnage prolongé d'images en 3D sans pause peut causer de la fatigue et un inconfort.



## Información de seguridad

Le damos las gracias por la adquisición de este producto Pioneer.

Lea a fondo estas instrucciones de utilización para que aprenda a utilizar correctamente su modelo.

Después de haber terminado de leer estas instrucciones, guárdelas en un lugar seguro para, en caso de ser necesario, consultarlas en el futuro.

### IMPORTANTE



La luz intermitente con el símbolo de punta de flecha dentro un triángulo equilátero. Está convenido para avisar al usuario de la presencia de "voltaje peligrosa" no aislada dentro el producto que podría constituir un peligro de choque eléctrico para las personas.



**ATENCIÓN:**  
PARA PREVENIR EL PELIGRO DE CHOQUE ELÉCTRICO NO REMOVER LA TAPA NI LAS PARTES DENTRO NO UTILIZADAS, LLAMAR UNA PERSONA CUALIFICADA.



El punto exclamativo dentro un triángulo equilátero convenido para avisar el usuario de la presencia de importantes instrucciones sobre el funcionamiento y la manutención en la libreta que acompaña el aparato.

D3-4-2-1-1\_A1\_Es

Cuando utilice este producto, confirme la información de seguridad mostrada en la parte inferior de la unidad.

D3-4-2-2-4\_B1\_Es

### PRECAUCIÓN

Este aparato es un producto de láser de clase 1 clasificado como tal en Seguridad de productos de láser, IEC 60825-1:2007.

PRODUCTO LASER CLASE 1

D58-5-2-2a\_A1\_Es

### PRECAUCIÓN PARA LA VENTILACIÓN

Cuando instale este aparato, asegúrese de dejar espacio en torno al mismo para la ventilación con el fin de mejorar la disipación de calor (por lo menos 10 cm encima, 10 cm detrás, y 10 cm en cada lado).

### ADVERTENCIA

Las ranuras y aberturas de la caja del aparato sirven para su ventilación para poder asegurar un funcionamiento fiable del aparato y para protegerlo contra sobrecalentamiento. Para evitar el peligro de incendio, las aberturas nunca deberán taparse ni cubrirse con nada (como por ejemplo, periódicos, manteles, cortinas) ni ponerse en funcionamiento el aparato sobre una alfombra gruesas o una cama.

D3-4-2-1-7b\*\_A1\_Es

### ADVERTENCIA

Este aparato no es impermeable. Para evitar el riesgo de incendio y de descargas eléctricas, no ponga ningún recipiente lleno de líquido (como pueda ser un vaso o un florero) cerca del aparato ni lo exponga a goteo, salpicaduras, lluvia o humedad.

D3-4-2-1-3\_A1\_Es

### ADVERTENCIA

Antes de enchufar el aparato a la corriente, lea la sección siguiente con mucha atención.

**La tensión de la red eléctrica es distinta según el país o región. Asegúrese de que la tensión de la alimentación de la localidad donde se proponga utilizar este aparato corresponda a la tensión necesaria (es decir, 230 V ó 120 V) indicada en el panel posterior.**

D3-4-2-1-4\*\_A1\_Es

### Entorno de funcionamiento

Temperatura y humedad del entorno de funcionamiento +5 °C a +35 °C; menos del 85 % de humedad relativa (rejillas de refrigeración no obstruidas)

No instale este aparato en un lugar mal ventilado, ni en lugares expuestos a alta humedad o a la luz directa del sol (o de otra luz artificial potente).

D3-4-2-1-7c\*\_A1\_Es

Si la clavija del cable de alimentación de CA de este aparato no se adapta a la toma de corriente de CA que usted desea utilizar, deberá cambiar la clavija por otra que se adapte apropiadamente. El reemplazo y montaje de una clavija del cable de alimentación de CA sólo deberá realizarlos personal de servicio técnico cualificado. Si se enchufa la clavija cortada a una toma de corriente de CA, puede causar fuertes descargas eléctricas. Asegúrese de que se tira de la forma apropiada después de haberla extraído. El aparato deberá desconectarse desenchufando la clavija de la alimentación de la toma de corriente cuando no se proponga utilizarlo durante mucho tiempo (por ejemplo, antes de irse de vacaciones).

D3-4-2-1a\_A1\_Es

#### PRECAUCIÓN

El interruptor de la alimentación **STANDBY/ON** de este aparato no corta por completo toda la alimentación de la toma de corriente de CA. Puesto que el cable de alimentación hace las funciones de dispositivo de desconexión de la corriente para el aparato, para desconectar toda la alimentación del aparato deberá desenchufar el cable de la toma de corriente de CA. Por lo tanto, asegúrese de instalar el aparato de modo que el cable de alimentación pueda desenchufarse con facilidad de la toma de corriente de CA en caso de un accidente. Para evitar correr el peligro de incendio, el cable de alimentación también deberá desenchufarse de la toma de corriente de CA cuando no se tenga la intención de utilizarlo durante mucho tiempo seguido (por ejemplo, antes de irse de vacaciones).

D3-4-2-2a\*\_A1\_Es

#### ADVERTENCIA

Para evitar el peligro de incendio, no ponga nada con fuego encendido (como pueda ser una vela) encima del aparato.

D3-4-2-1-7a\_A1\_Es

#### Entorno de funcionamiento

Temperatura y humedad del entorno de funcionamiento +5 °C a +35 °C; menos del 85 % de humedad relativa (rejillas de refrigeración no obstruidas)

No instale este aparato en un lugar mal ventilado, ni en lugares expuestos a alta humedad o a la luz directa del sol (o de otra luz artificial potente).

D3-4-2-1-7c\*\_A1\_Es

Este producto es para tareas domésticas generales. Cualquiera avería debida a otra utilización que tareas domésticas (tales como el uso a largo plazo para motivos de negocios en un restaurante o el uso en un coche o un barco) y que necesita una reparación hará que cobraría incluso durante el período de garantía.

K041\_A1\_Es

#### PRECAUCIONES CONCERNIENTES A LA MANIPULACIÓN DEL CABLE DE ALIMENTACIÓN

Tome el cable de alimentación por la clavija. No extraiga la clavija tirando del cable. Nunca toque el cable de alimentación cuando sus manos estén mojadas, ya que esto podría causar cortocircuitos o descargas eléctricas. No coloque la unidad, algún mueble, etc., sobre el cable de alimentación.

Asegúrese de no hacer nudos en el cable ni de unirlo a otros cables. Los cables de alimentación deberán ser dispuestos de tal forma que la probabilidad de que sean pisados sea mínima. Una cable de alimentación dañado podrá causar incendios o descargas eléctricas. Revise el cable de alimentación está dañado, solicite el reemplazo del mismo al centro de servicio autorizado PIONEER más cercano, o a su distribuidor.

S002\*\_A1\_Es

### PRECAUCIÓN

Los cambios o modificaciones no aprobados expresamente por la parte responsable de la conformidad del equipo podrían anular el derecho del usuario a hacerlo funcionar.

**NOTA:** EL FABRICANTE NO SE HACE RESPONSABLE DE NINGUNA INTERFERENCIA DE RADIO O TELEVISIÓN CAUSADA POR MODIFICACIONES NO AUTORIZADAS REALIZADAS EN ESTE EQUIPO. DICHAS MODIFICACIONES PODRÍAN ANULAR EL DERECHO DEL USUARIO A HACER FUNCIONAR EL EQUIPO.

### Advertencia de la Comisión Federal de Comunicaciones (CFC)

Este dispositivo cumple con la Sección 15 de las Normas de la Comisión Federal de Comunicaciones (CFC). Su funcionamiento está sujeto a las dos condiciones siguientes: (1) que no cause interferencias perjudiciales; y (2) que acepte cualquier interferencia recibida, incluyendo interferencias que puedan causar un funcionamiento no deseado.

### Declaración de cumplimiento con las disposiciones sobre exposición a la radiación de radiofrecuencias establecidas por la Comisión Federal de Comunicaciones (CFC)

Este equipo cumple con los límites de exposición a la radiación de radiofrecuencias establecidos por la CFC para un entorno no controlado. Este dispositivo y su antena no deberán colocarse ni utilizarse junto con ninguna otra antena ni transmisor.

"Para cumplir con las disposiciones sobre exposición a la radiación establecidas por la CFC, esta autorización solo será aplicable a las Configuraciones Móviles. Las antenas utilizadas para este transmisor deberán instalarse a una distancia de por lo menos 20 cm con respecto a todas las personas, no pudiendo situarse ni hacerse funcionar junto con otras antenas ni transmisores."

### Advertencia del Departamento de Industria de Canadá

Este dispositivo cumple con las normas RSS de exención de licencia del Departamento de Industria de Canadá. Su uso está sujeto al cumplimiento de las dos condiciones siguientes: (1) que no cause interferencias; y (2) que acepte cualquier interferencia, incluyendo aquellas que puedan provocar un funcionamiento no deseado de este dispositivo.

#### Advertencias para la visión 3D

- Si nota cualquier fatiga o malestar mientras está viendo imágenes 3D, deje de verlas.
- Los niños, particularmente los menores de 6 años, puede que sean más propensos a la sensibilidad, así que las personas que los tengan a su cargo deberán observarlos por si muestran cualquier señal de fatiga o malestar.
- Cuando esté viendo imágenes 3D, descanse periódicamente.  
La visión prolongada de imágenes 3D sin ningún descanso podría causar fatiga o malestar.

To register your product, find the nearest authorized service location, to purchase replacement parts, operating instructions, or accessories, please go to one of following URLs :

Pour enregistrer votre produit, trouver le service après-vente agréé le plus proche et pour acheter des pièces de rechange, des modes d'emploi ou des accessoires, reportez-vous aux URL suivantes :

**In the USA/Aux Etats-Unis**

<http://www.pioneerelectronics.com>

**In Canada/Aux Canada**

<http://www.pioneerelectronics.ca>

5018\_B1\_EnFr

© 2012 PIONEER CORPORATION.  
All rights reserved.

© 2012 PIONEER CORPORATION.  
Tous droits de reproduction et de  
traduction réservés.

---

**PIONEER CORPORATION**

1-1, Shin-ogura, Saiwai-ku, Kawasaki-shi, Kanagawa 212-0031, Japan

**PIONEER ELECTRONICS (USA) INC.**

P.O. BOX 1540, Long Beach, California 90801-1540, U.S.A. TEL: (800) 421-1404

**PIONEER ELECTRONICS OF CANADA, INC.**

340 Ferrier Street, Unit 2, Markham, Ontario L3R 2Z5, Canada TEL: 1-877-283-5901, 905-479-4411

**PIONEER EUROPE NV**

Haven 1087, Keetberglaan 1, B-9120 Melsele, Belgium TEL: 03/570.05.11

**PIONEER ELECTRONICS ASIACENTRE PTE. LTD.**

253 Alexandra Road, #04-01, Singapore 159936 TEL: 65-6472-7555

**PIONEER ELECTRONICS AUSTRALIA PTY. LTD.**

5 Arco Lane, Heatherton, Victoria, 3202, Australia, TEL: (03) 9586-6300

**PIONEER ELECTRONICS DE MEXICO S.A. DE C.V.**

Blvd.Manuel Avila Camacho 138 10 piso Col.Lomas de Chapultepec, Mexico, D.F. 11000 TEL: 55-9178-4270

K002\_B3\_En

Printed in China / Imprimé en Chine