

Table of Contents

1. Your Device1
 1.1 Appearance illustration1
 1.2 Home Screen2
 1.3 Apps and widgets.....4
 1.4 Basic Operation.....5
2. Settings8
 2.1 Device.....8
 2.2 Personal8
 2.3 System8
3. Recovery9
4. Safety Information11



This device meets applicable national SAR limits of 2.0 W/kg in EU and 1.6W/Kg in US .
The specific maximum SAR values can be found on page 17 of this user guide. When carrying the device or using it while worn on your body, either use an approved accessory such as a holster or otherwise maintain directly to the body to ensure compliance with RF exposure requirements. Note that the product may be transmitting even if you are not using it.

PROTECT YOUR HEARING



To prevent possible hearing damage, do not listen at high volume levels for long periods. Exercise caution when holding your device near your ear while the loudspeaker is in use.

1. Your device

1.1 Appearance illustration

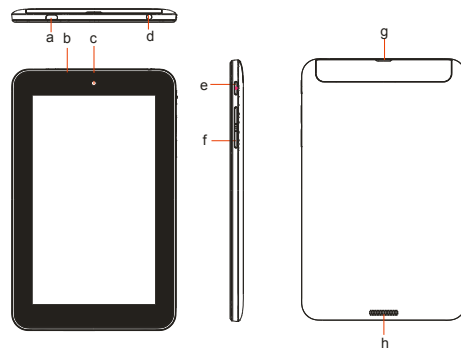

- a. Micro USB connector/ Battery charge interface
- b. Micro phone
- c. Front camera
- d. Earphone interface
- e. Power key
- f. Volume Up/Down
- g. SD card slot
- h. Built-in speaker

Note:

Please charge before first use. Normally, long press the Power key will power the pad on and the Home Screen will show up, but a battery icon will show instead of the Home Screen when the pad is

lack of power, that indicates you should charge before use. Use only charger recommended by TCT Mobile Limited and its affiliates.



1.2 Home screen

Your device includes five pages of Home screen giving you more space to add your own favorite apps, folders, and widgets for one-touch access. To switch between screens, sliding your finger to left or right.

- Lock/Unlock your screen

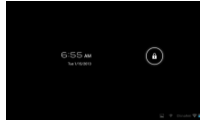







Once your device is powered on, it shows a locked screen interface, which is set as default.



Touch the locked icon, then a circle will show around it.

Touch and hold the locked icon , drag it to the lock icon at the right of the circle, home screen is unlocked.

- Icons on your screen



Icon	Name	Description
	Google search	Touch it to access the Google search engine.
	Voice actions	Use Voice Actions to watch a video, send email, set alarm, get directions, etc.
	All apps	Touch to show all apps list interface.
	Back	Go back to the previous menu or screen.
	Home	Return to the home screen.
	Background program	Press to view background program list.
	Wi-Fi	Press to view Wi-Fi connection.

On the right of the screen bottom, there is a notification bar . Hidden menus will popup when you press the bar, which includes time, date, network connection and battery information, etc. For further operation, you can press  setting.

1.3 Apps and widgets

- Apps

The Applications (apps) list contains all pre-embedded and newly installed apps. To access the apps list, touch the all apps key  from Home screen.

- Widgets

Touch the Widgets tab at the top of all apps screen or slide left at All apps screen, you can switch to widgets interface.

- Get more apps

Touch the Google play store icon  to get more apps.



- Create and manage shortcut on desktop

Touch and hold an icon on All Apps or widgets interface, it will jump to home screen automatically, drag it to the right place you want. Overlap icons together will build a folder. You can name the folder by touching the tap under the icons.

- Remove apps icon from desktop

Touch and hold the icon you want to delete from the desktop, drag it right over the "", which appears right in the middle of the screen top.

- Uninstall apps

Press  to enter all Apps, then touch and hold the Apps icon you want to uninstall, drag it over the , which appears top-left in the desktop.

1.4 Basic Operation

- Power on your device

Long press the Power key until the pad powers on. It will take some seconds before the screen lights up.

- Power off your device

1. Long press the Power key about 3 seconds until the options appear, select OK to power off your device.

2. Long press the Power key about 10 seconds to shut down your device.

- Stand-by mode

Press Power key once to shut down the screen and the product enters stand-by mode.

Note: without operation, the product will enter stand-by mode automatically. Press Power key once to wake it up.

- Reset your device

When your device is out of function,

1. You can press power button and volume up at the same time to enter Recovery screen to restart the device (Referring to Page 9).

2. Long press the Power key about 10 seconds to shut down your device.

Then press the Power key to restart.

- Connect to a computer via USB

When connecting your device to computer by USB, Select Setting\Storage\ 

 turn on USB storage, you can transfer files between your device and the computer.

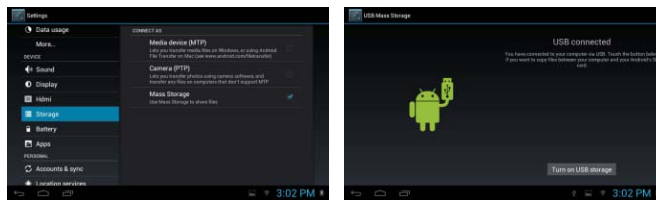

Note: files copied to pad are not available until USB data cable is disconnected with PC completely.

- Change your wallpaper

You can change your wallpaper in two different ways: touch & hold any space on home screen, select a wallpaper source from Gallery, Live Wallpapers or Wallpapers, touch a picture, select OK at the top of the screen (for Gallery images) or Set wallpaper; For another way is following the steps Settings > DEVICE > Display > Wallpaper.

Wi-Fi

To turn Wi-Fi on and connect to a wireless network

- . Touch Application tab from the Home screen.
- . Select Settings\Wireless & networks\Wi-Fi.
- . Mark/Unmark the checkbox to turn on/off Wi-Fi.

. Touch Wi-Fi. The detailed information of any detected Wi-Fi networks are displayed in the Wi-Fi networks section.

. Touch a Wi-Fi network to connect. If the network you selected is secured, you are required to enter a password or other credentials (You may need to contact the network operator for details). When finished, touch Connect.

Tips: To extend the battery life, turn off Wi-Fi when you're not using it.

Zoom in/out

Draw your fingers together/apart to zoom in/out (Web browser, Gallery etc...)

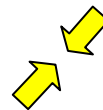
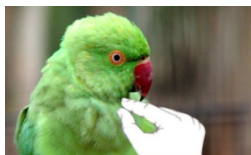

2 Settings

2.1 Device

2.1.1 Sound

You can set Volumes, Touch sounds and Screen lock sound to your preference with the Volume up/down key, or touch Settings\DEVICE\Sound.

2.1.2 Display

Touch settings> DEVICE >Display, you can see the items:

Brightness: adjust your screen in a comfortable brightness

Wallpaper: set your wallpaper

Auto-rotate screen: mark the checkbox, to enable or disable auto-rotation

Sleep: set Screensavers time

Font size: select a suitable font size for your tablet

2.1.3 Storage

Touch Settings> DEVICE >Storage to view the memory using status.

2.1.4 Battery

Touch Settings> DEVICE >battery to check the battery power and its service status.

2.2 Personal

Language & input

Touch Settings>PERSONAL>Language & input to view or set system language and input methods.

Language: set the system language

Keyboard & input methods: check and select all the input methods installed in the pad

2.3 System

2.3.1 Date & time

Touch Settings>SYSTEM>Date & time, to set date, time and format.

2.3.2 About tablet

Touch Settings>SYSTEM>About tablet to check legal information, tablet status and software version, etc.

2.3.3 Backup & reset

You can back up settings and other data associated with one or more of your Google Accounts. If you need to replace or factory reset your device, you can restore your data for any accounts that were previously backed up.

Touch Settings\PERSONAL\Backup & reset

Tips: please make sure that all the important data have been backed-up before you run factory data reset, for this function will eraser all apps and data that user installed; and remaining the battery is more than 50%.

3.Recovery

Recovery operation procedures

- 1) In power-off status, press and hold down the Vol+ key, then long press the Power key to enter the recovery mode.The system will show a screen containing a robot and a red triangle with an exclamation mark inside.
- 2) In Recovery mode, you can use Vol+/- key to scroll through the options, then press Power key to enter.



Recovery options:

Options	Descriptions
Reboot system now	Restart up the system.
Apply update from SD card	Update the system from the local SD card.
Wipe data/factory reset	Clear all data/ restore the factory default settings.
Wipe cache partition	Clear all CACHE partitions.
Recovery system from backup	Recover the system from the backup files.
Update rk image from SD card	Update the system (image) from local SD card.

Note:

Wipe data / factory reset

will erase all your personal information and downloaded apps (not includeSD card files and current system software).

SATEFY INFORMATION

We recommend that you read this chapter carefully before using your device. The manufacturer disclaims any liability for damage, which may result as a consequence of improper use or use contrary to the instructions contained herein.

- **TRAFFIC SAFETY**

Given that studies show that using a device while driving a vehicle constitutes a real risk, even when the hands-free kit is used (car kit, headset...), drivers are requested to refrain from using their device when the vehicle is not parked.

When driving, do not use your device or headphone to listen to music or to the radio. Using a headphone can be dangerous and forbidden in some areas. When switched on, your device emits electromagnetic waves that can interfere with the vehicle's electronic systems such as ABS anti-lock brakes or airbags. To ensure that there is no problem:

- Do not place your device on top of the dashboard or within an airbag deployment area,
- Check with your car dealer or the car manufacturer to make sure that the dashboard is adequately shielded from device RF energy.

- **CONDITIONS OF USE**

You are advised to switch off the device from time to time to optimize its performance.

Switch the device off before boarding an aircraft.

Switch the device off when you are in healthcare facilities, except in designated areas. As with many other types of equipment now in regular use, these devices can interfere with other electrical or electronic devices, or equipment using radio frequencies.

Switch the device off when you are near gas or flammable liquids. Strictly obey all signs and instructions posted in a fuel depot, petrol station, or chemical plant, or in any potentially explosive atmosphere.

When the device is switched on, it should be kept at least 15 cm from any medical device such as a pacemaker, a hearing aid or insulin pump, etc. In particular when using the device, you should hold it against the ear on the opposite side to the device, if any.

To avoid hearing impairment, move the handset away from your ear while using the "hands-free" mode because the amplified volume might cause hearing damage.

Do not let children use the device and/or play with the device and accessories without supervision.

When replacing the cover please note that your device may contain substances that could create an allergic reaction.

Always handle your device with care and keep it in a clean and dust-free place.

Do not allow your device to be exposed to adverse weather or environmental conditions (moisture, humidity, rain, infiltration of liquids, dust, sea air, etc.). The manufacturer's recommended operating temperature range is -0°C to +45°C.

At over 45°C the legibility of the device's display may be impaired, though this is temporary and not serious.

Do not open, dismantle or attempt to repair your device yourself.
Do not drop, throw or bend your device.
Do not use the device if the glass made screen is damaged, cracked or broken to avoid any injury.
Do not paint it.
Use only battery chargers and accessories which are recommended by TCT Mobile Limited and its affiliates and are compatible with your device model. TCT Mobile Limited and its affiliates disclaim any liability for damage caused by the use of other chargers or accessories.
Remember to make back-up copies or keep a written record of all important information stored in your device.
Some people may suffer epileptic seizures or blackouts when exposed to flashing lights, or when playing video games. These seizures or blackouts may occur even if a person never had a previous seizure or blackout. If you have experienced seizures or blackouts, or if you have a family history of such occurrences, please consult your doctor before playing video games on your device or enabling a flashing-lights feature on your device.
Parents should monitor their children's use of video games or other features that incorporate flashing lights on the device. All persons should discontinue use and consult a doctor if any of the following symptoms occur: convulsion, eye or muscle twitching, loss of awareness, involuntary movements, or disorientation. To limit the likelihood of such symptoms, please take the following safety precautions:
- Do not play or use a flashing-lights feature if you are tired or need sleep.
- Take a minimum of a 15-minute break hourly.

- Play in a room in which all lights are on.
- Play at the farthest distance possible from the screen.
- If your hands, wrists, or arms become tired or sore while playing, stop and rest for several hours before playing again.
- If you continue to have sore hands, wrists, or arms during or after playing, stop the game and see a doctor.

When you play games on your device, you may experience occasional discomfort in your hands, arms, shoulders, neck, or other parts of your body. Follow the instructions to avoid problems such as tendinitis, carpal tunnel syndrome, or other musculoskeletal disorders.

- **PRIVACY**

Please note that you must respect the laws and regulations in force in your jurisdiction or other jurisdiction(s) where you will use your device phone regarding taking photographs and recording sounds with your device. Pursuant to such laws and regulations, it may be strictly forbidden to take photographs and/or to record the voices of other people or any of their personal attributes, and duplicate or distribute them, as this may be considered to be an invasion of privacy. It is the user's sole responsibility to ensure that prior authorization be obtained, if necessary, in order to record private or confidential conversations or take a photograph of another person; the manufacturer, the seller or vendor of your device (including the operator) disclaim any liability which may result from the improper use of the device.

- **BATTERY**

There is an inner battery in this device. Observe the following precautions for battery use:

- Please do not attempt to open the cover and pick up the battery.

This battery must be disposed of in accordance with locally applicable environment regulations.



This symbol on your device, the battery and the accessories means that these products must be taken to collection points at the end of their life:

- Municipal waste disposal centers with specific bins for these items of equipment.
- Collection bins at points of sale.

They will then be recycled, preventing substances being disposed of in the environment, so that their components can be reused.

In European Union countries:

These collection points are accessible free of charge.

All products with this sign must be brought to these collection points.

In non-European Union jurisdictions:

Items of equipment with this symbol are not to be thrown into ordinary bins if your jurisdiction or your region has suitable recycling and collection facilities; instead they are to be taken to collection points for them to be recycled.

- **CHARGERS**

Mains powered chargers will operate within the temperature range of: 0°C to 40°C.

The chargers designed for your device meet with the standard for safety of information technology equipment and office equipment use. They are also compliant to the eco design directive 2009/125/EC. Due to different applicable electrical specifications, a charger you purchased in one jurisdiction may not work in another jurisdiction. They should be used for this purpose only.

- **RADIO WAVES**

THIS DEVICE MEETS INTERNATIONAL GUIDELINES FOR EXPOSURE TO RADIO WAVES

Your device is a radio transmitter and receiver. It is designed not to exceed the limits for exposure to radio waves (radio frequency electromagnetic fields) recommended by international guidelines. The guidelines were developed by an independent scientific organization (ICNIRP) and include a substantial safety margin designed to assure the safety of all persons, regardless of age and health. The radio wave exposure guidelines use a unit of measurement known as the Specific Absorption Rate, or SAR. The SAR limit for mobile devices is 2 W/kg in EU and 1.6W/Kg in US.

Tests for SAR are conducted using standard operating positions with the device transmitting at its highest certified power level in all tested frequency bands. The highest SAR values under the ICNIRP guidelines for this device model are:

Maximum SAR for this model and conditions under which it was recorded:

Maximum SAR for this model and conditions under which it was recorded:
--

Wi-Fi	0.351W/kg.
-------	------------

During use, the actual SAR values for this device are usually well below the values stated above. This is because, for purposes of system efficiency and to minimize interference on the network, the operating power of your device is automatically decreased when full power is not needed. The lower the power output of the device, the lower its SAR value.

Body-worn SAR testing has been carried out with the device directly touch with body. To meet RF exposure guidelines during body-worn operation, the device should be positioned at least this distance away from the body.

If you are not using an approved accessory ensure that whatever product is used is free of any metal and that it positions the device the indicated distance away from the body.

Organizations such as the World Health Organization and the US Food and Drug Administration have suggested that if people are concerned and want to reduce their exposure they could use a hands-free accessory to keep the wireless device away from the head or body during use, or reduce the amount of time spent on the device.

- **FCC Statement**

This device complies with part 15 of the FCC rules. Operation is subject to the following two conditions: (1) this device may not cause harmful interference, and (2) this device must accept any interference received, including interference that may cause undesired operation.

NOTE: The manufacturer is not responsible for any radio or TV interference caused by unauthorized modifications to this equipment. Such modifications could void the user's authority to operate the equipment.

NOTE: This equipment has been tested and found to comply with the limits for a Class B digital device, pursuant to part 15 of the FCC Rules. These limits are designed to provide reasonable protection against harmful interference in a residential installation. This equipment generates uses and can radiate radio frequency energy and, if not installed and used in accordance with the instructions, may cause harmful interference to radio communications. However, there is no guarantee that interference will not occur in a particular installation. If this equipment does cause harmful interference to radio or television reception, which can be determined by turning the equipment off and on, the user is encouraged to try to correct the interference by one or more of the following measures:

- Reorient or relocate the receiving antenna.
- Increase the separation between the equipment and receiver.

-Connect the equipment into an outlet on a circuit different from that to which the receiver is connected.

-Consult the dealer or an experienced radio/TV technician for help

Changes or modifications made to this equipment not expressly approved by TCT Mobile Limited may void the FCC authorization to operate this equipment.

This equipment complies with FCC RF radiation exposure limits set forth for an uncontrolled environment.

- RoHS Approval

The modem is in compliance with the restriction of the use of certain hazardous substances in electrical and electronic equipment Directive 2011/65/EU (RoHS Directive).

- LICENCES



Micro SD Logo is a trademark.



The Bluetooth word mark and logos are owned by the Bluetooth SIG, Inc. and any use of such marks by TCT Mobile Limited and its affiliates is under license. Other trademarks and trade names are those of their respective owners.

20
ONETOUCH TAB 7 Bluetooth QD ID XXXXXXX



TouchPal™ and CooTek™ are trademarks of Shanghai HanXiang (CooTek) Information Technology Co., Ltd. and/or its Affiliates.



The Wi-Fi Logo is a certification mark of the Wi-Fi Alliance.

Your device uses non-harmonized frequency and is intended for use in all European countries.

The WLAN can be operated in the EU without restriction indoors, but cannot be operated outdoors in France.

Google, the Google logo, Android, the Android logo, Google Search™, Google Maps™, Gmail™, YouTube, Android Market, Google Latitude™ and Google Talk™ are trademarks of Google Inc. You have purchased a product which uses the open source (<http://opensource.org/>) programs mtd, msdosfs, natatorial/iptables and initrd in object code and other open source programs licensed under the GNU General Public License and Apache License.

We will provide you with a complete copy of the corresponding source codes upon request within a period of three years from the distribution of the product by TCT.

You may download the source codes from <http://sourceforge.net/projects/alcatel/files/>. The provision of the source code is free of charge.

General information

Internet address: www.alcatelonetouch.com

Hot Line Number: see "TCT Mobile Services" leaflet or go to our website.

On our website, you will find our FAQ (Frequently Asked Questions) section. You can also contact us by e-mail to ask any questions you may have.

An electronic version of this user guide is available in English and other languages according to availability on our server:

www.alcatelonetouch.com

Your device is a transceiver that operates on Wi-Fi and Bluetooth with 2.4GHz.

This equipment is in compliance with the essential requirements and other relevant provisions of Directive 1999/5/EC. The entire copy of the Declaration of Conformity for your device can be obtained through our website: www.alcatelonetouch.com.

CE 0700

Disclaimer

There may be certain differences between the user manual description and the device's operation, depending on the software release of your device or specific operator services. TCT Mobile shall not be held legally responsible for such differences, if any, nor for their potential consequences, which responsibility shall be borne by the operator exclusively. This handset may contain materials, including applications and software in executable or source code form, which is submitted by third parties for inclusion in this handset ("Third Party Materials"). All third party materials in this handset are provided "as is", without warranty of any kind, whether express or implied, including the implied warranties of merchantability, fitness for a particular purpose or use/third party application, interoperability with other materials or applications of the purchaser and non-infringement of copyright. The purchaser undertakes that TCT Mobile has complied with all quality obligations incumbent upon it as a manufacturer of mobile devices and handsets in complying with Intellectual Property rights. TCT Mobile will at no stage be responsible for the inability or failure of the Third Party Materials to operate on this handset or in interaction with any other devices of the purchaser. To the maximum extent permitted by law, TCT Mobile disclaims all liability for any claims, demands, suits or actions, and more specifically – but not limited to – tort law actions, under any theory of liability, arising out of the use, by whatever means, or attempts to use, such Third Party Materials. Moreover, the present Third Party Materials, which are provided free of charge by TCT Mobile, may be subject to paid updates and upgrades in the future; TCT Mobile waives any responsibility regarding such additional costs, which shall be borne exclusively by the purchaser. The availability of the applications may vary depending on the countries and the operators where the

handset is used; in no event shall the list of possible applications and software provided with the handsets be considered as an undertaking from TCT Mobile; it shall remain merely as information for the purchaser. Therefore, TCT Mobile shall not be held responsible for the lack of availability of one or more applications wished for by the purchaser, as its availability depends on the country and the operator of the purchaser. TCT mobile reserves the right at any time to add or remove Third Party Materials from its handsets without prior notice; in no event shall TCT Mobile be held responsible by the purchaser for any consequences that such removal may have on the purchaser regarding the use or attempt to use such applications and Third Party Materials.