

TASCAM

OPCD400UTEA02

CD-400U

CD / MEMORY PLAYER

OWNER'S MANUAL

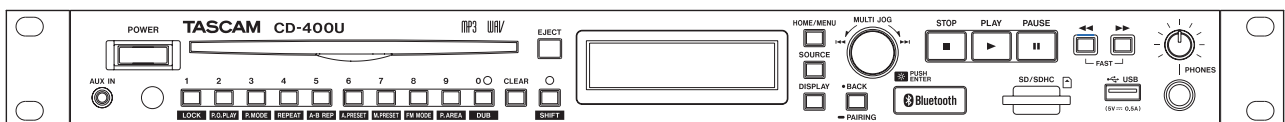

Qualcomm® aptX™



Bluetooth®

IMPORTANT SAFETY PRECAUTIONS



CAUTION
RISK OF ELECTRIC SHOCK
DO NOT OPEN



CAUTION: TO REDUCE THE RISK OF ELECTRIC SHOCK, DO NOT REMOVE COVER (OR BACK). NO USER-SERVICEABLE PARTS INSIDE. REFER SERVICING TO QUALIFIED SERVICE PERSONNEL.



The lightning flash with arrowhead symbol, within equilateral triangle, is intended to alert the user to the presence of uninsulated "dangerous voltage" within the product's enclosure that may be of sufficient magnitude to constitute a risk of electric shock to persons.



The exclamation point within an equilateral triangle is intended to alert the user to the presence of important operating and maintenance (servicing) instructions in the literature accompanying the appliance.

WARNING: TO PREVENT FIRE OR SHOCK HAZARD, DO NOT EXPOSE THIS APPLIANCE TO RAIN OR MOISTURE.

- 1 Read these instructions.
 - 2 Keep these instructions.
 - 3 Heed all warnings.
 - 4 Follow all instructions.
 - 5 Do not use this apparatus near water.
 - 6 Clean only with dry cloth.
 - 7 Do not block any ventilation openings. Install in accordance with the manufacturer's instructions.
 - 8 Do not install near any heat sources such as radiators, heat registers, stoves, or other apparatus (including amplifiers) that produce heat.
 - 9 Do not defeat the safety purpose of the polarized or grounding-type plug. A polarized plug has two blades with one wider than the other. A grounding type plug has two blades and a third grounding prong. The wide blade or the third prong are provided for your safety. If the provided plug does not fit into your outlet, consult an electrician for replacement of the obsolete outlet.
 - 10 Protect the power cord from being walked on or pinched particularly at plugs, convenience receptacles, and the point where they exit from the apparatus.
 - 11 Only use attachments/accessories specified by the manufacturer.
 - 12 Use only with the cart, stand, tripod, bracket, or table specified by the manufacturer, or sold with the apparatus. When a cart is used, use caution when moving the cart/apparatus combination to avoid injury from tip-over.
 - 13 Unplug this apparatus during lightning storms or when unused for long periods of time.
 - 14 Refer all servicing to qualified service personnel. Servicing is required when the apparatus has been damaged in any way, such as power-supply cord or plug is damaged, liquid has been spilled or objects have fallen into the apparatus, the apparatus has been exposed to rain or moisture, does not operate normally, or has been dropped.
- The apparatus draws nominal non-operating power from the AC outlet with its POWER or STANDBY/ON switch not in the ON position.
 - The mains plug is used as the disconnect device, the disconnect device shall remain readily operable.
 - Caution should be taken when using earphones or headphones with the product because excessive sound pressure (volume) from earphones or headphones can cause hearing loss.
 - If you are experiencing problems with this product, contact TEAC for a service referral. Do not use the product until it has been repaired.

CAUTION

- Do not expose this apparatus to drips or splashes.
- Do not place any objects filled with liquids, such as vases, on the apparatus.
- Do not install this apparatus in a confined space such as a book case or similar unit.
- The apparatus should be located close enough to the AC outlet so that you can easily grasp the power cord plug at any time.
- If the product uses batteries (including a battery pack or installed batteries), they should not be exposed to sunshine, fire or excessive heat.
- CAUTION for products that use replaceable lithium batteries: there is danger of explosion if a battery is replaced with an incorrect type of battery. Replace only with the same or equivalent type.

WARNING

- Products with Class I construction are equipped with a power supply cord that has a grounding plug. The cord of such a product must be plugged into an AC outlet that has a protective grounding connection.



IMPORTANT SAFETY INSTRUCTIONS

■ RACK-MOUNTING THE UNIT

Use the supplied rack-mounting kit to mount the unit in a standard 19-inch rack, as shown below.

Remove the feet of the unit before mounting.

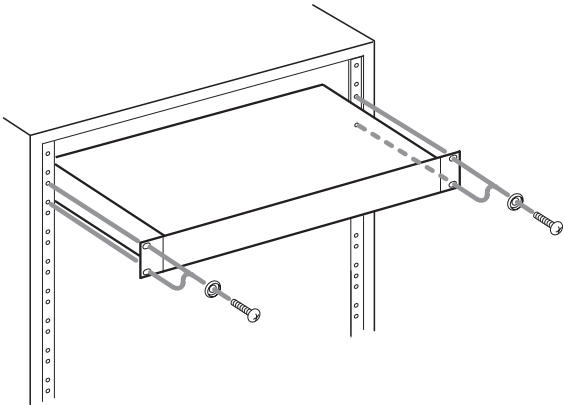

CAUTION

- Leave 1U of space above the unit for ventilation.
- Allow at least 10 cm (4 in) at the rear of the unit for ventilation.

Laser information

This product contains a semiconductor laser system inside the cabinet and is classified as a "CLASS 1 LASER PRODUCT".

To prevent being exposed to the laser beam, do not try to open the enclosure.

Notes on Laser Product

This product has been designed and manufactured according to FDA regulations "title 21, CFR, chapter 1, subchapter J, based on the Radiation Control for Health and Safety Act of 1968", and is classified as a class 1 laser product. There is no hazardous invisible laser radiation during operation because invisible laser radiation emitted inside of this product is completely confined in the protective housings.

The label required in this regulation is shown at ①.

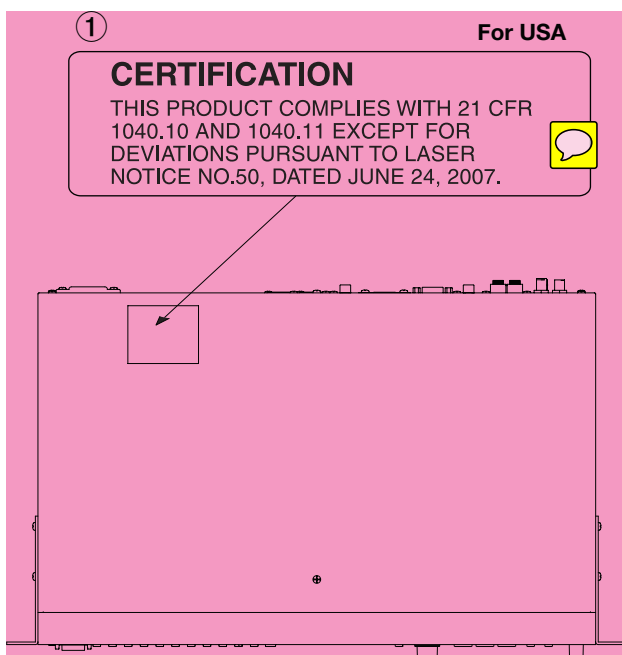

CAUTION

- DO NOT REMOVE THE PROTECTIVE HOUSING USING A SCREWDRIVER.
- USE OF CONTROLS OR ADJUSTMENTS OR PERFORMANCE OF PROCEDURES OTHER THAN THOSE SPECIFIED HEREIN MAY RESULT IN HAZARDOUS RADIATION EXPOSURE.

Optical pickup

Type: EP-C250L

Manufacturer: GUANGDONG EVER BRIGHT GROUP CO.,LTD

Laser output: Less than 0.30 mW on the objective lens

Wavelength: 792 +8 nm / -12 nm

CAUTIONS ABOUT BATTERIES

This product uses batteries. Misuse of batteries could cause a leak, rupture or other trouble. Always abide by the following precautions when using batteries.

- Never recharge non-rechargeable batteries. The batteries could rupture or leak, causing fire or injury.
- When installing batteries, pay attention to the polarity indications (plus/minus (+/-) orientation), and install them correctly in the battery compartment as indicated. Putting them in backward could make the batteries rupture or leak, causing fire, injury or stains around them.
- When you store or dispose batteries, isolate their terminals with insulation tape or something like that to prevent them from contacting other batteries or metallic objects.
- When throwing used batteries away, follow the disposal instructions indicated on the batteries and the local disposal laws.
- Do not use batteries other than those specified. Do not mix and use new and old batteries or different types of batteries together. The batteries could rupture or leak, causing fire, injury or stains around them.
- Do not carry or store batteries together with small metal objects. The batteries could short, causing leak, rupture or other trouble.
- Do not heat or disassemble batteries. Do not put them in fire or water. Batteries could rupture or leak, causing fire, injury or stains around them.
- If the battery fluid leaks, wipe away any fluid on the battery case before inserting new batteries. If the battery fluid gets in an eye, it could cause loss of eyesight. If fluid does enter an eye, wash it out thoroughly with clean water without rubbing the eye and then consult a doctor immediately. If the fluid gets on a person's body or clothing, it could cause skin injuries or burns. If this should happen, wash it off with clean water and then consult a doctor immediately.
- The unit power should be off when you install and replace batteries.

IMPORTANT SAFETY INSTRUCTIONS

- Remove the batteries if you do not plan to use the unit for a long time. Batteries could rupture or leak, causing fire, injury or stains around them. If the battery fluid leaks, wipe away any fluid on the battery compartment before inserting new batteries.
- Do not disassemble a battery. The acid inside the battery could harm skin or clothing.

⚠ WARNING

DO NOT INGEST BATTERY, CHEMICAL BURN HAZARD

followed by:

[The remote control supplied with] This product contains a coin/button cell battery. If the coin/button cell battery is swallowed, it can cause severe internal burns in just 2 hours and can lead to death.

Keep new and used batteries away from children. If the battery compartment does not close securely, stop using the product and keep it away from children.

If you think batteries might have been swallowed or placed inside any part of the body, seek immediate medical attention.

IN USA/CANADA, USE ONLY ON 120 V SUPPLY.

■ For European Customers

Disposal of electrical and electronic equipment and batteries and/or accumulators

- All electrical/electronic equipment and waste batteries/accumulators should be disposed of separately from the municipal waste stream via collection facilities designated by the government or local authorities.
- By disposing of electrical/electronic equipment and waste batteries/accumulators correctly, you will help save valuable resources and prevent any potential negative effects on human health and the environment.
- Improper disposal of waste electrical/electronic equipment and batteries/accumulators can have serious effects on the environment and human health because of the presence of hazardous substances in the equipment.
- The Waste Electrical and Electronic Equipment (WEEE) symbols, which show wheeled bins that have been crossed out, indicate that electrical/electronic equipment and batteries/accumulators must be collected and disposed of separately from household waste.
 

If a battery or accumulator contains more than the specified values of lead (Pb), mercury (Hg), and/or cadmium (Cd) as defined in the Battery Directive (2006/66/EC), then the chemical symbols for those elements will be indicated beneath the WEEE symbol.
 
- Return and collection systems are available to end users. For more detailed information about the disposal of old electrical/electronic equipment and waste batteries/accumulators, please contact your city office, waste disposal service or the shop where you purchased the equipment.

■ For China



“仅适用于海拔 2000m 以下地区安全使用”



“仅适用于非热带气候条件下安全使用”



“环境保护使用年限”

产品有毒有害物质或元素的名称及含量

机种 : CD-400U		有毒有害物质或元素					
	品名	铅 (Pb)	汞 (Hg)	镉 (Cd)	六价铬 (Cr6+)	多溴联苯 (PBB)	多溴二苯醚 (PBDE)
1	CHASSIS 部份	○	○	○	○	○	○
2	FRONT PANEL 部份	○	○	○	○	○	○
3	螺丝部份	○	○	○	○	○	○
4	线材部份	○	○	○	○	○	○
5	PCB Assy 部份	×	○	○	○	○	○
6	电源部份	○	○	○	○	○	○
7	附属品部份	×	○	○	○	○	○
8	LABEL 部份	○	○	○	○	○	○
9	包装部份	○	○	○	○	○	○

○ : 表示该有毒有害物质在该部件所有均质材料中的含量均在 GB/T26572 标准规定的限量要求以下。

× : 表示该有毒有害物质至少在该部件的某一均质材料中的含量超出 GB/T26572 标准规定的限量要求。

(针对现在代替技术困难的电子部品及合金中的铅)

Wireless equipment precautions

Compliance of radio transmitter and interference

This product has the function of broadband transmitter using 2.4 GHz Band.

Use frequency range: 2400 MHz - 2480 MHz

Maximum output power: Bluetooth® Class2 (less than 2.5 mW)

CAUTION

Use only in the country where you purchased the product.

- Authorization of wireless devices are different in countries or regions.
- Depending on the country, restrictions on the use of Bluetooth wireless technology might exist.

CAUTION

Changes or modifications to this equipment not expressly approved by TEAC CORPORATION for compliance could void the user's authority to operate this equipment.

Radiation Exposure requirements

This equipment meets the regulation, which is recognized internationally, for the case of human exposure to radio waves generated by the transmitter.

■ Model for U.S.A

This device complies with Part 15 of the FCC Rules. Operation is subject to the following two conditions: (1) this device may not cause harmful interference, and (2) this device must accept any interference received, including interference that may cause undesired operation.

Labeling of authorization

FCC ID: XEG-CD400U

This equipment has been tested and found to comply with the limits for a Class B digital device, pursuant to Part 15 of the FCC Rules. These limits are designed to provide reasonable protection against harmful interference in a residential installation. This equipment generates, uses, and can radiate radio frequency energy and, if not installed and used in accordance with the instruction manual, may cause harmful interference to radio communications. However, there is no guarantee that interference will not occur in a particular installation. If this equipment does cause harmful interference to radio or television reception, which can be determined by turning the equipment off and on, the user is encouraged to try to correct the interference by one or more of the following measures.

- a) Reorient or relocate the receiving antenna.
- b) Increase the separation between the equipment and receiver.
- c) Connect the equipment into an outlet on a circuit different from that to which the receiver is connected.
- d) Consult the dealer or an experienced radio/TV technician for help.

FCC Radiation Exposure Statement

This device complies with FCC radiation exposure limits set forth for an uncontrolled environment and it also complies with Part 15 of the FCC RF Rules.

This equipment must be installed and operated in accordance with provided instructions and the antenna(s) used for this transmitter must be installed to provide a separation distance of at least 20 cm from all persons and must not be co-located or operating in conjunction with any other antenna or transmitter.

End-users and installers must be provided with antenna installation instructions and consider removing the no-collocation statement.

■ Model for Canada

Compliance of radio transmitter

This device complies with Industry Canada's license-exempt RSSs. Operation is subject to the following two conditions:

- (a) This device may not cause interference; and
- (b) This device must accept any interference, including interference that may cause undesired operation of the device.

Labeling of authorization

IC: 1559C-CD400U

Compliance of interference

This Class B digital apparatus complies with Canadian ICES-003.

Labeling of compliance

CAN ICES-3(B)/NMB-3(B)

Wireless equipment precautions

Radiation Exposure requirements

The device meets the exemption from the routine evaluation limits in section 2.5 of RSS 102 and compliance with RSS-102 RF exposure, users can obtain Canadian information on RF exposure and compliance.

This transmitter must not be co-located or operating in conjunction with any other antenna or transmitter. This equipment should be installed and operated with a minimum distance of 20 centimeters between the radiator and your body.

■ Modèle pour le Canada

Conformité de l'émetteur radio

Le présent appareil est conforme aux CNR d'Industrie Canada applicables aux appareils radio exempts de licence. L'exploitation est autorisée aux deux conditions suivantes :

- 1) l'appareil ne doit pas produire de brouillage;
- 2) l'utilisateur de l'appareil doit accepter tout brouillage radioélectrique subi, même si le brouillage est susceptible d'en compromettre le fonctionnement.

Marquage d'autorisation

IC: 1559C-CD400U

Conformité de brouillage

Cet appareil numérique de la classe B est conforme à la norme NMB-003 du Canada.

Marquage d'autorisation

CAN ICES-3(B)/NMB-3(B)

Exigences relatives à l'exposition aux rayonnements

Le dispositif rencontre l'exemption des limites courantes d'évaluation dans la section 2.5 de RSS 102 et la conformité à l'exposition de RSS-102 rf, utilisateurs peut obtenir l'information canadienne sur l'exposition et la conformité de rf.

Cet émetteur ne doit pas être Co-placé ou ne fonctionnant en même temps qu'aucune autre antenne ou émetteur. Cet équipement devrait être installé et actionné avec une distance minimum de 20 centimètres entre le radiateur et votre corps.

■ Model for EUR



Hereby, TEAC Corporation declares that the radio equipment type CD-400U is in compliance with Directive 2014/53/EU, and the other Directives, and Commission Regulations.

The full text of the EU declaration of conformity is available at the following internet address: Please contact us by e-mail.

<http://tascam.eu/en/kontakt.html>

EU Importer: TEAC Europe GmbH

Bahnstrasse 12, 65205 Wiesbaden-Erbenheim, Germany

Radiation Exposure requirements

This equipment complies with EN.62311; Assessment of electronic and electrical equipment related to human exposure restrictions for electromagnetic fields; the harmonised standard of DIRECTIVE 2014/53/EU.

IMPORTANT SAFETY PRECAUTIONS	2
Compliance of radio transmitter and interference	5
1 – Introduction	8
Features	8
Items included with this product	8
Conventions used in this manual	8
Trademarks	9
Precautions for placement and use	9
Notes about power supplies	9
Beware of condensation	9
Cleaning the unit	9
About compact discs	10
Precautions for use	10
Slot loading of discs	10
SD cards and USB flash drives	10
Precautions for use	10
SD card write protection	10
Bluetooth®	11
Profiles	11
Codecs	11
Content protection	11
Transmission security	11
Using the TEAC Global Site	11
Product registration	11
2 – Names and Functions of Parts	12
Front panel	12
Rear panel	15
Wireless remote control (TASCAM RC-CD400)	16
Home Screen	17
Menu structure	18
Basic MENU screen operations	18
Menu operation procedures	18
3 – Preparation	19
Making connections	19
Assembling the AM antenna	19
Preparing the remote control	20
Installing batteries	20
When to replace batteries	20
Battery precautions	20
Using the wireless remote control	20
Turning the unit on and off	20
Adjusting the display brightness	20
Inserting and removing discs	21
Inserting discs	21
Ejecting discs	21
Forcing disc ejection	21
Inserting and removing SD cards	21
Inserting SD cards	21
Removing SD cards	21
SD card write protection switches	21
Connecting and disconnecting USB flash drives	22
Connecting USB flash drives	22
Disconnecting USB flash drives	22
Setting remote control reception	22
Panel lock functions	22
Selecting the playback source	22
4 – CD/SD/USB playback	23
Files that can be played back	23
Tracks and folders on SD cards and USB flash drives	23
Playback area	24
Setting the playback area	24
Basic playback operations	24
Playing tracks	24
Selecting tracks for playback	24
Skipping to earlier and later tracks	24
Selecting tracks directly	25
Folder playback (SD cards and USB flash drives only)	25
Playback modes	26
Setting the playback mode	26
Searching backward and forward	27
Using the repeat playback function	27
Ordinary repeat playback settings	27
A-B repeat playback settings (audio CDs only)	28
Using the power-on-play function	28
Using the resume function	29
Using the incremental playback function	29
Time and text information display	30
5 – Bluetooth device playback	31
Pairing	31
Usable controls	31
Playback from a Bluetooth device	31
Unpairing	31
6 – Listening to AM/FM radio	32
Tuning in radio stations	32
Changing the received frequency	32
Setting the FM mode	32
Setting radio station presets	32
Setting radio station presets automatically	32
Setting radio station presets manually	32
Selecting preset stations	33
Clearing preset assignments	33
Muting tuner broadcast sound	33
Setting the tuner broadcast outputs	33
RDS (European model only)	34
PTY search	34
RDS Program type	34
7 – Dubbing (copying) functions	36
Dubbing overview	36
Dubbing procedures	36
Muting analog outputs while dubbing	37
Make dubbing format settings	37
Recording times when dubbing	37
8 – Other functions	38
Setting the automatic power saving function	38
Adjusting the analog output	38
Serial mode setting (when sold-separately Ethernet card installed)	38
Using the RS-232C connector	38
Setting the transmission speed (baud rate)	38
Using the AUX IN jack	38
Checking the firmware version	39
Restoring factory default settings	39
9 – Troubleshooting	40
10 – Specifications	41
Ratings	41
Inputs and outputs	41
Analog audio input and output ratings	41
Control input/output	41
Audio performance	41
Bluetooth	42
Tuner	42
Other	42
Dimensional drawings	42

1 – Introduction

Thank you very much for purchasing the TASCAM CD-400U CD/MEMORY PLAYER.

Before using this unit, read this Owner's Manual carefully so that you will be able to use it correctly and enjoy working with it for many years. After you have finished reading this manual, please keep it in a safe place for future reference.

You can also download this Owner's Manual from the TEAC Global Site (<http://teac-global.com/>).

Features

- Playback of CDs, SD cards and USB flash drives possible
- CD player supports CD-DA, CD-ROM, CD-R, CD-RW (CD-DA format only), MP3-CD and WMA-CD formats
- MP3, AAC, WAV and WMA files can be played from SD cards and USB flash drives
- Bluetooth® receiver built-in, enabling playback from smart phones and other devices
- AM/FM tuner built-in
- AUX IN jack can be used for playback from mobile audio players and other devices
- Analog outputs include pairs of XLR balanced and RCA unbalanced jacks
- Incremental playback function jumps to the beginning of the next track, enabling instant cueing
- Recording from audio CDs and the tuner to SD cards and USB flash drives is possible
- RS-232C serial port allows external control
- Unbalanced RCA connectors dedicated for tuner output
- CD/SD/USB direct track searching using number keys or the dedicated remote control
- Power-on-play function can automatically start track playback when the unit is turned on
- Panel lock function can disable use of front panel buttons to increase operation confidence
- Headphone output jack enables audio monitoring
- 1U rackmount size

Items included with this product

This product includes the following items.

Take care when opening the package to avoid damaging the items. Keep the packing materials for transportation in the future.

Please contact the store where you purchased this unit if any of these items are missing or have been damaged during transportation.

- Main unit × 1
- Power cord × 1
- Wireless remote control (TASCAM RC-CD400) × 1
- AAA batteries × 2
- FM antenna × 1
- AM antenna × 1
- Rackmount screw kit × 1
- Owner's Manual (this document) including warranty × 1

Conventions used in this manual

In this manual, we use the following conventions:

- When we refer to buttons, connectors and other parts of this unit and other equipment, we use a bold font like this: **HOME/MENU** button.
- When we show characters that appear on the display, the typeface looks like this: **MENU**.
- SD/SDHC memory cards are called "SD cards".
- The CD-DA format is sometimes called the "audio CD" format. In addition, CDs with tracks recorded in the audio CD format are sometimes called "audio CDs".
- CDs with MP3 and WMA files are called "data CDs".
- The input source that is currently selected is called the "current source".
- The folder that is currently selected is called the "current folder".
- Computers, portable audio devices and other equipment connected to this unit using Bluetooth are called "Bluetooth devices".
- As necessary, additional information is provided under TIP, NOTE and CAUTION headings.

TIP

These are tips about how to use the unit.

NOTE

These provide additional explanations and describe special cases.

CAUTION

Failure to follow these instructions could result in injury, damage to equipment or lost recording data, for example.

Trademarks

- TASCAM is a registered trademark of TEAC Corporation.
- The SDHC logo is a trademark of SD-3C, LLC.



- The Bluetooth® word mark and logo are the property of Bluetooth SIG, Inc. and are used by TEAC Corporation with permission.
- Qualcomm® aptX™ is a product of Qualcomm® Technologies International, Ltd.
- Qualcomm® is a trademark of Qualcomm® Incorporated, registered in the United States and other countries, used with permission. aptX is a trademark of Qualcomm® Technologies International, Ltd., registered in the United States and other countries, used with permission.



- Supply of this product does not convey a license nor imply any right to distribute MPEG Layer-3 compliant content created with this product in revenue-generating broadcast systems (terrestrial, satellite, cable and/or other distribution channels), streaming applications (via Internet, intranets and/or other networks), other content distribution systems (pay-audio or audio-on-demand applications and the like) or on physical media (compact discs, digital versatile discs, semiconductor chips, hard drives, memory cards and the like). An independent license for such use is required. For details, please visit <http://mp3licensing.com>.
- Other company names, product names and logos in this document are the trademarks or registered trademarks of their respective owners.

Information is given about products in this manual only for the purpose of example and does not indicate any guarantees against infringements of third-party intellectual property rights and other rights related to them. TEAC Corporation will bear no responsibility for infringements on third-party intellectual property rights or their occurrence because of the use of these products.

With the exception of personal enjoyment and similar uses, copyrighted materials belonging to third parties cannot be used without permission from the rights holders in accordance with copyright law. Please use the equipment appropriately. TEAC Corporation will bear no responsibility for rights infringements committed by users of this product.

Precautions for placement and use

- The operating temperature range of this unit is 5–35 °C.
- Do not install this unit in the following types of locations. Doing so could make the sound quality worse or cause malfunction.
 - Locations with frequent vibrations
 - Near windows or other places exposed to direct sunlight
 - Near heaters or other extremely hot places
 - Extremely cold places
 - Very humid or poorly ventilated places
 - Very dusty places
- Install the unit so that it is level.
- To enable good heat dissipation, do not place anything on top of the unit.
- Do not place the unit on top of a power amplifier or other device that generates heat.
- To mount this unit in a rack, use the included rackmount screw kit and mount it as shown in the illustration below. Leave at least 1U of space open above it in the rack.

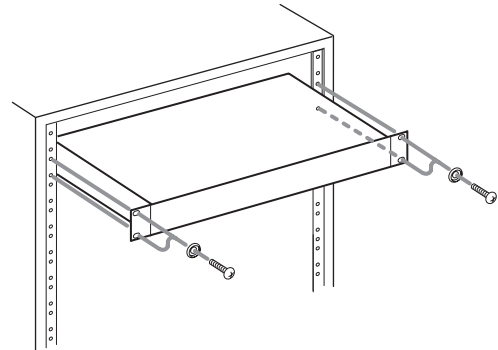

Notes about power supplies

- Insert the included power cord all the way into the AC IN connector.
- Do not connect a power supply other than one that is AC100V - 240V (50/60Hz).
- Hold the power cord by its plug when connecting or disconnecting it.

Beware of condensation

Condensation could occur if the unit is moved from a cold place to a warm place, it is used immediately after a cold room has been heated or it is otherwise exposed to a sudden temperature change.

To prevent this, or if this occurs, let the unit sit for one or two hours at the new room temperature before using it.

Cleaning the unit

Use a dry soft cloth to wipe the unit clean. Do not wipe with chemical cleaning cloths, thinner, alcohol or other chemical agents. Doing so could damage the surface or cause discoloration.

1 – Introduction

About compact discs

In addition to commercially-available music CDs, this unit can play CD-R and CD-RW discs recorded in the audio CD (CD-DA) format as well as CD-R and CD-RW discs that contain MP3 and WAV audio files.

CAUTION

8cm CDs cannot be used. If an 8cm CD is inserted, it will automatically be ejected. During ejection, if it stops at a place where it cannot be removed, press and hold the **EJECT** button.

Precautions for use

- Always insert discs with the label facing upward.
- To remove a disc from its case, press down on the center of the disc holder, then lift the disc out, holding it carefully by the edges.
- Do not touch the signal side (the unlabeled side). Fingerprints, oils and other substances can cause errors during playback.
- If fingerprints or dust adhere to the signal recording side of a disc, wipe gently with a soft dry cloth from the center towards the outside edge.
- Dirt on discs can lower the sound quality, so clean them and always store them in a clean state.
- Do not use any record spray, anti-static solutions, benzene, paint thinner or other chemical agents to clean CDs as they could damage the delicate playing surface. It may cause CDs to become unplayable.
- Do not apply labels or other materials to discs. Do not use discs that have had tape, stickers or other materials applied to their surface. Do not use discs that have sticky residue from stickers, etc. Such discs could become stuck in the unit or cause it to malfunction.
- Never use a commercially available CD stabilizer.
- Using stabilizers with this player will damage the mechanism and cause it to malfunction.
- Do not use cracked discs.
- Only use circular compact discs. Avoid using non-circular promotional, etc. discs.

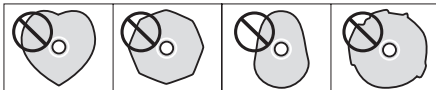

- Copy Control CDs have been sold by several record companies in an attempt to protect their copyrights. Since some of these discs do not comply with the CD specifications, they may not be playable on the unit.

Slot loading of discs

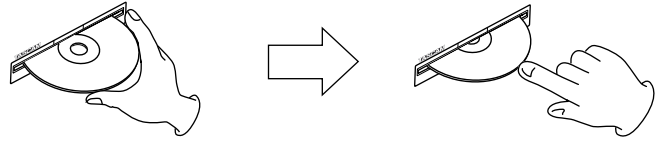

1. As shown in the illustration, hold the disc with the labeled side up and insert it part way into the slot.
2. Push the disc in further until just before it disappears. It will automatically be drawn in to the slot.

If a disc will not load properly

If a disc becomes stuck during insertion, for example, and is difficult to push, do not try to force the disc in. Pull the disc out once, press the **EJECT** button, and then try inserting it again. (Trying to force the disc in could damage the unit.)

SD cards and USB flash drives

This unit uses SD cards and USB flash drives for recording and playback.

A list of SD cards and USB flash drives that have been confirmed for use with this unit can be found on our web site. Please access to a product page of this product from the TEAC Global Site (<http://teac-global.com>) to find the list or contact the TASCAM customer support service.

Precautions for use

SD cards and USB flash drives are delicate media. In order to avoid damaging SD cards and USB flash drives, please take the following precautions when handling them.

- Do not leave them in extremely hot or cold places.
- Do not leave them in extremely humid places.
- Do not let them get wet.
- Do not put things on top of them or twist them.
- Do not hit them.
- Do not remove or insert them during recording, playback, data transmission or other access.
- When transporting them, put them into cases, for example.

SD card write protection

This unit writes track information to the media in order to improve operation performance. Since track information cannot be written to SD cards that are write-protected, the amount of time needed to read media will become longer, for example.

Bluetooth®

This unit has a built-in Bluetooth audio receiver, and can output sound played on a computer or portable audio device that supports Bluetooth (Bluetooth device).

CAUTION

The Bluetooth function of this unit is not guaranteed to enable connection or operation with all Bluetooth devices.

Profiles

This unit supports the following Bluetooth profiles.

- A2DP (Advanced Audio Distribution Profile)
- AVRCP (Audio/Video Remote Control Profile)

In order to transfer audio by Bluetooth, the Bluetooth device must support A2DP.

In order to control playback on the Bluetooth device, it must support AVRCP.

Even if a Bluetooth device supports the same profiles, though, its functions might differ according to its specifications.

Codecs

This unit supports the following codecs. It will automatically select one of them during audio transfer.

- SBC
- AAC
- aptX

The unit will select the appropriate codec to use according to the codec compatibility of the other Bluetooth device and communication conditions.

NOTE

- You cannot select the codec to be used by pressing a button, for example.
- Due to characteristics of Bluetooth wireless technology, playback from a Bluetooth device will be slightly delayed compared to playback from this unit.

Content protection

This unit supports SCMS-T as a form of content protection when transmitting audio, so it can play protected audio.

Transmission security

This unit supports security functions during Bluetooth transmission in accordance with the Bluetooth standard specifications, but it does not guarantee the privacy of such transmissions.

TEAC CORPORATION will bear no responsibility should an information leak occur during transmission by Bluetooth.

Using the TEAC Global Site

You can download updates for this unit from the TEAC Global Site:

<http://teac-global.com/>

In the TASCAM Downloads section, select the desired language to open the Downloads website page for that language.

Product registration

Customers in the USA, please visit the following TASCAM website to register your TASCAM product online.

<http://tascam.com/>

2 – Names and Functions of Parts

Front panel

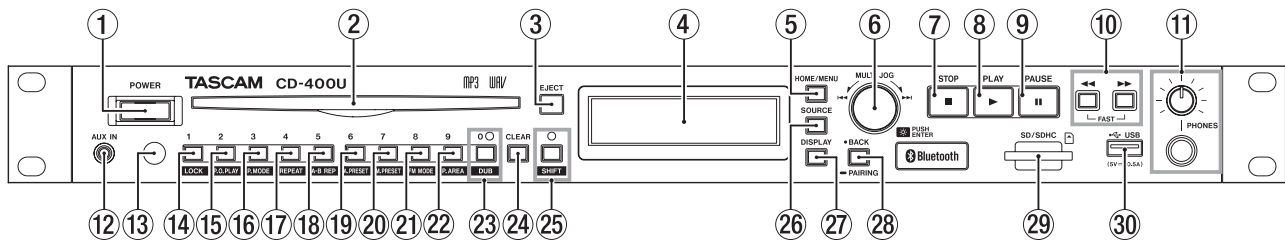

① POWER switch

This turns the unit on and off

CAUTION

Before turning the unit on, lower the volumes of connected equipment to their minimum levels. Failure to do so could result in a sudden loud noise that could harm hearing, for example.

NOTE

Do not use this switch when the unit is operating (including dubbing, playing back, or writing data to an SD card or USB flash drive). Doing so could cause dubbing to fail or dubbed data to be lost, for example.

② Disc slot

Insert a disc here.

After a disc is inserted partway, the unit will automatically draw it in.

③ EJECT button

Press to eject a disc. (see “Inserting and removing discs” on page 21)

Press and hold for at least 10 seconds to force-eject a disc. (see “Forcing disc ejection” on page 21)

④ Display

This shows various types of information.

⑤ HOME/MENU button

- When the Home Screen is open, press to open the MENU screen. (see “Menu structure” on page 18) (see “Basic MENU screen operations” on page 18)

- When the MENU screen is open, press this button to return to the Home Screen.

⑥ MULTI JOG dial

This dial functions as a dial when turned and as a button when pressed.

Dial functions

- When the current source is CD, USB or SD and the play area is set to “ALL”, turn the **MULTI JOG** dial to skip tracks. (see “Skipping to earlier and later tracks” on page 24)

- When the current source is USB or SD and the play area is folder (📁 icon shown), turn the **MULTI JOG** dial to move among tracks and folders. (see “Folder playback (SD cards and USB flash drives only)” on page 25)

- When the current source is AM/FM, turn the **MULTI JOG** dial to change the received frequency. (see “Tuning in radio stations” on page 32)

- When the current source is AM/FM and preset mode is enabled, turn the **MULTI JOG** dial to move to the previous or next preset number. (see “Setting radio station presets” on page 32)

- When a MENU screen is open, turn to select items and change setting values. (see “Basic MENU screen operations” on page 18)

- When the unit is in shift mode (**SHIFT** indicator lit), turn the **MULTI JOG** dial to adjust the display brightness. (see “Adjusting the display brightness” on page 20)

Button function

- When a Menu Screen is open, press to confirm selections and settings (**ENTER** button function).

⑦ STOP button

- Press to stop playback.

- When the incremental playback function is on, press this button during playback to jump to the beginning of the next track and pause. (see “Using the incremental playback function” on page 29)

- When the current source is AM or FM, press to switch between frequency and preset modes. (see “Changing the received frequency” on page 32)

- Press when dubbing to stop. (see “Dubbing procedures” on page 36)

⑧ PLAY button

- Press when stopped or in playback standby to start playback.

- When the incremental playback function setting is ON, press this button during playback to start playback of the next track. (see “Using the incremental playback function” on page 29)

⑨ PAUSE button

Press when stopped or playing back to start playback standby.

⑩ ◀▶ [FAST] buttons

- Press and hold these buttons to search backward/forward. (see “Searching backward and forward” on page 27)

- If the current source is CD and you are searching an audio CD backward/forward, press and hold the button for the opposite direction (◀ or ▶) to search at high-speed. (see “Searching backward and forward” on page 27)

- When the current source is AM or FM, press to automatically search received frequencies for that frequency mode. (see “Changing the received frequency” on page 32)

2 – Names and Functions of Parts

11 PHONES

Use this standard stereo jack to connect stereo headphones. Use an adapter to connect headphones with a mini plug. Use the **PHONES** knob to adjust the headphone output level. **PHONES** jack output can be lowered up to –18 dB in 1dB intervals using the **A. Out Att.** setting screen. (see “Adjusting the analog output” on page 38)

CAUTION

Before connecting headphones, minimize the volume with the **PHONES** knob. Failure to do so could result in a sudden loud noise that could harm hearing, for example.

12 AUX IN jack

This stereo mini jack is an audio line input jack. Connect a portable digital player or other external audio device here. (see “Using the AUX IN jack” on page 38)

CAUTION

- Before connecting another device to the **AUX IN** jack, minimize the volume of that device. Failure to do so could result in a sudden loud noise that could harm hearing, for example.
- Before connecting or disconnecting with the **AUX IN** jack, set the current source to something other than **AUX** (CD or Bluetooth) or turn the unit off.

13 Remote control signal receiver

Signals from the wireless remote control (TASCAM RC-CD400) are received here. When operating the remote control, point it toward this receiver.

14 1 [LOCK] button

- Press to input track number 1 when the current source is **CD**, **USB** or **SD** and the play area is set to “ALL”. (see “Selecting tracks directly” on page 25)
- When the current source is **AM** or **FM**, press to tune in a pre-set station.
- When the unit is in shift mode (**SHIFT** indicator lit), press to turn the panel lock function (which disables button use to prevent misoperation) on/off. (see “Panel lock functions” on page 22)

NOTE

- The number buttons on the unit (**1 [FLASH]** – **0 [DUB]**) can be used to specify numbers for track selection. For track numbers, a maximum of two digits can be input for audio CDs and three digits for data CDs. (see “Selecting tracks directly” on page 25)
- When in **SHIFT** mode (**SHIFT** indicator lit), pressing a number button will change the setting of the function shown in white lettering below the button.

15 2 [P.O.PLAY] button

- Press to input track number 2 when the current source is **CD**, **USB** or **SD** and the play area is set to “ALL”. (see “Selecting tracks directly” on page 25)
- When the current source is **AM** or **FM**, press to tune in a pre-set station.
- When in **SHIFT** mode (**SHIFT** indicator lit), press to turn the power-on-play function on/off. (see “Using the power-on-play function” on page 28)

16 3 [P.MODE] button

- Press to input track number 3 when the current source is **CD**, **USB** or **SD** and the play area is set to “ALL”. (see “Selecting tracks directly” on page 25)
- When the current source is **AM** or **FM**, press to tune in a pre-set station.
- When the current source is **CD**, **USB** or **SD**, and shift mode is active (**SHIFT** indicator lit) press to cycle through the playback modes (ordinary, single and random). (see “Playback modes” on page 26)

17 4 [REPEAT] button

- Press to input track number 4 when the current source is **CD**, **USB** or **SD** and the play area is set to “ALL”. (see “Selecting tracks directly” on page 25)
- When the current source is **AM** or **FM**, press to tune in a pre-set station.
- When the current source is **CD**, **USB** or **SD**, and shift mode is active (**SHIFT** indicator lit) press to turn the repeat playback function on/off. (see “Ordinary repeat playback settings” on page 27)

18 5 [A-B REP] button

- Press to input track number 5 when the current source is **CD**, **USB** or **SD** and the play area is set to “ALL”. (see “Selecting tracks directly” on page 25)
- When the current source is **AM** or **FM**, press to tune in a pre-set station.
- When the current source is **CD**, **USB** or **SD**, and shift mode is active (**SHIFT** indicator lit) press to set the A-B repeat function starting (A) and ending (B) points. (see “A-B repeat playback settings (audio CDs only)” on page 28)

19 6 [A. PRESET] button

- Press to input track number 6 when the current source is **CD**, **USB** or **SD** and the play area is set to “ALL”. (see “Selecting tracks directly” on page 25)
- When the current source is **AM** or **FM**, press to tune in a pre-set station.
- When the current source is **AM** or **FM** and shift mode is active (**SHIFT** indicator lit) press to automatically program the preset stations. (see “Setting radio station presets automatically” on page 32)

20 7 [M.PRESET] button

- Press to input track number 7 when the current source is **CD**, **USB** or **SD** and the play area is set to “ALL”. (see “Selecting tracks directly” on page 25)
- When the current source is **AM** or **FM**, press to tune in a pre-set station.
- When the current source is **AM** or **FM** and shift mode is active (**SHIFT** indicator lit) press to manually program the preset stations. (see “Setting radio station presets manually” on page 32)

2 – Names and Functions of Parts

⑳ 8 [FM MODE] button

- Press to input track number 8 when the current source is CD, USB or SD and the play area is set to "ALL". (see "Selecting tracks directly" on page 25)
- When the current source is AM or FM, press to tune in a preset station.
- When the current source is FM, and shift mode is active (SHIFT indicator lit), press to switch between stereo and mono for FM broadcast reception. (see "Setting the FM mode" on page 32)

㉑ 9 [P.AREA] button

- Press to input track number 9 when the current source is CD, USB or SD and the play area is set to "ALL". (see "Selecting tracks directly" on page 25)
- When the current source is AM or FM, press to tune in a preset station.
- When the current source is USB or SD and shift mode is active (SHIFT indicator lit), press to set the play area. (see "Setting the playback area" on page 24)

㉒ 0 [DUB] button and indicator

- Press to input track number 0 when the current source is CD, USB or SD and the play area is set to "ALL". (see "Selecting tracks directly" on page 25)
- When the current source is AM or FM, press to tune in a preset station.
- When the current source is CD and playback is stopped or the current source is AM/FM, press with shift mode active (SHIFT indicator lit) to start dubbing (copying) preparation. The indicator lights when the dubbing (copying) function is active. (see "Dubbing procedures" on page 36)

㉓ CLEAR button

- When the current source is CD, USB or SD, press this to clear values input with number buttons.
- Press to close a warning message that has appeared on the Home Screen.
- When the current source is AM or FM, press and hold to clear all preset stations for that source. (see "Clearing preset assignments" on page 33)

㉔ SHIFT button and indicator

Press this button to light the indicator and enable shift mode, which activates the shift functions of other buttons. (These functions are shown below the buttons with white letters on dark blue backgrounds.)

To deactivate the shift mode (SHIFT indicator unlit), press the SHIFT button again.

㉕ SOURCE button

Press to switch the current source. (see "Selecting the playback source." on page 22)

㉖ DISPLAY button

- Press during playback to show a variety of information. (see "Time and text information display" on page 30)
- Please ignore INFO on the remote control unit. (INFO function does not work on this unit.) This button does not work at all on the USA/Canadian model.
- Press when the current source is FM to switch the RDS mode. (see "RDS (European model only)" on page 34)

㉗ BACK [PAIRING] button

- When the MENU screen is open, press to return to the Home Screen.
- When a MENU setting screen is open, press to go up one menu level.
- When the current source is USB or SD and the play area is folder (□ icon shown), press to move up one folder level. (see "Playback area" on page 24)
- When the current source is BLUETOOTH, press and hold to activate Bluetooth pairing mode. When a Bluetooth connection is active (Connected shown), press to disconnect forcefully. (see "Pairing" on page 31)

㉘ SD card slot

Insert SD cards in these slots. (see "Inserting and removing SD cards" on page 21)

㉙ USB port

Connect (and disconnect) USB flash drives here. (see "Connecting and disconnecting USB flash drives" on page 22)

2 – Names and Functions of Parts

Rear panel

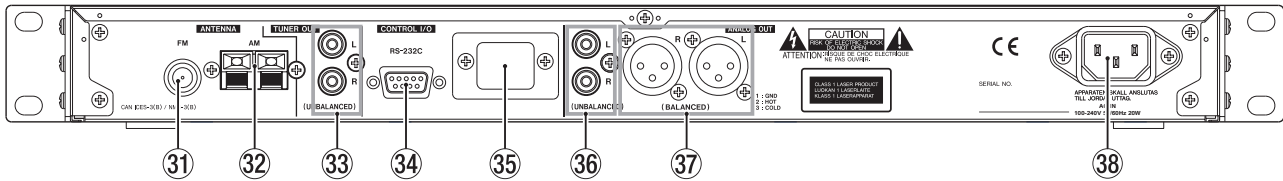

31 ANTENNA FM connector

Connect the included FM antenna here.
Extend the antenna and attach it to a window frame, wall or other surface where it provides the best reception.

32 ANTENNA AM connector

Assemble the included AM loop antenna and connect it to the AM antenna connector on the back of the unit.
Place the antenna in the position where it provides the best AM broadcast reception.

33 TUNER OUT jacks

These analog RCA pin output jacks always output the sound from the tuner.
The nominal output level is -10 dBV.

34 RS-232C connector

This is a 9-pin D-sub RS-422 control input/output connector.
Connect a computer, for example, here. (see "Using the RS-232C connector" on page 38)

35 Option slot

This slot is for installation of an Ethernet card (sold separately).

36 ANALOG OUT (UNBALANCED) L/R jacks

These are analog RCA pin output jacks.
The default nominal output level is -10 dBV (OFF analog output level setting), but it can also be lowered in 1dB increments to -28 dBV (-18dB analog output level setting). (see "Adjusting the analog output" on page 38)

37 ANALOG OUT (BALANCED) L/R jacks

These are balanced XLR analog output jacks.
The default nominal output level is +4 dBu (OFF analog output level setting), but it can also be lowered in 1dB increments to -14 dBu (-18dB analog output level setting). (1: GND, 2: HOT, 3: COLD) (see "Adjusting the analog output" on page 38)

38 AC IN connector

Connect the included power cord here.

2 – Names and Functions of Parts

Wireless remote control (TASCAM RC-CD400)

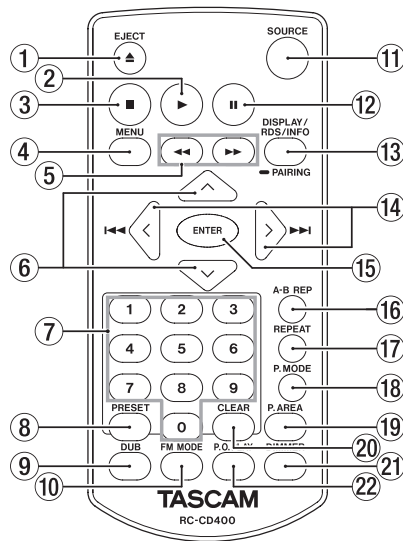

① EJECT button

This has the same function as the **EJECT** button on the main unit. (see "Inserting and removing discs" on page 21)

② ► button

This has the same function as the **PLAY** button on the main unit.

③ ■ button

This has the same function as the **STOP** button on the main unit.

④ MENU button

This has the same function as the **HOME/MENU** button on the main unit.

⑤ ◀◀/▶▶ buttons

These have the same functions as the **◀◀** and **▶▶** [FAST] buttons on the main unit.

⑥ ^/∨ buttons

- When the current source is **USB** or **SD** and the play area is folder (📁 icon shown), press the ^ button to move up one folder level. (see "Playback area" on page 24)
- When the current source is **FM** or **FM**, press the ∨ button to select a preset station.
- When a **MENU** setting screen is open, press the ^ button to move up one menu level.
- The ∨ button has the same function as the remote control **ENTER** button.

⑦ Number (0–9) buttons

- When the current source is **CD**, **USB** or **SD** and the play area is set to "**ALL**", use the number buttons to select tracks by their track numbers. For track numbers, a maximum of two digits can be input for audio CDs and three digits for data CDs. (see "Selecting tracks directly" on page 25)
- When the current source is **FM** or **FM**, press to tune in a pre-set station.

⑧ PRESET button

- When the current source is **FM** or **FM**, press to program pre-set stations manually. (see "Setting radio station presets manually" on page 32)
- When the current source is **FM** or **FM**, press and hold to program preset stations automatically. (see "Setting radio station presets automatically" on page 32)

⑨ DUB button

Press when stopped to start dubbing (copying) preparation. (see "Dubbing procedures" on page 36)

⑩ FM MODE button

When the current source is **FM**, press to switch between stereo and mono for FM broadcast reception. (see "Setting the FM mode" on page 32)

⑪ SOURCE button

This has the same function as the **SOURCE** button on the main unit. (see "Selecting the playback source" on page 22)

⑫ II button

This has the same function as the **PAUSE** button on the main unit.

⑬ DISPLAY/RDS/INFO [PAIRING] button

- Press during playback to show a variety of information. (see "Time and text information display" on page 30)
- When the current source is **BLUETOOTH**, press and hold to activate Bluetooth pairing mode. Press when pairing to end pairing mode. (see "Pairing" on page 31)
- Please ignore **INFO** on the remote control unit. (**INFO** function does not work on this unit.) This button does not work at all on the USA/Canadian model.
- Press when the current source is **FM** to switch the RDS mode. (see "RDS (European model only)" on page 34)

⑭ ◀◀/▶▶ [◀/▶] buttons

- When the current source is **CD**, **USB** or **SD** and the play area is set to "ALL", press to skip tracks. (see "Skipping to earlier and later tracks" on page 24)
- When the current source is **USB** or **SD** and the play area is folder (📁 icon shown), press to move between tracks and folders. (see "Playback area" on page 24)
- If the current source is **FM** or **FM**, press to change the frequency received. (see "Tuning in radio stations" on page 32)
- When the current source is **FM** or **FM** and preset mode is enabled, press to move to the previous or next preset number. (see "Setting radio station presets" on page 32)
- When a **MENU** screen is open, turn to select items and change setting values. (see "Basic MENU screen operations" on page 18)

⑮ ENTER button

When a **MENU** screen is open, press to confirm selections and settings.

2 – Names and Functions of Parts

16 A-B REP button

When the current source is **CD**, press to set the A-B repeat function starting (A) and ending (B) points. (see “A-B repeat playback settings (audio CDs only)” on page 28)

17 REPEAT button

Press to turn the repeat playback function on/off. (see “Ordinary repeat playback settings” on page 27)

18 P.MODE button

Press to cycle through the playback modes (ordinary, single and random). (see “Playback modes” on page 26)

19 P.AREA button

When the current source is **USB** or **SD**, press to set the play area. (see “Setting the playback area” on page 24)

20 CLEAR button

This has the same function as the **CLEAR** button on the main unit.

21 DIMMER button

Use to adjust the display brightness. (see “Adjusting the display brightness” on page 20)

22 P.O.PLAY button

Press to turn power-on-play on/off. (see “Using the power-on-play function” on page 28)

Home Screen

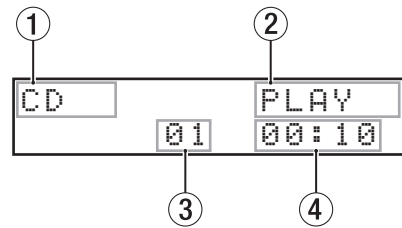

Home Screen when CD/USB/SD selected

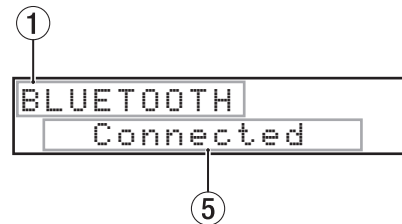

Home Screen when Bluetooth selected

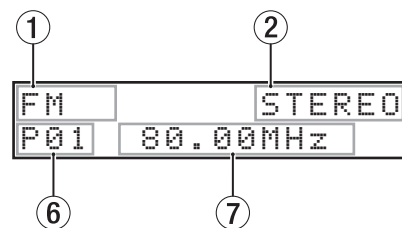

Home Screen when AM/FM selected

① Current source

This shows the name of the currently selected input source. (see “Selecting the playback source.” on page 22)

② Transport status/playback file format

- When the current source is **CD**, this shows the transport status.
- When the current source is **CD**, but a data CD is loaded or when the current source is **USB/SD**, this shows the playback file format.

③ Track number

This shows the number of the currently playing track.

④ Elapsed time from track beginning

This shows the elapsed time from the beginning of the current track (hours: minutes: seconds).

⑤ Connection status

This shows the connection status with other Bluetooth devices and messages.

⑥ Preset number

When the current source is **AM** or **FM** and preset mode is enabled, this shows the preset number.

⑦ Frequency received

If the current source is **AM** or **FM**, this shows the frequency received.

2 – Names and Functions of Parts

Menu structure

Press the main unit **HOME/MENU** button or remote control **MENU** button to open the MENU screen.

The various menu items are as follows.

Menu item	Function	Page
APS Setting	Automatic power saving function setting	see page 38
Tuner AutoMute	Tuner automatic muting function setting	see page 33
DUB AutoMute	Dubbing automatic muting function setting	see page 37
A.Out Att.	Analog output attenuation function setting	see page 38
Resume Setting	Resume playback function setting	see page 29
Inc Play	Incremental playback function setting	see page 29
Serial Mode (when sold-separately Ethernet card installed)	Serial Mode setting when Ethernet card installed (sold-separately)	see page 38
IRBaud Rate	RS-232C transmission speed setting	see page 38
Tuner Out Sel	Tuner broadcast sound output setting	see page 33
Information	Show information	see page 39
MP3 Bit rate	Set MP3 file bit rate	see page 37
IR Remote Lock	Remote control lock function setting	see page 22
Network Set. (when sold-separately Ethernet card installed)	Setting when Ethernet card installed (sold-separately)	
FACTORY PRESET	Restore factory default settings	see page 39

NOTE

The settings for all menu items are retained even when the unit is turned off.

Basic MENU screen operations

Operations are conducted on the MENU screen as follows.

Selecting items (moving vertically on a page):

Turn the **MULTI-JOG** dial on the main unit.
Use the **◀◀/▶▶** [**</>**] buttons on the remote control.

Confirming a selected item:

Press the **MULTI-JOG** dial on the main unit.
Press the remote control **ENTER** button.

Opening a submenu from a page:

Press the **MULTI-JOG** dial on the main unit.
Press the remote control **ENTER** button.

Selecting an item in a submenu:

Press the **MULTI-JOG** dial on the main unit.
Use the **◀◀/▶▶** [**</>**] buttons on the remote control.

Going back one step in a menu:

Press the main unit **BACK [PAIRING]** button.
Press the remote control **^** button.

Returning directly to the Home Screen from a menu screen:

Press the main unit **HOME/MENU** button.

Menu operation procedures

This example explains how to set the analog output attenuation function.

1. Press the main unit **HOME/MENU** button or remote control **MENU** button to open the MENU screen.

```
MENU
< APS Setting >
```

APS Setting menu item shown

2. Turn the main unit **MULTI JOG** dial or use the remote control **◀◀/▶▶** [**</>**] buttons to select the setting item.

```
MENU
< A.Out Att. >
```

A.Out Att. selected

3. Press the main unit **MULTI JOG** dial or remote control **ENTER** button to open the various setting screens.

```
A.Out Att.
< OFF >
```

A.Out Att. screen open

4. Turn the main unit **MULTI JOG** dial or use the remote control **◀◀/▶▶** [**</>**] buttons to change the setting.
5. Press the main unit **MULTI JOG** dial or remote control **ENTER** button to confirm the setting and return to the MENU screen.
6. Repeat steps 3 to 5 as necessary to set each item.
7. Press the main unit **BACK [PAIRING]** button or remote control **^** button to return to the Home Screen.

3 – Preparation

Making connections

This is an example of CD-400U connections.

Precautions before making connections

- Carefully read the operation manuals of the devices to be connected and then connect them correctly.
- Before making connections, turn this unit and all equipment to be connected off (standby).
- Install all connected devices, including this unit, so that they are powered from the same line. When using a power strip or similar device, be sure to use one that has high current capacity (thick cable) in order to minimize fluctuations in power voltage.

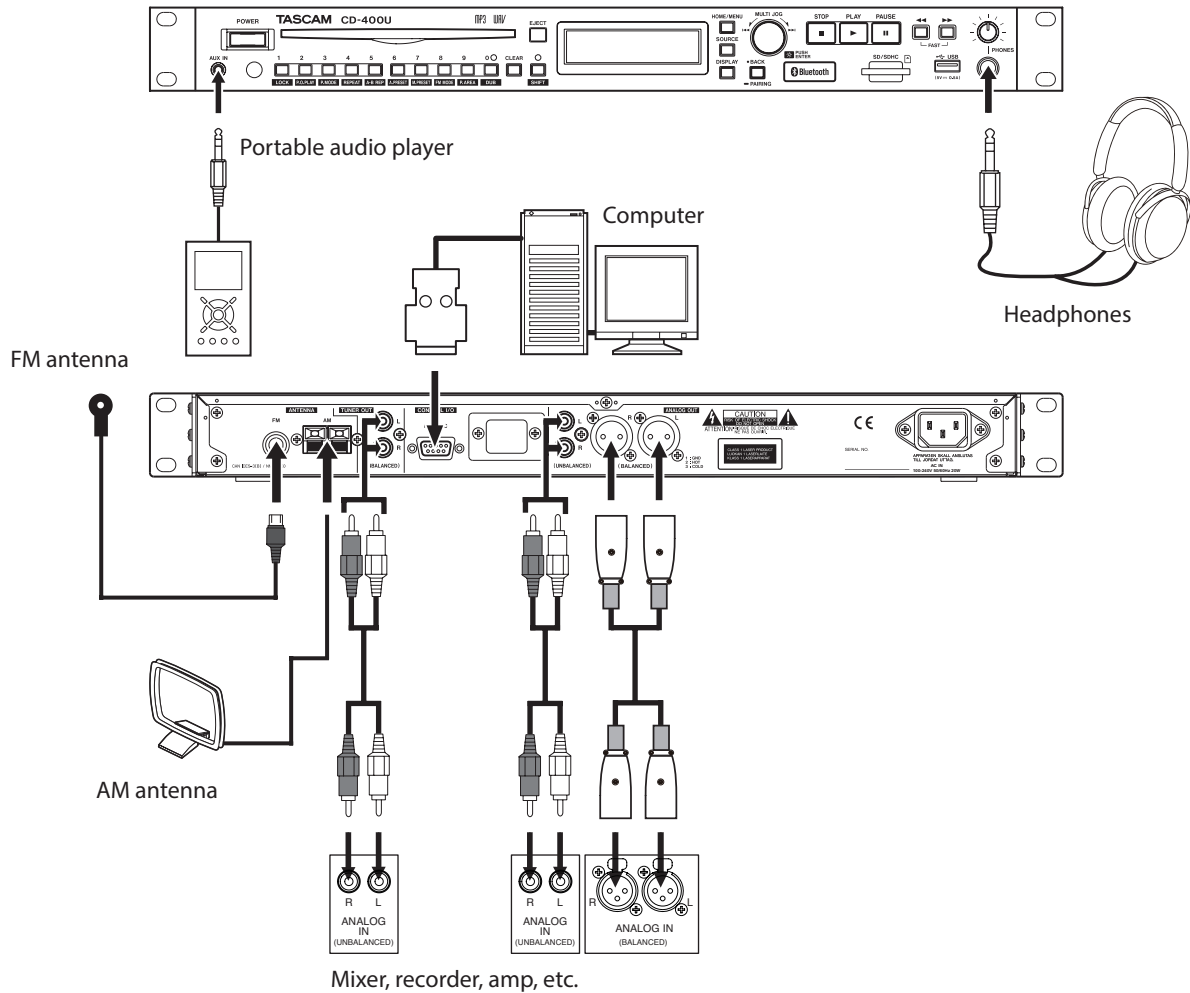

Assembling the AM antenna

To assemble the AM antenna, rotate the antenna base in the direction of the arrow, and insert the hook at the bottom of the antenna loop into the long hole in the antenna base.

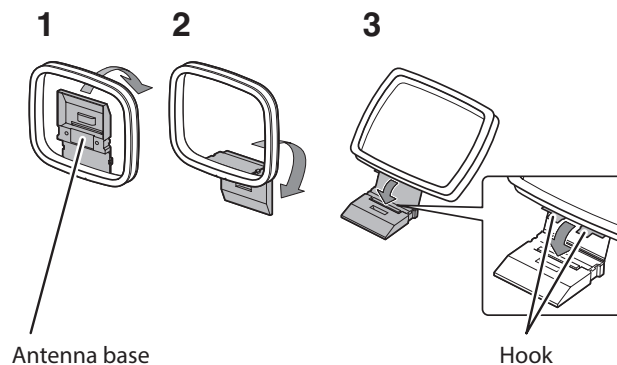

3 – Preparation

Preparing the remote control

Installing batteries

1. Open the cover on the back.
2. Insert two AAA batteries, being certain to use the correct ⊕ and ⊖ orientations.
3. Close the cover.

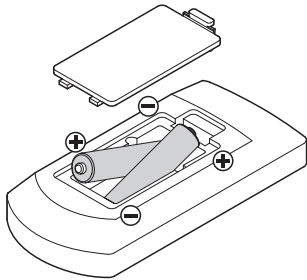

When to replace batteries

Replace both batteries with new ones if the distance from the main unit that the remote can be used decreases or if the unit stops responding to the remote buttons.

Battery precautions

Misuse of batteries could cause them to leak or rupture, for example. Carefully read and follow the battery caution labels. (see "CAUTIONS ABOUT BATTERIES" on page 3)

Using the wireless remote control

See Wireless remote control (TASCAM RC-CD400) page 16 for the button functions.

When using the remote control, point it toward the receiver on the unit and use it within the range shown below.

Remote control signal receiver

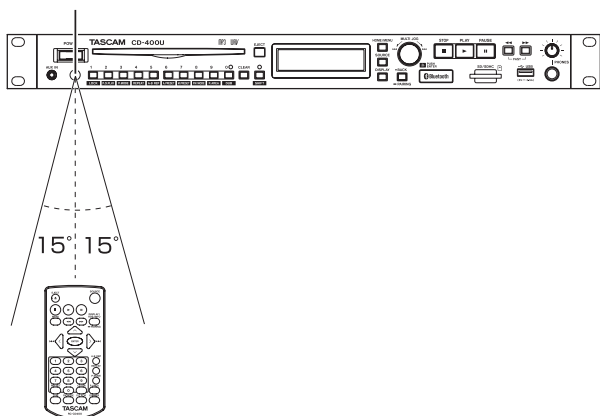

Remote control operation range

From any angle within 15° of front: 5 m

CAUTION

- The range will vary according to the angle.
- Operation might not be possible if there are obstacles.
- Remove the battery if not using the remote control for a long time (a month or more).
- If battery fluid should leak, wipe away any fluid inside the case thoroughly and install a new battery.
- When using other devices that can be controlled by infrared rays, operation of this remote control could cause those devices to function improperly.

Turning the unit on and off

Press the **POWER** switch on the front of the unit.



Startup screen

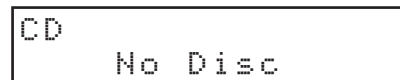

Home Screen

After the unit starts and the startup screen is shown, the Home Screen will open.

Turning the unit off

No special operations are necessary.

Press the **POWER** switch to turn the unit off.

CAUTION

Do not turn the power off or disconnect the power cord when the unit is operating (including playing back or writing data to an SD card or USB flash drive). Doing so could cause proper dubbing (copying) to fail, dubbed (copied) data to be lost, and sudden loud noises from monitoring equipment, which might damage the equipment, harm hearing or cause other trouble.

Adjusting the display brightness

Turn the **MULTI JOG** dial when the unit is in shift mode (**SHIFT** indicator lit), or press the remote control **DIMMER** button to adjust the display brightness.

Main unit operation:

dim ← → somewhat dim ← → normal

Remote-control operation:

normal → somewhat dim → dim → normal, etc.

Inserting and removing discs

Inserting discs

Insert the disc part way with its labeled side up. Push the disc in further until just before it disappears. It will automatically be drawn in to the slot.

CAUTION

- Discs cannot be inserted when the power is off.
- If the disc becomes stuck during insertion, for example, and is difficult to push, do not try to force it in. Pull the disc out once and press the **EJECT** button. Then, try inserting it again. (Trying to force the disc in could scratch it or damage the unit.)
- If a disc other than a playable CD is inserted or a disc is inserted upside down, the unit will automatically eject it.
- 8cm CDs cannot be used. If an 8cm CD is inserted, it will automatically be ejected.

Ejecting discs

Press the main unit or remote control **EJECT** button. When the disc is partially ejected, hold the edge and pull it out.

CAUTION

When the power is off, the main unit and remote control **EJECT** buttons will not function.

Forcing disc ejection

Press and hold the **EJECT** button for at least 10 seconds to force the disc to eject. (This will eject discs even when **No Disc** appears on the Home Screen)

Inserting and removing SD cards

Inserting SD cards

Insert an SD card into the SD card slot on the front of the unit to enable playback and dubbing by this unit.

NOTE

SD cards can be inserted whether or not the unit is on or off.

- Inserted SD cards with the correct orientation.
- The label should be up and the connector should be inserted toward the back.

Removing SD cards

Turn the unit off or stop operation before removing an SD card.

CAUTION

Do not remove an SD card when the unit is operating (including playing back or writing data to the SD card). Doing so could cause proper dubbing to fail, data to be lost, and sudden loud noises from monitoring equipment, which might damage the equipment, harm hearing or cause other trouble.

1. Press the SD card in gently to make it to come forward.
2. Pull the SD card out by hand.

SD card write protection switches

SD cards have write-protection switches that prevent writing new data to them.

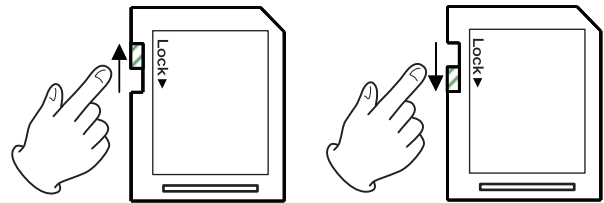

If you slide the write-protection switch to the LOCK position, dubbing will not be possible. Remove write-protection to use the dubbing (copying) function.

3 – Preparation

Connecting and disconnecting USB flash drives

Connecting USB flash drives

Connect a USB flash drive to the USB port on the front of the unit to enable playback and dubbing with this unit.

NOTE

You can connect a USB flash drive when the unit is on or off.

Disconnecting USB flash drives

Turn the unit off or stop operation before disconnecting a USB flash drive.

CAUTION

Never disconnect a USB flash drive when the unit is operating (including playing back or writing data to the USB flash drive). Doing so could cause proper dubbing to fail, data to be lost, and sudden loud noises from monitoring equipment, which might damage the equipment, harm hearing or cause other trouble.

Setting remote control reception

In order to prevent misoperation, the unit can be set to not accept remote control commands.

Use the MENU screen **IR Remote Lock** item to set whether or not the unit accepts remote control commands. (Default: **Un lock**)

NOTE

- When the remote control reception setting is **Lock**, if a remote control button is pressed, **IR Remote Locked** will appear on the display
- The remote-control reception on/off setting is retained even when the unit is turned off.

Panel lock functions

When the unit is in shift mode (**SHIFT** indicator lit), press the **1 [LOCK]** button to turn the front panel lock function on/off. This disables front panel button operations.

When the panel is locked, if a front panel button (excluding the **SHIFT** and **1 [LOCK]** buttons) is used, **Panel Locked** will appear on the display.

NOTE

- Even when the panel is locked, external control operations will be received through the **RS-232C** connector on the back of the unit.
- The panel lock function on/off setting is retained even when the unit is turned off.

Selecting the playback source.

Press the main unit or remote control **SOURCE** button to select the source played back by the main unit.

This changes the current source in the following order.

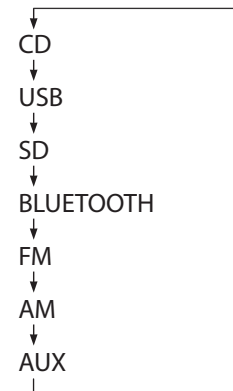

Current source switching order

The name of the current source (CD, USB, SD, BLUETOOTH, AM, FM or AUX) appears in the current source display area on the Home Screen.

NOTE

- When the current source is switched from CD to any other input source, the CD will stop if it is playing back or paused. In the same way, when switching from an SD card to another medium or from a USB flash drive to another input source, the previous source will stop if playing back or pause. (Bluetooth and AUX will not stop.)
- The playback mode setting is not cleared when the current source changes.

4 – CD/SD/USB playback

This chapter explains playback functions for audio files stored on CDs, SD cards and USB flash drives.

This explanation assumes that you have already loaded a CD, SD card or USB flash drive that contains audio files into the unit, that the unit is on, and that the current source is set appropriately. (see “Selecting the playback source.” on page 22)

Files that can be played back

This unit can play back files in the following formats.

Audio CDs

Commercially-available music CDs as well as CD-R and CD-RW discs that have been created in the audio CD format

Data CDs

CD-ROM/R/RW discs with MP3 or WMA files using ISO 9660 (Level 1, Level 2 or Joliet) recording formats can be played back.

SD card/USB flash drive

In addition to files (MP3) dubbed by this unit, this unit can play audio files that have been recorded by other units or written by a computer or other audio device if they use the following formats.

Files that can be played back	File formats
AAC	.m4a, .M4A
MP3	.mp3, .MP3
WAV	.wav, .WAV
WMA	.wma, .WMA

NOTE

- This unit cannot play CD-R/CD-RW discs that have not been finalized.
- For information about sampling frequencies and bit rates that can be played back, see “Playback file formats” at the end of this manual. (see “Ratings” on page 41)
- This display of this unit can only show half-width (normal) alphabet letters and numbers (single-byte). If a file name uses Japanese, Chinese or other full-width (double-byte) characters, playback is possible but those characters will be replaced with * on the display.
- MP3 files are recognized by the “.mp3” extension. Always add the “.mp3” extension to file names. This unit cannot play files without the “.mp3” extension. Furthermore, this unit cannot play files that have the “.mp3” extension if they are not in the MP3 data format.
- WAV files are recognized by the “.wav” extension. Always add the “.wav” extension to file names. This unit cannot play files without the “.wav” extension. Furthermore, this unit cannot play files that have the “.wav” extension if they are not in the WAV data format.
- Media with more than 300 files or 50 folders might not play properly.
- Depending on the condition of the disc, playback might skip or not be possible.

Tracks and folders on SD cards and USB flash drives

This unit handles audio files on SD cards and USB flash drives as “tracks”.

Some data CDs store files in folders in the same way that ordinary computer files are handled. Some also store multiple folders within a single folder, creating a multi-level structure.

This unit assigns track numbers to audio files for management. Track numbers are assigned in the following order.

1. Playable files in each folder are sorted in Unicode order. Folders, including empty folders and folders that do not contain playable files, are sorted in Unicode order.
2. If the root folder contains playable files, those files are assigned numbers first.
3. After all playable files in the root folder are assigned numbers, if there are lower-level folders with playable files in them, those files are assigned numbers
4. If there are more folders at an even lower level with playable files in them, those files are assigned numbers. If there are no folders in the lower level, the unit searches for folders on the same level, and then assigns numbers to the files in those folders.

During ordinary playback of SD cards and USB flash drives, tracks are played in numerical order in the same way as audio CDs.

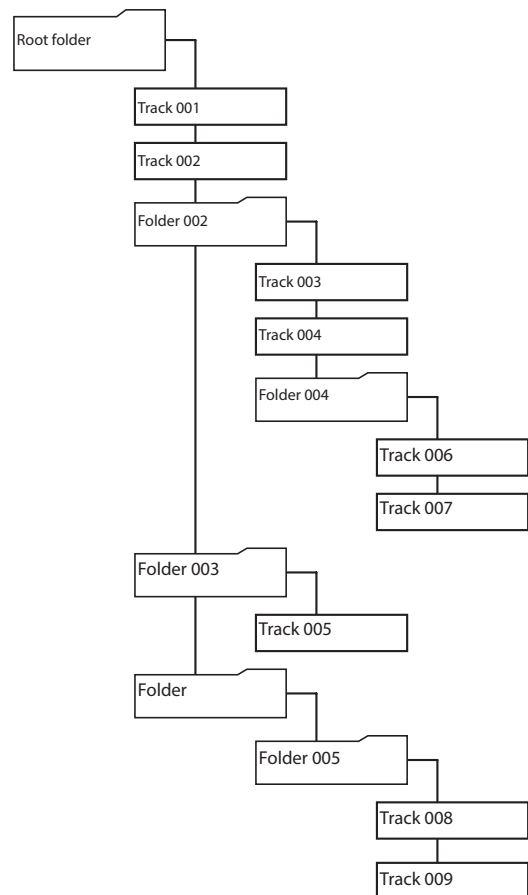

Track and folder structure example

4 – CD/SD/USB playback

Playback area

The range of tracks that can be selected for playback on the Home Screen is called the “playback area”.

When using audio CDs and CD-R/CD-RW discs (CD DA only) with MP3 and WMA files, the entire disc is always set as the play area. When using SD cards and USB flash drives, you can set folders as the play area.

Limiting the play area makes selection of playback tracks easier when you have numerous recorded files on an SD card or USB flash drive.

Setting the playback area

When the current source is USB or SD, press the **9 [P.AREA]** button with the shift mode active (**SHIFT** indicator lit) or press the remote control **P.AREA** button to set the play area.

Play area	Folder icon	Meaning
All	Not shown	Play all the files on the medium.
Folder	Shown	Play all the files in the folder that contains the currently selected file.

The  icon appears at the right side of the Home Screen when the play area is folder.



Basic playback operations

This section explains basic playback operations, including starting, stopping and pausing.

This explanation assumes that you have already made necessary connections, turned the unit on, loaded a medium that contains audio files, selected the current source, and opened the Home Screen on the display.

Playing tracks

Press the main unit **PLAY** button or the remote control  button to start playback.

Stopping playback:

Press the main unit **STOP** button or remote control  button.

Pausing playback:

Press the main unit **PAUSE** button or remote control  button.

Selecting tracks for playback

This is an explanation of how to select tracks if there are multiple tracks when the current source is CD and an audio CD is loaded, as well as when the current source is USB or SD and the play area is "All".







The two ways to select tracks are moving (skipping) backward/forward by track number and specifying track numbers directly.



NOTE

When the current source is USB or SD and the play area is folder ( icon shown), the number buttons on the main unit and remote cannot be used to designate tracks.





Skipping to earlier and later tracks

Turn the main unit **MULTI JOG** dial or use the remote control  /  [ / ] buttons to skip to the previous or next track.

- During track playback, turn the main unit **MULTI JOG** dial counterclockwise or press the remote control  [] button to return to the track beginning. When already at the beginning of a track, turn the **MULTI JOG** dial counterclockwise or press the remote control  [] button) to skip to the beginning of the previous track.
- When at the beginning or middle of a track, turn the main unit **MULTI JOG** dial clockwise or press the remote control  [] button) to skip to the next track.

After selecting a track, press the **PLAY** button or remote control  button to start playing it back. Instead of pressing the main unit **PLAY** button or remote control  button, press the **PAUSE** button or remote control  button to pause at the beginning of the selected track.

NOTE

- Only tracks in the current playback area can be played back.
- The track number, file name and other file information for the currently playing file appear on the display.
- Turn the main unit **MULTI JOG** dial or use the remote control  /  [ / ] buttons as necessary to move between tracks.

Selecting tracks directly

The number buttons on the main unit and the remote control can be used to directly enter track numbers.

For track numbers, a maximum of two digits can be input for audio CDs and three digits for discs with MP3 and WAV format files.

1. Use the number buttons on the main unit or the remote control to enter track numbers.
Enter the track number digits in order, starting with the largest.

Audio CD track number entry

Set with two digits.

Example: for track 9, input 0 → 9

Data CD/USB/SD track number entry

Set with three digits.

Example 1: for track 105, input 1 → 0 → 5

Example 2: for track 4, input 0 → 0 → 4

2. Press the main unit **PLAY** button or remote control **▶** button.
The selected track will start to play.
Playback can also be started by pressing the main unit **MULTI JOG** dial or remote control **ENTER** button.
3. Press the main unit **STOP** button or remote control **■** button to end track number input and return to the regular display.

NOTE

- If you input the wrong number, you can press the **CLEAR** button to delete the input value.
- The largest number that can be shown for the currently playing track is 999. If the track number exceeds 1000, --- will be shown.
- In random mode, the number buttons cannot be used to set tracks.

Folder playback (SD cards and USB flash drives only)

When the current source is **USB** or **SD** and the play area is folder (📁 icon shown), the selected folder (the current folder) can be set as the play area.

Follow the method explained below to designate the playback folder.

1. Select **USB** or **SD** as the current source. (see “Selecting the playback source.” on page 22)
2. Set the play area to folder (📁 icon shown). (see “Setting the playback area” on page 24)

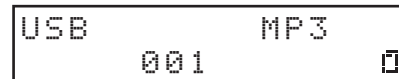

3. Turn the main unit **MULTI JOG** dial or use the remote control **◀◀/▶▶** [**</>**] buttons to select a track/folder.
The top line of the Home Screen shows the file or folder name, and the 📁 icon starts to blink.

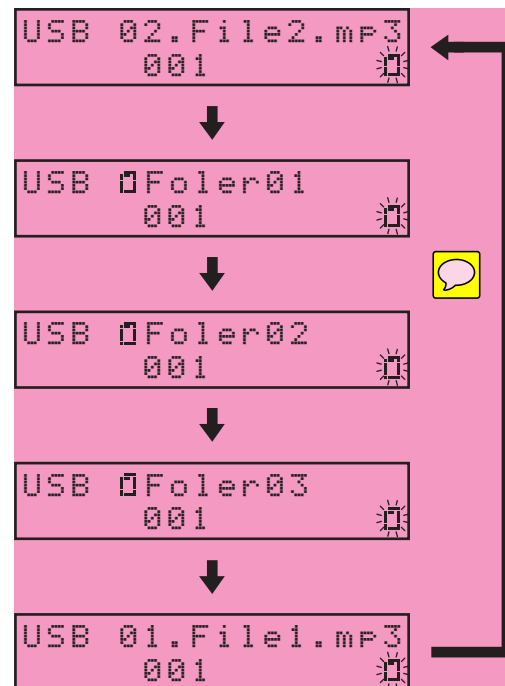

NOTE

- To cancel track/folder selection, press the **CLEAR** button on the main unit or remote control.
- If you select a folder that does not contain any audio files, **NO FILE** will be shown. At this time, if you turn the main unit **MULTI JOG** dial or press the **◀◀/▶▶** [**</>**] buttons, the name of the currently selected file will be shown and movement might become impossible. If this happens, press the **CLEAR** button on the main unit or remote control to cancel selection. Then, try again.
- The current folder will change along with movement between folders.

4 – CD/SD/USB playback

4. When the  icon is blinking, press the main unit **MULTI JOG** dial or remote control **ENTER** button to start playback if a track is selected or to move down one level if a folder is selected.

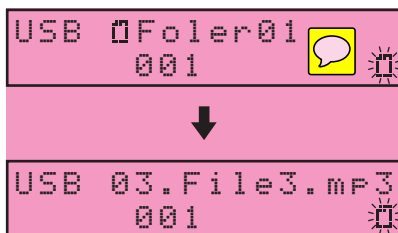

To move up one level, press the main unit **BACK [PAIRING]** button or remote control \wedge button.

5. When the  icon is blinking, press the main unit **MULTI JOG** dial or remote control **ENTER** button to select that track and start playback.

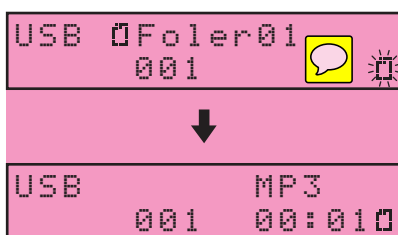

NOTE

- If repeat playback is activated during folder playback, the tracks in the current folder will be played repeatedly.
- If random playback is activated during folder playback, the tracks in the current folder will be played randomly.

Activating skip mode

When the play area is folder ( icon shown), press and hold the main unit **MULTI JOG** dial or remote control **ENTER** button to activate skip mode. An **S** will appear on the Home Screen.

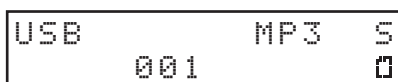

In this mode, turn the main unit **MULTI JOG** dial or use the remote control \lll / \ggg [\ll / \gg] buttons to skip to earlier and later tracks that are on the same level. Tracks on the same level can also be designated directly. (see “Selecting tracks directly” on page 25)

NOTE

When in skip mode, press and hold the main unit **MULTI JOG** dial or remote control **ENTER** button to make **S** disappear and return to ordinary folder mode.

Playback modes

This unit has three playback modes. The current playback mode is shown on the Home Screen.

Continuous playback mode (default setting)

Tracks in the playback area will be played in track number order.

NOTE

When using an SD card or USB flash drive and the play area is folder ( icon shown), tracks in the currently playing folder will be played in numerical order.

Single playback mode

The selected track will be played and stop after playback.

Random playback mode

All tracks in the playback area will be played in random order regardless of track number.

NOTE

When using an SD card or USB flash drive and the play area is folder ( icon shown), tracks in the current folder will be played in random order. (see “Folder playback (SD cards and USB flash drives only)” on page 25)

Setting the playback mode

When shift mode is active (**SHIFT** indicator lit), press the main unit **3 [P.MODE]** button or the remote control **P.MODE** button to change the playback mode.

Each time you press this button, the playback mode will change.

Indicator	Playback mode
Not shown	Continuous playback mode
1	Single playback mode
RND	Random playback mode

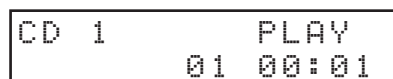

Single playback mode active

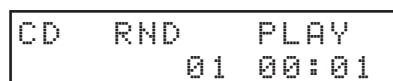

Random playback mode active

NOTE

- Unless otherwise specified, explanations in this manual assume that the playback mode is set to continuous playback mode.
- The current playback mode appears on the Home Screen.

Searching backward and forward

You can search backward and forward within a track while listening to it.

1. Play or pause the desired track.
2. Press and hold the main unit ◀◀/▶▶ [FAST] buttons or the remote control ◀◀/▶▶ buttons to start searching backward/forward.
3. To stop searching, release the button you are pressing. The state (playing or paused) before searching started will resume.

NOTE

- If the end of a track is reached when searching forward, the unit skips to the next track and starts searching it from the beginning.
- If the end of the last track is reached when searching forward, the unit stops.
- If the beginning of a track is reached when searching backward, the unit skips to the track before it and starts searching it from the end.
- If the beginning of the first track is reached when searching backward, playback pauses, but will resume when the button is released.
- When searching backward/forward by pressing the ◀◀/▶▶ button, press and hold the other ◀◀/▶▶ button for the opposite direction to search at high speed. (Audio CDs only)

Using the repeat playback function

All tracks in the playback area can be played back repeatedly. Specified intervals within a track can also be played back (A-B repeat playback).

Ordinary repeat playback settings

When the repeat playback function is on, operation depends on the playback mode setting.

Playback mode setting	Function
Continuous playback mode	Repeat playback of the tracks in the set play area
Single playback mode	Repeat playback of the current track

To turn the repeat playback function on/off, activate the shift mode (SHIFT indicator lit) and press the main unit **4 [REPEAT]** button or remote control **REPEAT** button.

REP appears on the Home Screen when the repeat function is on.

```

CD      REP  PLAY
          01  00:01
    
```

Continuous playback mode active

```

CD  1REP  PLAY
          01  00:01
    
```

Single playback mode active

NOTE

- The repeat playback setting is retained even when the unit is turned off.
- The repeat playback function cannot be turned on when the random playback mode is active (RND shown on display).

4 – CD/SD/USB playback

A-B repeat playback settings (audio CDs only)

Specified intervals within a track can be played back (A-B repeat playback). Follow the procedures below to use A-B repeat playback.

1. Select **CD** as the current source. (see “Selecting the playback source.” on page 22)
2. When playing back or when playback is paused at the point where you want the repeat playback interval to start (A), press the main unit **5 [A-B REP]** button when the shift mode is activated (**SHIFT** indicator lit) or press the remote control **A-B REP** button.
A- appears on the Home Screen.

```
CD  A-      PLAY
      01 00:10
```

3. At the point where you want the repeat playback interval to stop (B), press the main unit **5 [A-B REP]** button when the shift mode is activated (**SHIFT** indicator lit) or press the remote control **A-B REP** button.
A-B appears on the Home Screen.
This confirms the set interval (A-B) and starts A-B repeat playback.

```
CD  A-B     PLAY
      01 00:22
```

CAUTION

A-B repeat is not possible with data CDs, SD cards or USB flash drives.

NOTE

- Press the main unit **STOP** button or remote control **■** button to stop the unit and clear the set A-B repeat interval. Changing the track or the current source will also clear the repeat interval.
- The A-B repeat playback interval cannot include more than one track.
- The A-B repeat setting is not retained when the unit is turned off.

Using the power-on-play function

By using a commercially-available timer, for example, to turn this unit on, you can make it start playing at a desired time.

1. Connect the unit to the timer so that it receives power from the timer power output in advance.
2. Select the current source for playback. (see “Selecting the playback source.” on page 22)
3. Press the main unit **2 [P.O PLAY]** button when shift mode is active (**SHIFT** indicator lit) or press the remote control **P.O PLAY** button to turn the power-on-play function on. (Default: off)

```
PWR On Play On
      01 00:01
```

4. With this unit's **POWER** switch set to on, turn the power off from the timer, and set the timer to turn on at the desired time.
The power will turn on at the desired time, and the unit will automatically start playback.

NOTE

- The **P** icon appears on the Home Screen when the power-on-play function is on.

```
CD                PLAY P
      01 00:10
```

- The power-on-play function on/off setting is retained even when the unit is turned off.

Using the resume function

When the resume playback function is on, playback can restart from the point where it was last stopped (resume point).

When using data CDs, SD cards and USB flash drives, the unit can remember the track where playback stopped. Then, the next time playback is started it can start playback from the beginning of that track.

The following actions will clear the resume point.

- The medium is ejected
- The playback area is changed
- The playback mode is changed
- The content of the current source is changed (dubbing function used)

Use the menu to turn the resume playback function on/off.

1. Select the **Resume Setting** item on the **MENU** screen to open the **Resume Setting** screen. (see “Menu operation procedures” on page 18)

```

Resume Setting
<          ON          >
    
```

2. Turn the resume playback function on or off.
Options: OFF, ON (default)
3. Confirm the setting and return to the **MENU** screen.

NOTE

- If there is no resume point (no time has been set as the resume point), the beginning of the playback track will become the resume point.
- The resume playback function on/off setting is retained even when the unit is turned off.

Using the incremental playback function

When the incremental playback function is on, press the main unit **PLAY** button or remote control ► button during playback to start playback from the beginning of the next track. Press the main unit **STOP** button or remote control ■ button during playback to pause at the beginning of the next track.

1. Select the **Inc Play** item on the **MENU** screen to open the **Inc Play** screen. (see “Menu operation procedures” on page 18)

```

Inc Play
<      OFF      >
    
```

2. Turn the incremental playback function on or off.
Options: OFF (default), ON
3. Confirm the setting and return to the **MENU** screen.

NOTE

When the incremental playback function is on and playback is paused, press the main unit **PLAY** button or remote control ► button to start playback from where it is paused.

When playback is paused, press the main unit **STOP** button or remote control ■ button to stop playback. When the last track is playing back, press the main unit **PLAY** button or remote control ► button to start playback from the beginning of the first track in the play area. Press the main unit **STOP** button or remote control ■ button to pause at the first track in the play area.

NOTE

The incremental play function on/off setting is retained even when the unit is turned off.

4 – CD/SD/USB playback

Time and text information display

When the current source is **CD**, **USB** or **SD**, press the main unit **DISPLAY** button or remote control **DISPLAY/RDS/INFO [PAIRING]** button to select the time or text information shown on the Home Screen.

Press the main unit **DISPLAY** button or remote control **DISPLAY/RDS/INFO [PAIRING]** button to cycle through the types of information shown.

The types of information shown change according to the type and status of the media set as the current source as well as the unit operation status.

Audio CDs

When playing back or paused, you can cycle through what is displayed: track elapsed time → track remaining time → total track elapsed time → total track remaining time.

Indicator	Meaning
Not shown	Track elapsed time
TRACK-R	Track remaining time
TOTAL	Total track elapsed time
TOTAL-R	Total track remaining time

Data CDs, SD cards and USB flash drives

When playing back, paused or stopped, you can cycle through what is displayed: track elapsed time → file name of current track → title of current track → name of current track artist → name of current track album → folder name.

Shown	Meaning
Not shown	Track elapsed time
FILE	File name of current track
TITLE	Title of current track
ARTIST	Name of current track artist
ALBUM	Name of current track album
FOLDER	Folder name

NOTE

- The text information shown on the display is from the ID3/WMA tags for data CDs and from the ID3/WMA/AAC tags for SD cards and USB flash drives.
If this information is not stored with the disc or file, nothing will appear after **TITLE :** and **ARTIST :**.
If characters that cannot be displayed are included in the data, they will be replaced with *.
- The information display setting is retained even when the unit is turned off.
- On SD cards and USB flash drives written by Mac computers, the numbers of tracks in folders and the track numbers might not match. This is an existing problem in Mac system files, but it does not affect playback by this unit.

5 – Bluetooth device playback

This unit can output sound from a computer, portable audio device or other equipment that supports Bluetooth (A2DP). Moreover, if the Bluetooth device supports AVRCP, the **PLAY** button and other controls on this unit can be used to control playback on the Bluetooth device.

Pairing

Follow the procedures below to enable communication with a Bluetooth device.

NOTE

Pairing also requires operation of the Bluetooth device. Refer to the operation manual of the Bluetooth device for procedures.

1. Select **BLUETOOTH** as the current source. (see “Selecting the playback source.” on page 22)
2. Press and hold the main unit **BACK [PAIRING]** button or remote control **DISPLAY/RDS/INFO [PAIRING]** button. A **PAIRING** message will blink on the display.



BLUETOOTH
PAIRING

3. Enable Bluetooth transmission on the other Bluetooth device.
4. Select CD-400U (this unit) on the other Bluetooth device. When pairing succeeds, this unit and that device will be connected and **Connected** will appear on the Home Screen.



BLUETOOTH
Connected

NOTE

- Some older Bluetooth devices require the input of a passkey. Enter 0000 in such cases.
- Pairing will automatically end if connection is not confirmed within two minutes.
- When this unit is turned on, it will automatically try to connect with the Bluetooth device to which it was previously connected. At this time, pairing will automatically end after five minutes if connection is not possible because that Bluetooth device is not turned on or its Bluetooth function is turned off.

Usable controls

Controls on the main unit and included wireless remote control (RC-CD400) can be used to control the connected Bluetooth device if it supports AVRCP.

Main unit	Remote control	Function
PLAY button	▶ button	Play
PAUSE button	⏸ button	Pause
STOP button	■ button	Stop
MULTI JOG dial turning	⏮/⏭ [</>] buttons	Selects tracks
⏮/⏭ [FAST] buttons	⏮/⏭ buttons	Search backward and forward

CAUTION

Operation might not occur properly depending on the connected Bluetooth device.

Playback from a Bluetooth device.

After pairing with the other Bluetooth device in advance, follow the procedures below for playback from it.

1. Select **BLUETOOTH** as the current source. (see “Selecting the playback source.” on page 22)
2. Connect to CD-400U (this unit) on the other Bluetooth device. **Connected** appears on the Home Screen when connection completes.

Controls on the main unit and included wireless remote control (RC-CD400) can be used to control the connected Bluetooth device, and this unit can output the playback sound from the Bluetooth device.

Unpairing

The Bluetooth device that is currently connected can be unpaired from the unit.

1. Select **BLUETOOTH** as the current source. (see “Selecting the playback source.” on page 22)
2. Press the main unit **BACK [PAIRING]** button or remote control **DISPLAY/RDS/INFO [PAIRING]** button. A **Disconnect?** message will appear on the display.



BLUETOOTH
Disconnect?

3. Press the main unit **MULTI JOG** dial or remote control **ENTER** button to unpair the device. Press the main unit **BACK [PAIRING]** button or remote control **CLEAR** button to cancel unpairing.
4. After unpairing, ordinary operation will start.

6 – Listening to AM/FM radio

This unit can be used to listen to AM/FM radio. The following instructions assume that the current source has been set to AM or FM. (see “Selecting the playback source.” on page 22)

Tuning in radio stations

Changing the received frequency

Changing the frequency

Press the main unit **STOP** or remote control **■** button to switch between frequency selection mode (preset numbers not shown) and preset mode (preset numbers shown).

When in preset mode, **P01** appears on the Home Screen.

```
FM          STEREO
P01  80.00MHz
```

Raising the received frequency

When in frequency selection mode, turn the main unit **MULTI JOG** dial clockwise or use the remote control **▶▶ [>]** button to raise the received frequency by one step.

When in frequency selection mode, press the main unit **▶▶ [FAST]** button or remote control **▶▶** button to automatically search for received frequencies in the higher direction.

Lowering the received frequency

When in frequency selection mode, turn the main unit **MULTI JOG** dial counterclockwise or use the remote control **◀◀ [<]** button to lower the received frequency by one step.

When in frequency selection mode, press the main unit **◀◀ [FAST]** button or remote control **◀◀** button to automatically search for received frequencies in the lower direction.

Setting the FM mode

Activate shift mode (**SHIFT** indicator lit) and press the main unit **8 [FM MODE]** button, or press the remote control **FM MODE** button to switch between stereo and mono reception.

```
FM          STEREO
          80.00MHz
```

STEREO (stereo, default)

The unit will receive stereo FM broadcasts in stereo.

- If reception is poor, switch to **MONO** (mono) reception.

MONO (mono)

The unit will receive FM broadcasts in mono. When the reception of an FM stereo broadcast is poor, select this mode. The sound becomes mono, but noise is also reduced, making it sound better.

NOTE

Mono reception mode will automatically be disabled when the received frequency is changed.

Setting radio station presets

This unit can have up to 20 FM and 20 AM presets.

NOTE

Unless the preset memory is cleared, preset radio stations will be retained even when the unit is turned off. (see “Clearing preset assignments” on page 33)

Setting radio station presets automatically

1. Select the current source for the presets (**AM** or **FM**). (see “Selecting the playback source.” on page 22)
2. Press the main unit **6 [A.PRESET]** button when shift mode is active (**SHIFT** indicator lit) or press and hold the remote control **PRESET** button.

The following message will appear on the Home Screen.

```
FM
A.Preset OK?
```

3. Press the main unit **MULTI JOG** dial or remote control **ENTER** button to start automatically setting presets.

```
FM
Auto Preset
```

The unit will automatically search for radio stations and set them in order, starting with preset 01 (P01). The unit will stop automatically adding presets when 20 have been added or the reception frequency range has been searched completely.

Setting radio station presets manually

1. Select the current source for the presets (**AM** or **FM**). (see “Selecting the playback source.” on page 22)
2. Tune in the station that you want to add as a preset. (see “Changing the received frequency” on page 32)
3. Press the main unit **7 [M.PRESET]** button when shift mode is active (**SHIFT** indicator lit) or press the remote control **PRESET** button.

P01 will blink at the top of the Home Screen.

```
FM  P01  STEREO
P01  80.00MHz
```

NOTE

- The blinking **P01** will disappear after some time passes.
 - If ***** appears, the preset already has an assigned frequency.
4. Turn the main unit **MULTI JOG** dial or use the remote control **◀◀/▶▶ [< / >]** buttons to select the preset number to assign.
 5. Press the main unit **MULTI JOG** dial or remote control **ENTER** button to confirm the preset.

6 – Listening to AM/FM radio

Selecting preset stations

- When in preset mode, turn the main unit **MULTI JOG** dial or use the remote control **^ and v** buttons to select a preset station.
- You can also use the main unit or remote control number buttons to directly enter a preset number, and press the **ENTER** button to select that station.

Clearing preset assignments

1. Select the current source for the preset to be cleared (AM or FM). (see “Selecting the playback source.” on page 22)
2. Press and hold the main unit or remote control **CLEAR** button. The following message will appear on the Home Screen.

```
FM Clear all  
Presets OK?
```

Before clearing FM station presets

```
AM Clear all  
Presets OK?
```

Before clearing AM station presets

3. Press the main unit **MULTI JOG** dial or remote control **ENTER** button. After all preset assignments for the current source have been cleared, the Home Screen reopens.

NOTE

Press the main unit or remote control **CLEAR** button to **cancel the operation and** return to the Home Screen.

Muting tuner broadcast sound

The tuner can be muted when reception is poor or unpleasantly noisy.

1. Select the Tuner **AutoMute** item on the MENU screen to open the Tuner **AutoMute** screen. (see “Menu operation procedures” on page 18)

```
Tuner AutoMute  
< OFF >
```

2. Turn the tuner mute function on/off.
Options: OFF (default), ON
3. Confirm the setting and return to the MENU screen.

Setting the tuner broadcast outputs

You can set whether tuner broadcast signals are output from the **TUNER OUT** jacks only or from all the main unit jacks (**TUNER OUT**, **ANALOG OUT** and **PHONES** jacks).

1. Select the Tuner **Out Set** item on the MENU screen to open the Tuner **Out Set** screen. (see “Menu operation procedures” on page 18)

```
TunerOut Set.  
< ALL >
```

2. Set the outputs for sounds from the tuner.

Option	Meaning
TUNEROUT	Tuner broadcasts sounds are output only from the TUNER OUT jacks.
ALL (default)	Tuner broadcast signals are output from all the main unit jacks (TUNER OUT , ANALOG OUT and PHONES jacks).

3. Confirm the setting and return to the MENU screen.

NOTE

The tuner audio output setting is retained even when the unit is turned off.

6 – Listening to AM/FM radio

RDS (European model only)

The Radio Data System (RDS) is a broadcasting service that allows stations to send additional information along with the regular radio program signal.

- RDS works on the FM frequency band in Europe only.

1. Tune in to an FM RDS station. (see “Tuning in radio stations” on page 32)
2. Press the main unit **DISPLAY** button or remote control **DISPLAY/RDS/INFO [PAIRING]** button to cycle through the following RDS modes.

Program service (PS)

When you select Program service, **PS** will appear to the right of **FM** and then the program service name or station's name will be displayed. If there is no program service data, the frequency will be displayed.

RDS Program type (PTY)

When you select RDS Program type, **PTY** will appear to the right of **FM** and then the program type will be displayed.

RDS Radio text (RT)

When you select RDS Radio text, **RT** will appear to the right of **FM** and then information from the station consisting of up to 64 characters will be displayed.

PTY search

You can search for stations by program type. This function is available only through the RDS services of FM frequency stations in Europe.

1. Press the main unit **5 [A-B REP]** button when shift mode is active (**SHIFT** indicator lit) or press the remote control **A-B REP** button.
PTY SEARCH appears on the display.
2. Turn the main unit **MULTI JOG** dial or use the remote control **./▶▶▶ [</>]** buttons to select the desired program.
You can select from 31 program types (PTY).
3. Press the main unit **MULTI JOG** dial or remote control **ENTER** button to confirm the selection.
The unit starts searching.
 - When the program type that you have selected is found, searching stops and the program type will be displayed.
 - If a matching program type is not found during PTY Search, it will stop at the frequency set before searching started.
 - To stop searching, press the main unit **5 [A-B REP]** button when shift mode is active (**SHIFT** indicator lit) or press the remote control **A-B REP** button.

RDS Program type

NEWS:

Brief announcements, events, public opinion, reports and real situations.

AFFAIRS:

Suggestions, including practical announcements other than news, documents, discussion and analysis.

INFO:

Useful and reference information, such as weather forecasts, consumer guides and medical advice.

SPORT:

Sports-related programs.

EDUCATE:

Educational and cultural information.

DRAMA:

All kinds of radio concerts and serial dramas.

CULTURE:

All aspects of national or local culture, including religious events, philosophy, social science, language and theatre.

SCIENCE:

Programs on natural science and technology.

VARIED:

Popular programs such as quizzes, entertainment news, interviews, comedy and satire.

POP M:

Programs of commercial and popular songs, including music sales volumes, etc.

ROCK M:

Modern music generally composed and played by young musicians.

EASY M:

Popular music usually lasting for less than 5 minutes.

LIGHT M:

Classical music, instrumental music, chorus, and light music favored by general audiences.

CLASSICS:

Orchestral music including great operas and symphonies, chamber music and so on.

OTHER M:

Other music styles, including rhythm & blues and reggae.

WEATHER:

Weather reports and forecasts.

FINANCE:

Financial reports, commerce and trading.

CHILDREN:

Children's programs.

SOCIAL:

Social affairs.

RELIGION:

Religious programs.

PHONE IN:

Programs in which the public expresses its views by phone.

TRAVEL:

Travel reports.

LEISURE:

Programs concerning recreational activities.

JAZZ:

Jazz music.

COUNTRY:

Country music.

NATION M:

National music.

OLDIES:

Music from the so-called golden age of popular music.

FOLK M:

Folk music.

DOCUMENT:

Documentaries.

TEST:

Broadcast when testing emergency broadcast equipment or receivers. Not intended for searching or dynamic switching for consumer receivers.

ALARM!:

A program with notifications about emergencies and natural disasters.

7 – Dubbing (copying) functions

Using the dubbing (copying) functions of this unit, the content of audio CDs and AM/FM broadcasts can be copied to SD cards and USB flash drives. The format used for the files on the dubbing destination can also be changed.

Dubbing overview

Regardless of the playback mode setting, audio CDs are played continuously while being dubbed to SD cards and USB flash drives. This unit can record AM/FM broadcasts to SD cards and USB flash drives.

Some dubbing operations might delete existing files.

NOTE

This unit cannot simultaneously dub to both an SD card and a USB flash drive.

Dubbing file formats

This unit can write the following file formats to the dubbing destination.

- Dubbing from audio CDs
MP3 files (96/128/192/320 kbps)
- Dubbing from AM/FM radio
MP3 files (96/128 kbps)

For details about setting the MP3 file bit rate, see Make dubbing format settings page 37.

NOTE

When dubbing, a folder named `"/music/albumXXX/"` is created and files named `"trackXXX.wav/mp3"` are created for each CD track on the destination. ("XXX" are three-digit numbers such as "001".)

Operation when dubbing

Operation is as follows when the unit is dubbing.

- Actions other than dubbing are not possible.
- While dubbing, the audio of the CD being dubbed is output. The `DUB AutoMute` item can be set to `ON` to stop output. (see "Muting analog outputs while dubbing" on page 37)
- Playback of SD cards and USB flash drives is not possible while dubbing.
- Regardless of the playback mode setting, audio CDs are played continuously while dubbing.

NOTE

- Depending on the SD card or USB flash drive used while dubbing, errors could occur if writing cannot keep up with audio input.
- When copying from an audio CD, silent gaps will occur even between tracks that sounded continuous on the CD.

Dubbing from content on SD cards and USB flash drives

This unit can only dub from CD and AM/FM radio sources. This unit cannot dub from data CDs, SD cards, USB flash drives, Bluetooth devices or the AUX input.

Dubbing to write-protected media

`Write Protected` will appear on the Home Screen for several seconds before the display returns to the previous state.

Dubbing to media that does not have enough open space

`Media Full` will appear on the Home Screen for several seconds before the display returns to the previous state. Moreover, if the dubbing destination runs out of space while dubbing, `Media Full` will appear on the Home Screen for several seconds and dubbing will stop.

Dubbing procedures

1. Load the audio CD or tune in the radio frequency that you want to dub.
2. Select the media to copy as the current source (CD, AM or FM). (see "Selecting the playback source" on page 22)
3. When stopped, press the main unit **0 [DUB]** button when shift mode is active (**SHIFT** indicator lit) or press the remote control **DUB** button to activate dubbing mode.



```
CD          DUBBING
*USB <>    SD
```

4. Turn the main unit **MULTI JOG** dial or use the remote control **◀◀/▶▶** [**</>**] buttons to select the dubbing destination (USB or SD).

NOTE

- Regardless of the current source setting, dubbing will occur to the loaded SD card or USB flash drive if only one is loaded.
 - This unit cannot simultaneously dub to both an SD card and a USB flash drive.
5. Press the main unit **MULTI JOG** dial or remote control **ENTER** button to confirm the dubbing destination medium and open the following screen.

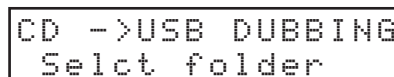

```
CD ->USB DUBBING
Select folder
```

USB selected

NOTE

- If the dubbing destination medium is write-protected, a `Write Protected` message will appear. Press the main unit or remote control **CLEAR** button to close the message and return to the Home Screen.
- If the dubbing destination medium does not have enough open space, a `Media Full` message will appear. Press the main unit or remote control **CLEAR** button to close the message and return to the Home Screen. Moreover, if the dubbing destination runs out of space while dubbing, a `Media Full` message will appear and dubbing will stop. Press the main unit or remote control **CLEAR** button to close the message and return to the Home Screen.

6. Turn the main unit **MULTI JOG** dial or use the remote control **◀◀/▶▶** [**</>**] buttons to select the dubbing destination folder.



```
CD ->USB DUBBING
ROOT
```

7 – Dubbing (copying) functions

7. Press the main unit **0 [DUB]** button or remote control **DUB** button again to start dubbing.

```
CD ->USB DUBBING
      01 00:01
```

8. To stop dubbing, press the main unit **STOP** button or remote control **■** button.
A **Complete** message will appear, and the Home Screen will reopen.
When the current source is **CD**, dubbing will automatically stop after the last track on the CD has been copied.

NOTE

The date and time information for the folders and files created are fixed and might be different from the current date and time depending on the dubbing.

Muting analog outputs while dubbing

Output from the **ANALOG OUT (UNBALANCED) L/R** and **ANALOG OUT (BALANCED) L/R** jacks can be muted to prevent the dubbed sound from being output to connected equipment while recording (dubbing).

1. Select the **DUB AutoMute** item on the **MENU** screen to open the **DUB AutoMute** screen. (see “Menu operation procedures” on page 18)

```
DUB AutoMute
<      OFF      >
```

2. Turn the dubbing mute function on/off.
Options: OFF (default), ON
3. Confirm the setting and return to the **MENU** screen.

NOTE

The dubbing mute function on/off setting is retained even when the unit is turned off.

Make dubbing format settings

Set the dubbing format.

1. Select the **Dubbing Format** item on the **MENU** screen to open the **MP3 Bit rate** screen. (see “Menu operation procedures” on page 18)

```
Dubbing Format
< mp3:128 kbps >
```

2. Set the dubbing format.
Options: 96 kbps, 128 kbps (default), 192 kbps, 320 kbps, **wav**
3. Confirm the setting and return to the **MENU** screen.

NOTE

The dubbing format setting is retained even when the unit is turned off.

Recording times when dubbing

The table below shows maximum recording times when dubbing on SD/SDHC cards and USB flash drives of different capacities by file format.

File format (set when dubbing)			SD/SDHC card or USB flash drive capacity				
			4 GB	8 GB	16 GB	32 GB	64 GB
WAV (STEREO)	16-bit	44.1kHz	6 hours 17 minutes	12 hours 35 minutes	25 hours 11 minutes	50 hours 23 minutes	About 100 hours
MP3 (STEREO)	96kbps	44.1kHz	92 hours 35 minutes	About 185 hours	About 370 hours	About 740 hours	About 1481 hours
	128kbps	44.1kHz	69 hours 26 minutes	About 138 hours	About 277 hours	About 555 hours	About 1111 hours
	192kbps	44.1kHz	46 hours 17 minutes	92 hours 35 minutes	About 185 hours	About 370 hours	About 740 hours
	320kbps	44.1kHz	27 hours 46 minutes	55 hours 33 minutes	About 111 hours	About 222 hours	About 444 hours

- The recording times shown above are estimates. They might differ depending on the SD/SDHC card or USB flash drive in use.
- The recording times shown above are not continuous recording times, but rather they are the total possible recording times for the SD/SDHC card or USB flash drive.

8 – Other functions

Setting the automatic power saving function

When the automatic power saving function is on, the unit will enter standby mode under the following conditions.

- If 30 minutes pass while stopped or paused when the current source is **CD**, **USB** or **SD**.
- If 30 minutes pass without pairing when the current source is **BLUETOOTH**.
- If 8 hours pass when the current source is **AUX**, regardless of whether or not there is an input signal.

NOTE

When the current source is **AM** or **FM**, the unit will not enter standby even if the automatic power saving function is on.

1. Select the **APS Setting** item on the **MENU** screen to open the **APS Setting** screen. (see “Menu operation procedures” on page 18)

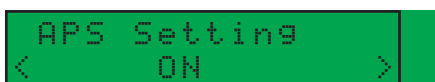

2. Turn the automatic power saving function on/off.
Options: **OFF** (default), **ON**
Options: **OFF**, **ON** (default)
3. Confirm the setting and return to the **MENU** screen.

Adjusting the analog output

If sound distorts from an output destination device at maximum output level, you can use this unit's analog output level function, which lowers the output level, to stop distortion.

1. Select the **A. Out Att.** item on the **MENU** screen to open the **A. Out Att.** screen. (see “Menu operation procedures” on page 18)



2. Set the analog output level.
Options: **OFF** (default), **-1dB** to **-18dB** (in 1dB intervals)
3. Confirm the setting and return to the **MENU** screen.

NOTE

- This adjusts the output level from the **ANALOG OUT (UNBALANCED) L/R**, **ANALOG OUT (BALANCED) L/R** and **PHONES** jacks. They cannot be set independently.
- The analog output level of the input signal from the **AUX IN** jack cannot be adjusted.

Serial mode setting (when sold-separately Ethernet card installed)

This unit can be set to allow control by serial communication using either **RS-232C** or any **Ethernet** card (sold separately).

1. Select the **Serial Mode** item on the **MENU** screen to open the **Serial Mode** screen. (see “Menu operation procedures” on page 18)

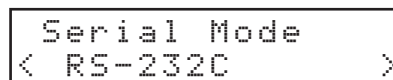

2. Set the serial mode.
Options: **RS-232C** (default), **Ethernet**
3. Confirm the setting and return to the **MENU** screen.

NOTE

- If an **Ethernet** card (sold separately) has not been installed in the unit, **Ethernet** cannot be selected.
- The serial mode setting is retained even when the unit is turned off.

Using the RS-232C connector

Serial control through the **CONTROL I/O RS-232C** connector (9-pin D-sub RS-232C standard) can be used to operate this unit from a computer or other external device.

Setting the transmission speed (baud rate)

1. Select the **Baud Rate** item on the **MENU** screen to open the **Baud Rate** screen. (see “Menu operation procedures” on page 18)

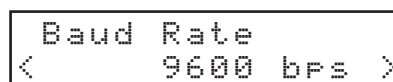

2. Set the transmission speed (baud rate).
Options: **4800 bps**, **9600 bps** (default), **19200 bps**, **38400 bps**, **57600 bps**
3. Confirm the setting and return to the **MENU** screen.

NOTE

You download the **RS-232C** command protocol for this unit from the **TEAC Global Site** (<http://teac-global.com/>).

Using the AUX IN jack

The **AUX IN** jack can be used for playback from portable audio players and other devices.

1. Connect the **AUX IN** jack to a portable audio player or other device.
2. Select **AUX** as the current source. (see “Selecting the playback source.” on page 22)
3. Press the play button on the connected device to start playback.

Checking the firmware version

You can check the version of the system firmware used by this unit.

1. Select the **Information** item on the **MENU** screen to open a screen where you can check the firmware version. (see “Menu operation procedures” on page 18)

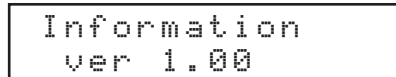

```
Information
ver 1.00
```

The firmware version confirmation screen shows information about the system firmware version.

2. Press the main unit **MULTI JOG** dial or remote control **ENTER** button to confirm the content and return to the **MENU** screen.

Restoring factory default settings

You can restore the various settings stored in the backup memory of the unit to their factory default values.

Use the following menu procedures to do so.

1. Select the **Factory Preset** item on the **MENU** screen. (see “Menu operation procedures” on page 18)
2. Press the main unit **MULTI JOG** dial or remote control **ENTER** button.
A confirmation message will appear.

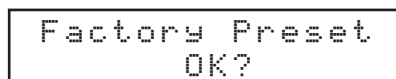

```
Factory Preset
OK?
```

NOTE

To cancel, press the main unit **BACK [PAIRING]** button or remote control **^** button.

3. Press the main unit **MULTI JOG** dial or remote control **ENTER** button to reset the unit to its factory settings.
After it completes, the **MENU** screen will reopen.

9 – Troubleshooting

If you are having trouble with the operation of this unit, please try the following before seeking repair. If these measures do not solve the problem, please contact the store where you bought the unit or TASCAM customer support service.

The unit will not turn on.

- Confirm that the power plug and other connectors are inserted completely.

Media are not recognized.

- Confirm that the SD card or USB flash drive is inserted securely.
- Stop playback or recording once.

The unit does not function.

- Confirm that the lock function is not on.

Remote control (RC-CD400) does not work.

- Is the remote control reception setting set to Lock?

Playback is not possible.

- If you are trying to play a WAV file, confirm that it uses a sampling frequency (44.1/48 kHz) and a bit depth (16-bit) that are supported by this unit.
If you are trying to play an MP3 file, confirm that it uses a sampling frequency (44.1/48 kHz) and a bit rate (32–320 kbps or VBR) that are supported by this unit.

CD cannot be played.

- If you are trying to play a data CD that contains MP3 files, confirm that their bit rates are supported by this unit.
- Confirm that the disc is not scratched or dirty.

All the tracks on an SD card or USB flash drive cannot be played back.

- Confirm that it is not in folder playback mode.

No sound is output.

- Check connections with the monitoring system again. Check the volume of the amplifier as well.

There is noise.

- Confirm that the connection cables do not have contact issues.

The remote control (RC-CD400) does not function.

- Confirm that a battery is installed and has not died.

Nothing appears on the display or it is dim.

- Confirm that the display brightness setting is not set to dim. (see “Adjusting the display brightness” on page 20)

Sound breaks up or is noisy.

- Are there any wireless LAN devices, other Bluetooth devices, microwave ovens or similar equipment nearby?
Keep such devices as far away as possible during use.
- Try reducing the distance between this unit and the other Bluetooth device. Try changing the positions of this unit and the other Bluetooth device.
- The operation of apps other than for music playback on the smartphone could cause the sound to break up. In this case, stop operation of apps other than the one used for music playback.

Cannot connect or communication is interrupted.

- Confirm that the other Bluetooth device power is on and that its Bluetooth function is on.
- Confirm that the other Bluetooth device is not too far away. Are there walls or other obstacles, for example, between this unit and the other Bluetooth device?
The body of this unit itself could interrupt transmission if the other Bluetooth device is behind it.
Try changing the positions of this unit and the other Bluetooth device.
- Try turning this unit's power off and on again.
- Remove the CD-400U pairing record from the other Bluetooth device, and try pairing the unit with that Bluetooth device again.

Cannot pair with another device.

- Confirm that the other Bluetooth device supports A2DP and AVRCP.
- Confirm that the other Bluetooth device is in a state that allows transmission. For details, check the operation manual of that Bluetooth device.
- Turn the power off for both this unit and the other Bluetooth device once, turn them both on again and try pairing them.
- Turn off Bluetooth devices other than the one that you are trying to pair with.
- Remove the CD-400U pairing record from the other Bluetooth device, and try pairing the unit with that Bluetooth device again.

Cannot receive radio or reception is poor.

- Select a broadcast station.
- If reception is poor, try repositioning the antenna.
- If a TV is near the unit, turn the TV off.
- Reception conditions are poor in reinforced concrete buildings, basements and similar locations. Place this unit and its antenna near a window facing outside the building, for example.

Stereo FM broadcasts become mono.

- Confirm that the FM mode is not set to mono reception.

Ratings

Supported media

CD, CD-R* (only CD-DA format), CD-RW (12cm, ISO 9660 LEVEL 1/2/JOLIET) (multi-session and CD text not supported)
SD cards* (512 MB – 2 GB)
SDHC cards* (4 GB – 32 GB)
USB flash drives* (512 MB – 64 GB)

* Media must be formatted FAT16/32.

Playback file formats

CD-DA: 44.1kHz, 16-bit stereo
WAV*: 44.1/48kHz, 16-bit
(LPCM SD card/USB flash drive)
MP3*: 44.1/48kHz, 32–320kbps, VBR
(MPEG1/2 Audio Layer-3, data CD/SD card/USB flash drive)
AAC*: 44.1/48kHz, 8–320kbps, VBR
(MPEG4 AAC-LC (Audio stream), DRM not supported, SD card/USB flash drive)
WMA*: 44.1/48kHz, 32–320kbps, VBR (WMA ver.9 standard, DRM not supported, data CD/SD card/USB flash drive)

* *File/folder specifications are as follows.

Maximum file size: 2 GB
Maximum number of files: 300 (including folders)
Maximum number of files in a single folder: 100
Maximum number of folders: 50

Number of channels

2 channels (stereo)
1 channel (mono)

Dubbing file formats

MP3: 44.1kHz, 96/128/192/320kbps
(96/128kbps with tuner)

Inputs and outputs

Analog audio input and output ratings

AUX IN jack (front panel)

Connector: 3.5mm stereo mini jack
Nominal input level: –20 dBV (0.1 Vrms)
Maximum input level: –4 dBV (0.63 Vrms)
Input impedance: 10 k Ω or higher

Analog output (balanced) jacks

Connectors: XLR-3-32 (1: GND, 2: HOT, 3: COLD)
Rated output level
+4 dBu (1.23 Vrms, when analog output level setting OFF)
Maximum output level (switchable):
+20 dBu (7.75 Vrms, when analog output level setting OFF)
Output impedance: 100 Ω

Analog output (unbalanced) jacks

Connectors: RCA pin jacks
Rated output level
–10 dBV (0.316 Vrms, when analog output level setting OFF)
Maximum output level (switchable):
+6 dBV (2.0 Vrms, when analog output level setting OFF)
Output impedance: 200 Ω

TUNER OUTPUTS (UNBALANCED) jacks

Connectors: RCA pin jacks
Rated output level: –10 dBV (0.316 Vrms)
Maximum output level: +6 dBV (2.0 Vrms)
Output impedance: 200 Ω

Phones jack

Connector: 6.3mm (1/4") standard stereo jack
Maximum output: 20 mW + 20 mW or higher (THD+N 0.1% or less, into 32 Ω load)

Control input/output

RS-232C connector

9-pin D-sub (female, inch-standard)

Audio performance

Frequency response

20 Hz – 20 kHz: ± 1.0 dB (when 44.1/48kHz sampling frequency, CD/SD/USB playback, JEITA)

Distortion

0.005% or less (when CD/SD/USB playback, JEITA)

S/N ratio

95 dB or higher (when CD/SD/USB playback, JEITA)

Dynamic range

90 dB or higher (when CD/SD/USB playback, JEITA)

Channel separation

90 dB or higher (when CD/SD/USB playback, JEITA)

10 – Specifications

Bluetooth

Bluetooth version: 4.2

Output class: 2 (about 10m* unobstructed transmission distance)

Supported profiles: A2DP, AVRCP 1.0

Supported A2DP codecs: SBC, AAC, aptX

Supported A2DP content protection: SCMS-T

* The transmission distance is only an estimate and might vary depending on the surrounding environment and radio wave conditions.

Tuner

Frequency range

US model

FM: 87.5 MHz to 108.0 MHz

AM: 520 kHz to 1,720 kHz

Other models

FM: 87.5 MHz to 108.0 MHz

AM: 522 kHz to 1,629 kHz

Antenna connectors

FM: F-type (female)

AM: 2-pin push terminal

Other

Power

AC100-240V, 50/60 Hz

Power consumption

10W

Dimensions

482.6 × 45 × 300.5 mm (W x H x D)

Weight

3.3 kg

Operating temperature range

5°C – 35°C

Permitted installation tilt

30° or less

Dimensional drawings

イラスト待ち

- Illustrations in this manual might differ in part from the actual product.
- Specifications and external appearance might be changed without notification to improve the product.

WARRANTY

< In the United States >

This warranty gives you specific legal rights and you may also have other rights which vary from state to state. This warranty is only valid within the country the unit was originally purchased.

WHAT IS AND IS NOT COVERED

Except as specified below, this warranty covers all defects in materials and workmanship in this product. The following are not covered by the warranty:

1. **Damage to or deterioration of the external cabinet.**
2. **Damages resulting from accident, misuse, abuse or neglect.**
3. **Damage resulting from failure to perform basic daily maintenance and/or calibration or otherwise resulting from failure to follow instructions contained in your owner's manual.**
4. **Damage occurring during shipment of the product. (Claims must be presented to the carrier)**
5. **Damage resulting from repair or attempted repair by anyone other than TEAC or an authorized TASCAM service station.**
6. **Damage resulting from causes other than product defects, including lack of technical skill, competence, or experience of the user.**
7. **Damage to any unit which has been altered or on which the serial number has been defaced, modified or is missing.**

WHO IS COVERED UNDER THE WARRANTY

This warranty may be enforced only by the original purchaser. This warranty is not valid if the product was purchased through an unauthorized dealer.

LENGTH OF WARRANTY

All parts except heads and disk drives are warranted for one (1) year from the date of original purchase. Heads and disk drives are warranted to ninety (90) days from date of original purchase. Labor is warranted for ninety (90) days from date of original purchase.

WHAT WE WILL PAY FOR

We will pay all labor and material expenses for items covered by the warranty. Payment of shipping charges is discussed in the next section of this warranty.

HOW YOU CAN GET WARRANTY SERVICE

Your unit must be serviced by an authorized TASCAM service station in the United States. (This warranty is not enforceable outside the U.S.) If you are unable to locate an authorized TASCAM service station in your area, please contact us. We either will refer you to an authorized service station or instruct you to return the unit to the factory. Whenever warranty service is required, you must present a copy of the original dated sales receipt from an Authorized TASCAM Dealer. You must pay any shipping charges if it is necessary to ship the product to service. However, if the necessary repairs are covered by the warranty, we will pay return surface shipping charges to any destination within the United States.

LIMITATION OF IMPLIED WARRANTIES

Any implied warranties, INCLUDING WARRANTIES OF MERCHANTABILITY AND FITNESS FOR A PARTICULAR PURPOSE, are limited in duration to the length of this warranty.

EXCLUSION OF DAMAGES

TEAC's liability for any defective product is limited to repair or replacement of the product, at TEAC's option. TEAC shall not be liable for:

1. **Damages based upon inconvenience, loss of use of the product, loss of time interrupted operation or commercial loss; or**
2. **Any other damages, whether incidental, consequential or otherwise.**

Some states do not allow limitations on how long an implied warranty lasts and/or do not allow the exclusion or limitation of incidental or consequential damages, so the above limitations and exclusions may not apply to you.

To locate an Authorized Service Center in Your Area

CALL 1-800-447-8322

< Europe >

This product is subject to the legal warranty regulations of the country of purchase. In case of a defect or a problem, please contact the dealer where you bought the product.

Ce produit est sujet aux réglementations concernant la garantie légale dans le pays d'achat. En cas de défaut ou de problème, veuillez contacter le revendeur chez qui vous avez acheté le produit.

Dieses Gerät unterliegt den gesetzlichen Gewährleistungsbestimmungen des Landes, in dem es erworben wurde. Bitte wenden Sie sich im Gewährleistungsfall an den Händler, bei dem sie das Gerät erworben haben.

Questo apparecchio è conforme alle norme sulla garanzia vigenti nel rispettivo Paese in cui esso è stato acquistato. Si prega di rivolgersi al proprio commerciante, presso il quale è stato acquistato l'apparecchio, nel caso in cui si voglia richiedere una prestazione in garanzia.

Las condiciones de garantía de este aparato están sujetas a las disposiciones legales sobre garantía del país en el que ha sido adquirido. En caso de garantía, debe dirigirse al establecimiento donde adquirió el aparato.

< In other countries/areas >

This warranty gives you specific legal rights, and you may also have other rights that vary by country, state or province.

If you have a warranty claim or request, please contact the dealer where you bought the product.

该保证书赋予了顾客特定的合法权利，并且因国家、州或省等地域的不同，顾客可能拥有其他权利。如需申请或要求保修，请与购买本产品的销售店进行联系。

If you require repair services for your **TASCAM** equipment, please contact the dealer where the product was purchased from or the **TASCAM** Distributor in your country. A list of **TASCAM** Distributors can be found on our website at: <http://teac-global.com/>

TASCAM

TEAC CORPORATION

Phone: +81-42-356-9143
1-47 Ochiai, Tama-shi, Tokyo 206-8530 Japan

<https://tascam.jp/jp/>

TEAC AMERICA, INC.

Phone: +1-323-726-0303
1834 Gage Road, Montebello, California 90640 USA

<http://tascam.com/>

TEAC UK Ltd.

Phone: +44-8451-302511
2 Huxley Road, Surrey Research Park, Guildford, GU2 7RE, United Kingdom

<http://tascam.eu/>

TEAC EUROPE GmbH

Phone: +49-611-71580
Bahnstrasse 12, 65205 Wiesbaden-Erbenheim, Germany

<http://tascam.eu/>

TEAC SALES & TRADING(SHENZHEN) CO., LTD

Phone: +86-755-88311561~2
Room 817, Block A, Hailrun Complex, 6021 Shennan Blvd., Futian District, Shenzhen 518040, China

<http://tascam.cn/>

1117.MA-2482A

Printed in China

WARRANTY

Model/Modèle/Modell
Modello/Modelo/型号

CD-400U

Owner's name/Nom du possesseur/Name des Eigentümers
Nome del proprietario/Nombre del propietario/顾客姓名

Serial No./No de Série/Seriennummer
Numero di serie/Número de serie/序列号

Address/Adresse/Adresse
Indirizzo/Dirección/顾客地址

Date of purchase/Date de l'achat/Datum des Kaufs
Data dell'acquisto/Fecha de compra/购买日期

Dealer's name/Nom du détaillant/Name des Händlers
Nome del commerciante/Nombre del establecimiento/销售店名

TASCAM
<http://teac-global.com/>

Dealer's address/Adresse du détaillant/Adresse des Händlers
Indirizzo del commerciante/Dirección del establecimiento/销售店地址