

Tenda

Install Guide

You can get the User Guide online at www.tenda.cn for featured settings of the device.

Package Contents

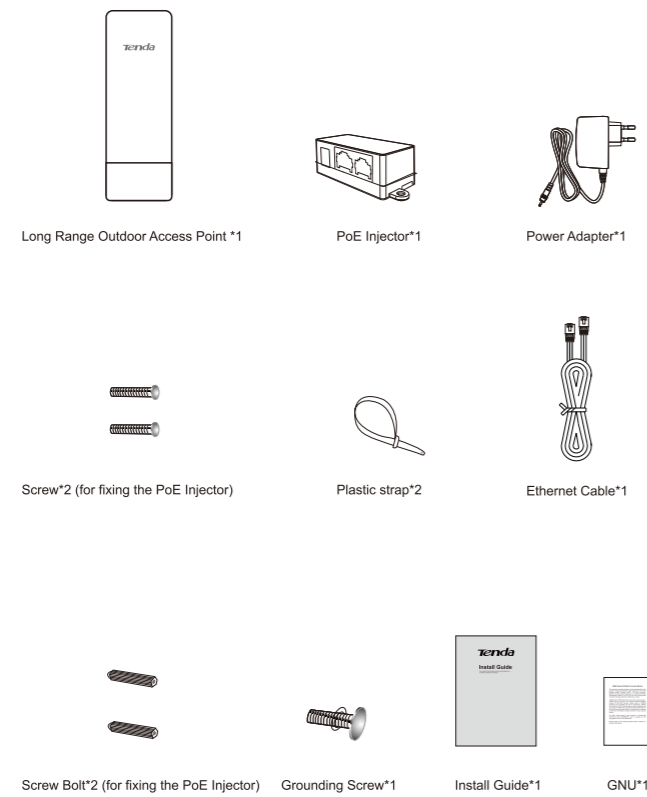

1 Get to Know Your Device

► Front View

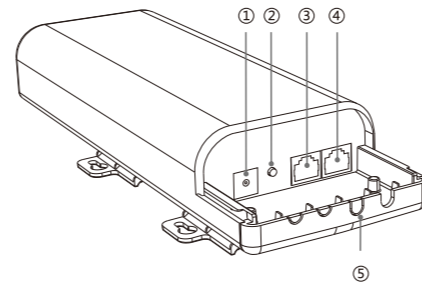

Item	Port / Button	Description
①	GND	With the included grounding screw, attach a copper wire here to provide proper surge and lightning protection for your device.
②	RST	Pressing and holding the reset button for over 7 seconds restores this device to factory defaults.
③	LAN	A 100Mbps LAN port for connecting the Ethernet device such as a switch, a computer, etc.
④	PoE LAN/WAN	This port provides power over an Ethernet connection via the PoE injector. And it works interchangeably as a WAN port in Router mode and a LAN port in other modes.
⑤	/	Cable access hole cut-outs

► Rear View

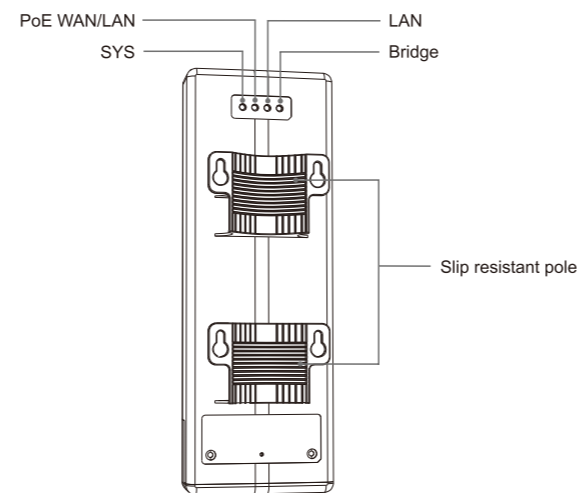

LED	Status	Description
SYS	Off	Malfunction occurs or the device is not powered on.
	Blinking	The device is working properly.
PoE WAN/LAN	Off	There is no device linked to this port.
	Solid	There is a device linked to this port but no data transmission.
	Blinking	Data transmission is occurring on this port.
LAN	Off	There is no device linked to this port.
	Solid	There is a device linked to this port but no data transmission.
	Blinking	Data transmission is occurring on this port.
Bridge	Off	* Working in AP or Router mode * Failed to connect to remote AP
	Solid	Bridged to the remote AP successfully

2 Hardware Install

Step 1: Mount the AP

Set up the AP in an outdoor location, usually on the roof, and thread plastic wraps through grooves underneath the brackets. Then attach the device firmly to a solid pole.

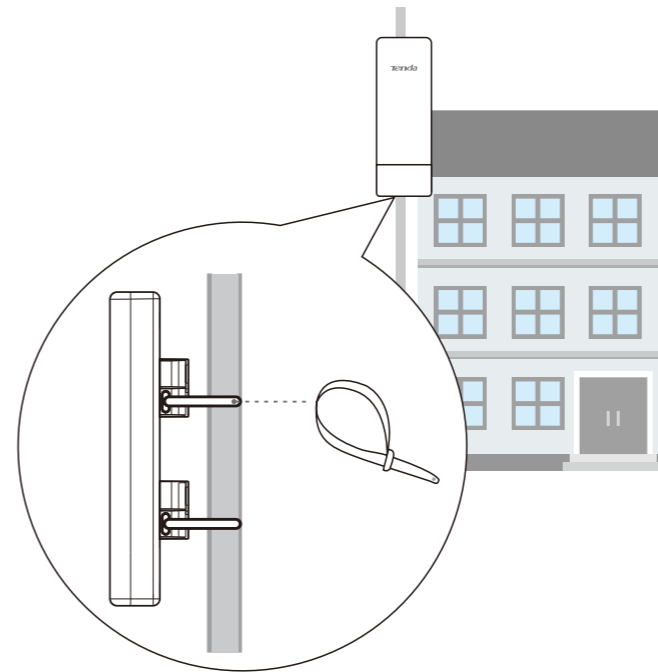

Step 2: Connect the AP

- Slide the bottom cover of the AP down to expose the ports.
- Connect the **PoE LAN/WAN** port of your AP to the **PoE** port of the injector with an Ethernet cable.
- Connect your computer to the **LAN** port of the injector with another Ethernet cable.
- Gently replace the cover by sliding it up until it clicks into place.
- Power on the AP by plugging the included power adapter into the **DC** jack on the injector, and the other end into a standard power outlet.

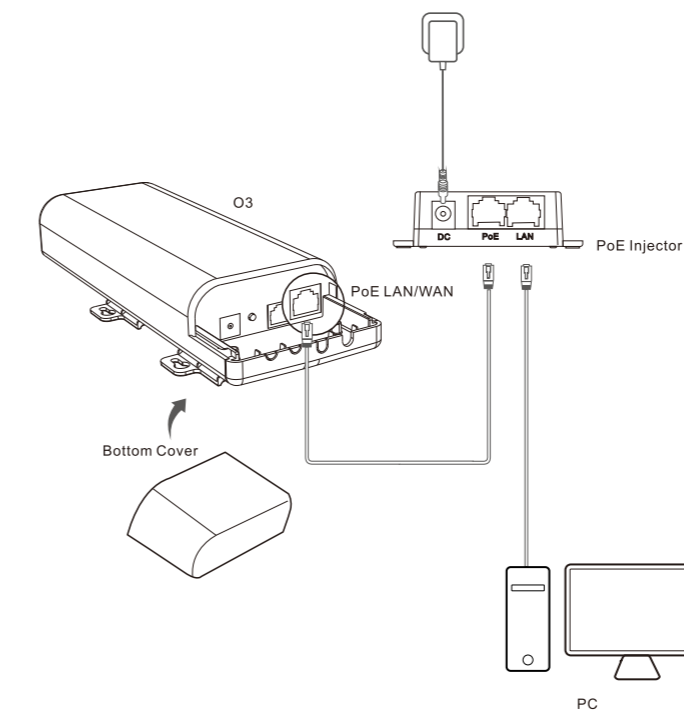

3 Configure PC

* Take Windows 7 as an example

Step 1: Click the icon on the bottom right corner of your desktop.

Step 2: Click **Open Network and Sharing Center**.

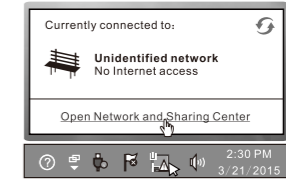

Tips

If you cannot find the icon on the bottom right corner of your desktop, follow steps below: Click **Start > Control Panel > Network and Internet > Network and Sharing Center**.

Step 3: Click **Local Area Connection > Properties**.

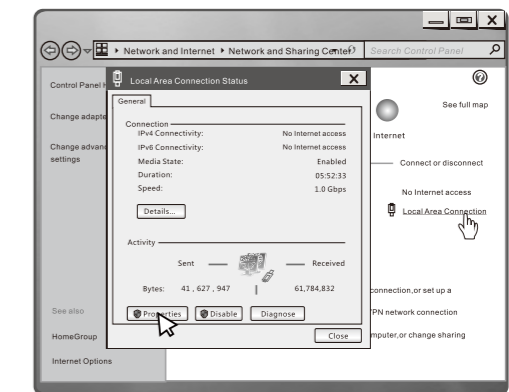

Step 4: Find and double click **Internet Protocol Version 4(TCP/IPv4)**.

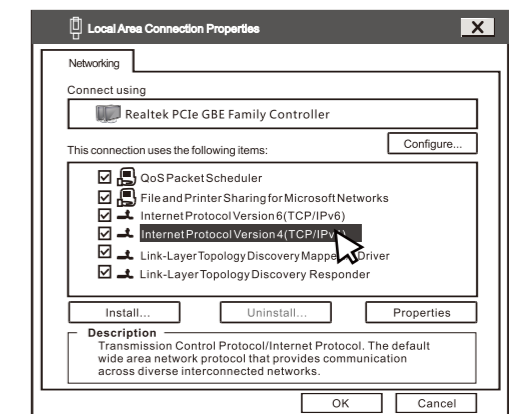

Step 5: Select **Use the following IP address**, type in the IP address: **192.168.2.x** (2~253), Subnet mask: **255.255.255.0** and click **OK**.

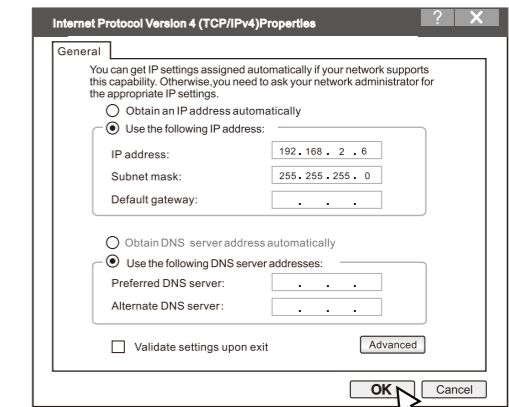

Step 6: Click **OK** on the **Local Area Connection Properties** window (see Step 4 for the screenshot).

4 Configure the AP

Step 1: Input 192.168.2.1 in a web browser's address bar, and then press **Enter** or **Return** on your keyboard.

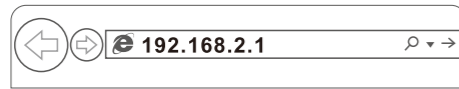

Step 2: Enter the default username and password (**admin** for both defaults) and click

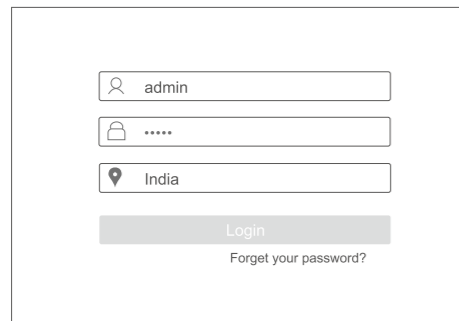

Step 3: Please select the proper operating mode and follow instructions on the web UI to apply your settings.

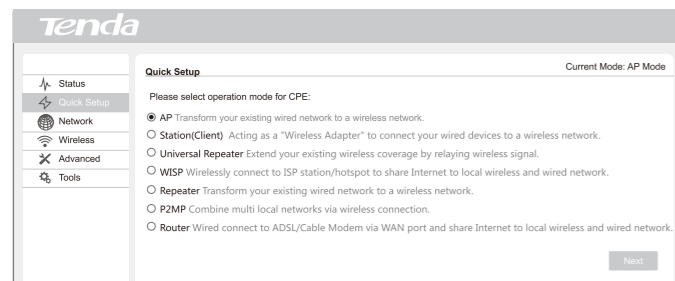

Here we will mainly introduce 2 application scenarios to you.

► AP Mode + Station Mode

For long-distance data transmission and IP camera (CCTV) surveillance, one works in AP mode and the other works in Station mode to build stable wireless connection. Please follow the steps as shown below.

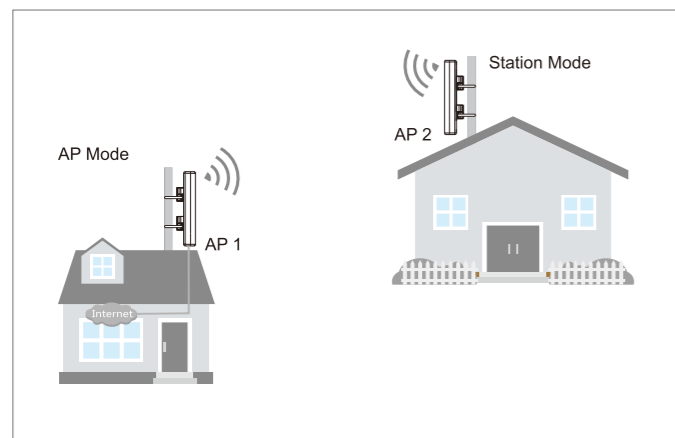

1.Set AP1 in AP mode.

1 Select AP mode

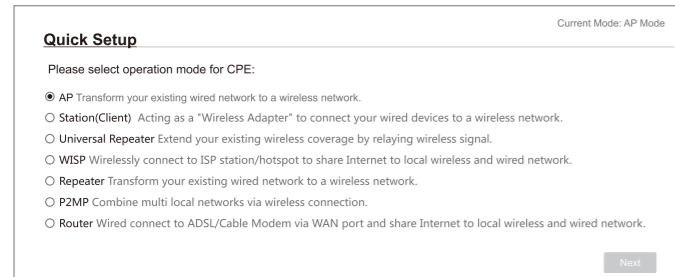

2 Customize your SSID (WiFi name)
Set security settings (Recommended: WPA2-PSK, AES)

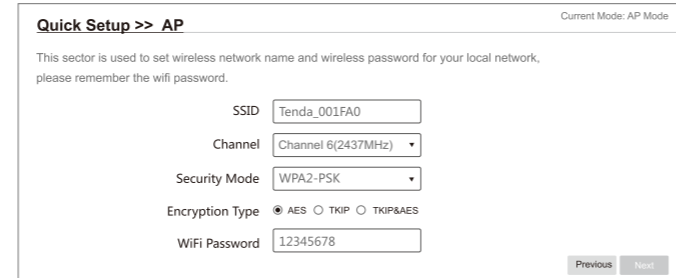

Then click **Save** on the appearing page to apply your settings. Wait until the device restarts automatically.

2.Set AP2 in Station mode.

1 Select Station mode

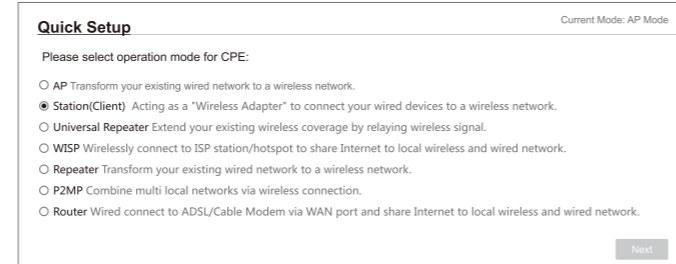

2 Select the remote SSID (WiFi name) you wish to bridge from the list

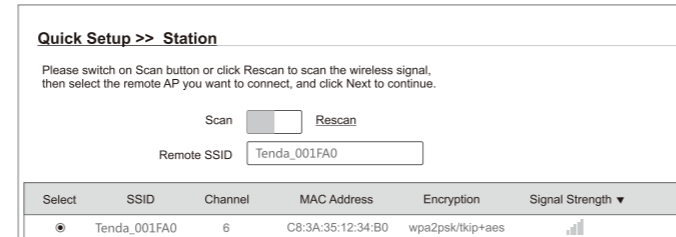

3 Enter the key (WiFi password) of the remote SSID if needed

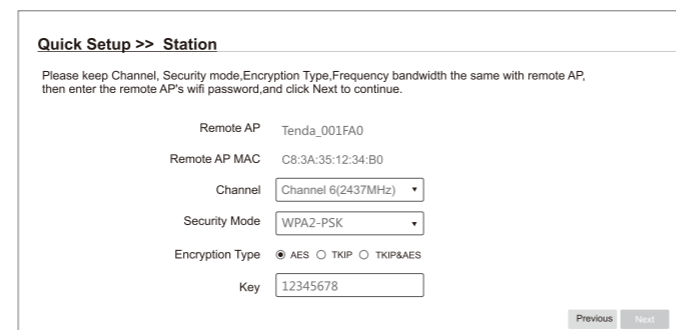

4 If the remote AP's IP address is 192.168.2.1, this AP's IP address should be 192.168.2.x (2~254).

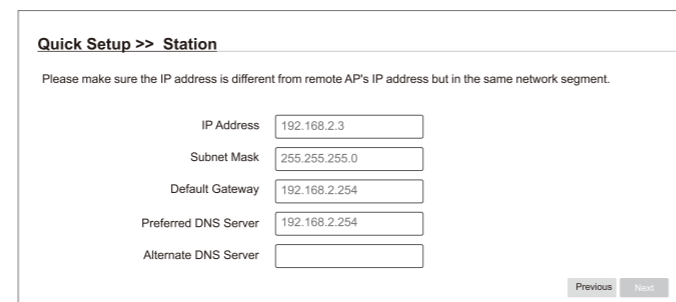

Then click **Save** on the appearing page to apply your settings. Wait until the device restarts automatically. When the **Bridge LED** stays solid, it has been bridged successfully!

► WISP Mode

In this mode, the device connects to ISP hotspot wirelessly to share Internet with local wireless and wired devices.



1 Select WISP mode

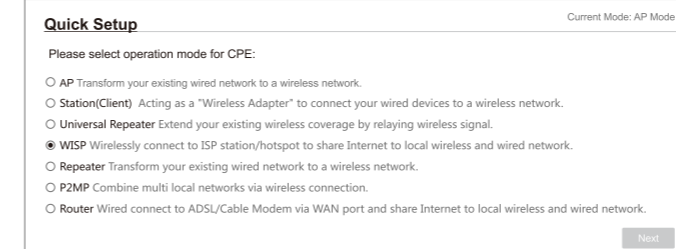

2 Select the SSID (WiFi name) of ISP hotspot

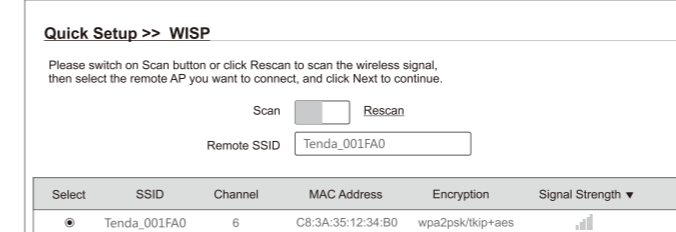

3 Enter the key (WiFi password) of the ISP hotspot if needed

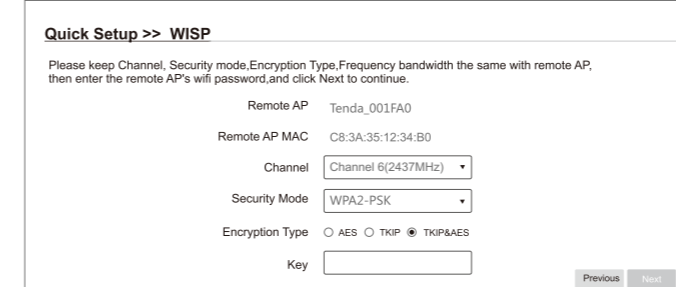

4 Select the WAN connection type and set corresponding parameters if needed

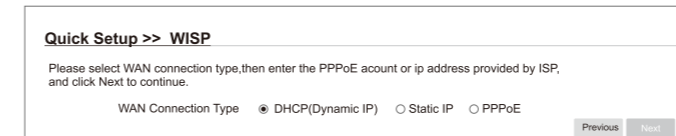

5 Customize your SSID for your local network
Set security settings for your local network(Recommended: WPA2-PSK and AES)

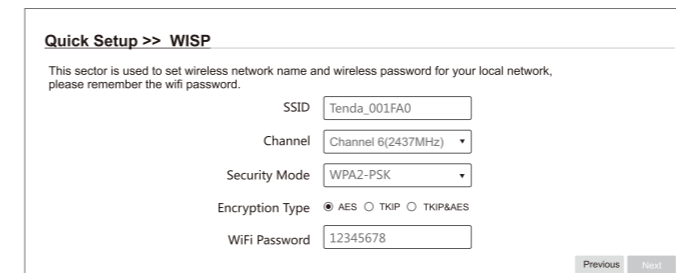

6 If the ISP hotspot's IP address is 192.168.2.x, this AP's IP can be 192.168.5.x.

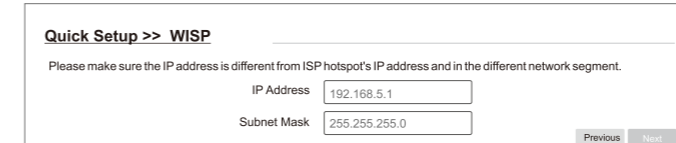

Then click **Save** on the appearing page to apply your settings. Wait until the device restarts automatically. When the **Bridge LED** stays solid, it has been bridged successfully!

Step 4: After finishing settings mentioned above, set your PC to **Obtain an IP address automatically** for Internet access.

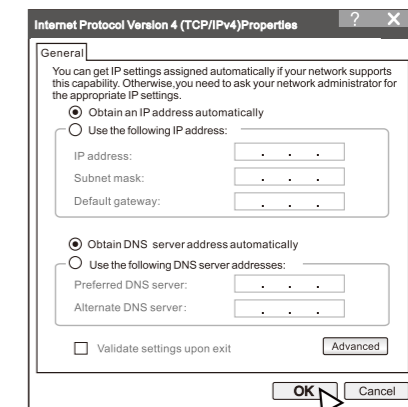

FAQs

Q1:How do I restore my AP to its factory default settings?

Method 1: Via the **RST** button
With the AP powered on, slide the bottom cover of the AP down to expose the **RST** button, press and hold it for over 7 seconds to restore the AP to its factory defaults. Note that once your AP is reset, all your current settings will be lost and you need to reconfigure your AP.

Method 2: Via the Web UI
Log in to this device's web UI, click **Tools > Maintenance**, locate the **Reset to Factory Settings** section and click **Reset**.

Q2: I enter the device's LAN IP address in the web browser but cannot access this device's web UI. What should I do?

- 1 Verify that the IP address of computer should be a different one but on the same network segment as the LAN IP address of this device. The default LAN IP address of AP is 192.168.2.1 and you need to set your PC to a static IP address within the following range: 192.168.2.X (2-253);
- 2 Clear the browser cookies or try another web browser;
- 3 If you are still unable to login, please restore the device to factory default settings and follow this Install Guide to configure your settings again.

Safety & Emission Statement



CE Mark Warning

This is a Class B product. In a domestic environment, this product may cause radio interference, in which case the user may be required to take adequate measures. This device complies with EU 1999/5/EC.

NOTE: (1) The manufacturer is not responsible for any radio or TV interference caused by unauthorized modifications to this equipment. (2) To avoid unnecessary radiation interference, it is recommended to use a shielded RJ45 cable.



FCC Statement

This device complies with Part 15 of the FCC Rules. Operation is subject to the following two conditions: (1) This device may not cause harmful interference, and (2) this device must accept any interference received, including interference that may cause undesired operation.

This equipment has been tested and found to comply with the limits for a Class B digital device, pursuant to Part 15 of the FCC Rules. These limits are designed to provide reasonable protection against harmful interference in a residential installation. This equipment generates, uses and can radiate radio frequency energy and, if not installed and used in accordance with the instructions, may cause harmful interference to radio communications. However, there is no guarantee that interference will not occur in a particular installation. If this equipment does cause harmful interference to radio or television reception, which can be determined by turning the equipment off and on, the user is encouraged to try to correct the interference by one of the following measures:

- Reorient or relocate the receiving antenna.
- Increase the separation between the equipment and receiver.
- Connect the equipment into an outlet on a circuit different from that to which the receiver is connected.
- Consult the dealer or an experienced radio/TV technician for help.

FCC Caution: Any changes or modifications not expressly approved by the party responsible for compliance could void the user's authority to operate this equipment.

This transmitter must not be co-located or operating in conjunction with any other antenna or transmitter. The manufacturer is not responsible for any radio or TV interference caused by unauthorized modifications to this equipment.

Radiation Exposure Statement

This equipment complies with FCC radiation exposure limits set forth for an uncontrolled environment. This equipment should be installed and operated with minimum distance 20cm between the radiator & your body.

NOTE: (1) The manufacturer is not responsible for any radio or TV interference caused by unauthorized modifications to this equipment. (2) To avoid unnecessary radiation interference, it is recommended to use a shielded RJ45 cable.

Shenzhen Tenda Technology Co., Ltd.
6-B Floor, Tower E3, No.1001, Zhongshanyuan Road,
Nanshan District, Shenzhen, China. 518052
Website: http://www.tenda.com
E-mail: support@tenda.com.cn
YouTube: Tendasz1999
Skype: tendasz
Phone: Global hotline: (86 755)27657180

© 2015 Shenzhen Tenda Technology Co., Ltd. All rights reserved.
Tenda is a registered trademark legally held by Shenzhen Tenda Technology Co., Ltd.
Other brand and product names mentioned herein are trademarks or registered trademarks of their respective holders. Specifications are subject to change without notice.