



S4.16

UHF
WIRELESS
SYSTEM

CONTENTS

1. Introduction and Safety
2. Trantec S4.16 System Overview
3. Receiver Layout and Operation
4. Handheld Layout and Operation
5. Beltpack Layout and Operation
7. General Set-up, Operating Hints and Fault Finding
10. Technical Specifications
12. Warranty Terms

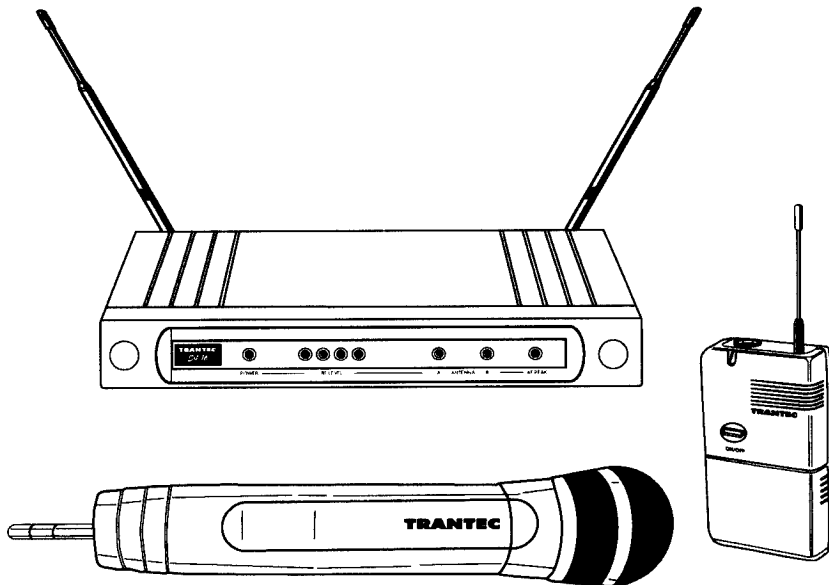

INTRODUCTION

The Trantec S4.16 Series represents Trantec's commitment to providing high-quality, affordable Wireless Audio Links using our considerable design expertise gained over many years as a leading edge manufacturer.

We would like to thank you for purchasing this product and would like you to spend a short time reading this *Operations Manual* so as to familiarise yourself with the features of the Trantec S4.16 series.

SAFETY

Our aim is to supply you with a product that provides you with countless hours of trouble free use.

In order to achieve these goals, we recommend the following:-

Keep the system away from direct sources of heat e.g. Central heating radiators, heaters and direct sunlight.

Should the Transmitters not be used for extended periods of time we recommend that the batteries are removed to avoid any potential leakage.

Keep the system clean by using a slightly damp cloth. Never use household cleaning agents or solvents.

Avoid using or storing the system in damp conditions.

Always use the AC power adaptor supplied with the Receiver and *never* remove the external covers of the equipment, so as to expose the electronics.

License requirement

The term "IC:" before the radio certification number only signifies that Industry Canada Technical specifications were met. Operation is subject to the following two conditions;

- (1) This device may not cause harmful interference, and (2) this device must accept any interference received, including interference that may cause undesired operation.

IMPORTANT NOTE : To comply with the FCC RF exposure compliance requirements, no charge to the antenna or the device is permitted. Any change to the antenna or the device could result in the device exceeding the RF exposure requirements and void user's authority to operate the device.

Le présent appareil est conforme aux CNR d'Industrie Canada applicables aux appareils radio exempts de licence. L'exploitation est autorisée aux deux conditions suivantes :

- (1) l'appareil ne doit pas produire de brouillage, et*
- (2) l'utilisateur de l'appareil doit accepter tout brouillage*

radio électrique subi, même si le brouillage est susceptible d'en

compromettre le fonctionnement

S4.16 SYSTEM OVERVIEW

The Trantec S4.16 is a high-quality UHF Wireless Microphone System.
The S4.16 has many features including:-

- >> 16 User Selectable Channels.
- >> Diversity Receiver Operation - to minimise drop-outs.
- >> User Adjustable Audio Output Level - adjustable on both Jack and XLR outputs.
- >> User Adjustable RSSI/Squelch - enables the user to minimise external interference.
- >> Rear Mount Detachable Antennas.
- >> Includes 4 Licence Free Channels.
- >> 19" Rack Mount plate available.

THE S4.16 COMPRISES 2 BASIC DIFFERENT VARIATIONS:-

The Handheld System and the Beltpack Presenters/Instrument System.

The Handheld System comprises a fully integrated Handheld Microphone incorporating a Cardioid Dynamic Capsule and is most suited to General Vocal Applications.

The Beltpack System comprises a Beltpack Transmitter which is supplied with a small Lapel style clip-on Microphone and is ideally suited for General Presentation/ Theatre applications.

In addition the Beltpack Transmitter is supplied with an Instrument Cord. This cord enables the beltpack to be used with electric instruments e.g. Guitars and other high impedance applications.

S4.16 RECEIVER LAYOUT

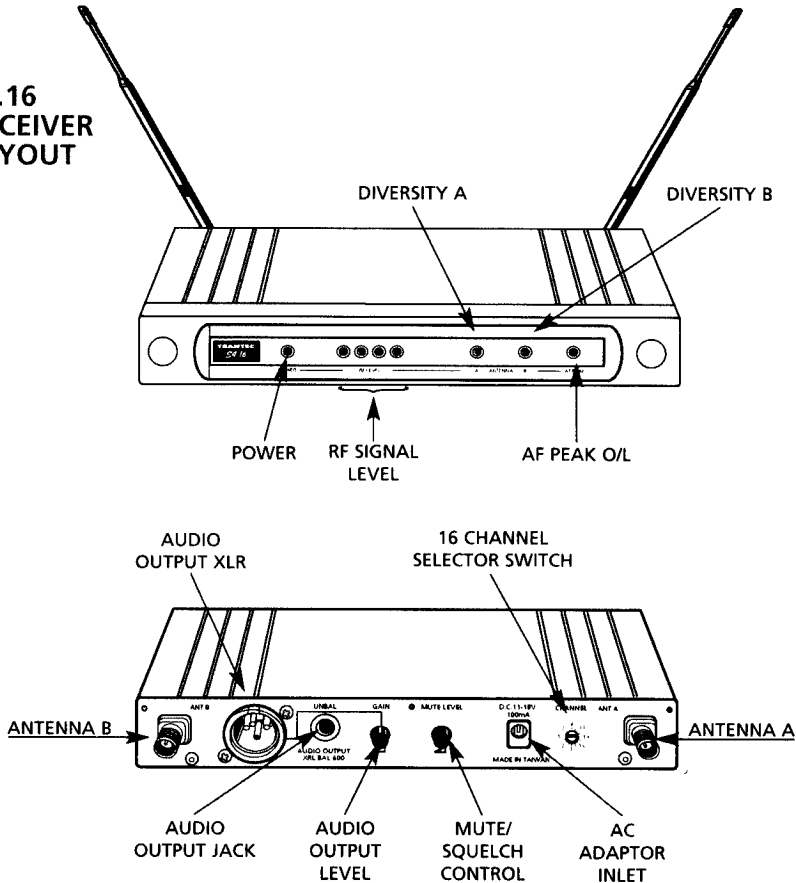

RECEIVER OPERATION

1. Connect the appropriate AC adaptor into the DC inlet as marked on the rear panel and observe the Supply indicator (green Led) lights up.
2. To provide best diversity operation, attach the antennae and angle them to form a "V" (as per illustration) ensuring they have a good line-of-sight view of the corresponding transmitter. i.e. Avoid placing large metallic objects in the transmission path.
3. Initially set the receiver AF gain control to its mid-position and connect the AF output from either the 1/4 inch Jack or XLR to your Mixing console or amplifier.
4. Select rear panel Channel Selector Switch (Small screw-driver adjust) to correspond to Transmitter setting. It is possible to select any of the 16 channels. (Factory set to position 1).

S4.16 HANDHELD LAYOUT

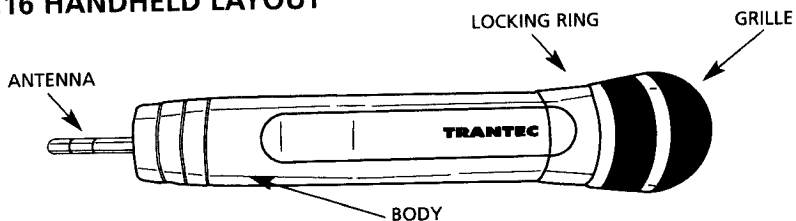

HANDHELD BATTERY INSERTION

1. Rotate the top collar locking ring in the direction indicated in the illustration and gently pull the body downwards.
2. Insert a 9V MN1604 (IEC 6 LR61) PP3 type alkaline battery, being sure to observe the correct polarity as marked.
3. Gently slide the body upwards and lock.

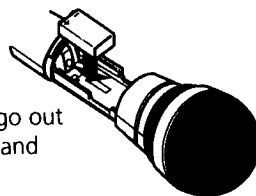
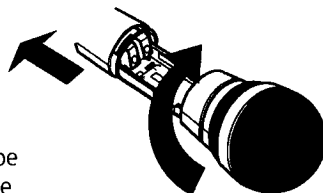

Note: Should the Red battery status Led Indicator go out during operation, this indicates a flattened battery and that it should be changed.

CHANNEL SELECTION. (Small screw-driver adjust)

With the Transmitter in the OFF position select a channel to correspond with the Receiver. It is possible to select any of the 16 channels. (Factory set to position 1).

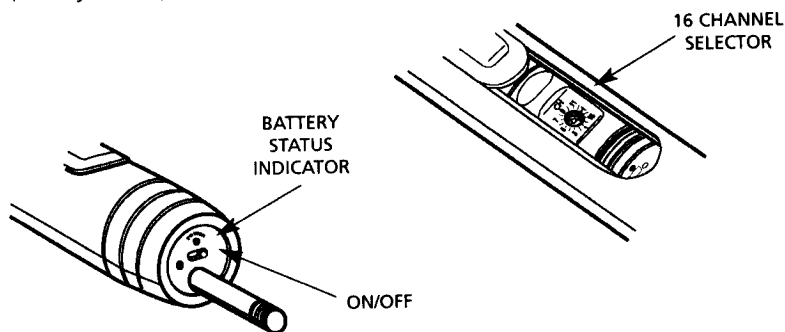

Note: If the Transmitter Active Channel has been changed whilst in the **ON** position, it must be turned **OFF** and then **ON** again to complete selection.

S4.16 BELTPACK LAYOUT

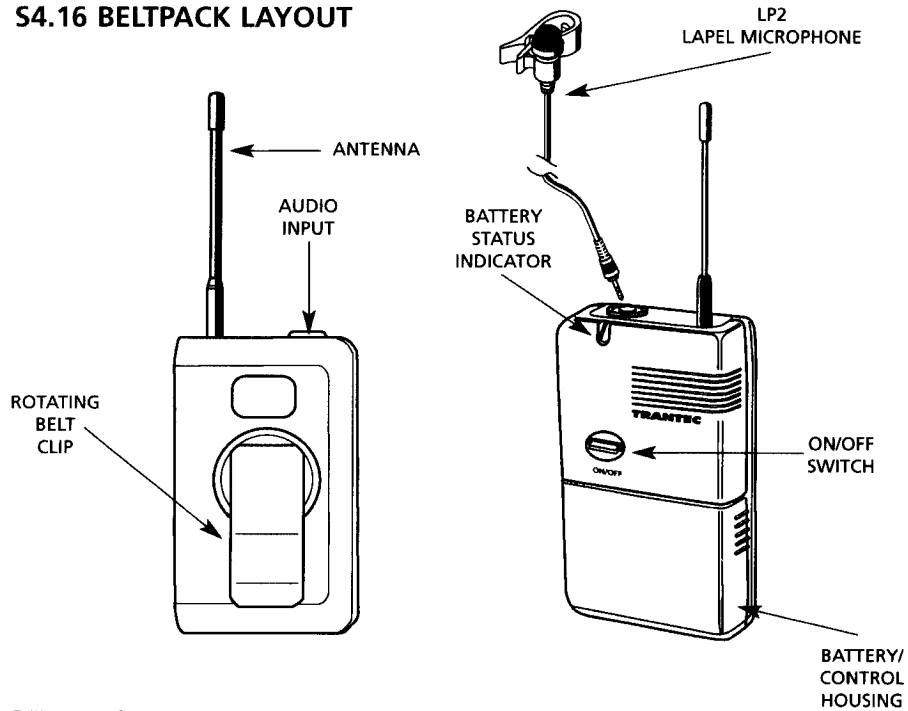

BELTPACK BATTERY INSERTION

1. Slide the battery compartment to the rear and hinge upwards to expose the battery.
2. Insert a 9V MN1604 (IEC 6 LR61) PP3 type alkaline battery, being sure to observe the correct polarity as marked.

Note: Should the Red battery status Led Indicator go out during operation, this indicates a flattened battery and that it should be changed.

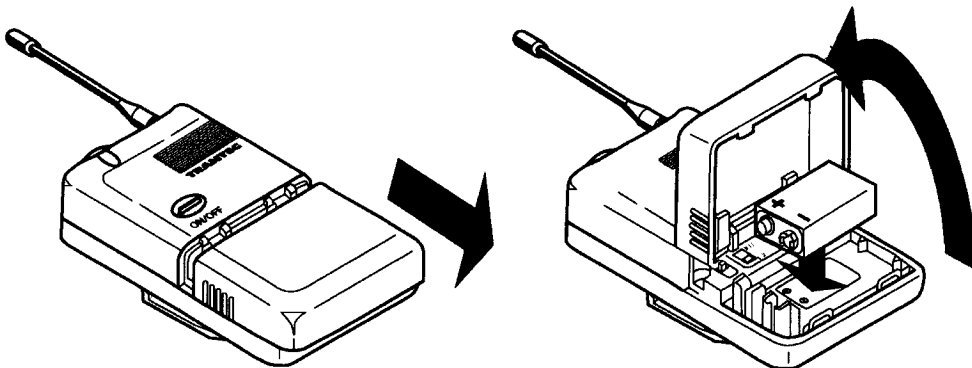

MICROPHONE CONNECTION

1. Connect small lapel-type microphone into the corresponding 3.5mm Top Panel Socket.
2. Ensure that the Battery Compartment **MIC/INST** switch is set to **Mic** position.
3. Clip the microphone to your clothing (normally Tie or Jacket Lapel). Route the mic cable so as to avoid undue strain or friction. Try and keep the mic cable away from the **ANTENNA**

The microphone supplied with the S4.16 has an Omni-directional response, which means it will pick up sounds from all directions. In view of this we recommend that the microphone is placed as close as possible to the required sound source.

INSTRUMENT CONNECTION

1. Connect the supplied Instrument cord into the corresponding 3.5mm Top Panel Socket.
2. Ensure that the battery compartment **MIC/INST** switch is set to **INST** position

BELTPACK GAIN CONTROL ADJUSTMENT. (Small screw-driver adjust)
If required adjust the Transmitter AF gain control so the signal only very occasionally allows the **Red AF O/L Peak Led** on the receiver to light.

CHANNEL SELECTION (Small screw-driver adjust)

With the Transmitter in the **OFF** position, select a channel to correspond with the Receiver. It is possible to select any of the 16 channels.
(Factory set to position 1).

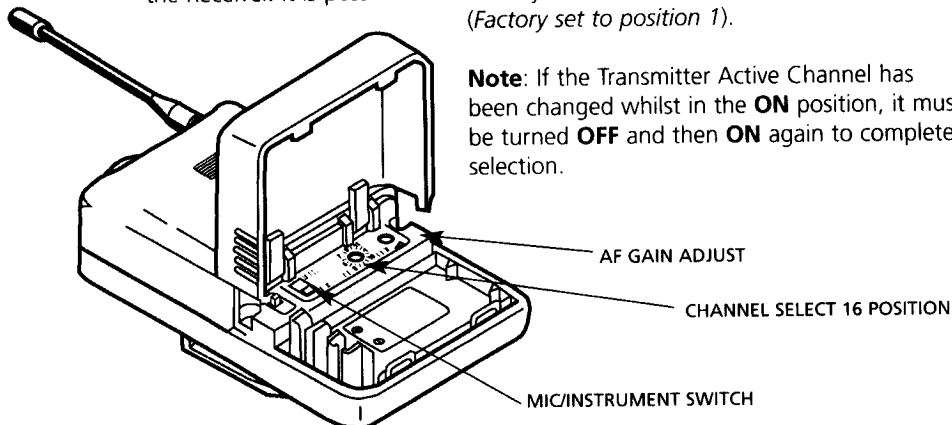

GENERAL SETUP AND OPERATING HINTS

1. DISTANCE.

To maximise operating distance (approximately 100m). We recommend you follow the guidelines below.

- a. Ensure good line of sight between Transmitter and Receiver. Do not place large obstructions between receiver and transmitters e.g. Concrete walls, large metal obstructions. In addition keep the receiver away from metallic beams and obstructions as these can adversely affect the Antenna Pick-up Pattern and induce interference.
- b. Always ensure that the Transmitter is at least 3m (10 feet) away from the Receiver.
- c. Conduct a "Walk test" which involves you moving the Transmitter in the area where transmission is required whilst noting the received RF signal strength on the receiver bargraph. Reception is best with all 4 Leds lit.
- d. Never position the Transmitter Antenna directly against the body or hand. This will reduce the operating range considerably.

2. SQUELCH/RSSI SET UP.

The S4.16 incorporates a Fixed Noise Squelch and a variable "Received Signal strength" Mute Control on the rear panel of the Receiver. This function is to reduce or eliminate the effect of interference from outside sources.

Note: Trantec cannot guarantee multi-channel compatibility with other brands/make of product.

To adjust follow these steps:

- a. Turn off the Transmitter and note if any interference is present by monitoring the Receiver RF Bargraph or Audio Output.
- b. Turn the Squelch Control clockwise until the interference disappears. In extreme cases it may not be possible to remove the unwanted interference and in this case it is recommended you try an alternative channel.

Note: the Squelch Control affects the operating range of the system and with the Squelch set to maximum, the range will be significantly reduced.

3. RECEIVER AF GAIN ADJUST.

The S4.16 receiver gain is continuously adjustable between Mic and Line level.

Should the receiver signal be too high it will distort your mixer/amplifier. If the signal is too low the result will be an increase in general background noise.
Adjust this control to achieve the best signal quality.

4. **BATTERY INFORMATION.**

Please note that this product is designed to be used with a 9V Alkaline battery. Should you use a rechargeable cell, be sure not to force it into the battery compartment as some types can be considerably larger than standard types and note that the operation time will be much reduced.

5. **LOW-BATTERY STATUS INDICATOR ON TRANSMITTERS.**

In normal circumstances, with the use of an Alkaline 9V battery, the Transmitters should provide approximately 10hrs of continuous use. Should the Battery indicator go out, it is advisable to change the battery as soon as possible.

FAULT-FINDING.

In the event of a problem it is worth checking the following check list.

1. **No RF Signal Indication on Receiver!**

- a. Are the Receiver and Transmitter on the same channel?
- b. Is the battery fresh in the Transmitter and the battery indicator lit?

2. **No Audio Signal!**

- a. Is the AF Gain Control set correctly on the Receiver?
- b. Is the Squelch Control set correctly (Normally mid-position)?
- c. Is the MIC/INST switch in the correct position on the Beltpack?

OPTIMUM FREQUENCY CONFIGURATION

For USA and Canada Band, 616MHz – 630MHz

Up to 4 Frequency Set

Position	Frequency
2	617.725
5	620.400
9	622.825
12	626.550

Up to 8 Frequency Set

Position	Frequency
1	616.775
4	619.650
5	620.400
9	622.825
11	624.425
12	626.550
13	627.425
16	629.950

Up to 12 Frequency Set

Position	Frequency
1	616.775
2	617.725
3	618.100
4	619.650
5	620.400
6	620.850
9	622.825
11	624.425
12	626.550
13	627.425
14	628.550
16	629.950

Trantec recommend that 12 frequencies is the largest set that can be used with the S4.16

TECHNICAL SPECIFICATIONS:-

OVERVIEW.

Fully synthesised 16 channel PLL Quartz Controlled FM Wireless Microphone System incorporating a Dual Conversion Diversity Receiver with Integral Audio Dynamics Processor.

AF S/N RATIO: > 100dBA

AF FREQUENCY RESPONSE: Handheld 80Hz – 16KHz +/- 3dB.
Beltpack 60Hz - 16KHz +/- 3dB

AF THD: less than 1%

OPERATING TEMPERATURE RANGE:
-10^o - +45^oC / 95 relative humidity.

RECEIVER

OPERATING VOLTAGE: 12V @ 100mA

FIRST IF FREQUENCY: 55.875MHz

SECOND IF FREQUENCY: 10.700MHz

AF OUTPUT: Variable to +10dBu unbalanced via 1/4 inch mono Jack socket.
+16dBu Balanced via XLR 3F connector Pin 2 +.

INDICATORS: 4 position RF Bargraph, AF peak (overload), Power, Diversity A/B.

CONTROLS: Channel select, AF output, Squelch.

DIMENSIONS: 35 x 213 x 98mm.

WEIGHT: Approx 580g

HANDHELD TRANSMITTER

OPERATING VOLTAGE:	9V @ <50mA.
OPERATING TIME:	approx 10 hours.
OUTPUT POWER:	10mW max.
CONTROLS:	Frequency select, On-off switch.
INDICATORS:	Battery status Led.
TRANSDUCER TYPE:	Dynamic with Cardioid pattern.
DIMENSIONS:	280 x 50mm max. (including grille)
WEIGHT:	Approx 210g

BELTPACK TRANSMITTER

OPERATING VOLTAGE:	9V @ <50mA.
OPERATING TIME:	approx 10 hours.
OUTPUT POWER:	10mW max.
CONTROLS:	Frequency select, On-off switch, Lapel/Instrument switch, Gain adjust.
INDICATORS:	Battery status Led.
CONNECTORS:	AF input via 3.5mm socket. Tip = Audio. Ring + sleeve = Gnd.

LP2 LAVALIER MICROPHONE:	Back electret condenser microphone with omni-directional pattern.
DIMENSIONS:	60 x 100 x 30mm mm including belt clip.
WEIGHT:	Approx 90g
TYPE APPROVALS.	ETSI 300-422, FCC pt 74 h.

DECLARATION OF CONFORMITY:

This equipment is in compliance with the essential requirements and other relevant provisions of Directives 1999/5/EC, 89/336/EC or 73/23EC.

GUARANTEE:

All Trantec products are guaranteed for a period of one year from date of purchase against defects in materials and workmanship. In the event of a claim under guarantee the system should be returned to your dealer in its original packaging and with proof of purchase. Defects caused by modification, mis-use or accident are not covered by this guarantee. E & OE
Due to our continual policy of research and development we reserve the right to alter specifications without prior notice.

10/06



TOA Corporation

URL: <http://www.toa.jp/>

D33-12-019-2B