



UHF WIRELESS MICROPHONE

WM-5270

Thank you for purchasing TOA's UHF Wireless Microphone.
Please carefully follow the instructions in this manual to ensure long, trouble-free use of your equipment.

1. SAFETY PRECAUTIONS

- Be sure to read the instructions in this section carefully before use.
- Make sure to observe the instructions in this manual as the conventions of safety symbols and messages regarded as very important precautions are included.
- We also recommend you keep this instruction manual handy for future reference.



WARNING

Indicates a potentially hazardous situation which, if mishandled, could result in death or serious personal injury.

- To prevent the electromagnetic wave from badly influencing medical equipment, make sure to switch off the unit's power when placing it in close proximity to the medical equipment.



CAUTION

Indicates a potentially hazardous situation which, if mishandled, could result in moderate or minor personal injury, and/or property damage.

- When the unit is not in use for 10 days or more, be sure to take the battery out of the unit because battery leakage may cause personal injury or contamination of environment.
- Make sure to observe the following handling precautions so that a fire or personal injury does not result from leakage or explosion of the battery.
 - Do not short, disassemble, heat nor put the battery into a fire.
 - Do not solder a battery directly.
 - Be sure to use the specified type of battery.
 - Note correct polarity (positive and negative orientation) when inserting a battery in the unit.
 - Avoid locations exposed to the direct sunlight, high temperature and high humidity when storing batteries.
- Attention should be drawn to the environmental aspects of battery disposal.

CAUTION TO USER: Changes or modifications not expressly approved by the party responsible for compliance could void the user's authority to operate the equipment.

2. GENERAL DESCRIPTION

The TOA's WM-5270 Wireless Microphone employs a dynamic microphone with high input handling capacity, and is suitable for vocal use.

3. FEATURES

- One frequency can be selected from 64 frequencies (16 channels x 4 banks) of 636 – 700 MHz.
- An optimized PLL-synthesizer minimizes the oscillation frequency drift resulting from the ambient temperature or voltage fluctuation.
- The maximum input sound pressure can be set in the range of 130 dB SPL to 142 dB SPL by a PAD switch, permitting adaptation to wide range of input sound pressure.
- Power/Battery lamps indicate battery consumption to prevent the unit from malfunctioning when the battery level remarkably decreases.
- Operates on a single AA battery.
- Employs a built-in antenna.
- The state of battery consumption can be displayed on the tuner's indicator when the unit is used in conjunction with the optional WT-5800, WT-5805 or WT-5810 Wireless Tuner.

4. HANDLING PRECAUTIONS

- Do not expose the unit to rain or an environment where it may be splashed by water or other liquids, as doing so may result in unit failure.
- Never open nor remove the unit case to modify the unit. Refer all servicing to your nearest TOA dealer.
- Take care not to drop the unit onto the floor nor bump it against a hard object as the unit could fail.
- Do not place the unit in locations of high temperature (ex. in an ill-ventilated car in summer) or high humidity as the unit could fail.
- Do not use the unit in locations where it is exposed to seawater.
- To clean, use a dry cloth. When the unit gets very dirty, wipe lightly with a cloth dampened in a dilute neutral cleanser, then wipe with a dry cloth. Never use benzine, thinner, or chemically-treated cleaning towel.
- Avoid using a mobile telephone near the wireless microphone in use. Noise could be picked up.
- When using two or more wireless microphones, keep them at least 50 cm away from each other to avoid malfunctions or noise.
- Keep the wireless microphone at least 3 m away from the receiving antenna. Using the microphone in close proximity to the antenna could result in malfunctions or noise.

5. NOMENCLATURE

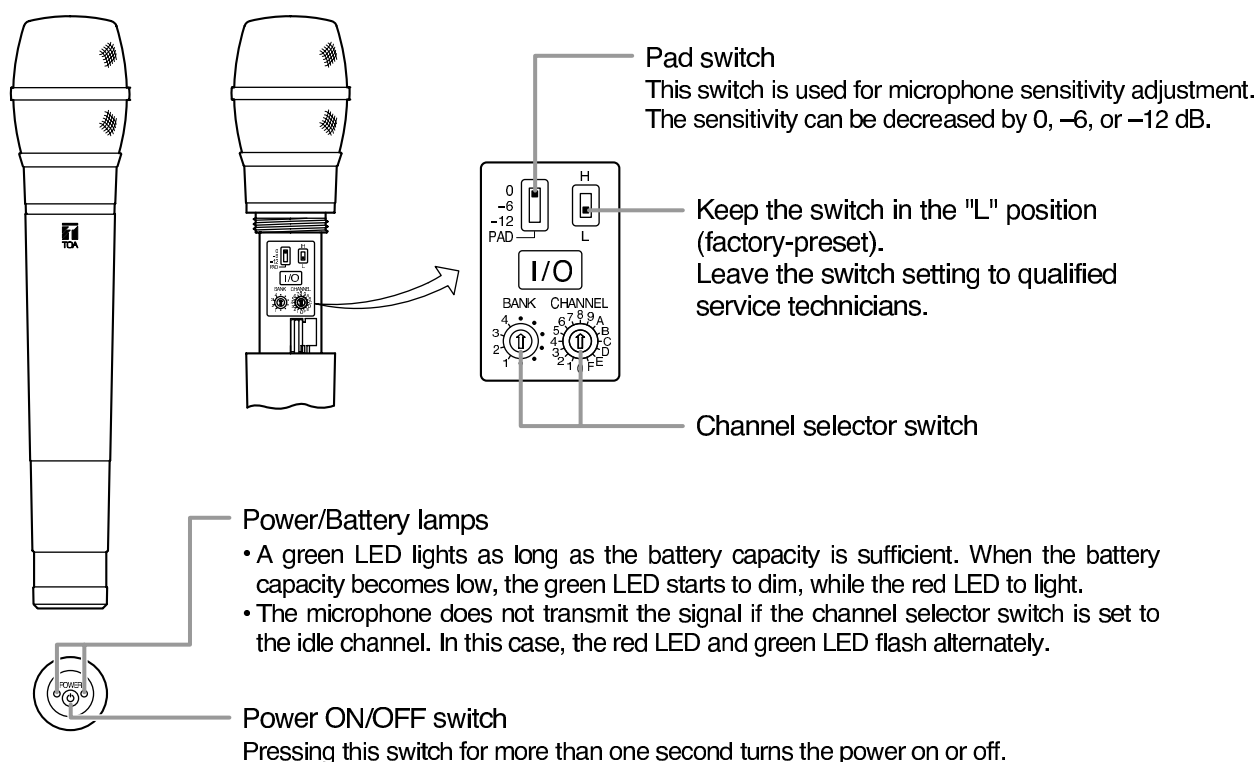

6. REPLACING THE BATTERY

- Step 1.** Hold down the power switch for one second or more to turn off the power.
- Step 2.** Hold the microphone body and rotate the microphone grip counterclockwise to remove it.
- Step 3.** Insert an AA battery according to (+) and (-) indications on the battery compartment.
- Step 4.** Replace the microphone grip by sliding and rotating it clockwise.

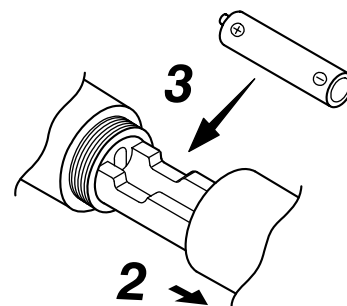

Battery replacement

- A brand-new AA alkaline battery will continuously operate the unit for about 10 hours.
- When the battery capacity becomes low, the green LED of the Power/Battery lamps starts to dim, while the red LED to light. When only the red LED lights, replace the battery with a new one. In this condition, the unit transmits the remaining battery capacity information to the tuner, causing the tuner's BATT indicator to light.

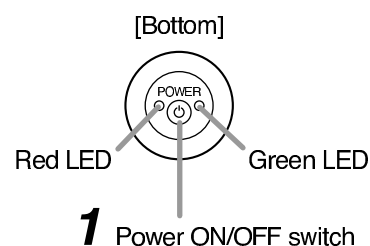

7. CHANNEL NUMBER SETTING

Step 1. Switch off the power. Rotate the microphone grip counterclockwise to remove it.

Step 2. Using the screwdriver housed in the microphone body, set the Channel selector switch pointer to the desired channel number.

Step 3. Replace the microphone grip.

Note

Make sure that the wireless microphone is identical to the wireless tuner in the channel number.

Should the microphone's setting differ from that of the tuner, the tuner does not receive the microphone signal.

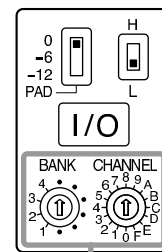
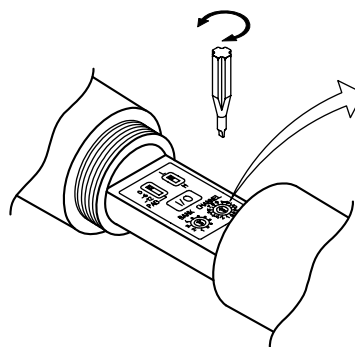

Channel selector switch

8. PAD SWITCH

The input sensitivity can be decreased by 0 dB, -6 dB or -12 dB with the PAD switch.

Select the appropriate level so that the output sound is not distorted when the volume control knob of the tuner is set at the 2 o'clock position.

If a loud voice distorts the output sound, decrease the sensitivity by shifting the PAD switch to the -6 dB or -12 dB position.

Note: The PAD switch is factory-preset to 0 dB.

The table at right shows the relationship between the PAD switch positions and the maximum input levels.

PAD switch	Maximum input level
0 dB	130 dB SPL
-6 dB	136 dB SPL
-12 dB	142 dB SPL

Pad switch

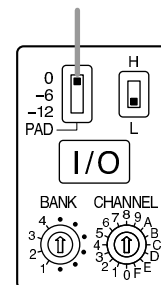

9. OPERATION

Step 1. Confirm that the wireless microphone and the wireless tuner are identical in the channel number.

If not identical, turn off the power ON/OFF switch, then set the channel number to the same channel number as the tuner.

Step 2. Hold down the power switch for one second or more to turn on the power.

Then, confirm the green LED of the Power/Battery lamps will light.

Step 3. Hold down the power switch for one second or more to turn off the power after use.

10. OPERATIONAL HINTS

- The microphone's service distance is 3 – 120 m. When the microphone user moves in a facility, signal dropouts (momentary losses of signal reception) may be encountered. These dropouts are caused by the building's architectural designs or materials which block the travel of or reflect the radio signal. If this occurs, the user needs to change locations for better signal reception.
- The proper operation of your wireless system may be interfered with by other system operating on the same frequency. In such cases, change the operating frequency of your system. (As to dealing with the interference, refer to the operating instructions of the wireless tuner.)
- Should you have any questions regarding the use or availability of TOA wireless products, please contact your local TOA dealer.
- If the output sound is distorted at the large volume level, use the microphone by shifting the PAD (input sensitivity reduction) switch to the -6 dB or -12 dB position to decrease the sensitivity.
- Attach the supplied rolling stopper as needed, preventing the microphone from rolling and dropping onto the floor.

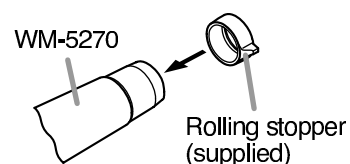

11. SPECIFICATIONS

Microphone Element	Dynamic microphone unit, cardioid pattern
Modulation	Frequency modulation
Frequency Range	636-697.925MHz
Selectable Channel	64 frequencies (the number of channels may differ from country to country.)
RF Carrier Power	Less than 50 mW
Tone Frequency	32.768 kHz
Oscillator	PLL synthesized
Maximum Input Level	142 dB SPL
Maximum Deviation	±40 kHz
Audio Frequency Response	80 – 15,000 Hz
Dynamic Range (AF Circuit)	More than 95 dB (with WT-5800)
Battery	LR6 (AA)
Battery Life	More than 10 hours (alkaline)
Indicator	Power/Battery lamps
Antenna	Built-in type
Operating Temperature	-10 to +50°C
Finish	Dark gray
Dimensions	ø48 x 244 mm
Weight	340 g (with battery)

Note: The design and specifications are subject to change without notice for improvement.

• Accessories

Microphone holder (with stand adapter)	1	Storage case	1
Screwdriver for setting (housed in the body)	1	Rolling stopper	1

License requirement

The term "IC:" before the radio certification number only signifies that Industry Canada Technical specifications were met. Operation is subject to the following two conditions:

(1) This device may not cause harmful interference, and (2) this device must accept any interference received, including interference that may cause undesired operation.

IMPORTANT NOTE: To comply with the FCC RF exposure compliance requirements, no change to the antenna or the device is permitted. Any change to the antenna or the device could result in the device exceeding the RF exposure requirements and void user's authority to operate the device.