

**TP-LINK®**

# **AP200**

# **User Guide**

AC750 Wireless Gigabit Access Point

# Contents

<b>Chapter 1. About This Guide</b> .....	<b>1</b>
<b>Chapter 2. Get to Know About Your AP Device</b> .....	<b>2</b>
1. 1. Product Overview .....	3
1. 2. Main Features .....	3
1. 3. Panel Layout .....	4
1. 3. 1.Top View .....	4
1. 3. 2.The Back Panel .....	6
1. 4. Position Your AP Device .....	6
<b>Chapter 3. Operation Modes</b> .....	<b>8</b>
2. 1. Determine the Mode .....	9
2. 2. Connect Your AP Device .....	9
<b>Chapter 4. Log into Your AP Device</b> .....	<b>11</b>
<b>Chapter 5. Set Up Wireless Connections</b> .....	<b>14</b>
4. 1. Quick Setup .....	15
4. 2. WPS .....	15
4. 3. Specify the Wireless Settings .....	17
4. 4. Check the connection status .....	22
<b>Chapter 6. Customize Your Network and Security Settings</b> .....	<b>24</b>
5. 1. Change the LAN Settings .....	25
5. 2. Specify DHCP Server Settings .....	25
5. 3. Access Control .....	27
5. 4. Advanced Wireless Settings .....	29
<b>Chapter 7. Manage Your AP Device</b> .....	<b>32</b>
6. 1. System Log .....	33
6. 2. Test the Network Connectivity .....	33
6. 3. Upgrade the Firmware .....	35
6. 3. 1.Local Upgrade .....	36
6. 3. 2.Online Upgrade .....	36





6.4.	Backup and Restore Configuration Settings .....	37
6.5.	Change the Management Account.....	38
6.6.	Throughput Monitor .....	39
6.7.	Statistics .....	39
6.8.	SNMP Management.....	40
6.9.	Ping Watchdog.....	41
6.10.	LEDs Control .....	42
6.11.	Mode Switch.....	42
<b>Chapter 8. FAQ.....</b>		<b>43</b>
<b>Chapter 9. Specifications .....</b>		<b>47</b>

# About This Guide

This guide provides details of each function and shows how to configure the AP device appropriate to your needs. In addition to this guide, a Quick Installation Guide is also released with each TP-LINK AP device, you are suggested to configure your AP device for quick Internet setup by following the published Quick Installation Guide before you get started with a further configuration.

## Conventions

In this guide the following conventions are used:

Convention	Description
AP device	Stands for 11AC Wireless Gigabit Access Point without any explanation.
parameters	Parameters provided in the screenshots are just references for setting up the device, which may differ from the actual situation. You can set the parameters according to your demand.
screenshots	The demonstrated screenshots may look a little different from the actual web page of your device due to the various firmware versions. Please just configure your product based on the actual web page.
<i>Blue Italic</i>	Hyperlinks are in blue italic. You can click to redirect to a website or a specific section.
Blue	Contents to be emphasized and texts on the web page are in blue, including the menus, items, buttons, etc.
>	The menu structures to show the path to load the corresponding page. For example, <a href="#">Advanced</a> > <a href="#">Wireless</a> > <a href="#">WPS</a> means the WPS function page is under the Wireless menu that is located in the Advanced tab.
 <b>Note:</b>	Ignoring this type of note might result in a malfunction or damage to the device.
 <b>Tips:</b>	Indicates important information that helps you make better use of your device.
symbols on the web page	<ul style="list-style-type: none"><li> click to edit the corresponding entry.</li><li> click to delete the corresponding entry.</li><li> click to enable or disable the corresponding entry.</li></ul>

## Chapter 1

---

# Get to Know About Your AP Device

---

This chapter introduces what the AP device can do and shows its main features and appearance.

This chapter contains the following sections:

- *Product Overview*
- *Main Features*
- *Panel Layout*
- *Position Your AP Device*

## 1.1. Product Overview

### What This Product Does

The TP-LINK Wireless AC Access Point is designed to establish or expand a scalable high-speed wireless AC network or to connect multiple Ethernet enabled devices such as game consoles, digital media adapters, printers, or network attached storage devices to a wireless network. The AP supports a host of different functions that make your wireless networking experience more flexible than ever before. Now, you can enjoy a better Internet experience when downloading, gaming or video streaming.

### 802.11ac - The Next Generation of Wi-Fi

TP-LINK's Wireless AC Access Point comes with the next generation Wi-Fi standard - 802.11ac, backward compatible with 802.11n and 3 times faster than wireless N speeds. With higher power efficiency and robust security, 802.11ac is the perfect way to accelerate a home multimedia network and solve congestion that multiple devices may cause.

### Concurrent Dual Band - More Bandwidth, Less Interference

With the high wireless speeds over the crystal clear 5GHz band and the 2.4GHz band, the Wireless AC Access Point offers you the flexibility of two dedicated networks and ensures amazing wireless performance. Simple tasks such as sending e-mails or web browsing can be handled by the 2.4GHz band while bandwidth intensive tasks like online gaming or HD video streaming can be processed by the 5GHz band – all at the same time.

### Broad Wi-Fi Coverage and Targeted Connection

Featuring multiple detachable external antennas and high power amplifiers, the Wireless AC Access Point is able to boost Wi-Fi coverage throughout your home. Advanced Beamforming technology enables it to focus Wi-Fi signal on connected devices, delivering a more targeted and highly efficient wireless connection.

### Multiple Operating Modes - Easy to Build WLAN

Supports AP, Bridge/Repeater, Client and Multi-SSID operation modes to enable various wireless applications to give you a more dynamic and comprehensive experience when using the AP device. Multiple operating modes also helps you easily build wireless network for hard-to-wire locations or eliminate wireless dead zone.

## 1.2. Main Features

### Wireless and Wired Performance

- Supports 802.11ac - The next generation of Wi-Fi, compatible with 802.11n

- Support simultaneous 2.4GHz and 5GHz connections
- Two detachable external antennas and high power amplifiers provide stable signals and optimal wireless coverage
- Support passive PoE
- Up to 4 SSIDs and VLAN support
- Provides WPA/WPA2, WPA-PSK/WPA2-PSK authentication, TKIP/AES encryption security
- Supports MAC filter, throughput monitor
- Easy one-touch WPA wireless security encryption with the WPS button
- Supports firmware upgrade and Web management
- Supports system log and Traffic Statistics



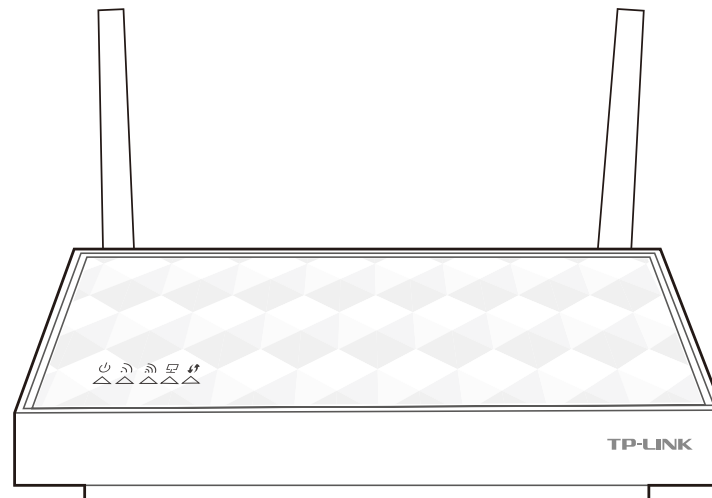

## 1.3. Panel Layout

### 1.3.1. Top View



The AP device's LEDs are located on the top panel. You can check the AP device's working status by following the LED Explanation table (view from left to right).

## LED Explanation

Name	Status	Indication
 (Power)	On	System initialization completes.
	Blinking	System initialization or firmware upgrade is in process. Do not disconnect or power off the AP device.
	Off	Power is off. Please ensure that the power adapter is connected correctly.
 (Wireless 2.4GHz)	On	The wireless 2.4GHz band is working properly (in AP/Multi-SSID/Repeater/Bridge mode).
	Off	The wireless 2.4GHz band is disabled (in AP/Multi-SSID/Repeater/Bridge mode). The LED is always off (in Client mode).
 (Wireless 5GHz)	On	The wireless 5GHz band is working properly (in AP/Multi-SSID/Repeater/Bridge mode).
	Off	The wireless 5GHz band is disabled (in AP/Multi-SSID/Repeater/Bridge mode). The LED is always off (in Client mode).
 (LAN)	On	A device is connected to the Ethernet port.
	Off	No device is connected to the Ethernet port.
 (WPS)	Slow blinking	WPS connection is in process.
	On	WPS connection is successful. It will turn off after 5 minutes.
	Quick blinking	WPS connection is failed.
	Solid green	The signal strength is great (in Repeater/Bridge/Client mode).
	Solid orange	The signal strength is good (in Repeater/Bridge/Client mode).
	Solid red	The signal strength is too weak (in Repeater/Bridge/Client mode).
	Off	The device is disconnected from the host network (in Repeater/Bridge/Client mode).

**Note:**

After a device is successfully added to the network by WPS function, the WPS LED will keep on for about 5 minutes and then turn off.



### 1.3.2. The Back Panel

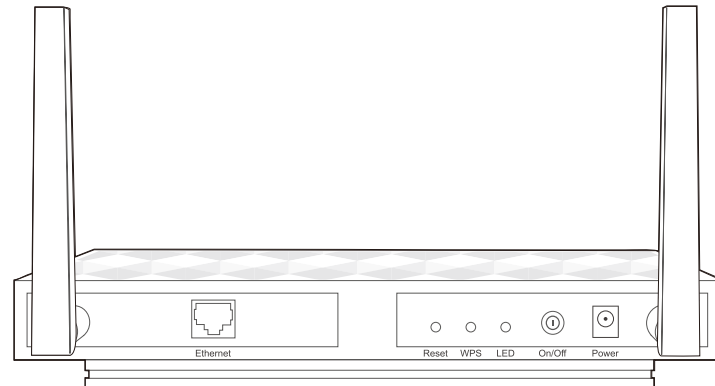

The AP device's back panel shows the connection ports, buttons and antennas. Refer to the following for detailed instructions (view from left to right).

Item	Description
Ethernet	One LAN 10/100/1000Mbps Auto-Negotiation RJ45 Port connects to a network device and supports passive PoE.
Reset	The switch for the reset function. With the device powered on, use a pin to press and hold the Reset button for five seconds until the Power LED starts blinking, then release the button.
WPS	Press and hold this button for two seconds to enable the WPS function. When the WPS LED blinks slowly, the device is trying to connect or to be connected.
LED	Press this button to turn on or turn off the LEDs.
On/Off	The switch for the power. Press it to power on or off the AP device.
Power	The power port connects to the provided power adapter.
Antennas	Used for wireless operation and data transmit. Upright them for the best Wi-Fi performance.

## 1.4. Position Your AP Device

- Place your AP device in a well-ventilated place far from any heater or heating vent
- Avoid direct irradiation of any strong light (such as sunlight)
- Keep at least 2 inches (5 cm) of clear space around your AP device
- Operating Temperature: 0°C~40°C (32°F~104°F)
- Operating Humidity: 10%~90%RH, Non-condensing

Generally, your AP device is placed on a horizontal surface. It also can be mounted on the wall as shown below.

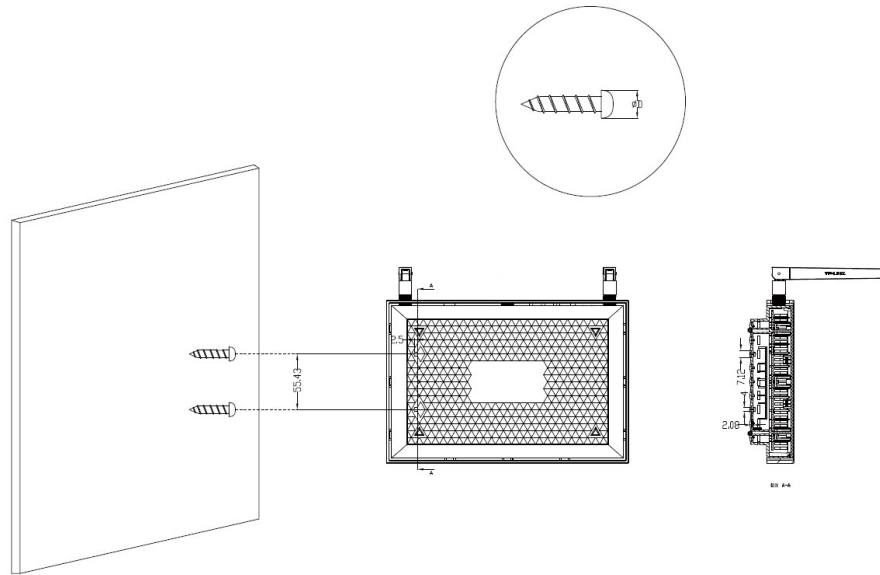

**Note:**

The diameter of the screw,  $4\text{mm} < D < 7\text{mm}$ , and the distance of two screws is 55.43mm. The screw that projects from the wall needs around 3.5mm based, and the length of the screw need to be at least 20mm to withstand the weight of the product.

## Chapter 2

---

# Operation Modes

---

The AP device supports four modes to satisfy user's diversified network requirements including Access Point mode, Repeater/Bridge mode, Client mode and multi-SSID mode. This chapter introduces typical usage scenarios of each mode. You can choose the desired scenario according to your needs, and refer to this part for hardware connection instruction.

- *Determine the Mode*
- *Connect Your AP Device*

## 2.1. Determine the Mode

Use the following scenarios to determine an appropriate operating mode for your network needs.

Modes	Scenarios
Access Point mode (Default mode)	You want to be able to access the Internet wirelessly, but this place only has an Ethernet port (wired network) available. you need to transform the existing wired network to a wireless network.
Repeater/Bridge mode	You are in a Wi-Fi dead-zone or a place with weak wireless signal. You want to have a greater effective range of the wireless signal throughout your home or office.
Client mode	You have a wired device with an Ethernet port and no wireless capability, for example, a Smart TV, Media Player, or game console. You want to connect it to the Internet wirelessly.
Multi-SSID mode	You want to divide the existing Wi-Fi network into several networks for different people with different access level and authority, for example, the guests, the host, the children and the parents.

## 2.2. Connect Your AP Device

Follow the figures below to connect your AP device.

**Note:**

AP200 is used for demonstration in this guide.

- **Access Point mode**

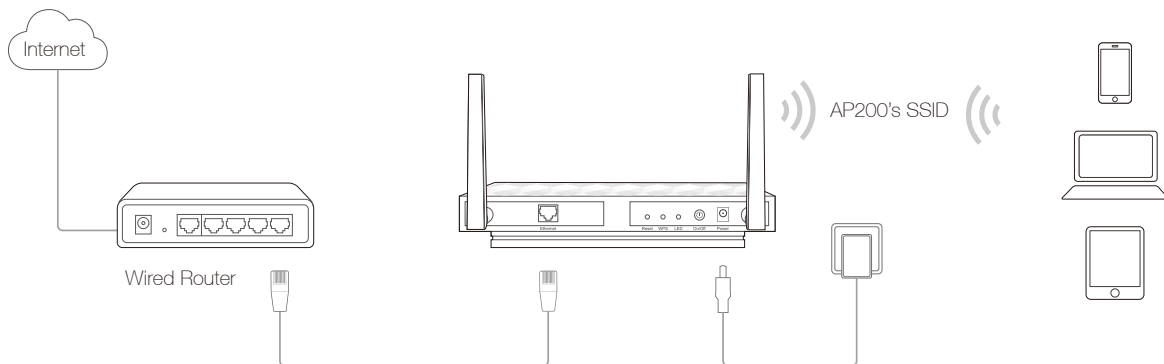

• Repeater/Bridge mode

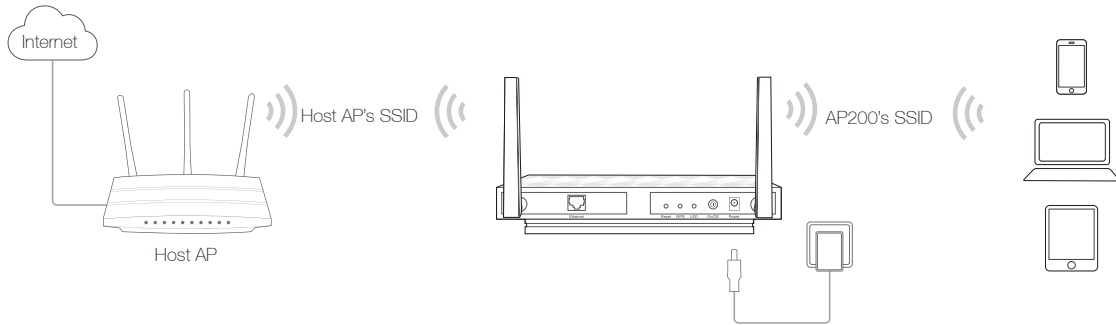

• Client mode

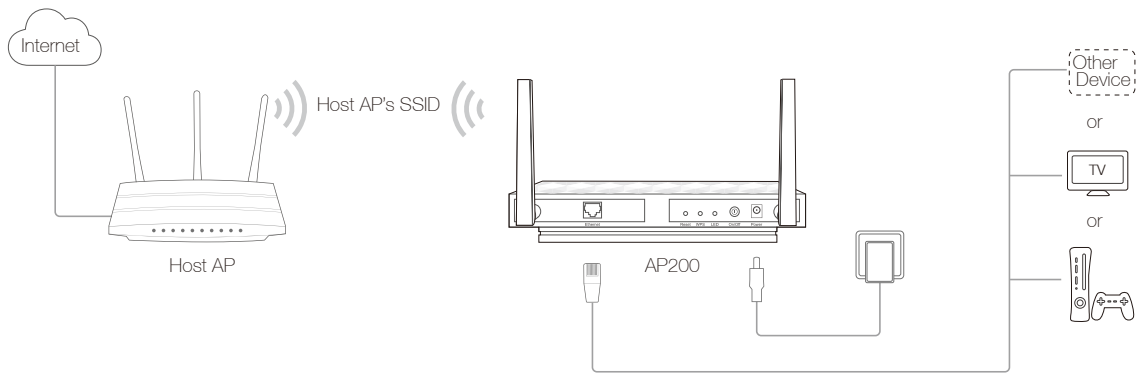

• Multi-SSID mode

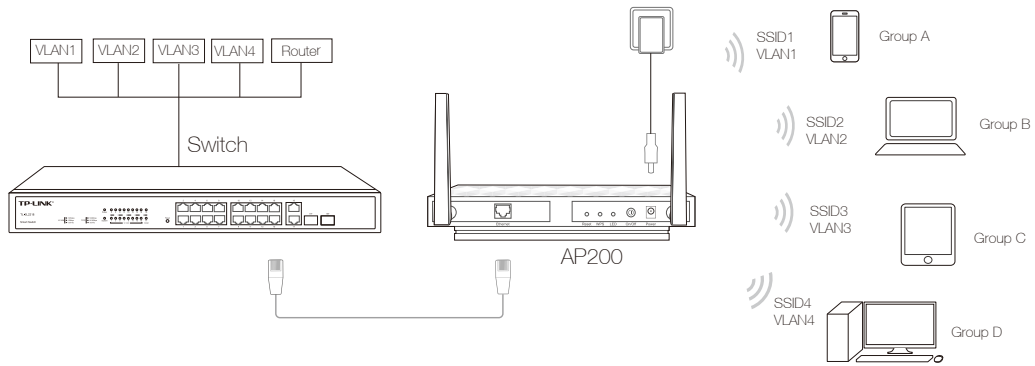

## Chapter 3

---

# Log into Your AP Device

---

With the Web-based management page, it is easy to configure and manage the AP device. The Web-based utility can be used on any Windows, Macintosh or UNIX OS with a Web browser, such as Microsoft Internet Explorer, Mozilla Firefox or Apple Safari.

Follow the steps below to log into your AP device.

1. Set up the TCP/IP Protocol in [Obtain an IP address automatically](#) mode on your computer.
2. Launch your Web browser. Enter <http://tplinkap.net> in the address field and Press Enter (PC) or Return (Mac).



3. Upon initial login, please enter [admin](#) in the username and password fields.

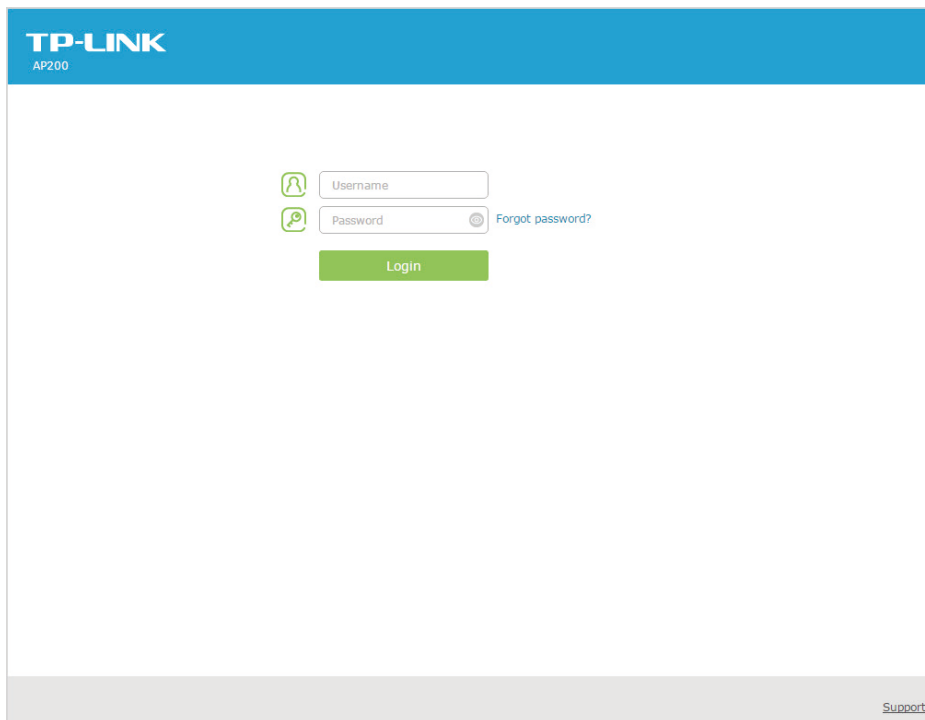

4. In the following pop-up window, it is recommended to change the device's username and password from its default settings for network security. Enter and confirm new username and password, then click [Confirm](#).

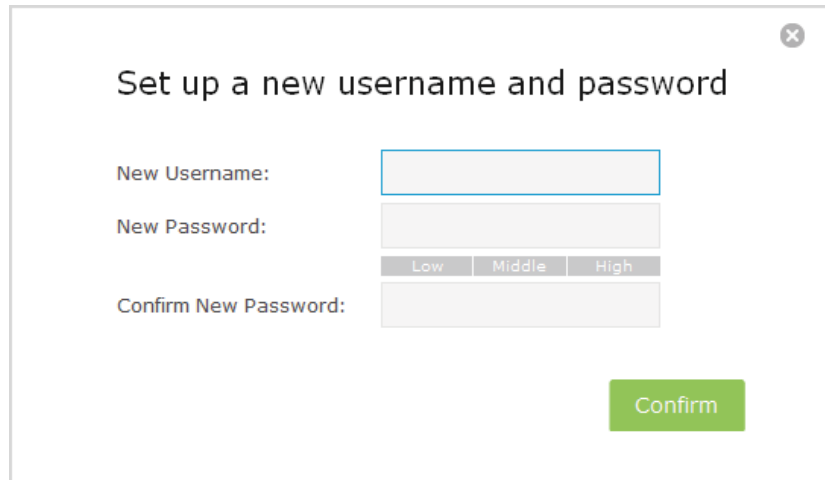

The screenshot shows a web form titled "Set up a new username and password" with a close button (X) in the top right corner. The form contains three input fields: "New Username:", "New Password:", and "Confirm New Password:". The "New Password:" field has a strength indicator below it with three segments labeled "Low", "Middle", and "High". A green "Confirm" button is located at the bottom right of the form.

5. For subsequent logins, you only need to enter the username and password that you have set to log in.

**Note:**

If the login window does not appear, please refer to [FAQ > Q3. I cannot log into the AP device's web management page, what can I do?](#)



## Chapter 4

---

# Set Up Wireless Connections

---

This chapter introduces how to connect your AP device to the wireless network. The AP device is equipped with a web-based Quick Setup wizard. You can also set up the wireless connection by the WPS feature. In addition, you can specify your wireless settings for some advanced features.

This chapter contains the following sections:

- *Quick Setup*
- *WPS*
- *Specify the Wireless Settings*
- *Check the connection status*

## 4.1. Quick Setup

Quick Setup wizard allows you to quickly configure your AP device step by step. Choose the suitable operation mode according to your network environment and follow the step-by-step instructions.

1. Visit <http://tplinkap.net>, and log in with the username and password you set for the AP device.
2. Go to *Quick Setup* on the top of the page, and follow the on-screen instructions to configure your AP device.

**Note:**

You can also change the operation mode by click the Mode button on the top of the page, and then you will be guided to the steps of Quick Setup.

## 4.2. WPS

WPS (Wi-Fi Protected Setup) feature can help you to quickly and securely connect to a network. WPS functions differently in different operation modes. In Access Point and Multi-SSID modes, the WPS feature can be used only when the network security is set to None or WPA2-PSK/AES. In Repeater/Bridge and Client modes, this device can use WPS (Push button method) to connect to Host network while local wireless networks do not support the WPS feature.

This section will guide you to add a new wireless device to an existing network quickly by the WPS feature. There are two ways to use this feature: by push button method and by PIN (Personal Identification Number). The PIN method can only be applied in Access Point and Multi-SSID modes.

### Push Button Method

Follow the steps below to use WPS by push button method.

1. Press the WPS button on the real panel of the AP device. The WPS LED will blink slowly, which shows the function has been triggered and the device is trying to connect or to be connected. This process may take up to 2 minutes.

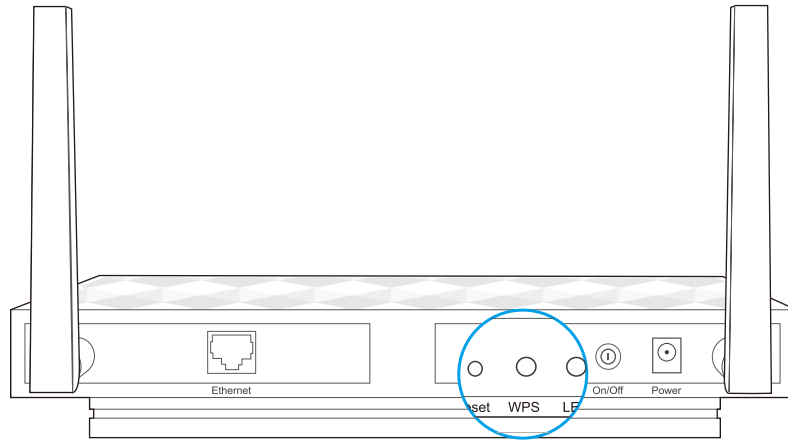

2. Press the WPS button of the device you want to connect to in 2 minutes.

**Note:**

The order to press the WPS button of the AP device and the device to be connected can be in reverse.

3. If the AP device's WPS LED is solid on, it shows the WPS connection is successful. If the AP device's WPS LED blinks quickly, it shows the WPS connection is failed. Please perform the steps again.

**Note:**

1. If the WPS connection is successful, after about 5 minutes, the WPS LED will turn off.
2. If the connection still fails, contact the technical support.

## PIN Method

Other devices can connect to this AP device by WPS with the AP device's PIN and the AP device can connect to other devices by entering their PINs. The PIN method can only be applied in Access Point and Multi-SSID modes.

**WPS** ?

---

Enable WPS:  On

**AP's PIN**

---

AP's PIN:  On

PIN: 09745940 Generate Default

**WPS Wizard**

---

Select a WPS connection method:  Push Button (Recommended)  PIN

Connect

Follow the steps below to use WPS by PIN method.

1. Visit <http://tplinkap.net>, then log in with the username and password you set for the AP device.
2. Go to [Settings](#) > [Wireless](#) > [WPS](#). There are also two ways to use WPS PIN method: using the AP device's PIN and using the wireless client's PIN.

➤ **Using the AP's PIN**

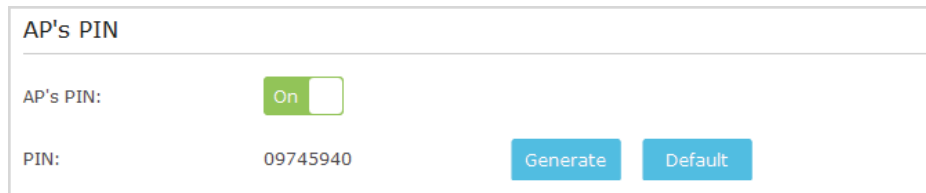

- 1) Toggle On [Enable AP's PIN](#) to allow wireless clients to connect to the device using the AP's PIN.
- 2) Click [Generate](#) to generate a new PIN randomly or click [Default](#) to restore the current PIN to the factory default PIN. Using this PIN to connect to the AP device. The default PIN can be found on the label of the AP device.

➤ **Using the wireless client's PIN**

- 1) Select the [PIN](#) as the setup method.

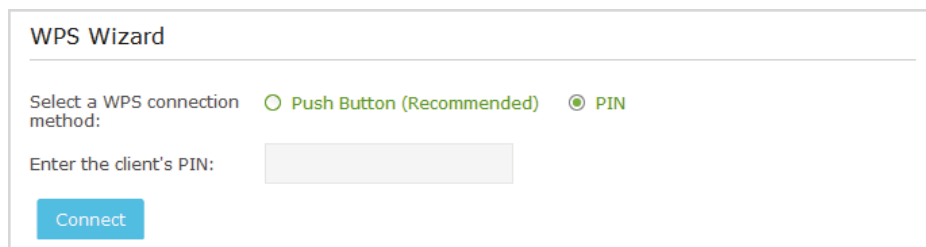

- 2) Entering the wireless client's WPS PIN into [Enter the client's PIN](#) field and click [Connect](#).

📌 **Note:**

Selecting [Push button \(Recommended\)](#) is equal to pressing the physical WPS button on the device.

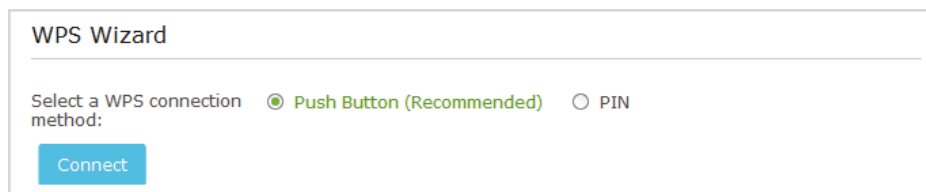

## 4.3. Specify the Wireless Settings

Follow the steps below to check or modify your wireless connection settings.

1. Visit <http://tplinkap.net>, then log in with the username and password you set for the AP device.
2. Go to [Settings](#) > [Wireless](#). And the following page decided by the mode of the AP device will appear.

### ➤ Access Point Mode

If Access Point mode is selected, please take the following steps:

The screenshot shows the 'Wireless Settings' page for a TP-Link Access Point. At the top right, there are tabs for '2.4GHz' and '5GHz'. The 'Enable Wireless Radio' checkbox is checked. The 'Network Name (SSID)' is 'TP-LINK\_9FD9' with a 'Hide SSID' checkbox. The 'Security' is set to 'WPA/WPA2 - Personal (Recommended)'. The 'Version' is 'WPA2-PSK'. The 'Encryption' is 'AES'. The 'Password' is '09745940'. The 'Group Key Update Period' is '0' seconds. The 'Mode' is '802.11b/g/n mixed'. The 'Channel Width' is 'Auto'. The 'Channel' is 'Auto'. The 'Transmit Power' is 'High'. A green 'Save' button is at the bottom right.

- 1) Select the wireless network [2.4GHz](#) or [5GHz](#). Here we take [2.4GHz](#) for demonstration.
- 2) The wireless radio is enabled by default. Customize the [Network Name \(SSID\)](#) and [Security](#) settings. The AP device provides four security options, None, WPA/WPA2 - Personal, WPA/WPA2 - Enterprise and WEP. The default WPA/WPA2 - Personal is recommended. Enter a [Password](#) below to prevent unauthorized access to your AP device.

#### 📌 Note:

1. It is recommended to keep the default settings for other parameters. If it is necessary to change the related parameters, please refer to the help page.
  2. Tick [Hide SSID](#) if you want to hide this wireless network name.
- 3) Click [Save](#) to save all your settings.

#### In addition

- [Mode](#) - Select the transmission mode for your wireless client devices, [802.11b/g/n mixed](#), [802.11g/n mixed](#) or [802.11n only](#) for [2.4GHz](#) and [802.11a/n/ac mixed](#),

802.11n/ac mixed or 802.11ac only for 5GHz. It is recommended to keep the default settings.

- **Channel Width** - Select a channel width for the wireless network, 40MHz or 20MHz for 2.4GHz and 80MHz, 40MHz or 20MHz for 5GHz.
- **Channel** - Select an operating channel for the wireless network. The default channel is Auto, which finds the best channel available automatically. It is recommended to leave the channel to Auto if you are not experiencing the intermittent wireless connection issue.

### ➤ Repeater/Bridge Mode

If Repeater/Bridge mode is selected, please take the following steps:

#### Connect to Host Network

You can choose one band to connect.

Wireless Band:  2.4GHz  5GHz

[Wireless Scanner](#)

Host SSID:

Host BSSID:

WDS Mode:

Host Security:

Version:  Auto  WPA-PSK  WPA2-PSK

Encryption:  Auto  TKIP  AES

Host Password:

[Save](#)

#### Extended Network Settings 2.4GHz | 5GHz

Extended 2.4GHz:  Enable Wireless Radio

Wireless Network Name(SSID):  [Copy Host SSID](#)

Hide SSID

Security:

Version:  Auto  WPA-PSK  WPA2-PSK

Encryption:  Auto  TKIP  AES

Password:

Group Key Update Period:  Seconds

[Save](#)

- 1) Select the wireless network **2.4GHz** or **5GHz** to connect. Here we take **2.4GHz** for demonstration.
- 2) Enter the exact same wireless settings of the Host network that you want to connect to. Or click **Wireless Scanner** and choose a Host network from the list. Once a network is selected, its SSID, MAC address and security settings (except the password) will be automatically filled in the respective fields. If the selected network is protected, enter the password.
- 3) Click **Save** to save the settings.
- 4) Select the wireless network **2.4GHz** or **5GHz** to configure the extended wireless settings. Here we take **2.4GHz** for demonstration.
- 5) The wireless radio is enabled by default. Customize the **Wireless Network Name (SSID)** and **Security** settings. The AP device provides four security options, None, WPA/WPA2 - Personal, WPA/WPA2 - Enterprise and WEP. The default WPA/WPA2 - Personal is recommended. Enter a **Password** below to prevent unauthorized access to your AP device.

**Note:**

1. If you want to automatically copy the same SSID and security settings as the Host AP, click the **Copy Host SSID** button .
2. If you want to hide this wireless network name, tick **Hide SSID**.

- 6) Click **Save** to save the settings.

➤ **Client Mode**

If Client mode is selected, please take the following steps:

### Connect to Host Network

You can choose one band to connect.

Wireless Band:  2.4GHz  5GHz

**Wireless Scanner**

Host SSID: TP-LINK\_A688

Host BSSID: E8-94-F6-79-A6-87

WDS Mode: Auto ▼

Host Security: WPA/WPA2 - Personal (Recommended) ▼

Version:  Auto  WPA-PSK  WPA2-PSK

Encryption:  Auto  TKIP  AES

Host Password: 12345678









**Save**

- 1) Select the wireless network [2.4GHz](#) or [5GHz](#) to connect. Here we take [2.4GHz](#) for demonstration.
- 2) Enter the exact same wireless settings of the Host network that you want to connect to. Or click [Wireless Scanner](#) and choose a Host network from the list. Once a network is selected, its SSID, MAC address and security settings (except the password) will be automatically filled in the respective fields. If the selected network is protected, enter the password.
- 3) Click [Save](#) to save the settings.

### ➤ Multi-SSID Mode

If Multi-SSID mode is selected, please take the following steps:

Wireless Settings
2.4GHz 5GHz

ID	Network Name (SSID)	Encryption	Status	Modify
1	TP-LINK_MULTI_2G_0	psk		
2	TP-LINK_MULTI_2G_1	psk		
3	TP-LINK_MULTI_2G_2	psk		
4	TP-LINK_MULTI_2G_3	psk		



Mode: 802.11b/g/n mixed ▼

Channel Width: Auto ▼

Channel: Auto ▼

Transmit Power:  Low  Middle  High

Save

- 1) The list will show the information of the Multi-SSID. The icon  means this SSID is enabled, and you can click it to disable. While the icon  means this SSID is disabled, and you can click it to enable.
- 2) Click the icon  to modify the SSID, VLAN ID, wireless security and other settings of the corresponding network.



1	TP-LINK_MULTI_2G_0	psk	💡	✎
<input checked="" type="checkbox"/> Enable Wireless Radio				
Network Name (SSID):	TP-LINK_MULTI_2G_0	<input type="checkbox"/> Hide SSID		
VLAN:	1			
Security:	WPA/WPA2 - Personal ▼			
Version:	<input type="radio"/> Auto <input type="radio"/> WPA-PSK <input checked="" type="radio"/> WPA2-PSK			
Encryption:	<input type="radio"/> Auto <input checked="" type="radio"/> AES <input type="radio"/> TKIP			
Password:	12345678			
Group Key Update Period:	0			
				<input type="button" value="Cancel"/> <input type="button" value="OK"/>

**Note:**

Tick [Hide SSID](#) if you want to hide this wireless network name.

3) Click [OK](#) to save the settings.

## 4.4. Check the connection status

After finishing the configuration, please go to [Advanced](#) > [Status](#) to check the connection status. Here we take Access Point mode as a demonstration. The status page of other modes are different. Click each element of the topology, its status will show below.

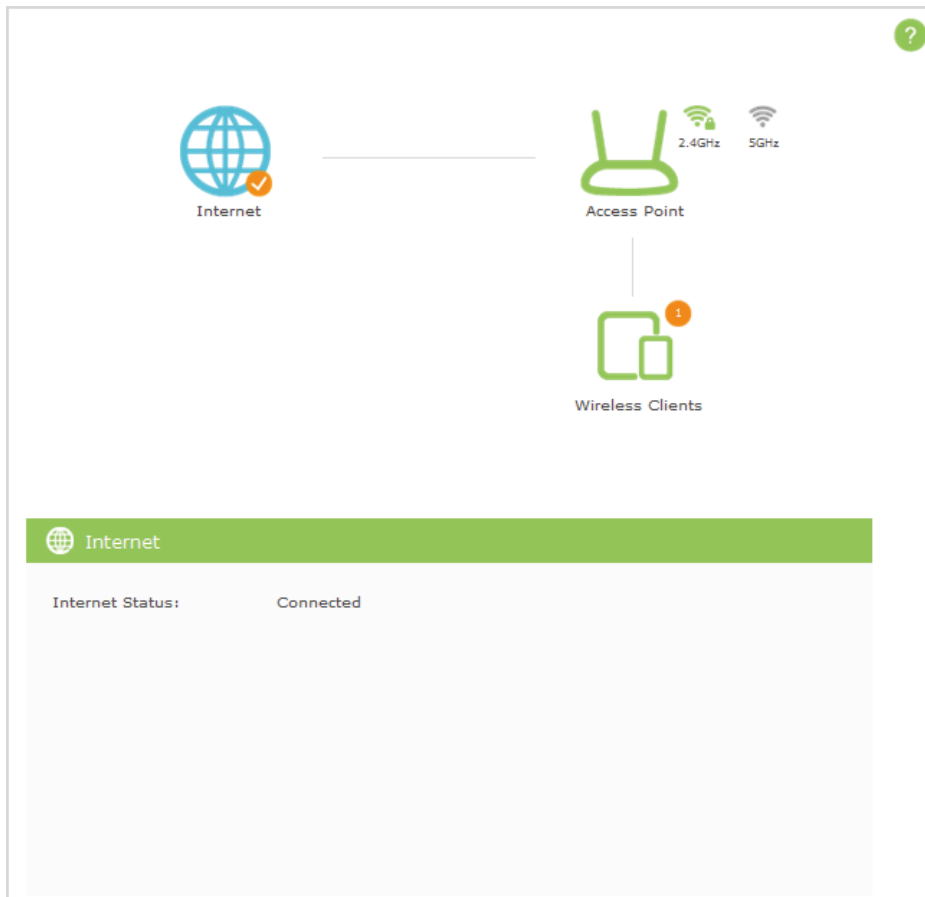

## Chapter 5

---

# Customize Your Network and Security Settings

---

This chapter guides you on how to configure advanced network and security settings that are available for this AP device.

This chapter contains the following sections:

- *Change the LAN Settings*
- *Specify DHCP Server Settings*
- *Access Control*
- *Advanced Wireless Settings*

## 5.1. Change the LAN Settings

The AP device is preset to [Obtain an IP address automatically](#), which allows the device to dynamically obtain an IP address and gateway from the main router/AP. You just need to enter <http://tplinkap.net> into the address bar to log into the web-based management page. It is recommended to keep the default LAN settings to avoid IP conflict with the main router/AP or other device on your local network. If it is necessary to change the LAN settings, for example, your network requires a specific IP subnet, please perform the following steps.

1. Visit <http://tplinkap.net>, and log in with the username and password you set for the AP device.
2. Go to [Settings](#) > [Network](#) > [LAN](#) page.



Network Settings

Obtain an IP address automatically

Use the following IP address

IP Address:

Subnet Mask:

Default Gateway:  (Optional)

Save

3. Select [Use the following IP address](#) option and type in a new IP Address appropriate to your needs.
4. Leave the [Subnet Mask](#) and [Default Gateway](#) as it is.
5. Click [Save](#).

■ **Note:**

After changing the IP address, you should enter the new IP address or use the domain name [tplinkap.net](http://tplinkap.net) to log into the web-based management page.

## 5.2. Specify DHCP Server Settings

By default, the DHCP (Dynamic Host Configuration Protocol) Server is set to [Auto](#). If the DHCP server of the host router/AP is disabled, the device's DHCP server will automatically assign valid IP addresses to clients. If the DHCP server of the host router/AP is enabled, the device's DHCP server will be unable to avoid IP conflict. You can switch [On](#) (enable) or [Off](#) (disable) the DHCP server. If [Off](#) is selected and there is no other DHCP server within your LAN, you have to configure the IP address for each client manually.

### ➤ DHCP Settings

1. Visit <http://tplinkap.net>, and log in with the username and password you set for the AP device.
2. Go to [Settings](#) > [Network](#) > [DHCP Settings](#).

DHCP Server Settings

DHCP Server:  Auto  On  Off

IP Address Pool: 192.168.0.100 - 192.168.0.199

Address Lease Time: 1 minutes. (1-2880. The default value is 1.)

Default Gateway: 192.168.0.254 (Optional)

Primary DNS: (Optional)

Secondary DNS: (Optional)

Save

3. Switch **On** the **DHCP server**.
4. Enter the starting and ending IP address in the **IP Address Pool**.
5. Enter other parameters if the ISP offers, the Default Gateway is automatically filled which is the same as the LAN IP address of the AP device.
6. Click **Save**.

### ➤ Check the DHCP Clients

1. Visit <http://tplinkap.net>, and log in with the username and password you set for the AP device.
2. Go to [Settings](#) > [Network](#) > [DHCP Client List](#) to check the DHCP Client List.

DHCP Client List

Total Clients: 0

ID	Client Name	MAC Address	Assigned IP Address	Leased Time
--	--	--	--	--

### ➤ To reserve an IP address for a specified client device:

1. Visit <http://tplinkap.net>, and log in with the username and password you set for the AP device.
2. Go to [Settings](#) > [Network](#) > [IP Address](#).
3. Click **Add**.

Address Reservation

+ Add - Delete

<input type="checkbox"/>	ID	MAC Address	Reserved IP Address	Description	Status	Modify
--	--	--	--	--	--	--

MAC Address:

IP Address:

Description:

Enable This Entry

Cancel OK

4. Enter the MAC address of the client device.
5. Enter the IP address to set to the client device.
6. Enter the Description of the client device.
7. Select the [Enable This Entry](#) checkbox.
8. Click [OK](#).

The IP address reservation is configured successfully, and you can see the rule shown as below.

Address Reservation

+ Add - Delete

<input type="checkbox"/>	ID	MAC Address	Reserved IP Address	Description	Status	Modify
<input type="checkbox"/>	1	BC-6C-21-07-5D-DE	192.168.0.140	1111	💡	✎ 🗑️

### 5.3. Access Control

Access Control is used to allow or block specific client devices from accessing your network. When a device is blocked, it is unable to connect to the Internet through your network or communicate with other devices in the LAN.

To use Access Control, enable this function and specify a blacklist or whitelist. If Access Control is disabled (Off), all devices, including the blacklisted ones, are allowed to access your network.

1. Visit <http://tplinkap.net>, and log in with the username and password you set for the AP device.

2. Go to [Settings](#) > [Wireless](#) > [Access Control](#) and toggle on the Access Control function.

**Access Control** ?

Access Control:  On

**Access Mode**

Default Access Mode:  Blacklist  Whitelist

[Save](#)

**Online Devices**

[Refresh](#) [Block](#)

<input type="checkbox"/>	ID	Device Name	IP Address	MAC Address	Connection Type	Modify
--	1	WORKGROUP	192.168.0.143	D4-3D-7E-BF-61-5F	Wired	<a href="#">ⓘ</a>

**Devices in Blacklist**

[+ Add](#) [- Delete](#)

<input type="checkbox"/>	ID	Device Name	MAC Address	Modify
--	--	--	--	--

3. Select the filtering rule: [Blacklist](#) or [Whitelist](#).

➤ **To add a device to a blacklist or whitelist**

1) Click [Add](#).

**Devices in Blacklist**

[+ Add](#) [- Delete](#)

<input type="checkbox"/>	ID	Device Name	MAC Address	Modify
--	--	--	--	--

Device Name:



MAC Address:



[Cancel](#) [OK](#)

2) Enter the [MAC address](#) of the device to choose the device that you want to add in the blacklist or whitelist from the [Access Devices List](#).

- 3) Enter the **Device Name** of the device.
- 4) Click **OK**.

➤ **To modify or delete a device from the Blacklist or Whitelist**

In the Blacklist or Whitelist, click the modify icon  or the delete  icon that corresponds to the device that you wish to modify or delete.

Devices in Blacklist					
				+ Add	- Delete
<input type="checkbox"/>	ID	Device Name	MAC Address	Modify	
<input type="checkbox"/>	1	a	74-D4-35-98-3F-DF		

➤ **To delete multiple devices from the Blacklist or Whitelist**

In the Blacklist or Whitelist, select the corresponding checkboxes of the devices to be deleted and click **Delete** above the table.

Devices in Blacklist					
				+ Add	- Delete
<input checked="" type="checkbox"/>	ID	Device Name	MAC Address	Modify	
<input checked="" type="checkbox"/>	1	a	74-D4-35-98-3F-DF		

## 5.4. Advanced Wireless Settings

It is recommended to keep the default settings of the advanced wireless settings. If it is necessary to change them, please perform the following steps.

1. Visit <http://tplinkwifi.net>, and log in with the username and password you set for the AP device.
2. Go to *Settings* > *Wireless* > *Advanced Settings*.



Advanced Settings
2.4GHz | 5GHz

---

Beacon Interval:	<input type="text" value="100"/>	(40-1000)
RTS Threshold:	<input type="text" value="2346"/>	(1-2346)
DTIM Interval:	<input type="text" value="1"/>	(1-15)
Group Key Update Period:	<input type="text" value="0"/>	seconds
WMM Feature:	<input checked="" type="checkbox"/> Enable WMM	
Short GI Feature:	<input checked="" type="checkbox"/> Enable Short GI	
AP Isolation Feature:	<input type="checkbox"/> Enable AP Isolation	

### 3. Choose the [2.4Ghz](#) or [5GHz](#) of the wireless network.

- **Beacon Interval** - Enter a time interval between 40 and 1000 in milliseconds to determine the duration between beacon packets that are transmitted periodically by the device to synchronize the wireless network. The default is 100 milliseconds.
- **RTS Threshold** - Enter a value between 1 and 2346 to determine the packet size of data transmitted through the network. By default, the RTS (Request to Send) Threshold size is 2346. If the packet size is greater than the preset threshold, the device sends Request to Send frames to a particular receiving station and negotiates the sending of a data frame, or else the packet will be sent immediately.
- **DTIM Interval** - This value determines the interval of the Delivery Traffic Indication Message (DTIM). You can specify the value between 1 and 15 Beacon Intervals. The default value is 1, which indicates the DTIM Period is the same as Beacon Interval.
- **Group Key Upgrade Period** - Enter the number of seconds (minimum 30) to control the time interval for the encryption key automatic renewal. The default is 0, indicating no key renewal.
- **WMM Feature** - This function guarantees the packets with high-priority messages being transmitted preferentially. It is enabled by default and highly recommended.
- **Short GI Feature**- This function is enabled by default and recommended to increase the data capacity by reducing the Guard Interval (GI) time.
- **AP Isolation Feature**- Select this checkbox to enable the AP Isolation feature that allows you to confine and restrict all wireless devices on your network from interacting with each other, but still able to access the Internet. AP isolation is disabled by default.

4. Click [Save](#).

## Chapter 6

---

# Manage Your AP Device

---

This chapter will show you how to configure and manage your AP device. This chapter includes the following sections:

- *System Log*
- *Test the Network Connectivity*
- *Upgrade the Firmware*
- *Backup and Restore Configuration Settings*
- *Change the Management Account*
- *Throughput Monitor*
- *Statistics*
- *SNMP Management*
- *Ping Watchdog*
- *LEDs Control*
- *Mode Switch*

## 6.1. System Log

The System Log page displays a list of the most recent activities (events) of the network. You can define the type of logs and/or the level of logs you want to view. You can also export the log files to a computer. When the AP device does not work properly, you can save the system log and send it to the technical support for troubleshooting.

### ➤ To Save the System Log in Local:

1. Visit <http://tplinkap.net>, and log in with the username and password you set for the AP device.
2. Go to [Settings](#) > [System Tools](#) > [System Log](#).

System Log

Log Filter: Type= Others And Level = ALL

Refresh Delete All

ID	Time	Type	Level	Log Content
1	1st day 00:00:05	OTHER	WARNING	LAN IP and mask were changed to 192.168.0.123 255.255.255.0
2	1st day 00:00:05	OTHER	INFO	System started

Save Log

3. Choose the type and level of the system log according to your need.

4. Click [Save Log](#) to save the system log to local.

#### ☞ Tips:

You can use the email to send the saved system log to the technical support for troubleshooting.

Click [Refresh](#) to renew the system log list or click [Delete all](#) to delete all the system logs.

## 6.2. Test the Network Connectivity

Diagnostics is used to test the connectivity between the AP device and the host or other network devices.

The device provides Ping and Traceroute tools to help you troubleshoot network connectivity problems. The Ping tool sends packets to a target IP address and logs the results, such as the number of packets sent/received, and the round-trip time. The Traceroute tool sends packets to a target IP address and displays the number of hops and time to reach the destination. You can ping and traceroute a local device by its IP address.

1. Visit <http://tplinkwifi.net>, and log in with the username and password you set for the AP device.
2. Go to [Settings](#) > [System Tools](#) > [Diagnostics](#).

The screenshot shows the 'Diagnostics' page in a web interface. At the top right is a green question mark icon. Below the title 'Diagnostics', there are two radio buttons: 'Ping' (selected) and 'Traceroute'. A text input field for 'IP Address/Domain Name:' is empty. Below this is an 'Advanced' section with an upward-pointing arrow icon. Inside the 'Advanced' section, there are three input fields: 'Ping Count' with the value '4' and a range '(1-50)', 'Ping Packet Size' with the value '64' and a range '(4-1472 Bytes)', and 'Ping Timeout' with the value '800' and a range '(100-2000 Milliseconds)'. A blue 'Start' button is located below these fields. At the bottom of the form, a dashed box contains the text 'The Router is ready.'

➤ **To diagnose using Ping**

- 1) Choose **Ping** as the diagnostic tool to test the connectivity.
- 2) Enter the target **IP Address/Domain Name** of the tested host.
- 3) Click **Advanced** and specify the **Ping Count**, **Ping Packet Size** and **Ping Timeout**. (Optional)
- 4) Click **Start**.

The figure below indicates the proper connection between the device and the IP address 192.168.0.123 tested through **Ping**.

```
Ping 192.168.0.123 with 64 bytes of data:
Reply from 192.168.0.123 bytes=64 time=1ms TTL=64 seq=1
Reply from 192.168.0.123 bytes=64 time=1ms TTL=64 seq=2
Reply from 192.168.0.123 bytes=64 time=1ms TTL=64 seq=3
Reply from 192.168.0.123 bytes=64 time=1ms TTL=64 seq=4
Ping statistics for 192.168.0.123
    Packets: Sent = 4 Received = 4 Lost = 0
    Approximate round trip times in milliseconds:
        Minimum = 1 Maximum = 1 Average = 1
```

➤ **To diagnose using Traceroute**

- 1) Choose **Traceroute** as the diagnostic tool to test the connectivity.

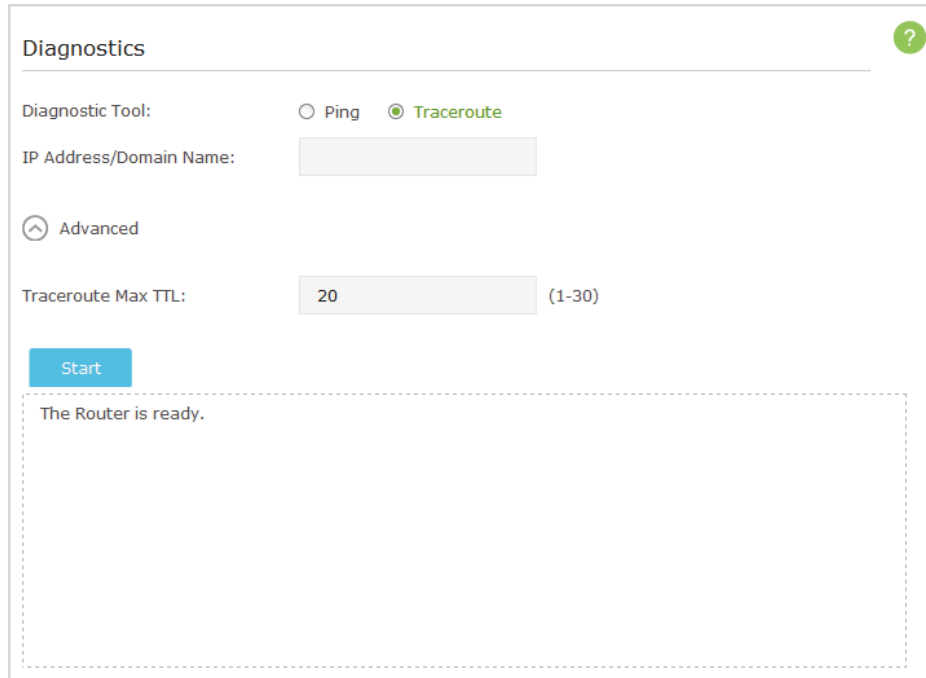

The screenshot shows a web interface titled "Diagnostics" with a help icon in the top right. Under "Diagnostic Tool:", the "Traceroute" radio button is selected. Below it is a text input field for "IP Address/Domain Name:". An "Advanced" section is collapsed. Under "Traceroute Max TTL:", the value "20" is entered in a text box, with "(1-30)" to its right. A blue "Start" button is visible. Below the button, a dashed box contains the text "The Router is ready."

- 2) Enter the target **IP Address/Domain Name** of the tested host.
- 3) Click **Advanced** and specify the number of hops (to be reached) in the **Traceroute Max TTL** (Time to Live) field. The default is 20. (Optional)
- 4) Click **Start**.

The figure below indicates the proper connection between the AP device and the IP address 192.168.0.123 tested through **Traceroute**.

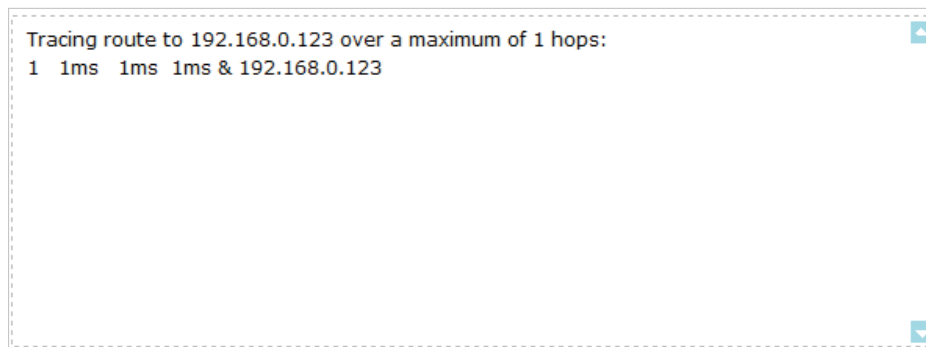

The screenshot shows a dashed box containing the text: "Tracing route to 192.168.0.123 over a maximum of 1 hops:" followed by "1 1ms 1ms 1ms & 192.168.0.123". There are small up and down arrow icons in the top right and bottom right corners of the dashed box.

## 6.3. Upgrade the Firmware

TP-LINK is dedicated to improving and enriching the product features, giving you a better network experience.

We will release the latest firmware at TP-LINK official website, you can download the latest firmware file from the [Support](#) page of our website [www.tp-link.com](http://www.tp-link.com) and upgrade the firmware to the latest version. If you have connected to the Internet, you can click [Check for upgrade](#) or check if there are the upgrading tips on the top of the page.

**Note:**

1. Make sure the latest firmware file matches with the hardware version (as shown in the webpage).
2. Make sure that you have a stable connection between the AP device and your computer. It is NOT recommended to upgrade the firmware wirelessly.
3. Back up your AP device configuration.
4. Do NOT turn off the AP device during the firmware upgrade.

### 6.3.1. Local Upgrade

Follow the steps to upgrade the firmware.

1. Download the latest firmware file for the AP device from our website [www.tp-link.com](http://www.tp-link.com).
2. Visit <http://tplinkap.net>, and log in with the username and password you set for the AP device.
3. Go to [Settings](#) > [System Tools](#) > [Firmware Upgrade](#).

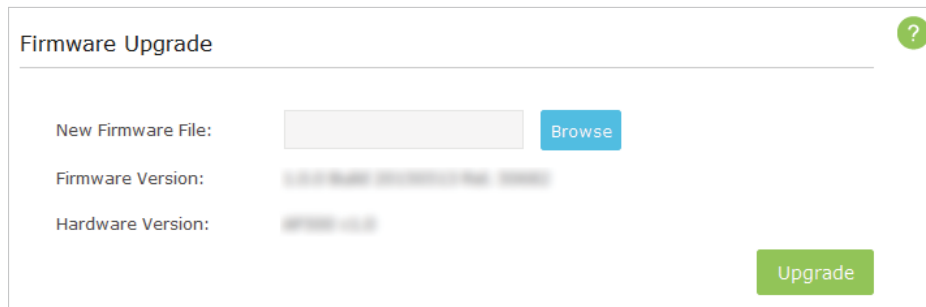

4. Click [Browse](#) to locate the downloaded new firmware file, and click [Upgrade](#).
5. Wait a few moments for the upgrading and rebooting.

### 6.3.2. Online Upgrade

1. Visit <http://tplinkap.net>, and log in with the username and password you set for the AP device.
2. If there's any firmware update available for your router, the update icon  will display in the top-right corner of the page. Click the icon to go to the [Firmware Upgrade](#) page.

Alternatively, you can go to [Settings](#) > [System Tools](#) > [Firmware Upgrade](#), and click [Check for upgrade](#) to see if there's any new firmware.



3. Focus on the [Online Upgrade](#) section, and click [Upgrade](#).
4. Wait a few moments for the upgrading and rebooting.

## 6.4. Backup and Restore Configuration Settings

The configuration settings are stored as a configuration file in the AP device. You can backup the configuration file to your computer for future use and restore the AP device to a previous settings from the backup file when needed. Moreover, if necessary you can erase the current settings and reset the AP device to the default factory settings.

1. Visit <http://tplinkap.net>, and log in with the username and password you set for the AP device.
2. Go to [Settings](#) > [System Tools](#) > [Backup & Restore](#).

### ➤ To backup configuration settings:

It is highly recommended to back up your current configurations in case a recovery is needed to restore the system to a previous state or from the factory defaults.

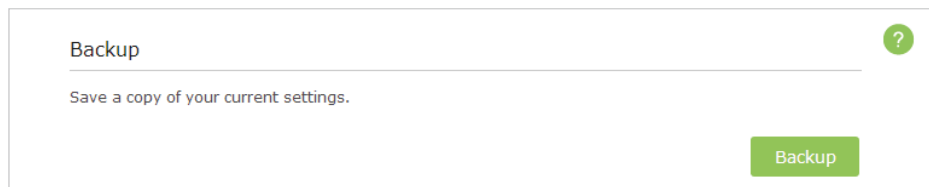

Click [Backup](#) to save a copy of the current settings to your local computer. A '.bin' file of the current settings will be stored to your computer. Make sure to save the backup file to a safe location that you can retrieve and restore the device later, if needed.

### ➤ To restore configuration settings:

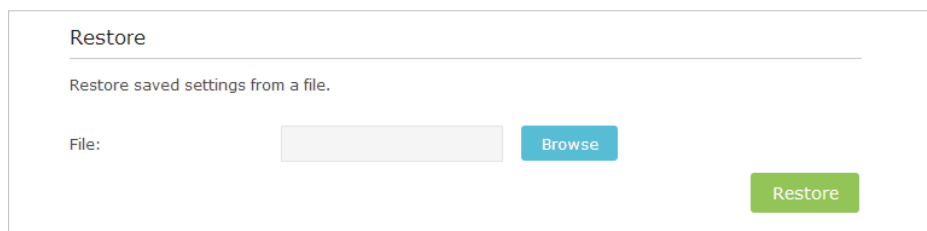



- 1) Click [Browse](#) to locate the backup configuration file stored on your computer, and click [Restore](#).
- 2) Wait a few moments for the restoring and rebooting.

📌 **Note:** During the restoring process, do not turn off or reset the AP device.

➤ **To reset the AP device to factory default settings:**



Factory Default Restore

Revert all the configuration settings to their default values.

Factory Restore

- 1) Click [Factory Restore](#) to reset the router.
- 2) Wait a few moments for the reset and reboot.

📌 **Note:**

1. During the resetting process, do not turn off the AP device.
2. We strongly recommend you back up the current configuration settings before resetting the AP device.

## 6.5. Change the Management Account

The account management feature allows you to change your login username and password of the web-based management page.

1. Visit <http://tplinkap.net>, and log in with the username and password you set for the AP device before.
2. Go to [Settings](#) > [System Tools](#) > [Account Management](#) and complete the settings in [Account Management](#) section.

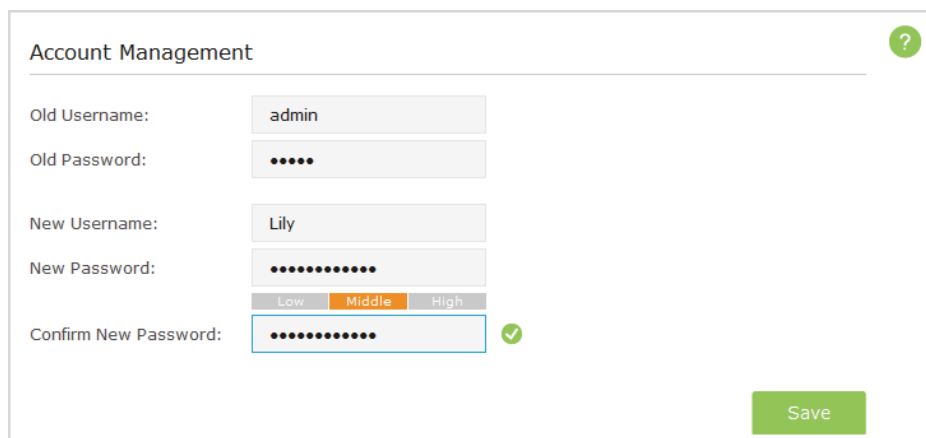

Account Management

Old Username: admin

Old Password: .....

New Username: Lily

New Password: .....

Low Middle High

Confirm New Password: ..... ✓

Save

3. Enter the old username and password.
4. Enter the new username and the new password twice (both case-sensitive). Click [Save](#).

Use the new username and password for subsequent logins.

📌 **Tips:** Please write down the new login information in a secure place in case you forget it.

## 6.6. Throughput Monitor

The throughput chart displays the current data traffic of the network. The curves in different colors represent the received (RX) and transmitted (TX) rates of the 2.4GHz and 5GHz frequencies respectively. You can choose to view individual or multiple data rates by selecting the corresponding checkbox.

1. Visit <http://tplinkap.net>, and log in with the username and password you set for the AP device.
2. Go to *Settings* > *Wireless* > *Throughput Monitor*.

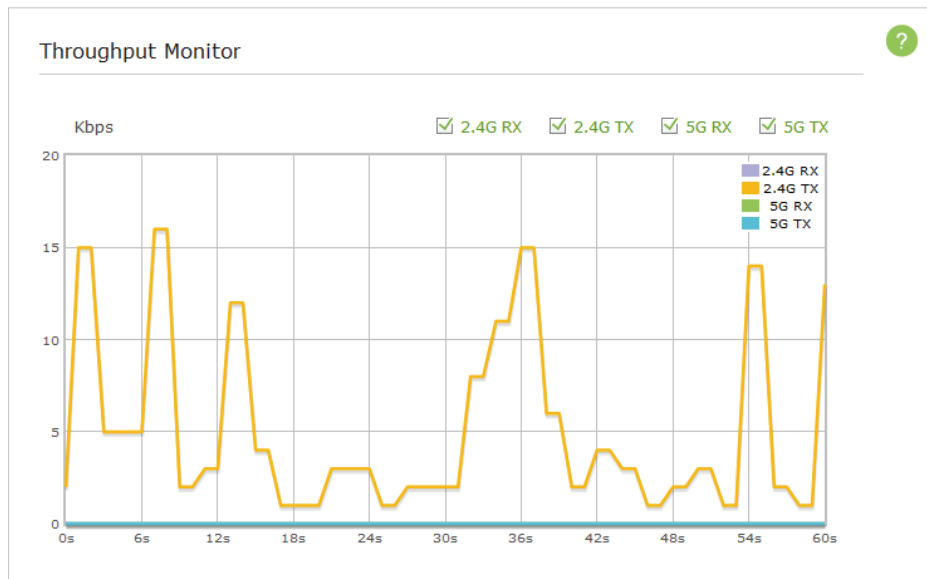

3. Select the corresponding checkbox (2.4G RX, 2.4G TX, 5G RX and 5G TX) to view individual or multiple data rates.

## 6.7. Statistics

The Statistics page displays the network traffic of wireless stations sent and received, and allows you to monitor the volume of wireless traffic statistics.

1. Visit <http://tplinkap.net>, and log in with the username and password you set for the AP device.
2. Go to *Settings* > *Wireless* > *Statistics*.



Wireless Stations Online ?

Total Clients: 1 Refresh

ID	MAC Address	Connection Type	Security	Received Packets	Sent Packets
1	DC-9B-9C-D3-17-61	2GHz	WPA2-PSK	29	189

3. Monitor the traffic statistics in [Wireless Stations Online](#) section.

## 6.8. SNMP Management

SNMP (Simple Network Management Protocol) is a popular network monitoring and management protocol.

1. Visit <http://tplinkap.net>, and log in with the username and password you set for the AP device.
2. Go to [Settings](#) > [System Tools](#) > [SNMP](#) and complete the settings according to your needs.

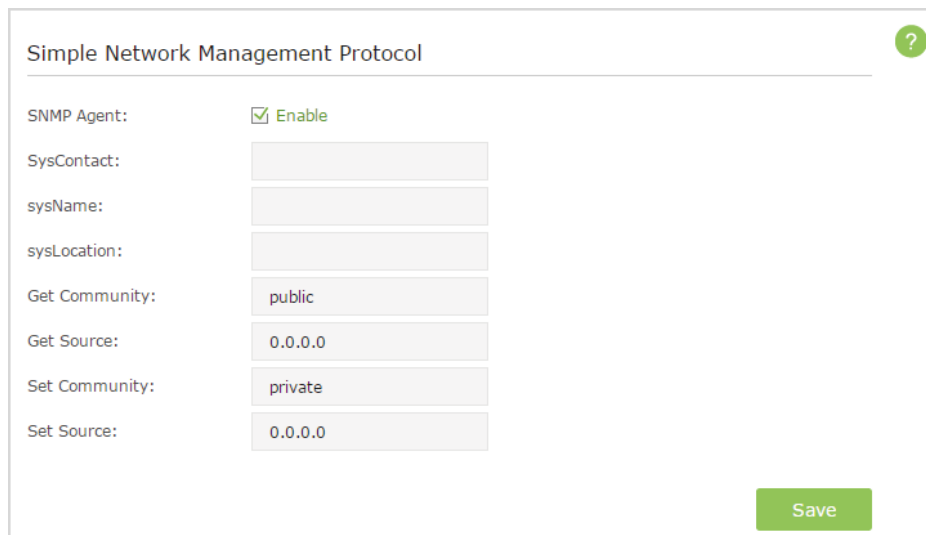

Simple Network Management Protocol ?

SNMP Agent:  Enable

SysContact:

sysName:

sysLocation:

Get Community:

Get Source:

Set Community:

Set Source:

3. Select the [SNMP Agent](#) checkbox to enable (or deselect to disable) the SNMP feature.
4. Enter the contact email address in [SysContact](#) field, a user-defined name in [SysName](#) field and the physical location in [SysLocation](#) of the node to be managed.
5. Enter the community name in [Get Community](#) field that allows read-only access to the device's SNMP information. The community name is considered as a group password. The default setting is [public](#).
6. Enter the IP address or subnet in [Get Source](#) field that management systems can read information from this 'get' community.

7. Enter the community name in **Set Community** field that allows read/write access to the device's SNMP information. The community name can be considered as a group password. The default setting is private.
8. Enter the IP address or subnet in **Set Source** field that management systems can read and write to this 'set' community.
9. Click **Save**.

**Note:**

A restricted source can be a specific IP address (e.g. 10.10.10.1), or a subnet - represented as IP/BITS (e.g. 10.10.10.0/24). If 0.0.0.0 is specified as the IP address, the agent will accept all requests under the corresponding community name.

## 6.9. Ping Watchdog

The Ping Watchdog feature allows you to continuously ping a specific remote host for connection status using a user-defined IP address (or an Internet gateway). If it is unable to ping the target IP address under the user-defined constraints, this device will automatically reboot.

1. Visit <http://tplinkap.net>, and log in with the username and password you set for the AP device.
2. Go to **Settings > System Tools > Ping Watchdog** and complete the settings according to your needs.



Field	Value	Range
Ping Watchdog	<input checked="" type="checkbox"/> Enable	
IP Address To Ping	192.168.0.1	
Ping Interval	300	(10-300)seconds
Startup Delay	300	(60-300)seconds
Fail Count To Reboot	3	(1-65535)

3. Select the **Ping Watchdog** checkbox to enable the function.
4. Enter the IP address of the target host in **IP Address To Ping** field that you want to send ping packets to.
5. Enter the time interval (in seconds) between two continuous ping packets in **Ping Interval** field.
6. Enter the time delay (in seconds) before the first ping packet is sent out when the device is restarted in **Startup Delay** field.
7. Enter a number of ping count(s) that the device can send continuously in **Fail Count To Reboot** field. If the value is exceeded, the device will restart automatically.

8. Click [Save](#).

## 6. 10. LEDs Control

The LEDs indicate AP device's activities and behavior. You can turn on or turn off the AP device's LEDs from the web-based management page.

1. Visit <http://tplinkap.net>, and log in with the username and password you set for the AP device.
2. Click the [LED On](#) or [LED Off](#) icon on the top right corner of the page. The icon  displays that the LEDs is on and you can click it to turn off the LEDs. The icon  displays that the LEDs is off and you can click it to turn on the LEDs.

## 6. 11. Mode Switch

The AP device has four operation modes. And you can change the mode of AP device by using the mode switch icon on the web-based management page.

1. Visit <http://tplinkap.net>, and log in with the username and password you set for the AP device.
2. Click the [Mode](#) icon  on the top right corner of the page. And then follow the step-by-step on-screen instructions to complete the configuration.

# FAQ

## Q1. What can I do if I forgot my wireless password?

The default password is labeled at the back of the AP device. If the password has been altered, please connect the AP device to the computer using a cable and follow the steps below:

1. Visit <http://tplinkap.net>, and log in with the username and password you set for the AP device.
2. Go to [Settings](#) > [Wireless](#) > [Wireless settings](#). Locate the password on the page and mark it down for future use.

## Q2. How to retrieve the username and password of the web management page?

The default username and password of the web management page are [admin](#) (in lower case). If the password has been altered, please follow the steps below:

1. Reset the router to factory default settings: with the device powered on, use a pin to press and hold the Reset button for five seconds until the Power LED starts blinking, then release the button;
2. Visit <http://tplinkap.net>;
3. Enter [admin](#) (in lower case) as both username and password to log in.

**Note:** You'll need to reconfigure the AP device. Please mark down your new password for future use.

## Q3. I cannot log into the AP device's web management page, what can I do?

This can happen for a variety of reasons, please try the methods below and try again.

1. Make sure the AP device connects to the computer correctly and the corresponding LED indicator(s) light up.
2. Make sure the IP address of your computer is configured as [Obtain an IP address automatically](#) and [Obtain DNS server address automatically](#).
3. Make sure the <http://tplinkap.net> you input is right.
4. Check your computer's settings:
  - 1) Go to [Start](#) > [Control Panel](#) > [Network and Internet](#), and click [View network status and tasks](#);
  - 2) Click [Internet Options](#) on the bottom left;
  - 3) Click [Connections](#), select [Never dial a connection](#);

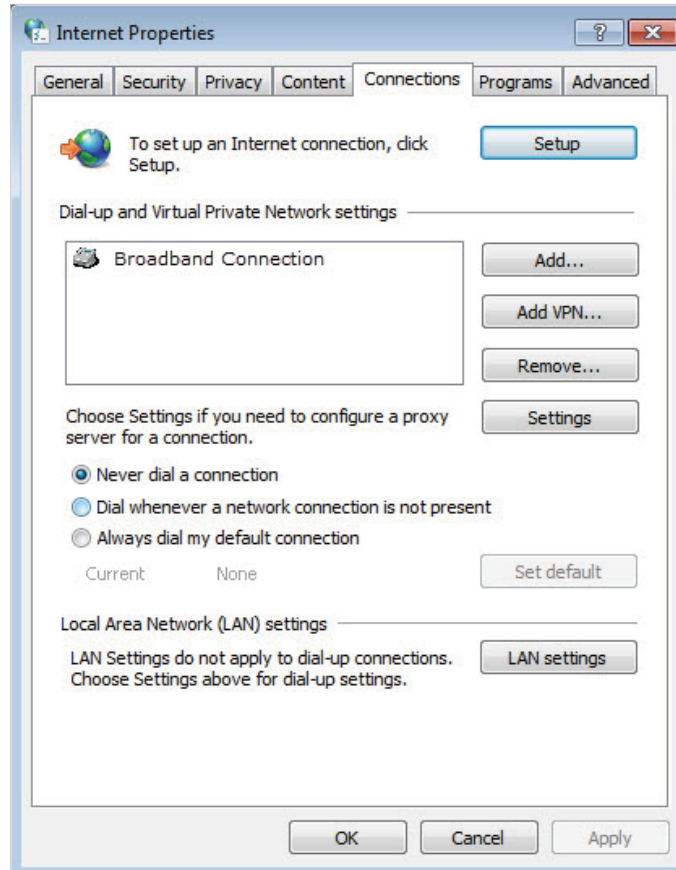

4) Click [LAN settings](#), deselect the following three options and click [OK](#);

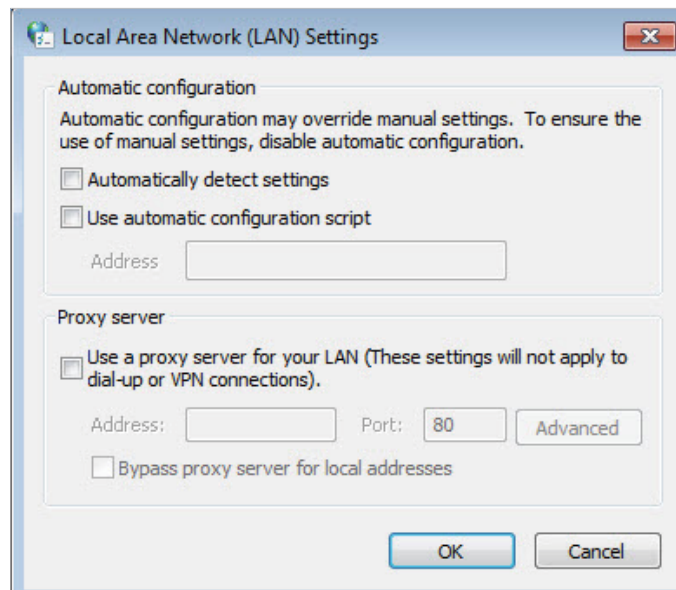

5) Go to [Advanced](#) > [Restore advanced settings](#), click [OK](#) to save the settings.

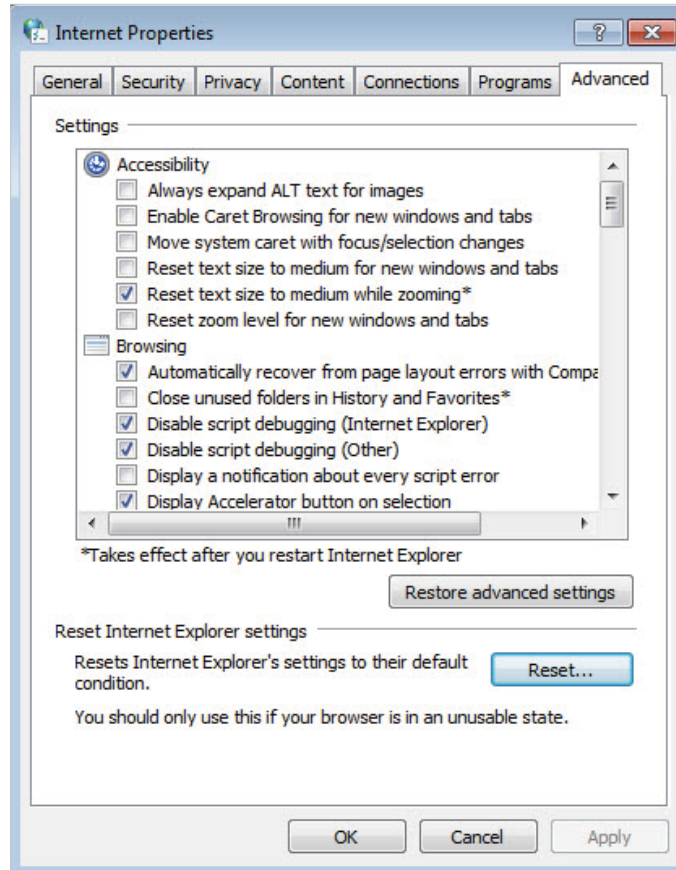

5. Change a web browser or computer and log in again.

6. Reset the AP device to factory default settings: use a pin to press and hold the Reset button for five seconds until the Power LED starts blinking, then release the button.

**Note:** Upon resetting, all previous configurations will be cleared, and the AP device will reset to the default AP Mode.

Open a web browser and log in again. If login still fails, please contact the technical support.

#### **Q4. What can I do if the login window does not appear?**

You can try the following methods to solve the problem:

- Change the computer's static IP address to obtain an IP address automatically.
- Verify if <http://tplinkap.net> or <http://192.168.0.254> is correctly entered in the web browser.
- Use another web browser and try again.
- Reboot your AP device and try again.
- Power off your host AP and enter <http://tplinkap.net> into the web browser to try again.



## Q5. What can I do if my wireless is not stable?

It may be caused by too much interference, you can try the following methods:

- Set your wireless channel to a different channel.
- Move the AP device to a new location away from Bluetooth devices and other household electronics, such as cordless phone, microwave, and baby monitor, etc., to minimize signal interference.

## Q6. What can I do to maximize my signal strength in Repeater/Bridge mode?

When choosing an ideal location to optimize wireless signal in Repeater/ Bridge mode, please use the following tips.

- **The Best Way is Halfway**

Generally, the ideal location for the repeater is halfway between your wireless router and your wireless clients. If that is not possible, place it closer to your wireless router to ensure stable performance.

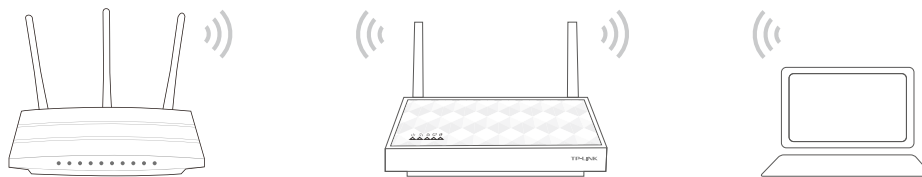

- **Less Obstacles Ensure Better Performance**

Choose a location with less obstacles that may block the signal between the AP device and the host network. An open corridor or a spacious location is ideal.

- **Less Interference Provides More Stability**

Choose a location away from Bluetooth devices and other household electronics, such as cordless phone, microwave, and baby monitor, etc., to minimize signal interference.

# Specifications

Hardware	
Ethernet Ports	1 10/100/1000Mbps LAN port
Button	Reset Button, WPS Button, LED On/Off Button, Power On/Off Button
External Power Supply	12V/1A
Antenna	Two Dual Band Detachable Antennas, supporting passive PoE
Wireless	
Wireless Standards	IEEE 802.11ac/n/a 5GHz, IEEE 802.11b/g/n 2.4GHz
Frequency	2.4GHz, 5GHz
Signal Rate	433Mbps at 5GHz, 300Mbps at 2.4GHz
Transmit Power	CE: <20dBm(2.4GHz), <23dBm(5GHz) FCC: <30dBm
Wireless Function	Enable/Disable Wireless Radio, WMM, Wireless Statistics
Wireless Security	64/128-bit WEP, WPA/WPA2, WPA-PSK/WPA-PSK2 encryptions
Software	
DHCP	Server, Client, DHCP Client List, Address Reservation
Quality of Service	WMM
Firewall Security	MAC Filtering
Protocols	Supports IPv4
Management	Account Management, SNMP
Environment	
Operating Temperature	0°C~40°C (32°F ~104°F)
Storage Temperature	-40°C~70°C (-40°F ~158°F)
Operating Humidity	10%~90% non-condensing
Storage Humidity	5%~90% non-condensing

## **COPYRIGHT & TRADEMARKS**

Specifications are subject to change without notice. **TP-LINK** is a registered trademark of TP-LINK TECHNOLOGIES CO., LTD. Other brands and product names are trademarks or registered trademarks of their respective holders.

No part of the specifications may be reproduced in any form or by any means or used to make any derivative such as translation, transformation, or adaptation without permission from TP-LINK TECHNOLOGIES CO., LTD. Copyright © 2016 TP-LINK TECHNOLOGIES CO., LTD. All rights reserved.

## FCC STATEMENT



This equipment has been tested and found to comply with the limits for a Class B digital device, pursuant to part 15 of the FCC Rules. These limits are designed to provide reasonable protection against harmful interference in a residential installation. This equipment generates, uses and can radiate radio frequency energy and, if not installed and used in accordance with the instructions, may cause harmful interference to radio communications. However, there is no guarantee that interference will not occur in a particular installation. If this equipment does cause harmful interference to radio or television reception, which can be determined by turning the equipment off and on, the user is encouraged to try to correct the interference by one or more of the following measures:

- Reorient or relocate the receiving antenna.
- Increase the separation between the equipment and receiver.
- Connect the equipment into an outlet on a circuit different from that to which the receiver is connected.
- Consult the dealer or an experienced radio/TV technician for help.

This device complies with part 15 of the FCC Rules. Operation is subject to the following two conditions:

- 1) This device may not cause harmful interference.
- 2) This device must accept any interference received, including interference that may cause undesired operation.

Any changes or modifications not expressly approved by the party responsible for compliance could void the user's authority to operate the equipment.

Note: The manufacturer is not responsible for any radio or TV interference caused by unauthorized modifications to this equipment. Such modifications could void the user's authority to operate the equipment.

### **FCC RF Radiation Exposure Statement**

This equipment complies with FCC RF radiation exposure limits set forth for an uncontrolled environment. This device and its antenna must not be co-located or operating in conjunction with any other antenna or transmitter.

"To comply with FCC RF exposure compliance requirements, this grant is applicable to only Mobile Configurations. The antennas used for this transmitter must be installed to provide a separation distance of at least 20 cm from all persons and must not be co-located or operating in conjunction with any other antenna or transmitter."

This device is restricted in indoor environment only.

## CE Mark Warning



This is a class B product. In a domestic environment, this product may cause radio interference, in which case the user may be required to take adequate measures.

## RF Exposure Information

This device meets the EU requirements (1999/5/EC Article 3.1a) on the limitation of exposure of the general public to electromagnetic fields by way of health protection. The device complies with RF specifications when the device used at 20 cm from your body.

Restricted to indoor use.

## Canadian Compliance Statement

This device complies with Industry Canada license-exempt RSSs. Operation is subject to the following two conditions:

1. This device may not cause interference, and
2. This device must accept any interference, including interference that may cause undesired operation of the device.

Le présent appareil est conforme aux CNR d'Industrie Canada applicables aux appareils radio exempts de licence. L'exploitation est autorisée aux deux conditions suivantes:

1. l'appareil ne doit pas produire de brouillage;
2. l'utilisateur de l'appareil doit accepter tout brouillage radioélectrique subi, même si le brouillage est susceptible d'en compromettre le fonctionnement.

This radio transmitter (IC: 8853A-AP200/ Model: AP200) has been approved by Industry Canada to operate with the antenna types listed below with the maximum permissible gain indicated. Antenna types not included in this list (Specifications), having a gain greater than the maximum gain indicated for that type, are strictly prohibited for use with this device.

Le présent émetteur radio (IC: 8853A-AP200/ Model: AP200) a été approuvé par Industrie Canada pour fonctionner avec les types d'antenne énumérés ci-dessous et ayant un gain admissible maximal. Les types d'antenne non inclus dans cette liste (Specifications), et dont le gain est supérieur au gain maximal indiqué, sont strictement interdits pour l'exploitation de l'émetteur.

No.	Model	Ant. Type	Ant. Connector	Gain (dBi)	Remark
1	3101500598	Dipole	RP-SMA-F	1.52	2.4G
2				2.13	5G

**Caution:**

- 1) The device for operation in the band 5150–5250 MHz is only for indoor use to reduce the potential for harmful interference to co-channel mobile satellite systems;
- 2) For devices with detachable antenna(s), the maximum antenna gain permitted for devices in the band 5725-5850 MHz shall be such that the equipment still complies with the e.i.r.p. limits specified for point-to-point and non-point-to-point operation as appropriate.

**Avertissement:**

- 1) Le dispositif fonctionnant dans la bande 5150-5250 MHz est réservé uniquement pour une utilisation à l'intérieur afin de réduire les risques de brouillage préjudiciable aux systèmes de satellites mobiles utilisant les mêmes canaux;
- 2) Le gain maximal d'antenne permis pour les dispositifs avec antenne(s) amovible(s) utilisant la bande 5725-5850 MHz doit se conformer à la limitation P.I.R.E spécifiée pour l'exploitation point à point et non point à point, selon le cas.

**Radiation Exposure Statement:**

This equipment complies with IC radiation exposure limits set forth for an uncontrolled environment. This equipment should be installed and operated with minimum distance 20cm between the radiator & your body.

**Déclaration d'exposition aux radiations:**

Cet équipement est conforme aux limites d'exposition aux rayonnements IC établies pour un environnement non contrôlé. Cet équipement doit être installé et utilisé avec un minimum de 20 cm de distance entre la source de rayonnement et votre corps.

**Industry Canada Statement**

CAN ICES-3 (B)/NMB-3(B)

**Korea Warning Statements**

당해 무선설비는 운용중 전파혼신 가능성이 있음.

**NCC Notice**

注意!

依據 低功率電波輻射性電機管理辦法

第十二條 經型式認證合格之低功率射頻電機，非經許可，公司、商號或使用者均不得擅自變更頻率、加大功率或變更原設計之特性或功能。

第十四條 低功率射頻電機之使用不得影響飛航安全及干擾合法通行；經發現有干擾現象時，應立即停用，並改善至無干擾時方得繼續使用。前項合法通信，指依電信規定作業之無線電信。低功率射頻電機需忍受合法通信或工業、科學以及醫療用電波輻射性電機設備之干擾。

減少電磁波影響，請妥適使用。

## BSMI Notice

### 安全諮詢及注意事項

- 請使用原裝電源供應器或只能按照本產品注明的電源類型使用本產品。
- 清潔本產品之前請先拔掉電源線。請勿使用液體、噴霧清潔劑或濕布進行清潔。
- 注意防潮，請勿將水或其他液體潑灑到本產品上。
- 插槽與開口供通風使用，以確保本產品的操作可靠並防止過熱，請勿堵塞或覆蓋開口。
- 請勿將本產品置放於靠近熱源的地方。除非有正常的通風，否則不可放在密閉位置中。
- 請不要私自打開機殼，不要嘗試自行維修本產品，請由授權的專業人士進行此項工作。



Продукт сертифіковано згідно с правилами системи УкрСЕПРО на відповідність вимогам нормативних документів та вимогам, що передбачені чинними законодавчими актами України.



## Safety Information



- When product has power button, the power button is one of the way to shut off the product; when there is no power button, the only way to completely shut off power is to disconnect the product or the power adapter from the power source.
- Don't disassemble the product, or make repairs yourself. You run the risk of electric shock and voiding the limited warranty. If you need service, please contact us.
- Avoid water and wet locations.

- Adapter shall be installed near the equipment and shall be easily accessible.
- The plug considered as disconnect device of adapter.
-  Use only power supplies which are provided by manufacturer and in the original packing of this product. If you have any questions, please don't hesitate to contact us.

For EU/EFTA, this product can be used in the following countries:

AT	BE	BG	CH	CY	CZ	DE	DK
EE	ES	FI	FR	GB	GR	HR	HU
IE	IS	IT	LI	LT	LU	LV	MT
NL	NO	PL	PT	RO	SE	SI	SK

## Explanation of the symbols on the product label

Symbol	Explanation
	DC voltage
	<p><b>RECYCLING</b></p> <p>This product bears the selective sorting symbol for Waste electrical and electronic equipment (WEEE). This means that this product must be handled pursuant to European directive 2012/19/EU in order to be recycled or dismantled to minimize its impact on the environment.</p> <p>User has the choice to give his product to a competent recycling organization or to the retailer when he buys a new electrical or electronic equipment.</p>