

# TP-LINK®

## User Guide

**TD-W8950N**

**150Mbps Wireless N ADSL2+ Modem Router**



## **COPYRIGHT & TRADEMARKS**

Specifications are subject to change without notice. **TP-LINK**<sup>®</sup> is a registered trademark of TP-LINK TECHNOLOGIES CO., LTD. Other brands and product names are trademarks or registered trademarks of their respective holders.

No part of the specifications may be reproduced in any form or by any means or used to make any derivative such as translation, transformation, or adaptation without permission from TP-LINK TECHNOLOGIES CO., LTD. Copyright © 2016 TP-LINK TECHNOLOGIES CO., LTD. All rights reserved.

<http://www.tp-link.com>

## FCC STATEMENT



This equipment has been tested and found to comply with the limits for a Class B digital device, pursuant to part 15 of the FCC Rules. These limits are designed to provide reasonable protection against harmful interference in a residential installation. This equipment generates, uses and can radiate radio frequency energy and, if not installed and used in accordance with the instructions, may cause harmful interference to radio communications. However, there is no guarantee that interference will not occur in a particular installation. If this equipment does cause harmful interference to radio or television reception, which can be determined by turning the equipment off and on, the user is encouraged to try to correct the interference by one or more of the following measures:

- Reorient or relocate the receiving antenna.
- Increase the separation between the equipment and receiver.
- Connect the equipment into an outlet on a circuit different from that to which the receiver is connected.
- Consult the dealer or an experienced radio/ TV technician for help.

This device complies with part 15 of the FCC Rules. Operation is subject to the following two conditions:

- 1) This device may not cause harmful interference.
- 2) This device must accept any interference received, including interference that may cause undesired operation.

Any changes or modifications not expressly approved by the party responsible for compliance could void the user's authority to operate the equipment.

Note: The manufacturer is not responsible for any radio or TV interference caused by unauthorized modifications to this equipment. Such modifications could void the user's authority to operate the equipment.

### **FCC RF Radiation Exposure Statement:**

This equipment complies with FCC RF radiation exposure limits set forth for an uncontrolled environment. This device and its antenna must not be co-located or operating in conjunction with any other antenna or transmitter.

"To comply with FCC RF exposure compliance requirements, this grant is applicable to only Mobile Configurations. The antennas used for this transmitter must be installed to provide a separation distance of at least 20 cm from all persons and must not be co-located or operating in conjunction with any other antenna or transmitter."

### **CE Mark Warning**



This is a class B product. In a domestic environment, this product may cause radio interference, in which case the user may be required to take adequate measures.

## RF Exposure Information

This device meets the EU requirements (1999/5/EC Article 3.1a) on the limitation of exposure of the general public to electromagnetic fields by way of health protection.

## Canadian Compliance Statement

This device complies with Industry Canada license-exempt RSSs. Operation is subject to the following two conditions:

- (1) This device may not cause interference, and
- (2) This device must accept any interference, including interference that may cause undesired operation of the device.

Le présent appareil est conforme aux CNR d'Industrie Canada applicables aux appareils radio exempts de licence. L'exploitation est autorisée aux deux conditions suivantes :

- (1) l'appareil ne doit pas produire de brouillage;
- (2) l'utilisateur de l'appareil doit accepter tout brouillage radioélectrique subi, même si le brouillage est susceptible d'en compromettre le fonctionnement.

## Radiation Exposure Statement:

This equipment complies with IC radiation exposure limits set forth for an uncontrolled environment. This equipment should be installed and operated with minimum distance 20cm between the radiator & your body.

## Déclaration d'exposition aux radiations:

Cet équipement est conforme aux limites d'exposition aux rayonnements IC établies pour un environnement non contrôlé. Cet équipement doit être installé et utilisé avec un minimum de 20 cm de distance entre la source de rayonnement et votre corps.

## Industry Canada Statement

CAN ICES-3 (B)/NMB-3(B)

## Korea Warning Statements

당해 무선설비는 운용중 전파혼신 가능성이 있음.

## NCC Notice

注意!

依據 低功率電波輻射性電機管理辦法

第十二條 經型式認證合格之低功率射頻電機，非經許可，公司、商號或使用者均不得擅自變更頻率、加大功率或變更原設計之特性或功能。

第十四條 低功率射頻電機之使用不得影響飛航安全及干擾合法通行；經發現有干擾現象時，應立即停用，並改善至無干擾時方得繼續使用。前項合法通信，指依電信規定作業之無線電信。低功率射頻電機需忍受合法通信或工業、科學以及醫療用電波輻射性電機設備之干擾。

減少電磁波影響，請妥適使用。

## BSMI Notice

### 安全諮詢及注意事項

- 請使用原裝電源供應器或只能按照本產品注明的電源類型使用本產品。
- 清潔本產品之前請先拔掉電源線。請勿使用液體、噴霧清潔劑或濕布進行清潔。
- 注意防潮，請勿將水或其他液體潑灑到本產品上。
- 插槽與開口供通風使用，以確保本產品的操作可靠並防止過熱，請勿堵塞或覆蓋開口。
- 請勿將本產品置放於靠近熱源的地方。除非有正常的通風，否則不可放在密閉位置中。
- 請不要私自打開機殼，不要嘗試自行維修本產品，請由授權的專業人士進行此項工作。



Продукт сертифіковано згідно с правилами системи УкрСЕПРО на відповідність вимогам нормативних документів та вимогам, що передбачені чинними законодавчими актами України.



## Safety Information

- When product has power button, the power button is one of the way to shut off the product; when there is no power button, the only way to completely shut off power is to disconnect the product or the power adapter from the power source.
- Don't disassemble the product, or make repairs yourself. You run the risk of electric shock and voiding the limited warranty. If you need service, please contact us.
- Avoid water and wet locations.
- Adapter shall be installed near the equipment and shall be easily accessible.
- The plug considered as disconnect device of adapter.
-  Use only power supplies which are provided by manufacturer and in the original packing of this product.

## DECLARATION OF CONFORMITY

For the following equipment:

Product Description: **150Mbps Wireless N ADSL2+ Modem Router**

Model No.: **TD-W8950N**

Trademark: **TP-LINK**

We declare under our own responsibility that the above products satisfy all the technical regulations applicable to the product within the scope of Council Directives:

Directives 1999/5/EC, Directives 2011/65/EU

The above product is in conformity with the following standards or other normative documents

**EN 300 328 V1.9.1**

**EN 301 489-1 V1.9.2 & EN 301 489-17 V2.2.1**

**EN 55022: 2010 + AC: 2011**

**EN 55024: 2010**

**EN 60950-1: 2006 + A11: 2009 + A1: 2010 + A12: 2011 +A2: 2013**

**EN 50385: 2002**

*The product carries the CE Mark:*

**CE 1588**

Person responsible for marking this declaration:



**Yang Hongliang**

**Product Manager of International Business**

Date of issue: 2016-01-15

TP-LINK TECHNOLOGIES CO., LTD

Building 24 (floors 1, 3, 4, 5), and 28 (floors 1-4) Central Science and Technology Park,  
Shennan Rd, Nanshan, Shenzhen, China

# CONTENTS

<b>Package Contents</b> .....	<b>1</b>
<b>Chapter 1. Product Overview</b> .....	<b>2</b>
1.1 Overview of the Modem Router .....	2
1.2 Main Features .....	3
1.3 Panel Layout .....	4
1.3.1 The Front Panel .....	4
1.3.2 The Back Panel .....	5
<b>Chapter 2. Connecting the Modem Router</b> .....	<b>6</b>
2.1 System Requirements.....	6
2.2 Installation Environment Requirements.....	6
2.3 Connecting the Modem Router .....	7
<b>Chapter 3. Quick Installation Guide</b> .....	<b>8</b>
3.1 TCP/IP Configuration .....	8
3.2 Quick Installation Guide .....	9
<b>Chapter 4. Configuring the Modem Router</b> .....	<b>13</b>
4.1 Login.....	13
4.2 Device Info .....	13
4.3 Quick Setup.....	14
4.4 Advanced Setup.....	14
4.4.1 Layer2 Interface .....	15
4.4.2 WAN Service .....	17
4.4.3 MAC Clone .....	26
4.4.4 LAN .....	27
4.4.5 NAT .....	30
4.4.6 Security .....	35
4.4.7 Parental Control .....	38
4.4.8 Quality of Service.....	40
4.4.9 Routing .....	43
4.4.10 DNS .....	45
4.4.11 DSL .....	47
4.4.12 UPnP .....	48

4.4.13	Interface Grouping .....	49
4.4.14	IP Tunnel.....	50
4.4.15	Multicast.....	52
4.5	IPTV .....	53
4.6	Wireless.....	53
4.6.1	Basic.....	53
4.6.2	Security.....	54
4.6.3	Wireless Schedule .....	68
4.6.4	MAC Filter .....	69
4.6.5	Wireless Bridge.....	70
4.6.6	Advanced .....	71
4.6.7	Station info .....	72
4.7	Guest Network .....	73
4.7.1	Basic.....	73
4.7.2	Station list .....	74
4.8	Diagnostics.....	74
4.9	Management .....	75
4.9.1	Settings.....	75
4.9.2	System Log .....	78
4.9.3	SNMP Agent.....	79
4.9.4	TR-069 Client .....	81
4.9.5	Internet Time .....	82
4.9.6	Access Control .....	82
4.9.7	Firmware Upgrade .....	84
4.9.8	Reboot .....	85
4.10	Logout .....	85
<b>Appendix A: Specifications .....</b>		<b>86</b>
<b>Appendix B: Configuring the PC.....</b>		<b>87</b>
<b>Appendix C: Troubleshooting.....</b>		<b>91</b>



# Package Contents

The following contents should be found in your package:

- One TD-W8950N 150Mbps Wireless N ADSL2+ Modem Router
- One power Adapter for TD-W8950N 150Mbps Wireless N ADSL2+ Modem Router
- Quick Installation Guide
- Technical Support card
- One RJ45 cable
- Two RJ11 cables
- One ADSL splitter
- One Resource CD for TD-W8950N 150Mbps Wireless N ADSL2+ Modem Router, including:
  - This User Guide
  - Other Helpful Information

 **Note:**

Make sure that the package contains the above items. If any of the listed items are damaged or missing, please contact your distributor.

# Chapter 1. Product Overview

Thank you for choosing the TD-W8950N 150Mbps Wireless N ADSL2+ Modem Router.

## 1.1 Overview of the Modem Router

The TD-W8950N 150Mbps Wireless N ADSL2+ Modem Router integrates 4-port Switch, Firewall, NAT-router and Wireless AP. Powered by 2x2 MIMO technology, the Wireless N router delivers exceptional range and speed, which can fully meet the need of Small Office/Home Office (SOHO) networks and the users demanding higher networking performance.

The TD-W8950N 150Mbps Wireless N ADSL2+ Modem Router utilizes integrated ADSL2+ transceiver and high speed MIPS CPU. The router supports full-rate ADSL2+ connectivity conforming to the ITU and ANSI specifications.

In addition to the basic DMT physical layer functions, the ADSL2+ PHY supports dual latency ADSL2+ framing (fast and interleaved) and the I.432 ATM Physical Layer.

The router provides up to 150Mbps wireless connection with other 802.11n wireless clients. The incredible speed makes it ideal for handling multiple data streams at the same time, which ensures your network stable and smooth. The performance of this 802.11n wireless router will give you the unexpected networking experience at speed 650% faster than 802.11g. It is also compatible with all IEEE 802.11g and IEEE 802.11b products.

With multiple protection measures, including SSID broadcast control and wireless LAN 64/128 WEP encryption, Wi-Fi protected Access (WPA2-PSK, WPA-PSK), as well as advanced Firewall protections, the TD-W8950N 150Mbps Wireless N ADSL2+ Modem Router provides complete data privacy.

The router provides flexible access control, so that parents or network administrators can establish restricted access policies for children or staff. It also supports Virtual Server and DMZ host for Port Triggering, and then the network administrators can manage and monitor the network in real time with the remote management function.

Since the router is compatible with virtually all the major operating systems, it is very easy to manage. Quick Setup Wizard is supported and detailed instructions are provided step by step in this user guide. Before installing the router, please look through this guide to know all the router's functions.

## 1.2 Main Features

- Complies with IEEE 802.11n to provide a wireless data rate of up to 150Mbps
- One RJ11 LINE port, four 10/100M Auto-Negotiation RJ45 LAN ports, supporting Auto MDI/MDIX
- Quick response semi-conductive surge protect circuit, reliable surge-protect function
- AFE to support Annex A and L deployments
- Provides external splitter
- Multi-user sharing a high-speed Internet connection
- Connecting the internet on demand and disconnecting from the Internet when idle for PPPoE
- Provides WPA/WPA2, WPA-PSK/WPA2-PSK data security, TKIP/AES encryption security
- Provides 64/128-bit WEP encryption security and wireless LAN ACL (Access Control List)
- Adopts Advanced DMT modulation and demodulation technology
- Adopts 150M wireless LAN transmission technology
- Supports access control, parents and network administrators can establish restricted access policies based on time of day for children or staff
- Supports Virtual Server, Port Triggering and DMZ host
- Supports UPnP, Dynamic DNS, Static Routing
- Supports bridge mode and router function
- Supports Web management
- Supports firmware upgrade
- Supports Flow Statistics
- Built-in firewall supporting IP address filtering, MAC address filtering and parental control
- Built-in DHCP server
- Supports IPv6.
- Supports Guest Network.
- Supports WPS

## 1.3 Panel Layout







### 1.3.1 The Front Panel

The router's LEDs are located on the front panel (View from left to right).



Figure 1-1

#### LED Explanation:

Name	Status	Indication
 (Power)	On	The modem router is powered on.
	Off	The modem router is off. Please ensure that the power adapter is connected correctly.
 (ADSL)	On	ADSL line is synchronized and ready to use.
	Flash	The ADSL negotiation is in progress.
	Off	ADSL synchronization fails. Please refer to <a href="#">Note 1</a> for troubleshooting.
 (Internet)	On	The network is available with a successful Internet connection.
	Off	There is no successful Internet connection or the modem router is operating in Bridge mode. Please refer to <a href="#">Note 2</a> for troubleshooting.
 (Wi-Fi)	On	Wireless is enabled.
	Flash	The modem router is sending or receiving data over Wi-Fi.
	Off	Wireless is disabled.
 (WPS)	On	A wireless device has been successfully added to the network by WPS function.
	Flash	WPS handshaking is in process and will continue for about 2 minutes. Please press the WPS button on other wireless devices that you want to add to the network while the LED is flashing.
	Off	The WPS function is disabled or the wireless device fails to be added to the network in 2 minutes after WPS function is enabled. For more information, please refer to <a href="#">WPS Setup</a> .
 (LAN1-4)	On	There is a device connected to this LAN port.
	Flash	The modem router is sending or receiving data over this LAN port.
	Off	There is no device connected to this LAN port.

**Note:**

- 1) If the ADSL LED is off, please check your Internet connection first. Refer to [2.3 Connecting the Modem Router](#) for more information about how to make Internet connection correctly. If you have already made a right connection, please contact your ISP to make sure if your Internet service is available now.
- 2) If the Internet LED is off, please check your ADSL LED first. If your ADSL LED is also off, please refer to **Note 1**. If your ADSL LED is GREEN ON, please check your Internet configuration. You may need to check this part of information with your ISP and make sure everything have been input correctly. Refer to [4.2 Device Info](#) for more information.

### 1.3.2 The Back Panel

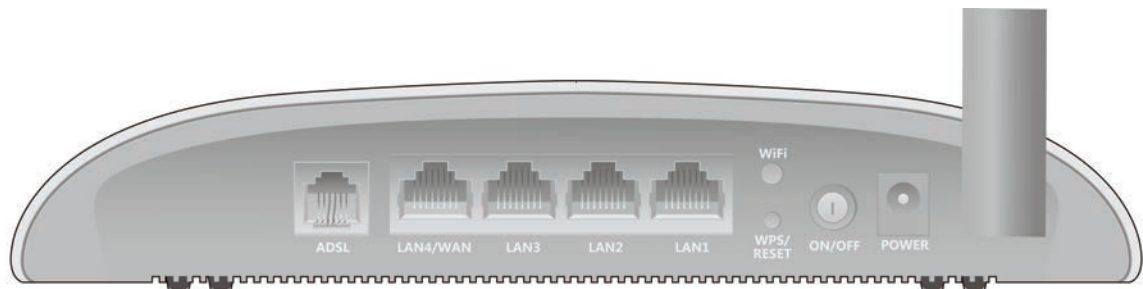

Figure 1-2

- **ADSL:** Connect to the Modem Port of Splitter or to the telephone line.
- **LAN4/WAN, LAN3, LAN2, LAN1:** Through these ports, you can connect the router to your PC or the other Ethernet network devices. Enable EWAN function and you will be able to connect to Cable/FTTH/ADSL device.
- **WiFi:** The switch for the Wi-Fi function.
- **WPS/RESET:**
  - 1) WPS function: For details, please refer to [WPS Setup](#).
  - 2) Reset the modem router: With the modem router powered on, press and hold down the WPS/RESET button on the rear panel of the modem router for more than 5 seconds and then release it. If all LEDs turn on momentarily, you restore the modem router successfully.
- **ON/OFF:** The switch for the power.
- **POWER:** The Power plug is where you will connect the power adapter.
- **Wireless Antennas:** To receive and transmit the wireless data.

# Chapter 2. Connecting the Modem Router

## 2.1 System Requirements

- Broadband Internet Access Service (DSL/Cable/Ethernet).
- PCs with a working Ethernet Adapter and an Ethernet cable with RJ45 connectors.
- TCP/IP protocol on each PC.
- Web browser, such as Microsoft Internet Explorer, Mozilla Firefox or Apple Safari.

## 2.2 Installation Environment Requirements

- The Product should not be located where it will be exposed to moisture or excessive heat.
- Place the router in a location where it can be connected to the various devices as well as to a power source.
- Make sure the cables and power cord are safely placed out of the way so they do not create a tripping hazard.
- The router can be placed on a shelf or desktop.
- Keep away from the strong electromagnetic radiation and the device of electromagnetic sensitive.

Generally, TD-W8950N is placed on a horizontal surface. The device also can be mounted on the wall as shown in Figure 2-1.

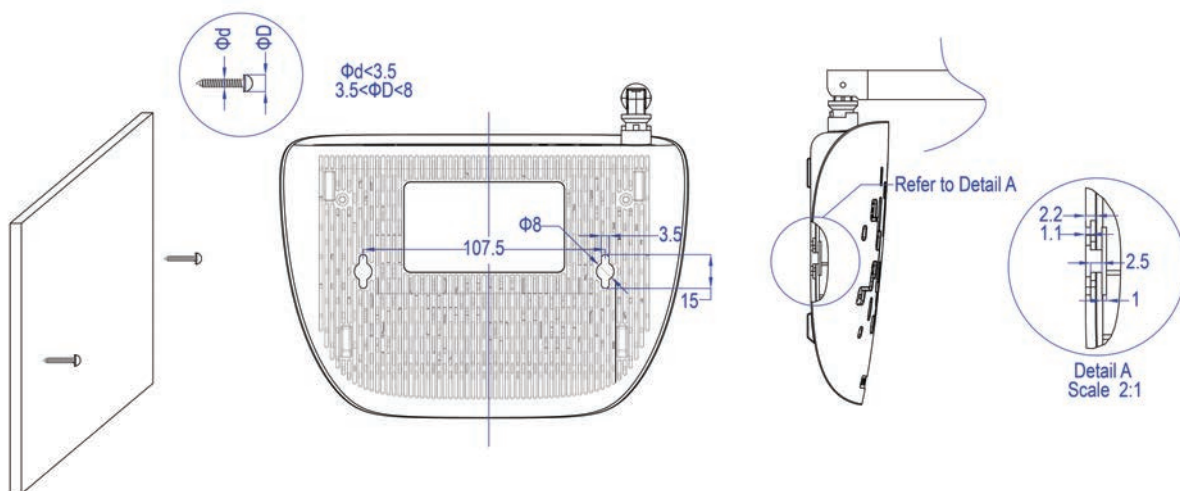

Figure 2-1 Wall-mount Install

### Note:

The diameter of the screw,  $3.5\text{mm} < D < 8\text{mm}$ , and the distance of two screws is 107.5mm. The screw that project from the wall need around 4mm based, and the length of the screw need to be at least 20mm to withstand the weight of the product.

## 2.3 Connecting the Modem Router

Before installing the device, please make sure your broadband service provided by your ISP is available. If there is any problem, please contact your ISP. Before cable connection, cut off the power supply and keep your hands dry. You can follow the steps below to install it.

**Step 1:** Connect the ADSL Line.

**Method one:** Plug one end of the twisted-pair ADSL cable into the ADSL port on the rear panel of TD-W8950N, and insert the other end into the wall socket.

**Method two:** You can use a separate splitter. External splitter can divide the data and voice, and then you can access the Internet and make calls at the same time. The external splitter has three ports:

- LINE: Connect to the wall jack
- PHONE: Connect to the phone sets
- MODEM: Connect to the ADSL port of TD-W8950N

Plug one end of the twisted-pair ADSL cable into the ADSL port on the rear panel of TD-W8950N. Connect the other end to the MODEM port of the external splitter.

**Step 2:** Connect the Ethernet cable. Attach one end of a network cable to your computer's Ethernet port or a regular hub/switch port, and the other end to the LAN port on the modem router TD-W8950N.

**Step 3:** Power on the computers and LAN devices.

**Step 4:** Attach the power adapter. Connect the power adapter to the power connector on the rear of the device and plug in the adapter to an electrical outlet or power extension. The electrical outlet shall be installed near the device and shall be easily accessible.

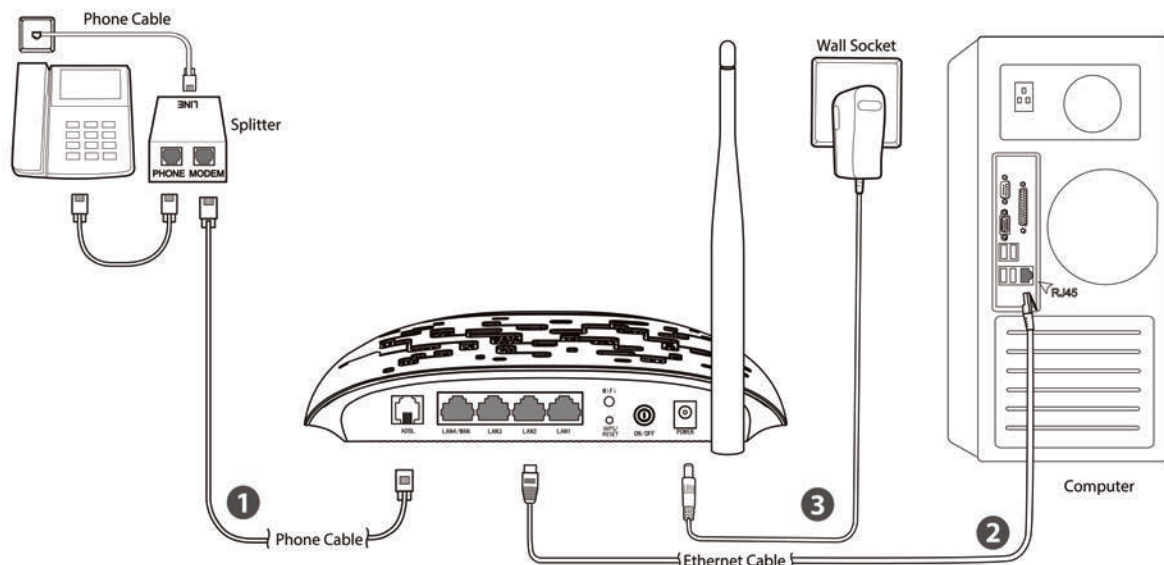

Figure 2-2

## Chapter 3. Quick Installation Guide

This chapter will show you how to configure the basic functions of your TD-W8950N 150Mbps Wireless N ADSL2+ Modem Router using **Quick Setup Wizard** within minutes.

### 3.1 TCP/IP Configuration

The default IP address of the TD-W8950N 150Mbps Wireless N ADSL2+ Modem Router is 192.168.1.1. And the default Subnet Mask is 255.255.255.0. These values can be changed as you desire. In this guide, we use all the default values for description.

Connect the local PC to the LAN/WAN port of the Router. And then you can configure the IP address for your PC in the following way.

- Obtain an IP address automatically
  - 1) Set up the TCP/IP Protocol in "**Obtain an IP address automatically**" mode on your PC. If you need instructions as to how to do this, please refer to [Appendix B: "Configuring the PC"](#).
  - 2) Then the built-in DHCP server will assign IP address for the PC.

Now, you can run the Ping command in the command prompt to verify the network connection. Please click the **Start** menu on your desktop, select **run** tab, type **cmd** or **command** in the field and press **Enter**. Type **ping 192.168.1.1** on the next screen, and then press **Enter**.

If the result displayed is similar to the screen below, the connection between your PC and the router has been established.

```
Pinging 192.168.1.1 with 32 bytes of data:
Reply from 192.168.1.1: bytes=32 time<1ms TTL=64
Reply from 192.168.1.1: bytes=32 time<1ms TTL=64
Reply from 192.168.1.1: bytes=32 time<1ms TTL=64
Reply from 192.168.1.1: bytes=32 time<1ms TTL=64

Ping statistics for 192.168.1.1:
    Packets: Sent = 4, Received = 4, Lost = 0 (0% loss),
    Approximate round trip times in milli-seconds:
        Minimum = 0ms, Maximum = 0ms, Average = 0ms
```

Figure 3-1

If the result displayed is similar to the screen shown below, it means that your PC has not connected to the router.

```
Pinging 192.168.1.1 with 32 bytes of data:
Request timed out.
Request timed out.
Request timed out.
Request timed out.

Ping statistics for 192.168.1.1:
    Packets: Sent = 4, Received = 0, Lost = 4 (100% loss),
```

Figure 3-2



You can check it by following the steps below:

**1) Is the connection between your PC and the router correct?**

The LED of LAN port which you link to the device and the LEDs on your PC's adapter should be lit.

**2) Is the TCP/IP configuration for your PC correct?**

If the router's IP address is 192.168.1.1, your PC's IP address must be within the range of 192.168.1.2 - 192.168.1.254.

## 3.2 Quick Installation Guide

With a Web-based utility, it is easy to configure and manage the TD-W8950N 150Mbps Wireless N ADSL2+ Modem Router. The Web-based utility can be used on any Windows, Macintosh or UNIX OS with a Web browser, such as Microsoft Internet Explorer, Mozilla Firefox or Apple Safari.

1. To access the configuration utility, open a web-browser and type the default address <http://tplinkmodem.net/> in the address field of the browser.



Figure 3-3

After a moment, a login window will appear, similar to the Figure 3-4. Enter **admin** for the User Name and Password, both in lower case letters. Then click the **Login** button or press the **Enter** key.

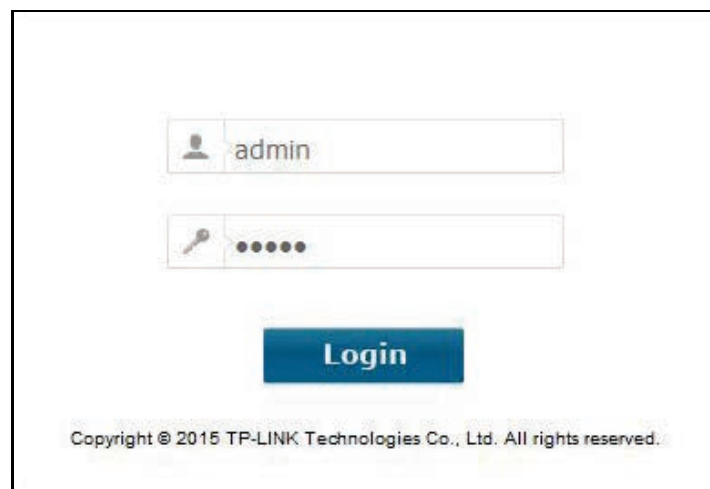

Figure 3-4

**Note:**

- 1) Do not mix up the user name and password with your ADSL account user name and password which are needed for PPP connections.
- 2) If the above screen does not pop up, it means that your Web-browser has been set to a proxy. Go to **Tools** menu → **Internet Options** → **Connections** → **LAN Settings**, in the screen that appears, cancel the Using Proxy checkbox, and click **OK** to finish it.
2. After your successful login, you will see the Login screen as shown in Figure 3-5. Click **Quick Setup** menu to access **Quick Setup Wizard** and click **NEXT**.

### Device Info

---

**Version Info**

Firmware Version:	1.0.1 Build 150911 Rel.54519
Hardware Version:	TD-W8950N V2 0x00000000
System Running Time:	0Day(s) 00:00:35

---

**LAN Info**

IPv4	LAN IP Address:	192.168.1.1
	LAN MAC Address:	40:16:9f:a0:b1:06
IPv6	IPV6 Address/Prefix Length:	NULL
	Auto Configuration:	RADVD&DHCPv6

---

**ADSL Info**

Line State:	Down
Line Rate - Upstream (Kbps):	0
Line Rate - Downstream (Kbps):	0

---

**Internet Info**

Notice:	There is no Route Interface.
Shortcut:	Click <a href="#">here</a> to do Quick Setup. Click <a href="#">here</a> to view all WAN interface's status and troubleshooting information.

Figure 3-5

- Choose the **WAN Type** for Internet access, and then click **Next**.

### Quick Setup - WAN Configurations

---

Please choose the Wan type for Internet access.

Choose WAN Type:     ADSL WAN    For ADSL(Telephone line/RJ11) Service

Ethernet WAN    For Ethernet(RJ45) Service

---

Enable IPv6 for this service

---

Figure 3-6

**Note:**

- 1) The Quick Setup Wizard will guide you to configure the WAN Service over ATM interface.
- 2) If you are unwilling to configure WAN Service now, you can click the **Skip WAN** button. Then you can configure WAN service referring to [4.4.1 Layer2 Interface](#).
4. If **ADSL WAN** is chosen, please select your **ISP** from the drop-down list. Select **WAN Link Type** provided by your ISP and enter the related parameters, and then click **Next**. Here we use PPPoE as an example.

**Quick Setup - WAN Configurations**

ISP:	<input type="text" value="Other"/>	
VPI/VCI:	<input type="text" value="8"/> / <input type="text" value="35"/> ([0-255] / [32-65535])	
Encapsulation Mode:	<input type="text" value="LLC/SNAP-BRIDGING"/> (optional)	
<hr/>		
WAN Link Type:	<input type="text" value="PPPoE(PPP over Ethernet)"/>	
PPP Username:	<input type="text"/>	
PPP Password:	<input type="text"/>	
PPPoE Service Name:	<input type="text"/> (optional)	
MTU (bytes):	<input type="text" value="1480"/> (optional)	
<hr/>		
<input type="button" value="Back"/>	<input type="button" value="Skip WAN"/>	<input type="button" value="Next"/>

Figure 3-7

**Note:**

If your ISP is not listed, please select **Other**. Then you can manually enter the VPI/VCI values and select **WAN Link Type** provided by your ISP.

If **Ethernet WAN** is chosen, please select **WAN Link Type** provided by your ISP and enter the related parameters, then click **Next**. Here we use PPPoE as an example.

### Quick Setup - WAN Configurations

---

Ethernet WAN Port: LAN4/WAN

---

WAN Link Type:  ▼

PPP Username:

PPP Password:

PPPoE Service Name:  (optional)

MTU (bytes):  (optional)

---

Back Skip WAN Next

Figure 3-8

- The WLAN function is enabled by default. You can rename your wireless network name and create your own password in this page. The default wireless name is TP-LINK\_XXXXXX, and the default wireless password, the same as the PIN code, is printed on the bottom label. Click **Next** to continue.

### Quick Setup - Wireless Configurations

---

Enable Wireless:

You can configure SSID and your WLAN Authentication type.

Wireless Network Name:  (Also called SSID)

In order to protect your network from hackers and unauthorized users, it is highly recommended you choose one of the following wireless network security settings.

Network Authentication:  ▼

Wireless Network Key:  (Also called WPA Pre-Shared Key)  
 (You can enter ASCII characters between 8 and 63 characters or 8 to 64 Hexadecimal characters.)

---

Back Skip Wi-Fi Next

Figure 3-9

- You will see the **Summary** screen below, click **Confirm** to make your settings take effect.

## Chapter 4. Configuring the Modem Router

This chapter will show each Web page's key function and the configuration way.

### 4.1 Login

After your successful login, you will see the main menus on the left of the Web-based utility. On the right, there are the corresponding explanations and instructions.

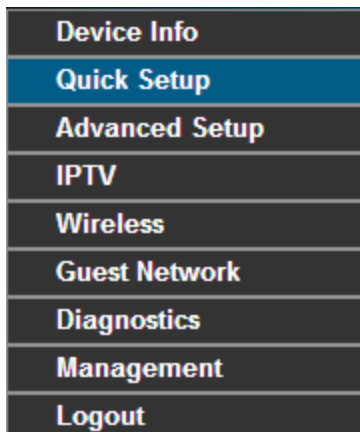

Device Info
Quick Setup
Advanced Setup
IPTV
Wireless
Guest Network
Diagnostics
Management
Logout

The detailed explanations for each Web page's key function are listed below.

### 4.2 Device Info

Choose "**Device Info**" menu, there are six submenus under the main menu: **Summary**, **WAN**, **Statistics**, **Route**, **ARP** and **DHCP**. This Device Info section mainly introduces the elementary information about the router and its current settings in use. Click any of them, and you will be able to view the corresponding information.

Choose "**Device Info**"→"**Summary**", you will see the Summary screen (shown in Figure 4-1). The first table indicates the information about the version including Software and Hardware. The second table displays the current status of the TD-W8950N connection. This information will vary depending on the settings of the router configured on the Advanced Setup screen.

Device Info		
<hr/>		
<b>Version Info</b>		
Firmware Version:	1.0.1 Build 150911 Rel.54519	
Hardware Version:	TD-W8950N V2 0x00000000	
System Running Time:	0Day(s) 00:00:35	
<hr/>		
<b>LAN Info</b>		
IPv4	LAN IP Address:	192.168.1.1
	LAN MAC Address:	40:16:9f:a0:b1:06
IPv6	IPV6 Address/Prefix Length:	NULL
	Auto Configuration:	RADVD&DHCPv6
<hr/>		
<b>ADSL Info</b>		
Line State:	Down	
Line Rate - Upstream (Kbps):	0	
Line Rate - Downstream (Kbps):	0	
<hr/>		
<b>Internet Info</b>		
Notice:	There is no Route Interface.	
Shortcut:	Click <a href="#">here</a> to do Quick Setup. Click <a href="#">here</a> to view all WAN interface's status and troubleshooting information.	

Figure 4-1

**Note:**

Click the other submenus under the main menu **Device Info**, and you will be able to view the corresponding information about **WAN**, **Statistics**, **Route**, **ARP** and **DHCP**.

### 4.3 Quick Setup

Please refer to Section [3.2 Quick Installation Guide](#).

### 4.4 Advanced Setup

Choose “**Advanced Setup**”, there are many submenus under the main menu. Among the submenus, **Layer2 Interface**, **WAN Service**, **LAN** etc. are default menus, while **NAT** will appear only when you select some corresponding functions. Click any one of them, and you will be able to configure the corresponding function.



This Advanced Setup section mainly introduces how to configure the router for adequate use. The detailed explanations for each subsection are provided below.

 **Note:**

To completely configure the WAN Interface, you need to first select the [Layer2 Interface \(4.4.1 Layer2 Interface\)](#) according to the connection ISP provides for you, and then to select the type of the connection ([4.4.2 WAN Service](#)) for the further configuration.

#### 4.4.1 Layer2 Interface

Choose “**Advanced Setup**”→“**Layer2 Interface**”, and you can select WAN Service Interface (layer2 interface) over **ATM Interface** or **ETH Interface**.

- **ATM Interface:** Configure the router to access Internet as an ADSL user. ISP provides you VPI (Virtual Path Identifier), VCI (Virtual Channel Identifier) settings and the DSL Interface with RJ11 connector. (Figure 4-2)
- **ETH Interface:** Configure the router to access Internet as an Ethernet user. ISP provides you Broadband Internet Service and the Ethernet Interface with RJ45 connector.

##### 4.4.1.1 ATM Interface

Choose “**Advanced Setup**”→“**Layer2 Interface**→**ATM Interface**”, you can Configure ATM interfaces on the screen below.

**DSL ATM Interface Configuration**

---

Choose Add, or Remove to configure DSL ATM interfaces.

Interface	Vpi	Vci	Link Type	Encapsulation	Category	Peak Cell Rate	Sustainable Cell Rate	Max Burst Size	Conn Mode	IP QoS	Sched Alg	Queue Weight	Group Precedence	Remove
atm0	8	35	EoA	LLC	UBR				VlanMuxMode	Enabled	WRR	1	8	<input type="checkbox"/>

Figure 4-2

- **Remove:** Select the check box in the table on the screen above and then click the **Remove** button, the corresponding interface will be deleted in the table.

**Note:**

If the interface is used by the configuration of the [4.4.2 WAN Service](#), you need to remove the corresponding WAN Service entry first before you can remove it here.

- **Add:** Click the button, and you can add a new interface in the next screen.

**ATM PVC Configuration**

---

This screen allows you to configure a ATM PVC.

**VPI:**  [0-255]  
**VCI:**  [32-65535]

Select DSL Link Type (EoA is for PPPoE, IPoE, and Bridge.)

EoA  
 PPPoA  
 IPoA

**Encapsulation Mode:**  ▼  
**Service Category:**  ▼

Select Scheduler for Queues of Equal Precedence

Round Robin (weight=1)  
 Weighted Fair Queuing

**Default Queue Weight:**  [1-63]  
**Default Queue Precedence:**  [1-8] (lower value, higher priority)

Note: For WFQ, the default queue precedence will be applied to all other queues in the VC.

Figure 4-3

- **VPI/VCI:** the VPI and VCI values provided by your ISP. Do not change them unless it was required by your ISP.
- **DSL Link Type:** Select a DSL Link Type which is provided by your ISP. The options include **EoA** (it is for PPPoE, IPoE, and Bridge), **PPPoA** (PPP over ATM) and **IPoA** (IP over ATM).
- **Encapsulation Mode:** The mode of the data processing over the Link Type you have selected. Uses the default setting, if you are not sure.
- **Service Category:** Select the type of the service assigned by your ISP in the drop-down list. The default type is **UBR Without PCR**.



**Note:**

The detailed configuration about **Scheduler for Queues of Equal Precedence** will be described in [Quality of Service](#).

**4.4.1.2 ETH Interface**

Choose “**Advanced Setup**”→“**Layer2 Interface**→**ETH Interface**”, you can configure ETH WAN interfaces on the screen below.



**ETH WAN Interface Configuration**

Choose Add, or Remove to configure ETH WAN interfaces.  
Allow one ETH as layer 2 wan interface.

Interface/(Name)	Connection Mode	Remove

Add Remove

Figure 4-4

➤ **Add:** Click the **Add** button, and you can add a new interface in the next screen.

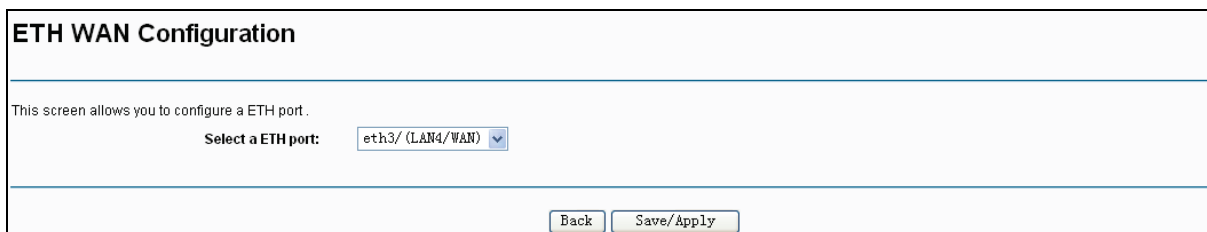

**ETH WAN Configuration**

This screen allows you to configure a ETH port.

Select a ETH port: eth3/(LAN4/WAN)

Back Save/Apply

Figure 4-5

➤ **ETH port:** Select an ETH port to configure as the WAN port.

Click **Save/Apply** to save your settings and then you will see the screen similar to Figure 4-6.

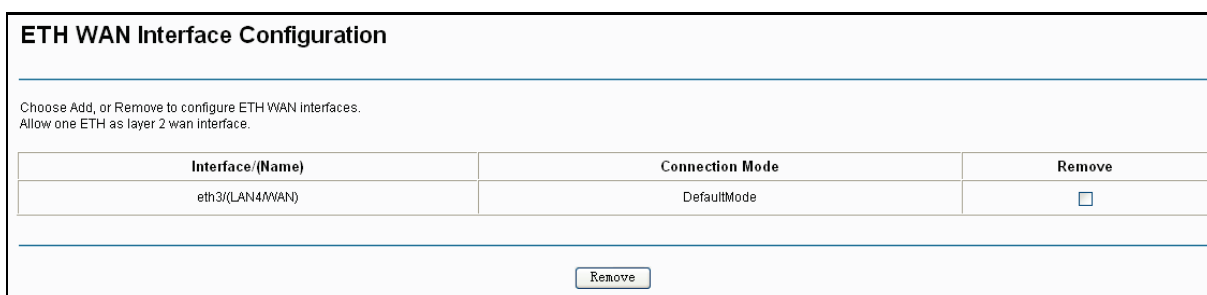

**ETH WAN Interface Configuration**

Choose Add, or Remove to configure ETH WAN interfaces.  
Allow one ETH as layer 2 wan interface.

Interface/(Name)	Connection Mode	Remove
eth3/(LAN4/WAN)	DefaultMode	<input checked="" type="checkbox"/>

Remove

Figure 4-6

➤ **Remove:** Select the check box in the table on the screen above and then click the **Remove** button, the corresponding interface will be deleted in the table.

**Note:**

Only one ETH is allowed to configure as the layer 2 WAN Interface.

**4.4.2 WAN Service**

Choose “**Advanced Setup**”→“**WAN Service**”, and you will see the WAN Port Information Table in the screen similar to Figure 4-7, which describes the WAN port settings and the relevant manipulation to each interface. After you add a new Lay2 Interface, please follow the instructions

below to complete the further configuration of WAN Interface. There are five different configurations for the connection types, which are PPPoE, IPoE, Bridge, PPPoA, and IPoA. You can select the corresponding types according to your needs.

### Wide Area Network (WAN) Service Setup

---

Choose Add, Remove or Edit to configure a WAN service over a selected interface.

Interface	Description	Type	Vlan8021p	VlanMuxId	Igmp	NAT	Firewall	IPv6	Mld	Remove	Edit
atm0.1	br_0_8_35	Bridge	N/A	N/A	Disabled	Disabled	Enabled	Disabled	Disabled	<input type="checkbox"/>	<input type="button" value="Edit"/>

---

Figure 4-7

**Note:**

The following section adopts different VPI, VCI to introduce further configuration for the different connection types, if you need to change the configuration of ATM PVC (VPI/VCI), you should go to the previous section ([4.4.1 Layer2 Interface](#)) to configure them again.

**4.4.2.1 ATM-EoA-PPPoE**

If your ISP provides a **PPPoE** connection and you need to use an ATM Interface, follow the steps below to add a WAN service over a selected ATM interface:

1. Add a **new** ATM interface ([4.4.1.1 ATM Interface](#)).
2. Click the **Add** button on the screen Figure 4-7 and you will enter the next screen as shown in Figure 4-8. Click **Next**.

### WAN Service Interface Configuration

---

Select a layer 2 interface for this service

Note: For ATM interface, the descriptor string is (portId\_vpi\_vci)

**Layer2 Interface:**

---

Figure 4-8

3. Select the **WAN service type** in Figure 4-9. If your ISP provides a PPPoE connection, select **PPPoE** option. You can create a service name for the **Service Description** or leave it the default name. Click **Next**.

### WAN Service Configuration

---

Select WAN service type:

PPP over Ethernet (PPPoE)

IP over Ethernet

Bridging

**Enter Service Description:**

For tagged service, enter valid 802.1P Priority and 802.1Q VLAN ID.  
For untagged service, set -1 to both 802.1P Priority and 802.1Q VLAN ID.

**Enter 802.1P Priority [0-7]:**

**Enter 802.1Q VLAN ID [0-4094]:**

Network Protocol Selection:

---

Figure 4-9

4. Enter the following parameters and then click **Next**.

### PPP Username and Password

---

PPP usually requires that you have a user name and password to establish your connection. In the boxes below, enter the user name and password that your ISP has provided to you.

**PPP Username:**

**PPP Password:**

**PPPoE Service Name:**

**MTU (bytes):**  (The default is 1480, do not change unless necessary.)

**Authentication Method:**

Dial on demand (with idle timeout timer)

Bridge PPPoE Frames Between WAN and Local Ports

---

**Multicast Proxy**

Enable IGMP Multicast Proxy

---

Figure 4-10

- **PPP Username/Password:** Enter the Username and Password provided by your ISP. These fields are case-sensitive.
- **PPPoE Service Name:** Enter the Service Name if it was provided by your ISP. You can leave it blank, if the ISP doesn't provide it.
- **MTU (bytes):** Maximum Transmission Unit Size. Check this box then you can change the MTU size. The default MTU value is 1480 Bytes. It is not recommended that you change the default value unless required by your ISP.
- **Authentication Method:** Select the **Authentication Method** from the drop-down list, the default method is **AUTO**, and you can leave it as a default setting.
- **Dial on demand (with idle timeout timer):** The router will cut off the Internet connection after it has been inactive for a specific period of time (idle timeout), and it will automatically

re-establish the connection as soon as you attempt to access the Internet again. If your Internet is charged by time you may want to select this option in order to save money.

- **Bridge PPPoE Frames Between WAN and Local Ports:** Select this option to enable PPP connection in your local PC.
- **Enable IGMP Multicast Proxy:** IGMP (Internet Group Management Protocol) is used to manage multicasting on TCP/IP networks. Some ISPs use IGMP to perform remote configuration for client devices, such as the router. The default value is enabled, and if you are not sure, please contact your ISP or just leave it.

5. Select a preferred wan interface as the system default gateway in Figure 4-11 and click **Next**.

Figure 4-11

6. Configure the DNS Server Addresses on the screen below and click **Next**.

Figure 4-12

- **Select DNS Server Interface from available WAN Interfaces:** You can select this option to automatically get DNS server information from the selected WAN interface.
- **Use the following Static DNS IP Address:** You can select this option to manually enter the primary and /or optional secondary DNS server IP addresses provided by your ISP.

**Note:**

If only single PVC with IPoA is configured, you must enter static DNS server IP addresses.

7. On the next screen you will see the detailed settings you've made. Please click the **Save/Apply** button to save these settings.

**WAN Setup - Summary**

---

Make sure that the settings below match the settings provided by your ISP.

Connection Type:	PPPoE
NAT:	Enabled
Full Cone NAT:	Disabled
Firewall:	Enabled
IGMP Multicast:	Enabled
Quality Of Service:	Disabled

Click "Save/Apply" to have this interface to be effective. Click "Back" to make any modifications.

---

Figure 4-13

8. On the next screen you will see the WAN Port Information Table with the new configuration.

**Wide Area Network (WAN) Service Setup**

---

Choose Add, Remove or Edit to configure a WAN service over a selected interface.

Interface	Description	Type	Vlan8021p	VlanMuxId	Igmp	NAT	Firewall	IPv6	Mld	Remove	Edit
atm0.1	br_0_8_35	Bridge	N/A	N/A	Disabled	Disabled	Enabled	Disabled	Disabled	<input type="checkbox"/>	<input type="button" value="Edit"/>

---

Figure 4-14

➤ **Remove:** Select the check box in the table above and then click **Remove**, the corresponding interface will be deleted.

#### 4.4.2.2 ATM-EoA-IPoE

If your ISP provides an **IPoE** connection and you need to use an ATM Interface, follow the steps below to add a WAN service over a selected ATM interface:

1. Add a **new** ATM interface ([4.4.1.1 ATM Interface](#)).
2. Click the **Add** button on the screen (as shown Figure 4-7). Select WAN Service Interface over ATM PVC on the next screen (as shown Figure 4-8).
3. If your ISP provides an IPoE connection, select **IP over Ethernet** option for the **WAN service type** on the screen (as shown Figure 4-9), and click **Next** button to continue.
4. Enter parameters in the following blanks to configure the WAN IP Address and click **Next**.

## WAN IP Settings

Enter information provided to you by your ISP to configure the WAN IP settings.  
 Notice: If "Obtain an IP address automatically" is chosen, DHCP will be enabled for PVC in IPoE mode.  
 If "Use the following Static IP address" is chosen, enter the WAN IP address, subnet mask and interface gateway.

Obtain an IP address automatically

Option 60 Vendor ID:

Option 61 IAID:  (8 hexadecimal digits)

Option 61 DUID:  (hexadecimal digit)

Option 125:  Disable  Enable

Use the following Static IP address:

WAN IP Address:

WAN Subnet Mask:

WAN gateway IP Address:

MTU (bytes):  (optional)

Figure 4-15

- **Obtain an IP address automatically:** Select this option, the router will be able to obtain IP network information dynamically from a DHCP server provided by your ISP.

 **Note:**

- 1) The response message from a DHCP server typically contains a number of configuration parameters (DHCP options) for the router. The DHCP options include IP network information, and also the vendor-specific options. In some cases, the router is implemented to perform user-defined operations (as shown below). You can implement your own treatment of all such options.
- 2) If the router is functioning as a DHCP client, it must identify itself in option 61 (client-identifier) in every DHCP message. DUID/IAID is portion of option 61.
  - **Option 60 Vendor ID:** The option code 60 used to identify Vendor class.
  - **Option 61 IAID:** IAID (Identity Association ID) assigns an Identity Association ID to individual interfaces. In cases where the device is functioning with a single DHCP client identity, it must use value 1 for IAID for all DHCP interactions. In cases where the device is functioning with multiple DHCP client identities, the values of IAID have to start at 1 for the first identity and be incremented for each subsequent identity. For example, the device may use IAID value 1 for the first physical interface and value 2 for the second. Alternatively, the device may use IAID value 1 for the virtual circuit corresponding to the first connection object in the data model and value 2 for the second connection object in the data model.
  - **Option 61 DUID:** Specifies the name of the interface whose link-layer address the server is to use as its DUID (DHCP Unique Identifier). You must enter a value for this parameter or the server will not start. When the server starts, the DUID is written to the system log.

- **Option 125:** The option 125 allows DHCP server to be pre-configured with policy for handling classes of devices in a certain way without requiring DHCP server to be able to parse the unique format used in client-identifier option.
- **Use the following IP Address:** If you are provided with a static IP/gateway Address, please select this option, and then enter the **WAN IP Address**, **WAN Subnet Mask** and **WAN gateway IP Address** manually.
5. You will see the next screen as below. You can enable the **NAT**, **SPI Firewall**, and **IGMP Multicast**, if you are not sure about the settings, just leave the default settings. Click **Next**.

### Network Address Translation Settings

---

Network Address Translation (NAT) allows you to share one Wide Area Network (WAN) IP address for multiple computers on your Local Area Network (LAN).

Enable NAT

Enable Firewall

---

**IGMP Multicast**

Enable IGMP Multicast

---

Figure 4-16

- **Enable NAT:** This technology translates the IP addresses of a local area network to the WAN IP address for the Internet. If this router is hosting your network's connection to the Internet, please select the check box. If another router exists in your network, you don't need to select the option.
- **Enable Firewall:** A SPI firewall enhances network's security. Select the option to use a firewall, or else without a firewall.
- **Enable IGMP Multicast:** This is enabled by default. This setting will not allow IGMP (Internet Group Management Protocol) packets to be forwarded to the LAN. IGMP is used to manage multicasting on TCP/IP networks. Most users will not need to enable this. Some ISPs use IGMP to perform remote configuration for client devices, such as the router. If you are unsure, check with your ISP.

 **Note:**

If you select the **Enable NAT** checkbox, the **NAT** menu will be added to the Web-based Utility. We will describe the detailed configuration in [4.4.5 NAT](#).

6. Select a preferred **WAN** interface as the system default gateway and click **Next**.

Figure 4-17

7. Configure the DNS Server Addresses on the screen as follows.

Figure 4-18

**Note:**

If only single PVC with IPoA is configured, you must enter static DNS server IP addresses.

8. On the next screen (as shown Figure 4-19) you will see the detailed settings you've made. Please click the **Save/Apply** button to save these settings.



### WAN Setup - Summary

---

Make sure that the settings below match the settings provided by your ISP.

Connection Type:	IPoE
NAT:	Enabled
Full Cone NAT:	Disabled
Firewall:	Enabled
IGMP Multicast:	Enabled
Quality Of Service:	Disabled

Click "Save/Apply" to have this interface to be effective. Click "Back" to make any modifications.

---

Figure 4-19

#### 4.4.2.3 ATM-EoA-Bridging

If you want to adopt the **Bridge** service and you need to use an ATM Interface, follow the steps below to add a WAN service over a selected ATM interface:

1. Add a new ATM interface (see [4.4.1.1 ATM Interface](#)).
2. Click the **Add** button on the screen Figure 4-7. Select WAN Service Interface over ATM PVC on the next screen (as shown Figure 4-8).
3. Select **Bridging** option for the **WAN service type** on the screen (as shown Figure 4-9), and click **Next** button to continue.
4. On the screen (as shown Figure 4-13) you will see the detailed settings you've made. Please click the **Save/Apply** button to save these settings.

#### 4.4.2.4 ATM-PPPoA

If your ISP provides a **PPPoA** connection and you need to use an ATM Interface, follow the steps below to add a WAN service over a selected ATM interface:

1. Add a new ATM interface and select **PPPoA** option for DSL Link Type (see [4.4.1.1 ATM Interface](#)).
2. Click the **Add** button on the screen Figure 4-7 and the next configuration is similar to **PPPoE**, (see section [4.4.2.1 ATM-EoA-PPPoE](#)). The difference is that you don't need to set the **PPPoE Service Name** and **Bridge PPPoE Frames Between WAN and Local Ports** on the screen of Figure 4-10.

#### 4.4.2.5 ATM-IPoA

If your ISP provides an **IPoA** connection and you need to use an ATM Interface, follow the steps below to add a WAN service over a selected ATM interface.

1. Add a new ATM interface and select **IPoA** option for DSL Link Type (see [4.4.1.1 ATM Interface](#)).
2. Click the **Add** button on the screen Figure 4-7 and the next configuration is similar to **IPoE** (see section [4.4.2.2 ATM-EoA-IPoE](#)). The difference is that you have to manually set the

Static IP Address on the screen of Figure 4-15, and the Static IP Address for DNS Server on the screen of Figure 4-18.

#### 4.4.2.6 ETH-PPPoE

If your ISP provides a **PPPoE** connection and you need to use an **ETH** Interface, follow the steps below to add a WAN service over a selected ETH interface:

1. Add a new **ETH** interface on the screen of [4.4.1.2 ETH Interface](#).
2. Click the **Add** button on the screen Figure 4-7 and the following configuration is similar to **PPPoE** over ATM interface (see section [4.4.2.1 ATM-EoA-PPPoE](#)).

#### 4.4.2.7 ETH-IPoE

If your ISP provides an **IPoE** connection and you want to use an **ETH** Interface, follow the steps below to add a WAN service over a selected ETH interface:

1. Add a new **ETH** interface on the screen of [4.4.1.2 ETH Interface](#).
2. Click the **Add** button on the screen Figure 4-7 and the next configuration is similar to **IPoE** over ATM interface (see section [4.4.2.2 ATM-EoA-IPoE](#)).

#### 4.4.2.8 ETH-Bridge

If you want to adopt the **Bridge** service and you need to use an **ETH** Interface, follow the steps below to add a WAN service over a selected ETH interface:

1. Add a new **ETH** interface on the screen of [4.4.1.2 ETH Interface](#).
2. Click the **Add** button on the screen Figure 4-7 and the next configuration is similar to **Bridge** over ATM interface (see section [4.4.2.3 ATM-EoA-Bridg](#)).

#### 4.4.3 MAC Clone

Choose menu “**Advanced Setup**”→“**MAC Clone**”, you can configure the MAC address of the WAN Interface as shown below.

The WAN Interface List displays the Lay2 Interfaces you have configured on the section [4.4.1 Layer2 Interface](#) and its default MAC Address. If you have not configured corresponding WAN Service for the interface on the section [4.4.2 WAN Service](#), the blank for MAC Address will display “Need a corresponding WAN Service”.

The last one of WAN Interface List displays your PC’s current address.

MAC Address Clone		
Set the special MAC address to the selected WAN Service.		
Clone MAC address for ppp0.2:	Not configured	Restore Default
Current PC MAC:	6c:62:6d:f7:32:09	Clone to ppp0.2
<b>Note:</b> Only the WAN ports can using MAC address clone. All the clone MAC address <b>MUST NOT</b> be the same with each other.		

Figure 4-20

Type the new value for the WAN Interface whose MAC Address you want to change.

You can select corresponding WAN Interface from the drop-down list and click **Clone** button to clone your current PC MAC.

Click **Restore Default** button to restore the WAN Interface’s default MAC Address.

**Note:**

Only the WAN Ports can use MAC Address Clone function. All the clone MAC addresses must not be the same with each other.

### 4.4.4 LAN

#### 4.4.4.1 IPv4 LAN Config

Choose “**Advanced Setup**”→“**LAN**”, and you will see the LAN screen (shown in Figure 4-21), the section allows you to configure the router’s LAN ports settings.

**Local Area Network (LAN) Setup**

Configure the DSL Modem Router IP Address and Subnet Mask for LAN interface. GroupName Default

IP Address:

Subnet Mask:

Enable IGMP Snooping

Standard Mode

Blocking Mode

Enable LAN side firewall

NOTE: If "LAN side firewall" is enabled, all PCs in the LAN will not able to manage the Router. Please make sure you have set a PC allowed to manage the Router on "Security->IP Filtering->Incoming" page.

Disable DHCP Server

Enable DHCP Server

Start IP Address:

End IP Address:

Leased Time (hour):  (1~48)

Static IP Lease List: (A maximum 32 entries can be configured)

MAC Address	IP Address	Status	Enable/Disable	Edit	Remove
<input type="button" value="Add"/> <input type="button" value="Enable All"/> <input type="button" value="Select All"/> <input type="button" value="Remove"/>					

Figure 4-21

- **IP Address:** You can configure the router’s IP Address and Subnet Mask for LAN Interface.
  - **IP Address:** Enter the router’s local IP Address, then you can access to the Web-based Utility via the IP Address, the default value is 192.168.1.1.
  - **Subnet Mask:** Enter the router’s Subnet Mask, the default value is 255.255.255.0.
- **Enable IGMP Snooping:** If you select the option, please choose the IGMP Mode: Standard Mode or Blocking Mode.
- **Enable LAN side firewall:** You can click the check box to enable LAN side firewall.
- **DHCP Server:** These settings allow you to configure the router’s Dynamic Host Configuration Protocol (DHCP) server function. The DHCP server is enabled by default for the router’s Ethernet LAN interface. DHCP service will supply IP settings to computers which are configured to automatically obtain IP settings that are connected to the router though the Ethernet port. If you enable the DHCP server, the router becomes the default gateway for

DHCP client connected to it. Keep in mind that if you change the IP address of the router, you must change the range of IP addresses in the pool used for DHCP on the LAN.

- **Start IP Address:** Enter a value for the DHCP server to start with when issuing IP addresses. Because the default IP address for the router is 192.168.1.1, the default Start IP Address is **192.168.1.100**, and the Start IP Address must be 192.168.1.2 or greater, but smaller than 192.168.1.254.
  - **End IP Address:** Enter a value for the DHCP server to end with when issuing IP addresses. The End IP Address must be smaller than 192.168.1.254. The default End IP Address is **192.168.1.200**.
  - **Leased Time (hour):** The Leased Time is the amount of time in which a network user will be allowed to connect to the router with their current dynamic IP address. Enter the amount of time, in hours, then the user will be “leased” this dynamic IP address. The default is **24** hours.
- **Static IP Lease List:** The function allows you to specify a reserved IP address for a PC on the LAN, that PC will always obtain the assigned IP address each time when it accesses the DHCP server. Reserved IP addresses should be assigned to servers that require permanent IP settings. Click the **Add Entries** button in Figure 4-21, and then you will set the rule in the screen as below.

### DHCP Static IP Lease

---

Enter the Mac address and Static IP address then click "Save/Apply" .

**MAC Address:**

**IP Address:**

---

Figure 4-22

- **MAC Address:** The MAC address of the computer on the LAN which you want to reserve an IP.
- **IP Address:** The IP address you want to reserved for the computer.

#### 4.4.4.2 IPv6 LAN Config

Choose “**Advanced Setup**”→“**LAN**” →“**IPv6 LAN Config**”, and you will see the LAN screen (shown in Figure 4-23), here you can configure LAN IPv6 interface for your modem router.

### IPv6 LAN Auto Configuration

---

Note: Stateless DHCPv6 is supported based on the assumption of prefix length less than 64. Interface ID does NOT support ZERO COMPRESSION "...". Please enter the complete information. For example: Please enter "0:0:0:2" instead of "::2".

**Static LAN IPv6 Address Configuration**  
 Interface Address (prefix length is required):

**IPv6 LAN Applications**

Enable DHCPv6 Server

Stateless

Stateful

Start interface ID:

End interface ID:

Leased Time (hour):

Enable RADVD

Enable ULA Prefix Advertisement

Randomly Generate

Statically Configure

Prefix:

Preferred Life Time (hour):

Valid Life Time (hour):

---

Figure 4-23

- **Interface Address (prefix length is required):** Here enter your interface address with its prefix length.
- **IPv6 LAN Applications:** Select a type to assign IPv6 addresses to the computers in your LAN. DHCPv6 Server and RADVD are provided.

**For DHCPv6 Server:**

- 1) If **Stateless** is selected, it doesn't need to be configured.
- 2) If **Stateful** is selected, please complete the following parameters.

Enable DHCPv6 Server

Stateless

Stateful

Start interface ID:

End interface ID:

Leased Time (hour):

- **Start interface ID:** Enter a value for the DHCPv6 server to start with when issuing IPv6 addresses.
- **End interface ID:** Enter a value for the DHCPv6 server to end with when issuing IPv6 addresses.
- **Leased Time (hour):** The Leased Time is the amount of time in which a network user will be allowed to connect to the modem router with their current dynamic IPv6 address. Enter the amount of time, in hours, then the user will be "leased" this dynamic IPv6

address. After the dynamic IPv6 address has expired, the user will be automatically assigned a new dynamic IPv6 address. The default is 24 hours.

**For RADVD:**

- 1) If **Randomly Generate** is selected, it doesn't need to be configured.
- 2) If **Statically Configure** is selected, please complete the following parameters.

Enable RADVD

Enable ULA Prefix Advertisement

Randomly Generate

Statically Configure

**Prefix:**

**Preferred Life Time (hour):**

**Valid Life Time (hour):**

- **Prefix:** Enter a value for the site prefix.

Click **Save/Apply** to make the configuration take effect.

#### 4.4.5 NAT

NAT (Network Address Translation) allows you to share one WAN (Wide Area Network) IP address for multiple computers on your LAN (Local Area Network).

**Note:**

When you select **PPPoA** or **PPPoE** for the WAN Setup, or when you select **Enable NAT** for the type of **IPoA** and **IPoE** connection ([4.4.2 WAN Service](#)), you will see the **NAT** menu in the Web-based Utility (shown in Figure 4-24).

**NAT -- Virtual Servers Setup**

---

Virtual Server allows you to direct incoming traffic from WAN side (identified by Protocol and External port) to the Internal server with private IP address on the LAN side. The Internal port is required only if the external port needs to be converted to a different port number used by the server on the LAN side. A maximum 80 entries can be configured.

Server Name	External Port Start	External Port End	Protocol	Internal Port Start	Internal Port End	Server IP Address	WAN Interface	Remove

---

Figure 4-24

Choose **“Advanced Setup”**→**“NAT”**, there are 4 submenus under the main menu: **Virtual Servers**, **Port Triggering**, **DMZ Host** and **ALG**. Click any of them, and you will be able to configure the corresponding function.

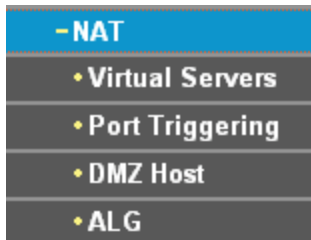

#### 4.4.5.1 Virtual Servers

Choose “**Advanced Setup**”→“**NAT**”→“**Virtual Servers**”, you can set up virtual servers on the screen below (shown in Figure 4-25).

Virtual servers can be used for setting up public services on your LAN, such as DNS, Email and FTP. A virtual server is defined as a service port, and all requests from the Internet to this service port will be redirected to the computer specified by the server IP. Any PC that was used for a virtual server must have a static or reserved IP Address because its IP Address may change when using the DHCP function.

**NAT -- Virtual Servers Setup**

---

Virtual Server allows you to direct incoming traffic from WAN side (identified by Protocol and External port) to the Internal server with private IP address on the LAN side. The Internal port is required only if the external port needs to be converted to a different port number used by the server on the LAN side. A maximum 80 entries can be configured.

Server Name	External Port Start	External Port End	Protocol	Internal Port Start	Internal Port End	Server IP Address	WAN Interface	Remove

---

Figure 4-25

- **Virtual Server Table:** The table indicates the information about the Virtual Server entries.
  - **Server Name:** This is the name of the **Virtual Server**. It is exclusive and must be filled in.
  - **External Port Start:** The base number of External Ports. You can type a service port or leave it blank.
  - **External Port End:** The end number of External Ports. You can type a service port or leave it blank.
  - **Protocol:** The protocol used for this application, **TCP**, **UDP**, or **TCP/UDP**.
  - **Internal Port Start:** The base number of Internal Ports. You can type a service port or leave it blank.
  - **Internal Port End:** The end number of Internal Ports. You can type a service port or leave it blank.
  - **Server IP Address:** The IP Address of the PC providing the service application.
  - **WAN Interface:** The WAN Service Interface providing the service application.
- **Add:** Click the **Add** button to add a new entry.
- **Remove:** Select the check box in the table (shown in Figure 4-25) and then click the **Remove** button, then the corresponding entry will be deleted in the table.

**To add a virtual server entry:**

1. Click the **Add** button on the preceding screen Figure 4-25, and then you will see the new Virtual Server in the next screen as shown in Figure 4-26.

**NAT -- Virtual Servers**

---

Select the service name, and enter the server IP address and click "Save/Apply" to forward IP packets for this service to the specified server.  
NOTE: The "Internal Port End" cannot be modified directly. Normally, it is set to the same value as "External Port End". However, if you modify "Internal Port Start", then "Internal Port End" will be set to the same value as "Internal Port Start".

Remaining number of entries that can be configured:32

Use Interface:  ▼

Service Name:

Select a Service:  ▼

Custom Service:

Server IP Address:

---

External Port Start	External Port End	Protocol	Internal Port Start	Internal Port End
<input type="text"/>	<input type="text"/>	TCP ▼	<input type="text"/>	<input type="text"/>
<input type="text"/>	<input type="text"/>	TCP ▼	<input type="text"/>	<input type="text"/>
<input type="text"/>	<input type="text"/>	TCP ▼	<input type="text"/>	<input type="text"/>
<input type="text"/>	<input type="text"/>	TCP ▼	<input type="text"/>	<input type="text"/>
<input type="text"/>	<input type="text"/>	TCP ▼	<input type="text"/>	<input type="text"/>
<input type="text"/>	<input type="text"/>	TCP ▼	<input type="text"/>	<input type="text"/>
<input type="text"/>	<input type="text"/>	TCP ▼	<input type="text"/>	<input type="text"/>
<input type="text"/>	<input type="text"/>	TCP ▼	<input type="text"/>	<input type="text"/>
<input type="text"/>	<input type="text"/>	TCP ▼	<input type="text"/>	<input type="text"/>
<input type="text"/>	<input type="text"/>	TCP ▼	<input type="text"/>	<input type="text"/>
<input type="text"/>	<input type="text"/>	TCP ▼	<input type="text"/>	<input type="text"/>
<input type="text"/>	<input type="text"/>	TCP ▼	<input type="text"/>	<input type="text"/>
<input type="text"/>	<input type="text"/>	TCP ▼	<input type="text"/>	<input type="text"/>
<input type="text"/>	<input type="text"/>	TCP ▼	<input type="text"/>	<input type="text"/>
<input type="text"/>	<input type="text"/>	TCP ▼	<input type="text"/>	<input type="text"/>

---

Figure 4-26

2. Select the Interface which you want to use from the drop-down list.
3. Select the service which you want to use from the drop-down list. If the list does not have the service you need, type the name of the custom service in the text box.
4. Type the IP Address of the computer in the **Server IP Address** text box.
5. Enter the External Port Start, External Port End, Internal Port Start and Internal Port End in the table, and then select the protocol used for this Virtual Server, **TCP**, **UDP** or **All**.
6. Click **Save/Apply** to enable virtual server and then you will see your setting as shown in Figure 4-25.

**Note:**

If you select the service from the drop-down list, the External Port Start, External Port End, Internal Port Start, Internal Port End and the Protocol will be added in the table automatically. You only need to enter the Server IP Address for the Virtual Server.

**4.4.5.2 Port Triggering**

Choose **“Advanced Setup”**→**“NAT”**→**“Port Triggering”**, you can set Port Triggering on the screen (shown in Figure 4-27).

Some applications require that specific ports in the router's firewall should be opened for access by remote devices. Port Trigger dynamically opens up the 'Open Ports' in the firewall when an



application on the LAN initiates a TCP/UDP connection to a remote device using the triggering ports. The router allows the remote party from the WAN side to establish new connections back to the application on the LAN side using the open ports. A maximum 32 entries can be configured.

**NAT -- Port Triggering Setup**

---

Some applications require that specific ports in the Router's firewall be opened for access by the remote parties. Port Trigger dynamically opens up the 'Open Ports' in the firewall when an application on the LAN initiates a TCP/UDP connection to a remote party using the 'Triggering Ports'. The Router allows the remote party from the WAN side to establish new connections back to the application on the LAN side using the 'Open Ports'. A maximum 32 entries can be configured.

Application Name	Trigger				Open			WAN Interface	Status	Enable/Disable	Edit	Remove
	Protocol	Port Range		Protocol	Port Range							
		Start	End		Start	End						
<input type="button" value="Add"/> <input type="button" value="Enable All"/> <input type="button" value="Select All"/> <input type="button" value="Remove"/>												

Figure 4-27

- **Port Triggering Table:** The table indicates the information about the Port Triggering entries.
  - **Application (Name):** This is the name of the **Port Triggering**. It is exclusive and must be filled.
  - **Trigger:** It includes the Protocol and the Start and End value of the Trigger Ports.
  - **Open:** It includes the Protocol and the Start and End value of the Open Ports.
  - **WAN Interface:** The WAN Service Interface setting the Port Triggering.
- **Add:** Click the button to add a new entry.
- **Remove:** Select the check box in the table (shown in Figure 4-27) and then click the **Remove** button, then the corresponding entry will be deleted in the table.

**To add a new Port Triggering:**

1. Click the **Add** button in Figure 4-27, and then you will see the new Port Triggering in the next screen as shown in Figure 4-28.

**NAT -- Port Triggering**

---

Some applications such as games, video conferencing, remote access applications and others require that specific ports in the Router's firewall be opened for access by the applications. You can configure the port settings from this screen by selecting an existing application or creating your own (Custom application) and click "Save/Apply" to add it.

Remaining number of entries that can be configured: 32

Use Interface:

Application Name:

Select an application:

Custom application:

Trigger Port Start	Trigger Port End	Trigger Protocol	Open Port Start	Open Port End	Open Protocol
<input type="text"/>	<input type="text"/>	TCP <input type="button" value="v"/>	<input type="text"/>	<input type="text"/>	TCP <input type="button" value="v"/>
<input type="text"/>	<input type="text"/>	TCP <input type="button" value="v"/>	<input type="text"/>	<input type="text"/>	TCP <input type="button" value="v"/>
<input type="text"/>	<input type="text"/>	TCP <input type="button" value="v"/>	<input type="text"/>	<input type="text"/>	TCP <input type="button" value="v"/>
<input type="text"/>	<input type="text"/>	TCP <input type="button" value="v"/>	<input type="text"/>	<input type="text"/>	TCP <input type="button" value="v"/>
<input type="text"/>	<input type="text"/>	TCP <input type="button" value="v"/>	<input type="text"/>	<input type="text"/>	TCP <input type="button" value="v"/>
<input type="text"/>	<input type="text"/>	TCP <input type="button" value="v"/>	<input type="text"/>	<input type="text"/>	TCP <input type="button" value="v"/>
<input type="text"/>	<input type="text"/>	TCP <input type="button" value="v"/>	<input type="text"/>	<input type="text"/>	TCP <input type="button" value="v"/>
<input type="text"/>	<input type="text"/>	TCP <input type="button" value="v"/>	<input type="text"/>	<input type="text"/>	TCP <input type="button" value="v"/>
<input type="text"/>	<input type="text"/>	TCP <input type="button" value="v"/>	<input type="text"/>	<input type="text"/>	TCP <input type="button" value="v"/>

Figure 4-28

2. Select the application from the drop-down list. If the list does not have the application that you want, select the **Custom application** radio button, and type the name of the custom application in the text box.
3. Enter the **Trigger Port Start**, **Trigger Port End**, **Open Port Start** and **Open Port End** in the table, and then select the **Trigger protocol** and **Open protocol**, **TCP**, **UDP** or **All**.
4. Click **Save/Apply** to enable the settings and then you will see your settings as shown in Figure 4-27.

 **Note:**

If you select the application from the drop-down list, the External Port Start, External Port End, Internal Port Start, Internal Port End and the Protocol will be added in the table automatically.

#### 4.4.5.3 DMZ Host

Choose “**Advanced Setup**”→“**NAT**”→“**DMZ Host**”, you can set up DMZ Host on the screen (shown in Figure 4-29).

The DMZ host feature can make a local host exposed to the Internet for a special-purpose service, such as online gaming or video conferencing.

**NAT -- DMZ Host**

---

The DSL Modem Router will forward IP packets from the WAN that do not belong to any of the applications configured in the Virtual Servers table to the DMZ host computer.

Enter the computer's IP address and click 'Save/Apply' to activate the DMZ host.

Clear the IP address field and click 'Save/Apply' to deactivate the DMZ host.

DMZ Host IP Address:

---

Figure 4-29

#### To add a new DMZ Host:

You can enter the computer's IP address and then click **Save/Apply** to activate the DMZ host you set on this page.

 **Note:**

DMZ host forwards all the ports at the same time. Any PC whose port is being forwarded must have its DHCP client function disabled and should have a new static IP Address assigned to it because its IP Address may change while using the DHCP function.

#### 4.4.5.4 ALG

Choose “**Advanced Setup**”→“**NAT**”→“**ALG**”, and then you can configure the basic security in the screen.

### ALG

---

Select the ALG below.

- PPTP Enabled
- L2TP Enabled
- IPSEC Enabled
- FTP Enabled
- SIP Enabled
- H.323 Enabled

---

Figure 4-30

Click the **Save/Apply** button to save your settings.

#### 4.4.6 Security

Choose “**Advanced Setup**”→“**Security**”, and you will see the security screen including **IP Filtering** and **MAC Filtering** (only effective in Bridging mode) submenus.



##### 4.4.6.1 IP Filtering

The IP address filtering feature makes it possible for administrators to control user's access to the Internet, which is based on user's IP. The IP address filtering here means **Outgoing**, the detailed descriptions are provided below.

Choose “**Advanced Setup**”→“**Security**”→“**IP Filtering**”, you can configure Outgoing Filtering rules on the screen (shown in Figure 4-31).

The Outgoing IP Filtering feature allows you to control some IP traffic from LAN to access to some specifically addresses. By default, all outgoing IP traffic from LAN is allowed, but some IP traffic can be **BLOCKED** by setting up filters.

#### Outgoing IP Filtering Setup

---

By default, all outgoing IP traffic from LAN is allowed, but some IP traffic can be **BLOCKED** by setting up filters.

Choose Add or Remove to configure outgoing IP filters. A maximum 36 IP filters can be configured.

Filter Name	IP Version	Protocol	SrcIP/ PrefixLength	SrcPort	DstIP/ PrefixLength	DstPort	Remove
sendmail-filter	4	TCP or UDP	192.168.1.222		210.17.188.204	25	<input type="checkbox"/>

---

Figure 4-31

### Set up an Outgoing IP Filtering rule:

1. Click the **Add** button in Figure 4-31, and you will see the next screen as shown in Figure 4-32.

**Add IP Filter -- Outgoing**

---

The screen allows you to create a filter rule to identify outgoing IP traffic by specifying a new filter name and at least one condition below. All of the specified conditions in this filter rule must be satisfied for the rule to take effect. Click 'Save/Apply' to save and activate the filter.

**Filter Name:**

**IP Version:**

**Protocol:**

**Source IP address[prefix length]:**

**Source Port (port or port:port):**

**Destination IP address[prefix length]:**

**Destination Port (port or port:port):**

---

Figure 4-32

2. Enter the **Filter name** for the rule, it is exclusive and must be filled.
3. Select the **protocol: TCP/UDP, TCP, UDP or ICMP** in the drop-down list for the connection between the Source IP address and Destination IP address.
4. Enter a **Source IP Address** in dotted-decimal notation format and then type **Source Port** (port or port: port) in the text boxes separately.
5. Enter a **Destination IP Address** in dotted-decimal notation format and then type **Destination Port** (port or port: port) in the text boxes separately.
6. Click **Save/Apply** to save this entry.

 **Note:**

- 1) When you add an Outgoing IP Filtering entry, you must configure at least one condition on the preceding screen except the Filter name. If you leave the Protocol blank, it means that the rule is effective to all protocols, if you leave the Source IP Address and/or Destination IP Address blank, it suggests that all Source IP Addresses and/or Destination IP Addresses are controlled by the rule, if you leave the Source Port and/or Destination Port blank, it suggests that all Source Ports and/or Destination Ports are controlled by the rule.
- 2) You can add an Incoming IP Filtering entry by similar steps.

#### 4.4.6.2 MAC Filtering

Choose “**Advanced Setup**”→“**Security**”→“**MAC Filtering**”, you can configure MAC Filtering rules on the screen as shown in Figure 4-33. The section allows you to control access to the Internet by users on your local network based on their MAC Address.

 **Note:**

MAC Filtering is only effective on ATM PVC(s) configured in Bridging mode.

### MAC Filtering Setup

MAC Filtering is only effective on ATM PVCs configured in Bridge mode. **FORWARDED** means that all MAC layer frames will be **FORWARDED** except those matching with any of the specified rules in the following table. **BLOCKED** means that all MAC layer frames will be **BLOCKED** except those matching with any of the specified rules in the following table.

MAC Filtering Policy For Each Interface:  
**WARNING: Changing from one policy to another of an interface will cause all defined rules for that interface to be REMOVED AUTOMATICALLY! You will need to create new rules for the new policy.**

Interface	Policy	Change
atm0.1	FORWARD	<input type="checkbox"/>

Choose Add or Remove to configure MAC filtering rules. A maximum 36 MAC filters can be configured.

Interface	Protocol	Destination MAC	Source MAC	Remove
atm0.1	IGMP	00:11:22:33:44:AA	00:11:22:33:44:BB	<input type="checkbox"/>

Figure 4-33

- **Change Policy:** There are two policies for the MAC filters: **FORWARDED** and **BLOCKED**. Select the **Change** checkbox and click the **Change Policy** button to change from one policy to another. When you set **FORWARDED**, it means that all MAC layer frames will be **forwarded** except those matching with any of the specified rules in the table (shown in Figure 4-33). While **BLOCKED** means that all MAC layer frames will be **blocked** except those matching with any of the specified rules in the preceding table.
- **Add:** Click the **Add** button, and then you can add a new MAC Filter in the next screen (shown in Figure 4-33).
- **Remove:** Select the check box in the table (shown in Figure 4-33) and then click the **Remove** button, and then the corresponding entry will be deleted in the table.

**To add a MAC Filtering rule:**

1. Click the **Add** button in Figure 4-33, and you will see the next screen similar to in Figure 4-34.

### Add MAC Filter

Create a filter to identify the MAC layer frames by specifying at least one condition below. If multiple conditions are specified, all of them take effect. Click "Save/Apply" to save and activate the filter.

**Protocol Type:**

**Destination MAC Address:**

**Source MAC Address:**

**WAN Interfaces (Configured in Bridge mode only):**

Figure 4-34

2. Select **Protocol Type** in the drop-down list for the rule.
3. Enter **Destination MAC Address** and **Source MAC Address** in the text box.
4. Select the **WAN interfaces** from the drop-down list.

- Click **Save/Apply** to save this entry and then you will see your settings as shown in Figure 4-34.

#### 4.4.7 Parental Control

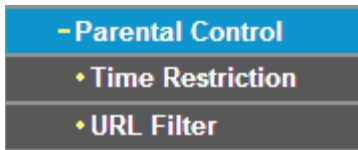

Choose “**Advanced Setup**”→“**Parental Control**”. You can configure the Parental Control function on the screen as shown in Figure 4-35. Time Restriction allows you to control the Internet activities of the children by restricting the time of surfing. URL Filter limits the computers you choose to access certain websites. These two features work independently.

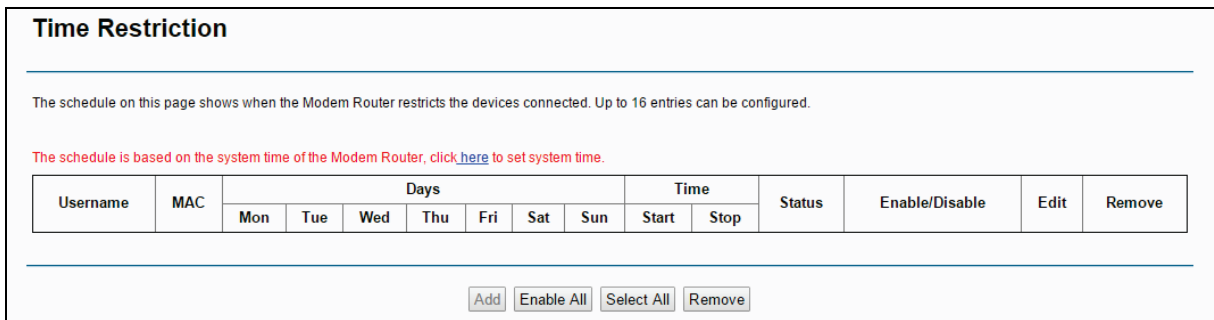

Figure 4-35

##### 4.4.7.1 Time Restriction

This feature allows you add time of day restriction to a special device connected to the router.

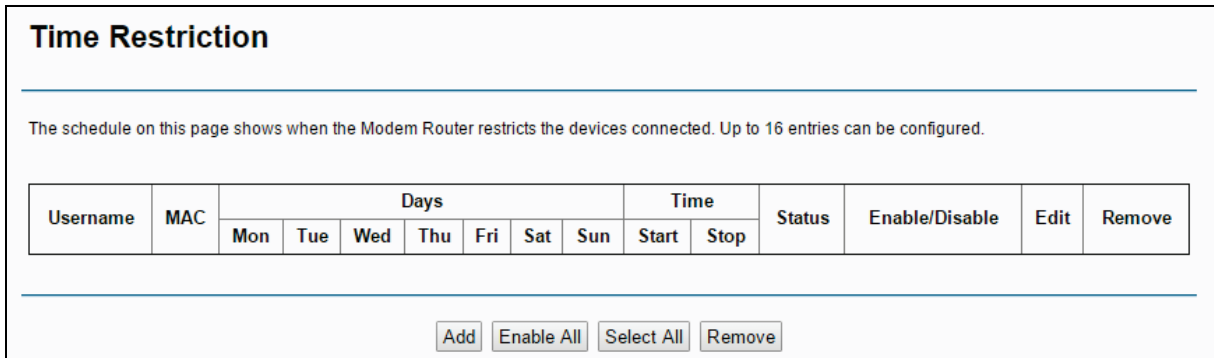

Figure 4-36

#### To add a Time Restriction entry:

- Click the **Add** button in Figure 4-36, and then you will see the next screen as shown in Figure 4-37.

**Access Time Restriction**

---

This page adds time of day restriction to a special LAN device connected to the Router. The "Browser's MAC Address" automatically displays the MAC address of the LAN device where the browser is running.  
 To restrict other LAN device, click the "Other MAC Address" button and enter the MAC address of the other LAN device.  
 To find out the MAC address of a Windows based PC, go to command window and type "ipconfig /all".

User Name:

Browser's MAC Address:

Other MAC Address(XXXXXXXXXX):

Days of the week:	Mon	Tue	Wed	Thu	Fri	Sat	Sun
Click to select:	<input checked="" type="checkbox"/>	<input checked="" type="checkbox"/>	<input checked="" type="checkbox"/>	<input checked="" type="checkbox"/>	<input checked="" type="checkbox"/>	<input type="checkbox"/>	<input type="checkbox"/>

Start Blocking Time (hh:mm):

End Blocking Time (hh:mm):

Figure 4-37

2. Enter the **User Name** of the LAN device connected to the router.
3. To restrict the device where the browser is running, select the **Browser's MAC Address** radio button. The MAC Address has been automatically displayed in the text box. To restrict other LAN devices, click **Other MAC Address** radio button and enter the MAC address of the other LAN device.
4. Select the day to allow the rule to take effect in the table.
5. Enter the **Start Blocking Time** and **End Blocking Time** in the text box separately, and then the device controlled will be unable to connect to the Internet during that time.
6. Click **Save/Apply** to save this entry and then you will see your settings as shown in Figure 4-36.

 **Note:**

The Time Restriction will not work correctly before the time of the device is set in "**Management** → **Internet Time**".

**4.4.7.2 URL Filter**

This feature allows you to configure the filter rules based on URL to control the computers in the LAN to access the specified websites, and it is independent of Time Restriction feature.

### URL Filter

---

Select a URL Filter Mode and choose devices to be controlled, then add website addresses to the Website Restriction list. Up to 4 devices can be controlled and up to 100 entries can be configured in the Website Restriction list.  
 NOTE: URL Filter will take effect only when there is an active WAN service with NAT enabled.

**URL Filter Mode:**

Disable

Allow In Allow mode, the devices under control can only access the websites in the Website Restriction list.

Deny In Deny mode, the devices under control cannot access the websites in the Website Restriction list.

---

**Devices Under Control:**

MAC Address of Current PC:

Choose a MAC Address:

MAC Address	Remove
	<input type="button" value="Remove"/>

NOTE: Up to 4 devices can be controlled.

---

**Website Restriction:**

Address	Remove
	<input type="button" value="Add"/> <input type="button" value="Remove"/>

Figure 4-38

**To set up the URL Filter:**

1. Check the **Allow** or **Deny** radio button. Here we take **Deny** for example.
2. Focus on the **Devices Under Control** section. Choose the MAC Address of the computer you want to control and click the **Add to Devices Under Control** button.
3. Focus on the **Website Restriction** section. Click the **Add** button and then you will see the next screen, as shown in the following picture. Enter a URL address such as a website, then click **Save/Apply**.

### Parental Control -- URL Filter Add

---

Enter the URL address, then click "Save/Apply" to add the entry to the URL filter.

URL Address:

---

Figure 4-39



## 4.4.8 Quality of Service

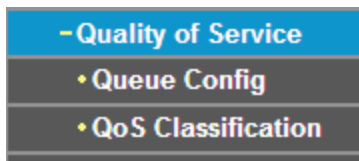

Choose “**Advanced Setup**”→“**Quality of Service**”, you can enable QoS (Quality of Service) on the screen shown in Figure 4-40. QoS helps to prioritize data as it enters your router. By attaching special identification marks or headers to incoming packets, QoS determines which queue the packets enter, based priority. This is useful when there are certain types of data you want to give higher priority, such as voice data packets give higher priority than Web data packets. This option will provide better service of selected network traffic over various technologies.

### QoS -- Queue Management Configuration

---

If Enable QoS checkbox is selected, choose a default DSCP mark to automatically mark incoming traffic without reference to a particular classifier. Click 'Save/Apply' button to save it.

**Note:** If Enable QoS checkbox is not selected, all QoS will be disabled for all interfaces.

**Note:** The default DSCP mark is used to mark all egress packets that do not match any classification rules.

Enable QoS

---

Figure 4-40

Select the **Enable QoS** checkbox to enable all QoS for all interfaces, and click **Save/Apply** to save the current configuration.

### 4.4.8.1 Queue Config

Choose “**Advanced Setup**”→“**Quality of Service**”→“**Queue Config**”, you can set up virtual servers on the screen below.

### QoS Queue Setup

In ATM mode, maximum 8 queues can be configured.  
 In PTM mode, maximum 8 queues can be configured.  
 For each Ethernet interface, maximum 4 queues can be configured.  
 For each Ethernet WAN interface, maximum 4 queues can be configured.  
 To add a queue, click the **Add** button.  
 To remove queues, check their remove-checkboxes, then click the **Remove** button.  
 The **Enable** button will scan through every queues in the table. Queues with enable-checkbox checked will be enabled. Queues with enable-checkbox un-checked will be disabled.  
 The enable-checkbox also shows status of the queue after page reload.  
 Note that if WMM function is disabled in Wireless Page, queues related to wireless will not take effects.

**The QoS function has been disabled. Queues would not take effects.**

Name	Key	Interface	Qid	Prec/Alg/Wght	DSL Latency	PTM Priority	Min Bit Rate(bps)	Shaping Rate(bps)	Burst Size(bytes)	Enable	Remove
WMM Voice Priority	1	wl0	1	1/SP						Enabled	
WMM Voice Priority	2	wl0	2	2/SP						Enabled	
WMM Video Priority	3	wl0	3	3/SP						Enabled	
WMM Video Priority	4	wl0	4	4/SP						Enabled	
WMM Best Effort	5	wl0	5	5/SP						Enabled	
WMM Background	6	wl0	6	6/SP						Enabled	
WMM Background	7	wl0	7	7/SP						Enabled	
WMM Best Effort	8	wl0	8	8/SP						Enabled	
Default Queue	33	atm0	8	8/SP	Path0					<input type="checkbox"/>	<input type="checkbox"/>

Figure 4-41

Click the **Add** button in Figure 4-41, and you can configure the QoS queue entry on the next screen as shown in Figure 4-42.

### QoS Queue Configuration

This screen allows you to configure a QoS queue and add it to a selected layer2 interface.

**Name:**

**Enable:**

**Interface:**

**Queue Precedence:**  (lower value, higher priority)

- The precedence list shows the scheduler algorithm for each precedence level.  
 - Queues of equal precedence will be scheduled based on the algorithm.  
 - Queues of unequal precedence will be scheduled based on SP.

**Scheduler Algorithm**

Weighted Round Robin  
 Weighted Fair Queuing

**Queue Weight:**  [1-63]

**DSL Latency:**

Figure 4-42

- **Name:** Set a name for the entry.
- **Enable:** Select Enable option to take this entry effect.
- **Interface:** Assigned a specific Wan Service for this QoS queue entry.
- **Precedence:** Specify precedence for this QoS queue entry.
- **DSL Latency:** Select latency path for the type of data transmission, only Path0 is available for this router.

After you specify the condition, click **Save/Apply** to save the entry and then you will see your settings as shown in Figure 4-41.

**Note:**

- 1) Lower integer values for precedence imply higher priority for this queue relative to others.
- 2) The queue entry configured here will be used by the classifier to place ingress packets appropriately.

**4.4.8.2 QoS Classification**

This section will guide you to create a traffic class rule to classify the upstream traffic, assign queue which defines the precedence and the interface and optionally overwrite the IP header DSCP byte.

A rule consists of a class name and at least one condition below. All of the specified conditions in this classification rule must be satisfied for the rule to take effect.

**QoS Classification Setup -- maximum 32 rules can be configured.**

To add a rule, click the **Add** button.  
 To remove rules, check their remove-checkboxes, then click the **Remove** button.  
 The **Enable** button will scan through every rules in the table. Rules with enable-checkbox checked will be enabled. Rules with enable-checkbox un-checked will be disabled.  
 The enable-checkbox also shows status of the rule after page reload.  
 If you disable WMM function in Wireless Page, classification related to wireless will not take effects.  
 The QoS function has been disabled. Classification rules would not take effects.

Class Name	Order	CLASSIFICATION CRITERIA											CLASSIFICATION RESULTS				Remove		
		Class Intf	Ether Type	SrcMAC/ Mask	DstMAC/ Mask	SrcIP/ PrefixLength	DstIP/ PrefixLength	Proto	SrcPort	DstPort	DSCP Check	802.1P Check	Queue Key	DSCP Mark	802.1P Mark	Enable			
ftp-class	1	LAN			00:11:22:33:44:AA										1	AF12		<input checked="" type="checkbox"/>	<input type="checkbox"/>

Figure 4-43

Click the **Add** button Figure 4-43, and you can configure the QoS on the next screen.

**Add Network Traffic Class Rule**

This screen creates a traffic class rule to classify the ingress traffic into a priority queue and optionally mark the DSCP or Ethernet priority of the packet. Click 'Save/Apply' to save and activate the rule.

**Traffic Class Name:**   
**Rule Order:**   
**Rule Status:**

**Specify Classification Criteria** (A blank criterion indicates it is not used for classification.)

**Class Interface:**   
**Ether Type:**   
**Source MAC Address:**   
**Destination MAC Address:**

**Specify Classification Results** (A blank value indicates no operation.)

**Specify Class Queue (Required):**   
 - Packets classified into a queue that exit through an interface for which the queue is not specified to exist, will instead egress to the default queue on the interface.

**Mark Differentiated Service Code Point (DSCP):**   
**Mark 802.1p priority:**

- Class non-vlan packets egress to a non-vlan interface will be tagged with VID 0 and the class rule p-bits.  
 - Class vlan packets egress to a non-vlan interface will have the packet p-bits re-marked by the class rule p-bits. No additional vlan tag is added.  
 - Class non-vlan packets egress to a vlan interface will be tagged with the interface VID and the class rule p-bits.  
 - Class vlan packets egress to a vlan interface will be additionally tagged with the packet VID, and the class rule p-bits.

Figure 4-44

After you specify the condition, click **Save/Apply** to save the entry.

### 4.4.9 Routing

Choose “**Advanced Setup**”→“**Routing**”, it includes 2 menus: **Default Gateway** and **Static Route**. The detailed descriptions are provided below.

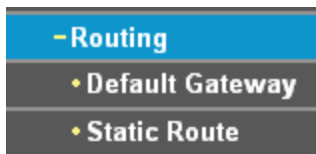

#### 4.4.9.1 Default Gateway

Choose “**Advanced Setup**”→“**Routing**”→“**Default Gateway**”, you can see the Default Gateway screen.

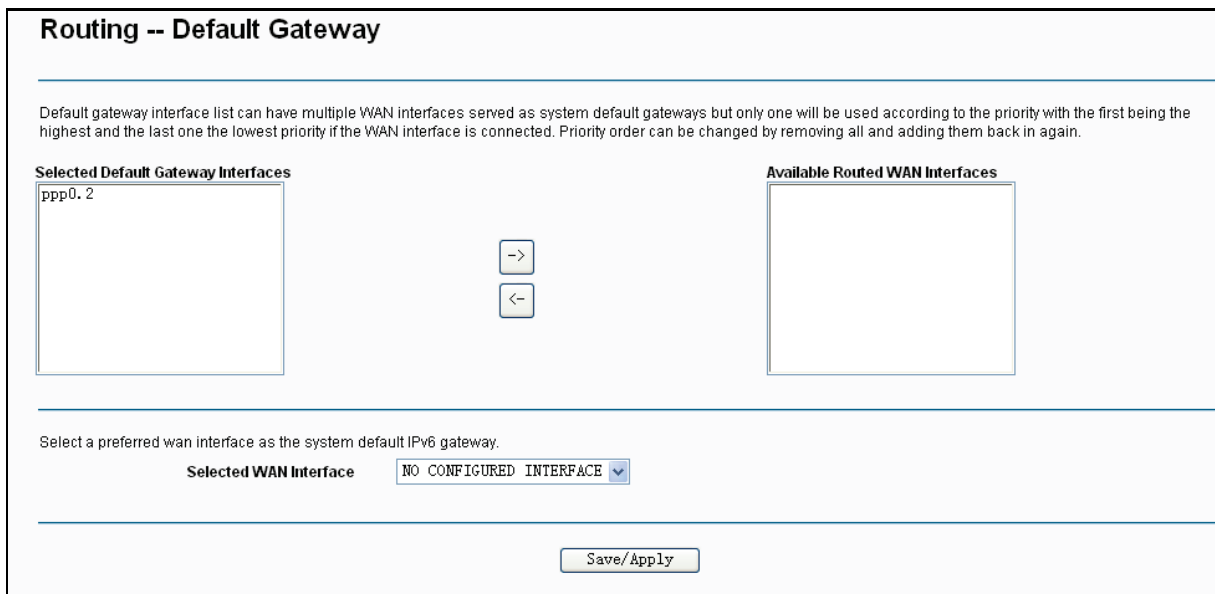

Figure 4-45

#### 4.4.9.2 Static Route

Choose “**Advanced Setup**”→“**Routing**”→“**Static Route**”. You can see the Static Route screen, this screen allows you to configure the static routes (shown in Figure 4-46). A static route is a pre-determined path that network information must travel to reach a specific host or network.

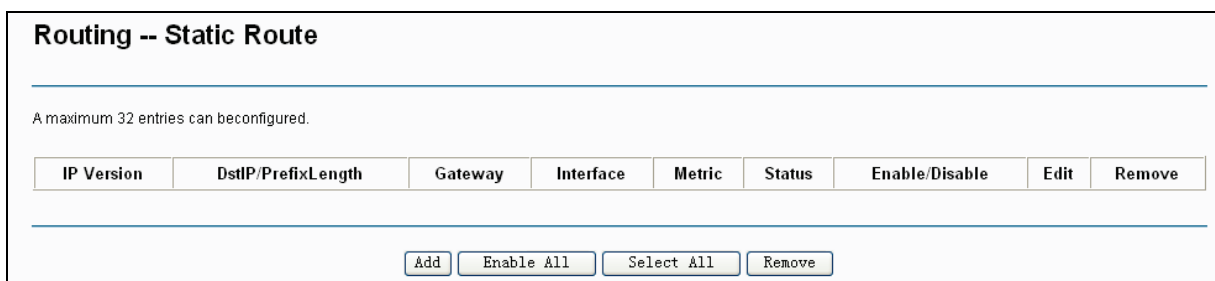

Figure 4-46

#### To add static routing entries:

1. Click the **Add** button in Figure 4-46, and you will see the screen as shown in Figure 4-47.

**Routing -- Static Route Add**

Enter the destination network address, subnet mask, gateway AND/OR available WAN interface then click "Save/Apply" to add the entry to the routing table.

**IP Version:**

**Destination IP address/prefix length:**

**Interface:**

**Gateway IP Address:**

(optional: metric number should be greater than or equal to zero)

**Metric:**

Figure 4-47

2. Enter the following data:

- **IP Version:** Select the version of IP.
- **Destination IP Address/prefix length:** The **Destination IP Address** is the address of the network or host that you want to assign to a static route.
- **Interface:** Select the Interface name in the text box, or else, the default Use Interface will be adopted for the Static Route.
- **Gateway IP Address:** If you select the IPoE or IPoA mode for **Interface**, the screen above will display this item, you should type the Gateway address correctly, and the other option for **Interface** will adopt the default Gateway address for the Static Route.

3. Click **Save/Apply** to and then you will see you settings as shown in Figure 4-46.

#### To remove a static routing entry:

1. Select the **Remove** check box according to the entry in the Figure 4-46.
2. Click the **Remove** button, and the entry will be deleted.

#### **Note:**

Gateway IP address should be correctly configured if IP based Interface (IPoE, IPoA) is selected.

### 4.4.10 DNS

When you select the connection type **PPPoE**, **PPPoA** or **IPoA** for WAN configuration, you will see the **DNS** menu in the Web-based Utility. It includes **DNS Server** and **Dynamic DNS** submenus.

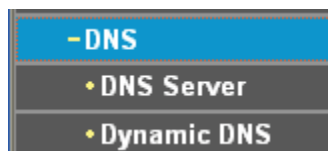

#### 4.4.10.1 DNS Server

Choose "**Advanced Setup**" → "**DNS**" → "**DNS Server**", and you can see the **DNS Server Configuration** screen as shown in Figure 4-48.

Figure 4-48

For PPPoA, PPPoE enabled PVC(s), please select the **Select DNS Server Interface from available WAN interfaces** checkbox, this modem router will accept automatically the first received DNS assignment from the selected configured WAN interface during the connection establishment.

For single PVC with IPoA, static IPoE protocol, please select the **Use the following Static DNS IP address** checkbox, and enter the primary and /or optional secondary DNS server IP addresses provided by your ISP.

Click the **Save/Apply** button to save the new configuration.

#### 4.4.10.2 Dynamic DNS

Choose **“Advanced Setup”**→**“DNS”**→**“Dynamic DNS”**, you can see the **Dynamic DNS** screen, this screen allows you to configure the Dynamic DNS (shown in Figure 4-49).

The modem router offers a Dynamic Domain Name System (**DDNS**) feature. DDNS lets you assign a fixed host and domain name to a dynamic Internet IP Address. The Dynamic DNS service allows you to alias a dynamic IP address to a static hostname in any of the many domains, allowing your modem router to be more easily accessed from various locations on the Internet.

Figure 4-49

**To add a DDNS entry:**

1. Click the **Add** button (pop-up after Figure 4-49), and then you will set the DDNS in the next screen (shown in Figure 4-50).

### Add Dynamic DNS

---

This page allows you to add a Dynamic DNS address from ThaiDDNS, DynDNS.org, TZO, or NO-IP.

D-DNS provider:

Hostname:

Interface:

ThaiDDNS Settings:

Username:

Password:

---

Figure 4-50

2. Select **D-DNS provider** in the drop-down list.
3. Enter the **Hostname** of the DNS Server, and select the corresponding **Interface** for the DDNS, you can leave it default.
4. Type the **User Name** and **Password** for your DDNS account.

Click **Save/Apply** to save your settings.

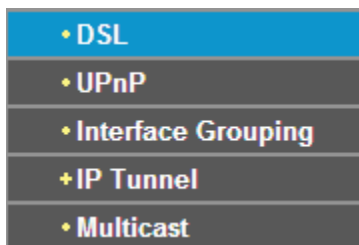
**4.4.11 DSL**

Choose “**Advanced Setup**”→“**DSL**”, you can see the DSL Settings screen, this screen allows you to configure the DSL (shown in Figure 4-51).

## DSL Settings

---

**Select the modulation below.**

- G.Dmt Enabled
- G.lite Enabled
- T1.413 Enabled
- ADSL2 Enabled
- AnnexL Enabled
- ADSL2+ Enabled
- AnnexM Enabled

---

**Select the phone line pair below.**

- Inner pair
- Outer pair

---

**Capability**

- Bitswap Enable
- SRA Enable

---

Figure 4-51

You can select the modulation type, phone line pair and the capability of Bitswap or SRA. After you set them up, click **Save/Apply** to save the configurations.

#### 4.4.12 UPnP

Choose “**Advanced Setup**”→“**UPnP**”, you can Enable or Disable the UPnP (Universal Plug and Play) protocol on the screen.

UPnP (Universal Plug and Play) is a distributed, open networking standard that uses TCP/IP for simple peer-to-peer network connectivity between devices. An UPnP device can dynamically join a network, obtain an IP address, convey its capabilities and learn about other devices on the network. In turn, a device can leave a network smoothly and automatically when it is no longer in use. UPnP broadcasts are only allowed on the LAN.

## UPnP Configuration

---

NOTE: UPnP is activated only when there is a live WAN service with NAT enabled.

- Enable UPnP protocol

---

Figure 4-52

Select the checkbox and click **Save/Apply** to enable the UPnP function.



### 4.4.13 Interface Grouping

Choose “**Advanced Setup**”→“**Interface Grouping**”, you can configure multiple ports to PVC and bridging groups to perform as an independent network.

**Interface Grouping**

---

Interface Grouping supports multiple ports to PVC and bridging groups. Each group will perform as an independent network. To support this feature, you must create mapping groups with appropriate LAN and WAN interfaces using the Add button. The Remove button will remove the grouping and add the ungrouped interfaces to the Default group. Only the default group has IP interface. A maximum 16 entries can be configured

Group Name	Remove	WAN Interface	LAN Interfaces	DHCP Vendor IDs
Default	Remove	atm0.1	LAN4/WAN	
		ppp0	LAN3	
			LAN2	
			LAN1	
			wlan0	

---

Figure 4-53

To support this feature, you must create mapping groups with appropriate LAN and WAN interfaces using the **Add** button. The **Remove** button will remove the grouping and add the ungrouped interfaces to the Default group. Only the default group has IP interface.

**To create a new interface group:**

1. Click the **Add** button. You can add a new interface group in the next screen.

### Interface grouping Configuration

To create a new interface group:

1. Enter the Group name and the group name must be unique and select either 2. (dynamic) or 3. (static) below:
2. If you like to automatically add LAN clients to a WAN Interface in the new group add the DHCP vendor ID string. By configuring a DHCP vendor ID string any DHCP client request with the specified vendor ID (DHCP option 60) will be denied an IP address from the local DHCP server.
3. Select interfaces from the available interface list and add it to the grouped interface list using the arrow buttons to create the required mapping of the ports.  
**Note that these clients may obtain public IP addresses**
4. Click Save/Apply button to make the changes effective immediately  
**IMPORTANT If a vendor ID is configured for a specific client device, please REBOOT the client device attached to the modem to allow it to obtain an appropriate IP address.**

Group Name:

WAN Interface used in the grouping:

Grouped LAN Interfaces

->

<-

Available LAN Interfaces

LAN4/WAN

LAN3

LAN2

LAN1

wlan0

wl0\_Guest1

Automatically Add Clients With the following DHCP Vendor IDs

Figure 4-54

2. Enter a unique name for Group.
3. Select the Interface which you want to use from the drop-down list.

**Note:**

If you like to automatically add LAN clients to a WAN Interface in the new group add the DHCP vendor ID string. By configuring a DHCP vendor ID string any DHCP client request with the specified vendor ID (DHCP option 60) will be denied an IP address from the local DHCP server.

4. Select interfaces from the available interface list and add it to the grouped interface list using the arrow buttons to create the required mapping of the ports.

**Note:**

These clients may obtain public IP addresses.

5. Click **Save/Apply** to make the entry effective immediately.

**Note:**

If a vendor ID is configured for a specific client device, please REBOOT the client device attached to the modem to allow it to obtain an appropriate IP address.

#### 4.4.14 IP Tunnel

IPv6 tunnel is a kind of transition mechanism to enable IPv6-only hosts to reach IPv4 services and to allow isolated IPv6 hosts and networks to reach each-other over IPv4-only infrastructure before

IPv6 completely supplants IPv4. It is a temporary solution for networks that do not support native dual-stack, where both IPv6 and IPv4 run independently.

Choose “**Advanced Setup**”→“**IP Tunnel**”, it includes two menus: **IPv6inIPv4** and **IPv4inIPv6**, The detailed descriptions are provided below.

#### 4.4.14.1 IPv6inIPv4

Choose “**Advanced Setup**”→“**IP Tunnel**”→“**IPv6inIPv4**”. You can see the 6in4 tunnel configuration screen, this screen allows you to configure the static routes (shown in Figure 4-55).

Name	WAN	LAN	Dynamic	IPv4 Mask Length	6rd Prefix	Border Relay Address	Remove
<input type="button" value="Add"/> <input type="button" value="Remove All"/> <input type="button" value="Remove"/>							

Figure 4-55

Click the **Add** button in Figure 4-55, and you can configure the 6in4 tunnel on the next screen as shown in Figure 4-56.

Currently, only 6rd configuration is supported.

**Tunnel Name:**

**Mechanism:** 6RD

**Associated WAN Interface:**

**Associated LAN Interface:** LAN/br0

Manual  Automatic

**IPv4 Mask Length:**

**6rd Prefix with Prefix Length:**

**Border Relay IPv4 Address:**

Figure 4-56

- **Mechanism:** 6RD, this type is used in the situation that your WAN connection is IPv4 while LAN connection is IPv6.
- **Associated WAN Interface:** Select a WAN connection from the drop-down list. Only the connected WAN connections can be shown in the drop-down list.
- **Associated LAN Interface:** Select a LAN connection from the drop-down list. Only the connected LAN connections can be shown in the drop-down list.
- **IPv4 Mask Length:** The length of the selected WAN connection’s IPv4 mask.
- **6rd Prefix with Prefix Length:** The length of the 6rd prefix.
- **Border Relay IPv4 Address:** The IPv4 address of the border relay router of 6RD tunnel.

Click **Save/Apply** to make the configuration take effect.

**Note:**

In this type, there should not have any IPv6 WAN connections. If there are IPv6 WAN connections, the page will prompt you to delete all the IPv6 WAN connections.

**4.4.14.2 IPv4inIPv6**

Choose “**Advanced Setup**”→“**IP Tunnel**”→“**IPv4inIPv6**”. You can see the 4in6 tunnel configuration screen, this screen allows you to configure the static routes (shown in Figure 4-57).

Name	WAN	LAN	Dynamic	AFTR	Remove

Figure 4-57

Click the **Add** button in Figure 4-57, and you can configure the 6in4 tunnel on the next screen as shown in Figure 4-58.

Currently, only DS-Lite configuration is supported.

**Tunnel Name:**   
**Mechanism:** DS-Lite   
**Associated WAN Interface:**   
**Associated LAN Interface:** LAN/br0   
 Manual  Automatic  
**AFTR:**

Figure 4-58

- **Mechanism:** DS-Lite, this type is used in the situation that your WAN connection is IPv6 while LAN connection is IPv4.
- **Associated WAN Interface:** Select a WAN connection from the drop-down list. Only the connected WAN connections can be shown in the drop-down list.
- **Associated LAN Interface:** Select a LAN connection from the drop-down list. Only the connected LAN connections can be shown in the drop-down list.
- **AFTR:** Enter the IPv6 address of the remote node.

Click **Save/Apply** to make the configuration take effect.

**Note:**

In this type, there should not have any IPv4 WAN connections. If there are IPv4 WAN connections, the page will prompt you to delete all the IPv4 WAN connections.

#### 4.4.15 Multicast

Choose “**Advanced Setup**”→“**Multicast**”, you can configure the IGMP protocol on the screen.

### IGMP Configuration

---

Enter IGMP protocol configuration fields if you want modify default values shown below.

Default Version:	3
Query Interval:	125
Query Response Interval:	10
Last Member Query Interval:	10
Robustness Value:	2

---

Figure 4-59

Click **Save/Apply** to save your settings.

#### 4.5 IPTV

### IPTV Settings

---

Enable IPTV

Please select the LAN port for IPTV connection and connect the set-top box (STB) to that port.

LAN1
  LAN2
  LAN3

Please set PVC parameters for IPTV connection.

VPI:	0	(0-255)
VCI:	35	(1-65535)

---

Figure 4-60

- **Enable IPTV:** Check this box to enable IPTV. If you enable IPTV, please make sure the following settings are correct.
- **VPI (0-255):** Identifies the virtual path between endpoints in an ATM network. The valid range is from 0 to 255. Please input the value provided by your ISP.
- **VCI (1-65535):** Identifies the virtual channel endpoints in an ATM network. The valid range is from 1 to 65535 (1 to 31 is reserved for well-known protocols). Please input the value provided by your ISP.

Click the **Save/Apply** button to save your settings.

## 4.6 Wireless

Choose “**Wireless**”, there are six submenus to configure Wireless LAN settings. Click any of them, and you will be able to configure the corresponding function. The detailed explanations for each submenu are provided below.

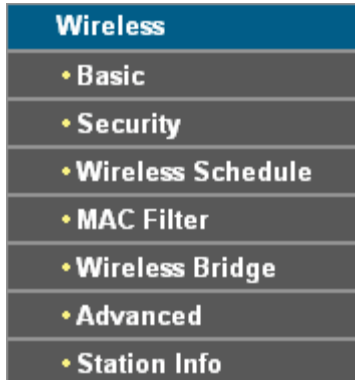

### 4.6.1 Basic

Choose “**Wireless**”→”**Basic**”, you will see the screen of **Wireless--Basic** settings shown as below. The basic settings for wireless networking are set on this screen.

#### Wireless -- Basic

---

This page allows you to configure basic features of the wireless LAN interface. You can enable or disable the wireless LAN interface, hide the network from active scans, set the wireless network name (also known as SSID) and restrict the channel set based on country requirements. Click "Save/Apply" to configure the basic wireless options.

---

Enable Wireless

Hide Access Point

Clients Isolation

SSID:

BSSID: 40:16:9f:70:b0:cc

Max Clients:

---

Figure 4-61

This page allows you to configure basic features of the wireless LAN interface. You can enable or disable the wireless LAN interface, hide the network from active scans and set the wireless network name (also known as SSID).

- **Enable Wireless:** If you want to use wireless features, you must select “Enable Wireless”. If you deselect “Enable Wireless” option, the wireless network will be disabled.
- **Hide Access Point:** When wireless clients survey the local area for wireless networks to associate with, you can select this option to avoid being surveyed.
- **Clients Isolation:** Select this option to enable AP isolation function so that stations associated to the AP will not be able to communicate with each other.

- **SSID:** SSID (Wireless network name) shared among all points in a wireless network. The SSID must be identical for all devices in the wireless network. It is case-sensitive and must not exceed 32 characters (use any of the characters on the keyboard). Make sure this setting is the same for all stations in your wireless network. Type the desired SSID in the space provided.
- **BSSID:** Show the MAC address of the router's wireless network.
- **Max Clients:** The maximum number of wireless clients that can connect to the router.

Click **Save/Apply** to save your settings.

## 4.6.2 Security

Choose “**Wireless**”→”**Security**”, you will see the screen of **Wireless--Security** settings shown as below. You can configure security features of the wireless LAN interface by manually setting the network authentication or through WPS (Wi-Fi Protected Setup) method.

**Wireless -- Security**

---

This page allows you to configure security features of the wireless LAN interface.  
 You may setup configuration manually or through WiFi Protected Setup(WPS).  
**Note:**If Hide Access Point enabled, WPS will be disabled.

---

**WPS Setup**

Enable WPS:

Add Client (This feature is available only when WPA2-PSK or OPEN mode is configured)

Push-Button   
 Enter STA PIN   
 Station's PIN:  [Help](#)  
 Use AP PIN

Device PIN:   [Help](#)

---

**Manual Setup AP**

In order to protect your network from hackers and unauthorized users, it is highly recommended you choose one of the following wireless network security settings.  
 You can set the network authentication method, selecting data encryption, specify whether a network key is required to authenticate to this wireless network and specify the encryption strength.  
**Warning: we suggest you not to set WEP encryption to "Enabled" when the device runs in 11n mode. The device's wireless highest speed is 54Mbps in that encryption type.**  
 Tips: 11n only mode are not supported when WEP encryption is "Enabled" or WPA Encryption type is "TKIP".  
 Tips: "WPA Encryption" are not allowed to set to "TKIP" when the device runs in 11n mode.  
 Click "Apply/Save" when done.

Select SSID:

Network Authentication:

WPA/WAPI passphrase:  [Click here to display](#)

WPA Group Rekey Interval:

WPA/WAPI Encryption:

WEP Encryption:

---

Figure 4-62

### 4.6.2.1 WPS Setup

This section will guide you to add a new wireless device to an existing network quickly by **WPS** (or called QSS) method.

**Note:**

- 1) This feature is available only when WPA2-PSK or OPEN mode is configured.

2) To build a successful connection by WPS, you should also do the corresponding configuration of the new device for WPS function meanwhile.

### I. By PBC

If the wireless adapter supports WPS and the Push Button Configuration (PBC) method, you can add it to the network by PBC with the following two methods. Click **Push-Button** radio box, you will see the screen as shown below.

#### Wireless -- Security

This page allows you to configure security features of the wireless LAN interface. You may setup configuration manually or through WiFi Protected Setup(WPS).  
**Note:** If Hide Access Point enabled, WPS will be disabled.

---

#### WPS Setup

Enable WPS: Enabled

Add Client (This feature is available only when WPA2-PSK or OPEN mode is configured)

Push-Button   
 Enter STA PIN

Station's PIN:  [Help](#)

Use AP PIN

Device PIN: 12345670  [Help](#)

---

#### Manual Setup AP

In order to protect your network from hackers and unauthorized users, it is highly recommended you choose one of the following wireless network security settings. You can set the network authentication method, selecting data encryption, specify whether a network key is required to authenticate to this wireless network and specify the encryption strength.  
**Warning:** we suggest you not to set WEP encryption to "Enabled" when the device runs in 11n mode. The device's wireless highest speed is 54Mbps in that encryption type.  
 Tips: 11n only mode are not supported when WEP encryption is "Enabled" or WPA Encryption type is "TKIP".  
 Tips: "WPA Encryption" are not allowed to set to "TKIP" when the device runs in 11n mode.  
 Click "Apply/Save" when done.

Select SSID: TP-LINK\_B0CD

Network Authentication: WPA2-PSK

WPA/WAPI passphrase:  [Click here to display](#)

WPA Group Rekey Interval:

WPA/WAPI Encryption: AES

WEP Encryption: Disabled

Figure 4-63

**Method One:** Hardware push button.

Step 1: Press the **WPS/RESET** button on the back panel of the router.

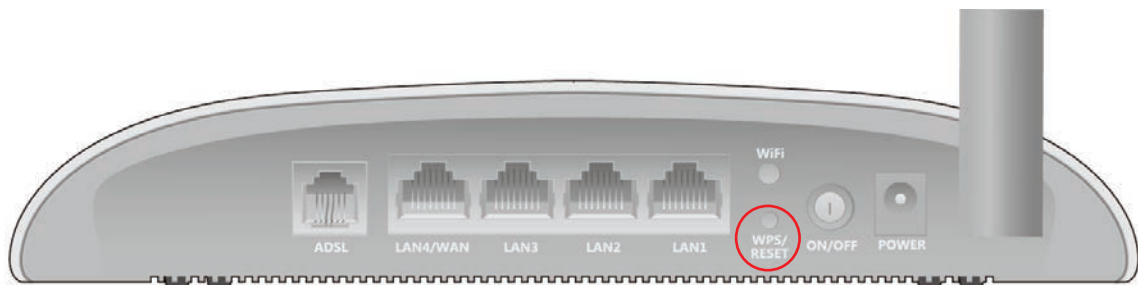



Step 2: Press and hold the WPS button of the adapter directly for 2 or 3 seconds.



Step 3: Wait for a while until the next screen of adapter appears. Click **OK** to complete the WPS configuration.



Figure 4-64

**Method Two:** Client's configuration utility

Step 1: Press the **WPS/RESET** button on the back panel of the router.

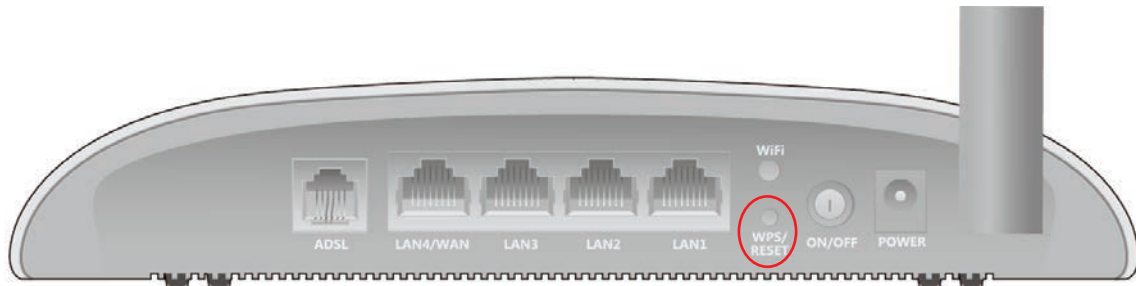

Step 2: For the configuration of the wireless adapter, please choose "**Push the button on my access point or wireless router**" in the configuration utility of the WPS as below, and click **Connect**.

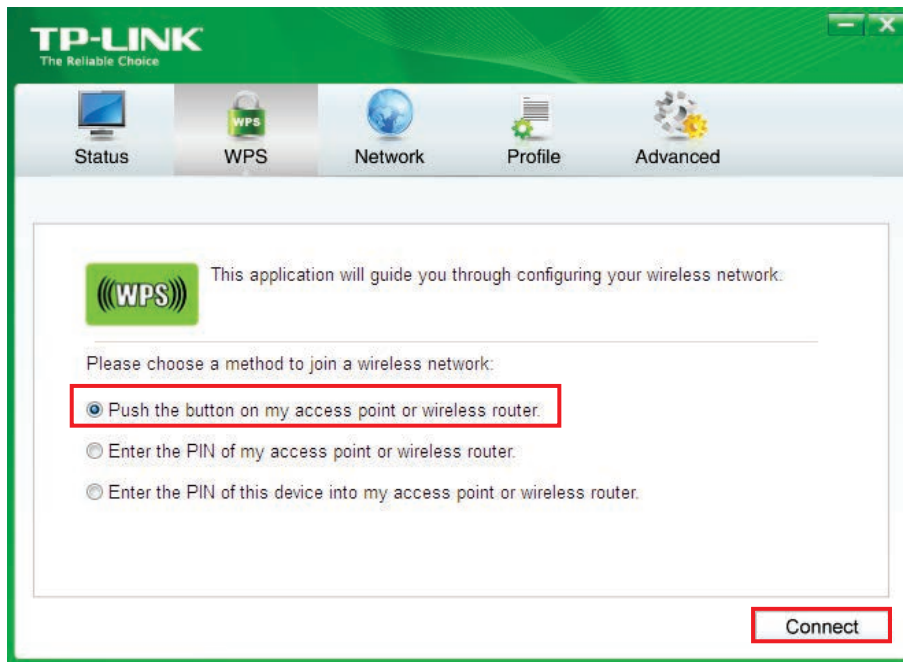

Figure 4-65

Step 3: Wait for a while until the next screen appears. Click **OK** to complete the WPS configuration.



Figure 4-66

## II. By PIN

If the new device supports Quick Security Setup and the PIN method, you can add it to the network by PIN with the following two methods.

**Method One:** Enter the PIN of wireless adapter into my router.

Step 1: Select the **Enter STA PIN** radio box and enter the PIN code of the wireless adapter in the field under as shown below. Then click **Add Enrollee**.

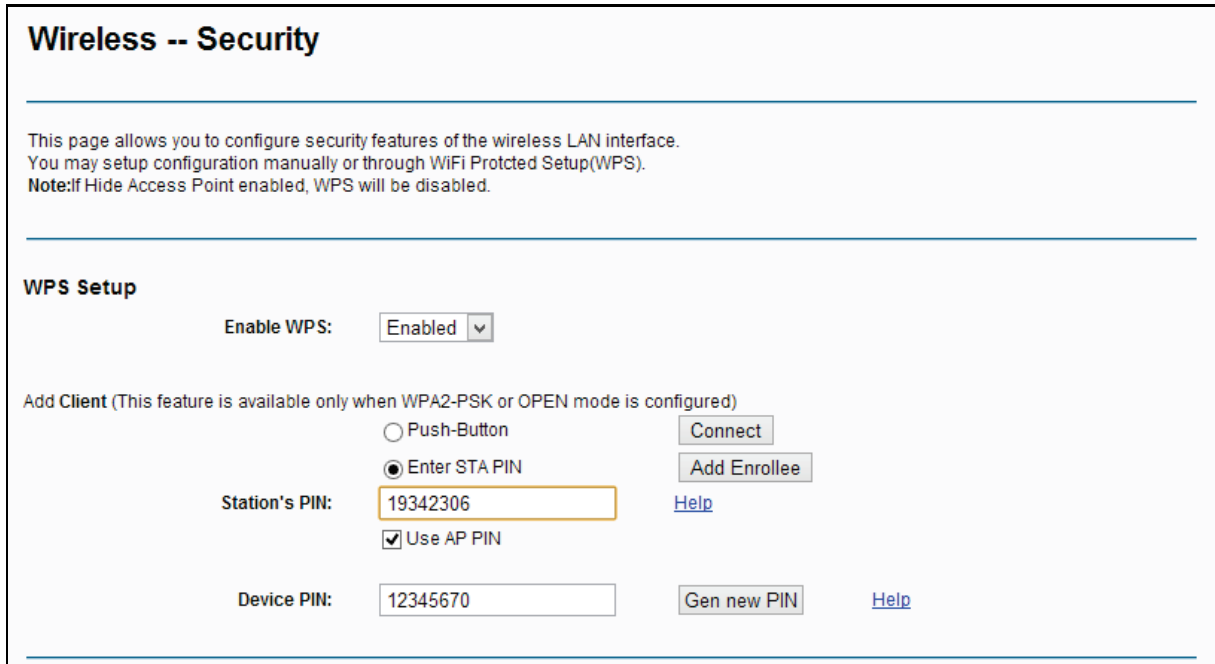

Figure 4-67

**Note:**

The PIN code of the adapter is always displayed on the WPS configuration screen.

Step 2: For the configuration of the wireless adapter, please choose **“Enter the PIN of this device into my access point or wireless router”** in the configuration utility of the WPS as below, and click **Connect**.

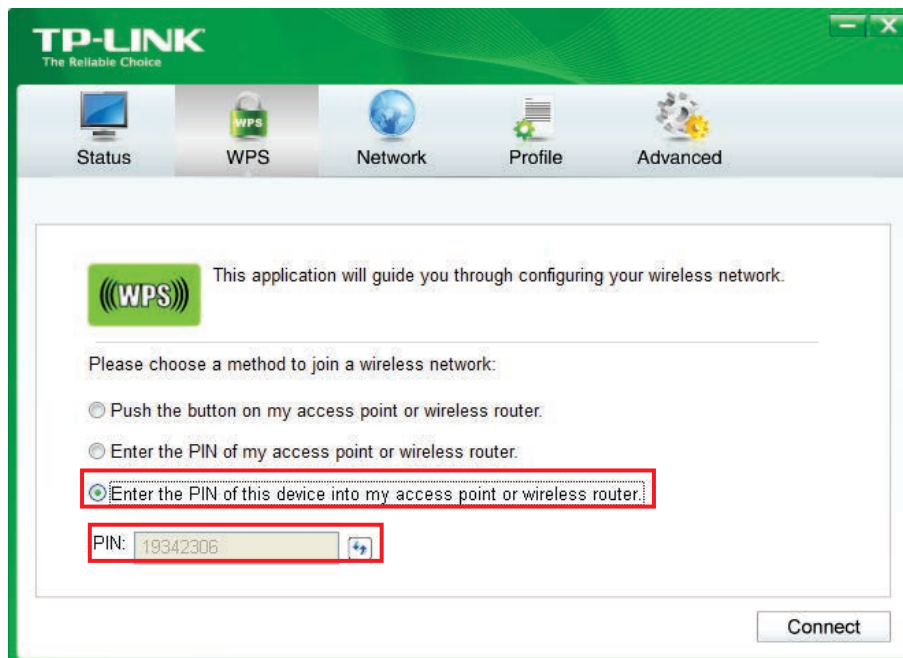

Figure 4-68

**Note:**

In this example, the default PIN code of this adapter is 19342306 as the preceding figure shown.

**Method Two:** Enter the PIN of my router into the wireless adapter.

Step 1: Select **Use AP PIN** and get the Device PIN generated by the router as shown below. You can click **Gen New PIN** to get a new PIN code for router.

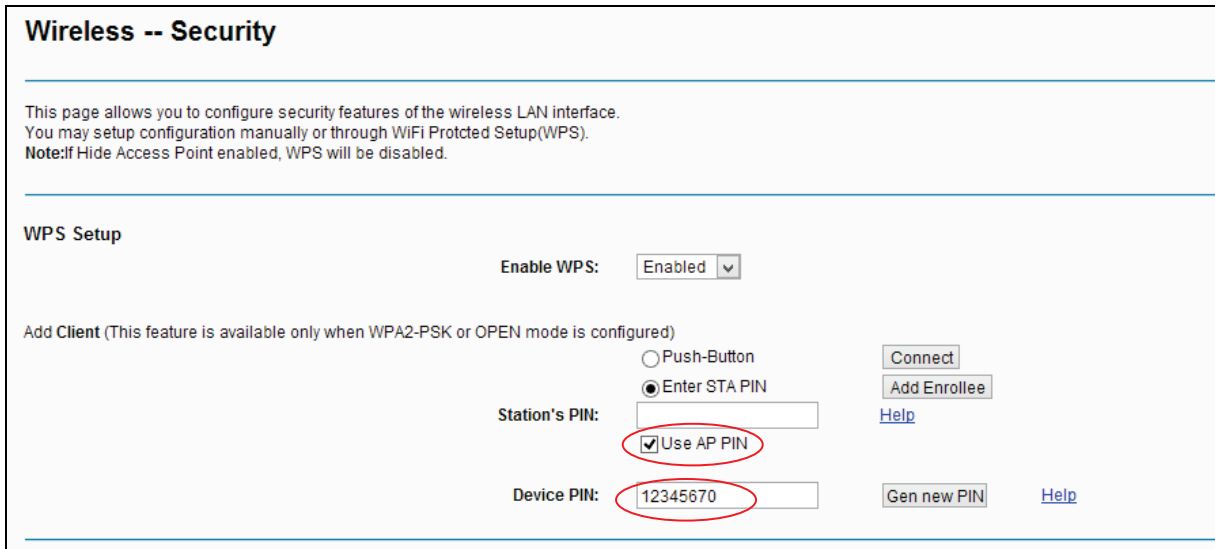

Figure 4-69

Step 2: For the configuration of the wireless adapter, please choose **Enter the PIN of my access point or wireless router** in the configuration utility of the WPS as below, and enter the PIN code of the router into the field after **“Device PIN”**. Then click **Connect**.

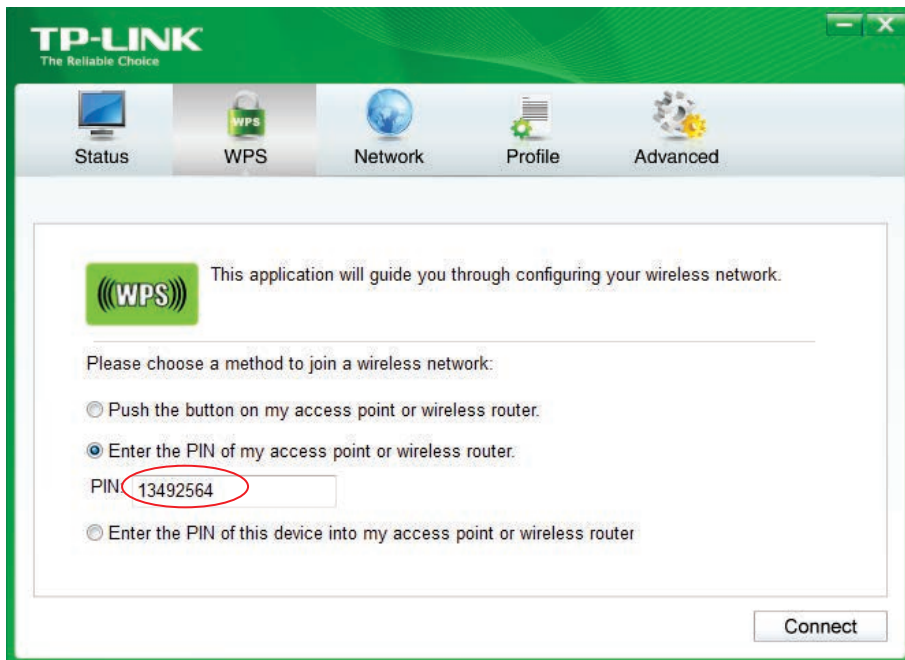

Figure 4-70

#### 4.6.2.2 Manual Setup AP

Follow the instructions below to configure security features of the wireless LAN interface manually. You can set the network authentication method, select data encryption, specify whether a network key is required to authenticate to this wireless network and specify the encryption strength.

**Manual Setup AP**

In order to protect your network from hackers and unauthorized users, it is highly recommended you choose one of the following wireless network security settings. You can set the network authentication method, selecting data encryption, specify whether a network key is required to authenticate to this wireless network and specify the encryption strength.

**Warning: we suggest you not to set WEP encryption to "Enabled" when the device runs in 11n mode. The device's wireless highest speed is 54Mbps in that encryption type.**

Tips: 11n only mode are not supported when WEP encryption is "Enabled" or WPA Encryption type is "TKIP".

Tips: "WPA Encryption" are not allowed to set to "TKIP" when the device runs in 11n mode.

Click "Apply/Save" when done.

Select SSID:

Network Authentication:

WPA/WAPI passphrase:  [Click here to display](#)

WPA Group Rekey Interval:

WPA/WAPI Encryption:

WEP Encryption:

Figure 4-71

- **Select SSID:** Select a wireless network to configure.
- **Network Authentication:** Select an authentication type from the drop-down list. Options available are: Open, Shared, WPA, WPA-PSK, WPA2, WPA2-PSK, Mixed WPA2/WPA, and Mixed WPA2/WPA-PSK.

 **Note:**

For most users, it is recommended to use the default Wireless LAN Performance settings. Any changes made to these settings may adversely affect your wireless network. Under certain circumstances, changes may benefit performance. Carefully consider and evaluate any changes to these wireless settings.

## 1. WEP

WEP is a basic encryption method offering two levels of encryption, 64-bit and 128-bit encryption. To configure the WEP encryption, there are two ways.

- Keep the Network Authentication of **Open (insecurity)** and select **Enabled** from the WEP Encryption drop-down list, as shown in Figure 4-72. **Open (insecurity)** with WEP encryption disable allows any wireless station to associate with the access point.
- Select **Shared** from the Network Authentication drop-down list, as shown in Figure 4-73. **Shared** must enable WEP encryption. Network using **Open** or **Shared** authentication with WEP encryption only allows stations using the same network key encryption to associate with it. Follow the instructions below to configure the Shared Keys.

**Manual Setup AP**

In order to protect your network from hackers and unauthorized users, it is highly recommended you choose one of the following wireless network security settings. You can set the network authentication method, selecting data encryption, specify whether a network key is required to authenticate to this wireless network and specify the encryption strength.

**Warning: we suggest you not to set WEP encryption to "Enabled" when the device runs in 11n mode. The device's wireless highest speed is 54Mbps in that encryption type.**

Tips: 11n only mode are not supported when WEP encryption is "Enabled" or WPA Encryption type is "TKIP".  
 Tips: "WPA Encryption" are not allowed to set to "TKIP" when the device runs in 11n mode.  
 Click "Apply/Save" when done.

Select SSID: TP-LINK\_B0CD

Network Authentication: Open

WEP Encryption: Enabled

Encryption Strength: 64-bit

Current Network Key: 1

Network Key 1: 1234567890123  
 Network Key 2: 1234567890123  
 Network Key 3: 1234567890123  
 Network Key 4: 1234567890123

Enter 13 ASCII characters or 26 hexadecimal digits for 128-bit encryption keys  
 Enter 5 ASCII characters or 10 hexadecimal digits for 64-bit encryption keys

Save/Apply

Figure 4-72

**Manual Setup AP**

In order to protect your network from hackers and unauthorized users, it is highly recommended you choose one of the following wireless network security settings. You can set the network authentication method, selecting data encryption, specify whether a network key is required to authenticate to this wireless network and specify the encryption strength.

**Warning: we suggest you not to set WEP encryption to "Enabled" when the device runs in 11n mode. The device's wireless highest speed is 54Mbps in that encryption type.**

Tips: 11n only mode are not supported when WEP encryption is "Enabled" or WPA Encryption type is "TKIP".  
 Tips: "WPA Encryption" are not allowed to set to "TKIP" when the device runs in 11n mode.  
 Click "Apply/Save" when done.

Select SSID: TP-LINK\_B0CD

Network Authentication: Shared

WEP Encryption: Enabled

Encryption Strength: 64-bit

Current Network Key: 1

Network Key 1: 1234567890123  
 Network Key 2: 1234567890123  
 Network Key 3: 1234567890123  
 Network Key 4: 1234567890123

Enter 13 ASCII characters or 26 hexadecimal digits for 128-bit encryption keys  
 Enter 5 ASCII characters or 10 hexadecimal digits for 64-bit encryption keys

Save/Apply

Figure 4-73

- **Encryption strength:** Select the appropriate level of encryption, 64-bit or 128-bit.
- **Current Network Key:** To indicate which WEP key to use, select a transmission key number.
- **Network Key 1-4:** If you want to manually enter the WEP keys, then enter them in the network Key 1-4 fields.

### Configure WEP Settings

1. Select **Shared** from the **Network Authentication** drop-down list. The menu will change to offer the appropriate settings.
2. Select **64-bit** from the **WEP Encryption** drop-down list.
3. Select **"1"** from **Current Network Key** drop-down list.
4. Type in the password in the **Network Key 1** field.
5. Click **Save/Apply** to save the new configuration.

**Manual Setup AP**

In order to protect your network from hackers and unauthorized users, it is highly recommended you choose one of the following wireless network security settings. You can set the network authentication method, selecting data encryption, specify whether a network key is required to authenticate to this wireless network and specify the encryption strength. **Warning, we suggest you not to set WEP encryption to "Enabled" when the device runs in 11n mode. The device's wireless highest speed is 54Mbps in that encryption type.**

Tips: 11n only mode are not supported when WEP encryption is "Enabled" or WPA Encryption type is "TKIP".  
 Tips: "WPA Encryption" are not allowed to set to "TKIP" when the device runs in 11n mode.  
 Click "Apply/Save" when done.

Select SSID: TP-LINK\_B0CD

Network Authentication: Shared

WEP Encryption: Enabled

Encryption Strength: 64-bit

Current Network Key: 1

Network Key 1:	1234567890
Network Key 2:	1234567890123
Network Key 3:	1234567890123
Network Key 4:	1234567890123

Enter 13 ASCII characters or 26 hexadecimal digits for 128-bit encryption keys  
 Enter 5 ASCII characters or 10 hexadecimal digits for 64-bit encryption keys

Save/Apply

Figure 4-74

**Note:**

We use **Network Authentication Shared, Encryption Strength 64-bit, Current Network Key "1"** and enter 10 hexadecimal digits "1234567890" in the **Network Key 1** for example, as shown in Figure 4-74 above.

## 2. WPA

WPA security for wireless communication has been developed to overcome some of the shortcomings of WEP. WPA combines the key generation with the authentication services of a RADIUS server.

**Manual Setup AP**

In order to protect your network from hackers and unauthorized users, it is highly recommended you choose one of the following wireless network security settings. You can set the network authentication method, selecting data encryption, specify whether a network key is required to authenticate to this wireless network and specify the encryption strength.

**Warning, we suggest you not to set WEP encryption to "Enabled" when the device runs in 11n mode. The device's wireless highest speed is 54Mbps in that encryption type.**

Tips: 11n only mode are not supported when WEP encryption is "Enabled" or WPA Encryption type is "TKIP".

Tips: "WPA Encryption" are not allowed to set to "TKIP" when the device runs in 11n mode.

Click "Apply/Save" when done.

Select SSID: TP-LINK\_B0CD

Network Authentication: WPA

WPA Group Rekey Interval: 0

RADIUS Server IP Address: 0.0.0.0

RADIUS Port: 1812

RADIUS Key: \*\*\*\*\*

WPA/WAPI Encryption: TKIP+AES

WEP Encryption: Disabled

Save/Apply

Figure 4-75

- **WPA Group ReKey Interval:** Enter the Key Renewal period, which tells the router how often it should change encryption keys.
- **RADIUS Server IP Address:** The IP address of the RADIUS server.
- **RADIUS Port:** The port of the RADIUS server. The default number is 1812.
- **RADIUS key:** The password of the RADIUS Server.
- **WPA Encryption:** Select the encryption you want to use: TKIP or AES (AES is an encryption method stronger than TKIP).

### Configure WPA settings

1. Select **WPA** from the **Network Authentication** drop-down list. The menu will change to offer the appropriate settings.
2. Change the **WPA Group Rekey Interval** as desired.
3. Type in the IP address of the RADIUS server used in the **RADIUS Server IP Address** field.
4. Change the **RADIUS Port** if necessary.
5. Type in the password in the **RADIUS Key** field.
6. Use the default setting **AES** of WPA Encryption.
7. Click **Save/Apply** to save the new configuration.



**Manual Setup AP**

In order to protect your network from hackers and unauthorized users, it is highly recommended you choose one of the following wireless network security settings. You can set the network authentication method, selecting data encryption, specify whether a network key is required to authenticate to this wireless network and specify the encryption strength.

**Warning: we suggest you not to set WEP encryption to "Enabled" when the device runs in 11n mode. The device's wireless highest speed is 54Mbps in that encryption type.**

Tips: 11n only mode are not supported when WEP encryption is "Enabled" or WPA Encryption type is "TKIP".  
 Tips: "WPA Encryption" are not allowed to set to "TKIP" when the device runs in 11n mode.  
 Click "Apply/Save" when done.

Select SSID: TP-LINK\_B0CD

Network Authentication: WPA

WPA Group Rekey Interval: 30

RADIUS Server IP Address: 192.168.1.20  
 RADIUS Port: 1812  
 RADIUS Key: .....

WPA/WAPI Encryption: AES

WEP Encryption: Disabled

Save/Apply

Figure 4-76

### 3. WPA-PSK

WPA-PSK requires a shared key and does not use a separate server for authentication. PSK keys can be ASCII or Hex type.

**Manual Setup AP**

In order to protect your network from hackers and unauthorized users, it is highly recommended you choose one of the following wireless network security settings. You can set the network authentication method, selecting data encryption, specify whether a network key is required to authenticate to this wireless network and specify the encryption strength.

**Warning: we suggest you not to set WEP encryption to "Enabled" when the device runs in 11n mode. The device's wireless highest speed is 54Mbps in that encryption type.**

Tips: 11n only mode are not supported when WEP encryption is "Enabled" or WPA Encryption type is "TKIP".  
 Tips: "WPA Encryption" are not allowed to set to "TKIP" when the device runs in 11n mode.  
 Click "Apply/Save" when done.

Select SSID: TP-LINK\_B0CD

Network Authentication: WPA-PSK

WPA/WAPI passphrase:  [Click here to display](#)

WPA Group Rekey Interval: 30

WPA/WAPI Encryption: TKIP+AES

WEP Encryption: Disabled

Save/Apply

Figure 4-77

- **WPA/WAPI passphrase:** WPA/WAPI passphrase is also called Wireless Network Key. In this field, enter the key shared by the router and your other network devices. It must have 8-63 ASCII characters or 8-64 Hexadecimal digits.
- **Click here to display:** Click it to show you the WPA Pre-Shared Key.

#### Configure WPA-PSK settings

1. Select **WPA-PSK**. The menu will change to offer the appropriate settings as the picture show above.
2. WPA-Personal requires a shared key. Type the key in the space provided. PSK keys can be ASCII or Hex type.
3. Change the Group Key Interval as desired or use the default setting.
4. Click **Save/Apply** to save the new configuration.

**Manual Setup AP**

In order to protect your network from hackers and unauthorized users, it is highly recommended you choose one of the following wireless network security settings. You can set the network authentication method, selecting data encryption, specify whether a network key is required to authenticate to this wireless network and specify the encryption strength.  
**Warning: we suggest you not to set WEP encryption to "Enabled" when the device runs in 11n mode. The device's wireless highest speed is 54Mbps in that encryption type.**  
 Tips: 11n only mode are not supported when WEP encryption is "Enabled" or WPA Encryption type is "TKIP".  
 Tips: "WPA Encryption" are not allowed to set to "TKIP" when the device runs in 11n mode.  
 Click "Apply/Save" when done.

Select SSID: TP-LINK\_B0CD

Network Authentication: WPA-PSK

WPA/WAPI passphrase: ..... [Click here to display](#)

WPA Group Rekey Interval: 30

WPA/WAPI Encryption: TKIP+AES

WEP Encryption: Disabled

Save/Apply

Figure 4-78

**Note:**

If you click the option "Click here to display", the Figure 4-79 will pop-up, and it shows the password you have set. In addition, it won't show the blank characters in both ends of the password phrase.

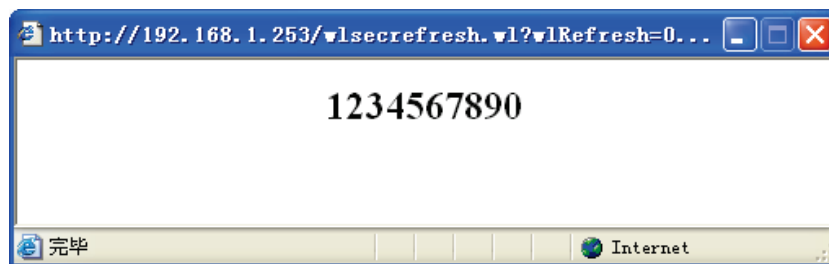

Figure 4-79

**4. WPA2**

To configure WPA2, select the WPA2 option from the drop-down list. The menu will change to offer the appropriate settings. The steps of these settings are similar to WPA settings.

**Manual Setup AP**

In order to protect your network from hackers and unauthorized users, it is highly recommended you choose one of the following wireless network security settings. You can set the network authentication method, selecting data encryption, specify whether a network key is required to authenticate to this wireless network and specify the encryption strength.  
**Warning: we suggest you not to set WEP encryption to "Enabled" when the device runs in 11n mode. The device's wireless highest speed is 54Mbps in that encryption type.**  
 Tips: 11n only mode are not supported when WEP encryption is "Enabled" or WPA Encryption type is "TKIP".  
 Tips: "WPA Encryption" are not allowed to set to "TKIP" when the device runs in 11n mode.  
 Click "Apply/Save" when done.

Select SSID: TP-LINK\_B0CD

Network Authentication: WPA2

WPA2 Preauthentication: Disabled

Network Re-auth Interval: 36000

WPA Group Rekey Interval: 0

RADIUS Server IP Address: 0.0.0.0

RADIUS Port: 1812

RADIUS Key:

WPA/WAPI Encryption: AES

WEP Encryption: Disabled

Save/Apply

Figure 4-80

- **WPA2 Preauthentication:** Select Enable from the drop-down list, Stations will authenticate with the AP during the scanning process, and once association is required, the station has been already authenticated.
- **Network Re-auth Interval:** Enter a value in seconds as the frequency interval to enable periodic Network Re-authentication function, while leave it blank or enter “0” to disable it.

## 5. WPA2 -PSK

To configure WPA2 -PSK settings, select the WPA2 -PSK option from the drop-down list. The menu will change to offer the appropriate settings. WPA2 -PSK requires a shared key and does not use a separate server for authentication. PSK keys can be ASCII or Hex type.

**Manual Setup AP**

In order to protect your network from hackers and unauthorized users, it is highly recommended you choose one of the following wireless network security settings. You can set the network authentication method, selecting data encryption, specify whether a network key is required to authenticate to this wireless network and specify the encryption strength.  
**Warning: we suggest you not to set WEP encryption to "Enabled" when the device runs in 11n mode. The device's wireless highest speed is 54Mbps in that encryption type.**  
 Tips: 11n only mode are not supported when WEP encryption is "Enabled" or WPA Encryption type is "TKIP".  
 Tips: "WPA Encryption" are not allowed to set to "TKIP" when the device runs in 11n mode.  
 Click "Apply/Save" when done.

Select SSID:

Network Authentication:

WPA/WAPI passphrase:  [Click here to display](#)

WPA Group Rekey Interval:

WPA/WAPI Encryption:

WEP Encryption:

Figure 4-81

## 6. Mixed WPA2/WPA

To configure Mixed WPA2/WPA settings, select the Mixed WPA2/WPA option from the drop-down list. The menu will change to offer the appropriate settings. The steps to these settings are similar to those for WPA-PSK.

**Manual Setup AP**

In order to protect your network from hackers and unauthorized users, it is highly recommended you choose one of the following wireless network security settings. You can set the network authentication method, selecting data encryption, specify whether a network key is required to authenticate to this wireless network and specify the encryption strength.  
**Warning: we suggest you not to set WEP encryption to "Enabled" when the device runs in 11n mode. The device's wireless highest speed is 54Mbps in that encryption type.**  
 Tips: 11n only mode are not supported when WEP encryption is "Enabled" or WPA Encryption type is "TKIP".  
 Tips: "WPA Encryption" are not allowed to set to "TKIP" when the device runs in 11n mode.  
 Click "Apply/Save" when done.

Select SSID:

Network Authentication:

WPA2 Preauthentication:

Network Re-auth Interval:

WPA Group Rekey Interval:

RADIUS Server IP Address:

RADIUS Port:

RADIUS Key:

WPA/WAPI Encryption:

WEP Encryption:

Figure 4-82

## 7. Mixed WPA2/WPA -PSK

To configure Mixed WPA2/WPA -PSK settings, select the Mixed WPA2/WPA -PSK option from the drop-down list. The menu will change to offer the appropriate settings. The steps of this setting are the same with WPA-PSK.

**Manual Setup AP**

In order to protect your network from hackers and unauthorized users, it is highly recommended you choose one of the following wireless network security settings. You can set the network authentication method, selecting data encryption, specify whether a network key is required to authenticate to this wireless network and specify the encryption strength.  
**Warning: we suggest you not to set WEP encryption to "Enabled" when the device runs in 11n mode. The device's wireless highest speed is 54Mbps in that encryption type.**  
 Tips: 11n only mode are not supported when WEP encryption is "Enabled" or WPA Encryption type is "TKIP".  
 Tips: "WPA Encryption" are not allowed to set to "TKIP" when the device runs in 11n mode.  
 Click "Apply/Save" when done.

Select SSID:

Network Authentication:

WPA/WAPI passphrase:  [Click here to display](#)

WPA Group Rekey Interval:

WPA/WAPI Encryption:

WEP Encryption:

Figure 4-83

### 4.6.3 Wireless Schedule

Choose menu “Wireless”→“Wireless Schedule”, you can configure the Task Schedule as shown below.

**Wireless -- Schedule**

Schedule can be set on this page.  
 Click the schedule table or use the 'Add' button to choose the period on which you need the wireless off automatically!  
 Schedule does not work while system time is not set. [Click here](#) to set system time.

Wireless Schedule:  Enable  Disable

Apply To:

Start Time:

End Time:

Time	0:00	1:00	2:00	3:00	4:00	5:00	6:00	7:00	8:00	9:00	10:00	11:00	12:00	13:00	14:00
Sun.															
Mon.															
Tues.															
Wed.															
Thur.															
Fri.															
Sat.															

Figure 4-84

**Note:**

The time you set is the period you need the wireless off.

Before configure the wireless schedule, please set system time first which refer to [4.8.5 Internet Time](#), then you can enable or disable Wireless Schedule.

- **Apply To:** Select the day or days you need the wireless off.
- **Start Time, End Time:** You can select all day-24 hours or you may enter the **Start Time** and **End Time** in the corresponding field.

➤ **Add:** Click this button to add your selected time to the below table.

Click the **Clear Schedule** button to clear your settings in the table.

Click **Save** to complete the settings.

#### 4.6.4 MAC Filter

Choose “**Wireless**”→”**MAC Filter**”, you will see the screen of **Wireless--MAC Filter** settings shown as below.

Figure 4-85

Wireless access can be filtered by using the MAC addresses of the wireless devices transmitting within your network’s RADIUS. To filter wireless users by MAC Address, either permitting or blocking access. If you do not wish to filter users by MAC Address, select Disabled.

- **Disabled:** Select this option to disable MAC Filter function.
- **Allow:** Select this option to enable MAC Filter function that allow wireless access by the devices listed on this screen.
- **Deny:** Select this option to enable MAC Filter function that block wireless access from the devices listed on this screen.
- **Add:** Click this button to add the MAC Address.
- **Remove:** Select the item of the MAC Address and click this button to remove it.

When you click the **Add** button, the pop-up picture shown below, and then you can type the MAC Address in the **MAC Address** field.

 **Note:**

The form of MAC Address must be “**xx:xx:xx:xx:xx:xx**”, like “**00:13:0A:55:FF:09**”.

Figure 4-86

When you finished making changes to the MAC Filter List screen, click **Save/Apply** to save the changes.

### 4.6.5 Wireless Bridge

Choose “Wireless”→”Wireless Bridge”, you will see the screen of **Wireless--Bridge** settings shown as below. You can configure wireless bridge features of the wireless LAN interface and click **Save/Apply** button to save the current configuration.

#### Wireless -- Bridge

---

This page allows you to configure wireless bridge features of the wireless LAN interface. You can select Wireless Bridge (also known as Wireless Distribution System) to disable access point functionality. Selecting Access Point enables access point functionality. Wireless bridge functionality will still be available and wireless stations will be able to associate to the AP. Select Disabled in Bridge Restrict which disables wireless bridge restriction. Any wireless bridge will be granted access. Selecting Enabled or Enabled(Scan) enables wireless bridge restriction. Only those bridges selected in Remote Bridges will be granted access.  
 Click "Refresh" to update the remote bridges. Wait for few seconds to update.  
 Click "Save/Apply" to configure the wireless bridge options.

**Tip1: Only "Open" or "Shared" Network Authentication support Wireless Bridge.**  
**If you want remote wireless devices connect to this router by bridge Mode, set the Network Authentication to "Open" or "Shared" first!**  
**Tip2: Other APs can bridge to device Only with the same channel as device.**

**AP Mode:**

**Bridge Restrict:**

---

Figure 4-87

- **AP Mode:** Select an AP Mode from the drop-down list. Options available are: Access Point and Wireless Bridge.
  - **Access Point:** Select this option to allow wireless stations including AP clients to access.
  - **Wireless Bridge:** Also known as WDS (Wireless Distribution System), it will bridge the wireless stations in bridge mode.
- **Bridge Restrict:**
  - **Disabled:** Select this option to disables wireless bridge restriction, that any wireless bridge will be granted access.
  - **Enabled:** Select this option (as shown below) to enables wireless bridge restriction, please enter the MAC address of the Remote Bridges that you want to connect with, and only these Remote Bridges are granted access.

**AP Mode:**

**Bridge Restrict:**

**Remote Bridges MAC Address:**

---

Figure 4-88

- **Enabled (Scan):** Select this option to enables wireless bridge restriction, and it will scan the environment for APs that exist around the device. Only those selected AP will be granted access.
- **Refresh:** Click this button to scan and display the APs.

AP Mode:

Bridge Restrict:

Remote Bridges MAC Address:

	SSID	BSSID
<input type="checkbox"/>	TP-LINK_341108	00:11:22:34:11:08
<input type="checkbox"/>	TP-LINK_334434	00:11:22:33:44:34
<input type="checkbox"/>	TP-LINK_4BFA6A	90:F6:52:4B:FA:6A
<input type="checkbox"/>	TP-LINK_130969	00:0A:EB:13:09:69
<input type="checkbox"/>	TP-LINK_BF5101	40:16:9F:BF:51:01
<input type="checkbox"/>	TP-LINK_BF6005	D8:5D:4C:BF:60:05

Figure 4-89

**Note:**

Only Open or Shared authentication method support wireless bridge, you should choose “Wireless”→“Security” to change authentication method to “open” or “shared” mode first.

**4.6.6 Advanced**

Choose “Wireless”→“Advanced”, you will see the screen of **Wireless--Advanced** settings shown as below.

**Wireless -- Advanced**

---

This page allows you to configure advanced features of the wireless LAN interface. You can select a particular channel on which to operate, set the fragmentation threshold, set the RTS threshold, set the wakeup interval for clients in power-save mode, set the beacon interval for the access point and set whether short or long preambles are used. Click “Save/Apply” to configure the advanced wireless options.

---

Channel:  Current: 1 (interference: acceptable)

Mode:

Bandwidth:

Fragmentation Threshold:

RTS Threshold:

DTIM Interval:

Beacon Interval:

Transmit Power:

WMM(Wi-Fi Multimedia):

---

Figure 4-90

- **Channel:** Select the channel you want to use from the drop-down List. This field determines which operating frequency will be used. It is not necessary to change the wireless channel unless you notice interference problems with another nearby access point.
- **Mode:** In the drop-down list you can select “11b”, “11bg”, “11bgn” and “11n only”. “11bgn” allows both 802.11b, 802.11g and 802.11n wireless stations to connect to the router.
- **Bandwidth:** Select the Bandwidth you want to use from the drop-down List. If bigger bandwidth is selected, device could transmit and receive data with higher speed.

- **Fragmentation Threshold:** This value specifies the maximum size for a packet before data is fragmented into multiple packets. If you experience a high packet error rate, you may slightly increase the Fragmentation Threshold. Setting the Fragmentation Threshold too low may result in poor network performance. Only minor reduction of the default value is recommended. In most cases, it should remain at its default value of 2346.
- **RTS Threshold:** Should you encounter inconsistent data flow, only minor reduction of the default value 2347 is recommended. If a network packet is smaller than the preset RTS threshold size, the RTS/CTS mechanism will not be enabled. The router sends Request to Send (RTS) frames to a particular receiving station and negotiates the sending of a data frame. After receiving an RTS, the wireless station responds with a Clear to Send (CTS) frame to acknowledge the right to begin transmission. This mechanism can provide you a quiet communication channel by notifying other stations not to send packet for a period of time. In most cases, keep its default value of 2347.
- **DTIM Interval:** This value, between 1 and 255, indicates the interval of the Delivery Traffic Indication Message (DTIM). A DTIM field is a countdown field informing clients of the next window for listening to broadcast and multicast messages. The countdown unit is measured by the amounts of beacon frames received. When the router has buffered broadcast or multicast messages for associated clients, it sends the next DTIM with a DTIM Interval value. Its clients hear the beacons and awaken to receive the broadcast and multicast messages. The default value is 1.
- **Beacon Interval:** Enter a value between 20-1000 milliseconds. The beacons are the packets sent by the modem router to synchronize a wireless network. Beacon Interval value determines the time interval of the beacons. The default value is 100.
- **Transmit Power:** This option will allow you to configure the wireless transmit power. High transmit power will extend the wireless signal range of the device and make the signal transmit more legible. Low transmit power with the smaller wireless signal range that will decrease the probability of interrupt by other Wi-Fi device.
- **WMM (Wi-Fi Multimedia):** This function can guarantee the packets with high-priority messages being transmitted preferentially. It is strongly recommended.

#### 4.6.7 Station info

Choose “Wireless”→“Station Info”, you will see the screen of **Wireless--Authenticated Stations** setting shown as below.

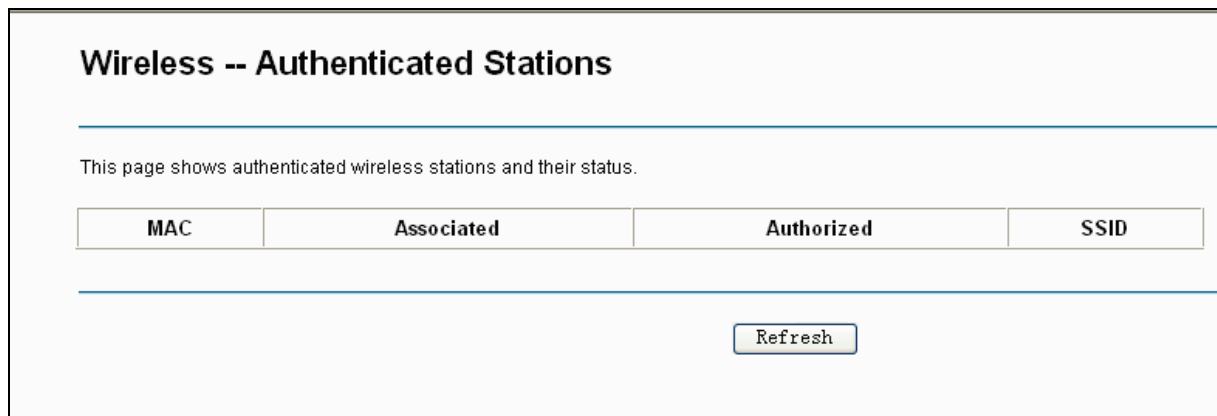

Figure 4-91

This page shows authenticated wireless stations and their status.



- **MAC:** Displays the connected wireless station's MAC address.
- **Associated:** Displays whether the wireless station has associated with the access point.
- **Authorized:** Displays the information of Authentication.
- **SSID:** Displays the connected wireless station's SSID.

You cannot change any of the values on this page. To update this page and to show the current connected wireless stations, click on the **Refresh** button.

## 4.7 Guest Network



There are two submenus under the Guest Network menu: **Basic** and **Station list**. Click any of them, and you will be able to scan or configure the corresponding function. The detailed explanations for each submenu are provided below.

### 4.7.1 Basic

Choose menu "**Guest Network**"→"**Basic**", and you will see the screen as shown in Figure 4-92. This feature allows you to create a separate network for your guests without allowing them to access your main network and the computers connected to it.

 A screenshot of a web configuration page titled "Wireless -- Guest Network". The page contains the following fields and options:
 

- Guest Network:** Radio buttons for "Enable" (selected) and "Disable".
- Guest SSID:** Text input field containing "TP-LINK\_Guest\_B0CD".
- Authentication Type:** Drop-down menu showing "WPA-PSK".
- Encryption:** Drop-down menu showing "AES+TKIP".
- Wireless Password:** Text input field. To its right, text reads: "(Enter ASCII characters between 8 and 63 or Hexadecimal characters between 8 and 64.)". Below the field is a blue link: "Click here to display".
- Group Key Update Period:** Text input field containing "0". To its right, text reads: "(second, minimum is 30, 0 means no update.)".
- Allow Guest To Access My Local Network:** Drop-down menu showing "Disabled".
- Guest Network Isolation:** Drop-down menu showing "Disabled".

 At the bottom center of the page is a "Save/Apply" button.

Figure 4-92

You can enable or disable Guest Network. When you enable this function, you could set wireless parameters for Guest Network.

- **Guest SSID:** The guest network name. When setting up a Guest network, it is strongly recommended to use a name that easily distinguishes it from your primary network.
- **Authentication Type:** Select the Authentication Type from the drop-down list.

- **Encryption:** You can select either **AES**, or **AES+TKIP**.
- **Wireless Password:** Enter the wireless password for the Guest Network as you like. You also can click **Click here to display** to see the wireless password.
- **Group Key Update Period:** Specify the group key update interval in seconds. The value should be 30 or above. Enter 0 to disable the update.
- **Allow Guest To Access My Local Network:** The guests have access to your Local Network, but cannot login the modem router's web management interface.
- **Guest Network Isolation:** This function can isolate wireless clients on your guest network from each other. Client isolation is disabled by default.

Click **Save/Apply** to save your settings.

#### 4.7.2 Station list

Choose menu "**Guest Network**"→"**Station list**", you can see the MAC Address, Associated, Authorized and SSID.

**Wireless -- Authenticated Stations**

---

This page shows authenticated wireless stations and their status.

MAC	Associated	Authorized	SSID

Figure 4-93

- **MAC:** Displays the connected wireless station's MAC address.
- **Associated:** Displays whether the wireless station has associated with the access point.
- **Authorized:** Displays the information of Authentication.
- **SSID:** Displays the connected wireless network's SSID.

You cannot change any of the values on this page. To update this page and to show the current connected wireless stations, click on the **Refresh** button.

## 4.8 Diagnostics

Choose "**Diagnostics**", you will see the Diagnostics screen. This section describes the result of the test for the ENET (Ethernet) Connection, Wireless Connection and ADSL Synchronization. You can refer to the **Help** menu to get more information about the corresponding test.

**br\_0\_8\_35 Diagnostics**

---

Your modem is capable of testing your DSL connection. The individual tests are listed below. If a test displays a fail status, click "Rerun Diagnostic Tests" at the bottom of this page to make sure the fail status is consistent. If the test continues to fail, click "Help" and follow the troubleshooting procedures.

---

Test the connection to your local network

Test your LAN1 Connection:	FAIL	<a href="#">Help</a>
Test your LAN2 Connection:	PASS	<a href="#">Help</a>
Test your LAN3 Connection:	FAIL	<a href="#">Help</a>
Test your LAN4/WAN Connection:	FAIL	<a href="#">Help</a>
Test your Wireless Connection:	PASS	<a href="#">Help</a>

---

Test the connection to your DSL service provider

Test xDSL Synchronization:	FAIL	<a href="#">Help</a>
Test ATM OAM F5 segment ping:	DISABLED	<a href="#">Help</a>
Test ATM OAM F5 end-to-end ping:	DISABLED	<a href="#">Help</a>

---

Figure 4-94

## 4.9 Management

Choose "Management", there are eight submenus under the main menu. They are **Settings**, **System Log**, **SNMP Agent**, **TR-069 Client**, **Internet Time**, **Access Control**, **Update Firmware** and **Reboot**. Click any of them, and you will be able to configure the corresponding function.

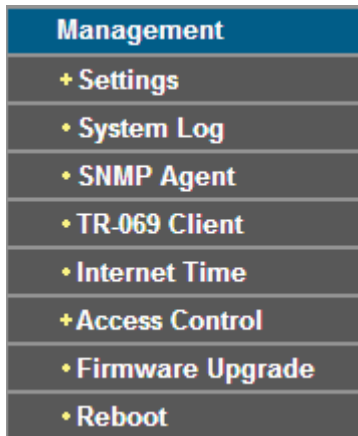

### 4.9.1 Settings

This section provides three important functions for managing the router; they are **Export**, **Import** and **Restore Default** (shown in Figure 4-95). The detailed manipulations are described below.

**Settings - Export**

---

Backup DSL Modem Router configurations. You may save your router configurations to a file on your PC.

---

Figure 4-95

#### 4.9.1.1 Export

Choose “**Management**”→“**Settings**”→“**Export**”, you can see the **Export** screen, this screen (shown in Figure 4-96) allows you to save the current configuration of the router as a backup file.

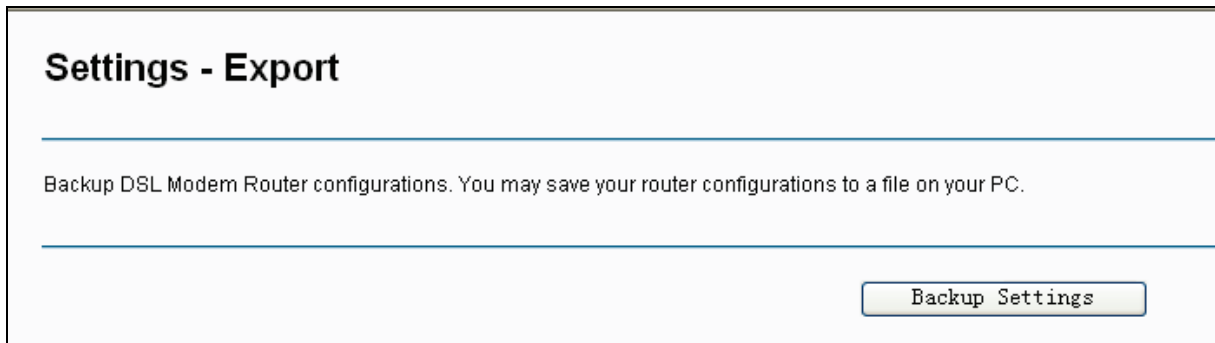

Figure 4-96

#### To back up the router's current settings:

1. Click the **Backup Settings** button on the preceding screen (pop-up Figure 4-96), the following screen will then appear (shown in Figure 4-97).

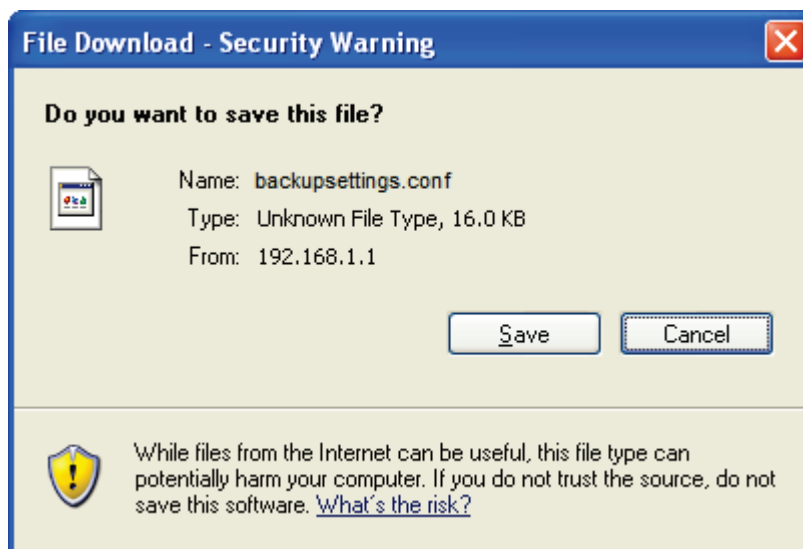

Figure 4-97

2. Click the **Save** button, and save the file as the appointed file (shown in Figure 4-98).

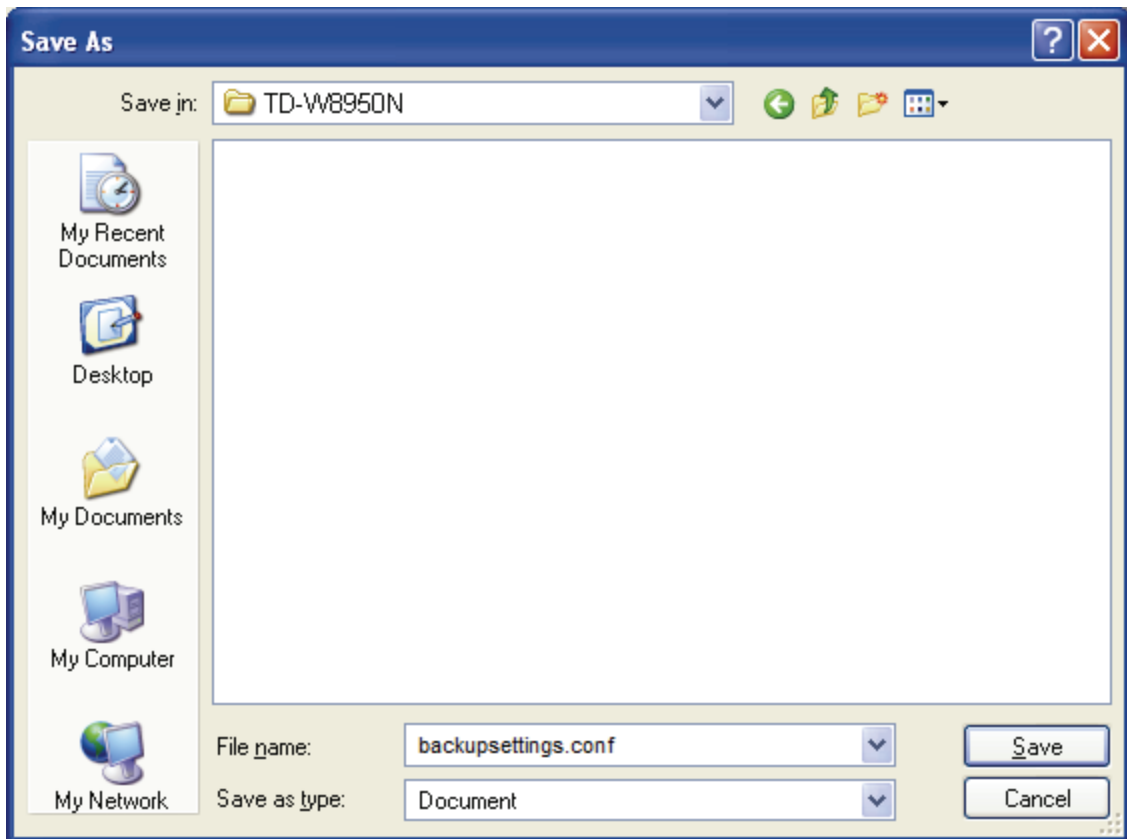

Figure 4-98

#### 4.9.1.2 Import

Choose “**Management**”→“**Settings**”→“**Import**”, you can see the **Import** screen, this screen (shown in Figure 4-99) allows you to update the router’s settings.

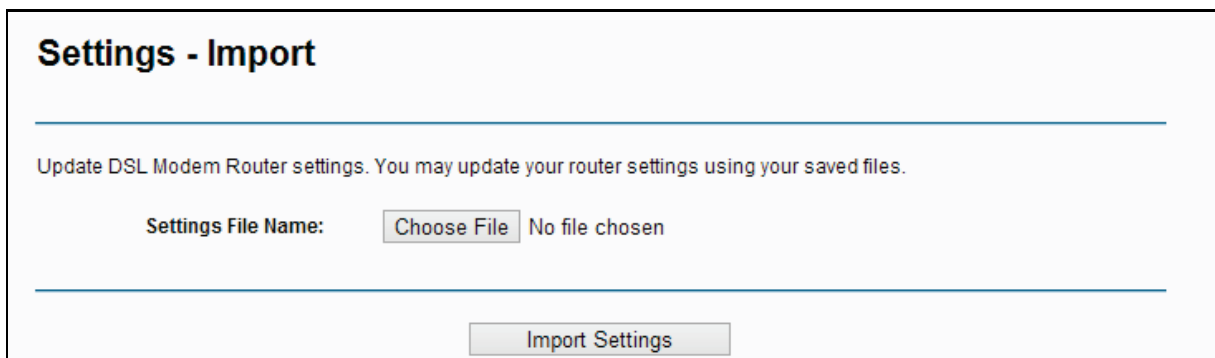

Figure 4-99

#### To update the router’s settings:

1. Click the **Choose File** button to locate the update file for the device, and you can also enter the exact path to the Setting file in the text box.
2. After you have selected the file for updating the settings, click the **Import Settings** button.

#### **Note:**

The router will reboot upon completion. This process will take a while, don’t turn off the router or press the **Reset** button while processing.

### 4.9.1.3 Restore Default

Choose “**Management**”→“**Settings**”→“**Restore Default**”, you can see the **Restore Default** screen, this screen (shown in Figure 4-100) allows you to restore the router’s configuration to the factory defaults on the screen.

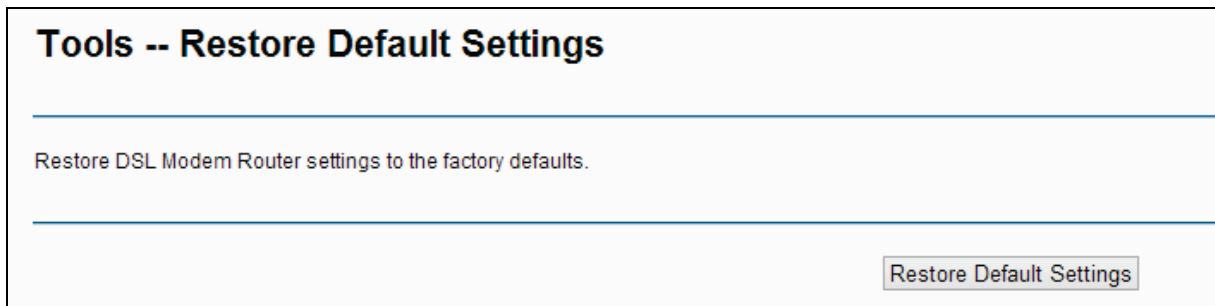

Figure 4-100

- **Restore Default Settings:** Click this button to restore the router’s configuration to the factory defaults, and then follow the on-screen instructions to complete it.
- **Account and Password:** The default **account name** and **password** are both admin.
- The default **IP Address:** 192.168.1.1.
- The default **Subnet Mask:** 255.255.255.0.

### 4.9.2 System Log

Choose “**Management**”→“**System Log**”, you can see the **System Log** screen, this screen (shown in Figure 4-101) allows you to view the system log and configure the system log options.

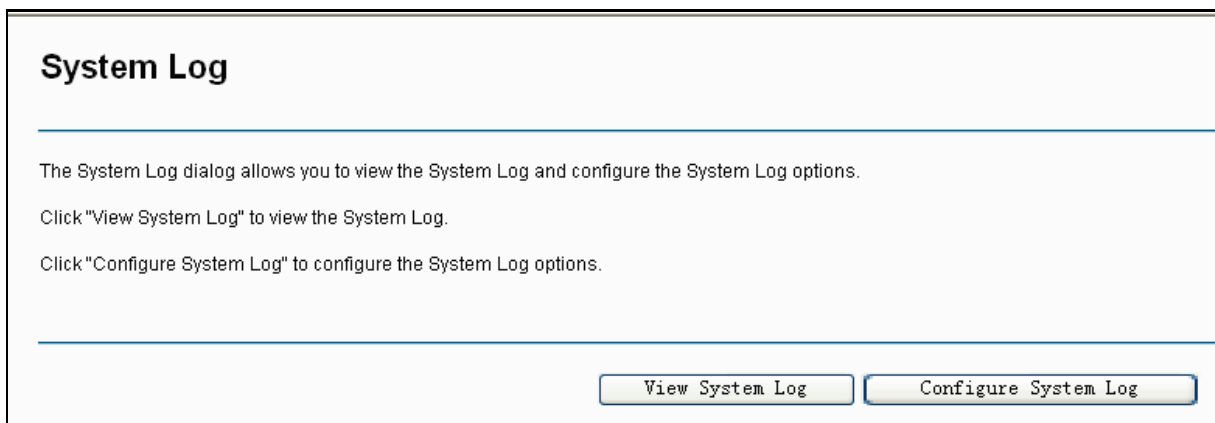

Figure 4-101

#### To View the System Log:

Click the **View System Log** button, you will see the screen (shown in Figure 4-102) which displays the router’s recent logs.

System Log			
Date/Time	Facility	Severity	Message
<input type="button" value="Refresh"/> <input type="button" value="Back"/>			

Figure 4-102

- **Refresh:** Click the button, the information in the table will be updated.
- **Back:** Click the button, the screen will back to the previous page.

### To Configure the System Log Settings:

Click the **Configure System Log** button (shown in Figure 4-101), you will see the screen below (shown in Figure 4-103).

System Log -- Configuration	
<p>If the log mode is enabled, the system will begin to log all the selected events. For the Log Level, all events above or equal to the selected level will be logged. For the Display Level, all logged events above or equal to the selected level will be displayed. If the selected mode is 'Remote' or 'Both,' events will be sent to the specified IP address and UDP port of the remote syslog server. If the selected mode is 'Local' or 'Both,' events will be recorded in the local memory.</p>	
<p>Select the desired values and click 'Save/Apply' to configure the system log options.</p>	
Log:	<input checked="" type="radio"/> Disable <input type="radio"/> Enable
Log Level:	<input type="text" value="Debugging"/>
Display Level:	<input type="text" value="Error"/>
Mode:	<input type="text" value="Local"/>
<input type="button" value="Save/Apply"/>	

Figure 4-103

- **Disable/Enable:** Select the **Enable** to log the events, if you don't want to log these events, please select **Disable**.
- **Log Level:** Select the Log level in the drop-down list, for the Log level, all events above or equal to the selected level will be logged.
- **Display Level:** Select the Display level in the drop-down list, for the Display Level, all logged events above or equal to the selected level will be displayed.
- **Mode:** Select the mode to record the events. If the selected mode is **Local**, events will be recorded in the local memory. If the selected mode is **Remote**, events will be sent to the specified IP address and UDP port of the remote system log server. If the selected mode is **Both**, events will be sent to the local memory and the remote system log server.

### 4.9.3 SNMP Agent

Choose "**Management**" → "**SNMP Agent**", you can see the SNMP-Configuration screen as shown below.

**SNMP** (Simple Network Management Protocol) has been widely applied in the computer networks currently, which is used for ensuring the transmission of the management information between any two nodes. In this way, network administrators can easily search and modify the information on any node on the network. Meanwhile, they can locate faults promptly and implement the fault diagnosis, capacity planning and report generating.

An **SNMP Agent** is an application running on the router that performs the operational role of receiving and processing SNMP messages, sending responses to the SNMP manager, and sending traps when an event occurs. So a router containing SNMP "agent" software can be monitored and/or controlled by SNMP Manager using SNMP messages.

An **SNMP Manager** or SNMP Service is an application that performs the operational roles of generating SNMP messages/requests to modify and retrieve management information, and receiving the requested information and trap-event reports that are generated by the SNMP agent. SNMP Manager is the third-party management system. Monitor one is an SNMP Manager.

### SNMP - Configuration

---

Simple Network Management Protocol (SNMP) allows a management application to retrieve statistics and status from the SNMP agent in this device.

Select the desired values and click "Save/Apply" to configure the SNMP options.

<b>SNMP Agent:</b>	<input checked="" type="radio"/> Disable <input type="radio"/> Enable
<b>Read Community:</b>	<input type="text" value="public"/>
<b>Set Community:</b>	<input type="text" value="private"/>
<b>System Name:</b>	<input type="text" value="TP-LINK"/>
<b>System Location:</b>	<input type="text" value="unknown"/>
<b>System Contact:</b>	<input type="text" value="unknown"/>
<b>Trap Manager IP:</b>	<input type="text" value="0. 0. 0. 0"/>

---

Figure 4-104

➤ **SNMP Agent:** You can select the checkbox to disable or enable the function.

**Note:**

**SNMP Community string** provides a simple method of authentication between the router (SNMP Agent) and a remote network manager (SNMP Manager). You can specify the community string as the password to authenticate the management station to the router.

- **Read Community:** This field allows you to specify the SNMP Community string which provides read-only access to the router that the community is only permitted to read the device configuration. The default value is "public".
- **Set Community:** This field allows you to specify the SNMP Community string which provides read and write access to the router that the community has the authority to read and change the device configuration. The default value is "private".
- **System Name:** Enter alphanumeric string to specify an SNMP community string name. Your router (SNMP agents) will expose management data on the managed systems as this "system name".
- **System Location:** The person to notify when problems occur.



- **System Contact:** The location of the person that is identified as the system contact.
- **Trap Manager IP:** Enter the IP address of the SNMP Manager, where the SNMP Agent forwards trap notifications.

Select the desired values and click **Save/Apply** to configure the SNMP options.

#### 4.9.4 TR-069 Client

Choose “**Management**”→“**TR-069 Client**”, you can see the TR-069 client screen as shown below.

**TR-069** (WAN Management Protocol) allows a Auto-Configuration Server (ACS) to perform auto-configuration, provision, collection, and diagnostics to this device.

### TR-069 client - Configuration

---

WAN Management Protocol (TR-069) allows a Auto-Configuration Server (ACS) to perform auto-configuration, provision, collection, and diagnostics to this device.

Select the desired values and click "Apply/Save" to configure the TR-069 client options.

**Inform**     Disable     Enable

**Inform Interval:**

**ACS URL:**

**ACS User Name:**

**ACS Password:**

**WAN Interface used by TR-069 client:**

**Display SOAP messages on serial console**     Disable     Enable

Connection Request Authentication

**Connection Request User Name:**

**Connection Request Password:**

**Connection Request URL:**

---

Figure 4-105

- **Inform:** You can select the checkbox to disable or enable the function of TR-069 client.
- **Inform Interval:** Type the interval time of your router contact with the **ACS**.
- **ACS URL:** Please accept this information from your ISP. And through **ACS** (Auto-Configuration Server) you can perform auto-configuration, provision, collection, and diagnostics to this router.
- **ACS User Name:** Please accept this User Name information from your ISP.
- **ACS Password:** Please accept the Password information from your ISP.

#### **Note:**

If you want to log on the **ACS**, you must own the **ACS User Name** and **ACS Password**.

- **WAN Interface used by TR-069 Client:** Please select the WAN Interface from the drop-down list to perform this function.
- **Connection Request User Name:** Type the Connection Request User Name, set it yourself.
- **Connection Request Password:** Type the Connection Request Password, set it yourself.

**Note:**

The Connection Request User Name and Connection Request Password are used for **ACS** log on the router and manage it.

Select the desired values and click **Save/Apply** to configure the TR-069 client options.

### 4.9.5 Internet Time

Choose "**Management**"→"**Internet Time**", you can see the Time settings screen as shown below. Here you can configure the time of the router.

Figure 4-106

- **Enable DST:** Select the checkbox to enable daylight saving function.

### 4.9.6 Access Control

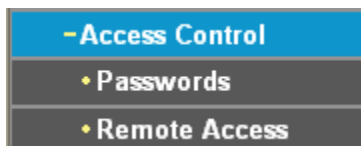

There are two submenus under the Access Control menu: **Passwords** and **Remote Access**. The detailed explanations for each submenu are provided below.

#### 4.9.6.1 Password

Choose "**Management**"→"**Access Control**"→"**Password**", you can see the screen (shown in Figure 4-107) which allows you to change the factory default password of the router. The default password is the same as the user name, which is admin/admin, support/support, and user/user respectively.

### Access Control -- Passwords

---

You can access your Modem Router with your user account **admin** from the local network or through the Internet to view or change its settings.  
 Note: **Firmware Upgrade** (Management > Firmware Upgrade) and **Settings Export/Import** (Management > Settings > Export/Import) functions are only available for local access.

Use the fields below to enter up to 16 characters and click "Save/Apply" to change or create password. Note: Password cannot contain a space.

Username:

Old Password:

New Password:

Confirm Password:

---

Figure 4-107

**To change the password:**

1. Enter the **Old Password** in the text box.
2. Enter the **New Password** and **Confirm Password**. The Confirm Password should be the same as the New Password.
3. Click **Save/Apply** to make your change take effect.

**Note:**

- 1) Access to your DSL modem router is controlled through the account **admin**. You have unrestricted access to change and view configuration of your DSL modem router if you access from the local area network. If you access via the Internet, **Firmware Upgrade** (Management > Firmware Upgrade) and **Settings Export/Import** (Management > Settings > Export/Import) functions are unavailable
- 2) **Admin** can do remote management. For security reasons, please change its default password when remote access function is enabled.
- 3) The password cannot contain a space, and its maximum length is 16 characters.

**4.9.6.2 Remote Access**

Choose "**Management**"→"**Access Control**"→"**Remote Access**", you can see the screen (shown in Figure 4-108) which allows you to change the factory default password of the router.

### Access Control -- Remote Access

---

You can access your Modem Router through the Internet with your user account **admin** to view or change any setting except **Firmware Upgrade** (Management > Firmware Upgrade) and **Settings Export/Import** (Management > Settings > Export/Import).

Selected WAN Interface:

Web:

Telnet:

ICMP(ping):

---

Figure 4-108

- **Web:** Select this box, you can access your modem router via web.
- **Telnet:** Select this box, you can access your modem router via command line.
- **ICMP(ping):** Select this box, PC in public network can ping the WAN address of the modem router.

Click **Save/Apply** to make your change take effect.

#### 4.9.7 Firmware Upgrade

Choose “**Management**”→“**Firmware Upgrade**”, you can see the screen (shown in Figure 4-109) which allows you to upgrade the latest version software to keep the router up to date.

### Tools -- Firmware Upgrade

---

**Step 1:** Obtain an updated firmware image file from our website ([www.tp-link.com](http://www.tp-link.com)).

**Step 2:** Enter the path to the image file location in the box below or click the "Browse" button to locate the image file.

**Step 3:** Click the "Upgrade Firmware" button once to upload the new image file.

NOTE: The Upgrade process takes about 2 minutes to complete, and your DSL Modem Router will reboot.

Firmware File Name:  No file chosen

---

Figure 4-109

- **Choose File:** Click the button to locate the latest software for the device.
- **Upgrade Firmware:** After you have selected the latest software, click the button.

#### To upgrade the router's software:

1. Download the latest software upgrade file from the TP-LINK website (<http://www.tp-link.com>).
2. Click **Choose File** to view the folders and select the image file or enter the exact path to the image file location in the text box.
3. Click the **Upgrade Firmware** button.

#### **Note:**

- 1) There is no need to upgrade the firmware unless the new firmware has a new feature you want to use. However, when experiencing problems caused by the router itself, you can try to upgrade the firmware.
- 2) Before upgrading the router's firmware, you should write down some of your customized settings to avoid losing important configuration settings of the router.
- 3) Do not turn off the router or press the RESET button while the software is being updated.
- 4) The router will reboot after the Upgrading is finished.

### 4.9.8 Reboot

Choose “**Management**” → “**Reboot**”, you can see the screen (shown in Figure 4-110) which allows you to reboot the router.

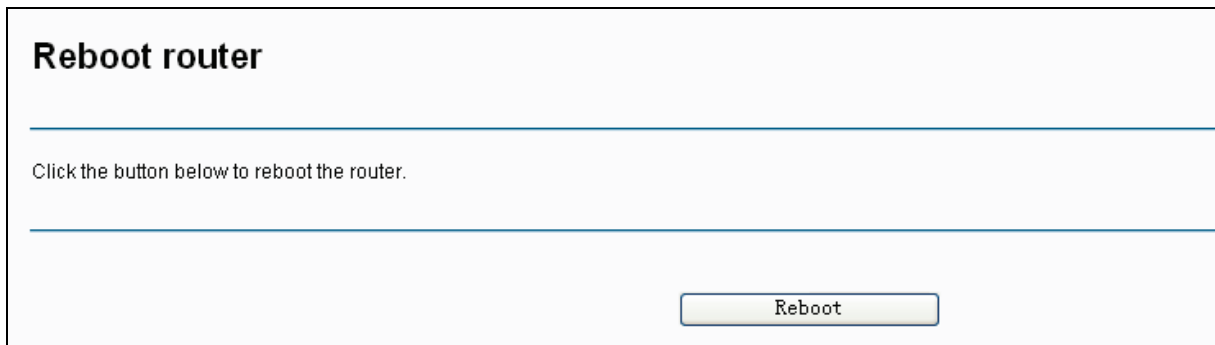

Figure 4-110

#### Note:

- 1) After you clicked the Reboot button, please wait for a while before reopening your web browser.
- 2) Do not turn off the router or press the **RESET** button while the router is rebooting.
- 3) If necessary, reconfigure your PC's IP address to match your new configuration.

### 4.10 Logout

Choose “**Logout**”, and you will back to the login screen as shown in Figure 4-111.

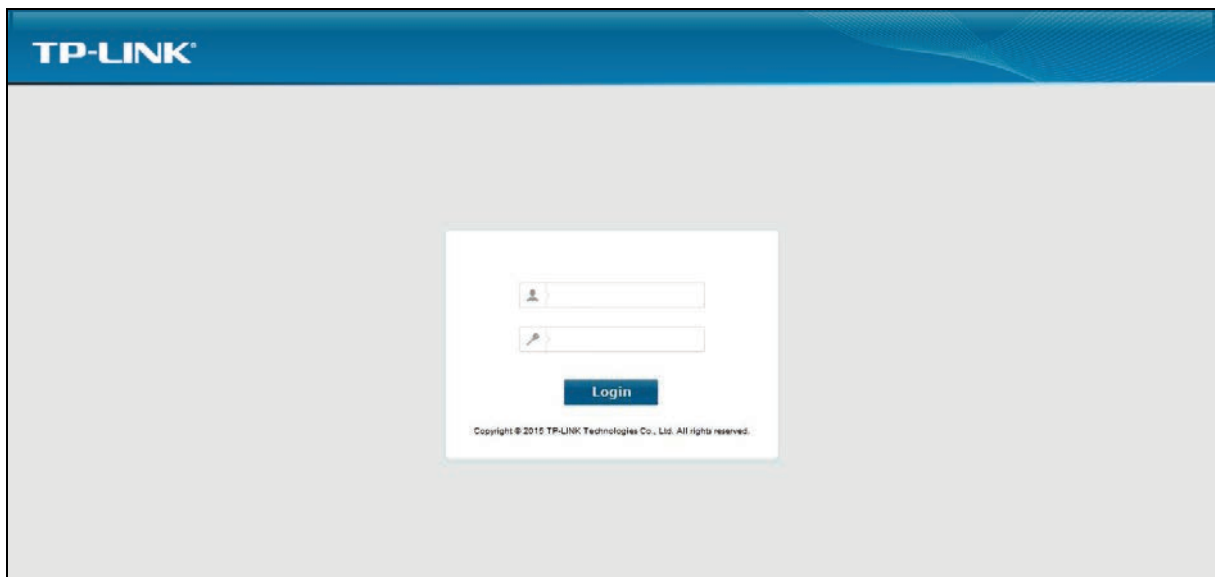

Figure 4-111

## Appendix A: Specifications

General	
Standards	ANSI T1.413.I2, ITU G.992.1, ITU G.992.2, ITU G.992.3, ITU G.992.5, IEEE 802.1p, IEEE 802.3, IEEE 802.3u, IEEE 802.11e, IEEE 802.11b, IEEE 802.11g, 802.11n, TR100, TR-067, TR-069
Protocols	TCP/IP, IPoA, PPPoA, PPPoE, SNTP, HTTP, DHCP, ICMP, NAT
Ports	LAN Ports: Four 10/100M Auto-Negotiation RJ45 ports (Auto MDI/MDIX)
	Line Port: One RJ11 port
Cabling Type	10BASE-T: UTP category 3, 4, 5 cable (maximum 100m) EIA/TIA-568 100Ω STP (maximum 100m)
	100BASE-TX: UTP category 5, 5e cable (maximum 100m) EIA/TIA-568 100Ω STP (maximum 100m)
LED	Power, ADSL, Internet, WLAN, WPS, 1,2,3,4(LAN),
Safety & Emissions	FCC, CE

Wireless	
Frequency Band	2.4~2.4835GHz
Radio Data Rate	11n: up to 150Mbps (Automatic) 11g: 54/48/36/24/18/12/9/6Mbps (Automatic) 11b: 11/5.5/2/1Mbps (Automatic)
Frequency Expansion	DSSS(Direct Sequence Spread Spectrum)
Modulation	DBPSK, DQPSK, CCK, OFDM, 16-QAM, 64-QAM
Security	WEP/WPA/WPA2/WPA2-PSK/WPA-PSK
Sensitivity @PER	270M: -62dBm@10% PER 130M: -64dBm@10% PER 54M: -68dBm@10% PER 11M: -85dBm@8% PER 6M: -88dBm@10% PER 1M: -90dBm@8% PER

Environmental and Physical	
Temperature	Operating: 0°C~40°C (32°F~104°F)
	Storage: -40°C~70°C(-40°F~158°F)
Humidity	Operating: 10% ~ 90% RH, Non-condensing
	Storage: 5% ~ 90% RH, Non-condensing

## Appendix B: Configuring the PC

In this section, we'll introduce how to install and configure the TCP/IP correctly in Windows XP. First make sure your Ethernet Adapter is working, refer to the adapter's manual if necessary.

### 1. Configure TCP/IP component

- 1) On the Windows taskbar, click the **Start** button, and then click **Control Panel**.
- 2) Click the **Network and Internet Connections** icon, and then click on the **Network Connections** tab in the appearing window.
- 3) Right click the icon that showed below, select Properties on the prompt page.

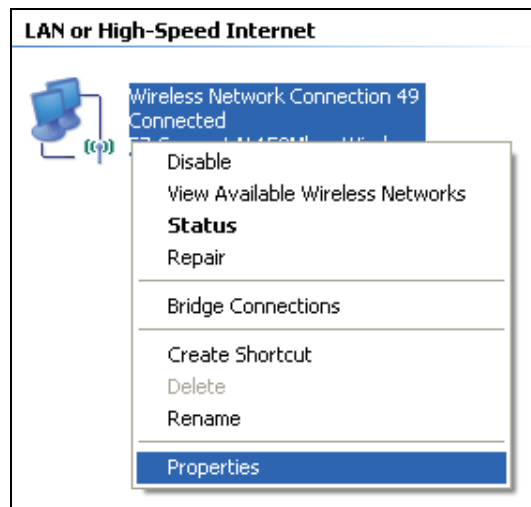

Figure B-0-1

- 4) In the prompt page that showed below, double click on the **Internet Protocol (TCP/IP)**.

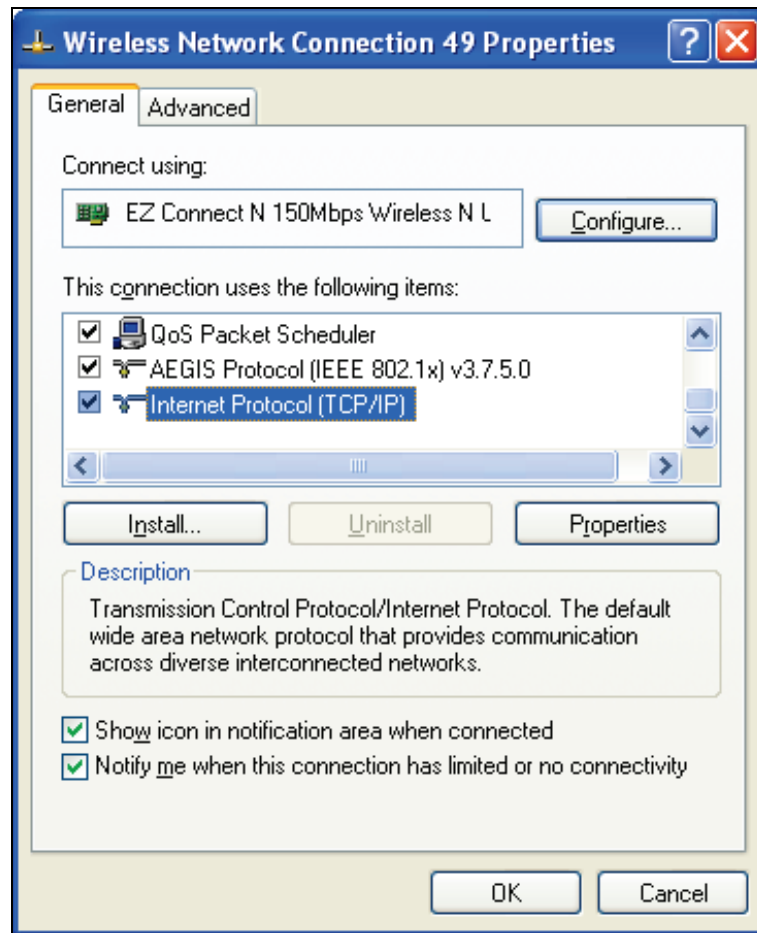

Figure B-0-2

- 5) The following **TCP/IP Properties** window will display and the **IP Address** tab is open on this window by default.

Now you have two ways to configure the **TCP/IP** protocol below:

➤ **Setting IP address automatically**

Select **Obtain an IP address automatically**, Choose **Obtain DNS server automatically**, as shown in the Figure below:



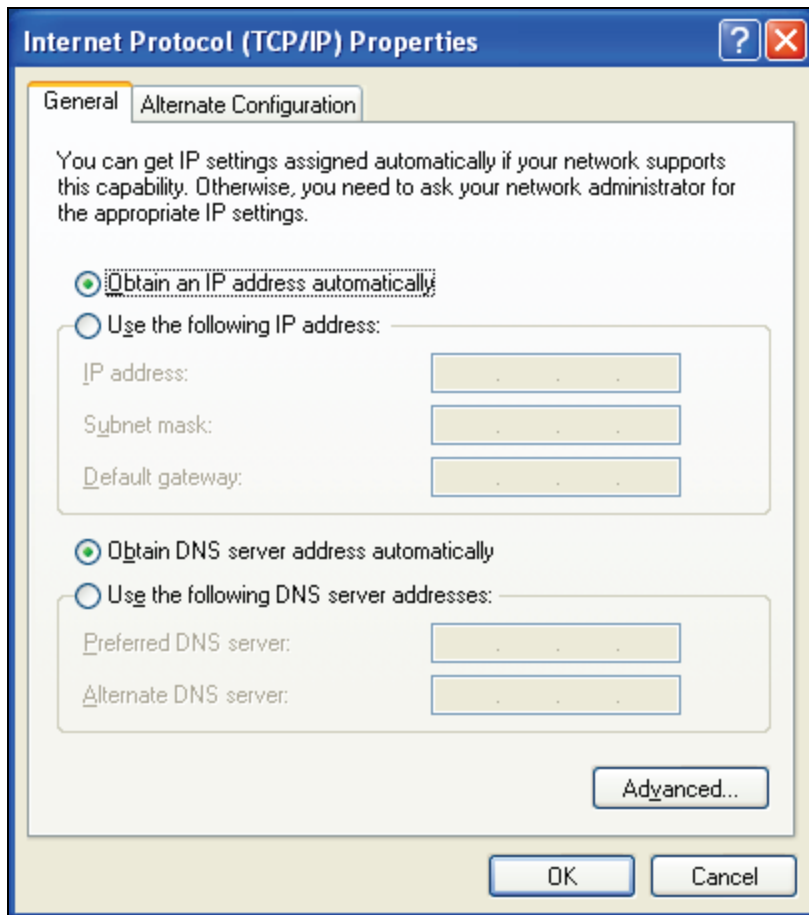

Figure B-0-3

**Note:**

For Windows 98 OS or before, the PC and Router may need to be restarted.

➤ **Setting IP address manually**

- 1 Select **Use the following IP address** radio button. And the following items available
- 2 If the modem router's LAN IP address is 192.168.1.1, specify the **IP address** as 192.168.1.x (x is from 2 to 254), and the **Subnet mask** as 255.255.255.0.
- 3 Type the modem router's LAN IP address (the default IP is 192.168.1.1) into the **Default gateway** field.
- 4 Select **Use the following DNS server addresses**. In the **Preferred DNS Server** field you can enter the same value as the **Default gateway** or type the local DNS server IP address.

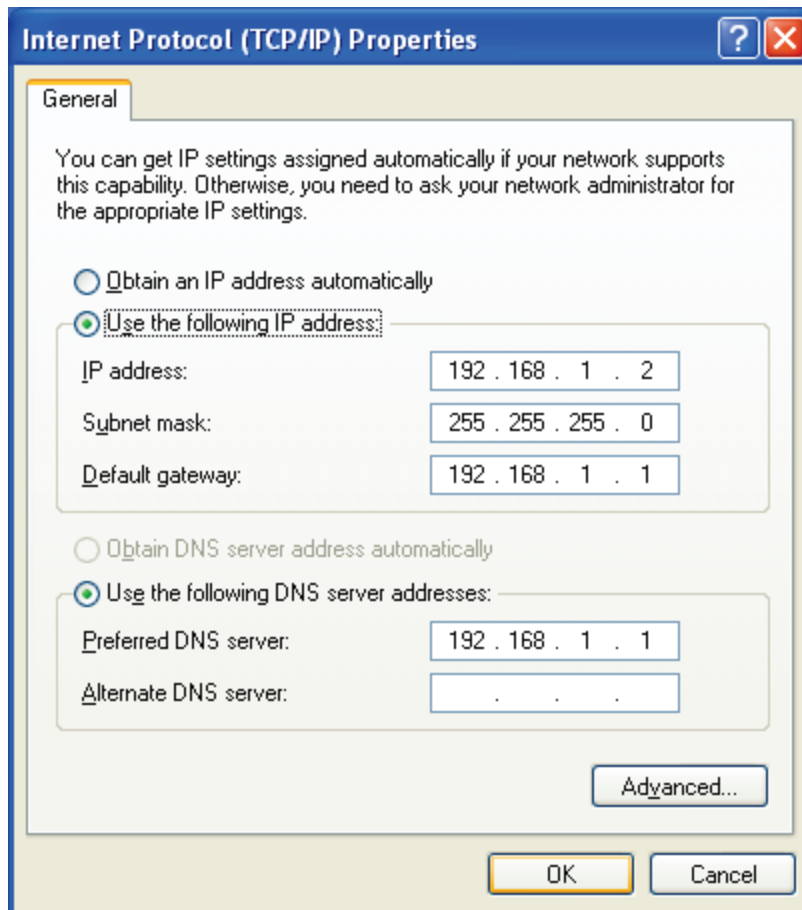

Figure B-0-4

**Now:**

Click **OK** to keep your settings.

## Appendix C: Troubleshooting

### T1. What can I do if I don't know or forget my password?

- For default wireless password: Please refer to the "Wireless Password/PIN" labeled on the bottom of the modem router.
- For the web management page password: Reset the modem router first and then use the default user name and password: admin/admin.

### T2. How do I restore my modem router's configuration to its factory default settings?

- With the modem router powered on, press and hold down the **WPS/RESET** button on the rear panel of the modem router for more than 5 seconds and then release it. If all LEDs turn on momentarily, you restore the modem router successfully.
- Log into the Web Management page of the modem router, and go to **Management > Settings > Restore Default**, click Restore Default Settings and wait until the reset process is complete.

 **Note:**

Once the modem router is reset, the current configuration settings will be lost and you will need to re-configure the router.

### T3. What can I do if I cannot access the web-based configuration page?

- 1) Configure your computer's IP Address.

#### **For Mac OS X**

- Click the **Apple** icon on the upper left corner of the screen.
- Go to "**System Preferences -> Network**".
- Select **Airport** on the left menu bar, and then click **Advanced** for wireless configuration; or select **Ethernet** for wired configuration.
- In the **Con-figure IPv4** box under **TCP/IP**, select **Using DHCP**.
- Click **Apply** to save the settings.

#### **For Windows 7**

- Click "**Start -> Control Panel -> Network and Internet -> View network status -> Change adapter settings**".
- Right-click **Wireless Network Connection** (or **Local Area Connection**), and then click **Properties**.
- Select **Internet Protocol Version 4 (TCP/IPv4)**, and then click **Properties**.
- Select **Obtain an IP address automatically** and **Obtain DNS server address automatically**. Then click **OK**.

#### **For Windows XP**

- Click "**Start -> Control Panel -> Network and Internet Connections -> Network Connections**".
- Right-click **Wireless Network Connection** (or **Local Area Connection**), and then click **Properties**.

- Select **Internet Protocol (TCP/IP)**, and then click **Properties**.
- Select **Obtain an IP address automatically** and **Obtain DNS server address automatically**. Then click **OK**.

**For Windows 8**

- Move your mouse to the lower right corner and you will see **Search** icon  in the Popups. Go to **Search** -> **Apps**. Type **Control Panel** in the search box and press **Enter**, then you will go to **Control Panel**.
- Click **“View network status and tasks > Change adapter settings”**.
- Right-click **“Ethernet”** and then select **Properties**.
- Double-click **Internet Protocol Version 4 (TCP/IPv4)**. Select **Obtain an IP address automatically**, choose **Obtain DNS server address automatically** and then click **OK**.

2) Configure your IE browser

Open your IE browser, click **Tools** tab and you will see the following screen.

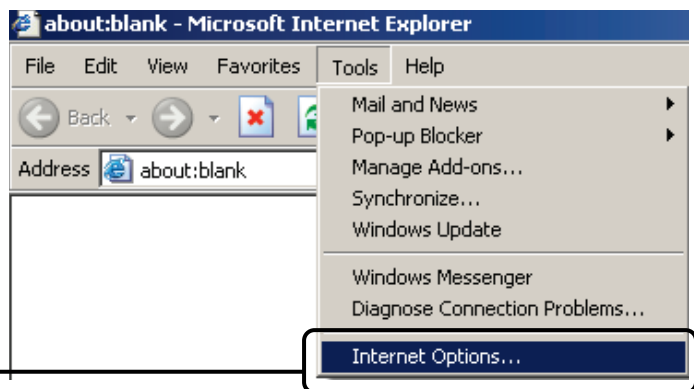

Click **Internet Options**

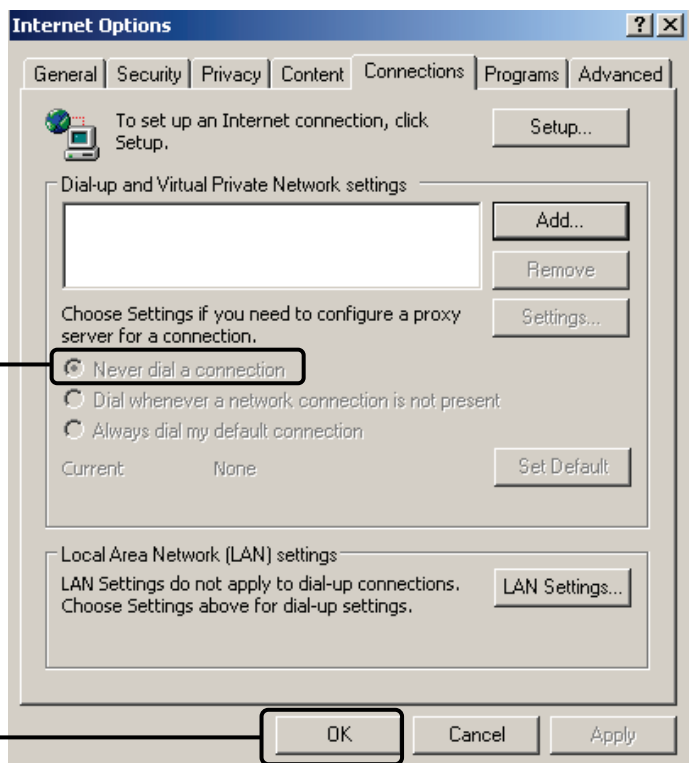

Select **Never dial a connection**

Click **OK**

Now, try to log on to the Web-based configuration page again after the above settings have been configured. If you still cannot access the configuration page, please restore your modem router's factory default settings and reconfigure your modem router following the instructions in [3.2 Quick Installation Guide](#). Please feel free to contact our Technical Support if the problem still exists.

#### **T4. What can I do if I cannot access the Internet?**

- 1) Make sure the telephone and Ethernet cables are plugged in correctly.
- 2) Try to log into the web management page of the modem router using the default address at <http://tplinkmodem.net>. If you can, try the following answers. If you cannot, change your computer to obtain an IP address automatically from the modem router.
- 3) Consult your ISP and make sure all the VPI/VCI, WAN Link Type, account username and password are correct. If they are not, please replace them with the correct settings and try again.
- 4) Restore the modem router to its factory default settings and reconfigure the modem router by following the instructions in [3.2 Quick Installation Guide](#).
- 5) Please contact our Technical Support if the problem still exists.