



User Guide

AV1300 Gigabit Powerline ac Wi-Fi Extender
TL-WPA8630

Contents

About This Guide	1
Chapter 1. Get to Know Your Powerline Extender	2
1.1. Product Overview.....	3
1.2. Product Appearance.....	3
1.2.1. LED Legend	3
1.2.2. Physical Interface	4
Chapter 2. Initial Use	6
2.1. To Set Up a New Secure Wireless Network	7
2.2. To Extend the Existing Wireless Network.....	8
Chapter 3. Configuring via Web Management Interface.....	11
3.1. Management Interface.....	12
3.1.1. Log In	12
3.1.2. Change the Login Account	12
3.2. Manage Powerline Network.....	13
3.2.1. Add a New Device to the Powerline Network	13
3.2.2. Change Powerline Network Name.....	14
3.3. Wi-Fi Move	14
3.4. Wi-Fi Clone	15
3.5. Wireless Network.....	16
3.5.1. Customize Wireless Settings	16
3.5.2. Wireless Clients	19
3.6. LED Schedules	19
3.7. Schedule Your Wireless Function	20
3.8. Parental Controls	22
3.9. Guest Network.....	24
3.10. MAC Filter	25
3.11. Administration.....	27
3.11.1. LAN IP Address.....	27
3.11.2. Set Up System Time.....	27
3.11.3. Upgrade the Firmware	29
3.11.4. Backup and Restore Configuration Settings.....	30
3.11.5. System Log	31

About This Guide

This guide is a complement to Quick Installation Guide. The Quick Installation Guide provides instructions for quick Internet setup, while this guide contains details of each function and demonstrates how to configure them in typical scenarios.

When using this guide, please notice that features of the powerline extender may vary slightly depending on the model and software version you have, and on your location and language. All images, parameters and descriptions documented in this guide are used for demonstration only.

Conventions

In this guide the following conventions are used:

Convention	Description
Powerline extender	Stands for AV1300 Powerline ac Wi-Fi Extender without any explanation.
<u>Teal Underlined</u>	Hyperlinks are in teal and underlined. You can click to redirect to a website or a specific section.
Teal	Key information appears in teal, including management page text such as menus, items, buttons and so on.
>	The menu structures to show the path to load the corresponding page. For example, Wireless > MAC Filter means the MAC Filter function page is under the Wireless menu.
■ Note:	Ignoring this type of note might result in a malfunction or damage to the device.
🔗 Tips:	Indicates important information that helps you make better use of your device.
Symbols on the web page	<ul style="list-style-type: none">✎ click to edit the corresponding entry.🗑 click to delete the corresponding entry.💡 click to enable or disable the corresponding entry.

More Info

- The latest software, management app and utility are available from the [Download Center](#) at <http://www.tp-link.com/support>.
- The Quick Installation Guide (QIG) can be found where you find this guide or inside the package of the powerline extender.
- Specifications can be found on the product page at <http://www.tp-link.com>.
- A Technical Support Forum is provided for you to discuss our products at <http://forum.tp-link.com>.
- Our Technical Support contact information can be found at the [Contact Technical Support](#) page at <http://www.tp-link.com/support>.

Chapter 1

Get to Know Your Powerline Extender

This chapter introduces what the powerline extender can do and describes its main features and appearance.

It contains the following sections:

- [Product Overview](#)
- [Product Appearance](#)

1.1. Product Overview

TP-Link's Powerline Wi-Fi Extender is a combined wired/wireless network expansion device. With the help of your home's existing electrical circuitry, it can extend your Wi-Fi to wherever you want in your house.

With Ethernet ports and built-in antennas, the powerline Wi-Fi extender provides wired and wireless access for multiple computers and mobile devices.

With various features and functions, the powerline Wi-Fi extender is the perfect choice for your home or business network.



1.2. Product Appearance

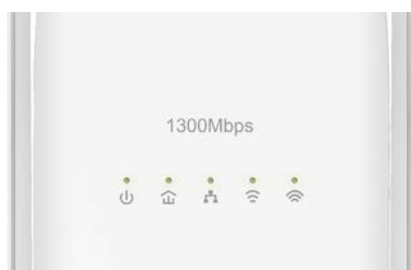

Your powerline extender may differ in appearance slightly from that depicted because of the region and product version.

1.2.1. LED Legend



LEDs indicate the powerline extender's working status. For more details, please refer to the following table.

Name	Status	Indication
 Power	On/Off	Power is on/off.
	Blinking	Pairing is in progress.
 Powerline	Yellow-green	The powerline extender is connected to the powerline network and is in a suitable location.
	Red	The powerline extender is experiencing poor signal strength. Try plugging it into another wall socket.
 Ethernet	Off	The powerline extender is not connected to the powerline network.
	On	At least one LAN port is connected to a powered-on device.
	Off	No LAN port is connected to a powered-on device.

Name	Status	Indication
 2.4GHz Wireless	On	The 2.4GHz wireless band is enabled.
	Off	The 2.4GHz wireless band is disabled.
	Flashing	Slowly: The powerline extender is cloning 2.4GHz wireless network settings from the main router. Quickly: The powerline extender is syncing 2.4GHz wireless network settings from an existing powerline extender.
 5GHz Wireless	On	The 5GHz wireless band is enabled.
	Off	The 5GHz wireless band is disabled.
	Flashing	Slowly: The powerline extender is cloning 5GHz wireless network settings from the main router. Quickly: The powerline extender is syncing 5GHz wireless network settings from an existing powerline extender.

1.2.2. Physical Interface

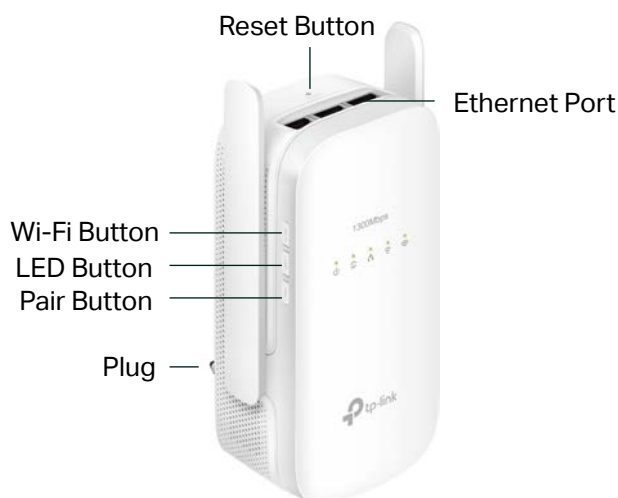

Reset

Press and hold the Reset button for at least 5 seconds to reset the powerline extender to factory default settings. When Reset is triggered properly, all LEDs will turn off and start on again.

Ethernet Port

Connect the Ethernet ports to your wired devices, such as a computer, a router or a

game console, via Ethernet cables.

Wi-Fi Button

Press and hold the button for 1 second to copy wireless settings from the main router to the extender. Go to [Wi-Fi Clone](#) for more information.

Press and hold the button for at least 5 seconds to turn the wireless function on or off. The wireless function is on by default. You can turn them off at night and then on in the morning by pressing this button.

LED Button

Press and hold the button for 1 second to turn all LEDs on or off. All LEDs are on by default. If you don't feel like being bothered by the LED light at night, press and hold the button for 1 second to turn all LEDs off. The next morning, just press and hold the button again to turn them on.

Pair Button

Press and hold the button for 1 second to join a powerline network. Go to [To Set Up a New Secure Wireless Network](#) for more information.

Press and hold the button for about 8 seconds until the powerline LED turns off to leave the existing powerline network.

Plug

The powerline adapter has a Plug that can be connected to any standard power socket.

Note:

1. Use the product in below direction.

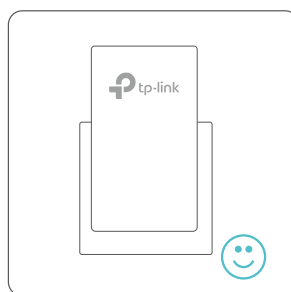

2. Plug the product directly into a wall socket instead of a power strip.

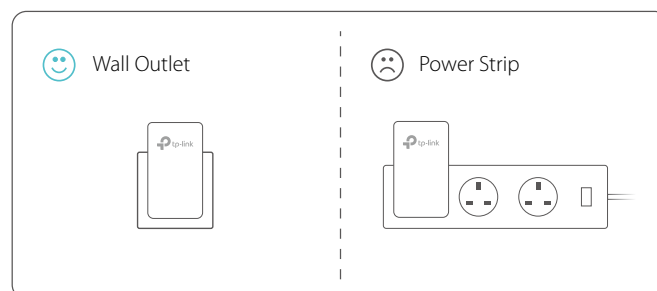

Chapter 2

Initial Use

This chapter guides you on how to use the powerline extender when you first open the package.

It contains the following sections:

- [To Set Up a New Secure Wireless Network](#)
- [To Extend the Existing Wireless Network](#)

2.1. To Set Up a New Secure Wireless Network

I want to:

Use the Powerline Wi-Fi Kit to set up a new secure wireless network in my house.

For example, I have a wireless router in my house, but the wireless signal cannot reach every corner. So I bought a Powerline Wi-Fi Kit to extend the wireless network. The Powerline Wi-Fi Kit includes a powerline adapter and a powerline extender.

How can I do that?

1. Connect the powerline adapter to an available LAN port of the router.
2. Plug the powerline adapter into a wall socket.
3. Plug the powerline extender into a wall socket near the adapter.

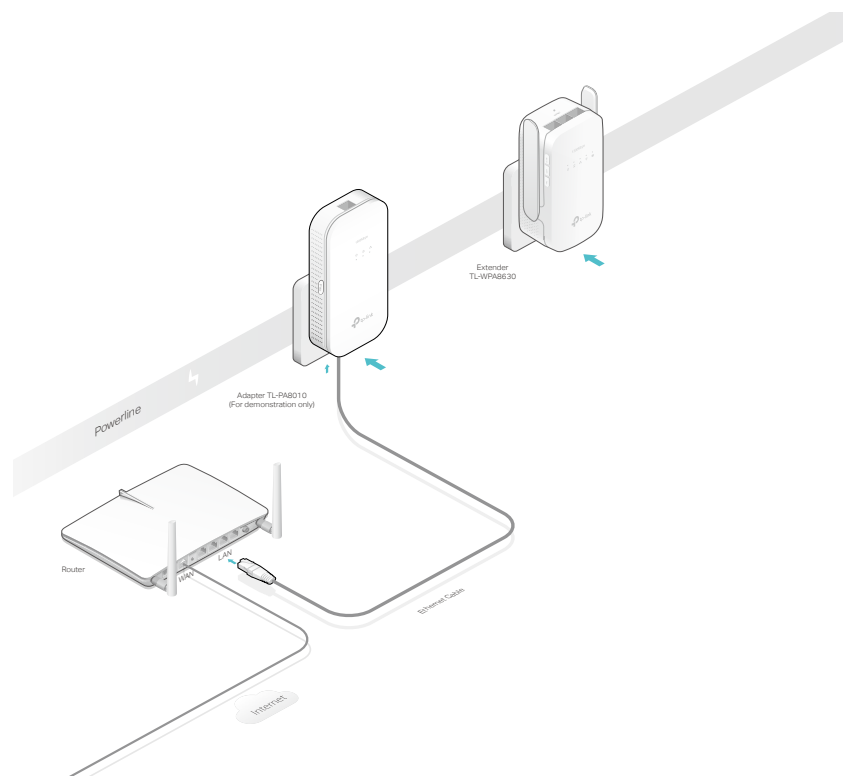

4. Pair the powerline devices.
 - a. Press the Pair button of the powerline adapter for 1 second. The Power LED starts blinking.
 - Note: If the Power LED does not blink, press it again.
 - b. Within two minutes, press the Pair button of the powerline extender for 1 second. The Power LED starts blinking.

When the Powerline LED turns solid, the pairing process is done!

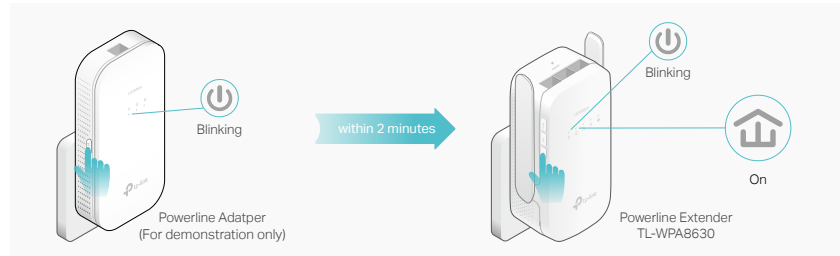

- Relocate the new extender to the Wi-Fi “dead” zone. Use the SSID (network name) and password on the provided Wi-Fi Info Card to connect to the internet.

Note: A red Powerline LED indicates poor signal strength. Move the extender to another location.

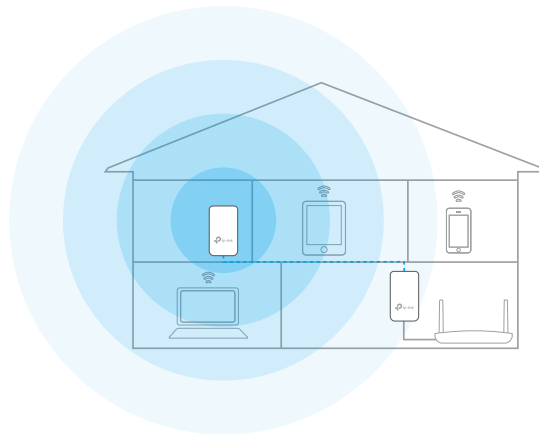
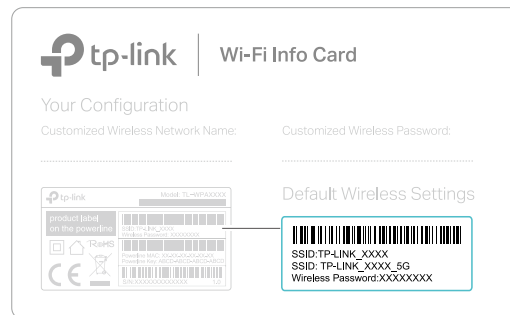

Done!

Now enjoy the internet with the SSID and password printed on the Wi-Fi Info Card!

2.2. To Extend the Existing Wireless Network

I want to:

Extend the existing wireless network by adding a new powerline extender into the existing powerline network.

For example, I already set up a wireless network using powerline devices, but the wireless network is still not big enough to reach the top floor. So I bought a new powerline extender to extend the wireless network.

How can I do that?

1. Plug the new powerline extender into a wall socket near one of the existing powerline extender.

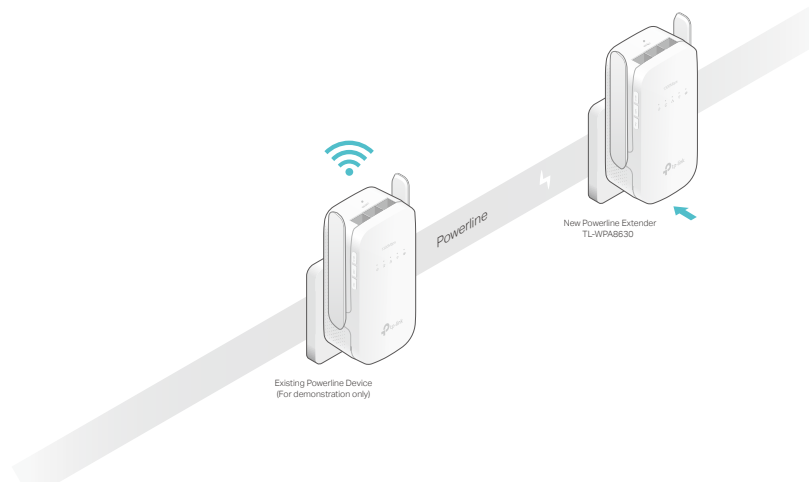

2. Check the new extender's Powerline LED . Is it on?
 - If it is on, follow Step 4 > A.
 - If it is off, follow Step 3 and Step 4 > B.
3. Join the new powerline extender into the existing powerline network by pairing two powerline devices.
 - a. Press the Pair button on the existing powerline device for 1 second. The Power LED starts blinking.
 - Note: If the Power LED does not blink, press again.
 - b. Within two minutes, press the Pair button on the new powerline extender for 1 second. The Power LED starts blinking. When the Powerline LED turns solid, the pairing process is complete.

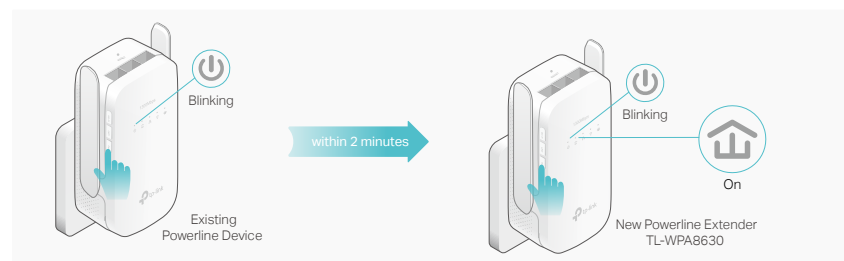

4. Relocate the new extender to the Wi-Fi "dead" zone.
 - Note: A red Powerline LED indicates poor signal strength. Move the extender to another location.

- A. Use the SSID (network name) and password on the provided Wi-Fi Info Card to connect to the internet.
- B. Use the SSID (network name) and password of your existing wireless network to connect.

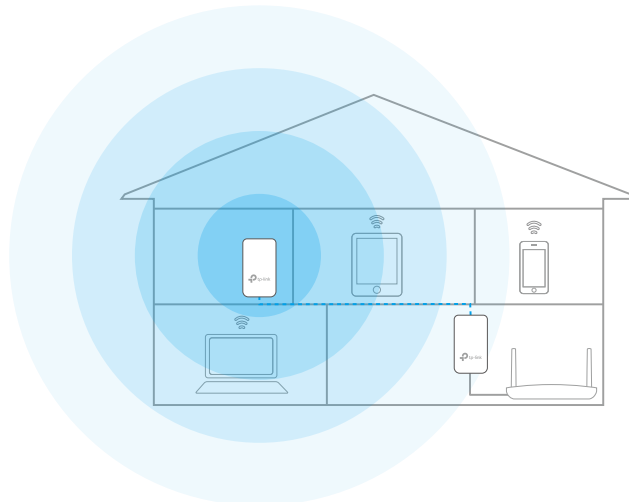

Done!

Enjoy the Internet through your extended network!

Chapter 3

Configuring via Web Management Interface

The powerline extender has a management interface to configure all settings. The management interface can be opened on any device that has a web browser, such as Internet Explorer, Chrome or Firefox. This chapter is going to give detailed information on what functions the powerline extender has and how to configure them.

It contains the following sections:

- [Management Interface](#)
- [Manage Powerline Network](#)
- [Wi-Fi Move](#)
- [Wi-Fi Clone](#)
- [Wireless Network](#)
- [LED Schedules](#)
- [Schedule Your Wireless Function](#)
- [Parental Controls](#)
- [Guest Network](#)
- [MAC Filter](#)
- [Administration](#)

3. 1. Management Interface

3. 1. 1. Log In

There are two methods to log in to the management interface.

Method 1: Via web browser

Follow the steps below:

1. Connect your device to the powerline extender wirelessly.
2. Launch a web browser and type in <http://tplinkplc.net> to open the management interface.

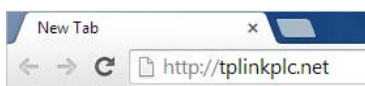

3. Enter **admin** (the default username and password) for both username and password. We recommend you change them immediately after your first login.

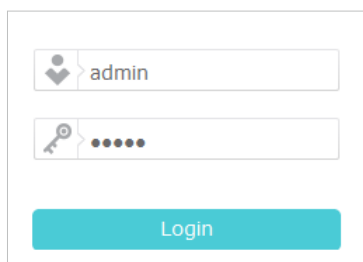
A screenshot of a login form. It features two input fields: the top one contains the text 'admin' and has a user icon to its left; the bottom one contains masked characters (dots) and has a key icon to its left. Below the input fields is a teal-colored button labeled 'Login'.

4. Click **Login**.

Method 2: Via tpPLC utility

Follow the steps below:

1. Connect your computer to the powerline extender via an Ethernet cable or wirelessly.
2. Obtain and install the tpPLC Utility from the product's Support page at <http://www.tp-link.com>.
3. Open the utility, move your mouse over your powerline extender, and click the  icon that appears beside it.
4. Enter **admin** for both username and password.
5. Click **Login**.

3. 1. 2. Change the Login Account

We strongly recommend you change the login account immediately after the first login.

Follow the steps below to change the account.

1. Go to **System Tools > Administration**.

Account Management

Old Username:

Old Password:

New Username:

New Password:

Low Middle High

Confirm New Password:

[Save](#)

2. Follow instructions on the page to set a new username and password. A strong password should be at least 8 characters in length, combining uppercase and lowercase letters, numbers and punctuations.
3. Click [Save](#) to make the settings effective.

3. 2. Manage Powerline Network



A powerline network is formed of powerline devices, including adapters and extenders. Powerline devices in the same powerline network share the same powerline network name.

3. 2. 1. Add a New Device to the Powerline Network

1. Connect to the powerline extender wirelessly. Visit <http://tplinkplc.net>, and log in with the username and password you set for the extender.
2. Go to the [Status](#) page. Click the [Powerline Network](#) icon to see the Powerline Device List.

Powerline Device List

List of all Powerline devices in the current powerline network.

	Local Device				
		00-0A-EB-10-16-22	RX:36Mbps	TX:7Mbps	

[+](#)

[Back](#) [Refresh](#)

3. Click the **add** icon  and enter the **Powerline Key** of the device you want to add. The Powerline Key contains 16 capital letters, formed like XXXX-XXXX-XXXX-XXXX. It is printed on the back of the powerline device.

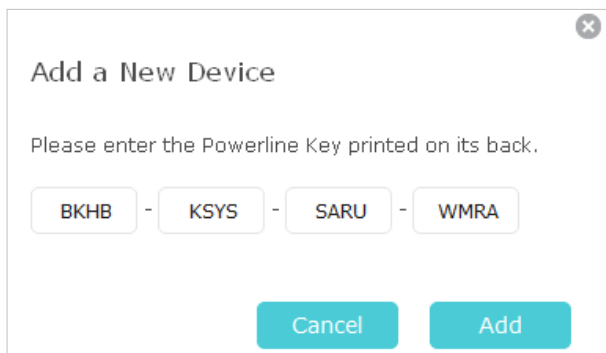

A dialog box titled "Add a New Device" with a close button (x) in the top right corner. Below the title, it says "Please enter the Powerline Key printed on its back." There are four input fields, each containing a four-letter code: "BKHB", "KSYS", "SARU", and "WMRA", separated by hyphens. At the bottom, there are two buttons: "Cancel" and "Add".

4. Click **Add** to add the device.

3.2.2. Change Powerline Network Name

You can change the extender's powerline network name to add it to or remove it from a powerline network.

Follow the steps below to change the name.

1. Connect to the powerline extender wirelessly. Visit <http://tplinkplc.net>, and log in with the username and password you set for the extender.
2. Go to **Device Settings > Powerline**.

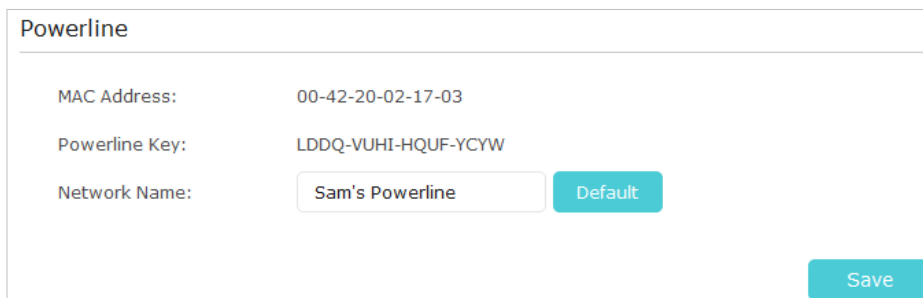

The "Powerline" settings page. It shows the following information:

MAC Address:	00-42-20-02-17-03
Powerline Key:	LDDQ-VUHI-HQUF-YCYW
Network Name:	<input type="text" value="Sam's Powerline"/> <input type="button" value="Default"/>

At the bottom right, there is a **Save** button.

3. Change the **Network Name**. You can also click **Default** to use the default network name, e.g. HomePlugAV. However, if the default name is used, the Wi-Fi Move function will be automatically disabled.
4. Click **Save** to make the settings effective.

3.3. Wi-Fi Move

Wi-Fi Move is enabled by default. With the feature enabled, any changes made to the Wi-Fi settings of one powerline extender will be automatically synchronized to other powerline extenders whose Wi-Fi Move feature is also enabled on the same powerline network.

Follow the steps below to enable the Wi-Fi Move feature:

1. Connect to the powerline extender wirelessly. Visit <http://tplinkplc.net>, and log in with the username and password you set for the extender.
2. Go to **Wireless > Wi-Fi Move**.
3. Toggle **On** to enable the feature.



Note:

When Wi-Fi Move is enabled, the following features will be synced: Wireless SSID & Password; Wireless Security; Wireless Mode; Wireless Radio Status; Wi-Fi Schedules; LED Schedules; Wi-Fi Clone Settings; MAC Filter Settings; Parental Controls, Guest Network.

3.4. Wi-Fi Clone

I want to: Copy wireless settings from my router to my extender, so I can use the same SSID and password to access the internet in my house.

How can I do that?

1. Connect to the powerline extender wirelessly. Visit <http://tplinkplc.net>, and log in with the username and password you set for the extender.
2. Go to **Wireless > Wi-Fi Clone**.
3. Select a Wi-Fi band or both to be cloned. **2.4GHz & 5GHz** is selected by default.



4. Before cloning, make sure your router supports the same band as your extender. If you do not know how to check this, go to your router's User Guide for more information.
5. Plug your extender near your router.
6. Press the **WPS** button on your router.

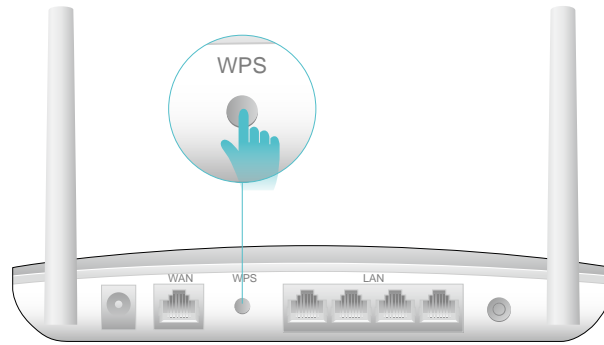

Wireless Router

7. Within two minutes, press the **Wi-Fi** button on the side panel of the extender.

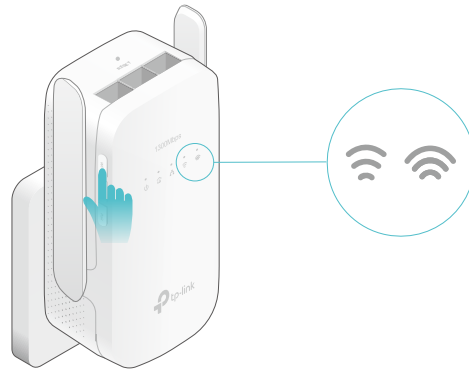

Done!

When the corresponding Wi-Fi LED blinks quickly for 3 seconds and then stays on. It's done!

3. 5. Wireless Network

3. 5. 1. Customize Wireless Settings

The powerline extender's wireless network name (SSID) and password, and security option are preset in the factory. The preset SSID and password can be found on the product label and Wi-Fi Info Card. You can customize the wireless settings according to your needs.

Connect to the powerline extender wirelessly. Visit <http://tplinkplc.net>, and log in with the username and password you set for the extender.

Go to **Wireless > Settings** page.

To enable or disable the wireless function:

Select the box to enable the wireless Radio of 2.4GHz or 5GHz. Deselect the box to disable wireless function. If disabled, all wireless settings will be ineffective.

Wireless		2.4GHz 5GHz
2.4GHz:	<input checked="" type="checkbox"/>	Enable Wireless Radio

To change the wireless network name (SSID) and wireless password:

The default SSID is TP-LINK_XXXX for 2.4GHz network and TP-LINK_XXXX_5G for 5GHz network, and the default password is printed on the Wi-Fi Info Card. You can change the default ones by directly entering new ones in the field. SSID is up to 32 characters, and the value in both SSID and password is case-sensitive.

Note:

Remember to write down the new SSID and password, for you may be disconnected when new settings are effective.

Network Name (SSID):	TP-LINK_1702
Password:	12345670

To hide SSID:

Select Hide SSID, and your SSID will not be broadcasted. It won't display when you scan for local wireless network list on your wireless device and you need to manually join the network.

Network Name (SSID):	TP-LINK_1702	<input checked="" type="checkbox"/> Hide SSID
----------------------	--------------	---

To have more advanced settings

Click [Advanced](#) below [Password](#) to have more advanced settings.

 Advanced
--

Security:	<input type="text" value="WPA/WPA2-Personal (Recommended)"/>
Version:	<input checked="" type="radio"/> Auto <input type="radio"/> WPA-PSK <input type="radio"/> WPA2-PSK
Encryption:	<input type="radio"/> Auto <input type="radio"/> TKIP <input checked="" type="radio"/> AES
Mode:	<input type="text" value="802.11b/g/n mixed"/>
Channel Width:	<input checked="" type="radio"/> Auto <input type="radio"/> 20MHz <input type="radio"/> 40MHz
Channel:	<input type="text" value="Auto"/>
Transmit Power:	<input type="radio"/> Low <input type="radio"/> Middle <input checked="" type="radio"/> High

Security: Select an option from the Security drop-down list. The extender provides three options, No Security, WPA/WPA2 Personal (Recommended), and WEP. WPA2 uses the newest standard and the security level is the highest. We don't recommend you to change the default settings unless necessary.

Mode: Select the desired mode.

- 802.11n only: Select only if all of your wireless clients are 802.11n devices.
- 802.11g/n mixed: Select if you are using both 802.11g and 802.11n wireless clients.
- 802.11b/g/n mixed: Select if you are using a mix of 802.11b, 11g, and 11n wireless clients.

Note: When 802.11n only mode is selected, only 802.11n wireless clients can connect to the extender. It is strongly recommended that you select 802.11b/g/n mixed, and all of 802.11b, 802.11g, and 802.11n wireless clients can connect to the extender.

- 802.11ac only (5GHz): Select only if all of your wireless clients are 802.11ac devices.
- 802.11n/ac mixed (5GHz): Select if you are using both 802.11n and 802.11ac wireless clients.
- 802.11a/n/ac mixed (5Ghz): Select if you are using a mix of 802.11ac, 802.11n and 802.11ac wireless clients. It is strongly recommended that you select 11a/n/ac mixed.

Channel Width: Select the channel width. The default setting is Auto, which can adjust the channel width for your clients automatically.

Channel: Select the channel you want to use from the drop-down list. This field determines which operating frequency will be used. It is not necessary to change the wireless channel unless you notice interference problems with another nearby access point.

Transmit Power: Select the level of transmit power. We recommend you choose **High** to have the best signal strength.

3.5.2. Wireless Clients

Follow the steps below to view detailed information of all wireless clients connected to the extender.

1. Connect to the powerline extender wirelessly. Visit <http://tplinkplc.net>, and log in with the username and password you set for the extender.
2. Go to [Wireless > Clients](#) page.

Online Wireless Clients					
Total Clients: 1					
ID	Device Name	IP Address	MAC Address	Wireless Band	Security
1	TP-Link	192.168.0.101	CC-08-8D-19-0A-35	2.4GHz	WPA2-PSK

3. Now you can view the detailed information, including device name, IP address, MAC address, connected wireless band and security type.

 **Tips:** You can also see the wireless details by clicking the wireless clients icon on [Status > Wireless Clients](#).



3.6. LED Schedules

I want to: Automatically turn off LEDs at times when I do not want light in my room.

For example, I want to turn LEDs off everyday from 00:00am to 7:00am.

How can I do that?

1. Connect to the powerline extender wirelessly. Visit <http://tplinkplc.net> and log in with the username and password you set.
2. Go to [Device Settings > LED Schedules](#).
3. Toggle **On** to enable the LED Scheduler.

LED Schedules							
Note: Please make sure the time settings are correct before using this function.							
LED Scheduler:				<input checked="" type="checkbox"/>			
LED Off Schedules							
 Add  Delete							
<input type="checkbox"/>	ID	From	To	Day(s)	Status	Modify	
<input type="checkbox"/>	--	--	--	--	--	--	

4. Click [Add](#) to add an entry.
5. Choose [LED Off Time](#) from 00:00 to 7:00, and then check all boxes from Sunday to Saturday.

Note: Please make sure that the system time is correct before using this function.

6. Click [Enable this entry](#) to make it effective.

LED Off Schedules

+ Add - Delete

<input type="checkbox"/>	ID	From	To	Day(s)	Status	Modify
--	--	--	--	--	--	--

LED Off Time: -

Repeat Every: Sun. Mon. Tue. Wed. Thu. Fri. Sat.

[Enable this entry](#)

Cancel
OK

7. Click [OK](#) to save the settings.

Done!

Now your LEDs will be turned off automatically at 00:00 and turned on at 7:00am the next morning.

3. 7. Schedule Your Wireless Function

I want to:

Automatically turn off my wireless network at times when I do not need the wireless connection.

For example, I want to turn them off from 00:00am to 7:00am. Yet if I have my wireless devices connected to the extender at that time, I want the wireless on till all devices are disconnected from the internet.

How can I do that?

1. Connect to the powerline extender wirelessly. Visit <http://tplinkplc.net> and log in with the username and password you set.
2. Go to [Wireless](#) > [Wi-Fi Schedules](#).

Wi-Fi Schedules

Note: Please make sure the time settings are correct before using this function.

Wi-Fi Scheduler:

Do not turn off Wi-Fi while clients are connected to it.

[Save](#)

Wi-Fi Off Schedules

[+ Add](#) [- Delete](#)

<input type="checkbox"/>	ID	From	To	Day(s)	Status	Modify
--	--	--	--	--	--	--

3. Toggle **On** to enable the Wi-Fi Scheduler. If you are prompted like the following picture, click **Continue**.

✕



Changes made to the Wi-Fi Settings will be synchronized across powerline extenders whose Wi-Fi Move function is enabled. Are you sure you want to continue?

Don't ask me again

Cancel
Continue

4. Check the box of **Do not turn off Wi-Fi while clients are connected to it** and click **Save**.
5. Click **Add** to add an entry.
6. Choose 00:00 and 7:00 from the drop-down list. Check all boxes from Sunday to Saturday.

Note: Please make sure that the system time is correct before using this function.
7. Click **Enable this entry** to make it effective.

Wi-Fi Off Schedules

+ Add - Delete

<input type="checkbox"/>	ID	From	To	Day(s)	Status	Modify
<input type="checkbox"/>	--	--	--	--	--	--

Wi-Fi Off Time: 0:00 - 7:00

Repeat Every: Sun. Mon. Tue. Wed. Thu. Fri. Sat.

Enable this entry

Cancel OK

8. Click **OK** to save the settings.

Done!

Now your Wi-Fi will be automatically turned off at 00:00 and turned on at 7:00am the next morning.

Note:

The Wi-Fi LED will turn off if the wireless network is disabled.

3. 8. Parental Controls

I want to:

Control when my children's wireless devices can access the internet.

For example, I want to allow my children's wireless devices to access only from 18:00 (6PM) to 22:00 (10PM) on weekdays and not other times.

How can I do that?

1. Connect to the powerline extender wirelessly. Visit <http://tplinkplc.net>, and log in with the username and password you set for the extender.
2. Go to **Parental Controls**.

Parental Controls

Parental Controls:

Devices Under Parental Controls

+ Add - Delete

<input type="checkbox"/>	ID	MAC Address	Internet Access Time	Description	Status	Modify
<input type="checkbox"/>	--	--	--	--	--	--

- Toggle **On** to enable Parental Controls. If you are prompted like the following picture, click **Continue**.

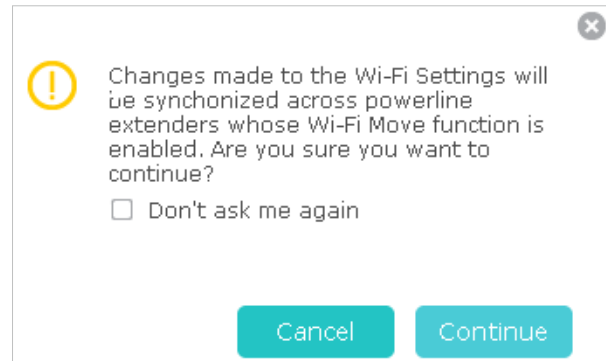

- Click **Add**.
- Click **View Existing Devices**, and select the device to be controlled. Or, enter the **MAC Address** manually.
- Click the  icon to set the Internet Access Time. Drag the cursor over the appropriate cell(s) and click **Save**.

Note: Please make sure that the system time is correct before using this function.



- Enter a **Description** for the entry.
- Click **Enable this entry** to make it effective.

Devices Under Parental Controls

+ Add - Delete

<input type="checkbox"/>	ID	MAC Address	Internet Access Time	Description	Status	Modify
--	--	--	--	--	--	--

MAC Address:

Internet Access Time:

Description: (Optional)

Enable this Entry

9. Click **OK** to save the settings.

Done!

Now the controlled device can access only from 18:00 (6PM) to 22:00 (10PM) on weekdays and not other times.

3.9. Guest Network

I want to:

Create a network for my guests, providing internet access for them while at the same time limit the network authorities for guests to ensure network security and privacy.

How can I do that?

1. Connect to the powerline extender wirelessly. Visit <http://tplinkplc.net>, and log in with the password you set for the extender.
2. Go to [Guest Network](#).
3. Check the box of relative entry to limit network authorities. If you have problems understanding these items, click the question mark on the upper right corner to have more information.
4. Click **Save** to make the settings effective.

Guest Network

Allow guests to see each other

Do not allow guests to manage my network

Automatic disable after

- Click [2.4GHz](#) or [5GHz](#) to choose a wireless band, and configure the following settings.

Guest Network Settings 2.4GHz | 5GHz

2.4GHz: Enable Guest Network

Network Name (SSID):

Security: No Security WPA/WPA2-Personal

Password:

[Save](#)

To enable or disable the guest network function:

Select the box to enable the guest network function. Deselect the box to disable guest network function. If disabled, all guest network settings of the corresponding band will be ineffective.

To change the guest network name (SSID) and password:

The default SSID is TP-LINK_Guest_XXXX for 2.4GHz guest network and TP-LINK_Guest_XXXX_5G for 5GHz guest network. The default password is the same as the host network's, which is printed on the Wi-Fi Info Card. You can change the default ones by directly entering new ones in the field. SSID is up to 32 characters, and the value in both SSID and password is case-sensitive.

Done!

Now you can tell your guests to connect to the guest network you created.

3. 10. MAC Filter

This function exploits the uniqueness of the MAC (Medium Access Control) address, a unique 12-digit hexadecimal address (for example, D8-5D-4C-B4-46-EA) of every network device, to determine if the device can or cannot access your wireless network.

I want to:

Prevent unauthorized users from accessing my wireless network by utilizing the network device's MAC address.

[For example](#), I have a computer that is connected to my wireless network. Now, an unknown device (an intruder) is also using my wireless network, which affects my internet speed. I would like to control my wireless network with the following capabilities:

- My computer is always allowed to access the wireless network.

How can I do that?

- The unknown device is not allowed to access the wireless network.
 - I don't have to keep changing my wireless password as often.
1. Connect to the powerline extender wirelessly. Visit <http://tplinkplc.net>, and log in with the username and password you set for the extender.
 2. Go to [Wireless > MAC Filter](#).
 3. Toggle [On](#) to enable MAC Filter.
 4. Select either of the filtering rules and click [Save](#). Here we select [Block wireless access from the devices listed below](#) and then click [Save](#).

MAC Filter Settings

MAC Filter:

MAC Filter

Select the filtering rule: [Block wireless access from the devices in the list below.](#)
 [Allow wireless access only from the devices in the list below.](#)

[Save](#)

5. Click [Add](#) under Device List to add devices to the list.

Device List

[+ Add](#) [- Delete](#)

<input type="checkbox"/>	ID	MAC Address	Description	Status	Modify
--	--	--	--	--	--

MAC Address: [View Devices](#)

Description: (Optional)

Enable this entry

[Cancel](#) [OK](#)

6. Click [View Devices](#) to see how many devices are now connected to the network. Click [Choose](#) to choose a device. You can also enter the [MAC Address](#) manually.
7. Give a description of the entry in the [Description](#) field. (Optional)

8. Click [Enable this entry](#) to make this entry effective.
9. Click [OK](#) to save the settings.

Done! Now MAC Filter is implemented to protect your wireless network.

3. 11. Administration

3. 11. 1. LAN IP Address

Follow the steps below to configure LAN settings of the extender.

Connect to the powerline extender wirelessly. Visit <http://tplinkplc.net>, and log in with the username and password you set for the extender.

Go to [Device Settings](#) > [LAN Settings](#).

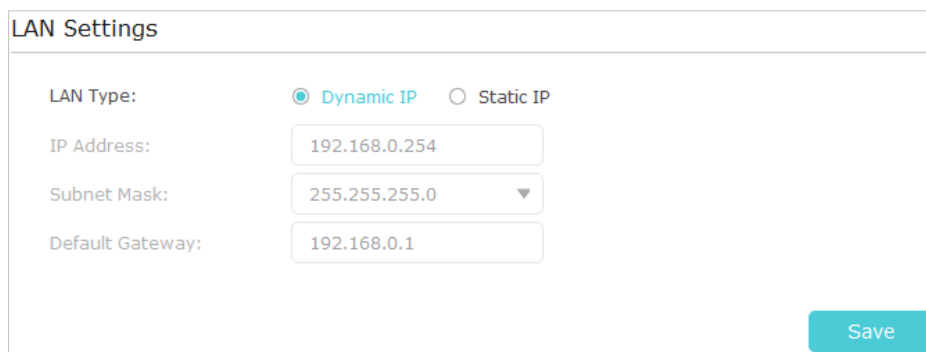

LAN Settings	
LAN Type:	<input checked="" type="radio"/> Dynamic IP <input type="radio"/> Static IP
IP Address:	<input type="text" value="192.168.0.254"/>
Subnet Mask:	<input type="text" value="255.255.255.0"/>
Default Gateway:	<input type="text" value="192.168.0.1"/>

[Save](#)

LAN Type: Select [Dynamic IP](#) to have your extender automatically obtain IP Address from the main router. Select [Static IP](#) to manually configure the LAN parameters.

IP Address: The IP address of the powerline extender.

Subnet Mask: The subnet mask associated with IP address.

Default Gateway: The IP address of the gateway device.

3. 11. 2. Set Up System Time

System time is the time displayed while the extender is running. The system time you configure here will be used for other time-based functions like Parental Controls, Wi-Fi Schedules. You can manually set how to get the system time.

Connect to the powerline extender wirelessly. Visit <http://tplinkplc.net>, and log in with the username and password you set for the extender.

Go to [System Tools](#) > [Time Settings](#) page.

Time Settings

Time Zone: (GMT) Greenwich Mean Time, Dublin, London ▼

Date: 01/01/2016 DD/MM/YY

Time: 00 ▼ : 38 ▼ : 24 ▼ (HH/MM/SS)

NTP Server I: 0.0.0.0 (Optional)

NTP Server II: 0.0.0.0 (Optional)

Get GMT

Save

To automatically synchronize the time:

1. Select your local [Time Zone](#) from the drop-down menu.
2. In the [NTP Server I](#) field, enter the IP address or domain name of your desired NTP Server. (Optional)
3. In the [NTP Server II](#) field, enter the IP address or domain name of the second NTP Server. (Optional)
4. Click [Get GMT](#) and click [Save](#).

To manually set the date and time:

1. In the [Time Settings](#) field, select your local [Time Zone](#).
2. Enter the current [Date](#).
3. Set the current [Time](#) (In 24-hour clock format, e.g. 16:00:00 is 04:00PM).
4. Click [Save](#).

To set up Daylight Saving time:

Daylight-Saving Time

Daylight-Saving Time: Enable Daylight Saving

Start: 2016 Mar. ▼ M Last ▼ W Sun. ▼ D 1a.m. ▼ H

End: 2016 Oct. ▼ M Last ▼ W Sun. ▼ D 2a.m. ▼ H

Daylight saving is down

Save

1. Select [Enable Daylight Saving](#).
2. Select the correct [Start](#) date and time when daylight saving time starts at your local time zone.

3. Select the correct [End](#) date and time when daylight saving time ends at your local time zone.
4. Click [Save](#).

3. 11. 3. Upgrade the Firmware

TP-Link is dedicated to improving and enriching the product features, giving you a better network experience. We will release the latest firmware at TP-Link official website, you can download the latest firmware file from our website: www.tp-link.com and upgrade the firmware to the latest version.

To upgrade the firmware online:

1. Connect to the powerline extender wirelessly. Visit <http://tplinkplc.net>, and log in with the username and password you set for the extender.
2. If there's any firmware update available for your extender, the update icon  will display on the top-right corner of the page. Click the icon to go to the Firmware Upgrade page.

Alternatively, you can go to [System Tools](#) > [Firmware Upgrade](#) page and click [Check for Upgrade](#) to see if there's any new firmware.



3. Focus on the [Online Upgrade](#) section, and click [Upgrade](#).



4. Wait a few moments for the upgrading and rebooting.

Note:

1. Before upgrading the firmware, it's better to back up your current settings.
2. During the upgrading process, do not turn off or reset the extender.

To upgrade the firmware manually:

1. Connect to the powerline extender wirelessly. Visit <http://tplinkplc.net>, and log in with the username and password you set for the extender.

2. Go to [System Tools > Firmware Upgrade](#) page and confirm the [Hardware Version](#).

The screenshot shows a 'Manual Upgrade' section with the following details:

- New Firmware File:** An empty text input field with a 'Browse' button to its right.
- Firmware Version:** 2.0.0 Build 20181103 Rev.70084
- Hardware Version:** TL-WPA8630 v2.0
- Upgrade:** A teal button located at the bottom right of the section.

3. Go to www.tp-link.com. Download the latest firmware file for the extender.

■ **Note:** The upgraded firmware version must correspond to the hardware.

4. Click [Browse](#) to locate the downloaded new firmware file, and click [Upgrade](#).

5. Wait a few minutes for the upgrading and rebooting.

■ **Note:**

1. Before upgrading the firmware, it's better to back up your current settings.
2. During the upgrading process, do not turn off or reset the extender.

3. 11. 4. Backup and Restore Configuration Settings

The configuration settings are stored as a configuration file in the extender. You can back up the configuration file to your computer for future use and restore the extender to a previous settings from the backup file when needed. Moreover, if needed, you can erase the current settings and reset the extender to the default factory settings.

To backup configuration settings:

1. Connect to the powerline extender wirelessly. Visit <http://tplinkplc.net>, and log in with the username and password you set for the extender.
2. Go to [System Tools > Backup & Restore](#) page.

The screenshot shows a 'Backup' section with the following details:

- Backup:** The title of the section.
- Save a copy of your current settings.** A message indicating the purpose of the backup.
- Backup:** A teal button located at the bottom right of the section.

3. Click [Backup](#) to save a copy of the current settings to your local computer. A [config.bin](#) file will be stored to your computer.

To restore configuration settings:

1. Connect to the powerline extender wirelessly. Visit <http://tplinkplc.net>, and log in with the username and password you set for the extender.
2. Go to [System Tools > Backup & Restore](#) page.

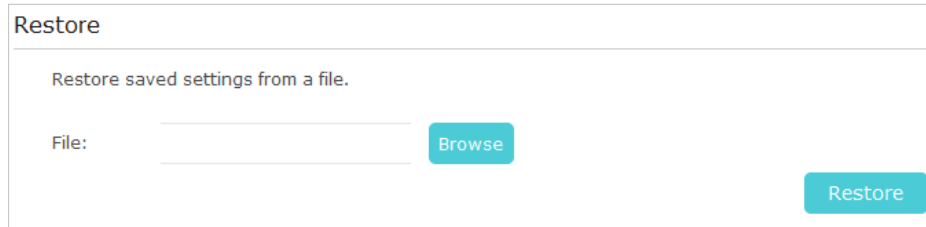

Restore

Restore saved settings from a file.

File:

3. Click [Browse](#) to locate the backup configuration file stored on your computer, and click [Restore](#). The configuration file is config.bin.

4. Wait a few minutes for the restoring and rebooting.

■ **Note:** During the restoring process, do not turn off or reset the extender.

To reset the extender to factory default settings:

1. Connect to the powerline extender wirelessly. Visit <http://tplinkplc.net>, and log in with the username and password you set for the extender.

2. Go to [System Tools](#) > [Backup & Restore](#) page.

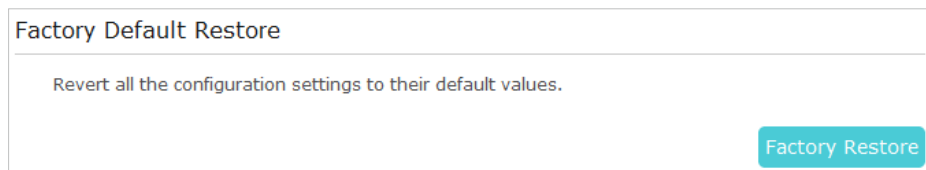

Factory Default Restore

Revert all the configuration settings to their default values.

3. Click [Factory Restore](#) to reset the extender.

4. Wait a few minutes for the resetting and rebooting.

■ **Note:**

1. During the resetting process, do not turn off the extender.

2. We strongly recommend you back up the current configuration settings before resetting the extender.

3.11.5. System Log

When the extender does not work properly, you can save the system log and send it to the technical support for troubleshooting.

Follow the steps below to save the system log:

1. Connect to the powerline extender wirelessly. Visit <http://tplinkplc.net>, and log in with the username and password you set for the extender.

2. Go to [System Tools](#) > [System Log](#).

System Log

Log Filter: Type= and Level =

[Refresh](#) [Delete All](#)

ID	Time	Type	Level	Log Content
1	0 days 00:41:09	OTHERS	INFO	User cleared up all the logs.

[Save Log](#)

3. Choose the type and level of the system log according to your need.
4. Click [Save Log](#) to save the system log to local.

COPYRIGHT & TRADEMARKS

Specifications are subject to change without notice.  **tp-link** is a registered trademark of TP-Link Technologies Co., Ltd. Other brands and product names are trademarks or registered trademarks of their respective holders.

No part of the specifications may be reproduced in any form or by any means or used to make any derivative such as translation, transformation, or adaptation without permission from TP-Link Technologies Co., Ltd. Copyright © 2017 TP-Link Technologies Co., Ltd. All rights reserved.

CE Mark Warning



This is a class B product. In a domestic environment, this product may cause radio interference, in which case the user may be required to take adequate measures.

RF Exposure Information

This device meets the EU requirements (1999/5/EC Article 3.1a) on the limitation of exposure of the general public to electromagnetic fields by way of health protection.

The device complies with RF specifications when the device used at 20 cm from your body.

Restricted to indoor use.

Safety Information

- When product has power button, the power button is one of the way to shut off the product; when there is no power button, the only way to completely shut off power is to disconnect the product or the power adapter from the power source.
- Don't disassemble the product, or make repairs yourself. You run the risk of electric shock and voiding the limited warranty. If you need service, please contact us.
- Avoid water and wet locations.
- Alert to service person

CAUTION

DOUBLE POLE / NEUTRAL FUSING

Explanation of the symbols on the product label

Symbol	Explanation
A wavy line symbol representing AC voltage.	AC voltage
A symbol for Waste Electrical and Electronic Equipment (WEEE), showing a crossed-out wheeled bin with a recycling symbol inside.	RECYCLING This product bears the selective sorting symbol for Waste electrical and electronic equipment (WEEE). This means that this product must be handled pursuant to European directive 2012/19/EU in order to be recycled or dismantled to minimize its impact on the environment. User has the choice to give his product to a competent recycling organization or to the retailer when he buys a new electrical or electronic equipment.
A simple outline of a house, indicating that the product is for indoor use only.	Indoor use only

FCC Statement:

Federal Communication Commission Interference Statement

This equipment has been tested and found to comply with the limits for a Class B digital device, pursuant to Part 15 of the FCC Rules. These limits are designed to provide reasonable protection against harmful interference in a residential installation. This equipment generates, uses and can radiate radio frequency energy and, if not installed and used in accordance with the instructions, may cause harmful interference to radio communications. However, there is no guarantee that interference will not occur in a particular installation. If this equipment does cause harmful interference to radio or television reception, which can be determined by turning the equipment off and on, the user is encouraged to try to correct the interference by one of the following measures:

- Reorient or relocate the receiving antenna.
- Increase the separation between the equipment and receiver.
- Connect the equipment into an outlet on a circuit different from that to which the receiver is connected.
- Consult the dealer or an experienced radio/TV technician for help.

FCC Caution: Any changes or modifications not expressly approved by the party responsible for compliance could void the user's authority to operate this equipment.

This device complies with Part 15 of the FCC Rules. Operation is subject to the following two conditions: (1) This device may not cause harmful interference, and (2) this device must accept any interference received, including interference that may cause undesired operation.

For product available in the USA/Canada market, only channel 1~11 can be operated. Selection of other channels is not possible.

This device is restricted for indoor use.

IMPORTANT NOTE:

FCC Radiation Exposure Statement:

This equipment complies with FCC radiation exposure limits set forth for an uncontrolled environment. This equipment should be installed and operated with minimum distance 20cm between the radiator & your body.

IC Statement:

This device complies with Industry Canada license-exempt RSS standard(s). Operation is subject to the following two conditions: (1) this device may not cause interference, and (2) this device must accept any interference, including interference that may cause undesired operation of the device.

Le présent appareil est conforme aux CNR d'Industrie Canada applicables aux appareils radio exempts de licence.

L'exploitation est autorisée aux deux conditions suivantes : (1) l'appareil ne doit pas produire de brouillage, et (2)

l'utilisateur de l'appareil doit accepter tout brouillage radioélectrique subi, même si le brouillage est susceptible d'en compromettre le fonctionnement.

For product available in the USA/Canada market, only channel 1~11 can be operated. Selection of other channels is not possible.

Pour les produits disponibles aux États-Unis / Canada du marché, seul le canal 1 à 11 peuvent être exploités. Sélection d'autres canaux n'est pas possible.

The device for operation in the band 5150–5250 MHz is only for indoor use to reduce the potential for harmful interference to co-channel mobile satellite systems.

les dispositifs fonctionnant dans la bande 5150-5250 MHz sont réservés uniquement pour une

utilisation à l'intérieur afin de réduire les risques de brouillage préjudiciable aux systèmes de satellites mobiles utilisant les mêmes canaux.

IMPORTANT NOTE:

IC Radiation Exposure Statement:

This equipment complies with IC RSS-102 radiation exposure limits set forth for an uncontrolled environment. This equipment should be installed and operated with minimum distance 20cm between the radiator & your body.

Cet équipement est conforme aux limites d'exposition aux rayonnements IC établies pour un environnement non contrôlé. Cet équipement doit être installé et utilisé avec un minimum de 20 cm de distance entre la source de rayonnement et votre corps.