

TP-LINK®

User Guide

TL-WR841HP

300Mbps High Power Wireless N Router



COPYRIGHT & TRADEMARKS

Specifications are subject to change without notice. **TP-LINK®** is a registered trademark of TP-LINK TECHNOLOGIES CO., LTD. Other brands and product names are trademarks or registered trademarks of their respective holders.

No part of the specifications may be reproduced in any form or by any means or used to make any derivative such as translation, transformation, or adaptation without permission from TP-LINK TECHNOLOGIES CO., LTD. Copyright © 2015 TP-LINK TECHNOLOGIES CO., LTD. All rights reserved.

<http://www.tp-link.com>

FCC STATEMENT



This equipment has been tested and found to comply with the limits for a Class B digital device, pursuant to part 15 of the FCC Rules. These limits are designed to provide reasonable protection against harmful interference in a residential installation. This equipment generates, uses and can radiate radio frequency energy and, if not installed and used in accordance with the instructions, may cause harmful interference to radio communications. However, there is no guarantee that interference will not occur in a particular installation. If this equipment does cause harmful interference to radio or television reception, which can be determined by turning the equipment off and on, the user is encouraged to try to correct the interference by one or more of the following measures:

- Reorient or relocate the receiving antenna.
- Increase the separation between the equipment and receiver.
- Connect the equipment into an outlet on a circuit different from that to which the receiver is connected.
- Consult the dealer or an experienced radio/ TV technician for help.

This device complies with part 15 of the FCC Rules. Operation is subject to the following two conditions:

- 1) This device may not cause harmful interference.
- 2) This device must accept any interference received, including interference that may cause undesired operation.

Any changes or modifications not expressly approved by the party responsible for compliance could void the user's authority to operate the equipment.

Note: The manufacturer is not responsible for any radio or TV interference caused by

unauthorized modifications to this equipment. Such modifications could void the user's authority to operate the equipment.

FCC RF Radiation Exposure Statement:

This equipment complies with FCC RF radiation exposure limits set forth for an uncontrolled environment. This device and its antenna must not be co-located or operating in conjunction with any other antenna or transmitter.

“To comply with FCC RF exposure compliance requirements, this grant is applicable to only Mobile Configurations. The antennas used for this transmitter must be installed to provide a separation distance of at least 20 cm from all persons and must not be co-located or operating in conjunction with any other antenna or transmitter.”

Korea Warning Statements

당해 무선설비는 운용중 전파혼신 가능성이 있음.



Продукт сертифіковано згідно с правилами системи УкрСЕПРО на відповідність вимогам нормативних документів та вимогам, що передбачені чинними законодавчими актами України.



Safety Information

- When product has power button, the power button is one of the way to shut off the product; when there is no power button, the only way to completely shut off power is to disconnect the product or the power adapter from the power source.
- Don't disassemble the product, or make repairs yourself. You run the risk of electric shock and voiding the limited warranty. If you need service, please contact us.
- Avoid water and wet locations.

This product can be used in the following countries:

AT	BG	BY	CA	CZ	DE	DK	EE
ES	FI	FR	GB	GR	HU	IE	IT
LT	LV	MT	NL	NO	PL	PT	RO
RU	SE	SK	TR	UA	US		

CONTENTS

Package Contents	1
Chapter 1. Introduction.....	2
1.1 Overview of the Router	2
1.2 Conventions	3
1.3 Main Features	3
1.4 Panel Layout	4
1.4.1 The Front Panel	4
1.4.2 The Rear Panel.....	5
Chapter 2. Connecting the Router.....	6
2.1 System Requirements.....	6
2.2 Installation Environment Requirements	6
2.3 Connecting the Router	6
Chapter 3. Quick Installation Guide	9
3.1 TCP/IP Configuration	9
3.2 Quick Installation Guide	11
Chapter 4. Configuring the Router	20
4.1 Login.....	20
4.2 Status	20
4.3 Quick Setup.....	21
4.4 WPS	21
4.5 Network	24
4.5.1 WAN.....	24
4.5.2 MAC Clone	33
4.5.3 LAN	34
4.6 Wireless.....	35
4.6.1 Wireless Settings	35
4.6.2 Wireless Security	38
4.6.3 Wireless MAC Filtering	42
4.6.4 Wireless Advanced	44

4.6.5	Wireless Statistics	45
4.7	Guest Network	46
4.7.1	Wireless Settings	46
4.8	DHCP	48
4.8.1	DHCP Settings	48
4.8.2	DHCP Clients List	49
4.8.3	Address Reservation	49
4.9	Forwarding	51
4.9.1	Virtual Servers	51
4.9.2	Port Triggering	53
4.9.3	DMZ	55
4.9.4	UPnP	55
4.10	Security	57
4.10.1	Basic Security	57
4.10.2	Advanced Security	58
4.10.3	Local Management	60
4.10.4	Remote Management	61
4.11	Parental Control	62
4.12	Access Control	64
4.12.1	Rule	65
4.12.2	Host	67
4.12.3	Target	69
4.12.4	Schedule	71
4.13	Advanced Routing	72
4.13.1	Static Routing List	73
4.13.2	System Routing Table	74
4.14	Bandwidth Control	75
4.14.1	Control Settings	75
4.14.2	Rule List	75
4.15	IP & MAC Binding	76
4.15.1	Binding Settings	77

4.15.2 ARP List	78
4.16 Dynamic DNS.....	79
4.16.1 Comexe.cn DDNS	79
4.16.2 Dyndns.org DDNS	80
4.16.3 No-ip.com DDNS	81
4.17 System Tools.....	82
4.17.1 Time Settings	83
4.17.2 Diagnostic	84
4.17.3 Firmware Upgrade	86
4.17.4 Factory Defaults.....	87
4.17.5 Backup & Restore.....	87
4.17.6 Reboot	88
4.17.7 Password	89
4.17.8 System Log.....	89
4.17.9 Statistics.....	91
4.18 Logout	93
Appendix A: FAQ	94
Appendix B: Configuring the PC	99
Appendix C: Specifications	103
Appendix D: Glossary	104

Package Contents

The following items should be found in your package:

- TL-WR841HP 300Mbps High Power Wireless N Router
- DC Power Adapter for TL-WR841HP 300Mbps High Power Wireless N Router
- Quick Installation Guide
- Ethernet Cable
- Resource CD for TL-WR841HP 300Mbps High Power Wireless N Router, including:
 - This Guide
 - Other Helpful Information

 **Note:**

Make sure that the package contains the above items. If any of the listed items are damaged or missing, please contact your distributor.

Chapter 1. Introduction

1.1 Overview of the Router

The TL-WR841HP 300Mbps High Power Wireless N Router integrates 4-port Switch, Firewall, NAT-Router and Wireless AP. The 300Mbps High Power Wireless N Router delivers exceptional range and speed, which can fully meet the need of Small Office/Home Office (SOHO) networks and the users demanding higher networking performance.

Incredible Speed

The TL-WR841HP 300Mbps High Power Wireless N Router provides up to 300Mbps wireless connection with other 802.11n wireless clients. The incredible speed makes it ideal for handling multiple data streams at the same time, which ensures your network stable and smooth. The performance of this 802.11n wireless router will give you the unexpected networking experience at speed 650% faster than 802.11g. It is also compatible with all IEEE 802.11g and IEEE 802.11b products.

Multiple Security Protections

With multiple protection measures, including SSID broadcast control and wireless LAN 64/128/152-bit WEP encryption, Wi-Fi protected Access (WPA2-PSK, WPA-PSK), as well as advanced Firewall protections, the TL-WR841HP 300Mbps High Power Wireless N Router provides complete data privacy.

Flexible Access Control

The TL-WR841HP 300Mbps High Power Wireless N Router provides flexible access control, so that parents or network administrators can establish restricted access policies for children or staff. It also supports Virtual Server and DMZ host for Port Triggering, and then the network administrators can manage and monitor the network in real time with the remote management function.

Simple Installation

Since the router is compatible with virtually all the major operating systems, it is very easy to manage. Quick Setup Wizard is supported and detailed instructions are provided step by step in this user guide. Before installing the router, please look through this guide to know all the router's functions.

1.2 Conventions

The router or TL-WR841HP mentioned in this guide stands for TL-WR841HP 300Mbps High Power Wireless N Router without any explanation.

1.3 Main Features

- Complies with IEEE 802.11n to provide a wireless data rate of up to 300Mbps.
- One 10/100M Auto-Negotiation RJ45 WAN port, four 10/100M Auto-Negotiation RJ45 LAN ports, supporting Auto MDI/MDIX.
- Provides WPA/WPA2, WPA-PSK/WPA2-PSK authentication, TKIP/AES encryption security.
- Shares data and Internet access for users, supporting Dynamic IP/Static IP/PPPoE Internet access.
- Supports Virtual Server, Special Application and DMZ host.
- Supports UPnP, Dynamic DNS, Static Routing.
- Provides Automatic-connection and Scheduled Connection on certain time to the Internet.
- Built-in NAT and DHCP server supporting static IP address distributing.
- Built-in firewall supporting IP address filtering, Domain Name filtering, and MAC address filtering.
- Connects Internet on demand and disconnects from the Internet when idle for PPPoE.
- Provides 64/128/152-bit WEP encryption security and wireless LAN ACL (Access Control List).
- Supports Flow Statistics.
- Supports firmware upgrade and Web management.
- Supports Tether App to manage the router on smart devices.

1.4 Panel Layout

1.4.1 The Front Panel



Figure 1-1 Front Panel sketch

The router's LEDs are located on the front panel (View from left to right).

Name	Status	Indication
⏻ (Power)	Off	Power is off.
	On	Power is on.
⚙️ (System)	Flashing	The Router is working properly.
	On/Off	The Router has a system error.
📶 (WLAN)	Off	The Wireless function is disabled.
	Flashing	The Wireless function is enabled.
🌐 (WAN), 📶 (LAN 1-4)	Off	There is no device linked to the corresponding port.
	On	There is a device linked to the corresponding port but there is no activity.
	Flashing	There is an active device linked to the corresponding port.
🔒 (WPS)	Slow Flash	A wireless device is connecting to the network by WPS function. This process will last in the first 2 minutes.
	On	A wireless device has been successfully added to the network by WPS function.
	Quick Flash	A wireless device failed to be added to the network by WPS function.

Table 1-1 The LEDs description

👉 Note:

After a device is successfully added to the network by **WPS** function, the **WPS** LED will keep on for about 5 minutes and then turn off.

1.4.2 The Rear Panel

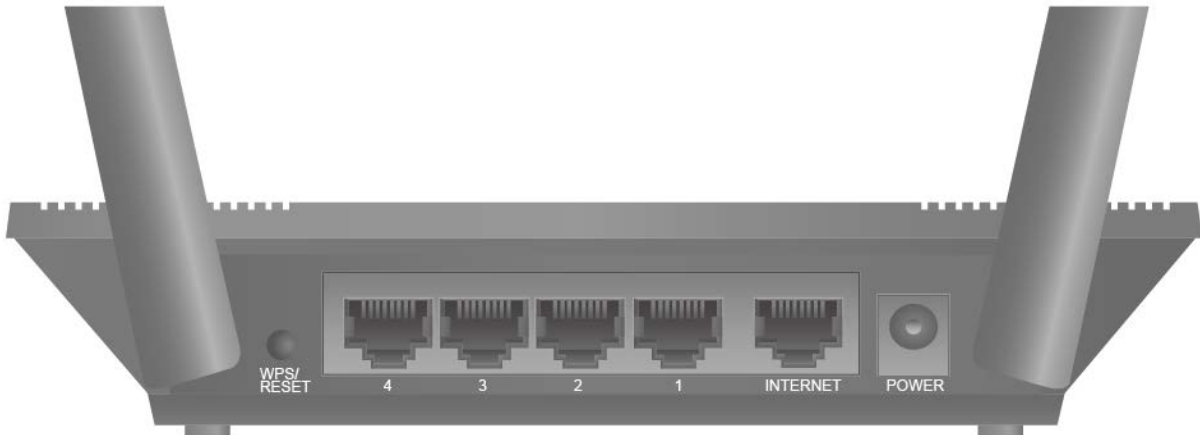

Figure 1-2 Rear Panel sketch

The following parts are located on the rear panel (View from right to left).

- **POWER:** The Power socket is where you will connect the power adapter. Please use the power adapter provided with this TL-WR841HP 300Mbps High Power Wireless N Router.
- **INTERNET:** This port is where you will connect the DSL/cable Modem or Ethernet.
- **1,2,3,4 (ETHERNET):** These ports (1,2,3,4) connect the Router to the local PC(s).
- **WPS/RESET:** This button is used for both WPS and Reset function. To use the WPS function, press it for less than five seconds; to use the RESET function, press it for more than five seconds.

- **Used as RESET button:**

There are two ways to reset to the Router's factory defaults:

- 1) Use the **Factory Defaults** function on **System Tools** -> **Factory Defaults** page in the Router's Web-based Utility.
- 2) Use the **WPS/RESET** button: With the Router powered on, press and hold the **WPS/RESET** button (more than 5 seconds) until the SYS LED becomes quick-flash from slow-flash. Then release the button and wait the Router to reboot to its factory default settings.

- **Used as WPS button:**

If you have client devices, such as wireless adapters, that support Wi-Fi Protected Setup, then you can press this button to quickly establish a connection between the Router and client devices and automatically configure wireless security for your wireless network.

- **Wireless antenna:** To receive and transmit the wireless data.

Chapter 2. Connecting the Router

2.1 System Requirements

- Broadband Internet Access Service (DSL/Cable/Ethernet)
- One DSL/Cable Modem that has an RJ45 connector (which is not necessary if the router is connected directly to the Ethernet.)
- PCs with a working Ethernet Adapter and an Ethernet cable with RJ45 connectors
- TCP/IP protocol on each PC
- Web browser, such as Microsoft Internet Explorer, Mozilla Firefox or Apple Safari

2.2 Installation Environment Requirements

- Place the router in a well ventilated place far from any heater or heating vent
- Avoid direct irradiation of any strong light (such as sunlight)
- Keep at least 2 inches (5 cm) of clear space around the router
- Operating Temperature: 0°C~40°C (32°F~104°F)
- Operating Humidity: 10%~90%RH, Non-condensing

2.3 Connecting the Router

If your Internet connection is through an Ethernet cable from the wall instead of through a DSL / Cable / Satellite modem, connect the Ethernet cable directly to the router's Internet port, then follow steps 4 and 5 to complete the hardware connection.

1. Install the antennas to the router and then use the supplied bracket to fix the position of the antennas in place for best Wi-Fi performance.
2. Turn off the modem and remove the backup battery if it has one.
3. Connect an Ethernet cable from the modem to the INTERNET port on your router.
4. Turn on the modem and then wait about 2 minutes for it to restart.

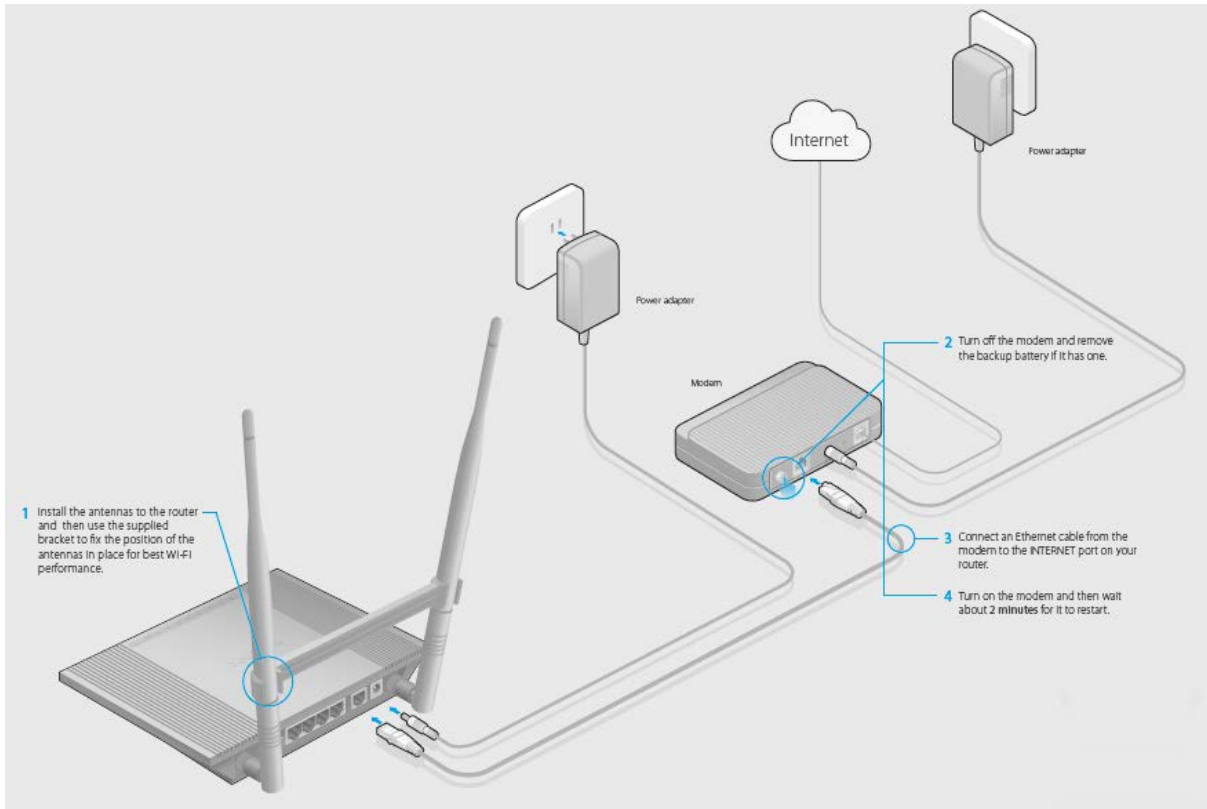
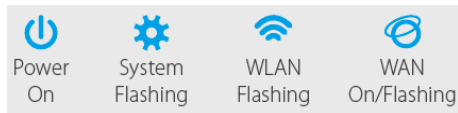
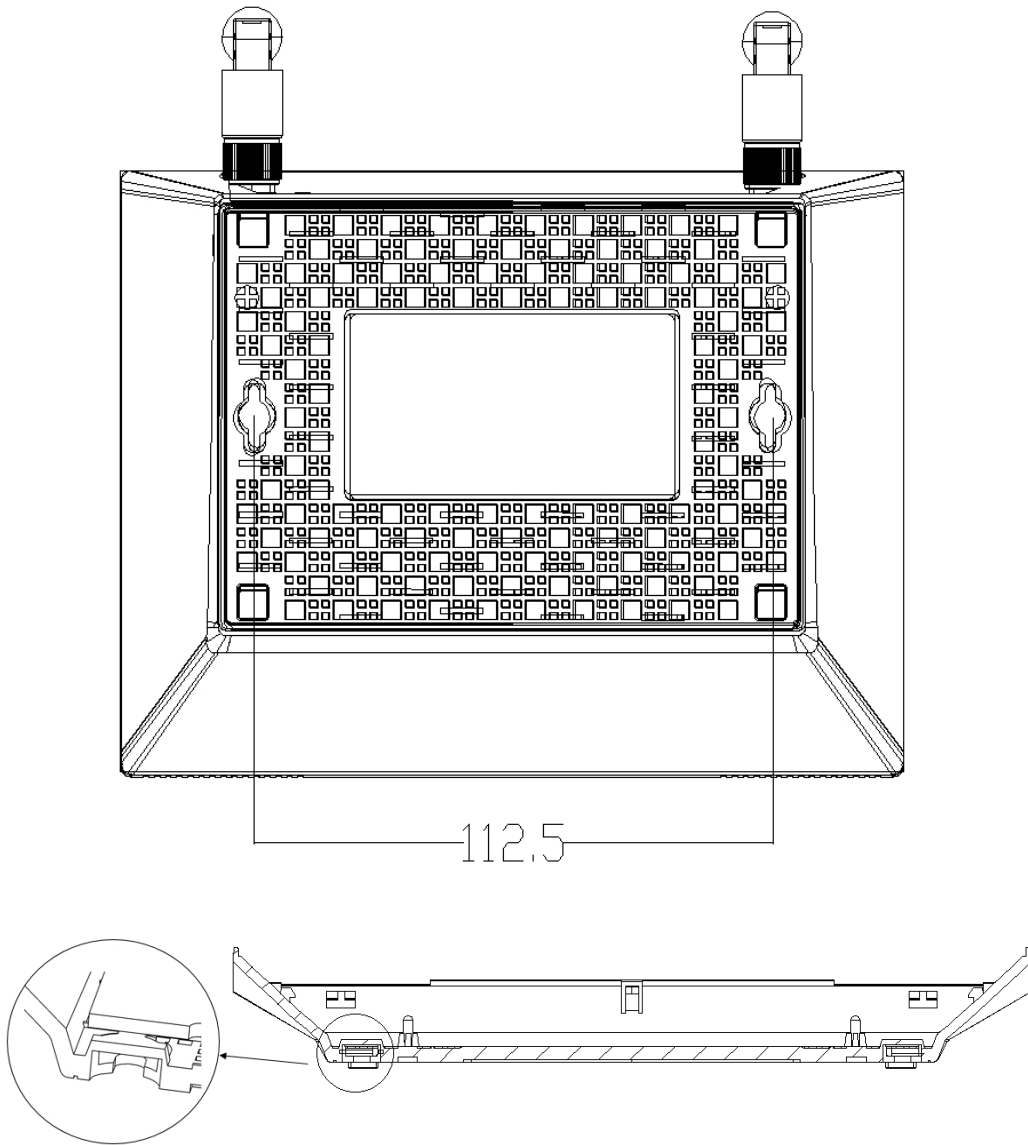

Figure 2-1 Hardware Installation

5. Verify that the hardware connection is correct by checking these LEDs.





Note:

The diameter of the screw ranges from 3.5 mm to 8 mm, and the distance between two screws is 112.5 mm. The screw that projects from the wall needs around 4.5 mm base, and the length of the screw needs to be at least 20 mm to withstand the weight of the product.

Chapter 3. Quick Installation Guide

This chapter will show you how to configure the basic functions of your TL-WR841HP 300Mbps High Power Wireless N Router using **Quick Setup Wizard** within minutes.

3.1 TCP/IP Configuration

The default domain name of the TL-WR841HP 300Mbps High Power Wireless N Router is <http://tplinkwifi.net>, the default IP address is 192.168.0.1, and the default Subnet Mask is 255.255.255.0. These values can be changed as you desire. In this guide, we use all the default values for description.

Connect the local PC to the LAN ports of the router. And then you can configure the IP address for your PC in the following two ways.

- Configure the IP address manually
 - 1) Set up the TCP/IP Protocol for your PC. If you need instructions as to how to do this, please refer to [Appendix B: Configuring the PC](#).
 - 2) Configure the network parameters. The IP address is 192.168.0.xxx ("xxx" is any number from 2 to 254), Subnet Mask is 255.255.255.0, and Gateway is 192.168.0.1 (The router's default IP address)
- Obtain an IP address automatically
 - 1) Set up the TCP/IP Protocol in "**Obtain an IP address automatically**" mode on your PC. If you need instructions as to how to do this, please refer to [Appendix B: Configuring the PC](#).
 - 2) Then the built-in DHCP server will assign IP address for the PC.

Now, you can run the Ping command in the **command prompt** to verify the network connection between your PC and the router. The following example is in Windows XP.

Open a command prompt, and type *ping 192.168.0.1*, and then press **Enter**.

- If the result displayed is similar to the Figure 3-1, it means the connection between your PC and the router has been established well.

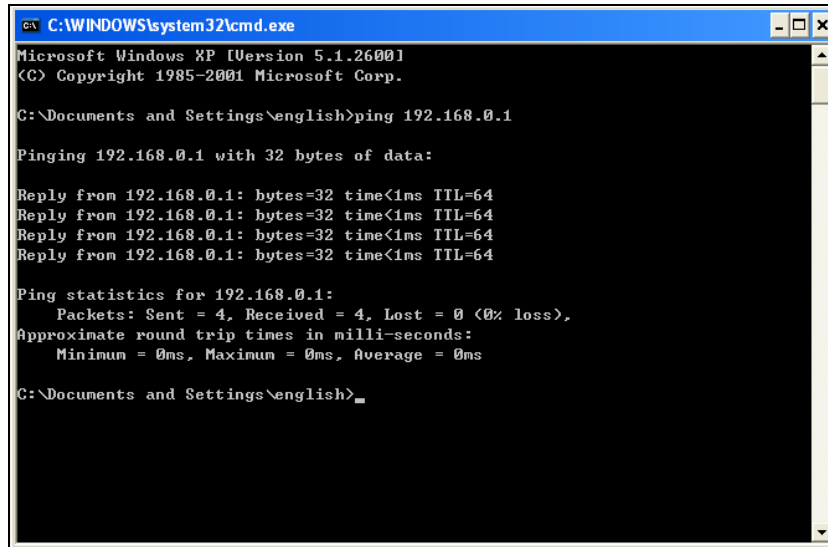

```
C:\WINDOWS\system32\cmd.exe
Microsoft Windows XP [Version 5.1.2600]
(C) Copyright 1985-2001 Microsoft Corp.

C:\Documents and Settings\english>ping 192.168.0.1

Pinging 192.168.0.1 with 32 bytes of data:

Reply from 192.168.0.1: bytes=32 time<1ms TTL=64
Reply from 192.168.0.1: bytes=32 time<1ms TTL=64
Reply from 192.168.0.1: bytes=32 time<1ms TTL=64
Reply from 192.168.0.1: bytes=32 time<1ms TTL=64

Ping statistics for 192.168.0.1:
    Packets: Sent = 4, Received = 4, Lost = 0 (0% loss),
    Approximate round trip times in milli-seconds:
        Minimum = 0ms, Maximum = 0ms, Average = 0ms

C:\Documents and Settings\english>
```

Figure 3-1 Success result of Ping command

- If the result displayed is similar to the Figure 3-2, it means the connection between your PC and the router is failed.

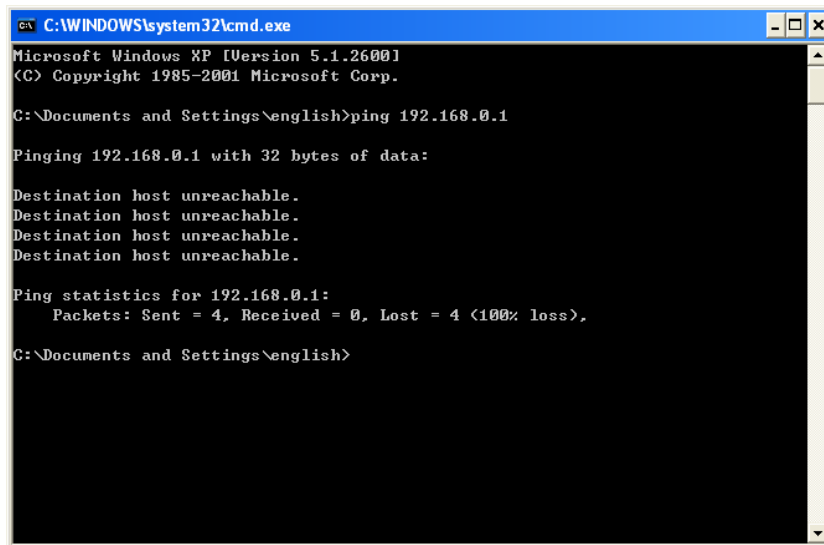

```
C:\WINDOWS\system32\cmd.exe
Microsoft Windows XP [Version 5.1.2600]
(C) Copyright 1985-2001 Microsoft Corp.

C:\Documents and Settings\english>ping 192.168.0.1

Pinging 192.168.0.1 with 32 bytes of data:

Destination host unreachable.
Destination host unreachable.
Destination host unreachable.
Destination host unreachable.

Ping statistics for 192.168.0.1:
    Packets: Sent = 4, Received = 0, Lost = 4 (100% loss),

C:\Documents and Settings\english>
```

Figure 3-2 Failure result of Ping command

Please check the connection following these steps:

1. Is the connection between your PC and the router correct?

Note:

The 1/2/3/4 LEDs of LAN ports which you link to on the router and LEDs on your PC's adapter should be lit.

2. Is the TCP/IP configuration for your PC correct?

Note:

If the router's IP address is 192.168.0.1, your PC's IP address must be within the range of 192.168.0.2 ~ 192.168.0.254.

3. Is the default LAN IP of the router correct?

 **Note:**

If the LAN IP of the modem connected with your router is 192.168.0.x, the default LAN IP of the router will automatically switch from 192.168.0.1 to 192.168.1.1 to avoid IP conflict. Therefore, in order to verify the network connection between your PC and the router, you can open a command prompt, and type `ping 192.168.1.1`, and then press **Enter**.

3.2 Quick Installation Guide

With a Web-based utility, it is easy to configure and manage the TL-WR841HP 300Mbps High Power Wireless N Router. The Web-based utility can be used on any Windows, Macintosh or UNIX OS with a Web browser, such as Microsoft Internet Explorer, Mozilla Firefox or Apple Safari.

1. To access the configuration utility, open a web-browser and type in the default address <http://tplinkwifi.net> in the address field of the browser.



Figure 3-3 Login the Router

After a moment, a login window will appear, similar to the Figure 3-4. Enter **admin** for the User Name and Password, both in lower case letters. Then click the **Login** button or press the **Enter** key.

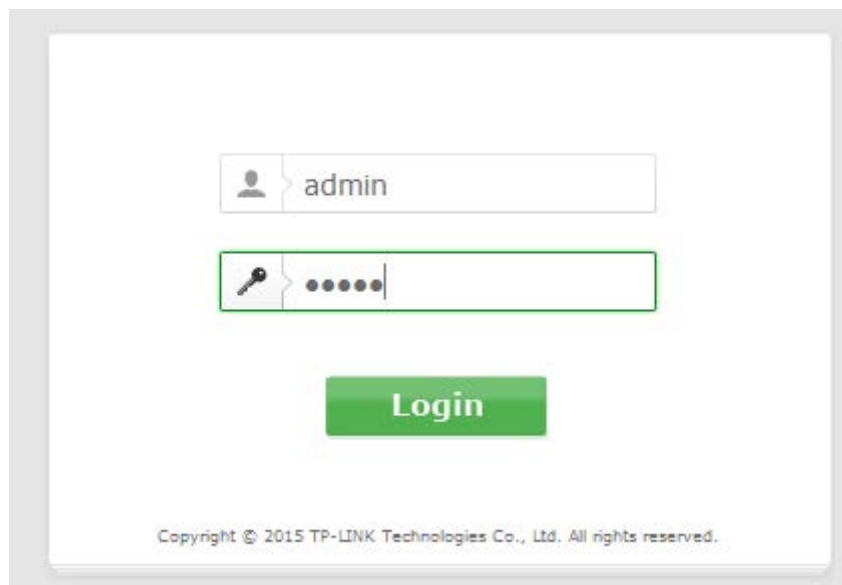

Figure 3-4 Login Windows

 **Note:**

If the above screen does not pop-up, it means that your Web-browser has been set to a proxy. Go to **Tools>Internet Options>Connections>LAN Settings**, in the screen that appears, cancel the **Using Proxy** checkbox, and click **OK** to finish it.

2. After successful login, you can click the **Quick Setup** to quickly configure your router.

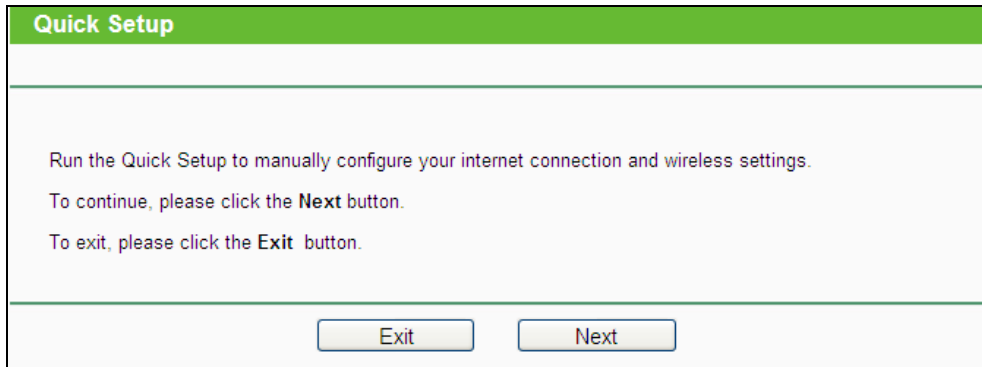

Figure 3-5 Quick Setup

Note:

The Router will automatically detect the Internet connection. If the Internet is available, the Router will direct you to **step 5 Wireless** settings; otherwise, you need to continue with **step 3** to choose **WAN Connection Type**.

3. Click **Next**, and then **WAN Connection Type** page will appear, shown in Figure 3-6.

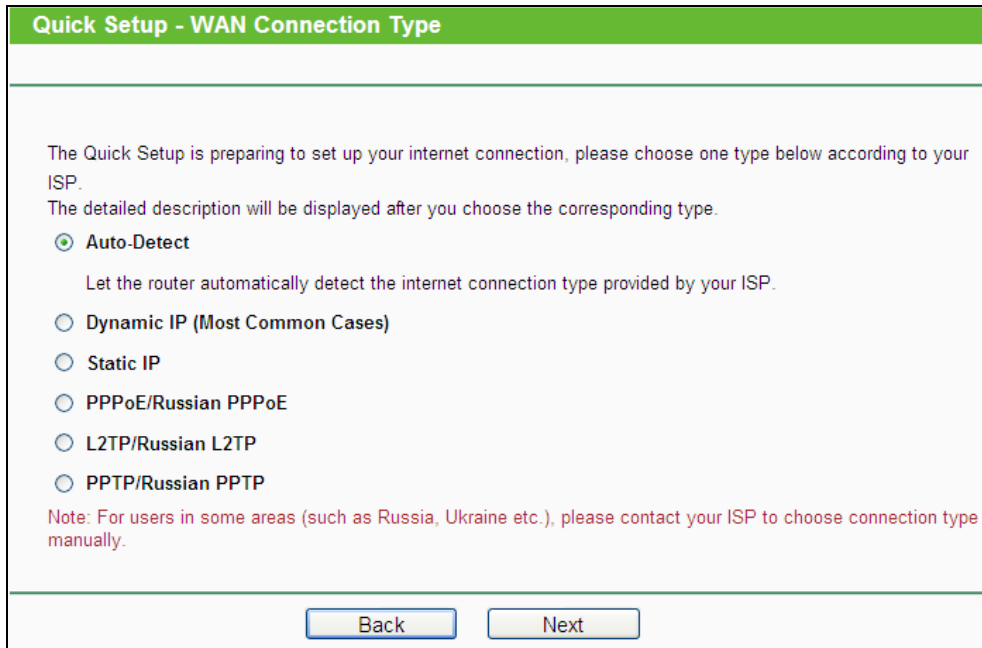
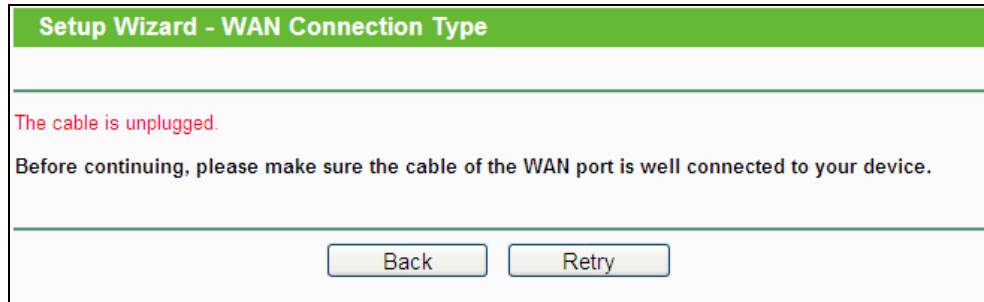

Figure 3-6 Choose WAN Connection Type

The router provides **Auto-Detect** function and supports five popular ways **Dynamic IP**, **Static IP**, **PPPoE/Russian PPPoE**, **L2TP/Russian L2TP** and **PPTP/Russian PPTP** to connect to the Internet. It's recommended that you make use of the **Auto-Detect** function. If you select **Auto-Detect**, the router will automatically detect the connection type your ISP provides. If you are sure of what kind of connection type your ISP provides, you can select the very type and click **Next** to go on configuring.

Note:

- 1) **L2TP** and **PPTP** cannot be detected by the router. You must select it manually.
- 2) Before continuing, please make sure the cable of the WAN port is well connected to your device. If the WAN port is not connected, **the cable is unplugged** page will appear.



4. If you select **Auto-Detect**, the router will automatically detect the connection type your ISP provides. Make sure the cable is securely plugged into the Internet port before detection. The appropriate configuration page will be displayed when an active Internet service is successfully detected by the router.
 - 1) If the connection type is **Dynamic IP**, there will appear the MAC Clone page (as shown in Figure 3-7). In most cases, there is no need to clone the MAC address. You can select “**No, I do NOT need to clone MAC address**” and then click **Next**. If it is necessary in your case, please select “**Yes, I need to clone MAC address**” and then click **Next**.

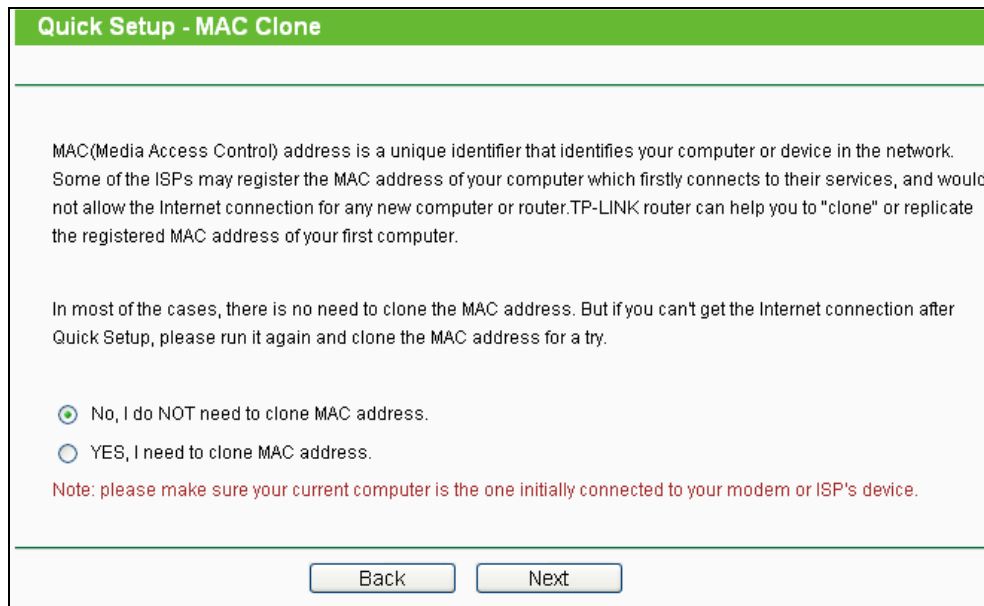
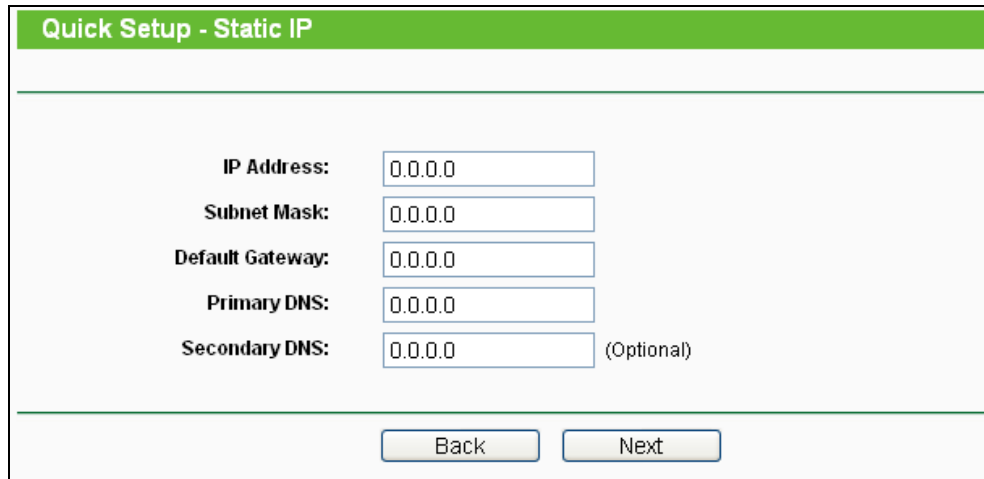

Figure 3-7 MAC Clone

- 2) If the connection type is Static IP, the next screen will appear as shown in Figure 3-8.



Quick Setup - Static IP

IP Address:

Subnet Mask:

Default Gateway:

Primary DNS:

Secondary DNS: (Optional)

Figure 3-8 Quick Setup - Static IP

- **IP Address** - This is the WAN IP address as seen by external users on the Internet (including your ISP). Enter the IP address into the field.
 - **Subnet Mask** - The Subnet Mask is used for the WAN IP address, it is usually 255.255.255.0.
 - **Default Gateway** - Enter the gateway IP address into the box if required.
 - **Primary DNS** - Enter the DNS Server IP address into the box if required.
 - **Secondary DNS** - If your ISP provides another DNS server, enter it into this field.
- 3) If the connection type is **PPPoE/Russian PPPoE**, the next screen will appear as shown in Figure 3-9. Configure the following parameters and then click **Next** to continue.

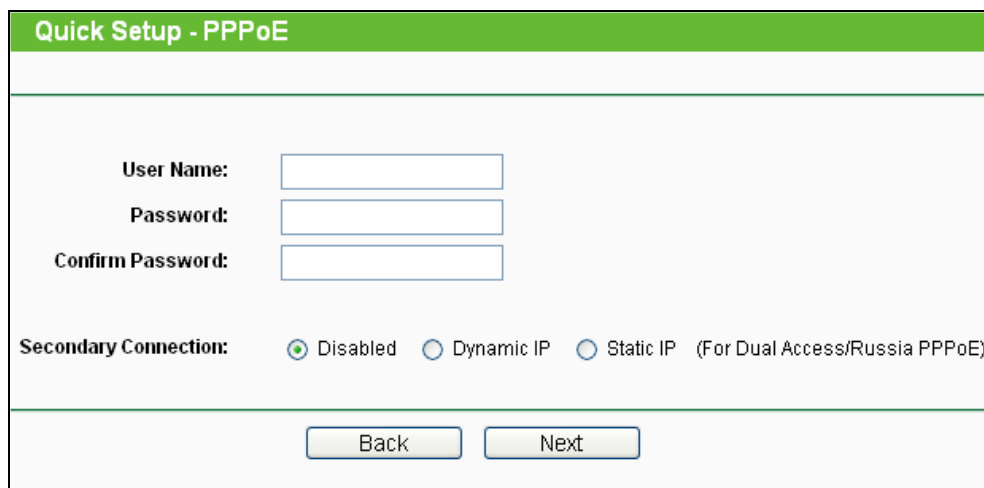

Quick Setup - PPPoE

User Name:

Password:

Confirm Password:

Secondary Connection: Disabled Dynamic IP Static IP (For Dual Access/Russia PPPoE)

Figure 3-9 Quick Setup – PPPoE

- **User Name and Password** - Enter the **User Name** and **Password** provided by your ISP. These fields are case sensitive. If you have difficulty with this process, please contact your ISP.

- **Confirm Password** - Re-enter the password provided by your ISP to ensure the Password you entered is correct.

Check the radio button of **Dynamic/Static IP** to activate the secondary connection if your ISP provides an extra Connection type such as Dynamic/Static IP to connect to a local area network.

- 4) If the connection type is **L2TP/Russian L2TP**, the next screen will appear as shown in Figure 3-10. Configure the following parameters and then click **Next** to continue.

Figure 3-10 Quick Setup – L2TP

- **User Name and Password** - Enter the **User Name** and **Password** provided by your ISP. These fields are case sensitive. If you have difficulty with this process, please contact your ISP.
- **Confirm Password** - Re-enter the password provided by your ISP to ensure the Password you entered is correct.

Select **Dynamic IP** if none of the above parameters are provided. Then you just need to enter server IP address or domain name provided by your ISP.

Select **Static IP** if IP Address/ Subnet Mask/ Gateway and DNS server address have been provided by your ISP. Then please enter server IP address or domain name provided by your ISP, and also enter the corresponding parameters.

	<input type="radio"/> Dynamic IP	<input checked="" type="radio"/> Static IP
Server IP Address/Name:	<input type="text"/>	
IP Address:	<input type="text" value="0.0.0.0"/>	
Subnet Mask:	<input type="text" value="0.0.0.0"/>	
Gateway:	<input type="text" value="0.0.0.0"/>	
DNS:	<input type="text" value="0.0.0.0"/>	

- 5) If the connection type is **PPTP/Russian PPTP**, the next screen will appear as shown in Figure 3-11. Configure the following parameters and then click **Next** to continue.

Quick Setup - PPTP	
User Name:	<input type="text"/>
Password:	<input type="text"/>
Confirm Password:	<input type="text"/>
	<input checked="" type="radio"/> Dynamic IP <input type="radio"/> Static IP
Server IP Address/Name:	<input type="text"/>
<input type="button" value="Back"/> <input type="button" value="Next"/>	

Figure 3-11 Quick Setup – PPTP

- **User Name and Password** - Enter the **User Name** and **Password** provided by your ISP. These fields are case sensitive. If you have difficulty with this process, please contact your ISP.
- **Confirm Password** - Re-enter the password provided by your ISP to ensure the Password you entered is correct.

Select **Dynamic IP** if none of the above parameters are provided. Then you just need to enter server IP address or domain name provided by your ISP.

	<input checked="" type="radio"/> Dynamic IP	<input type="radio"/> Static IP
Server IP Address/Name:	<input type="text"/>	

Select **Static IP** if IP Address/ Subnet Mask/ Gateway and DNS server address have been provided by your ISP. Then please enter server IP address or domain name provided by your ISP, and also enter the corresponding parameters.

Dynamic IP Static IP

Server IP Address/Name:

IP Address:

Subnet Mask:

Gateway:

DNS:

5. Click **Next** to continue, the Wireless settings page will appear as shown in Figure 3-12.

Quick Setup - Wireless

The internet settings have been completed, now please configure the wireless settings.

Wireless Radio:

Wireless Network Name: (Also called the SSID)

Region:

Warning: Ensure you select a correct country to conform local law. Incorrect settings may cause interference.

Wireless Security:

Disable Security

WPA-PSK/WPA2-PSK

Wireless Password:

(You can enter ASCII characters between 8 and 63 or Hexadecimal characters between 8 and 64.)

No Change
(use the current security settings.)

More Advanced Wireless Settings

Figure 3-12 Quick Setup – Wireless

- **Wireless Radio** - Enable or disable the wireless radio.
- **Wireless Network Name** - Enter a string of up to 32 characters. The same name of SSID (Service Set Identification) must be assigned to all wireless devices in your network. Considering your wireless network security, the default SSID is set to be TP-LINK_XXXX (XXXX indicates the last unique four numbers of each router's MAC address). This value is case-sensitive. For example, *TEST* is NOT the same as *test*.
- **Region** - Select your region from the pull-down list. This field specifies the region where the wireless function of the router can be used. It may be illegal to use the wireless function of the router in a region other than one of those specified in this field. If your country or region is not listed, please contact your local government agency for assistance.

Note:

Per FCC regulations, all Wi-Fi products marketed in the U.S. must be fixed to the U.S. region only.

Quick Setup - Wireless

The Internet settings have been completed, now please configure the wireless settings.

Wireless Radio:

Wireless Network Name: (Also called the SSID)

Region:

Warning: Ensure you select a correct country to conform local law. Incorrect settings may cause interference.

Wireless Security:

Disable Security

WPA-PSK/WPA2-PSK

Wireless Password:
(You can enter ASCII characters between 8 and 63 or Hexadecimal characters between 8 and 64.)

No Change
(use the current security settings.)

More Advanced Wireless Settings

- **Disable Security** - The wireless security function can be enabled or disabled. If disabled, the wireless stations will be able to connect the router without encryption. It is recommended strongly that you choose one of following options to enable security.
- **WPA/WPA2-Personal** - Select WPA based on pre-shared passphrase.
 - **PSK Password** - You can enter **ASCII** or **Hexadecimal** characters.
 - For **ASCII**, the key can be made up of any numbers 0 to 9 and any letters A to Z, the length should be between 8 and 63 characters.
 - For **Hexadecimal**, the key can be made up of any numbers 0 to 9 and letters A to F, the length should be between 8 and 64 characters.
 - Please also note the key is case sensitive, this means that upper and lower case keys will affect the outcome. It would also be a good idea to write down the key and all related wireless security settings.
- **No Change** - If you chose this option, wireless security configuration will not change!

The above settings are only for basic wireless parameters. For advanced settings, please check "**More Advanced Wireless Settings**", and then you can set the following parameters.

More Advanced Wireless Settings

Mode:

Channel Width:

Channel:

- **Mode** - This field determines the wireless mode which the router works on.

- **Channel Width** - Select any channel width from the pull-down list. The default setting is automatic, which can adjust the channel width for your clients automatically.
- **Channel** - This field determines which operating frequency will be used. The default channel is set to **Auto**, so the AP will choose the best channel automatically. It is not necessary to change the wireless channel unless you notice interference problems with another nearby access point.

Click **Next** to continue.

6. Click the **Finish** button to complete the **Quick Setup**.

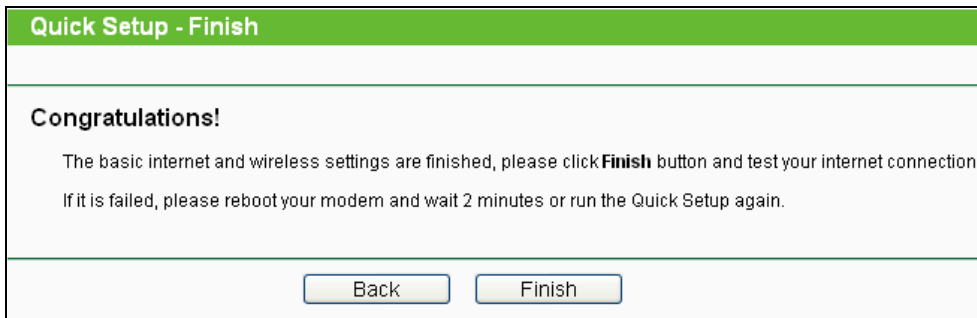

Quick Setup - Finish

Congratulations!

The basic internet and wireless settings are finished, please click **Finish** button and test your internet connection.

If it is failed, please reboot your modem and wait 2 minutes or run the Quick Setup again.

Figure 3-13 Quick Setup – Finish

Chapter 4. Configuring the Router

This chapter will show each Web page's key functions and the configuration way.

4.1 Login

After your successful login, you will see the main menus on the left of the Web-based utility. On the right, there are the corresponding explanations and instructions.

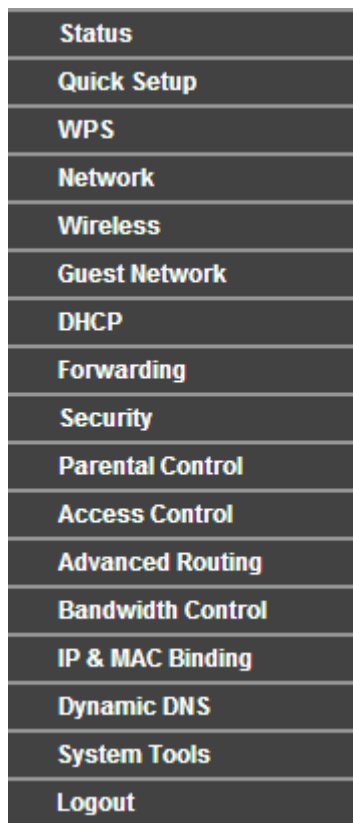

Status
Quick Setup
WPS
Network
Wireless
Guest Network
DHCP
Forwarding
Security
Parental Control
Access Control
Advanced Routing
Bandwidth Control
IP & MAC Binding
Dynamic DNS
System Tools
Logout

The detailed explanations for each Web page's key function are listed below.

4.2 Status

The Status page provides the current status information about the router. All information is read-only.

Status		
Firmware Version:	3.16.9 Build 150814 Rel.42667n	
Hardware Version:	WR841HP v2 00000000	
LAN		
MAC Address:	00-0A-EB-13-09-19	
IP Address:	192.168.0.1	
Subnet Mask:	255.255.255.0	
Wireless		
Wireless Radio:	Enable	
Name (SSID):	TP-LINK_0919	
Mode:	11bgn mixed	
Channel Width:	Automatic	
Channel:	Auto (Current channel 7)	
MAC Address:	00-0A-EB-13-09-19	
WDS Status:	Disable	
WAN		
MAC Address:	00-0A-EB-13-09-1A	
IP Address:	0.0.0.0	Dynamic IP
Subnet Mask:	0.0.0.0	
Default Gateway:	0.0.0.0	
DNS Server:	0.0.0.0 , 0.0.0.0	
Traffic Statistics		
	Received	Sent
Bytes:	28,992	24,348
Packets:	302	271
System Up Time:	2 days 21:30:55	<input type="button" value="Refresh"/>

Figure 4-1 Router Status

4.3 Quick Setup

Please refer to [3.2 Quick Installation Guide](#).

4.4 WPS

This section will guide you to add a new wireless device to an existing network quickly by WPS (**Wi-Fi Protected Setup**) function.

- Choose menu "WPS", and you will see the next screen (shown in Figure 4-2).

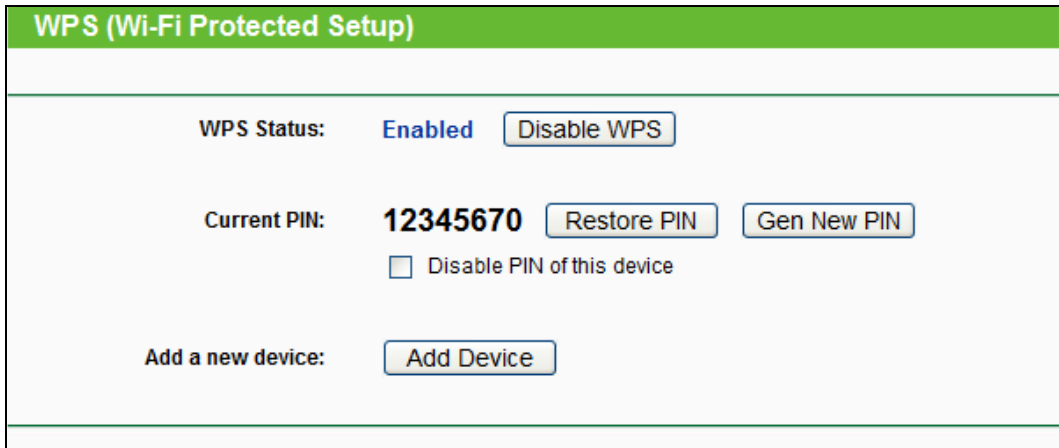

Figure 4-2 WPS

- **WPS Status** - Enable or disable the **WPS** function here.
- **Current PIN** - The current value of the router's PIN is displayed here. The default PIN of the router can be found in the label attached on the router.
- **Restore PIN** - Restore the PIN of the router to its default.
- **Gen New PIN** - Click this button, and then you can get a new random value for the router's PIN. You can ensure the network security by generating a new PIN.
- **Disable PIN of this device** - You can disable the router's PIN manually here. If the router receives multiple failed attempts to authenticate an external registrar, this function will be disabled automatically.
- **Add Device** - You can add a new device to the existing network manually by clicking this button.

b). To add a new device:

If the wireless adapter supports Wi-Fi Protected Setup (WPS), you can establish a wireless connection between wireless adapter and router using either Push Button Configuration (PBC) method or PIN method.

 **Note:**

To build a successful connection by **WPS**, you should also do the corresponding configuration of the new device for **WPS** function meanwhile.

I. Use the Wi-Fi Protected Setup Button

Use this method if your client device has a Wi-Fi Protected Setup button.

Step 1: Press the **WPS/RESET** button on the back panel of the router for one second.

You can also keep the default **WPS** Status as **Enabled** and click the **Add Device** button in Figure 4-2, then Choose "**Press the button of the new device in two minutes**" and click **Connect**. (Shown in the following figure)

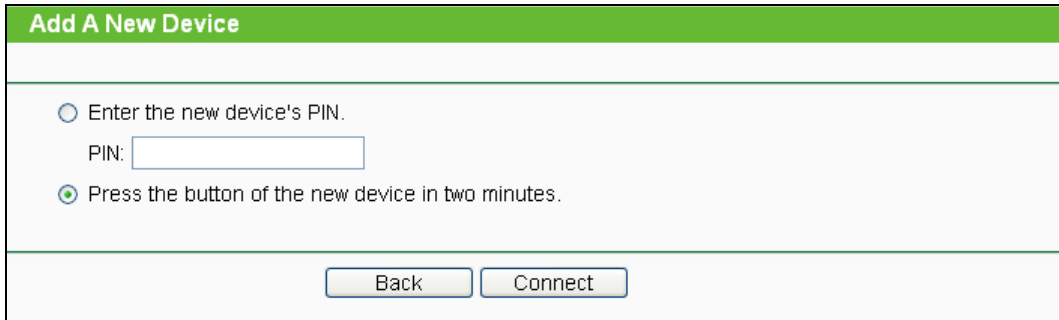

Add A New Device

Enter the new device's PIN.
PIN:

Press the button of the new device in two minutes.

Figure 4-3 Add A New Device

Step 2: Press and hold the **WPS** button of the client device directly.

Step 3: The Wi-Fi Protected Setup LED flashes for two minutes during the Wi-Fi Protected Setup process.

Step 4: When the WPS LED is on, the client device has successfully connected to the router.

Step 5: Refer back to your client device or its documentation for further instructions.

II. Enter the client device's PIN on the router

Use this method if your client device has a Wi-Fi Protected Setup PIN number.

Step 1: Keep the default **WPS** Status as **Enabled** and click the **Add Device** button in Figure 4-2, then the following screen will appear.

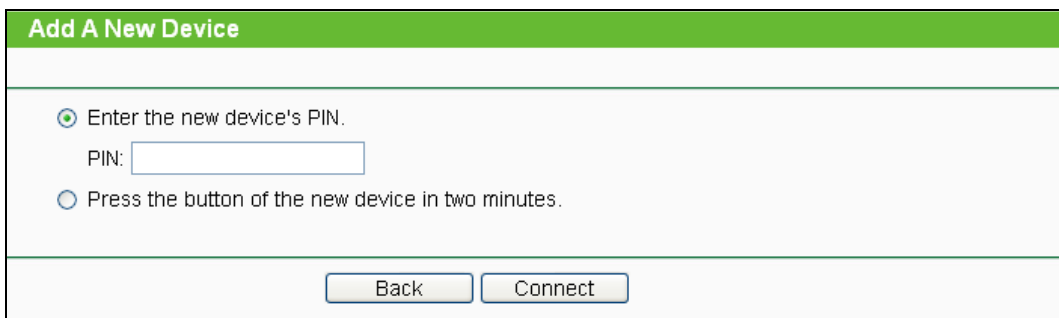

Add A New Device

Enter the new device's PIN.
PIN:

Press the button of the new device in two minutes.

Figure 4-4 Add A New Device

Step 2: Enter the PIN number from the client device in the field on the above WPS screen. Then click **Connect** button.

Step 3: "**Connect successfully**" will appear on the screen of Figure 4-4, which means the client device has successfully connected to the router.

III. Enter the router's PIN on your client device

Use this method if your client device asks for the router's PIN number.

Step 1: On the client device, enter the PIN number listed on the router's Wi-Fi Protected Setup screen. (It is also labeled on the bottom of the router.)

Step 2: The Wi-Fi Protected Setup LED flashes for two minutes during the Wi-Fi Protected Setup process.

Step 3: When the WPS LED is on, the client device has successfully connected to the router.

Step 4: Refer back to your client device or its documentation for further instructions.

 **Note:**

- 1) The **WPS** LED on the router will light green for five minutes if the device has been successfully added to the network.
- 2) The **WPS** function cannot be configured if the Wireless Function of the router is disabled. Please make sure the Wireless Function is enabled before configuring the **WPS**.

4.5 Network

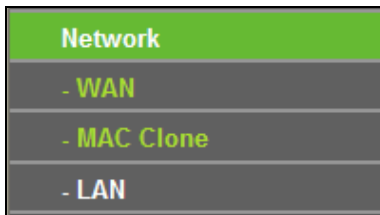

Figure 4-5 the Network menu

There are three submenus under the Network menu (shown in Figure 4-5): **WAN**, **MAC Clone**, and **LAN**. Click any of them, and you will be able to configure the corresponding function.

4.5.1 WAN

Choose menu "**Network**→**WAN**", you can configure the IP parameters of the WAN on the screen below.

1. If your ISP provides the DHCP service, please choose **Dynamic IP** type, and the router will automatically get IP parameters from your ISP. You can see the page as follows (Figure 4-6):

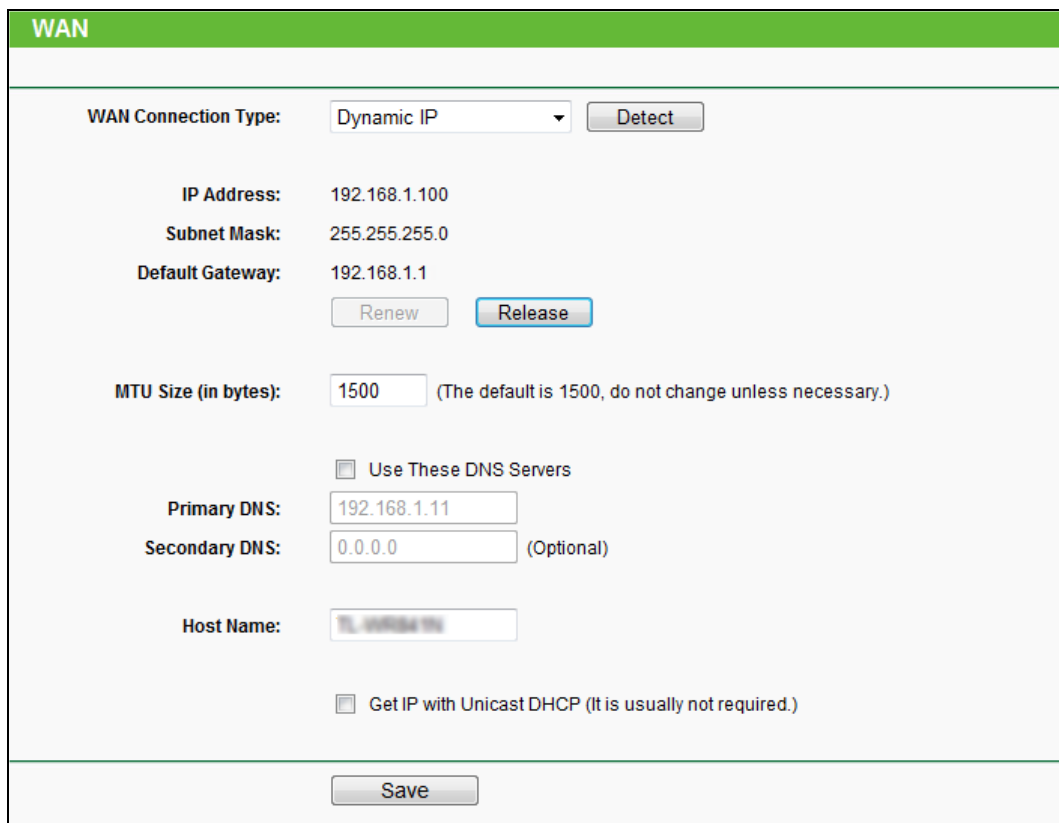
 A screenshot of the WAN configuration page. The title "WAN" is in a green header. The page contains several configuration fields:

- WAN Connection Type:** A dropdown menu set to "Dynamic IP" with a "Detect" button next to it.
- IP Address:** 192.168.1.100
- Subnet Mask:** 255.255.255.0
- Default Gateway:** 192.168.1.1
- Buttons for "Renew" and "Release" are located below the gateway field.
- MTU Size (in bytes):** 1500 (The default is 1500, do not change unless necessary.)
- Use These DNS Servers
- Primary DNS:** 192.168.1.11
- Secondary DNS:** 0.0.0.0 (Optional)
- Host Name:** TL-WR841HP
- Get IP with Unicast DHCP (It is usually not required.)
- A "Save" button is at the bottom of the page.

Figure 4-6 WAN - Dynamic IP

This page displays the WAN IP parameters assigned dynamically by your ISP, including IP address, Subnet Mask, Default Gateway, etc. Click the **Renew** button to renew the IP parameters from your ISP. Click the **Release** button to release the IP parameters.

- **MTU Size** - The normal **MTU** (Maximum Transmission Unit) value for most Ethernet networks is 1500 Bytes. It is not recommended that you change the default **MTU Size** unless required by your ISP.
- **Use These DNS Servers** - If your ISP gives you one or two DNS addresses, select **Use These DNS Servers** and enter the primary and secondary addresses into the correct fields. Otherwise, the DNS servers will be assigned dynamically from your ISP.

 **Note:**

If you find error when you go to a Web site after entering the DNS addresses, it is likely that your DNS servers are set up improperly. You should contact your ISP to get DNS server addresses.

- **Get IP with Unicast DHCP** - A few ISPs' DHCP servers do not support the broadcast applications. If you cannot get the IP Address normally, you can choose this option. (It is rarely required.)

Click the **Save** button to save your settings.

2. If your ISP provides a static or fixed IP Address, Subnet Mask, Gateway and DNS setting, select **Static IP**. The Static IP settings page will appear, shown in Figure 4-7.

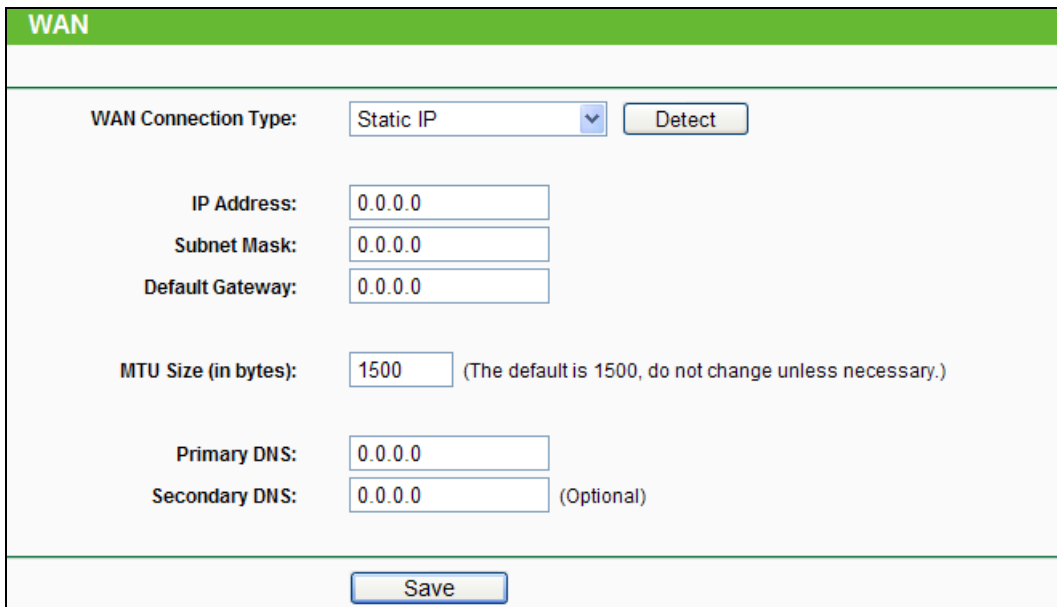

WAN	
WAN Connection Type:	Static IP <input type="button" value="Detect"/>
IP Address:	0.0.0.0
Subnet Mask:	0.0.0.0
Default Gateway:	0.0.0.0
MTU Size (in bytes):	1500 (The default is 1500, do not change unless necessary.)
Primary DNS:	0.0.0.0
Secondary DNS:	0.0.0.0 (Optional)
<input type="button" value="Save"/>	

Figure 4-7 WAN - Static IP

- **IP Address** - Enter the IP address in dotted-decimal notation provided by your ISP.
- **Subnet Mask** - Enter the subnet Mask in dotted-decimal notation provided by your ISP, usually is 255.255.255.0.

- **Default Gateway** - (Optional) Enter the gateway IP address in dotted-decimal notation provided by your ISP.
- **MTU Size** - The normal **MTU** (Maximum Transmission Unit) value for most Ethernet networks is 1500 Bytes. It is not recommended that you change the default **MTU Size** unless required by your ISP.
- **Primary/Secondary DNS** - (Optional) Enter one or two DNS addresses in dotted-decimal notation provided by your ISP.

Click the **Save** button to save your settings.

3. If your ISP provides a PPPoE connection, select **PPPoE/Russia PPPoE** option. And you should enter the following parameters (Figure 4-8):

The screenshot shows the WAN configuration interface for a PPPoE/Russia PPPoE connection. The page has a green header with the text 'WAN'. Below the header, there are several sections of configuration options:

- WAN Connection Type:** A dropdown menu is set to 'PPPoE/Russia PPPoE' with a 'Detect' button next to it.
- PPPoE Connection:** This section contains three input fields: 'User Name:', 'Password:', and 'Confirm Password:'.
- Secondary Connection:** This section has three radio buttons: 'Disabled' (which is selected), 'Dynamic IP', and 'Static IP'. A note '(For Dual Access/Russia PPPoE)' is next to the 'Static IP' option.
- Wan Connection Mode:** This section has four radio buttons: 'Connect on Demand', 'Connect Automatically' (which is selected), 'Time-based Connecting', and 'Connect Manually'.
 - Under 'Connect on Demand', there is a 'Max Idle Time' field set to '15' minutes, with a note '(0 means remain active at all times.)'.
 - Under 'Time-based Connecting', there is a 'Period of Time' field set to 'from 0 : 0 (HH:MM) to 23 : 59 (HH:MM)'.
 - Under 'Connect Manually', there is a 'Max Idle Time' field set to '15' minutes, with a note '(0 means remain active at all times.)'.

At the bottom of the configuration area, there are three buttons: 'Connect', 'Disconnect', and 'Disconnected!'. Below the entire configuration area, there are two buttons: 'Save' and 'Advanced'.

Figure 4-8 WAN - PPPoE

- **User Name/Password** - Enter the User Name and Password provided by your ISP. These fields are case-sensitive.
- **Secondary Connection** - It's available only for PPPoE Connection. If your ISP provides an extra Connection type such as Dynamic/Static IP to connect to a local area network, then you can check the radio button of Dynamic/Static IP to activate this secondary connection.

- **Disabled** - The Secondary Connection is disabled by default, so there is PPPoE connection only. This is recommended.
 - **Dynamic IP** - You can check this radio button to use Dynamic IP as the secondary connection to connect to the local area network provided by ISP.
 - **Static IP** - You can check this radio button to use Static IP as the secondary connection to connect to the local area network provided by ISP.
- **Connect on Demand** - In this mode, the Internet connection can be terminated automatically after a specified inactivity period (**Max Idle Time**) and **be** re-established when you attempt to access the Internet again. If you want your Internet connection keeps active all the time, please enter "0" in the **Max Idle Time** field. Otherwise, enter the number of minutes you want to have elapsed before your Internet access disconnects.
- **Connect Automatically** - The connection can be re-established automatically when it was down.
- **Time-based Connecting** - The connection will only be established in the period from the start time to the end time (both are in HH:MM format).

 **Note:**

Only when you have configured the system time on **System Tools -> Time** page, will the **Time-based Connecting** function can take effect.

- **Connect Manually** - You can click the **Connect/ Disconnect** button to connect/disconnect immediately. This mode also supports the **Max Idle Time** function as **Connect on Demand** mode. The Internet connection can be disconnected automatically after a specified inactivity period and re-established when you attempt to access the Internet again.

Click the **Connect** button to connect immediately. Click the **Disconnect** button to disconnect immediately.

Caution: Sometimes the connection cannot be terminated although you specify a time to Max Idle Time, since some applications are visiting the Internet continually in the background.

If you want to do some advanced configurations, please click the **Advanced** button, and the page shown in Figure 4-9 will then appear:

Figure 4-9 PPPoE Advanced Settings

- **MTU Size** - The default MTU size is “1480” bytes, which is usually fine. It is not recommended that you change the default **MTU Size** unless required by your ISP.
- **Service Name/AC Name** - The service name and AC (Access Concentrator) name, which should not be configured unless you are sure it is necessary for your ISP. In most cases, leaving these fields blank will work.
- **ISP Specified IP Address** - If your ISP does not automatically assign IP addresses to the router during login, please click “**Use IP address specified by ISP**” check box and enter the IP address provided by your ISP in dotted-decimal notation.
- **Detect Online Interval** - The router will detect Access Concentrator online at every interval. The default value is “0”. You can input the value between “0”and “120”. The value “0” means no detect.
- **DNS IP address** - If your ISP does not automatically assign DNS addresses to the router during login, please click “**Use the following DNS servers**” check box and enter the IP address in dotted-decimal notation of your ISP’s primary DNS server. If a secondary DNS server address is available, enter it as well.

Click the **Save** button to save your settings.

4. If your ISP provides BigPond Cable (or Heart Beat Signal) connection, please select **BigPond Cable**. And you should enter the following parameters (Figure 4-10):

Figure 4-10 WAN – BigPond Cable

- **User Name/Password** - Enter the User Name and Password provided by your ISP. These fields are case-sensitive.
- **Auth Server** - Enter the authenticating server IP address or host name.
- **Auth Domain** - Type in the domain suffix server name based on your location.
e.g.

NSW / ACT - **nsw.bigpond.net.au**

VIC / TAS / WA / SA / NT - **vic.bigpond.net.au**

QLD - **qld.bigpond.net.au**

- **MTU Size** - The normal **MTU** (Maximum Transmission Unit) value for most Ethernet networks is 1500 Bytes. It is not recommended that you change the default **MTU Size** unless required by your ISP.
- **Connect on Demand** - In this mode, the Internet connection can be terminated automatically after a specified inactivity period (**Max Idle Time**) and be re-established when you attempt to access the Internet again. If you want your Internet connection keeps active all the time, please enter "0" in the **Max Idle Time** field. Otherwise, enter the number of minutes you want to have elapsed before your Internet access disconnects.

- **Connect Automatically** - The connection can be re-established automatically when it was down.
- **Connect Manually** - You can click the **Connect/Disconnect** button to connect/disconnect immediately. This mode also supports the **Max Idle Time** function as **Connect on Demand** mode. The Internet connection can be disconnected automatically after a specified inactivity period and re-established when you attempt to access the Internet again.

Click the **Connect** button to connect immediately. Click the **Disconnect** button to disconnect immediately.

Caution: Sometimes the connection cannot be terminated although you specify a time to Max Idle Time because some applications are visiting the Internet continually in the background.

Click the **Save** button to save your settings.

5. If your ISP provides L2TP connection, please select **L2TP/Russia L2TP** option. And you should enter the following parameters (Figure 4-11):

WAN

WAN Connection Type: L2TP/Russia L2TP

User Name:

Password:

Confirm Password:

Disconnected!

Dynamic IP Static IP

Server IP Address/Name:

IP Address: 0.0.0.0

Subnet Mask: 0.0.0.0

Gateway: 0.0.0.0

DNS: 0.0.0.0, 0.0.0.0

Internet IP Address: 0.0.0.0

Internet DNS: 0.0.0.0, 0.0.0.0

MTU Size (in bytes): (The default is 1460, do not change unless necessary.)

Max Idle Time: minutes (0 means remain active at all times.)

Connection Mode: Connect on Demand
 Connect Automatically
 Connect Manually

Figure 4-11 L2TP Settings

- **User Name/Password** - Enter the User Name and Password provided by your ISP. These fields are case-sensitive.
- **Dynamic IP/ Static IP** - Choose either as you are given by your ISP. Click the **Connect** button to connect immediately. Click the **Disconnect** button to disconnect immediately.
- **Connect on Demand** - You can configure the router to disconnect from your Internet connection after a specified period of inactivity (**Max Idle Time**). If your Internet connection has been terminated due to inactivity, **Connect on Demand** enables the router to automatically re-establish your connection as soon as you attempt to access the Internet again. If you wish to activate **Connect on Demand**, click the radio button. If you want your Internet connection to remain active at all times, enter 0 in the **Max Idle Time** field. Otherwise, enter the number of minutes you want to have elapsed before your Internet connection terminates.
- **Connect Automatically** - Connect automatically after the router is disconnected. To use this option, click the radio button.
- **Connect Manually** - You can configure the router to make it connect or disconnect manually. After a specified period of inactivity (**Max Idle Time**), the router will disconnect from your Internet connection, and you will not be able to re-establish your connection automatically as soon as you attempt to access the Internet again. To use this option, click the radio button. If you want your Internet connection to remain active at all times, enter "0" in the **Max Idle Time** field. Otherwise, enter the number in minutes that you wish to have the Internet connecting last unless a new link is requested.

Caution: Sometimes the connection cannot be disconnected although you specify a time to **Max Idle Time**, since some applications is visiting the Internet continually in the background.

Click the **Save** button to save your settings.

6. If your ISP provides PPTP connection, please select **PPTP/Russia PPTP** option. And you should enter the following parameters (Figure 4-12):

WAN

WAN Connection Type: PPTP/Russia PPTP

User Name:

Password:

Confirm Password:

Disconnected!

Dynamic IP Static IP

Server IP Address/Name:

IP Address: 0.0.0.0

Subnet Mask: 0.0.0.0

Gateway: 0.0.0.0

DNS: 0.0.0.0, 0.0.0.0

Internet IP Address: 0.0.0.0

Internet DNS: 0.0.0.0, 0.0.0.0

MTU Size (in bytes): (The default is 1420, do not change unless necessary.)

Max Idle Time: minutes (0 means remain active at all times.)

Connection Mode: Connect on Demand Connect Automatically Connect Manually

Figure 4-12 PPTP Settings

- **User Name/Password** - Enter the User Name and Password provided by your ISP. These fields are case-sensitive.
- **Dynamic IP/ Static IP** - Choose either as you are given by your ISP and enter the ISP's IP address or the domain name.

If you choose static IP and enter the domain name, you should also enter the DNS assigned by your ISP. And click the **Save** button.

Click the Connect button to connect immediately. Click the Disconnect button to disconnect immediately.

- **Connect on Demand** - You can configure the router to disconnect from your Internet connection after a specified period of inactivity (**Max Idle Time**). If your Internet connection has been terminated due to inactivity, **Connect on Demand** enables the router to automatically re-establish your connection as soon as you attempt to access the Internet again. If you wish to activate **Connect on Demand**, click the radio button. If you want your

Internet connection to remain active at all times, enter 0 in the **Max Idle Time** field. Otherwise, enter the number of minutes you want to have elapsed before your Internet connection terminates.

- **Connect Automatically** - Connect automatically after the router is disconnected. To use this option, click the radio button.
- **Connect Manually** - You can configure the router to make it connect or disconnect manually. After a specified period of inactivity (**Max Idle Time**), the router will disconnect from your Internet connection, and you will not be able to re-establish your connection automatically as soon as you attempt to access the Internet again. To use this option, click the radio button. If you want your Internet connection to remain active at all times, enter "0" in the **Max Idle Time** field. Otherwise, enter the number in minutes that you wish to have the Internet connecting last unless a new link is requested.

Caution: Sometimes the connection cannot be disconnected although you specify a time to Max Idle Time, since some applications are visiting the Internet continually in the background.

Click the **Save** button to save your settings.

 **Note:**

If you don't know how to choose the appropriate connection type, click the **Detect** button to allow the router to automatically search your Internet connection for servers and protocols. The connection type will be reported when an active Internet service is successfully detected by the router. This report is for your reference only. To make sure the connection type your ISP provides, please refer to the ISP. The various types of Internet connections that the router can detect are as follows:

- **PPPoE** - Connections which use PPPoE that requires a user name and password.
- **Dynamic IP** - Connections which use dynamic IP address assignment.
- **Static IP** - Connections which use static IP address assignment.

The router can not detect PPTP/L2TP/BigPond connections with your ISP. If your ISP uses one of these protocols, then you must configure your connection manually.

4.5.2 MAC Clone

Choose menu "**Network→MAC Clone**", you can configure the MAC address of the WAN on the screen below, Figure 4-13:

Figure 4-13 MAC Address Clone

Some ISPs require that you register the MAC Address of your adapter. Changes are rarely needed here.

- **WAN MAC Address** - This field displays the current MAC address of the WAN port. If your ISP requires you to register the MAC address, please enter the correct MAC address into this field in XX-XX-XX-XX-XX-XX format(X is any hexadecimal digit).
- **Your PC's MAC Address** - This field displays the MAC address of the PC that is managing the router. If the MAC address is required, you can click the **Clone MAC Address To** button and this MAC address will fill in the **WAN MAC Address** field.

Click **Restore Factory MAC** to restore the MAC address of WAN port to the factory default value.

Click the **Save** button to save your settings.

 **Note:**

Only the PC on your LAN can use the **MAC Address Clone** function.

4.5.3 LAN

Choose menu "**Network→LAN**", you can configure the IP parameters of the LAN on the screen as below.

Figure 4-14 LAN

- **MAC Address** - The physical address of the router, as seen from the LAN. The value can't be changed.
- **IP Address** - Enter the IP address of your router or reset it in dotted-decimal notation (factory default: 192.168.0.1).
- **Subnet Mask** - An address code that determines the size of the network. Normally use 255.255.255.0 as the subnet mask.
- **IGMP Proxy** - If you want to watch TV through IGMP, please **Enable** it.

 **Note:**

1. If you change the IP Address of LAN, you must use the new IP Address to login the router.
2. If the new LAN IP Address you set is not in the same subnet, the IP Address pool of the DHCP server will change accordingly at the same time, while the Virtual Server and DMZ Host will not take effect until they are re-configured.

4.6 Wireless



Figure 4-15 Wireless menu

There are five submenus under the Wireless menu (shown in Figure 4-15): **Wireless Settings**, **Wireless Security**, **Wireless MAC Filtering**, **Wireless Advanced** and **Wireless Statistics**. Click any of them, and you will be able to configure the corresponding function.

4.6.1 Wireless Settings

Choose menu "**Wireless**→**Wireless Setting**", you can configure the basic settings for the wireless network on this page.

Figure 4-16 Wireless Settings

- **Wireless Network Name** - Enter a value of up to 32 characters. The same name of SSID (Service Set Identification) must be assigned to all wireless devices in your network. Considering your wireless network security, the default SSID is set to be TP-LINK_XXXX (XXXX indicates the last unique four numbers of each router's MAC address). This value is case-sensitive. For example, *TEST* is NOT the same as *test*.
- **Region** - Select your region from the pull-down list. This field specifies the region where the wireless function of the router can be used. It may be illegal to use the wireless function of the router in a region other than one of those specified in this field. If your country or region is not listed, please contact your local government agency for assistance.

When you select your local region from the pull-down list, click the **Save** button, then the Note Dialog appears. Click **OK**.

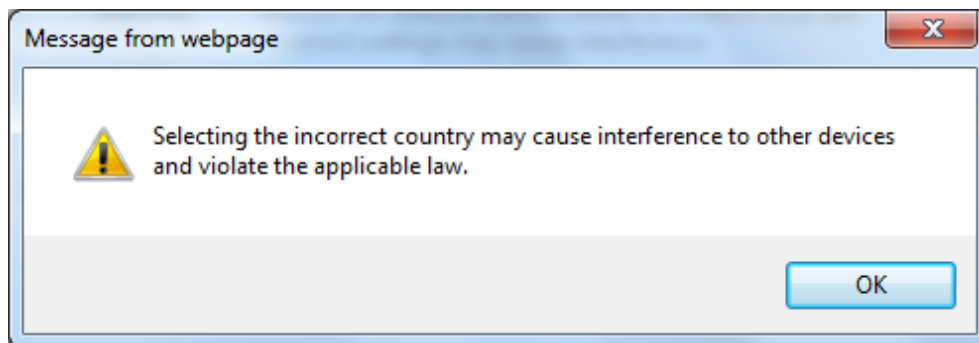

Note Dialog

 **Note:**

Per FCC regulations, all Wi-Fi products marketed in the U.S. must be fixed to the U.S. region

only.

- **Mode** - Select the desired mode. The default setting is 11bgn mixed.

11n only - Select if you are using 802.11n wireless clients.

11gn mixed - Select if you are using both 802.11g and 802.11n wireless clients.

11bgn mixed - Select if you are using a mix of 802.11b, 11g, and 11n wireless clients.

Select the desired wireless mode. It is strongly recommended that you set the Mode to **11bgn mixed**, and all of 802.11b, 802.11g, and 802.11n wireless stations can connect to the router.

- **Channel width** - Select any channel width from the pull-down list. The default setting is automatic, which can adjust the channel width for your clients automatically.

 **Note:**

If **11bg mixed** is selected in the **Mode** field, the **Channel Width** selecting field will turn grey and the value will become 20M, which is unable to be changed.

- **Channel** - This field determines which operating frequency will be used. The default channel is set to **Auto**, so the AP will choose the best channel automatically. It is not necessary to change the wireless channel unless you notice interference problems with another nearby access point.
- **Enable Wireless Router Radio** - The wireless radio of this router can be enabled or disabled to allow wireless stations access. Please use the Wi-Fi button on this device to enable/disable radio.
- **Enable SSID Broadcast** - When wireless clients survey the local area for wireless networks to associate with, they will detect the SSID broadcast by the router. If you select the **Enable SSID Broadcast** checkbox, the Wireless router will broadcast its name (SSID) on the air.

- **Enable WDS Bridging** - Check this box to enable WDS. With this function, the router can bridge two or more WLANs. If this checkbox is selected, you will have to set the following parameters as shown below. Make sure the following settings are correct

Enable WDS Bridging
 SSID (to be bridged):
 BSSID (to be bridged): Example:00-1D-0F-11-22-33

 WDS Mode: Auto
 Key type: None
 WEP Index: 1
 Auth type: open
 Password:

- **SSID (to be bridged)** - The SSID of the AP your router is going to connect to as a client. You can also use the search function to select the SSID to join.
- **BSSID (to be bridged)** - The BSSID of the AP your router is going to connect to as a client. You can also use the search function to select the BSSID to join.
- **Survey** - Click this button, you can search the AP which runs in the current channel.
- **WDS Mode** - This field determines which WDS Mode will be used. It is not necessary to change the WDS Mode unless you notice network communication problems with root AP. If you select Auto, then router will choose the appropriate WDS Mode automatically.
- **Key type** - This option should be chosen according to the AP's security configuration. It is recommended that the security type is the same as your AP's security type
- **WEP Index** - This option should be chosen if the key type is WEP(ASCII) or WEP(HEX). It indicates the index of the WEP key.
- **Auth Type** - This option should be chosen if the key type is WEP(ASCII) or WEP(HEX). It indicates the authorization type of the Root AP.
- **Password** - If the AP your router is going to connect needs password, you need to fill the password in this blank.

4.6.2 Wireless Security

Choose menu "**Wireless**→**Wireless Security**", you can configure the security settings of your wireless network.

There are five wireless security modes supported by the router: WEP (Wired Equivalent Privacy), WPA (Wi-Fi Protected Access), WPA2 (Wi-Fi Protected Access 2), WPA2-PSK (Pre-Shared Key), WPA-PSK (Pre-Shared Key).

Figure 4-17 Wireless Security

- **Disable Security** - If you do not want to use wireless security, select this check box, but it's strongly recommended to choose one of the following modes to enable security.
- **WPA/WPA2 – Personal (Recommended)** - It's the WPA/WPA2 authentication type based on pre-shared passphrase.
 - **Version** - you can choose the version of the WPA-PSK security on the drop-down list. The default setting is **Automatic**, which can select **WPA-PSK** (Pre-shared key of WPA) or **WPA2-PSK** (Pre-shared key of WPA) automatically based on the wireless station's capability and request.
 - **Encryption** - When **WPA-PSK** or **WPA** is set as the Authentication Type, you can select either **Automatic**, or **TKIP** or **AES** as Encryption.

 **Note:**

If you check the **WPA/WPA2 – Personal (Recommended)** radio button and choose TKIP encryption, you will find a notice in red as shown in Figure 4-18.

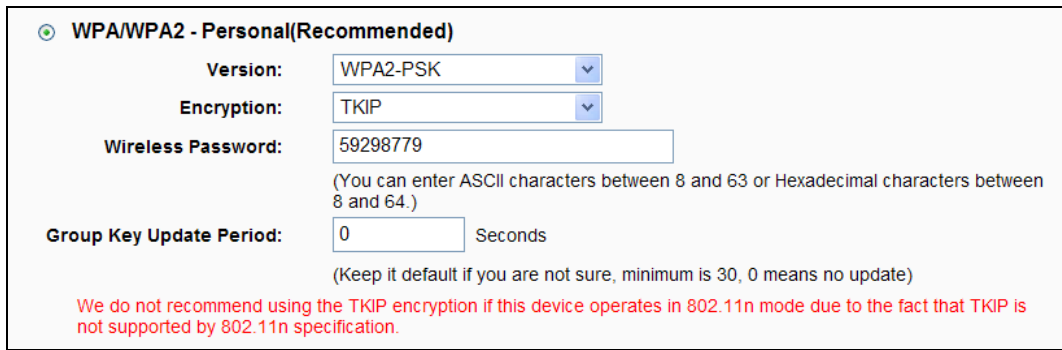

WPA/WPA2 - Personal(Recommended)

Version: WPA2-PSK

Encryption: TKIP

Wireless Password: 59298779
(You can enter ASCII characters between 8 and 63 or Hexadecimal characters between 8 and 64.)

Group Key Update Period: 0 Seconds
(Keep it default if you are not sure, minimum is 30, 0 means no update)

We do not recommend using the TKIP encryption if this device operates in 802.11n mode due to the fact that TKIP is not supported by 802.11n specification.

Figure 4-18

- **Wireless Password** - You can enter ASCII characters between 8 and 63 characters or 8 to 64 Hexadecimal characters.
- **Group Key Update Period** - Specify the group key update interval in seconds. The value should be 30 or above. Enter 0 to disable the update.

Be sure to click the **Save** button to save your settings on this page.

➤ **WPA /WPA2 – Enterprise** - It's based on Radius Server.

- **Version** - you can choose the version of the WPA security on the pull-down list. The default setting is **Automatic**, which can select **WPA** (Wi-Fi Protected Access) or **WPA2** (WPA version 2) automatically based on the wireless station's capability and request.
- **Encryption** - You can select either **Automatic**, or **TKIP** or **AES**.

 **Note:**

If you check the **WPA/WPA2** radio button and choose TKIP encryption, you will find a notice in red as shown in Figure 4-19.

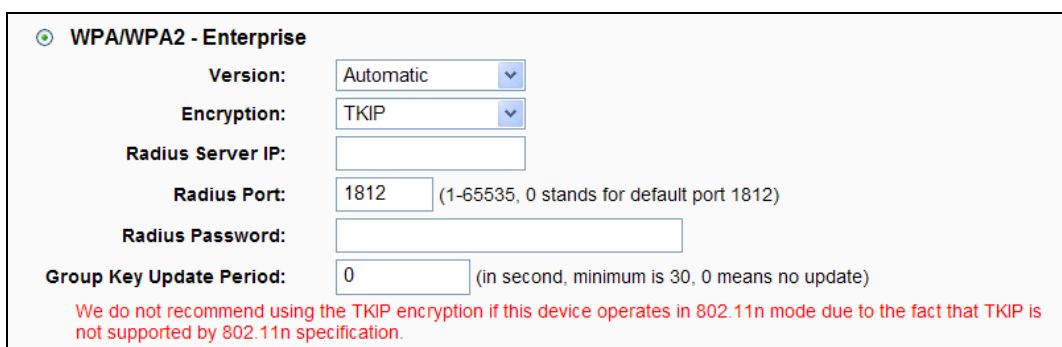

WPA/WPA2 - Enterprise

Version: Automatic

Encryption: TKIP

Radius Server IP:

Radius Port: 1812 (1-65535, 0 stands for default port 1812)

Radius Password:

Group Key Update Period: 0 (in second, minimum is 30, 0 means no update)

We do not recommend using the TKIP encryption if this device operates in 802.11n mode due to the fact that TKIP is not supported by 802.11n specification.

Figure 4-19

- **Radius Server IP** - Enter the IP address of the Radius Server.
- **Radius Port** - Enter the port that radius service used.
- **Radius Password** - Enter the password for the Radius Server.

- **Group Key Update Period** - Specify the group key update interval in seconds. The value should be 30 or above. Enter 0 to disable the update.
- **WEP** - It is based on the IEEE 802.11 standard. If you select this check box, you will find a notice in red as show in Figure 4-20.

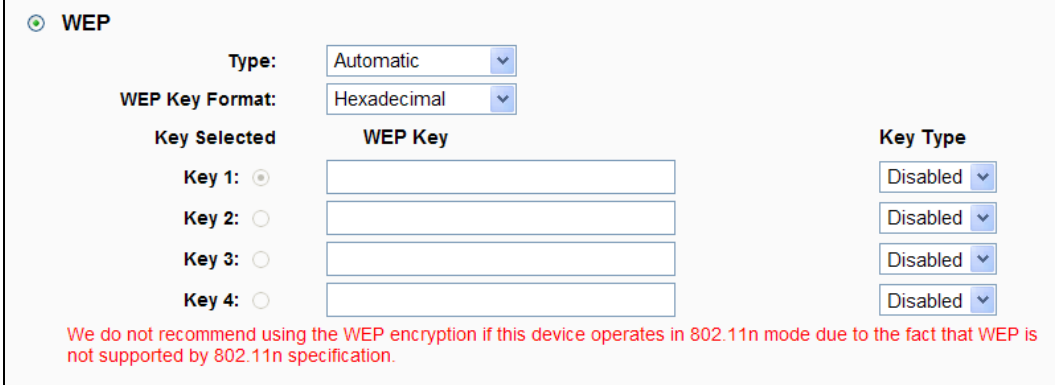

WEP

Type: Automatic

WEP Key Format: Hexadecimal

Key Selected	WEP Key	Key Type
Key 1: <input checked="" type="radio"/>	<input type="text"/>	Disabled
Key 2: <input type="radio"/>	<input type="text"/>	Disabled
Key 3: <input type="radio"/>	<input type="text"/>	Disabled
Key 4: <input type="radio"/>	<input type="text"/>	Disabled

We do not recommend using the WEP encryption if this device operates in 802.11n mode due to the fact that WEP is not supported by 802.11n specification.

Figure 4-20

- **Type** - you can choose the type for the WEP security on the pull-down list. The default setting is **Automatic**, which can select **Open System** or **Shared Key** authentication type automatically based on the wireless station's capability and request.
- **WEP Key Format** - **Hexadecimal** and **ASCII** formats are provided. **Hexadecimal** format stands for any combination of hexadecimal digits (0-9, a-f, A-F) in the specified length. **ASCII** format stands for any combination of keyboard characters in the specified length.
- **WEP Key**- Select which of the four keys will be used and enter the matching WEP key that you create. Make sure these values are identical on all wireless stations in your network.
- **Key Type** - You can select the WEP key length (64-bit, or 128-bit, or 152-bit.) for encryption. "Disabled" means this WEP key entry is invalid.

64-bit - You can enter 10 hexadecimal digits (any combination of 0-9, a-f, A-F, zero key is not promoted) or 5 ASCII characters.

128-bit - You can enter 26 hexadecimal digits (any combination of 0-9, a-f, A-F, zero key is not promoted) or 13 ASCII characters.

152-bit - You can enter 32 hexadecimal digits (any combination of 0-9, a-f, A-F, zero key is not promoted) or 16 ASCII characters.

 **Note:**

If you do not set the key, the wireless security function is still disabled even if you have selected Shared Key as Authentication Type.

4.6.3 Wireless MAC Filtering

Choose menu “**Wireless→MAC Filtering**”, you can control the wireless access by configuring the Wireless MAC Address Filtering function, shown in Figure 4-21.

Figure 4-21 Wireless MAC address Filtering

To filter wireless users by MAC Address, click **Enable**. The default setting is **Disabled**.

- **MAC Address** - The wireless station's MAC address that you want to filter.
- **Status** - The status of this entry either **Enabled** or **Disabled**.
- **Description** - A simple description of the wireless station.

To Add a Wireless MAC Address filtering entry, click the **Add New...** button. The "**Add or Modify Wireless MAC Address Filtering entry**" page will appear, shown in Figure 4-22:

Figure 4-22 Add or Modify Wireless MAC Address Filtering entry

To add or modify a **MAC Address Filtering** entry, follow these instructions:

1. Enter the appropriate MAC Address into the **MAC Address** field. The format of the MAC Address is XX-XX-XX-XX-XX-XX (X is any hexadecimal digit). For example: 00-0A-EB-00-07-8A.
2. Enter a simple description of the wireless station in the **Description** field. For example: Wireless station A.
3. **Status** - Select **Enabled** or **Disabled** for this entry on the **Status** pull-down list.
4. Click the **Save** button to save this entry.

To modify or delete an existing entry:

1. Click the **Modify** in the entry you want to modify. If you want to delete the entry, click the **Delete**.
2. Modify the information.
3. Click the **Save** button.

Click the **Enable All** button to make all entries enabled

Click the **Disabled All** button to make all entries disabled.

Click the **Delete All** button to delete all entries

Click the **Next** button to go to the next page

Click the **Previous** button to return to the previous page.

For example: If you desire that the wireless station A with MAC address 00-0A-EB-00-07-8A and the wireless station B with MAC address 00-0A-EB-00-23-11 are able to access the router, but all the other wireless stations cannot access the router, you can configure the **Wireless MAC Address Filtering** list by following these steps:

1. Click the **Enable** button to enable this function.
2. Select the radio button: **Allow** the stations specified by any enabled entries in the list to access for **Filtering Rules**.
3. Delete all or disable all entries if there are any entries already.
4. Click the **Add New...** button and enter the MAC address 00-0A-EB-00-07-8A /00-0A-EB-00-23-11 in the **MAC Address** field, then enter wireless station A/B in the **Description** field, while select **Enabled** in the **Status** pull-down list. Finally, click the **Save** button.

The filtering rules that configured should be similar to the following list:

Filtering Rules

Deny the stations specified by any enabled entries in the list to access.

Allow the stations specified by any enabled entries in the list to access.

ID	MAC Address	Status	Description	Modify
1	00-0A-EB-00-07-8A	Enabled	wireless station A	Modify Delete
2	00-0A-EB-00-23-11	Enabled	wireless station B	Modify Delete

4.6.4 Wireless Advanced

Choose menu “**Wireless**→**Wireless Advanced**”, you can configure the advanced settings of your wireless network.

Wireless Advanced

Transmit Power: High

Beacon Interval : (20-1000)

RTS Threshold: (1-2346)

Fragmentation Threshold: (256-2346)

DTIM Interval: (1-255)

Enable WMM

Enable Short GI

Enable AP Isolation

Figure 4-23 Wireless Advanced

- **Transmit Power** - Here you can specify the transmit power of router. You can select High, Middle or Low which you would like. High is the default setting and is recommended.
- **Beacon Interval** - Enter a value between 20-1000 milliseconds for Beacon Interval here. The beacons are the packets sent by the router to synchronize a wireless network. Beacon Interval value determines the time interval of the beacons. The default value is 100.
- **RTS Threshold** - Here you can specify the RTS (Request to Send) Threshold. If the packet is larger than the specified RTS Threshold size, the router will send RTS frames to a particular receiving station and negotiate the sending of a data frame. The default value is 2346.

- **Fragmentation Threshold** - This value is the maximum size determining whether packets will be fragmented. Setting the Fragmentation Threshold too low may result in poor network performance since excessive packets. 2346 is the default setting and is recommended.
- **DTIM Interval** - This value determines the interval of the Delivery Traffic Indication Message (DTIM). A DTIM field is a countdown field informing clients of the next window for listening to broadcast and multicast messages. When the router has buffered broadcast or multicast messages for associated clients, it sends the next DTIM with a DTIM Interval value. You can specify the value between 1-255 Beacon Intervals. The default value is 1, which indicates the DTIM Interval is the same as Beacon Interval.
- **Enable WMM** - WMM function can guarantee the packets with high- priority messages being transmitted preferentially. It is strongly recommended enabled.
- **Enable Short GI** - This function is recommended for it will increase the data capacity by reducing the guard interval time.
- **Enabled AP Isolation** - This function can isolate wireless stations on your network from each other. Wireless devices will be able to communicate with the router but not with each other. To use this function, check this box. AP Isolation is disabled by default.

 **Note:**

If you are not familiar with the setting items in this page, it's strongly recommended to keep the provided default values; otherwise it may result in lower wireless network performance.

4.6.5 Wireless Statistics

Choose menu “**Wireless**→**Wireless Statistics**”, you can see the MAC Address, Current Status, Received Packets and Sent Packets for each connected wireless station.

Wireless Statistics				
Current Connected Wireless Stations numbers:		1	<input type="button" value="Refresh"/>	
ID	MAC Address	Current Status	Received Packets	Sent Packets
1	00-0A-EB-88-34-75	STA-ASSOC	416	2
<input type="button" value="Previous"/>		<input type="button" value="Next"/>		

Figure 4-24 The router attached wireless stations

- **MAC Address** - The connected wireless station's MAC address

- **Current Status** - The connected wireless station's running status, one of **STA-AUTH / STA-ASSOC / STA-JOINED / WPA / WPA-PSK / WPA2 / WPA2-PSK / AP-UP / AP-DOWN / Disconnected**
- **Received Packets** - Packets received by the station
- **Sent Packets** - Packets sent by the station

You cannot change any of the values on this page. To update this page and to show the current connected wireless stations, click on the **Refresh** button.

If the numbers of connected wireless stations go beyond one page, click the **Next** button to go to the next page and click the **Previous** button to return the previous page.

 **Note:**

This page will be refreshed automatically every 5 seconds.

4.7 Guest Network

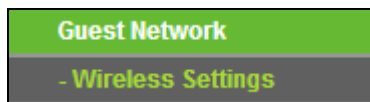

Figure 4-25 The Guest Network menu

4.7.1 Wireless Settings

Choose menu "**Guest Network** → **Wireless Settings**", you can configure the Guest Network Wireless Settings on the page as shown in Figure 4-26.

Guest Network Wireless Settings	
Access And Bandwidth Control	
Allow Guest To Access My Local Network:	<input type="checkbox"/>
Enable Guest Network Bandwidth Control:	<input type="checkbox"/>
Egress Bandwidth For Guest Network:	<input type="text" value="256"/> Kbps (Range:1~100000)
Ingress Bandwidth For Guest Network:	<input type="text" value="1024"/> Kbps (Range:1~100000)
Wireless	
Guest Network:	<input type="checkbox"/>
Network Name:	<input type="text" value="TP-LINK_GUEST_1905"/> (Also called the SSID)
Wireless Security:	WPA/WPA2-Personal
Version:	WPA2-PSK
Encryption:	AES
PSK Password:	<input type="text" value="80966159"/>
<small>(You can enter ASCII characters between 8 and 63 or Hexadecimal characters between 8 and 64.)</small>	
Group Key Update Period:	<input type="text" value="0"/> Seconds (Keep it default if you are not sure, minimum is 30, 0 means no update)
Access Time:	Schedule <input type="text" value="can not be connected."/>
	<input checked="" type="radio"/> Everyday <input type="radio"/> Select Days <input type="checkbox"/> Mon <input type="checkbox"/> Tue <input type="checkbox"/> Wed <input type="checkbox"/> Thu <input type="checkbox"/> Fri <input type="checkbox"/> Sat <input type="checkbox"/> Sun <input checked="" type="checkbox"/> All day-24 Hours Start Time: <input type="text"/> (HHMM) End Time: <input type="text"/> (HHMM)
<input type="button" value="Save"/>	

Figure 4-26 Guest Network Wireless Settings

- **Allow Guest To Access My Local Network** - If enabled, guests can communicate with hosts.
- **Enable Guest Network Bandwidth Control** - If enabled, the Guest Network Bandwidth Control rules will take effect.
- **Egress Bandwidth For Guest Network** - The upload speed through the WAN port for Guest Network.
- **Ingress Bandwidth For Guest Network** - The download speed through the WAN port for Guest Network.
- **Guest Network** - Enabled or disable the Guest Network function here.
- **Network Name** - Enter a value of up to 32 characters. The same Name (SSID) must be assigned to all wireless devices in your Guest Network.
- **Wireless Security** - You can configure the security of Guest Network here.
- **Access Time** - During this time the wireless stations could accessing the AP.

 **Note:**

The range of bandwidth for Guest Network is calculated according to the setting of Bandwidth Control on the page "Bandwidth Control->Control Settings".

4.8 DHCP

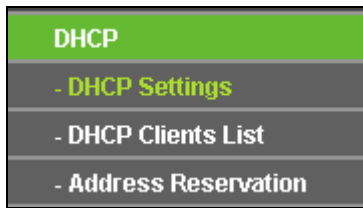

Figure 4-27 The DHCP menu

There are three submenus under the DHCP menu (shown in Figure 4-27): **DHCP Settings**, **DHCP Clients List** and **Address Reservation**. Click any of them, and you will be able to configure the corresponding function.

4.8.1 DHCP Settings

Choose menu "**DHCP→DHCP Settings**", you can configure the DHCP Server on the page (shown in Figure 4-28).The router is set up by default as a DHCP (Dynamic Host Configuration Protocol) server, which provides the TCP/IP configuration for all the PC(s) that are connected to the router on the LAN.

 A screenshot of a web configuration page titled "DHCP Settings". The page has a green header. Below the header, there are several configuration fields:

- DHCP Server:** Two radio buttons, "Disable" (unselected) and "Enable" (selected).
- Start IP Address:** A text input field containing "192.168.0.100".
- End IP Address:** A text input field containing "192.168.0.199".
- Address Lease Time:** A text input field containing "120" followed by the text "minutes (1~2880 minutes, the default value is 120)".
- Default Gateway:** A text input field containing "192.168.0.1" with "(Optional)" to its right.
- Default Domain:** An empty text input field with "(Optional)" to its right.
- Primary DNS:** A text input field containing "0.0.0.0" with "(Optional)" to its right.
- Secondary DNS:** A text input field containing "0.0.0.0" with "(Optional)" to its right.

 At the bottom center of the page is a "Save" button.

Figure 4-28 DHCP Settings

- **DHCP Server - Enable or Disable** the DHCP server. If you disable the Server, you must have another DHCP server within your network or else you must configure the computer manually.
- **Start IP Address** - Specify an IP address for the DHCP Server to start with when assigning IP addresses. 192.168.0.100 is the default start address.
- **End IP Address** - Specify an IP address for the DHCP Server to end with when assigning IP addresses. 192.168.0.199 is the default end address.
- **Address Lease Time** - The **Address Lease Time** is the amount of time a network user will be allowed connection to the router with their current dynamic IP Address. Enter the amount of time in minutes and the user will be "leased" this dynamic IP Address. After the time is up,

the user will be automatically assigned a new dynamic IP address. The range of the time is 1 ~ 2880 minutes. The default value is 120 minutes.

- **Default Gateway** - (Optional.) Suggest to input the IP address of the LAN port of the router, default value is 192.168.0.1
- **Default Domain** - (Optional.) Input the domain name of your network.
- **Primary DNS** - (Optional.) Input the DNS IP address provided by your ISP. Or consult your ISP.
- **Secondary DNS** - (Optional.) Input the IP address of another DNS server if your ISP provides two DNS servers.

 **Note:**

To use the DHCP server function of the router, you must configure all computers on the LAN as "Obtain an IP Address automatically" mode.

4.8.2 DHCP Clients List

Choose menu "DHCP→DHCP Clients List", you can view the information about the clients attached to the router in the next screen (shown in Figure 4-29).

DHCP Client List				
ID	Client Name	MAC Address	Assigned IP	Lease Time
1	tplink16461	50-E5-49-C8-E2-7A	192.168.0.100	01:12:39

Figure 4-29 DHCP Clients List

- **ID** - The index of the DHCP Client
- **Client Name** - The name of the DHCP client
- **MAC Address** - The MAC address of the DHCP client
- **Assigned IP** - The IP address that the router has allocated to the DHCP client.
- **Lease Time** - The time of the DHCP client leased. After the dynamic IP address has expired, a new dynamic IP address will be automatically assigned to the user.

You cannot change any of the values on this page. To update this page and to show the current attached devices, click the **Refresh** button.

4.8.3 Address Reservation

Choose menu "DHCP→Address Reservation", you can view and add a reserved addresses for clients via the next screen (shown in Figure 4-30).When you specify a reserved IP address for a PC on the LAN, that PC will always receive the same IP address each time when it accesses the

DHCP server. Reserved IP addresses should be assigned to the servers that require permanent IP settings.

Address Reservation				
ID	MAC Address	Reserved IP Address	Status	Modify
1	00-11-22-33-44-AA	192.168.0.100	Enabled	Modify Delete

Figure 4-30 Address Reservation

- **MAC Address** - The MAC address of the PC for which you want to reserve IP address.
- **Assigned IP Address** - The IP address of the router reserved.
- **Status** - The status of this entry either **Enabled** or **Disabled**.

To Reserve IP addresses:

1. Click the **Add New ...** button. (Pop-up Figure 4-31)
2. Enter the MAC address (in XX-XX-XX-XX-XX-XX format.) and IP address in dotted-decimal notation of the computer you wish to add.
3. Click the **Save** button when finished.

Add or Modify an Address Reservation Entry	
MAC Address:	<input type="text"/>
Reserved IP Address:	<input type="text"/>
Status:	Enabled <input type="button" value="v"/>
<input type="button" value="Save"/> <input type="button" value="Back"/>	

Figure 4-31 Add or Modify an Address Reservation Entry

To modify or delete an existing entry:

1. Click the **Modify** in the entry you want to modify. If you want to delete the entry, click the **Delete**.
2. Modify the information.
3. Click the **Save** button.

Click the **Enable/ Disabled All** button to make all entries enabled/disabled

Click the **Delete All** button to delete all entries

Click the **Next** button to go to the next page and Click the **Previous** button to return the previous page.

4.9 Forwarding

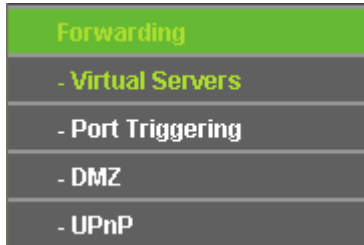

Figure 4-32 The Forwarding menu

There are four submenus under the Forwarding menu (shown in Figure 4-32): **Virtual Servers**, **Port Triggering**, **DMZ** and **UPnP**. Click any of them, and you will be able to configure the corresponding function.

4.9.1 Virtual Servers

Choose menu “**Forwarding**→**Virtual Servers**”, you can view and add virtual servers in the next screen (shown in Figure 4-33). Virtual servers can be used for setting up public services on your LAN, such as DNS, Email and FTP. A virtual server is defined as a service port, and all requests from the Internet to this service port will be redirected to the computer specified by the server IP. Any PC that was used for a virtual server must have a static or reserved IP Address because its IP Address may be changed when using the DHCP function.

Virtual Servers						
ID	Service Port	Internal Port	IP Address	Protocol	Status	Modify
1	11130	11120	192.168.0.198	ALL	Enabled	Modify Delete

Figure 4-33 Virtual Servers

- **Service Port** - The numbers of External Ports. You can type a service port or a range of service ports (in XXX – YYY format, XXX is the start port number, YYY is the end port number).

- **Internal Port** - The Internal Service Port number of the PC running the service application. You can leave it blank if the **Internal Port** is the same as the **Service Port**, or enter a specific port number when **Service Port** is a single one.
- **IP Address** - The IP Address of the PC providing the service application.
- **Protocol** - The protocol used for this application, either **TCP**, **UDP**, or **All** (all protocols supported by the router).
- **Status** - The status of this entry either **Enabled** or **Disabled**.

To set up a virtual server entry:

1. Click the **Add New...** button. (pop-up Figure 4-34)
2. Select the service you want to use from the Common Service Port list. If the **Common Service Port** list does not have the service that you want to use, type the number of the service port or service port range in the **Service Port** box.
3. Type the IP Address of the computer in the **IP Address** box.
4. Select the protocol used for this application, either **TCP** or **UDP**, or **All**.
5. Select the **Enable** check box to enable the virtual server.
6. Click the **Save** button.

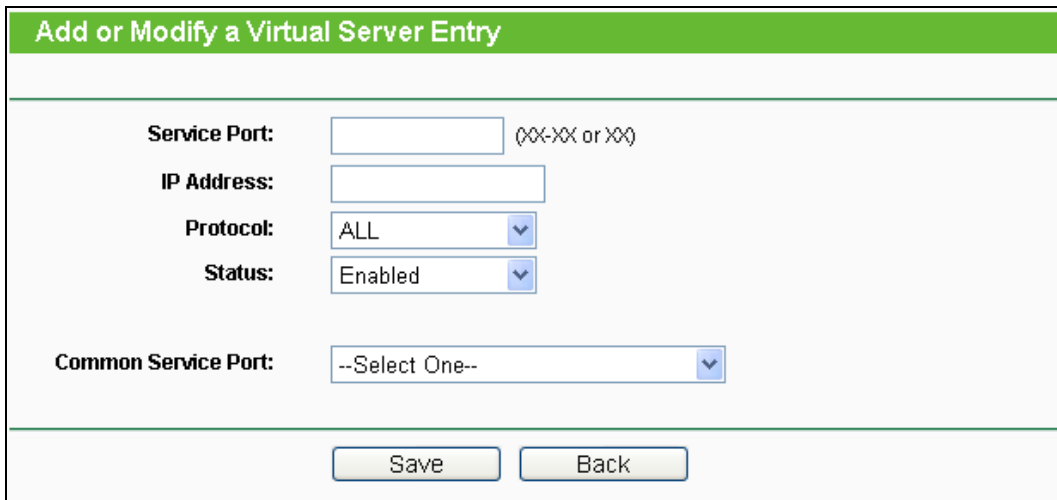

The screenshot shows a web-based configuration window titled "Add or Modify a Virtual Server Entry". The window has a green header bar. Below the header, there are several input fields and buttons. The "Service Port" field is a text box with a hint "(XX-XX or XX)". The "IP Address" field is a text box. The "Protocol" field is a dropdown menu with "ALL" selected. The "Status" field is a dropdown menu with "Enabled" selected. The "Common Service Port" field is a dropdown menu with "--Select One--" selected. At the bottom of the window, there are two buttons: "Save" and "Back".

Figure 4-34 Add or Modify a Virtual Server Entry

Note:

If your computer or server has more than one type of available service, please select another service, and enter the same IP Address for that computer or server.

To modify or delete an existing entry:

1. Click the **Modify** in the entry you want to modify. If you want to delete the entry, click the **Delete**.
2. Modify the information.
3. Click the **Save** button.

Click the **Enable/ Disabled All** button to make all entries enabled/ disabled.

Click the **Delete All** button to delete all entries.

Click the **Next** button to go to the next page and click the **Previous** button to return the previous page.

 **Note:**

If you set the service port of the virtual server as 80, you must set the Web management port on **System Tools → Remote Management** page to be any other value except 80 such as 8080. Otherwise there will be a conflict to disable the virtual server.

4.9.2 Port Triggering

Choose menu “**Forwarding→Port Triggering**”, you can view and add port triggering in the next screen (shown in Figure 4-35). Some applications require multiple connections, like Internet games, video conferencing, Internet calling and so on. These applications cannot work with a pure NAT router. Port Triggering is used for some of these applications that can work with an NAT router.

Port Triggering						
ID	Trigger Port	Trigger Protocol	Incoming Port	Incoming Protocol	Status	Modify
1	554	ALL	8970-8999	ALL	Enabled	Modify Delete

Figure 4-35 Port Triggering

Once the router is configured, the operation is as follows:

1. A local host makes an outgoing connection using a destination port number defined in the Trigger Port field.
 2. The router records this connection, opens the incoming port or ports associated with this entry in the Port Triggering table, and associates them with the local host.
 3. When necessary the external host will be able to connect to the local host using one of the ports defined in the **Incoming Ports** field.
- **Trigger Port** - The port for outgoing traffic. An outgoing connection using this port will "Trigger" this rule.
 - **Trigger Protocol** - The protocol used for Trigger Ports, either **TCP**, **UDP**, or **All** (all protocols supported by the router).

- **Incoming Port** - The port or port range used by the remote system when it responds to the outgoing request. A response using one of these ports will be forwarded to the PC that triggered this rule. You can input at most 5 groups of ports (or port section). Every group of ports must be set apart with ",". For example, 2000-2038, 2050-2051, 2085, 3010-3030.
- **Incoming Protocol** - The protocol used for Incoming Ports Range, either **TCP** or **UDP**, or **ALL** (all protocols supported by the router).
- **Status** - The status of this entry either **Enabled** or **Disabled**.

To add a new rule, follow the steps below.

1. Click the **Add New...** button, the next screen will pop-up as shown in Figure 4-36.
2. Select a common application from the **Common Applications** drop-down list, then the **Trigger Port** field and the **Incoming Ports** field will be automatically filled. If the **Common Applications** do not have the application you need, enter the **Trigger Port** and the **Incoming Ports** manually.
3. Select the protocol used for Trigger Port from the **Trigger Protocol** drop-down list, either **TCP**, **UDP**, or **All**.
4. Select the protocol used for Incoming Ports from the **Incoming Protocol** drop-down list, either **TCP** or **UDP**, or **All**.
5. Select **Enable** in **Status** field.
6. Click the **Save** button to save the new rule.

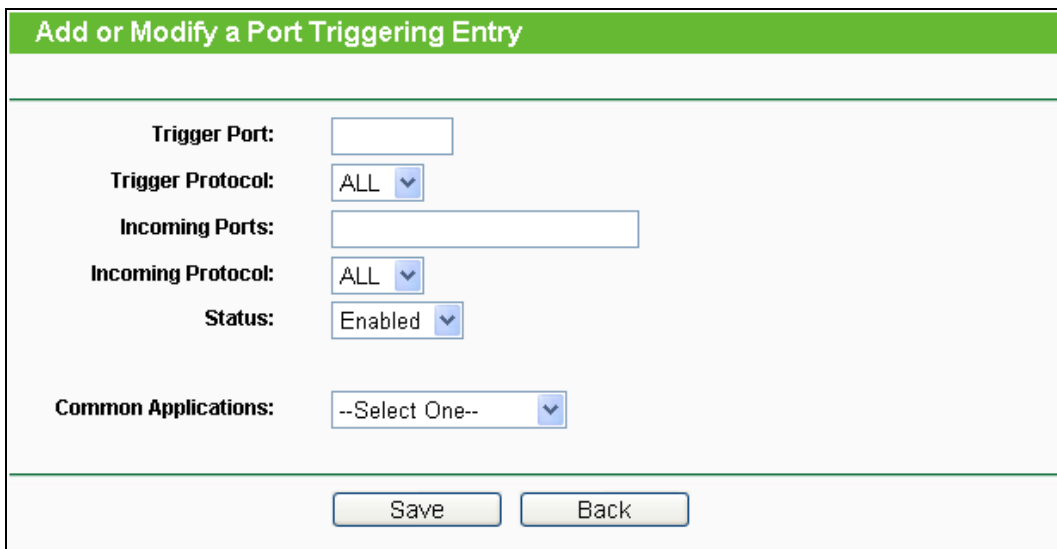

The screenshot shows a web interface for configuring port triggering. The title bar is green and reads "Add or Modify a Port Triggering Entry". The form contains the following fields and controls:

- Trigger Port:** A text input field.
- Trigger Protocol:** A dropdown menu with "ALL" selected.
- Incoming Ports:** A text input field.
- Incoming Protocol:** A dropdown menu with "ALL" selected.
- Status:** A dropdown menu with "Enabled" selected.
- Common Applications:** A dropdown menu with "--Select One--" selected.

At the bottom of the form, there are two buttons: "Save" and "Back".

Figure 4-36 Add or Modify a Triggering Entry

To modify or delete an existing entry:

1. Click the **Modify** in the entry you want to modify. If you want to delete the entry, click the **Delete**.
2. Modify the information.
3. Click the **Save** button.

Click the **Enable All** button to make all entries enabled

Click the **Disabled All** button to make all entries disabled.

Click the **Delete All** button to delete all entries

 **Note:**

1. When the trigger connection is released, the according opening ports will be closed.
2. Each rule allowed to be used only by one host on LAN synchronously. The trigger connection of other hosts on LAN will be refused.
3. Incoming Port Range cannot overlap each other.

4.9.3 DMZ

Choose menu “**Forwarding**→**DMZ**”, you can view and configure DMZ host in the screen (shown in Figure 4-37).The DMZ host feature allows one local host to be exposed to the Internet for a special-purpose service such as Internet gaming or videoconferencing. DMZ host forwards all the ports at the same time. Any PC whose port is being forwarded must have its DHCP client function disabled and should have a new static IP Address assigned to it because its IP Address may be changed when using the DHCP function.

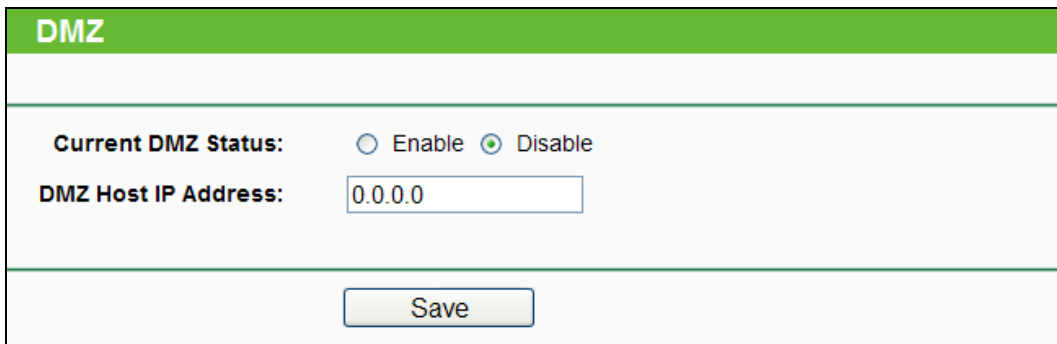

DMZ	
Current DMZ Status:	<input type="radio"/> Enable <input checked="" type="radio"/> Disable
DMZ Host IP Address:	<input type="text" value="0.0.0.0"/>
<input type="button" value="Save"/>	

Figure 4-37 DMZ

To assign a computer or server to be a DMZ server:

1. Click the **Enable** radio button
2. Enter the local host IP Address in the **DMZ Host IP Address** field
3. Click the **Save** button.

 **Note:**

After you set the DMZ host, the firewall related to the host will not work.

4.9.4 UPnP

Choose menu “**Forwarding**→**UPnP**”, you can view the information about **UPnP**(Universal Plug and Play) in the screen (shown in Figure 4-38).The UPnP feature allows the devices, such as

Internet computers, to access the local host resources or devices as needed. UPnP devices can be automatically discovered by the UPnP service application on the LAN.

UPnP

Current UPnP Status: **Enabled**

Current UPnP Settings List

ID	App Description	External Port	Protocol	Internal Port	IP Address	Status
1	BitComet(192.168.0.100:23959)	23959	TCP	23959	192.168.0.100	Enabled
2	BitComet(192.168.0.100:23959)	23959	UDP	23959	192.168.0.100	Enabled

Figure 4-38 UPnP Setting

- **Current UPnP Status** - UPnP can be enabled or disabled by clicking the **Enable** or **Disable** button. As allowing this may present a risk to security, this feature is enabled by default.
- **Current UPnP Settings List** - This table displays the current UPnP information.
 - **App Description** -The description provided by the application in the UPnP request
 - **External Port** - External port, which the router opened for the application.
 - **Protocol** - Shows which type of protocol is opened.
 - **Internal Port** - Internal port, which the router opened for local host.
 - **IP Address** - The UPnP device that is currently accessing the router.
 - **Status** - The port's status displayed here. "Enabled" means that port is still active. Otherwise, the port is inactive.

Click **Refresh** to update the Current UPnP Settings List.

4.10 Security



Figure 4-39 The Security menu

There are four submenus under the Security menu as shown in Figure 4-39: **Basic Security**, **Advanced Security**, **Local Management** and **Remote Management**. Click any of them, and you will be able to configure the corresponding function.

4.10.1 Basic Security

Choose menu “**Security** → **Basic Security**”, you can configure the basic security in the screen as shown in Figure 4-37.

 A configuration page titled 'Basic Security' with a green header. It is divided into three sections:

- Firewall**: Contains 'SPI Firewall:' with 'Enable' (selected) and 'Disable' radio buttons.
- VPN**: Contains 'PPTP Passthrough:', 'L2TP Passthrough:', and 'IPSec Passthrough:', each with 'Enable' (selected) and 'Disable' radio buttons.
- ALG**: Contains 'FTP ALG:', 'TFTP ALG:', 'H323 ALG:', and 'RTSP ALG:', each with 'Enable' (selected) and 'Disable' radio buttons.

 At the bottom center is a 'Save' button.

Figure 4-40 Basic Security

- **Firewall** - A firewall protects your network from the outside world. Here you can enable or disable the router's firewall.
 - **SPI Firewall** - SPI (Stateful Packet Inspection, also known as dynamic packet filtering) helps to prevent cyber attacks by tracking more state per session. It validates that the

traffic passing through the session conforms to the protocol. SPI Firewall is enabled by factory default. If you want all the computers on the LAN exposed to the outside world, you can disable it.

- **VPN** - VPN Passthrough must be enabled if you want to allow VPN tunnels using IPSec, PPTP, or L2TP protocols to pass through the router's firewall.
 - **PPTP Passthrough** - Point-to-Point Tunneling Protocol (PPTP) allows the Point-to-Point Protocol (PPP) to be tunneled through an IP network. To allow PPTP tunnels to pass through the router, keep the default, **Enabled**.
 - **L2TP Passthrough** - Layer 2 Tunneling Protocol (L2TP) is the method used to enable Point-to-Point sessions via the Internet on the Layer 2 level. To allow L2TP tunnels to pass through the router, keep the default, **Enabled**.
 - **IPSec Passthrough** - Internet Protocol Security (IPSec) is a suite of protocols for ensuring private, secure communications over Internet Protocol (IP) networks, through the use of cryptographic security services. To allow IPSec tunnels to pass through the router, keep the default, **Enabled**.
- **ALG** - It is recommended to enable Application Layer Gateway (ALG) because ALG allows customized Network Address Translation (NAT) traversal filters to be plugged into the gateway to support address and port translation for certain application layer "control/data" protocols such as FTP, TFTP, H323 etc.
 - **FTP ALG** - To allow FTP clients and servers to transfer data across NAT, keep the default **Enable**.
 - **TFTP ALG** - To allow TFTP clients and servers to transfer data across NAT, keep the default **Enable**.
 - **H323 ALG** - To allow Microsoft NetMeeting clients to communicate across NAT, keep the default **Enable**.
 - **RTSP ALG** - To allow some media player clients to communicate with some streaming media servers across NAT, click **Enable**.

Click the **Save** button to save your settings.

4.10.2 Advanced Security

Choose menu "**Security** → **Advanced Security**", you can protect the router from being attacked by TCP-SYN Flood, UDP Flood and ICMP-Flood in the screen as shown in Figure 4-41.

Figure 4-41 Advanced Security

- **Packets Statistics Interval (5~60)** - The default value is 10. Select a value between 5 and 60 seconds from the drop-down list. The Packets Statistics Interval value indicates the time section of the packets statistics. The result of the statistics is used for analysis by SYN Flood, UDP Flood and ICMP-Flood.
- **DoS Protection** - Denial of Service protection. Check the Enable or Disable button to enable or disable the DoS protection function. Only when it is enabled, will the flood filters be enabled.

 **Note:**

Dos Protection will take effect only when the **Traffic Statistics** in “**System Tool** → **Traffic Statistics**” is enabled.

- **Enable ICMP-FLOOD Attack Filtering** - Enable or Disable the ICMP-FLOOD Attack Filtering.
- **ICMP-FLOOD Packets Threshold (5~3600)** - The default value is 50. Enter a value between 5 ~ 3600. When the current ICMP-FLOOD Packets number is beyond the set value, the router will startup the blocking function immediately.
- **Enable UDP-FLOOD Filtering** - Enable or Disable the UDP-FLOOD Filtering.

- **UDP-FLOOD Packets Threshold (5~3600)** - The default value is 500. Enter a value between 5 ~ 3600. When the current UPD-FLOOD Packets number is beyond the set value, the router will startup the blocking function immediately.
- **Enable TCP-SYN-FLOOD Attack Filtering** - Enable or Disable the TCP-SYN-FLOOD Attack Filtering.
- **TCP-SYN-FLOOD Packets Threshold (5~3600)** - The default value is 50. Enter a value between 5 ~ 3600. When the current TCP-SYN-FLOOD Packets numbers is beyond the set value, the router will startup the blocking function immediately.
- **Ignore Ping Packet From WAN Port** - Enable or Disable Ignore Ping Packet From WAN Port. The default setting is disabled. If enabled, the ping packet from the Internet cannot access the router.
- **Forbid Ping Packet From LAN Port** - Enable or Disable Forbid Ping Packet From LAN Port. The default setting is disabled. If enabled, the ping packet from LAN cannot access the router. This function can be used to defend against some viruses.

Click the **Save** button to save the settings.

Click the **Blocked DoS Host List** button to display the DoS host table by blocking.

4.10.3 Local Management

Choose menu “**Security** → **Local Management**”, you can configure the management rule in the screen as shown in Figure 4-42. The management feature allows you to deny computers in LAN from accessing the router.

Local Management

Management Rules

All the PCs on the LAN are allowed to access the Router's Web-Based Utility

Only the PCs listed can browse the built-in web pages to perform Administrator tasks

MAC 1:

MAC 2:

MAC 3:

MAC 4:

Your PC's MAC Address:

Figure 4-42 Local Management

By default, the radio button “**All the PCs on the LAN are allowed to access the Router's Web-Based Utility**” is checked. If you want to allow PCs with specific MAC Addresses to access

the Setup page of the router's Web-Based Utility locally from inside the network, check the radio button “**Only the PCs listed can browse the built-in web pages to perform Administrator tasks**”, and then enter each MAC Address in a separate field. The format for the MAC Address is XX-XX-XX-XX-XX-XX (X is any hexadecimal digit). Only the PCs with MAC address listed can use the password to browse the built-in web pages to perform Administrator tasks while all the others will be blocked.

After click the **Add** button, your PC's MAC Address will be placed in the list above.

Click the **Save** button to save your settings.

 **Note:**

If your PC is blocked but you want to access the router again, use a pin to press and hold the **Reset Button** (hole) on the back panel for about 5 seconds to reset the router's factory defaults on the router's Web-Based Utility.

4.10.4 Remote Management

Choose menu “**Security** → **Remote Management**”, you can configure the Remote Management function in the screen as shown in Figure 4-43. This feature allows you to manage your router from a remote location via the Internet.

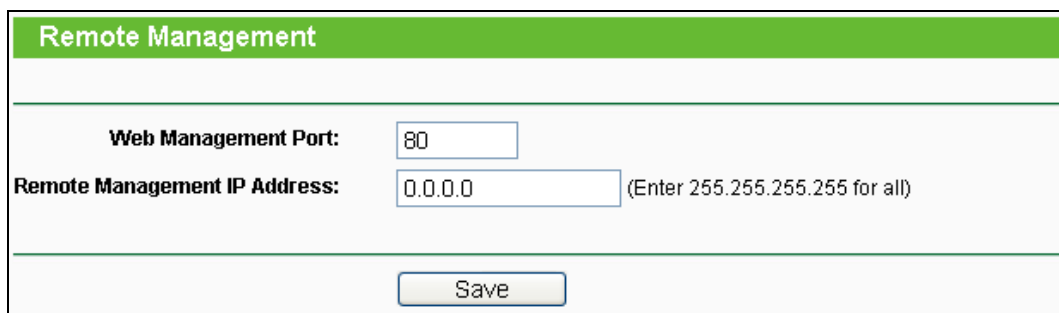

Remote Management	
Web Management Port:	<input type="text" value="80"/>
Remote Management IP Address:	<input type="text" value="0.0.0.0"/> (Enter 255.255.255.255 for all)
<input type="button" value="Save"/>	

Figure 4-43 Remote Management

- **Web Management Port** - Web browser access normally uses the standard HTTP service port 80. This router's default remote management web port number is 80. For greater security, you can change the remote management web port to a custom port by entering that number in the box provided. Choose a number between 1 and 65534 but do not use the number of any common service port.
- **Remote Management IP Address** - This is the current address you will use when accessing your router from the Internet. This function is disabled when the IP address is set to the default value of 0.0.0.0. To enable this function change 0.0.0.0 to a valid IP address. If set to 255.255.255.255, then all the hosts can access the router from internet.

 **Note:**

1. To access the router, you should type your router's WAN IP address into your browser's address (in IE) or Location (in Navigator) box, followed by a colon and the custom port

number. For example, if your router's WAN address is 202.96.12.8, and the port number used is 8080, please enter `http://202.96.12.8:8080` in your browser. Later, you may be asked for the router's password. After successfully entering the username and password, you will be able to access the router's web-based utility.

2. Be sure to change the router's default password to a very secure password.

4.11 Parental Control

Choose menu **"Parental Control"**, and you can configure the parental control in the screen as shown in Figure 4-44. The Parental Control function can be used to control the internet activities of the child, limit the child to access certain websites and restrict the time of surfing.

Figure 4-44 Parental Control Settings

- **Parental Control** - Check **Enable** if you want this function to take effect, otherwise check **Disable**.
- **MAC Address of Parental PC** - In this field, enter the MAC address of the controlling PC, or you can make use of the **Copy To Above** button below.
- **MAC Address of Your PC** - This field displays the MAC address of the PC that is managing this router. If the MAC Address of your adapter is registered, you can click the Copy To Above button to fill this address to the MAC Address of Parental PC field above.
- **Website Description** - Description of the allowed website for the PC controlled.
- **Schedule** - The time period allowed for the PC controlled to access the Internet. For detailed information, please go to **"Access Control → Schedule"**.
- **Modify** - Here you can edit or delete an existing entry.

To add a new entry, please follow the steps below.

1. Click the **Add New...** button and the next screen will pop-up as shown in Figure 4-45.
2. Enter the MAC address of the PC (e.g. 00-11-22-33-44-AA) you'd like to control in the MAC Address of Child PC field. Or you can choose the MAC address from the All Address in Current LAN drop-down list.
3. Give a description (e.g. Allow TP-LINK) for the website allowed to be accessed in the Website Description field.
4. Enter the allowed domain name of the website, either the full name or the keywords (e.g. **TP-LINK**) in the Allowed Domain Name field. Any domain name with keywords in it (<http://www.tp-link.com>) will be allowed.
5. Select from the Effective Time drop-down list the schedule (e.g. Schedule_1) you want the entry to take effect. If there are not suitable schedules for you, click the **Schedule** in red below to go to the Advance Schedule Settings page and create the schedule you need.
6. In the Status field, you can select **Enabled** or **Disabled** to enable or disable your entry.
7. Click the **Save** button.

Click the **Enable All** button to enable all the rules in the list.

Click the **Disable All** button to disable all the rules in the list.

Click the **Delete All** button to delete all the entries in the table.

Click the **Next** button to go to the next page, or click the **Previous** button return to the previous page.

Add or Modify Parental Control Entry

The Schedule is based on the time of the Router. The time can be set in "System Tools -> [Time settings](#)".

MAC Address of Children's PC:

All MAC Address in Current LAN: --Please Select--

Website Description:

Effective Time: Anytime

The time schedule can be set in "Access Control -> [Schedule](#)".

Status: Enabled

Figure 4-45 Add or Modify Parental Control Entry

For example: If you desire that the child PC with MAC address 00-11-22-33-44-AA can access www.tp-link.com on Saturday only while the parent PC with MAC address 00-11-22-33-44-BB is without any restriction, you should follow the settings below.

1. Click **“Parental Control”** menu on the left to enter the Parental Control Settings page. Check Enable and enter the MAC address 00-11-22-33-44-BB in the MAC Address of Parental PC field.
2. Click **“Access Control → Schedule”** on the left to enter the Schedule Settings page. Click **Add New...** button to create a new schedule with Schedule Description is Schedule_1, Day is Sat and Time is all day-24 hours.
3. Click **“Parental Control”** menu on the left to go back to the Add or Modify Parental Control Entry page:
 - Click **Add New...** button.
 - Enter 00-11-22-33-44-AA in the **MAC Address of Child PC** field.
 - Enter “Allow TP-LINK” in the **Website Description** field.
 - Enter “www.tp-link.com” in the **Allowed Domain Name** field.
 - Select “Schedule_1” you create just now from the **Effective Time** drop-down list.
 - In **Status** field, select Enable.
4. Click **Save** to complete the settings.

Then you will go back to the Parental Control Settings page and see the following list, as shown in Figure 4-46.

ID	MAC address	Website Description	Schedule	Status	Modify
1	00-11-22-33-44-AA	Allow TP-LINK	Schedule_1	Enabled	Edit Delete

Figure 4-46 Parental Control Settings

4.12 Access Control

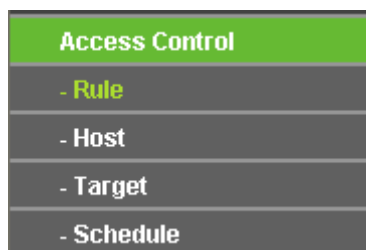

Figure 4-47 Access Control

There are four submenus under the Access Control menu as shown in Figure 4-47: **Rule**, **Host**, **Target** and **Schedule**. Click any of them, and you will be able to configure the corresponding function.

4.12.1 Rule

Choose menu “**Access Control** → **Rule**”, you can view and set Access Control rules in the screen as shown in Figure 4-48.

Figure 4-48 Access Control Rule Management

- **Enable Internet Access Control** - Select the check box to enable the Internet Access Control function, so the Default Filter Policy can take effect.
- **Rule Name** - Here displays the name of the rule and this name is unique.
- **Host** - Here displays the host selected in the corresponding rule.
- **Target** - Here displays the target selected in the corresponding rule.
- **Schedule** - Here displays the schedule selected in the corresponding rule.
- **Status** - This field displays the status of the rule. **Enabled** means the rule will take effect, **Disabled** means the rule will not take effect.
- **Modify** - Here you can edit or delete an existing rule.

To add a new rule, please follow the steps below.

1. Click the **Add New...** button and the next screen will pop-up as shown in Figure 4-49.
2. Give a name (e.g. Rule_1) for the rule in the **Rule Name** field.
3. Select a host from the **Host** drop-down list or choose “**Click Here To Add New Host List**”.

4. Select a target from the **Target** drop-down list or choose “**Click Here To Add New Target List**”.
5. Select a schedule from the **Schedule** drop-down list or choose “**Click Here To Add New Schedule**”.
6. In the **Action** field, select **Deny** or **Allow**.
7. In the **Status** field, select **Enabled** or **Disabled** to enable or disable your entry.
8. Click the **Save** button.

Click the **Enable All** button to enable all the rules in the list.

Click the **Disable All** button to disable all the rules in the list.

Click the **Delete All** button to delete all the entries in the table.

You can change the entry's order as desired. Fore entries are before hind entries. Enter the ID number in the first box you want to move and another ID number in second box you want to move to, and then click the **Move** button to change the entry's order.

Click the **Next** button to go to the next page, or click the **Previous** button return to the previous page.

Figure 4-49 Add or Modify Internet Access Control Entry

For example: If you desire to allow the host with MAC address 00-11-22-33-44-AA to access **www.tp-link.com** only from **18:00 to 20:00** on **Saturday and Sunday**, and forbid other hosts in the LAN to access the Internet, you should follow the settings below:

1. Click “**Access Control → Host**” in the left to enter the Host Settings page. Add a new entry with the Host Description is Host_1 and MAC Address is 00-11-22-33-44-AA.
2. Click “**Access Control → Target**” in the left to enter the Target Settings page. Add a new entry with the Target Description is Target_1 and Domain Name is www.tp-link.com.
3. Click “**Access Control → Schedule**” in the left to enter the Schedule Settings page. Add a new entry with the Schedule Description is Schedule_1, Day is Sat and Sun, Start Time is 1800 and Stop Time is 2000.
4. Click “**Access Control → Rule**” in the left to return to the Access Control Rule Management page. Select “**Enable Internet Access Control**” and choose “**Allow** the packets specified by any enabled access control policy to pass through the Router”.

5. Click **Add New...** button to add a new rule as follows:

- In **Rule Name** field, create a name for the rule. Note that this name should be unique, for example Rule_1.
- In **Host** field, select Host_1.
- In **Target** field, select Target_1.
- In **Schedule** field, select Schedule_1.
- In **Action** field, select Allow.
- In **Status** field, select Enable.
- Click **Save** to complete the settings.

Then you will go back to the Access Control Rule Management page and see the following list.

ID	Rule Name	Host	Target	Schedule	Action	Status	Modify
1	Rule_1	Host_1	Target_1	Schedule_1	Allow	Enabled	Edit Delete

4.12.2 Host

Choose menu “**Access Control** → **Host**”, you can view and set a Host list in the screen as shown in Figure 4-50. The host list is necessary for the Access Control Rule.

Host Settings			
ID	Host Description	Information	Modify
1	Host_1	IP: 192.168.0.1 - 192.168.0.23	Edit Delete
<input type="button" value="Add New..."/> <input type="button" value="Delete All"/>			
<input type="button" value="Previous"/> <input type="button" value="Next"/> Current No. <input type="text" value="1"/> Page			

Figure 4-50 Host Settings

- **Host Description** - Here displays the description of the host and this description is unique.
- **Information** - Here displays the information about the host. It can be IP or MAC.
- **Modify** - To modify or delete an existing entry.

To add a new entry, please follow the steps below.

1. Click the **Add New...** button.
2. In the **Mode** field, select IP Address or MAC Address.
 - If you select IP Address, the screen shown is Figure 4-51.
 - 1) In **Host Description** field, create a unique description for the host (e.g. Host_1).
 - 2) In **LAN IP Address** field, enter the IP address.
 - If you select MAC Address, the screen shown is Figure 4-52.

- 1) In **Host Description** field, create a unique description for the host (e.g. Host_1).
 - 2) In **MAC Address** field, enter the MAC address.
3. Click the **Save** button to complete the settings.

Click the **Delete All** button to delete all the entries in the table.

Click the **Next** button to go to the next page, or click the **Previous** button return to the previous page.

The screenshot shows a web form titled "Add or Modify a Host Entry". The form has a green header bar with the title. Below the header, there are three input fields: "Mode" is a dropdown menu set to "IP Address"; "Host Description" is a text box containing "Host_1"; and "LAN IP Address" is a range input box containing "192.168.0.1" and "192.168.0.23". At the bottom of the form are two buttons: "Save" and "Back".

Figure 4-51 Add or Modify a Host Entry

The screenshot shows the same "Add or Modify a Host Entry" form, but with the "Mode" dropdown menu set to "MAC Address". The "Host Description" field still contains "Host_1", and the "MAC Address" field now contains "00-11-22-33-44-AA". The "Save" and "Back" buttons are still present at the bottom.

Figure 4-52 Add or Modify a Host Entry

For example: If you desire to restrict the internet activities of host with MAC address 00-11-22-33-44-AA, you should first follow the settings below:

1. Click **Add New...** button in Figure 4-50 to enter the Add or Modify a Host Entry page.
2. In **Mode** field, select MAC Address from the drop-down list.
3. In **Host Description** field, create a **unique** description for the host (e.g. Host_1).
4. In **MAC Address** field, enter 00-11-22-33-44-AA.
5. Click **Save** to complete the settings.

Then you will go back to the Host Settings page and see the following list.

ID	Host Description	Information	Modify
1	Host_1	MAC: 00-11-22-33-44-AA	Edit Delete

4.12.3 Target

Choose menu “**Access Control** → **Target**”, you can view and set a Target list in the screen as shown in Figure 4-53. The target list is necessary for the Access Control Rule.

Target Settings			
ID	Target Description	Information	Modify
1	Target_1	192.168.0.2 - 192.168.0.23/21/TCP	Edit Delete

Current No. Page

Figure 4-53 Target Settings

- **Target Description** - Here displays the description about the target and this description is unique.
- **Information** - The target can be IP address, port, or domain name.
- **Modify** - To modify or delete an existing entry.

To add a new entry, please follow the steps below.

1. Click the **Add New...** button.
2. In **Mode** field, select IP Address or Domain Name.
 - If you select **IP Address**, the screen shown is Figure 4-54.
 - 1) In **Target Description** field, create a unique description for the target (e.g. Target_1).
 - 2) In **IP Address** field, enter the IP address of the target.
 - 3) Select a common service from **Common Service Port** drop-down list, so that the **Target Port** will be automatically filled. If the **Common Service Port** drop-down list doesn't have the service you want, specify the **Target Port** manually.
 - 4) In **Protocol** field, select TCP, UDP, ICMP or ALL.
 - If you select **Domain Name**, the screen shown is Figure 4-55.
 - 1) In **Target Description** field, create a unique description for the target (e.g. Target_1).
 - 2) In **Domain Name** field, enter the domain name, either the full name or the keywords (for example TP-LINK) in the blank. Any domain name with keywords in it will be blocked or allowed. You can enter 4 domain names.
3. Click the **Save** button.

Click the **Delete All** button to delete all the entries in the table.

Click the **Next** button to go to the next page, or click the **Previous** button return to the previous page.

The screenshot shows a web form titled "Add or Modify an Access Target Entry". The form has a green header bar with the title. Below the header, there are several fields: "Mode" is a dropdown menu set to "IP Address"; "Target Description" is a text input field; "IP Address" is a field with two sub-inputs separated by a hyphen; "Target Port" is a field with two sub-inputs separated by a hyphen; "Protocol" is a dropdown menu set to "ALL"; and "Common Service Port" is a dropdown menu set to "--please select--". At the bottom of the form are two buttons: "Save" and "Back".

Figure 4-54 Add or Modify an Access Target Entry

The screenshot shows the same web form titled "Add or Modify an Access Target Entry". In this version, the "Mode" dropdown menu is set to "Domain Name". The "Target Description" field is present. The "Domain Name" field consists of four stacked text input boxes. At the bottom of the form are two buttons: "Save" and "Back".

Figure 4-55 Add or Modify an Access Target Entry

For example: If you desire to restrict the internet activities of host with MAC address 00-11-22-33-44-AA in the LAN to access **www.tp-link.com** only, you should first follow the settings below:

1. Click **Add New...** button in Figure 4-53 to enter the Add or Modify an Access Target Entry page.
2. In **Mode** field, select Domain Name from the drop-down list.
3. In **Target Description** field, create a unique description for the target (e.g. Target_1).
4. In **Domain Name** field, enter www.tp-link.com.
5. Click **Save** to complete the settings.

Then you will go back to the Target Settings page and see the following list.

ID	Target Description	Information	Modify
1	Target_1	www.tp-link.com	Edit Delete

4.12.4 Schedule

Choose menu “**Access Control** → **Schedule**”, you can view and set a Schedule list in the next screen as shown in Figure 4-56. The Schedule list is necessary for the Access Control Rule.

Schedule Settings				
ID	Schedule Description	Day	Time	Modify
1	Schedule_1	Sat	00:00 - 24:00	Edit Delete
<input type="button" value="Add New..."/> <input type="button" value="Delete All"/>				
<input type="button" value="Previous"/> <input type="button" value="Next"/> Page <input type="text" value="1"/>				

Figure 4-56 Schedule Settings

- **Schedule Description** - Here displays the description of the schedule and this description is unique.
- **Day** - Here displays the day(s) in a week.
- **Time** - Here displays the time period in a day.
- **Modify** - Here you can edit or delete an existing schedule.

To add a new schedule, follow the steps below.

1. Click **Add New...** button shown in Figure 4-56 and the next screen will pop-up as shown in Figure 4-57.
2. In **Schedule Description** field, create a unique description for the schedule (e.g. Schedule_1).
3. In **Day** field, select the day or days you need.
4. In **Time** field, you can select all day-24 hours or you may enter the Start Time and Stop Time in the corresponding field.
5. Click **Save** to complete the settings.

Click the **Delete All** button to delete all the entries in the table.

Click the **Next** button to go to the next page, or click the **Previous** button return to the previous page.

Figure 4-57 Advanced Schedule Settings

For example: If you desire to restrict the internet activities of host with MAC address 00-11-22-33-44-AA to access www.tp-link.com only from **18:00 to 20:00** on **Saturday** and **Sunday**, you should first follow the settings below:

1. Click **Add New...** button shown in Figure 4-56 to enter the Advanced Schedule Settings page.
2. In **Schedule Description** field, create a unique description for the schedule (e.g. Schedule_1).
3. In **Day** field, check the Select Days radio button and then select Sat and Sun.
4. In **Time** field, enter 1800 in Start Time field and 2000 in Stop Time field.
5. Click **Save** to complete the settings.

Then you will go back to the Schedule Settings page and see the following list.

ID	Schedule Description	Day	Time	Modify
1	Schedule_1	Sat Sun	18:00 - 20:00	Edit Delete

4.13 Advanced Routing

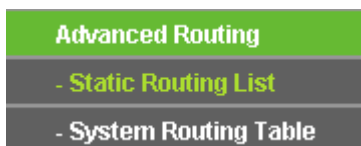

Figure 4-58 Advanced Routing

There are two submenus under the Advanced Routing menu as shown in Figure 4-58: **Static Routing List** and **System Routing Table**. Click any of them, and you will be able to configure the corresponding function.

4.13.1 Static Routing List

Choose menu “**Advanced Routing** → **Static Routing List**”, and then you can configure the static route in the next screen (shown in Figure 4-59). A static route is a pre-determined path that network information must travel to reach a specific host or network.

ID	Destination Network	Subnet Mask	Default Gateway	Status	Modify
<input type="button" value="Add New..."/> <input type="button" value="Enable All"/> <input type="button" value="Disable All"/> <input type="button" value="Delete All"/>					
<input type="button" value="Previous"/> <input type="button" value="Next"/>					

Figure 4-59 Static Routing

To add static routing entries:

1. Click **Add New...** shown in Figure 4-59, you will see the following screen.

Destination Network:
Subnet Mask:
Default Gateway:
Status:

Figure 4-60 Add or Modify a Static Route Entry

2. Enter the following data:
 - **Destination Network** - The Destination Network is the address of the network or host that you want to assign to a static route.
 - **Subnet Mask** - The **Subnet Mask** determines which portion of an IP Address is the network portion, and which portion is the host portion.
 - **Default Gateway** - This is the IP Address of the gateway device that allows for contact between the router and the network or host.
3. Select **Enabled** or **Disabled** for this entry on the **Status** drop-down list.
4. Click the **Save** button to make the entry take effect.

Other configurations for the entries:

Click the **Delete** button to delete the entry.

Click the **Enable All** button to enable all the entries.

Click the **Disable All** button to disable all the entries.

Click the **Delete All** button to delete all the entries.

Click the **Previous** button to view the information in the previous screen, click the **Next** button to view the information in the next screen.

4.13.2 System Routing Table

Choose menu “**Advanced Routing** → **System Routing Table**”, and then you can view the System Routing Table in the next screen (shown in Figure 4-61). System routing table views all of the valid route entries in use. The Destination IP address, Subnet Mask, Gateway, and Interface will be displayed for each entry.

System Routing Table				
ID	Destination Network	Subnet Mask	Gateway	Interface
1	192.168.1.0	255.255.255.0	0.0.0.0	WAN
2	192.168.0.0	255.255.255.0	0.0.0.0	LAN & WLAN
3	239.0.0.0	255.0.0.0	0.0.0.0	LAN & WLAN
4	0.0.0.0	0.0.0.0	192.168.1.1	WAN

Figure 4-61 System Routing Table

- **Destination Network** - The Destination Network is the address of the network or host to which the static route is assigned.
- **Subnet Mask** - The Subnet Mask determines which portion of an IP address is the network portion, and which portion is the host portion.
- **Gateway** - This is the IP address of the gateway device that allows for contact between the router and the network or host.
- **Interface** - This interface tells you either the Destination IP Address is on the **LAN & WLAN** (internal wired and wireless networks), or on the **WAN** (Internet).

4.14 Bandwidth Control



Figure 4-62

There are two submenus under the Bandwidth Control menu as shown in Figure 4-62. Click any of them, and you will be able to configure the corresponding function. The detailed explanations for each submenu are provided below.

4.14.1 Control Settings

Choose menu “**Bandwidth Control** → **Control Settings**”, you can configure the Egress Bandwidth and Ingress Bandwidth in the next screen. Their values you configure should be less than 100000Kbps. For optimal control of the bandwidth, please select the right Line Type and ask your ISP for the total bandwidth of the egress and ingress.

A screenshot of the 'Bandwidth Control Settings' configuration page. The title bar is green with the text 'Bandwidth Control Settings'. Below the title bar, there are four main settings: 'Enable Bandwidth Control' with an unchecked checkbox; 'Line Type' with two radio buttons, 'ADSL' (checked) and 'Other' (unchecked); 'Egress Bandwidth' with a text input field containing '512' and 'Kbps' to its right; and 'Ingress Bandwidth' with a text input field containing '2048' and 'Kbps' to its right. At the bottom of the form is a 'Save' button.

Figure 4-63 Bandwidth Control Settings

- **Enable Bandwidth Control** - Check this box so that the Bandwidth Control settings can take effect.
- **Line Type** - Select the right type for you network connection. If you don't know how to choose, please ask your ISP for the information.
- **Egress Bandwidth** - The upload speed through the WAN port.
- **Ingress Bandwidth** - The download speed through the WAN port.

4.14.2 Rule List

Choose menu “**Bandwidth Control** → **Rule List**”, you can view and configure the Bandwidth Control rules in the screen below.

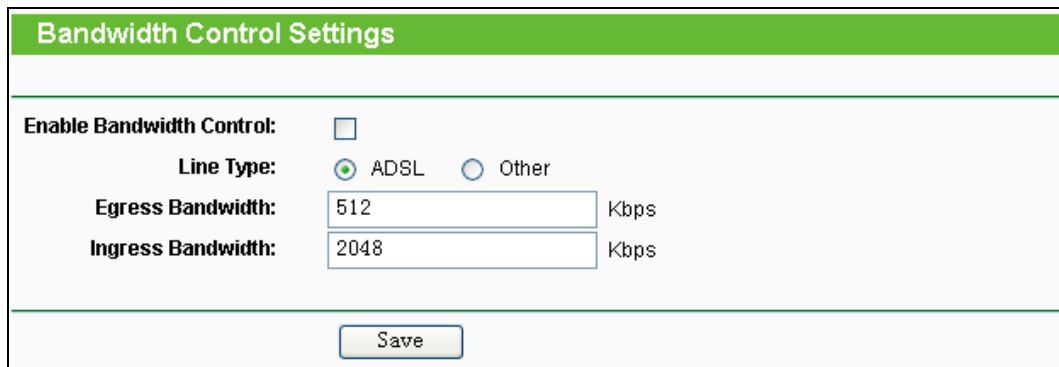
Bandwidth Control Rule List							
ID	Description	Egress Bandwidth(Kbps)		Ingress Bandwidth(Kbps)		Enable	Modify
		Min	Max	Min	Max		
The current list is empty.							
<input type="button" value="Add New..."/> <input type="button" value="Delete All"/>							
<input type="button" value="Previous"/> <input type="button" value="Next"/> Current No. <input type="text" value="1"/> Page							

Figure 4-64 Bandwidth Control Rules List

- **Description** - This is the information about the rules such as address range.
- **Egress bandwidth** - This field displays the max and mix upload bandwidth through the WAN port, the default is 0.
- **Ingress bandwidth** - This field displays the max and mix download bandwidth through the WAN port, the default is 0.
- **Enable** - This displays the status of the rule.
- **Modify** - Click **Modify** to edit the rule. Click **Delete** to delete the rule.

To add/modify a Bandwidth Control rule, follow the steps below.

Step 1: Click **Add New...** shown in Figure 4-64, you will see a new screen shown in Figure 4-65.

Step 2: Enter the information like the screen shown below.

Bandwidth Control Rule Settings			
Enable:	<input checked="" type="checkbox"/>		
IP Range:	<input type="text"/> - <input type="text"/>		
Port Range:	<input type="text"/> - <input type="text"/>		
Protocol:	All <input type="button" value="v"/>		
	Min Bandwidth(Kbps)	Max Bandwidth(Kbps)	
Egress Bandwidth:	<input type="text" value="0"/>	<input type="text" value="0"/>	
Ingress Bandwidth:	<input type="text" value="0"/>	<input type="text" value="0"/>	
<input type="button" value="Save"/> <input type="button" value="Back"/>			

Figure 4-65 Bandwidth Control Rule Settings

Step 3: Click the **Save** button.

4.15 IP & MAC Binding

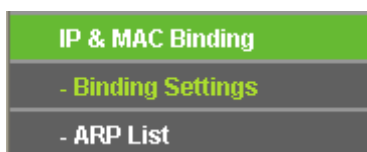

Figure 4-66 the IP & MAC Binding menu

There are two submenus under the IP & MAC Binding menu (shown in Figure 4-66): **Binding Settings** and **ARP List**. Click any of them, and you will be able to scan or configure the corresponding function. The detailed explanations for each submenu are provided below.

4.15.1 Binding Settings

This page displays the **IP & MAC Binding** table; you can operate it in accord with your desire. (shown in Figure 4-67).

Figure 4-67 Binding Setting

- **MAC Address** - The MAC address of the controlled computer in the LAN.
- **IP Address** - The assigned IP address of the controlled computer in the LAN.
- **Bind** - Check this option to enable ARP binding for a specific device.
- **Modify** - To modify or delete an existing entry.

When you want to add or modify an IP & MAC Binding entry, you can click the **Add New** button or **Modify** button, and then you will go to the next page. This page is used for adding or modifying an IP & MAC Binding entry (shown in Figure 4-68).

Figure 4-68 IP & MAC Binding Setting (Add & Modify)

To add IP & MAC Binding entries, follow the steps below.

1. Click the **Add New...** button as shown in Figure 4-62.
2. Enter the MAC Address and IP Address.

3. Select the Bind checkbox.
4. Click the **Save** button to save it.

To modify or delete an existing entry, follow the steps below.

1. Find the desired entry in the table.
2. Click **Modify** or **Delete** as desired on the **Modify** column.

To find an existing entry, follow the steps below.

1. Click the **Find** button as shown in Figure 4-67.
2. Enter the MAC Address or IP Address.
3. Click the **Find** button in the page as shown in Figure 4-69.

Find IP & MAC Binding Entry				
MAC Address:	<input type="text"/>			
IP Address:	<input type="text"/>			
ID	MAC Address	IP Address	Bind Link	
1	00-11-22-33-44-BB	192.168.0.100	<input checked="" type="checkbox"/>	To page
<input type="button" value="Find"/> <input type="button" value="Back"/>				

Figure 4-69 Find IP & MAC Binding Entry

Click the **Enable All** button to make all entries enabled.

Click the **Delete All** button to delete all entries.

4.15.2 ARP List

To manage the computer, you could observe the computers in the LAN by checking the relationship of MAC address and IP address on the ARP list, and you could configure the items on the ARP list also. This page displays the ARP List; it shows all the existing IP & MAC Binding entries (shown in Figure 4-70).

ARP List				
ID	MAC Address	IP Address	Status	Configure
1	40-61-86-FC-74-93	192.168.0.100	Unbound	Load Delete
<input type="button" value="Bind All"/> <input type="button" value="Load All"/> <input type="button" value="Refresh"/>				

Figure 4-70 ARP List

- **MAC Address** - The MAC address of the controlled computer in the LAN.

- **IP Address** - The assigned IP address of the controlled computer in the LAN.
- **Status** - Indicates whether or not the MAC and IP addresses are bound.
- **Configure** - Load or delete an item.
 - **Load** - Load the item to the IP & MAC Binding list.
 - **Delete** - Delete the item.

Click the **Bind All** button to bind all the current items, available after enable.

Click the **Load All** button to load all items to the IP & MAC Binding list.

Click the **Refresh** button to refresh all items.

 **Note:**

An item could not be loaded to the IP & MAC Binding list if the IP address of the item has been loaded before. Error warning will prompt as well. Likewise, "Load All" only loads the items without interference to the IP & MAC Binding list.

4.16 Dynamic DNS

Choose menu "**Dynamic DNS**", and you can configure the Dynamic DNS function.

The router offers the **DDNS** (Dynamic Domain Name System) feature, which allows the hosting of a website, FTP server, or e-mail server with a fixed domain name (named by yourself) and a dynamic IP address, and then your friends can connect to your server by entering your domain name no matter what your IP address is. Before using this feature, you need to sign up for DDNS service providers such as www.comexe.cn, dyn.com/dns, or www.noip.com. The Dynamic DNS client service provider will give you a password or key.

4.16.1 Comexe.cn DDNS

If the dynamic DNS **Service Provider** you select is www.comexe.cn, the page will appear as shown in Figure 4-71.

DDNS

Service Provider: Comexe (www.comexe.cn) [Go to register...](#)

Domain Name:

Domain Name:

Domain Name:

Domain Name:

Domain Name:

User Name:

Password:

Enable DDNS

Connection Status: DDNS not launching!

Figure 4-71 Comexe.cn DDNS Settings

To set up for DDNS, follow these instructions:

1. Type the **Domain Name** received from your dynamic DNS service provider.
2. Type the **User Name** for your DDNS account.
3. Type the **Password** for your DDNS account.
4. Click the **Login** button to log in to the DDNS service.

Connection Status -The status of the DDNS service connection is displayed here.

Click **Logout** to log out of the DDNS service.

4.16.2 Dyndns.org DDNS

If the dynamic DNS **Service Provider** you select is dyn.com/dns, the page will appear as shown in Figure 4-72.

DDNS

Service Provider: DynDNS (dyn.com/dns) [Go to register...](#)

User Name:

Password:

Domain Name:

Enable DDNS

Connection Status: DDNS not launching!

Figure 4-72 DynDNS.org DDNS Settings

To set up for DDNS, follow these instructions:

1. Type the **User Name** for your DDNS account.
2. Type the **Password** for your DDNS account.
3. Type the **Domain Name** you received from dynamic DNS service provider here.
4. Click the **Login** button to log in to the DDNS service.

Connection Status -The status of the DDNS service connection is displayed here.

Click **Logout** to logout of the DDNS service.

4.16.3 No-ip.com DDNS

If the dynamic DNS **Service Provider** you select is www.noip.com, the page will appear as shown in Figure 4-68.

DDNS

Service Provider: No-IP (www.noip.com) [Go to register...](#)

User Name:

Password:

Domain Name:

Enable DDNS

Connection Status: DDNS not launching!

Figure 4-73 No-ip.com DDNS Settings

To set up for DDNS, follow these instructions:

1. Type the **User Name** for your DDNS account.
2. Type the **Password** for your DDNS account.
3. Type the **Domain Name** you received from dynamic DNS service provider.
4. Click the **Login** button to log in the DDNS service.

Connection Status - The status of the DDNS service connection is displayed here.

Click **Logout** to log out the DDNS service.

4.17 System Tools



Figure 4-74 The System Tools menu

Choose menu "**System Tools**", and you can see the submenus under the main menu: **Time Settings**, **Diagnostic**, **Firmware Upgrade**, **Factory Defaults**, **Backup & Restore**, **Reboot**,

Password, System Log and Statistics. Click any of them, and you will be able to configure the corresponding function. The detailed explanations for each submenu are provided below.

4.17.1 Time Settings

Choose menu “**System Tools** → **Time Settings**”, you can configure the time on the following screen.

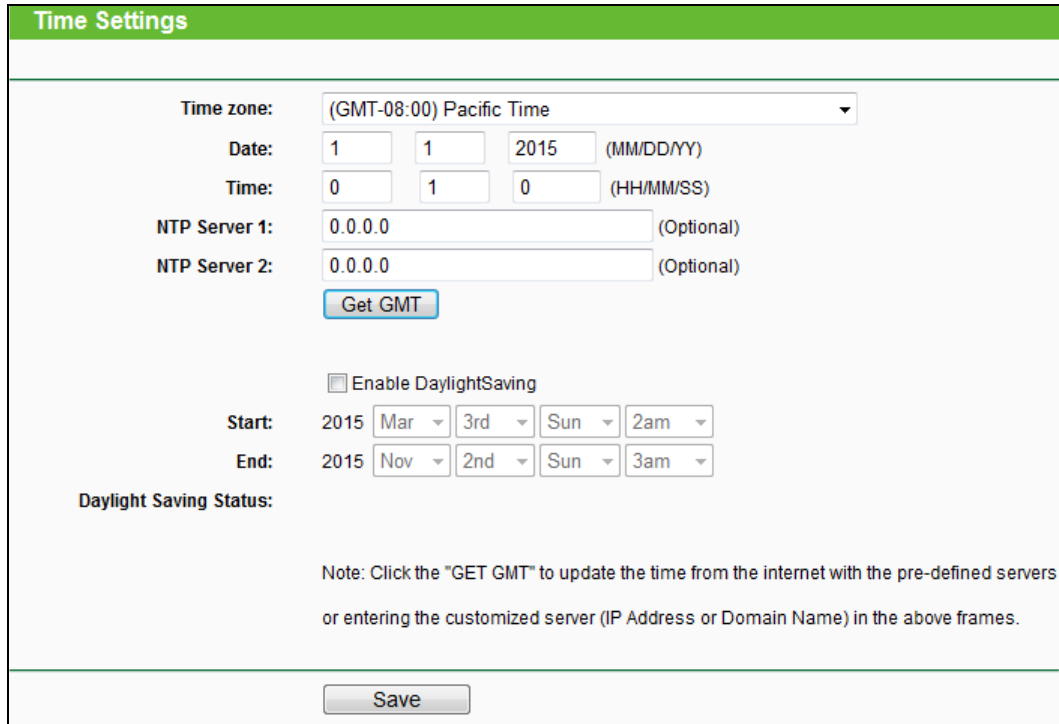

Figure 4-75 Time settings

- **Time Zone** - Select your local time zone from this drop-down list.
- **Date** - Enter your local date in MM/DD/YY into the right blanks.
- **Time** - Enter your local time in HH/MM/SS into the right blanks.
- **NTP Server I / NTP Server II** - Enter the address or domain of the **NTP Server I** or **NTP Server II**, and then the router will get the time from the NTP Server preferentially. In addition, the router built-in some common NTP Servers, so it can get time automatically once it connects the Internet.
- **Enable Daylight Saving** - Check the box to enable the Daylight Saving function.
- **Start** - The time to start the Daylight Saving. Select the month in the first field, the week in the second field, the day in the third field and the time in the last field.
- **End** - The time to end the Daylight Saving. Select the month in the first field, the week in the second field, the day in the third field and the time in the last field.
- **Daylight Saving Status** - Displays the status whether the Daylight Saving is in use.

To set time manually:

1. Select your local time zone.
2. Enter the **Date** in Month/Day/Year format.
3. Enter the **Time** in Hour/Minute/Second format.
4. Click **Save**.

To set time automatically:

1. Select your local time zone.
2. Enter the address or domain of the **NTP Server I** or **NTP Server II**.
3. Click the **Get GMT** button to get system time from Internet if you have connected to the Internet.

To set Daylight Saving:

1. Check the box to enable Daylight Saving.
2. Select the start time from the drop-down lists in the **Start** field.
3. Select the end time from the drop-down lists in the **End** field.
4. Click the **Save** button to save the settings.

	<input checked="" type="checkbox"/> Enable DaylightSaving
Start:	2014 Mar 3rd Sun 2am
End:	2014 Nov 2nd Sun 3am
Daylight Saving Status:	daylight saving is down.

 **Note:**

1. This setting will be used for some time-based functions such as firewall. You must specify your time zone once you login to the router successfully, otherwise, these functions will not take effect.
2. The time will be lost if the router is turned off.
3. The router will automatically obtain GMT from the Internet if it is configured accordingly.
4. The Daylight Saving will take effect one minute after the configurations are completed.

4.17.2 Diagnostic

Choose menu "**System Tools** → **Diagnostic**", you can transact Ping or Traceroute function to check connectivity of your network in the following screen.

Figure 4-76 Diagnostic Tools

- **Diagnostic Tool** - Check the radio button to select one diagnostic tool.
 - **Ping** - This diagnostic tool troubleshoots connectivity, reachability, and name resolution to a given host or gateway.
 - **Traceroute** - This diagnostic tool tests the performance of a connection.

 **Note:**

You can use ping/traceroute to test both numeric IP address or domain name. If pinging/tracerouting the IP address is successful, but pinging/tracerouting the domain name is not, you might have a name resolution problem. In this case, ensure that the domain name you are specifying can be resolved by using Domain Name System (DNS) queries.

IP Address/Domain Name - Type the destination IP address (such as 202.108.22.5) or Domain name (such as <http://www.tp-link.com>)

- **Pings Count** - The number of Ping packets for a Ping connection.
- **Ping Packet Size** - The size of Ping packet.
- **Ping Timeout** - Set the waiting time for the reply of each Ping packet. If there is no reply in the specified time, the connection is overtime.
- **Traceroute Max TTL** - The max number of hops for a Traceroute connection.

Click **Start** to check the connectivity of the Internet.

The **Diagnostic Results** page displays the result of diagnosis.

If the result is similar to the following screen, the connectivity of the Internet is fine.

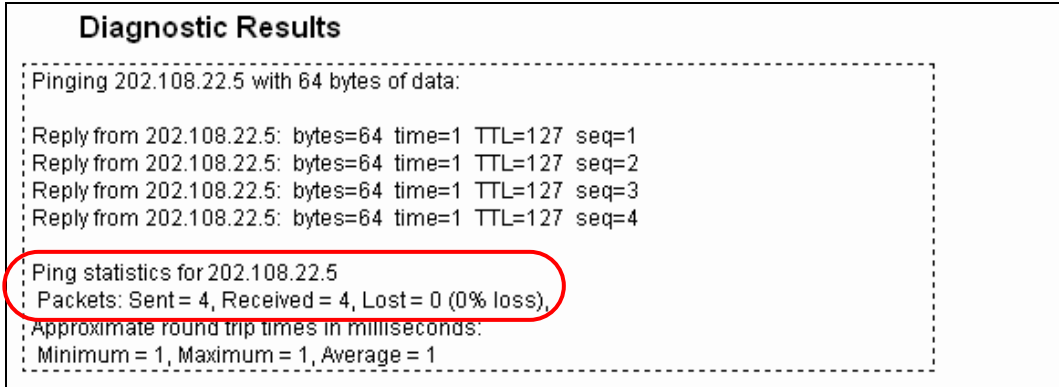

Figure 4-77 Diagnostic Results

Note:

Only one user can use this tool at one time. Options “Number of Pings”, “Ping Size” and “Ping Timeout” are used for **Ping** function. Option “Tracert Hops” are used for **Tracert** function.

4.17.3 Firmware Upgrade

Choose menu “**System Tools** → **Firmware Upgrade**”, you can update the latest version of firmware for the router on the following screen.

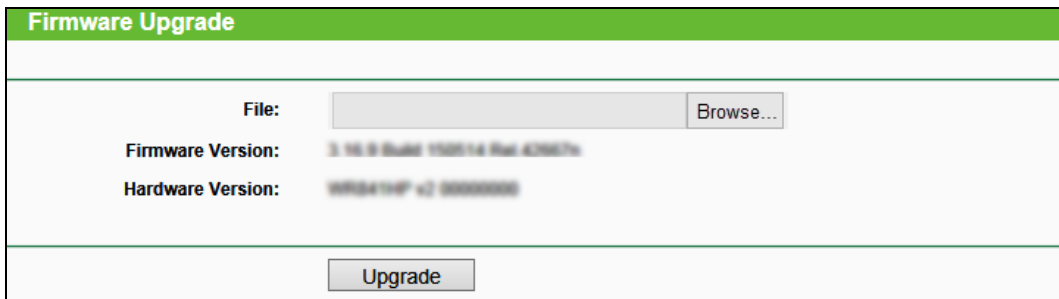

Figure 4-78 Firmware Upgrade

- **Firmware Version** - This displays the current firmware version.
- **Hardware Version** - This displays the current hardware version. The hardware version of the upgrade file must accord with the router’s current hardware version.

To upgrade the router's firmware, follow these instructions below:

1. Download a more recent firmware upgrade file from the TP-LINK website (<http://www.tp-link.com>).
2. Type the path and file name of the update file into the **File** field. Or click the **Browse** button to locate the update file.

3. Click the **Upgrade** button.

 **Note:**

1. New firmware versions are posted at <http://www.tp-link.com> and can be downloaded for free. There is no need to upgrade the firmware unless the new firmware has a new feature you want to use. However, when experiencing problems caused by the router rather than the configuration, you can try to upgrade the firmware.
2. When you upgrade the router's firmware, you may lose its current configurations, so before upgrading the firmware please write down some of your customized settings to avoid losing important settings.
3. Do not turn off the router or press the Reset button while the firmware is being upgraded, otherwise, the router may be damaged.
4. The router will reboot after the upgrading has been finished.

4.17.4 Factory Defaults

Choose menu "**System Tools** → **Factory Defaults**", and you can restore the configurations of the router to factory defaults on the following screen

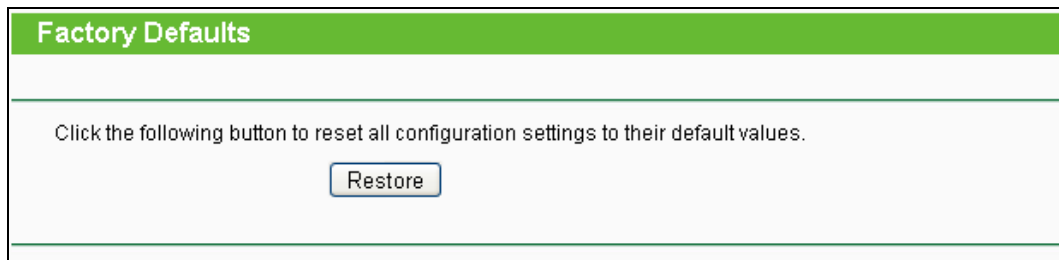

Figure 4-79 Restore Factory Default

Click the **Restore** button to reset all configuration settings to their default values.

- The default **User Name**: admin
- The default **Password**: admin
- The default **IP Address**: 192.168.0.1
- The default **Subnet Mask**: 255.255.255.0

 **Note:**

Any settings you have saved will be lost when the default settings are restored.

4.17.5 Backup & Restore

Choose menu "**System Tools** → **Backup & Restore**", you can save the current configuration of the router as a backup file and restore the configuration via a backup file as shown in Figure 4-75.

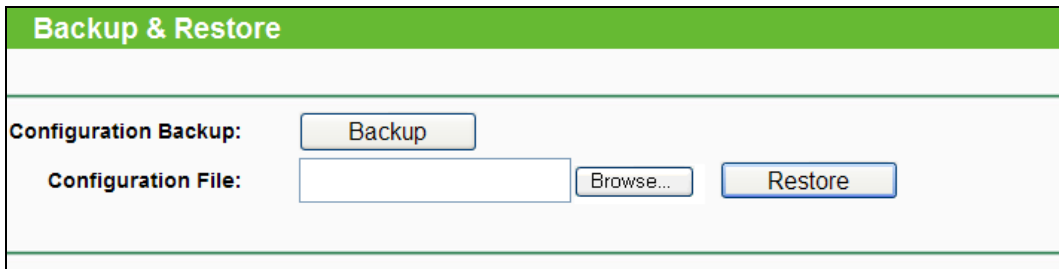

Figure 4-80 Backup & Restore Configuration

- Click the **Backup** button to save all configuration settings as a backup file in your local computer.
- To upgrade the router's configuration, follow these instructions.
 - Click the **Browse...** button to locate the update file for the router, or enter the exact path to the Setting file in the text box.
 - Click the **Restore** button.

 **Note:**

The current configuration will be covered by the uploading configuration file. The upgrade process lasts for 20 seconds and the router will restart automatically. Keep the router on during the upgrading process to prevent any damage.

4.17.6 Reboot

Choose menu "**System Tools** → **Reboot**", you can click the **Reboot** button to reboot the router via the next screen.

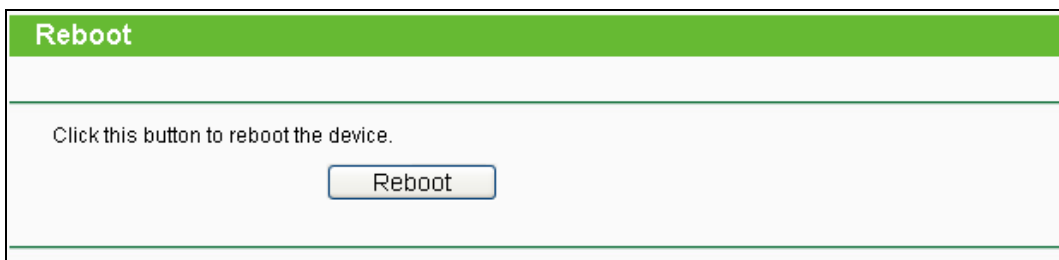

Figure 4-81 Reboot the router

Some settings of the router will take effect only after rebooting, which include

- Change the LAN IP Address (system will reboot automatically).
- Change the DHCP Settings.
- Change the Wireless configurations.
- Change the Web Management Port.
- Upgrade the firmware of the router (system will reboot automatically).
- Restore the router's settings to factory defaults (system will reboot automatically).
- Update the configuration with the file (system will reboot automatically).

4.17.7 Password

Choose menu “**System Tools** → **Password**”, you can change the factory default user name and password of the router in the next screen as shown in Figure 4-77.

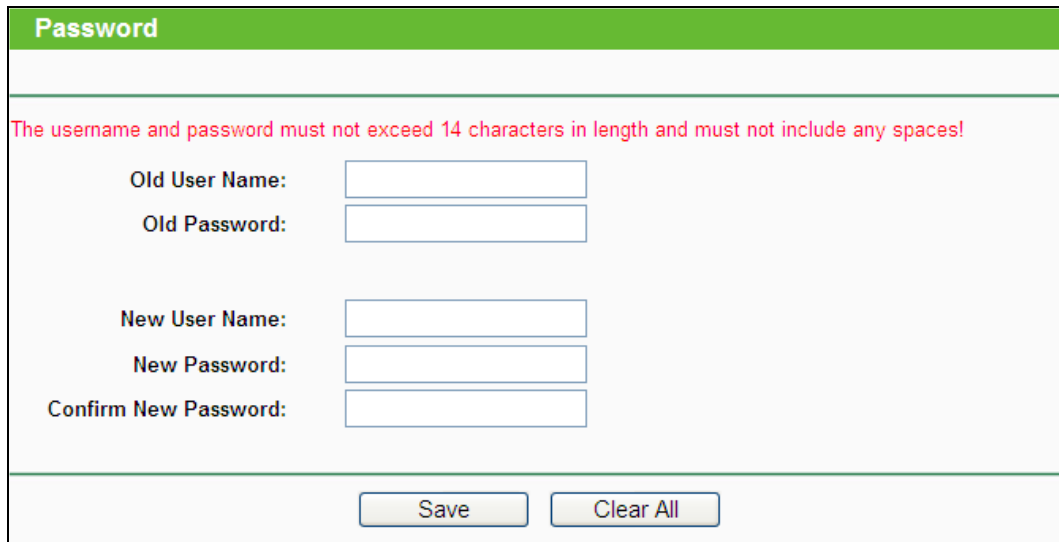

The screenshot shows a web page titled "Password" with a green header. Below the header, a red warning message states: "The username and password must not exceed 14 characters in length and must not include any spaces!". The page contains six input fields: "Old User Name:", "Old Password:", "New User Name:", "New Password:", and "Confirm New Password:". At the bottom, there are two buttons: "Save" and "Clear All".

Figure 4-82 Password

It is strongly recommended that you should change the factory default user name and password of the router, because all users who try to access the router's Web-based utility or Quick Setup will be prompted for the router's default user name and password.

 **Note:**

The new user name and password must not exceed 14 characters in length and not include any spaces. Enter the new Password twice to confirm.

Click the **Save** button when finished.

Click the **Clear All** button to clear all.

4.17.8 System Log

Choose menu “**System Tools** → **System Log**”, you can view the logs of the router.

System Log				
Auto Mail Feature: Disabled Mail Settings				
Log Type: ALL		Log Level: ALL		
Index	Time	Type	Level	Log Content
1	3rd day 21:35:02	OTHER	INFO	User clear system log.
Time = 2015-01-03 21:35:00 250502s H-Ver = <small>TL-WR841HP v2 00000000</small> : S-Ver = <small>3.16.0 Build 150114 Rel.42667a</small> L = 192.168.0.1 : M = 255.255.255.0 W1 = DHCP : W = 0.0.0.0 : M = 0.0.0.0 : G = 0.0.0.0				
<input type="button" value="Refresh"/> <input type="button" value="Save Log"/> <input type="button" value="Mail Log"/> <input type="button" value="Clear Log"/>				
<input type="button" value="Previous"/> <input type="button" value="Next"/> Current No. 1 Page				

Figure 4-83 System Log

- **Auto Mail Feature** - Indicates whether auto mail feature is enabled or not.
- **Mail Settings** - Set the receiving and sending mailbox address, server address, validation information as well as the timetable for Auto Mail Feature, as shown in Figure 4-84.

Mail Account Settings	
From:	<input type="text"/>
To:	<input type="text"/>
SMTP Server:	<input type="text"/>
<input type="checkbox"/>	Authentication
<input type="checkbox"/>	Enable Auto Mail Feature
<input checked="" type="radio"/>	Everyday, mail the log at <input type="text" value="18"/> : <input type="text" value="00"/>
<input type="radio"/>	Mail the log every <input type="text" value="48"/> hours
<input type="button" value="Save"/> <input type="button" value="Back"/>	

Figure 4-84 Mail Account Settings

- **From** - Your mail box address. The router would connect it to send logs.
- **To** - Recipient's address. The destination mailbox where the logs would be received.
- **SMTP Server** - Your smtp server. It corresponds with the mailbox filled in the From field. You can log on the relevant website for Help if you are not clear with the address.

- **Authentication** - Most SMTP Server requires Authentication. It is required by most mailboxes that need User Name and Password to log in.

 **Note:**

Only when you select **Authentication**, do you have to enter the User Name and Password in the following fields.

- **User Name** - Your mail account name filled in the From field. The part behind @ is included.
- **Password** - Your mail account password.
- **Confirm The Password** - Enter the password again to confirm.
- **Enable Auto Mail Feature** - Select it to mail logs automatically. You could mail the current logs either at a specified time everyday or by intervals, but only one could be the current effective rule. Enter the desired time or intervals in the corresponding field as shown in Figure 4-84.

Click **Save** to keep your settings.

Click **Back** to return to the previous page.

- **Log Type** - By selecting the log type, only logs of this type will be shown.
- **Log Level** - By selecting the log level, only logs of this level will be shown.
- **Refresh** - Refresh the page to show the latest log list.
- **Save Log** - Click to save all the logs in a txt file.
- **Mail Log** - Click to send an email of current logs manually according to the address and validation information set in Mail Settings.
- **Clear Log** - All the logs will be deleted from the router permanently, not just from the page.

Click the **Next** button to go to the next page, or click the **Previous** button return to the previous page.

4.17.9 Statistics

Choose menu "**System Tools** → **Statistics**", you can view the network traffic of each PC on the LAN, including total traffic and the value of the last Packets Statistic interval in seconds.

Figure 4-85 Statistics

- **Current Statistics Status** - Enable or Disable. The default value is disabled. To enable, click the **Enable** button. If disabled, the function of DoS protection in Security settings will be disabled.
- **Packets Statistics Interval (5-60)** - The default value is 10. Select a value between 5 and 60 seconds in the pull-down list. The Packets Statistic interval indicates the time section of the packets statistic.

Select the **Auto-refresh** checkbox to refresh automatically.

Click the **Refresh** button to refresh the page.

- **Sorted Rules** - Choose how displayed statistics are sorted

Click **Reset All** to reset the values of all the entries to zero.

Click **Delete All** to delete all entries in the table.

Statistics Table:

IP/MAC Address		The IP and MAC address are displayed with related statistics.
Total	Packets	The total number of packets received and transmitted by the Router.
	Bytes	The total number of bytes received and transmitted by the Router.
Current	Packets	The total number of packets received and transmitted in the last Packets Statistic interval seconds.
	Bytes	The total number of bytes received and transmitted in the last Packets Statistic interval seconds.
	ICMP Tx	The number of the ICMP packets transmitted to WAN per second at the specified Packets Statistics interval. It is shown like "current transmitting rate / Max transmitting rate".

	UDP Tx	The number of UDP packets transmitted to the WAN per second at the specified Packets Statistics interval. It is shown like "current transmitting rate / Max transmitting rate".
	TCP SYN Tx	The number of TCP SYN packets transmitted to the WAN per second at the specified Packets Statistics interval. It is shown like "current transmitting rate / Max transmitting rate".
Modify	Reset	Reset the value of the entry to zero.
	Delete	Delete the existing entry in the table.

There would be 5 entries on each page. Click **Previous** to return to the previous page and **Next** to the next page.

4.18 Logout



Figure 4-86 The Logout menu

Choose menu "**Logout**", and you will log out the web manage page of the router.

Appendix A: FAQ

1. How do I configure the router to access Internet by ADSL users?

- 1) First, configure the ADSL Modem configured in RFC1483 bridge model.
- 2) Connect the Ethernet cable from your ADSL Modem to the WAN port on the router. The telephone cord plugs into the Line port of the ADSL Modem.
- 3) Login to the router, click the "Network" menu on the left of your browser, and click "WAN" submenu. On the WAN page, select "PPPoE" for WAN Connection Type. Type user name in the "User Name" field and password in the "Password" field, finish by clicking "Connect".

The screenshot shows the WAN Connection Type configuration interface. At the top, 'WAN Connection Type:' is set to 'PPPoE/Russia PPPoE' with a dropdown arrow and a 'Detect' button. Below this, the 'PPPoE Connection:' section contains three input fields: 'User Name:', 'Password:', and 'Confirm Password:'.

Figure A-1 PPPoE Connection Type

- 4) If your ADSL lease is in "pay-according-time" mode, select "Connect on Demand" or "Connect Manually" for Internet connection mode. Type an appropriate number for "Max Idle Time" to avoid wasting paid time. Otherwise, you can select "Auto-connecting" for Internet connection mode.

The screenshot shows the 'Wan Connection Mode:' configuration page. The 'Connect on Demand' radio button is selected. Below it, 'Max Idle Time:' is set to '15' minutes. Other options include 'Connect Automatically', 'Time-based Connecting' (with a period of time from 0:00 to 23:59), and 'Connect Manually' (with a 'Max Idle Time:' of 15 minutes). At the bottom, there are 'Connect', 'Disconnect', and 'Disconnected!' buttons.

Figure A-2 PPPoE Connection Mode

Note:

1. Sometimes the connection cannot be disconnected although you specify a time to Max Idle Time, since some applications is visiting the Internet continually in the background.
2. If you are a Cable user, please configure the router following the above steps.

2. How do I configure the router to access Internet by Ethernet users?

- 1) Login to the router, click the "Network" menu on the left of your browser, and click "WAN" submenu. On the WAN page, select "Dynamic IP" for "WAN Connection Type", finish by clicking "Save".
- 2) Some ISPs require that you register the MAC Address of your adapter, which is connected to your cable/DSL Modem during installation. If your ISP requires MAC register, login to the router and click the "Network" menu link on the left of your browser, and then click "MAC Clone" submenu link. On the "MAC Clone" page, if your PC's MAC address is proper MAC address, click the "Clone MAC Address" button and your PC's MAC address will fill in the "WAN MAC Address" field. Or else, type the MAC Address into the "WAN MAC Address" field. The format for the MAC Address is XX-XX-XX-XX-XX-XX. Then click the "Save" button. It will take effect after rebooting.

Figure A-3 MAC Clone

3. I want to use Netmeeting, what do I need to do?

- 1) If you start Netmeeting as a host, you don't need to do anything with the router.
- 2) If you start as a response, you need to configure Virtual Server or DMZ Host and make sure the H323 ALG is enabled.
- 3) How to configure Virtual Server: Log in to the router, click the "**Forwarding**" menu on the left of your browser, and click "**Virtual Servers**" submenu. On the "**Virtual Servers**" page, click **Add New....** Then on the "**Add or Modify a Virtual Server Entry**" page, enter "11130" for the "Service Port" blank, and your IP address for the "IP Address" blank, taking 192.168.0.198 for an example, remember to **Enable** and **Save**.

ID	Service Port	Internal Port	IP Address	Protocol	Status	Modify
1	11130	11120	192.168.0.198	ALL	Enabled	Modify , Delete

Figure A-4 Virtual Servers

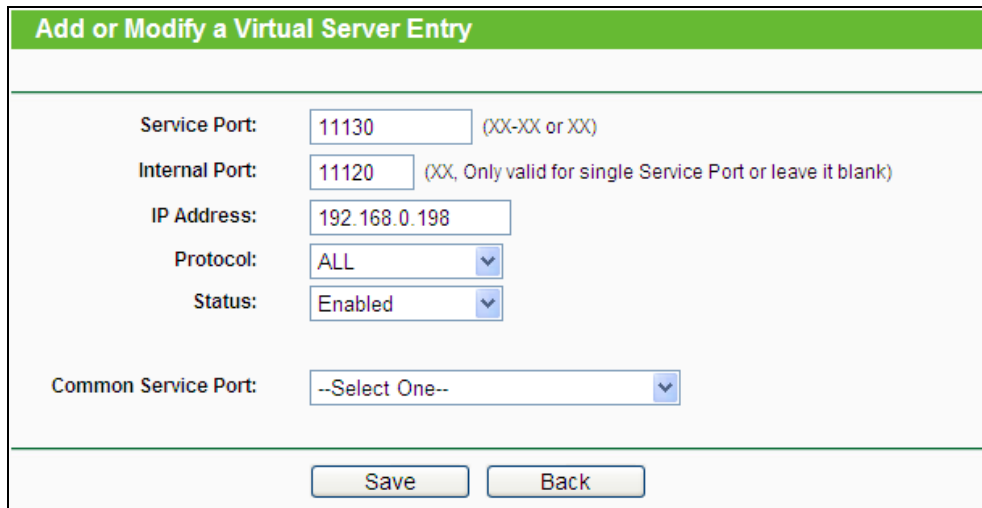

Add or Modify a Virtual Server Entry	
Service Port:	<input type="text" value="11130"/> (XX-XX or XX)
Internal Port:	<input type="text" value="11120"/> (XX, Only valid for single Service Port or leave it blank)
IP Address:	<input type="text" value="192.168.0.198"/>
Protocol:	<input type="text" value="ALL"/>
Status:	<input type="text" value="Enabled"/>
Common Service Port:	<input type="text" value="--Select One--"/>
<input type="button" value="Save"/> <input type="button" value="Back"/>	

Figure A-5 Add or Modify a Virtual server Entry

Note:

Your opposite side should call your WAN IP, which is displayed on the “**Status**” page.

- 4) How to enable DMZ Host: Log in to the router, click the “**Forwarding**” menu on the left of your browser, and click “**DMZ**” submenu. On the “DMZ” page, click **Enable** radio button and type your IP address into the “DMZ Host IP Address” field, using 192.168.0.198 as an example, remember to click the **Save** button.

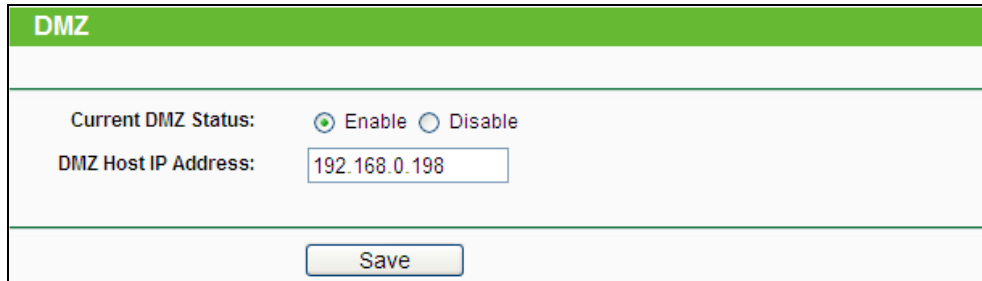

DMZ	
Current DMZ Status:	<input checked="" type="radio"/> Enable <input type="radio"/> Disable
DMZ Host IP Address:	<input type="text" value="192.168.0.198"/>
<input type="button" value="Save"/>	

Figure A-6 DMZ

- 5) How to enable H323 ALG: Log in to the router, click the “**Security**” menu on the left of your browser, and click “**Basic Security**” submenu. On the “**Basic Security**” page, check the **Enable** radio button next to **H323 ALG**. Remember to click the **Save** button.

Basic Security	
Firewall	
SPI Firewall:	<input checked="" type="radio"/> Enable <input type="radio"/> Disable
VPN	
PPTP Passthrough:	<input checked="" type="radio"/> Enable <input type="radio"/> Disable
L2TP Passthrough:	<input checked="" type="radio"/> Enable <input type="radio"/> Disable
IPSec Passthrough:	<input checked="" type="radio"/> Enable <input type="radio"/> Disable
ALG	
FTP ALG:	<input checked="" type="radio"/> Enable <input type="radio"/> Disable
TFTP ALG:	<input checked="" type="radio"/> Enable <input type="radio"/> Disable
H323 ALG:	<input checked="" type="radio"/> Enable <input type="radio"/> Disable
RTSP ALG:	<input checked="" type="radio"/> Enable <input type="radio"/> Disable
<input type="button" value="Save"/>	

Figure A-7 Basic Security

4. I want to build a WEB Server on the LAN, what should I do?

- 1) Because the WEB Server port 80 will interfere with the WEB management port 80 on the router, you must change the WEB management port number to avoid interference.
- 2) To change the WEB management port number: Log in to the router, click the "Security" menu on the left of your browser, and click "Remote Management" submenu. On the "Remote Management" page, type a port number except 80, such as 88, into the "Web Management Port" field. Click **Save** and reboot the router.

Remote Management	
Web Management Port:	<input type="text" value="88"/>
Remote Management IP Address:	<input type="text" value="0.0.0.0"/> (Enter 255.255.255.255 for all)
<input type="button" value="Save"/>	

Figure A-8 Remote Management

Note:

If the above configuration takes effect, to configure to the router by typing <http://192.168.0.1:88> (the router's LAN IP address: Web Management Port) in the address field of the Web browser.

- 3) Log in to the router, click the **"Forwarding"** menu on the left of your browser, and click the **"Virtual Servers"** submenu. On the **"Virtual Servers"** page, click **Add New...**, then on the **"Add or Modify a Virtual Server"** page, enter **"80"** into the blank next to the **"Service Port"**, and your IP address next to the **"IP Address"**, assuming 192.168.0.188 for an example, remember to **Enable** and **Save**.

Virtual Servers						
ID	Service Port	Internal Port	IP Address	Protocol	Status	Modify
1	80	21	192.168.0.188	ALL	Enabled	Modify Delete

Figure A-9 Virtual Servers

Add or Modify a Virtual Server Entry	
Service Port:	<input type="text" value="80"/> (XX-XX or XX)
Internal Port:	<input type="text" value="21"/> (XX, Only valid for single Service Port or leave it blank)
IP Address:	<input type="text" value="192.168.0.188"/>
Protocol:	<input type="text" value="ALL"/>
Status:	<input type="text" value="Enabled"/>
Common Service Port:	<input type="text" value="--Select One--"/>

Figure A-10 Add or Modify a Virtual server Entry

5. The wireless stations cannot connect to the router.

- 1) Make sure the **"Wireless Router Radio"** is enabled.
- 2) Make sure that the wireless stations' SSID accord with the router's SSID.
- 3) Make sure the wireless stations have right KEY for encryption when the router is encrypted.
- 4) If the wireless connection is ready, but you can't access the router, check the IP Address of your wireless stations.

Appendix B: Configuring the PC

In this section, we'll introduce how to install and configure the TCP/IP correctly in Windows 7. First make sure your Ethernet Adapter is working, refer to the adapter's manual if needed.

1. Install TCP/IP component

- 1) On the Windows taskbar, click the **Start** button, and then click **Control Panel**.
- 2) Click the **Network and Internet**, and click the **Network and Sharing Center**, then click **Change adapter settings**.
- 3) Right click the icon that showed below, select **Properties** on the prompt page.

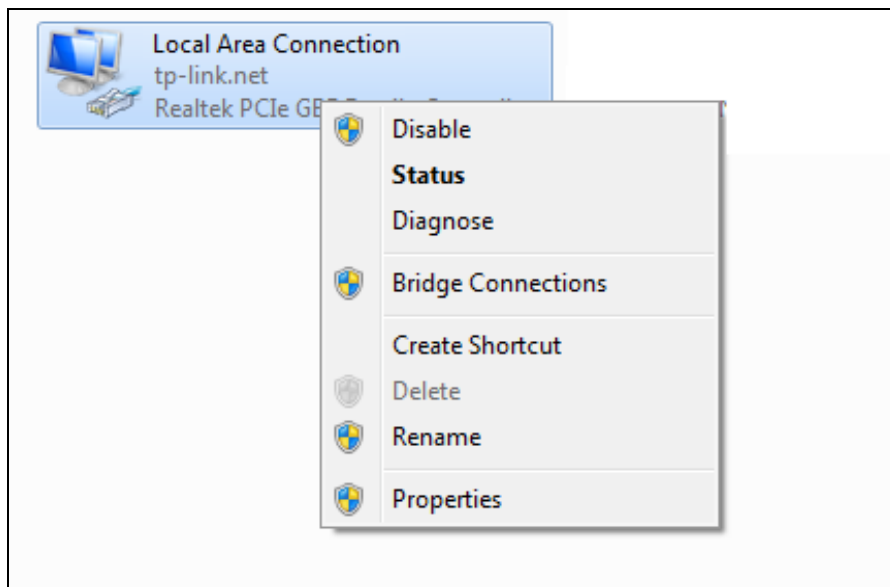

Figure B-1

- 4) In the prompt page that showed below, double click on the **Internet Protocol Version 4 (TCP/IPv4)**.

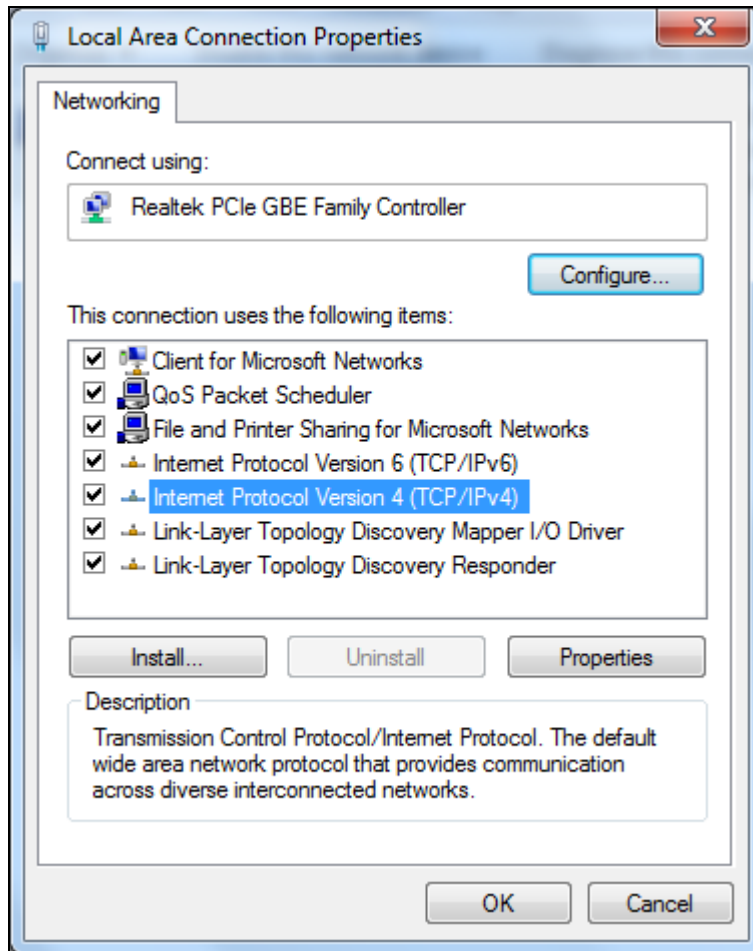

Figure B-2

- 5) The following **TCP/IP Properties** window will display and the **IP Address** tab is open on this window by default.

Now you have two ways to configure the **TCP/IP** protocol below:

➤ **Setting IP address automatically**

Select **Obtain an IP address automatically**, Choose **Obtain DNS server automatically**, as shown in the Figure below:

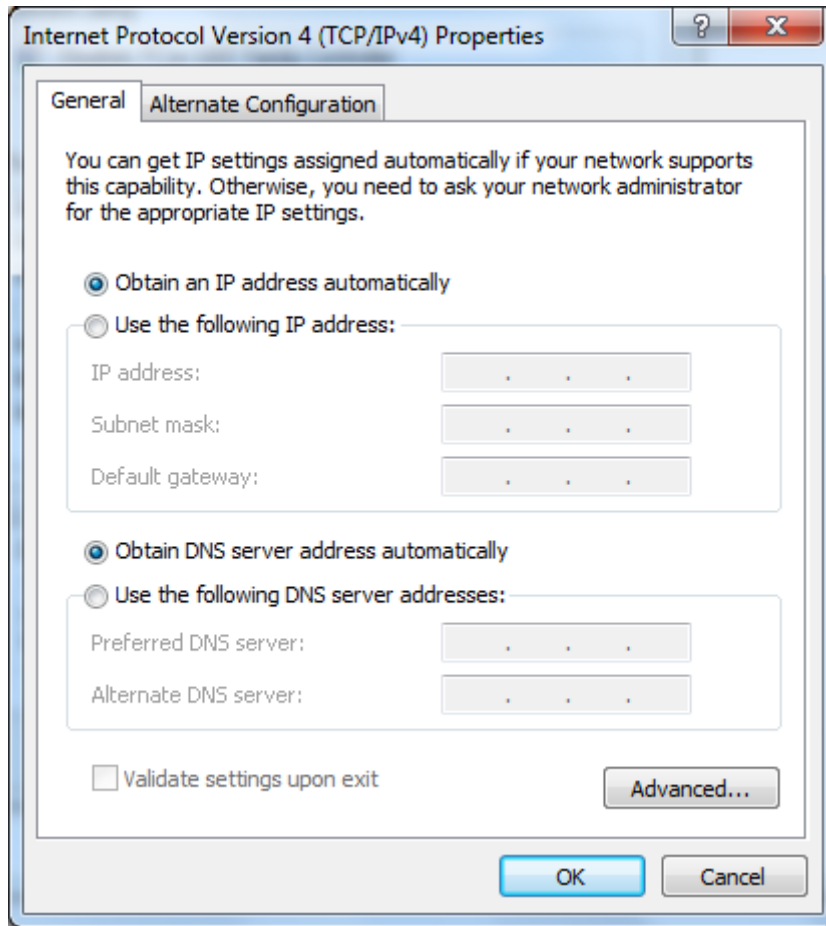

Figure B-3

➤ **Setting IP address manually**

- 1 Select **Use the following IP address** radio button. And the following items available
- 2 If the router's LAN IP address is 192.168.0.1, specify the IP address as 192.168.0.x (x is from 2 to 254), and **Subnet mask** is 255.255.255.0.
- 3 Type the router's LAN IP address (the default IP is 192.168.0.1) into the **Default gateway** field.
- 4 Select **Use the following DNS server addresses** radio button. In the **Preferred DNS Server** field you can type the DNS server IP address, which has been provided by your ISP

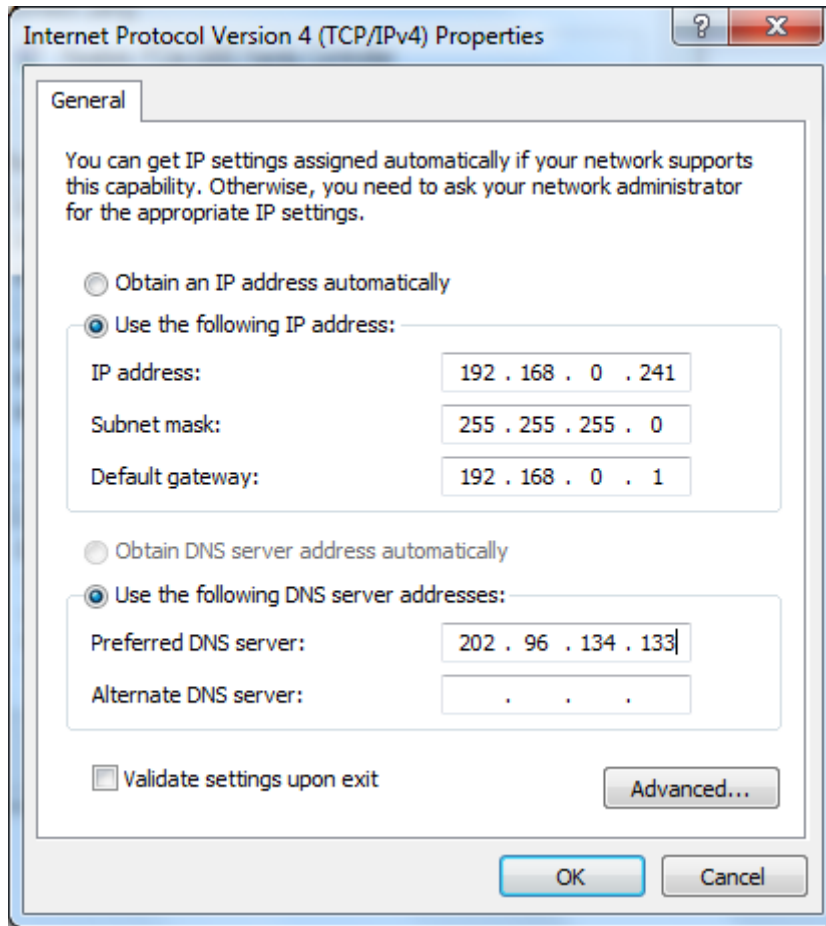

Figure B-4

Appendix C: Specifications

General	
Standards	IEEE 802.11g、IEEE 802.11b、IEEE 802.11n、IEEE 802.3、IEEE 802.3u、IEEE 802.3x、IEEE 802.1X、IEEE 802.11e、IEEE 802.11i
Protocols	TCP/IP, PPPoE, DHCP, ICMP, NAT, SNTP
Ports	One 10/100M Auto-Negotiation WAN RJ45 port, Four 10/100M Auto-Negotiation LAN RJ45 ports supporting Auto MDI/MDIX
Cabling Type	10BASE-T: UTP category 3, 4, 5 cable (maximum 100m) EIA/TIA-568 100Ω STP (maximum 100m)
	100BASE-TX: UTP category 5, 5e cable (maximum 100m) EIA/TIA-568 100Ω STP (maximum 100m)
LEDs	PWR, SYS, WLAN, LAN (1-4), WAN, WPS
Safety & Emissions	FCC
Wireless	
Frequency Band	2.4~2.4835GHz
Radio Data Rate	11n: up to 300Mbps (Automatic) 11g: 54/48/36/24/18/12/9/6M (Automatic) 11b: 11/5.5/2/1M (Automatic)
Frequency Expansion	DSSS (Direct Sequence Spread Spectrum)
Modulation	BPSK, QPSK, CCK, OFDM, 16-QAM, 64-QAM
Security	WEP/WPA/WPA2/WPA2-PSK/WPA-PSK
Sensitivity @PER	270M: -68dBm@10% PER 130M: -68dBm@10% PER 108M: -68dBm@10% PER 54M: -68dBm@10% PER 11M: -85dBm@8% PER 6M: -88dBm@10% PER 1M: -90dBm@8% PER
Antenna Gain	9dBi * 2
Environmental and Physical	
Temperature	Operating : 0°C~40°C (32°F~104°F)
	Storage: -40°C~70°C(-40°F~158°F)
Humidity	Operating: 10% - 90% RH, Non-condensing
	Storage: 5% - 90% RH, Non-condensing

Appendix D: Glossary

- **802.11n** - 802.11n builds upon previous 802.11 standards by adding MIMO (multiple-input multiple-output). MIMO uses multiple transmitter and receiver antennas to allow for increased data throughput via spatial multiplexing and increased range by exploiting the spatial diversity, perhaps through coding schemes like Alamouti coding. The Enhanced Wireless Consortium (EWC) [3] was formed to help accelerate the IEEE 802.11n development process and promote a technology specification for interoperability of next-generation wireless local area networking (WLAN) products.
- **802.11b** - The 802.11b standard specifies a wireless networking at 11 Mbps using direct-sequence spread-spectrum (DSSS) technology and operating in the unlicensed radio spectrum at 2.4GHz, and WEP encryption for security. 802.11b networks are also referred to as Wi-Fi networks.
- **802.11g** - specification for wireless networking at 54 Mbps using direct-sequence spread-spectrum (DSSS) technology, using OFDM modulation and operating in the unlicensed radio spectrum at 2.4GHz, and backward compatibility with IEEE 802.11b devices, and WEP encryption for security.
- **DDNS (Dynamic Domain Name System)** - The capability of assigning a fixed host and domain name to a dynamic Internet IP Address.
- **DHCP (Dynamic Host Configuration Protocol)** - A protocol that automatically configure the TCP/IP parameters for the all the PC(s) that are connected to a DHCP server.
- **DMZ (Demilitarized Zone)** - A Demilitarized Zone allows one local host to be exposed to the Internet for a special-purpose service such as Internet gaming or videoconferencing.
- **DNS (Domain Name System)** - An Internet Service that translates the names of websites into IP addresses.
- **Domain Name** - A descriptive name for an address or group of addresses on the Internet.
- **DSL (Digital Subscriber Line)** - A technology that allows data to be sent or received over existing traditional phone lines.
- **ISP (Internet Service Provider)** - A company that provides access to the Internet.
- **MTU (Maximum Transmission Unit)** - The size in bytes of the largest packet that can be transmitted.
- **NAT (Network Address Translation)** - NAT technology translates IP addresses of a local area network to a different IP address for the Internet.
- **PPPoE (Point to Point Protocol over Ethernet)** - PPPoE is a protocol for connecting remote hosts to the Internet over an always-on connection by simulating a dial-up connection.

- **SSID** - A **S**ervice **S**et **I**dentification is a thirty-two character (maximum) alphanumeric key identifying a wireless local area network. For the wireless devices in a network to communicate with each other, all devices must be configured with the same SSID. This is typically the configuration parameter for a wireless PC card. It corresponds to the ESSID in the wireless Access Point and to the wireless network name.
- **WEP (Wired Equivalent Privacy)** - A data privacy mechanism based on a 64-bit or 128-bit or 152-bit shared key algorithm, as described in the IEEE 802.11 standard.
- **Wi-Fi** - A trade name for the 802.11b wireless networking standard, given by the Wireless Ethernet Compatibility Alliance (WECA, see <http://www.wi-fi.net>), an industry standards group promoting interoperability among 802.11b devices.
- **WLAN (Wireless Local Area Network)** - A group of computers and associated devices communicate with each other wirelessly, which network serving users are limited in a local area.