



User's Guide

TEW-635BRM
H/W: V 1

Table of Contents

CHAPTER 1 INTRODUCTION	1
Wireless ADSL Modem Router Features.....	1
Package Contents	5
Physical Details.....	6
CHAPTER 2 INSTALLATION.....	8
Requirements.....	8
Procedure.....	8
CHAPTER 3 SETUP	10
Overview	10
Configuration Program	12
Setup Wizard	13
Configuring VCs.....	20
Main Screen	23
LAN Screen.....	24
Wireless Screen.....	26
Wireless Security	29
Trusted Wireless Stations	33
Password Screen.....	35
Mode Screen.....	37
Status	38
Connection Status - PPPoE & PPPoA	41
Connection Details - Dynamic IP Address	42
Connection Details - Fixed IP Address.....	43
Binding Function	44
CHAPTER 4 COMPUTER CONFIGURATION	45
Overview	45
Windows Clients.....	45
Macintosh Clients.....	57
Linux Clients.....	57
Other Unix Systems.....	57
Wireless Station Configuration.....	58
Wireless Configuration on Windows XP.....	58
CHAPTER 5 ADVANCED FEATURES	69
Overview	69
Internet.....	69
Dynamic DNS (Domain Name Server)	73
Options	75
Schedule.....	76
Port Trigger	77
Port Forward	79
Port Range Forward	80
QoS	81
CHAPTER 6 ADVANCED ADMINISTRATION	83
Overview	83
PC Database.....	84
Config File.....	85
Logs.....	86

E-mail	88
Diagnostics	90
Remote Administration.....	91
Routing	93
Upgrade Firmware	97
CHAPTER 7 MODEM MODE.....	98
Overview	98
Management Connections	98
Modem Mode Main Screen	99
Operation	103
APPENDIX A TROUBLESHOOTING	104
Overview	104
General Problems	104
Internet Access.....	104
Wireless Access	105
APPENDIX B ABOUT WIRELESS LANS.....	107
Modes	107
BSS/ESS.....	107
Channels.....	108
WEP	108
WPA-PSK	108
WPA2-PSK	109
WPA-802.1x	109
Wireless LAN Configuration.....	109
APPENDIX C SPECIFICATIONS	110
Multi-Function Wireless ADSL Modem Router	110
Wireless Interface.....	110
Regulatory Approvals	113

Chapter 1

Introduction

1

This Chapter provides an overview of the Wireless ADSL Modem Router's features and capabilities.

Congratulations on the purchase of your new Wireless ADSL Modem Router. The Wireless ADSL Modem Router is a multi-function device providing the following services:

- **ADSL Modem.**
- **Shared Broadband Internet Access** for all LAN users.
- **Wireless Access Point** for 802.11n, 802.11b and 802.11g Wireless Stations.
- **4-Port Switching Hub** for 10BaseT or 100BaseT connections.

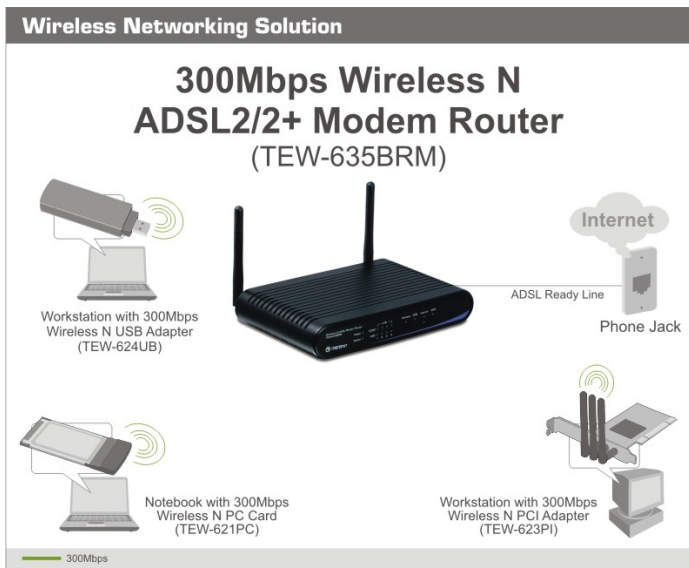

Wireless ADSL Modem Router Features

The Wireless ADSL Modem Router incorporates many advanced features, carefully designed to provide sophisticated functions while being easy to use.

Internet Access Features

- **Shared Internet Access.** All users on the LAN or WLAN can access the Internet through the Wireless ADSL Modem Router, using only a single external IP Address. The local (invalid) IP Addresses are hidden from external sources. This process is called NAT (Network Address Translation).
- **Built-in ADSL Modem.** The Wireless ADSL Modem Router has a built-in ADSL modem, supporting all common ADSL connections.

-
- ***IPoA, PPPoE, PPPoA, Direct Connection Support.*** The Wireless ADSL Modem Router supports all common connection methods.
 - ***Auto-detection of Internet Connection Method.*** In most situations, the Wireless ADSL Modem Router can test your ADSL and Internet connection to determine the connection method used by your ISP.
 - ***Static or Dynamic IP Address.*** On the Internet (ADSL port) connection, the Wireless ADSL Modem Router supports both Dynamic IP Address (IP Address is allocated on connection) and Static (Fixed) IP Address.

Advanced Internet Functions

- ***Application Level Gateways (ALGs).*** Applications which use non-standard connections or port numbers are normally blocked by the Firewall. The ability to define and allow such applications is provided, to enable such applications to be used normally.
- ***Port Triggering.*** This feature, also called Special Applications, allows you to use Internet applications which normally do not function when used behind a firewall.
- ***Port Forwarding.*** This feature allows Internet users to access Internet servers on your LAN. The required setup is quick and easy.
- ***Dynamic DNS Support.*** DDNS, when used with the Virtual Servers feature, allows users to connect to Servers on your LAN using a Domain Name, even if you have a dynamic IP address which changes every time you connect.
- ***URL Filter.*** Use the URL Filter to block access to undesirable Web sites by LAN users.
- ***Scheduling.*** Both the URL Filter and Firewall rules can be scheduled to operate only at certain times. This provides great flexibility in controlling Internet-bound traffic.
- ***Logs.*** Define what data is recorded in the Logs, and optionally send log data to a Syslog Server. Log data can also be E-mailed to you.
- ***VPN Pass through Support.*** PCs with VPN (Virtual Private Networking) software using PPTP, L2TP and IPSec are transparently supported - no configuration is required.
- ***Multi-PVC Support.*** A permanent virtual circuit (PVC) can provide a continuous connection between two or more points when needed without having to reserve a specific physical path in advance. In this way, many companies can share a common pool of circuits. (Please note: auto-detect connection setup in Setup Wizard does not support Multi-PCV. If you would like to enable the Multi-PVC feature, please use manual connection method instead.)

Wireless Features

- ***Standards Compliant.*** The Wireless ADSL Modem Router complies with the IEEE802.11g (DSSS) specifications for Wireless LANs.
- ***Supports Pre-N Wireless Stations.*** The 802.11n Draft standard provides for backward compatibility with the 802.11b standard, so 802.11n, 802.11b and 802.11g Wireless stations can be used simultaneously.
- ***WEP support.*** Support for WEP (Wired Equivalent Privacy) is included. Key sizes of 64 Bit and 128 Bit are supported. WEP encrypts any data before transmission, providing protection against snoopers.

- **WPA-PSK support.** Like WEP, WPA-PSK encrypts any data before transmission, providing protection against snoopers. The WPA-PSK is a later standard than WEP, and provides both easier configuration and greater security than WEP.
- **WPA2-PSK support.** Support for WPA2 is also included. WPA2 uses the extremely secure AES encryption method.
- **802.1x Support.** Support for 802.1x mode is included, providing for the industrial-strength wireless security of 802.1x authentication and authorization.
- **Wireless MAC Access Control.** The Wireless Access Control feature can check the MAC address (hardware address) of Wireless stations to ensure that only trusted Wireless Stations can access your LAN.
- **Simple Configuration.** If the default settings are unsuitable, they can be changed quickly and easily.
- **WPS Support.** WPS (Wi-Fi Protected Setup) can simplify the process of connecting any device to the wireless network by using the Push Button Configuration (PBC) on the Wireless Access Point, or entering a PIN code if there's no button.
- **WDS Support.** Support for WDS (Wireless Distribution System) allows the Wireless Access Point to act as a Wireless Bridge. Both Point-to-Point and Multi-Point Bridge modes are supported.

LAN Features

- **4-Port Switching Hub.** The Wireless ADSL Modem Router incorporates a 4-port 10/100BaseT switching hub, making it easy to create or extend your LAN.
- **DHCP Server Support.** Dynamic Host Configuration Protocol provides a dynamic IP address to PCs and other devices upon request. The Wireless ADSL Modem Router can act as a **DHCP Server** for your local LAN and WLAN devices.

Configuration & Management

- **Easy Setup.** Use your WEB browser from anywhere on the LAN or WLAN for configuration.
- **Configuration File Upload/Download.** Save (download) the configuration data from the Wireless ADSL Modem Router to your computer, and restore (upload) a previously-saved configuration file to the Wireless ADSL Modem Router.
- **Remote Management.** The Wireless ADSL Modem Router can be managed from any PC on your LAN or Wireless LAN. And, if the Internet connection exists, it can also (optionally) be configured via the Internet.
- **Network Diagnostics.** You can use the Wireless ADSL Modem Router to perform a *Ping* or *DNS lookup*.

Security Features

- **Password - protected Configuration.** Password protection is provided to prevent unauthorized users from modifying the configuration data and settings.
- **Wireless LAN Security.** WPA-802.1x, WPA2-802.1x and WEP and Wireless access control by MAC address are all supported. The MAC-level access control feature can be used to prevent unknown wireless stations from accessing your LAN.

-
- ***NAT Protection.*** An intrinsic side effect of NAT (Network Address Translation) technology is that by allowing all LAN users to share a single IP address, the location and even the existence of each computer is hidden. From the external viewpoint, there is no network, only a single device - the Wireless ADSL Modem Router.
 - ***Firewall.*** All incoming data packets are monitored and all incoming server requests are filtered, thus protecting your network from malicious attacks from external sources.
 - ***Protection against DoS attacks.*** DoS (Denial of Service) attacks can flood your Internet connection with invalid packets and connection requests, using so much bandwidth and so many resources that Internet access becomes unavailable. The Wireless ADSL Modem Router incorporates protection against DoS attacks.

Package Contents

The following items should be included. If any of these items are damaged or missing, please contact your dealer immediately.

- TEW-635BRM
- Multi-Language Quick Installation Guide
- CD-ROM (User's Guide)
- 1 x RJ-45 Ethernet Cable
- 1 x RJ-11 Telephone Cable
- 1 x External Power Adapter (12VDC, 1A)

Physical Details

Front-mounted LEDs



Power LED	On (Green) - Power on. Off - No power. Flashing (Green) - Device is rebooting.
Status	On (Orange) - Device error.
LAN	For each port, there are 2 LEDs. One is 100BaseT, another is 10BaseT. <ul style="list-style-type: none">• On (Green) - Corresponding LAN (hub) port is using 100BaseT.• On (Orange) - Corresponding LAN (hub) port is using 10BaseT.• Off - No active connection on the corresponding LAN (hub) port.• Flashing - Data is being transmitted or received via the corresponding LAN (hub) port.
Wireless	On - Wireless enabled. Off - No Wireless connections currently exist. Flashing - Data is being transmitted or received via the Wireless connection. This includes "network traffic" as well as user's data.
ADSL	On - ADSL connection established. Off - No ADSL connection existing. Flashing - ADSL is synchronizing.
Internet	On (Green) - Internet connection is available. Off - No Internet connection available. On (Orange) - Authentication error.
WPS	On - WPS wireless security is enabled. Off - WPS is disable Flashing - The device is in the 2-minute interval to synchronize security.

Rear Panel



ADSL port	Connects ADSL line here
LAN 1~4	10/100Mbps LAN port.
Power ON/OFF	Press this button to power on/off the device
Power port	Power adapter port
WPS Button	Push the WPS button to enable the WPS function. On your other wireless device, push the WPS (if available) or type the pin code to establish the secured wireless encryption connection automatically.
Wireless ON/OFF	Press this button to switch wireless function on or off.

To restore the factory default settings

Press the **Wireless** and **WPS** buttons simultaneously for 8 seconds and release them. Wait the Wireless ADSL Modem Router to restart. The ADSL router should restore the factory default value.

Chapter 2

Installation

2

This Chapter covers the physical installation of the Wireless ADSL Modem Router.

Requirements

- Network cables. Use standard 10/100BaseT network (UTP) cables with RJ-45 connectors.
- TCP/IP protocol must be installed on all PCs.
- For Internet Access, an Internet Access account with an ISP, and a DSL connection.
- To use the Wireless Access Point, all Wireless devices must be compliant with the IEEE 802.11g, IEEE 802.11b or IEEE 802.11n Draft specifications.

Procedure

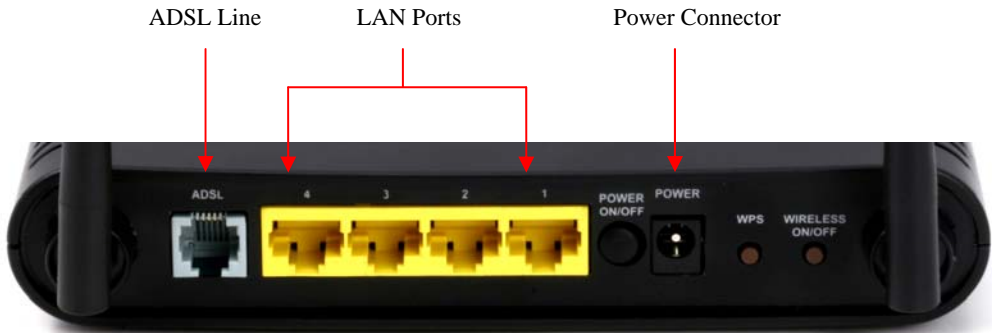

1. Choose an Installation Site

Select a suitable place on the network to install the Wireless ADSL Modem Router.



For best Wireless reception and performance, the Wireless ADSL Modem Router should be positioned in a central location with minimum obstructions between the Wireless ADSL Modem Router and the computers.

Also, if using multiple Access Points, adjacent Access Points should use different Channels.

2. Connect LAN Cables

Use standard LAN cables to connect computers to the Switching Hub ports on the Wireless ADSL Modem Router. Both 10BaseT and 100BaseT connections can be used simultaneously.

3. Connect RJ-11 Telephone Cable

Connect the provided telephone cable from the ADSL port to the ADSL phone jack which provided by your ADSL phone company.

4. Power Up

Connect the provided power adapter to the power port. Only use the provided power adapter. Using a different one may cause hardware damage.

5. Check the LEDs

- The *Power* LED should be ON.
- One of the LAN port should be on if there is a computer connected.
- The *Wireless* LED should be ON
- The *ADSL* LED should be ON if ADSL line is established.
- The *Internet* (Green) LED may be OFF. After configuration, it should be ON.

For more information, refer to *Front-mounted LEDs* in Chapter 1.

Chapter 3

Setup



This Chapter provides Setup details of the Wireless ADSL Modem Router.

Overview

This chapter describes the setup procedure for:

- Internet Access
- LAN configuration
- Wireless setup
- Assigning a Password to protect the configuration data.

PCs on your local LAN may also require configuration. For details, see *Chapter 4 - Computer Configuration*.

Other configuration may also be required, depending on which features and functions of the Wireless ADSL Modem Router you wish to use. Use the table below to locate detailed instructions for the required functions.

To Do this:	Refer to:
Configure PCs on your LAN.	Chapter 4: Computer Configuration
Use any of the following Advanced features: <ul style="list-style-type: none">• Internet (DMZ, URL Filter)• Access Control• Dynamic DNS• Options• Schedule• Port Trigger• Port Forward• Port Range Forward• QoS	Chapter 5: Advanced Features

<p>Use any of the following Administration Configuration settings or features:</p> <ul style="list-style-type: none">• PC Database• Config File• Logs• E-mail• Diagnostics• Remote Admin• Routing• Upgrade Firmware	<p>Chapter 6 Advanced Administration</p>
--	--

Configuration Program

The Wireless ADSL Modem Router contains an HTTP server. This enables you to connect to it, and configure it, using your Web Browser. **Your Browser must support JavaScript.**

The configuration program has been tested on the following browsers:

- Netscape 7.1 or later.
- Mozilla 1.6 or later
- Internet Explorer V5.5 or later

Preparation

Before attempting to configure the Wireless ADSL Modem Router, please ensure that:

- Your computer can establish a physical connection to the Wireless ADSL Modem Router. The computer and the Wireless ADSL Modem Router must be directly connected (using the Hub ports on the Wireless ADSL Modem Router) or on the same LAN segment.
- The Wireless ADSL Modem Router must be installed and powered ON.
- Wireless ADSL Modem Router's default IP Address (192.168.10.1). Make sure there is no other device using the same IP address within the same network.

Using your Web Browser

To establish a connection from your computer to the Wireless ADSL Modem Router:

1. After installing the Wireless ADSL Modem Router in your LAN, start your computer. If your computer is already running, restart it.
2. Start your WEB browser.
3. In the *Address* box, enter "HTTP://" and the IP Address of the Wireless ADSL Modem Router, as in this example, which uses the Wireless ADSL Modem Router's default IP Address:

HTTP://192.168.10.1

4. When prompted for the User name and Password, enter values as follows:
 - User name admin
 - Password password

If you can't connect

If the Wireless ADSL Modem Router does not respond, check the following:

- The Wireless ADSL Modem Router is properly installed, LAN connection is OK, and it is powered ON. You can test the connection by using the "Ping" command:
- Open the MS-DOS window or command prompt window.
- Enter the command:
`ping 192.168.10.1`

If no response is received, either the connection is not working, or your computer's IP address is not compatible with the Wireless ADSL Modem Router's IP Address. (See next item.)

- If your computer is using a fixed IP Address, its IP Address must be within the range 192.168.10.2 to 192.168.10.254 to be compatible with the Wireless ADSL Modem Router's default IP Address of 192.168.10.1. Also, the *Network Mask* must be set to 255.255.255.0. See *Chapter 4 - Computer Configuration* for details on checking your computer's TCP/IP settings.
- Ensure that your computer and the Wireless ADSL Modem Router are on the same network segment. (If you don't have a router, this must be the case.)
- Ensure you are using the wired LAN interface. The Wireless interface can only be used if its configuration matches your PC's wireless settings.

Setup Wizard

The common connection types are explained in the following table.

Connection Type	Details	ISP Data required
Dynamic IP Address	Your IP Address is allocated automatically, when you connect to you ISP.	Often, none. Some ISP's may require you to use a particular <i>Hostname</i> or <i>Domain</i> name, or MAC (physical) address.
Static (Fixed) IP Address	Your ISP allocates a permanent IP Address to you. Usually, the connection is "Always on".	IP Address allocated to you, and related information, such as Network Mask, Gateway IP address, and DNS address.
PPPoE, PPPoA	You connect to the ISP only when required. The IP address is usually allocated automatically.	a) User name and password are always required. b) If using a Static (Fixed) IP address, you need the IP address and related information (Network Mask, Gateway IP address, and DNS address)

IPoA (IP over ATM)	Normally, the connection is "Always on".	IP Address allocated to you, and related information, such as Network Mask, Gateway IP address, and DNS address.
-----------------------	--	--

The first time you connect to the Wireless ADSL Modem Router, you should run the *Setup Wizard* to configure the ADSL and Internet Connection. There are two options. One is “**Auto-Detect**” and another is “**Manual Selection**”.

Auto-Detection

1. Click the *Setup Wizard* link on the main menu



2. On the first screen, select VC 1 (*Router - Primary Internet Connection*), then click "Next". Note: Auto-detection does not support “MultiPVC”. If you would like to enable the multi PVC feature, you must use Manual Selection to setup your ADSL line.

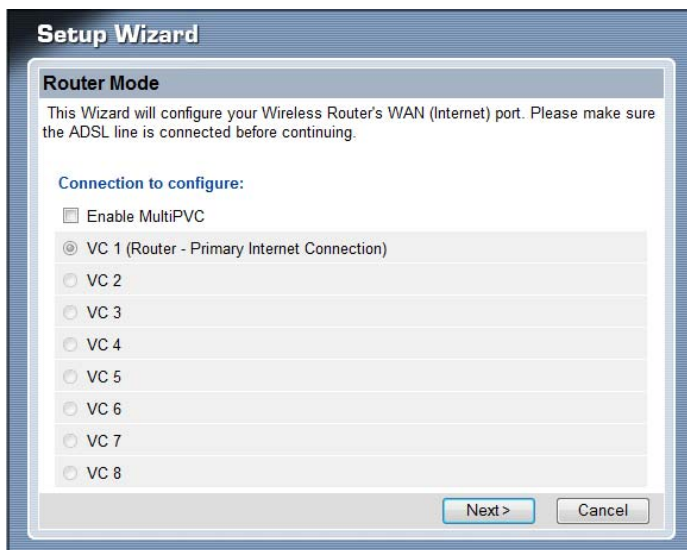

3. Select the “*Auto-detect*” connection method.

The screenshot shows the 'Setup Wizard' window with the title 'Determine Connection Method'. Below the title, it says 'Select the desired option.' and 'Select the method of determining the type of Internet connection.' There are two radio button options: 'Auto-detect' (which is selected) and 'Manual Selection'. At the bottom, there are three buttons: '< Back', 'Next >', and 'Cancel'.

4. Configure the setting based on the information your IPS provided.

The screenshot shows the 'Setup Wizard' window with the title 'Internet Access'. Below the title, it says 'Check the data provided by your ISP.' Under the 'Connection Method' section, it says 'If your ISP requires a User Name and Password for Internet Access, select "Login". Otherwise, select "No Login".' There are two radio button options: 'Login' (selected) and 'No Login'. The 'Login' option has a dropdown menu set to 'PPPoE'. The 'No Login' option has a dropdown menu set to 'Dynamic IP address (RFC1483 bridge)'. Below this, there is a 'DSL Multiplexing Method' dropdown menu set to 'LLC-BASED'. At the bottom, there are three buttons: '< Back', 'Next', and 'Cancel'.

5. Type in the username & password if applicable

The screenshot shows the 'Setup Wizard' window with the title 'PPPoE'. Below the title, it says 'Check the data supplied by your ISP.' There are several fields and options: 'Login Name:' with the text 'myisp@isp.com', 'Password:' with masked characters '•••••', 'Connect Behavior:' with a dropdown menu set to 'Automatic Connect/Disconnect', 'Auto-disconnect Timeout period:' with a value of '5' and the unit 'min', 'IP Address:' with radio buttons for 'Automatic (Dynamic)' (selected), 'Fixed:' (with four empty boxes), and 'DNS:' with radio buttons for 'Automatic (obtain from Server)' (selected) and 'Fixed:' (with four empty boxes). At the bottom, there are three buttons: '< Back', 'Next >', and 'Cancel'.

6. Waiting for the Modem Router reboot.

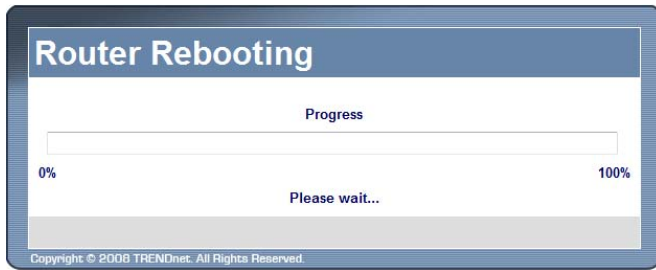

7. Click *OK*.

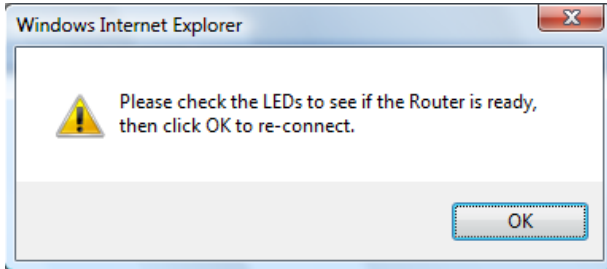

8. Click *Finish* to diagnostic the setting result

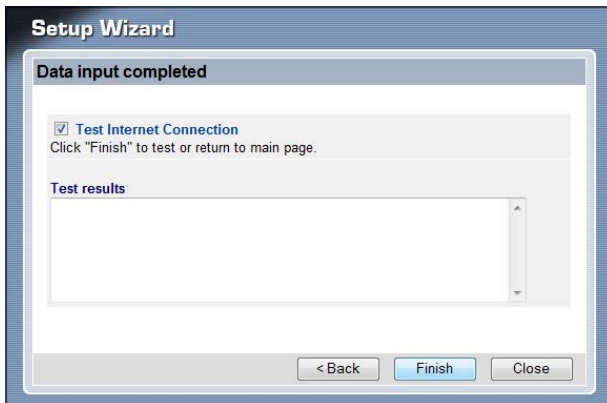

9. Click *Close* to exit the Setup Wizard



10. If the connection test fails:

- Check all connections, and the front panel LEDs.
- Check that you have entered all data correctly

Manual-Selection

1. Click the *Setup Wizard* link on the main menu



2. On the first screen, select *VC 1 (Router - Primary Internet Connection)*, then click "Next". If you would like to enable the "*Enable MultiPVC*", please select it now.

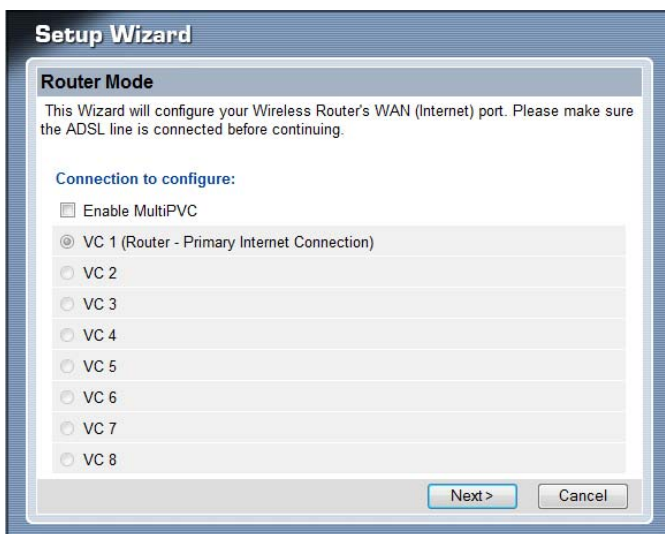

3. Select *Manual Selection*

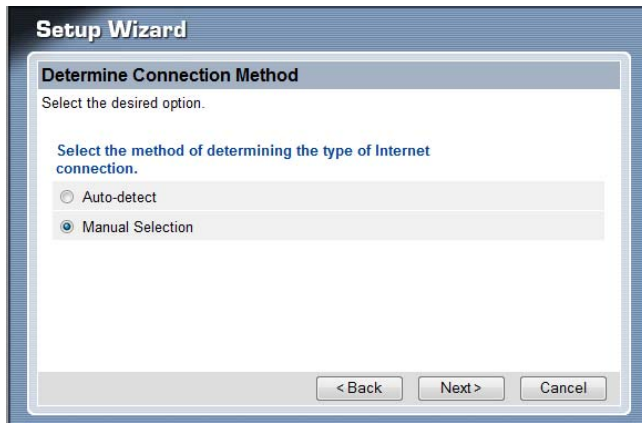

4. Type in the VPI and VCI value that provided by your ISP provider, then click "Next".

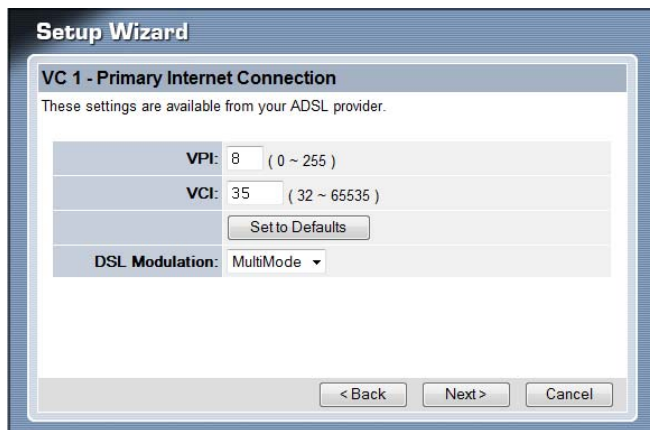

5. Configure the setting based on the information your IPS provided.

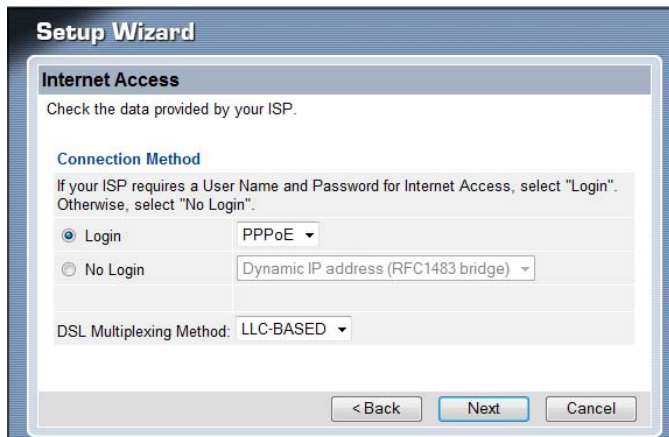

6. Type in the username & password if there is any



7. Waiting for the Modem Router reboot.

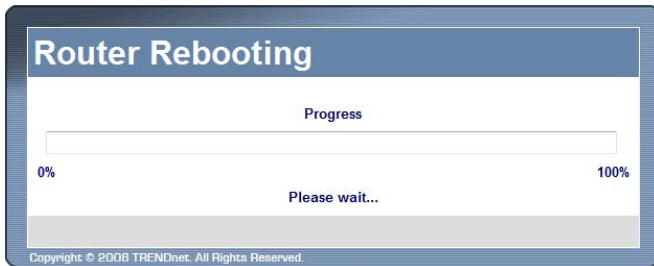

8. Click **OK**.

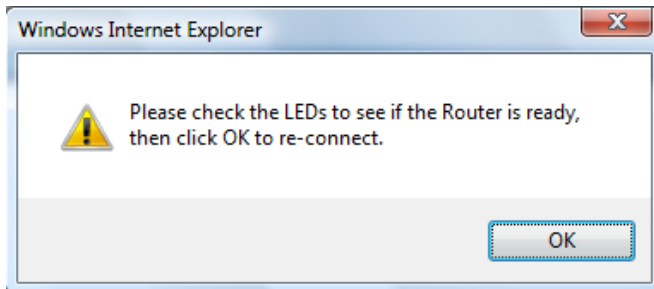

9. Click **Finish** to diagnostic the setting result

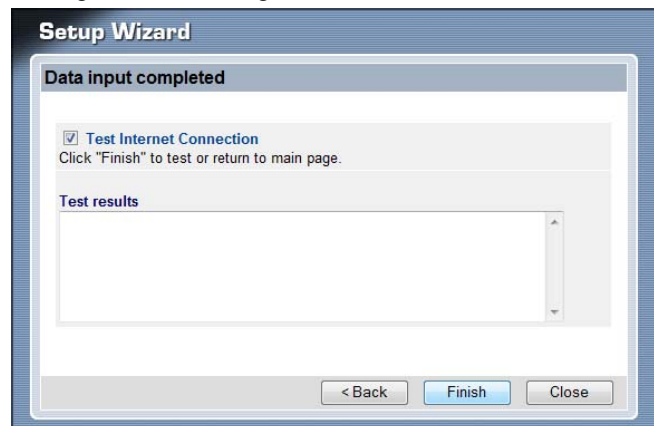

10. Click *Close* to exit the Setup Wizard



11. If the connection test fails:

- Check all connections, and the front panel LEDs.
- Check that you have entered all data correctly

Configuring VCs

The Wireless ADSL Modem Router supports multiple VCs (Virtual Circuits) on the ADSL connection.

VC1 must be used for general-purpose Internet access. The other VCs are available for special purposes, such as Video-on-Demand.

You can only use these VCs if supported by your ISP and ADSL service provider. In that case, they will provide the necessary configuration data.



Some ISP's allow multiple PPPoE connections. This allows multiple PCs to connect to the Internet using PPPoE client software. When using the Wireless ADSL Modem Router, multiple PPPoE connections are neither necessary nor supported.

To Configure additional VCs

1. Start the *Setup Wizard* again.



2. Select “Enable MultiPVC”, then select VC2 and click "Next"

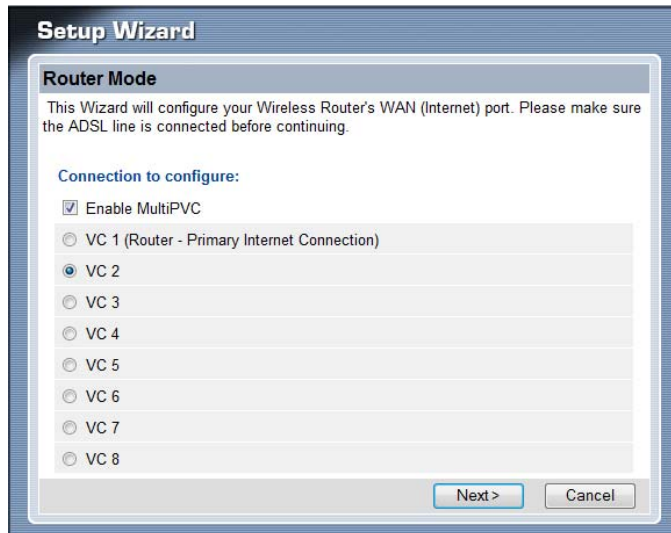

3. Configure the VC setup screen following by the screen and information by your ISP provider to finish the VC setup.

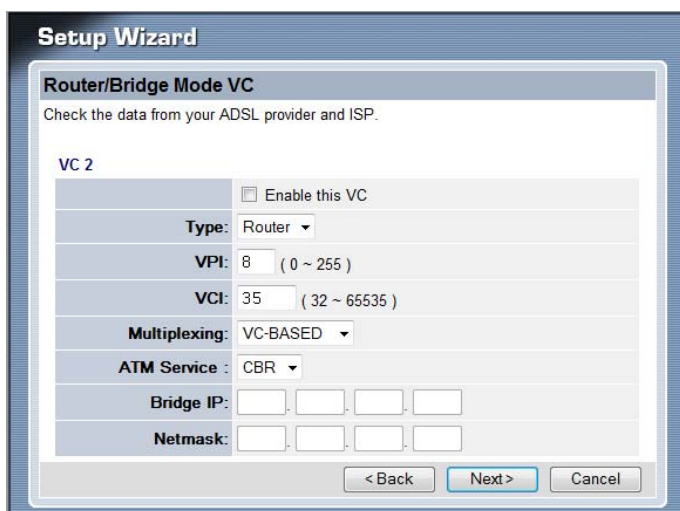

Setup Wizard VC Screen

VC	The VC number is displayed
Enable	To use this VC, you must enable it by checking this checkbox.
VPI	Enter the VPI value provided by your ISP.
VCI	Enter the VPI value provided by your ISP.
Multiplexing	Select the multiplexing value provided by your ISP.
ATM Service	Select the multiplexing value provided by your ISP.
LAN IP Address	<p>Enter the IP address of the device on your LAN which will receive the data on this VC.</p> <ul style="list-style-type: none"> • For Video-on-Demand, this would be the IP address of your SetTop Box. • For VoIP, this would be the IP address of your VoIP TA. • Note that this IP address does not have to be in the same IP address range as other devices on your local LAN.

Main Screen

After finishing the Setup Wizard, the browser will back to main screen.



Main Menu

The main menu, on the left, contains links to the most-commonly used screen. To see the links to the other available screens, click "Advanced" or "Administration".

The main menu also contains one (1) button:

- **Log Out** - When finished, you should click this button to logout.

Navigation & Data Input

- Use the menu bar on the left of the screen, and the "Back" button on your Browser, for navigation.
- Changing to another screen without clicking "Save" does NOT save any changes you may have made. You must "Save" before changing screens or your data will be ignored.



On each screen, clicking the "Help" button will display help for that screen.

LAN Screen

Use the *LAN* link on the main menu to reach the LAN screen. An example screen is shown below.

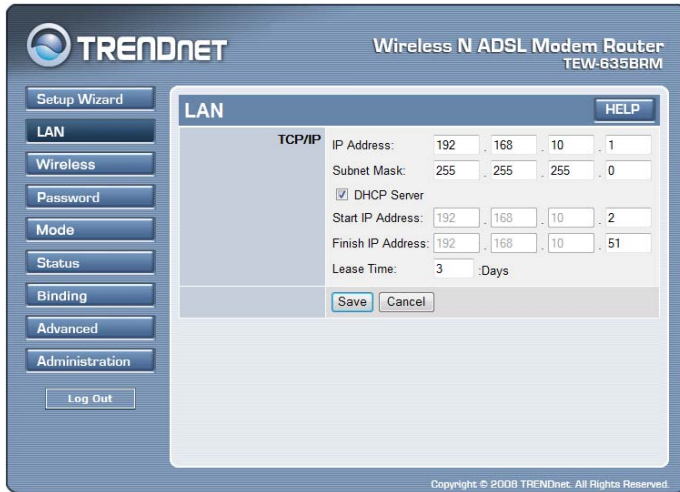

LAN Screen

TCP/IP

IP Address	IP address for the Wireless ADSL Modem Router, as seen from the local LAN. Use the default value unless the address is already in use or your LAN is using a different IP address range. In the latter case, enter an unused IP Address from within the range used by your LAN.
Subnet Mask	The default value 255.255.255.0 is standard for small (class "C") networks. For other networks, use the Subnet Mask for the LAN segment to which the Wireless ADSL Modem Router is attached (the same value as the PCs on that LAN segment).
DHCP Server	<ul style="list-style-type: none"> • If Enabled, the Wireless ADSL Modem Router will allocate IP Addresses to PCs (DHCP clients) on your LAN when they start up. The default (and recommended) value is Enabled. • If you are already using a DHCP Server, this setting must be Disabled, and the existing DHCP server must be re-configured to treat the Wireless ADSL Modem Router as the default Gateway. See the following section for further details. • The Start IP Address and Finish IP Address fields set the values used by the DHCP server when allocating IP Addresses to DHCP clients. This range also determines the number of DHCP clients supported. Enter the desired value for the Lease Time, which should be between 1 and 7. <p>See the following section for further details on using DHCP.</p>

DHCP

What DHCP Does

A DHCP (Dynamic Host Configuration Protocol) **Server** allocates a valid IP address to a DHCP **Client** (PC or device) upon request.

- The client request is made when the client device starts up (boots).
- The DHCP Server provides the *Gateway* and *DNS* addresses to the client, as well as allocating an IP Address.
- The Wireless ADSL Modem Router can act as a **DHCP server**.
- Windows other non-Server versions of Windows will act as a DHCP **client**. This is the default Windows setting for the TCP/IP network protocol. However, Windows uses the term *Obtain an IP Address automatically* instead of "DHCP Client".
- You must NOT have two (2) or more DHCP Servers on the same LAN segment. (If your LAN does not have other Routers, this means there must only be one (1) DHCP Server on your LAN.)

Using the Wireless ADSL Modem Router's DHCP Server

This is the default setting. The DHCP Server settings are on the *LAN* screen. On this screen, you can:

- Enable or Disable the Wireless ADSL Modem Router's *DHCP Server* function.
- Set the range of IP Addresses allocated to PCs by the DHCP Server function.



You can assign Fixed IP Addresses to some devices while using DHCP, provided that the Fixed IP Addresses are NOT within the range used by the DHCP Server.

Using another DHCP Server

You can only use one (1) DHCP Server per LAN segment. If you wish to use another DHCP Server, rather than the Wireless ADSL Modem Router's, the following procedure is required.

- Disable the DHCP Server feature in the Wireless ADSL Modem Router. This setting is on the LAN screen.
- Configure the DHCP Server to provide the Wireless ADSL Modem Router's IP Address as the *Default Gateway*.

To Configure your PCs to use DHCP

This is the default setting for TCP/IP for all non-Server versions of Windows.

See *Chapter 4 - Client Configuration* for the procedure to check these settings.

Wireless Screen

The Wireless ADSL Modem Router's settings must match the other Wireless stations.

Note that the Wireless ADSL Modem Router will automatically accept both 802.11b and 802.11g connections, and no configuration is required for this feature.

To change the Wireless ADSL Modem Router's default settings for the Wireless Access Point feature, use the *Wireless* link on the main menu to reach the **Wireless** screen. An example screen is shown below.

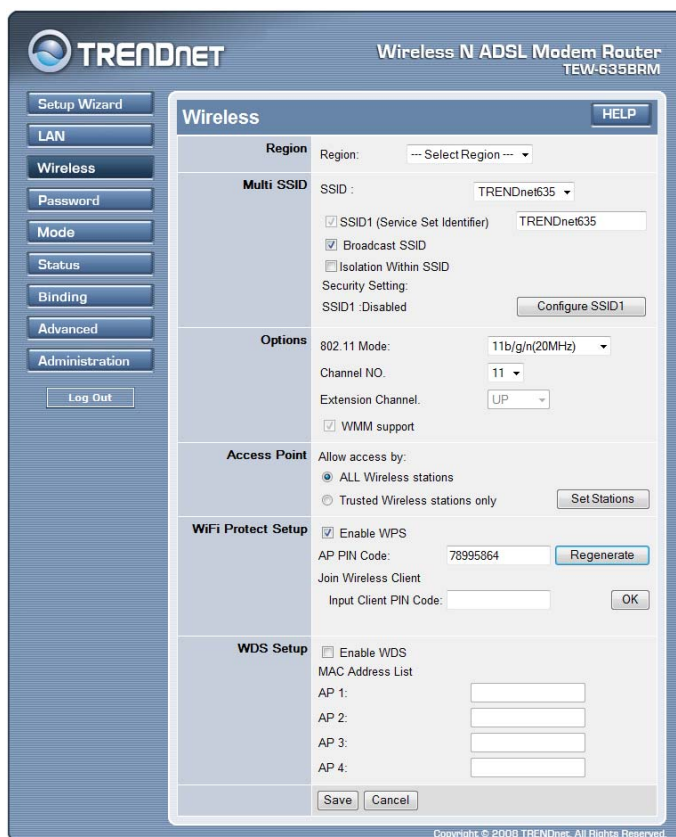

Wireless Screen

Region	
Region	Select the correct domain for your location. It is your responsibility to ensure: <ul style="list-style-type: none">• That the Wireless ADSL Modem Router is only used in domains for which is licensed.• That you select the correct domain, so that only the legal channels for that domain can be selected.

Multi SSID	
SSID	<p>With Multiple SSIDs, you can have 2 SSIDs on one AP. For example, a Guest SSID without encryption for visitors to have Internet access only, and a Admin SSID with encryption for private use to secure your company resources.</p> <p>Select the desired SSID from the list to configure.</p>
SSID 1/SSID 2	<p>This is also called the "Network Name".</p> <ul style="list-style-type: none"> • If using an ESS (Extended Service Set, with multiple access points) this ID is called an ESSID (Extended Service Set Identifier). • To communicate, all Wireless stations should use the same SSID/ESSID.
Broadcast SSID	<p>If enabled, the Wireless ADSL Modem Router will broadcast its SSID. This allows PCs and other wireless stations to detect this Access Point and use the correct SSID.</p> <p>If disabled, PC users will have to manually enter the SSID and other details of the wireless interface before they can connect to this Access Point.</p>
Isolation within SSID	<p>If Enabled, devices that have the same SSID will not be able to see each other.</p>
Security Setting	<p>The current Wireless security is displayed. The default value is Disabled.</p>
Configure SSID 1/SSID2 Button	<p>Click this button to access the Wireless security sub-screen, and view or change the settings. See the following section for details.</p>
Options	
802.11 Mode	<p>Select the desired mode:</p> <ul style="list-style-type: none"> • 11b + 11g - Both 802.11b and 802.11g Wireless stations will be able to use the Wireless Broadband Router. • 11b/g/N (20MHz) - 802.11.g, 802.11b and 802.11n (20MHz) Wireless stations can use the Wireless Broadband Router. • 11b/g/N (20/40MHz) - 802.11b, 802.11g and 802.11n (20MHz or 40MHz) Wireless stations can use the Wireless Broadband Router. • Disable: Wireless function is off
Channel No.	<p>Select the Channel you wish to use on your Wireless LAN.</p> <ul style="list-style-type: none"> • If you experience interference (shown by lost connections and/or slow data transfers) you may need to experiment with different channels to see which is the best. • If using multiple Access Points, adjacent Access Points should use different Channels to reduce interference.
Extension Channel	<p>Select either UP or DOWN from the list.</p>
WMM Support	<p>Enable or disable this feature as required.</p>

Access Point	
Allow access by ...	<p>Use this feature to determine which Wireless stations can use the Access Point. The options are:</p> <ul style="list-style-type: none"> • All Wireless Stations - All wireless stations can use the access point, provided they have the correct SSID and security settings. • Trusted Wireless stations only - Only wireless stations you designate as "Trusted" can use the Access Point, even if they have the correct SSID and security settings. <p>This feature uses the MAC address to identify Wireless stations. The MAC address is a low-level network identifier which is unique to each PC or network device.</p> <p>To define the trusted wireless stations, use the "Set Stations" button.</p>
Set Stations Button	Click this button to manage the trusted PC database.
WiFi Protect Setup	
Enable WPS	Enable this if you want to use Wireless WPS function.
AP PIN Code	Click the <i>Regenerate</i> button to have the new pin code in the field.
Input Client PIN Code	Enter the client's PIN code in the field and click <i>OK</i> to add the client device.
WDS	
Enable WDS	<p>This feature allows you to make a completely wireless network by using multiple access points without connecting them with a wire LAN.</p> <p>In order to make the WDS working successfully, the access point must use the same channel, SSID, as well as the wireless encryption method.</p>
MAC Address List	Enter the MAC address(es) of the AP(s) into the fields to allow the following access points to be connected to the wireless router.

Wireless Security

This screen is accessed by clicking the "Configure SSID" button on the *Wireless* screen. There are 3 options for Wireless security:

- **Disabled** - no data encryption is used.
- **WEP** - data is encrypted using the WEP standard.
- **WPA-PSK** - data is encrypted using the WPA-PSK standard. This is a later standard than WEP, and provides much better security than WEP. If all your Wireless stations support WPA-PSK, you should use WPA-PSK rather than WEP.
- **WPA2-PSK** - This is a further development of WPA-PSK, and offers even greater security, using the AES (Advanced Encryption Standard) method of encryption.
- **Mixed WPA-PSK/WAP2-PSK** - This method, sometimes called "Mixed Mode", allows clients to use EITHER WPA-PSK OR WPA2-PSK.
- **WPA-802.1x** - This version of WPA requires a Radius Server on your LAN to provide the client authentication according to the 802.1x standard. Data transmissions are encrypted using the WPA standard.

If this option is selected:

- This Access Point must have a "client login" on the Radius Server.
- Each user must have a "user login" on the Radius Server.
- Each user's wireless client must support 802.1x and provide the login data when required.
- All data transmission is encrypted using the WPA standard. Keys are automatically generated, so no key input is required.

WEP Wireless Security

The screenshot shows a configuration window titled "Wireless Security" with a "HELP" button in the top right corner. The "Security System" is set to "WEP". Below this, the "Authentication Type" is set to "Automatic" and "WEP Data Encryption" is set to "64 bit (10 Hex chars)". There are four radio buttons for "Key 1", "Key 2", "Key 3", and "Key 4", each followed by an empty text input field. A "Passphrase" field is also present, followed by a "Generate Keys" button. At the bottom of the window are "Save", "Cancel", and "Close" buttons. A copyright notice at the very bottom reads "Copyright © 2008 TRENDnet. All Rights Reserved."

WEP Screen

WEP Data Encryption

WEP Data

Select the desired option, and ensure the Wireless Stations use the

Encryption	<p>same setting.</p> <ul style="list-style-type: none"> • 64 Bit - data is encrypted, using the default key, before being transmitted. You must enter at least the default key. For 64 Bit Encryption, the key size is 10 chars in HEX (0~9 and A~F). • 128 Bit - data is encrypted, using the default key, before being transmitted. You must enter at least the default key. For 128 Bit Encryption, the key size is 26 chars in HEX (0~9 and A~F).
Default Key	<p>Select the key you wish to be the default. Transmitted data is ALWAYS encrypted using the Default Key; the other Keys are for decryption only.</p> <p>You must enter a Key Value for the Default Key.</p>
Key Value	<p>Enter the key value or values you wish to use. The Default Key is required, the other keys are optional. Other stations must have the same key.</p>
Passphrase	<p>If desired, you can generate a key from a phrase, instead of entering the key value directly. Enter the desired phrase, and click the "Generate Keys" button.</p>

WPA-PSK Wireless Security

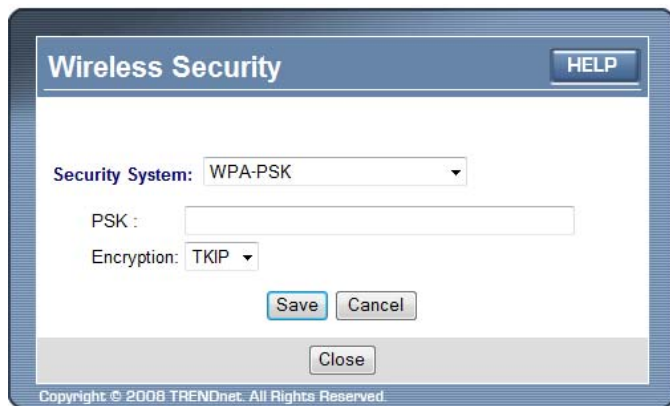

WPA-PSK Screen

PSK	<p>Enter the PSK (network key). Data is encrypted using a key derived from the network key. Other Wireless Stations must use the same network key. The PSK must be from 8 to 63 characters in length.</p>
Encryption	<p>The WPA-PSK standard allows different encryption methods to be used. Select the desired option. Wireless Stations must use the same encryption method.</p>

WPA2-PSK Wireless Security

WPA2-PSK Screen

Authentication	This is a further development of WPA-PSK, and offers even greater security.
PSK	Enter the PSK (network key). Data is encrypted using a key derived from the network key. Other Wireless Stations must use the same network key. The PSK must be from 8 to 63 characters in length.
Encryption	The WPA2-PSK standard allows different encryption methods to be used. Select the desired option. Wireless Stations must use the same encryption method.

Mixed WPA-PSK/WAP2-PSK Wireless Security

Mixed WPA-PSK/WAP2-PSK Screen

Authentication	This method, sometimes called "Mixed Mode", allows clients to use EITHER WPA-PSK OR WPA2-PSK.
-----------------------	---

PSK	Enter the PSK (network key). Data is encrypted using a key derived from the network key. Other Wireless Stations must use the same network key. The PSK must be from 8 to 63 characters in length.
Encryption	The Mixed WPA-PSK/WAP2-PSK standard allows different encryption methods to be used. Select the desired option. Wireless Stations must use the same encryption method.

WPA-802.1x Wireless Security

Wireless Security HELP

Security System: WPA-802.1x

Server Address:

Radius Port: 1812

Shared Key :

Encryption: TKIP

Save Cancel

Close

Copyright © 2008 TRENDnet. All Rights Reserved.

WPA-802.1x Screen

Server Address	Enter the server address here.
Radius Port	Enter the port number used for connections to the Radius Server.
Shared Key	Enter the shared key. Data is encrypted using a key derived from the network key. Other Wireless Stations must use the same key. The key must be from 8 to 63 characters in length.
Encryption	The encryption method is TKIP. Wireless Stations must also use TKIP.

Trusted Wireless Stations

This feature can be used to prevent unknown Wireless stations from using the Access Point. This list has no effect unless the setting *Allow access by trusted stations only* is enabled.

To change the list of trusted wireless stations, use the *Modify List* button on the *Access Control* screen. You will see a screen like the sample below.

Trusted Wireless Stations

Trusted Wireless Stations	This lists any Wireless Stations which you have defined as "Trusted".
Other Wireless Stations	This list any Wireless Stations detected by the Access Point, which you have not defined as "Trusted".
Name	The name assigned to the Trusted Wireless Station. Using this feature when adding or editing a Trusted Station.
Address	The MAC (physical) address of the Trusted Wireless Station. Using this feature when adding or editing a Trusted Station.
Buttons	
<<	<p>Add a Trusted Wireless Station to the list (move from the "Other Stations" list).</p> <ul style="list-style-type: none"> Select an entry (or entries) in the "Other Stations" list, and click the "<<" button. Enter the Address (MAC or physical address) of the wireless station, and click the "Add" button.

>>	<p>Delete a Trusted Wireless Station from the list (move to the "Other Stations" list).</p> <ul style="list-style-type: none"> • Select an entry (or entries) in the "Trusted Stations" list. • Click the ">>" button.
Edit	<p>Use this to change an existing entry in the "Trusted Stations" list:</p> <ol style="list-style-type: none"> 1. Select the Station in the <i>Trusted Station</i> list. 2. Click the <i>Edit</i> button. The address will be copied to the "Address" field, and the <i>Add</i> button will change to <i>Update</i>. 3. Edit the address (MAC or physical address) as required. 4. Click <i>Update</i> to save your changes.
Add (Update)	<p>To add a Trusted Station which is not in the "Other Wireless Stations" list, enter the required data and click this button.</p> <p>When editing an existing Wireless Station, this button will change from <i>Add</i> to <i>Update</i>.</p>
Clear	<p>Clear the <i>Name</i> and <i>Address</i> fields.</p>

Password Screen

The password screen allows you to assign a password to the Wireless ADSL Modem Router.



Old Password	Enter the existing password in this field.
New password	Enter the new password here.
Verify password	Re-enter the new password here.

After click “Save” button, the information will store into the memory and the field will leave as blank.

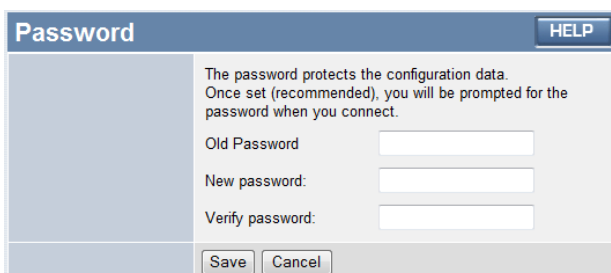

Click any button to continue, it screen will prompt the password login page. Enter correct password to login the page again. Please note: the username name is always “admin”.

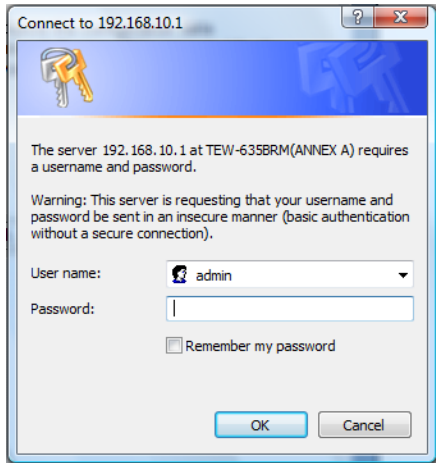

Mode Screen

Use this screen to change the mode between Router mode and Modem (Bridge) mode. The example show below is Router mode. For detail Modem mode, please refer to Chapter 7.



Select the desired option, and click "Save".

<p>Router (Router + Modem)</p>	<p>Both the ADSL Modem and the Router features are operational. In this mode, this device can provide shared Internet Access to all your LAN users. Also, by default, it acts a DHCP Server, providing an IP address and related information to all Wireless and LAN users.</p>
<p>Modem (Modem only)</p>	<p>Only the ADSL Modem component is operational.</p> <ul style="list-style-type: none"> • All Router features are disabled. This device is "transparent" - it does not perform any operations or make any changes to the network traffic passing through it. • You need to have a DHCP Server on your LAN to provide IP addresses to the Wireless clients using this Access Point. • All traffic received on either the Wireless or LAN interface will be sent over the ADSL connection.

Notes:

- Generally, you should NOT use modem mode. Only select this mode if you understand what you actually needed.
- After changing the mode, this device will restart, which will take a few seconds. The menu will also change, depending on the mode you are in.
- The Wireless Access Point can function in either Router or Modem mode. However, in general it is not recommend to combine a Modem with an Access Point, because all data received from the wireless stations will be sent over the modem connection. (Since the modem is transparent, it does not examine the traffic to determine whether the traffic is for the LAN or the WAN.)

Status

Use the *Status* link on the main menu to view this screen.

The screenshot shows a 'Status' window with a 'HELP' button in the top right. The window is divided into several sections:

- ADSL:** Modem Status: Connected; DownStream Connection Speed: 384 kbps; UpStream Connection Speed: 384 kbps. A button labeled 'ADSL Details' is present.
- Internet:** Connection Method: PPPoE; Connection Status: Idle; Internet IP Address: ---; Wan MAC Address: 0C:00:02:00:00:00. Buttons labeled 'Connection Details' and 'MultiPVC Details' are present.
- LAN:** IP Address: 192.168.10.1; Network Mask: 255.255.255.0; DHCP Server: On; MAC Address: 0C:00:02:00:00:00.
- Wireless:** SSID1: TRENDnet635; MAC Address: 0C:00:02:00:00:00; SSID2: Guest; MAC Address: 0C:00:02:00:00:00; Region: --; Channel: 11; Wireless AP: enable; Broadcast Name: enable.
- System:** Device Name: TEW-635BRM; Firmware Version: 1.00.03. Buttons labeled 'Refresh Screen' and 'Attached Devices' are present.

Status Screen

ADSL	
Modem Status	This indicates the status of the ADSL modem component.
DownStream Connection Speed	Displays the speed for the DownStream Connection.
UpStream Connection Speed	If connected, displays the speed for the Up Stream (upload) ADSL Connection.
ADSL Details	Click this button to open a sub-window and view the details of each VC (Virtual Circuit).
Internet (VC1)	
Connection Method	Displays the current connection method, as set in the <i>Setup Wizard</i> .
Connection Status	This indicates the current status of the Internet Connection <ul style="list-style-type: none"> • Active - Connection exists • Idle - No current connection, but no error has been detected. This condition normally arises when an idle connection is automatically terminated.

	<ul style="list-style-type: none"> • Failed - The connection was terminated abnormally. This could be caused by Modem failure, or the loss of the connection to the ISP's server. <p>If there is an error, you can click the "Connection Details" button to find out more information.</p>
Internet IP Address	This IP Address is allocated by the ISP (Internet Service Provider). If using a dynamic IP address, and no connection currently exists, this information is unavailable.
WAN MAC Address	It displays the MAC address for the WAN.
Connection Details	Click this button to open a sub-window and view a detailed description of the current connection. Depending on the type of connection, a "log" may also be available.
MultiPVC Details	Click this button to view the details of multi PVC in the sub-screen.
Connection Details	Click this button to open a sub-window and view a detailed description of the current connection.
LAN	
IP Address	The IP Address of the Wireless ADSL Modem Router.
Network Mask	The Network Mask (Subnet Mask) for the IP Address above.
DHCP Server	This shows the status of the DHCP Server function. The value will be "Enabled" or "Disabled".
MAC Address	This shows the MAC Address for the Wireless ADSL Modem Router, as seen on the LAN interface.
Wireless	
SSID 1	It displays the name of the SSID 1.
SSID 2	It displays the name of the SSID 2.
Region	The current region, as set on the Wireless screen.
Channel	This shows the Channel currently used, as set on the Wireless screen.
Wireless AP	This indicates whether or not the Wireless Access Point feature is enabled.
Broadcast Name	This indicates whether or not the SSID is Broadcast. This setting is on the Wireless screen.
System	
Device Name	The current name of the Router. This name is also the "hostname" for users with an "@Home" type connection.
Firmware Version	The version of the current firmware installed.
Buttons	
Attached Devices	This will open a sub-window, showing all LAN and Wireless devices currently on the network.

Refresh Screen

Update the data displayed on screen.

Connection Status - PPPoE & PPPoA

If using PPPoE (PPP over Ethernet) or PPPoA (PPP over ATM), a screen like the following example will be displayed when the "Connection Details" button is clicked.



PPPoE/PPPoA Screen

Connection Time	This indicates how long the current connection has been established.
PPPoE Link Status	This indicates whether or not the connection is currently established. <ul style="list-style-type: none">• Click "Connect" button to establish an Internet connection.• Click "Disconnect" to exit an Internet connection.
Negotiation	This indicates the status of the PPPoE Server login.
IP Address	The IP Address of this device, as seen by Internet users. This address is allocated by your ISP (Internet Service Provider).
Network Mask	The Network Mask associated with the IP Address above.
Buttons	
Connect	Click this button to establish a Internet connection.
Disconnect	Click this button to exit an Internet connection.
Close	Close the window.

Connection Details - Dynamic IP Address

If your access method is "Direct" (no login), with a Dynamic IP address, a screen like the following example will be displayed when the "Connection Details" button is clicked.



Dynamic IP address

Internet	
IP Address	The current IP Address of this device, as seen by Internet users. This address is allocated by your ISP (Internet Service Provider).
Network Mask	The Network Mask associated with the IP Address above.
Default Gateway	The IP address of the remote Gateway or Router associated with the IP Address above.
DHCP Server	The IP address of your ISP's DHCP Server.
DNS Server	The IP address of the Domain Name Server which is currently used.
Lease Obtained Lease Expires	This indicates when the current IP address was obtained, and how long before this IP address allocation (the DHCP lease) expires.
Buttons	
Release	If an IP Address has been allocated to the Wireless ADSL Modem Router (by the ISP's DHCP Server, clicking the "Release" button will break the connection and release the IP Address.
Renew	If the ISP's DHCP Server has NOT allocated an IP Address for the Wireless ADSL Modem Router, clicking the "Renew" button will attempt to re-establish the connection and obtain an IP Address from the ISP's DHCP Server.
Close	Close this window.

Connection Details - Fixed IP Address

If your access method is "Direct" (no login), with a fixed IP address, a screen like the following example will be displayed when the "Connection Details" button is clicked.

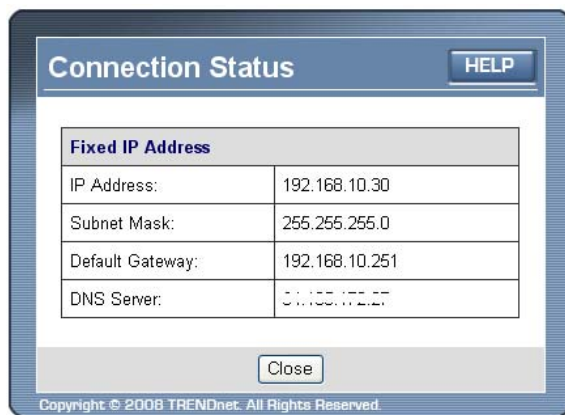

Fixed IP address Screen

Internet	
IP Address	The IP Address of this device, as seen by Internet users. This address is allocated by your ISP (Internet Service Provider).
Network Mask	The Network Mask associated with the IP Address above.
Default Gateway	The IP Address of the remote Gateway or Router associated with the IP Address above.
DNS Server	The IP Address of the Domain Name Server which is currently used.

Binding Function

The Binding feature is for MultiPVC. If you have enabled multiple PVCs and set the WAN connection methods individually, you can bind the LAN Ports and WLAN Port to them using this page. While binding one port to the selected PVC, this port would connect Internet via this PVC. The PVC port should be configured first or the bound port will not access the Internet.

While in Modem mode, Bridge connection can only be set for all the PVCs. You can click *MultiPVC Details* in the Status screen to see all the information.

Note: When you switch from Router (Modem+Router) to Modem mode, all the connection methods will change to would be changed to Bridge. You may need to reconfigure the Bridge IP/Netmask through wizard pages if you want to access the WEB Server via the relevant port.

Binding				HELP
LAN Ports	Port 0	VC1	VPI/VCI: 0/35	Type: PPPoE
	Port 1	VC1	VPI/VCI: 0/35	Type: PPPoE
	Port 2	VC1	VPI/VCI: 0/35	Type: PPPoE
	Port 3	VC1	VPI/VCI: 0/35	Type: PPPoE
WLAN	TRENDnet635	VC1	VPI/VCI: 0/35	Type: PPPoE
	Guest	VC1	VPI/VCI: 0/35	Type: PPPoE
Group	Port 1:			
	<input type="checkbox"/> VC2 <input type="checkbox"/> VC3 <input type="checkbox"/> VC4 <input type="checkbox"/> VC5 <input type="checkbox"/> VC6 <input type="checkbox"/> VC7 <input type="checkbox"/> VC8			
		Save		Cancel

Binding Screen

Port 0	This port is always bound to the Primary Internet Connection VC1.
Port 1~3	These ports can be bound to VC2~VC8. If it is not enabled, it would be bound to VC1 as default.
WLAN	The WLAN Port can be bound to VC2~VC8. If it is not enabled,, it would be bound to VC1 as default.
VPI/VCI	It displays the current VPI/VCI information of the selected PVC.
Type	It displays the current connection type of the selected PVC.

Chapter 4

4

Computer Configuration

This Chapter details the Computer Configuration required on the local ("Internal") LAN.

Overview

For each PC, the following may need to be configured:

- TCP/IP network settings
- Internet Access configuration
- Wireless configuration

Windows Clients

This section describes how to configure Windows clients for Internet access via the Wireless ADSL Modem Router.

The first step is to check the PC's TCP/IP settings.

The Wireless ADSL Modem Router uses the TCP/IP network protocol for all functions, so it is essential that the TCP/IP protocol be installed and configured on each PC.

TCP/IP Settings - Overview

If using the default Wireless ADSL Modem Router setting, and the default Windows TCP/IP settings, no changes need to be made.

- By default, the Wireless ADSL Modem Router will act as a DHCP Server, automatically providing a suitable IP Address (and related information) to each PC when the PC boots.
- For all non-Server versions of Windows, the default TCP/IP setting is to act as a DHCP client.

If using a Fixed (specified) IP address, the following changes are required:

- The *Gateway* must be set to the IP address of the Wireless ADSL Modem Router
- The *DNS* should be set to the address provided by your ISP.



If your LAN has a Router, the LAN Administrator must re-configure the Router itself. Refer to *Chapter 6 - Advanced Administrator* for details.

Checking TCP/IP Settings - Windows NT4.0

1. Select *Control Panel - Network*, and, on the *Protocols* tab, select the TCP/IP protocol, as shown below.

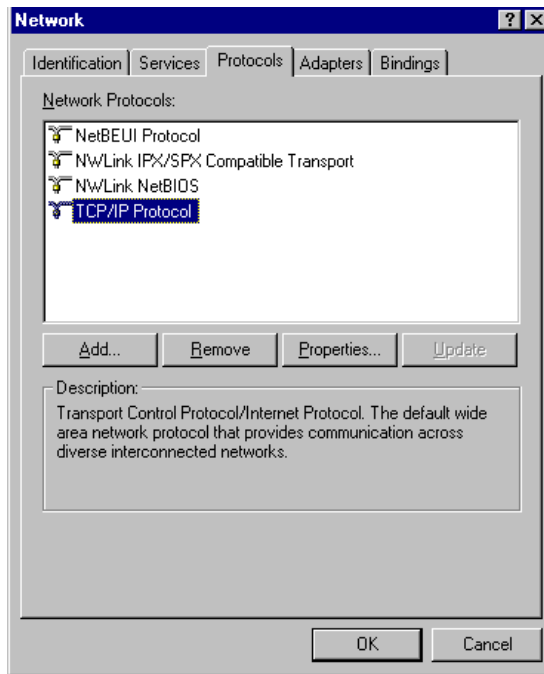

2. Click the *Properties* button to see a screen like the one below.

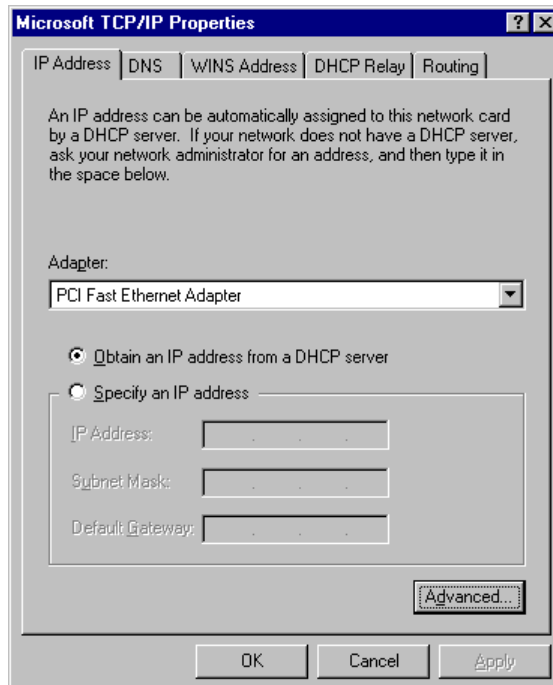

3. Select the network card for your LAN.
4. Select the appropriate radio button - *Obtain an IP address from a DHCP Server* or *Specify an IP Address*, as explained below.

Obtain an IP address from a DHCP Server

This is the default Windows setting. **Using this is recommended.** By default, the Wireless ADSL Modem Router will act as a DHCP Server.

Restart your PC to ensure it obtains an IP Address from the Wireless ADSL Modem Router.

Specify an IP Address

If your PC is already configured, check with your network administrator before making the following changes.

1. The *Default Gateway* must be set to the IP address of the Wireless ADSL Modem Router. To set this:
 - Click the *Advanced* button on the screen above.
 - On the following screen, click the *Add* button in the *Gateways* panel, and enter the Wireless ADSL Modem Router's IP address, as shown in **Error! Reference source not found.** below.
 - If necessary, use the *Up* button to make the Wireless ADSL Modem Router the first entry in the *Gateways* list.

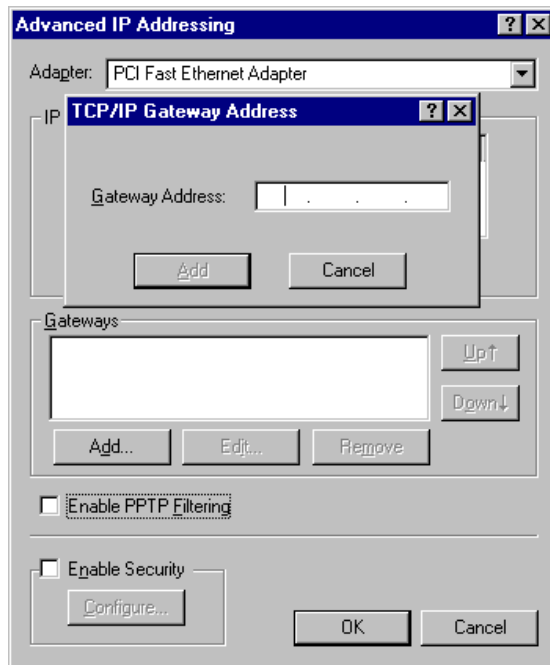

2. The DNS should be set to the address provided by your ISP, as follows:
 - Click the DNS tab.
 - On the DNS screen, shown below, click the *Add* button (under *DNS Service Search Order*), and enter the DNS provided by your ISP.

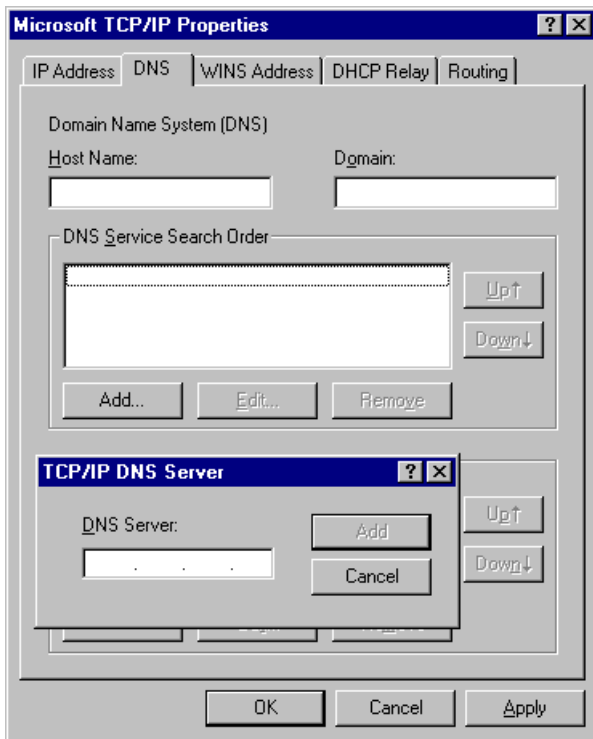

Checking TCP/IP Settings - Windows 2000:

1. Select *Control Panel - Network and Dial-up Connection*.
2. Right - click the *Local Area Connection* icon and select *Properties*. You should see a screen like the following:

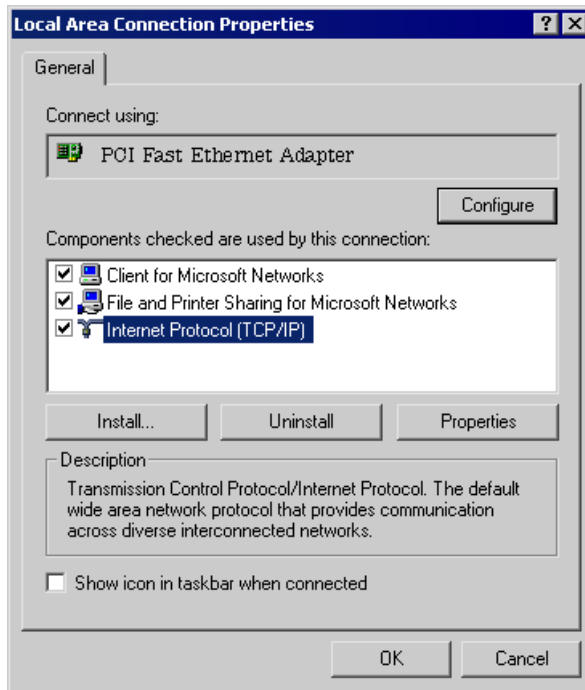

3. Select the *TCP/IP* protocol for your network card.
4. Click on the *Properties* button. You should then see a screen like the following.

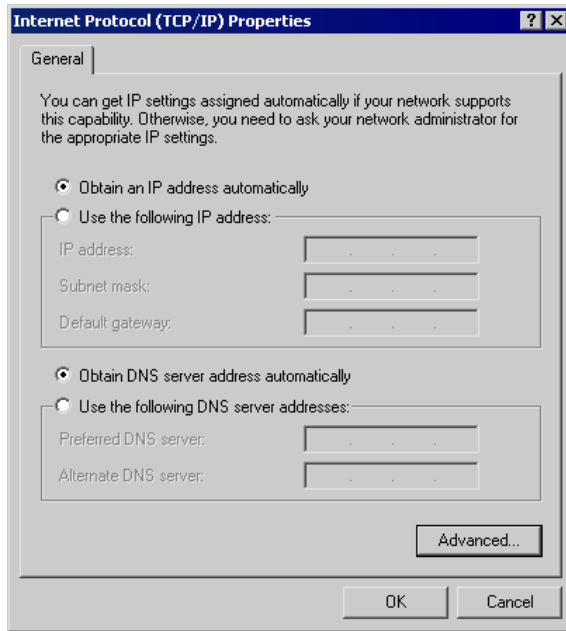

5. Ensure your TCP/IP settings are correct, as described below.

Using DHCP

To use DHCP, select the radio button *Obtain an IP Address automatically*. This is the default Windows setting. **Using this is recommended.** By default, the Wireless ADSL Modem Router will act as a DHCP Server.

Restart your PC to ensure it obtains an IP Address from the Wireless ADSL Modem Router.

Using a fixed IP Address ("Use the following IP Address")

If your PC is already configured, check with your network administrator before making the following changes.

- Enter the Wireless ADSL Modem Router's IP address in the *Default gateway* field and click *OK*. (Your LAN administrator can advise you of the IP Address they assigned to the Wireless ADSL Modem Router.)
- If the *DNS Server* fields are empty, select *Use the following DNS server addresses*, and enter the DNS address or addresses provided by your ISP, then click *OK*.

Checking TCP/IP Settings - Windows XP

1. Select *Control Panel - Network Connection*.
2. Right click the *Local Area Connection* and choose *Properties*. You should see a screen like the following:



3. Select the *TCP/IP* protocol for your network card.
4. Click on the *Properties* button. You should then see a screen like the following.

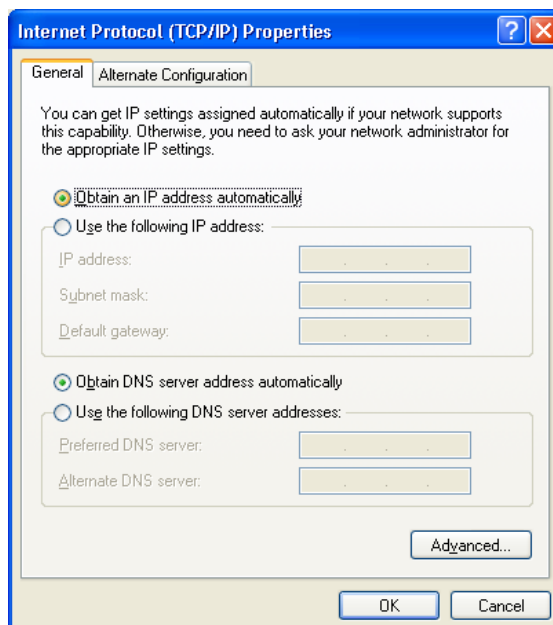

5. Ensure your TCP/IP settings are correct.

Using DHCP

To use DHCP, select the radio button *Obtain an IP Address automatically*. This is the default Windows setting. **Using this is recommended.** By default, the Wireless ADSL Modem Router will act as a DHCP Server.

Restart your PC to ensure it obtains an IP Address from the Wireless ADSL Modem Router.

Using a fixed IP Address ("Use the following IP Address")

If your PC is already configured, check with your network administrator before making the following changes.

- In the *Default gateway* field, enter the Wireless ADSL Modem Router's IP address and click *OK*. Your LAN administrator can advise you of the IP Address they assigned to the Wireless ADSL Modem Router.
- If the *DNS Server* fields are empty, select *Use the following DNS server addresses*, and enter the DNS address or addresses provided by your ISP, then click *OK*.

Checking TCP/IP Settings - Windows Vista

6. Select Control Panel - Network Connections.
7. Right click the *Local Area Connection Status* and choose *Properties*. Click *Continue* to the *User Account Control* dialog box, then you should see a screen like the following:

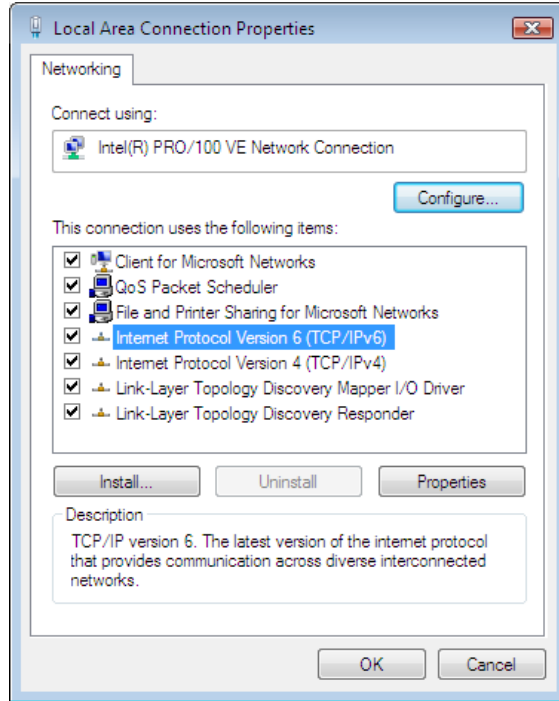

8. Select the *TCP/IP* protocol for your network card.
- 9.
10. Click on the *Properties* button. You should then see a screen like the following.

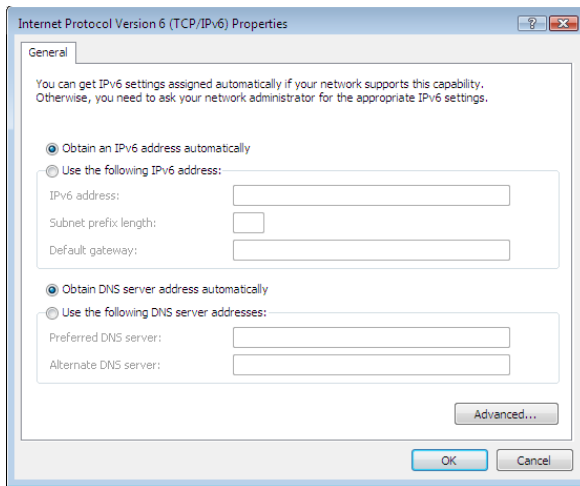

11. Ensure your TCP/IP settings are correct.

Using DHCP

To use DHCP, select the radio button *Obtain an IP Address automatically*. This is the default Windows setting. To work correctly, you need a DHCP server on your LAN.

Using a fixed IP Address ("Use the following IP Address")

If your PC is already configured for a fixed (specified) IP address, no changes are required.

(The Administrator should configure the Wireless Access Point with a fixed IP address from the same address range used on the PCs.)

Internet Access

To configure your PCs to use the Wireless ADSL Modem Router for Internet access:

- Ensure that the DSL modem, Cable modem, or other permanent connection is functional.
- Use the following procedure to configure your Browser to access the Internet via the LAN, rather than by a Dial-up connection.

For Windows 2000

1. Select *Start Menu - Settings - Control Panel - Internet Options*.
2. Select the *Connection* tab, and click the *Setup* button.
3. Select "I want to set up my Internet connection manually, or I want to connect through a local area network (LAN)" and click *Next*.
4. Select "I connect through a local area network (LAN)" and click *Next*.
5. Ensure all of the boxes on the following Local area network Internet Configuration screen are **unchecked**.
6. Check the "No" option when prompted "Do you want to set up an Internet mail account now?".
7. Click *Finish* to close the Internet Connection Wizard.
Setup is now completed.

For Windows XP

1. Select *Start Menu - Control Panel - Network and Internet Connections*.
2. Select *Set up or change your Internet Connection*.
3. Select the *Connection* tab, and click the *Setup* button.
4. Cancel the pop-up "Location Information" screen.
5. Click *Next* on the "New Connection Wizard" screen.
6. Select "Connect to the Internet" and click *Next*.
7. Select "Set up my connection manually" and click *Next*.
8. Check "Connect using a broadband connection that is always on" and click *Next*.
9. Click *Finish* to close the New Connection Wizard.
Setup is now completed.

For Windows Vista

You might already be connected to the Internet if your PC is connected to a local area network. Open your web browser and try accessing a website to find out.

1. Select *Start - Control Panel - Network and Internet*.
2. Select *Network and Sharing Center*.
3. Select *Set up a connection or network*
4. Select *Connect to the Internet*.
5. Select the desired method to fit your environment.

Accessing AOL

To access AOL (America On Line) through the Wireless ADSL Modem Router, the *AOL for Windows* software must be configured to use TCP/IP network access, rather than a dial-up connection. The configuration process is as follows:

-
- Start the *AOL for Windows* communication software. Ensure that it is Version 2.5, 3.0 or later. This procedure will not work with earlier versions.
 - Click the *Setup* button.
 - Select *Create Location*, and change the location name from "New Locality" to "Wireless ADSL Modem Router".
 - Click *Edit Location*. Select *TCP/IP* for the *Network* field. (Leave the *Phone Number* blank.)
 - Click *Save*, then *OK*.
Configuration is now complete.
 - Before clicking "Sign On", always ensure that you are using the "Wireless ADSL Modem Router" location.

Macintosh Clients

From your Macintosh, you can access the Internet via the Wireless ADSL Modem Router. The procedure is as follows.

1. Open the TCP/IP Control Panel.
2. Select *Ethernet* from the *Connect via* pop-up menu.
3. Select *Using DHCP Server* from the *Configure* pop-up menu. The DHCP Client ID field can be left blank.
4. Close the TCP/IP panel, saving your settings.

Note:

If using manually assigned IP addresses instead of DHCP, the required changes are:

- Set the *Router Address* field to the Wireless ADSL Modem Router's IP Address.
- Ensure your DNS settings are correct.

Linux Clients

To access the Internet via the Wireless ADSL Modem Router, it is only necessary to set the Wireless ADSL Modem Router as the "Gateway".

Ensure you are logged in as "root" before attempting any changes.

Fixed IP Address

By default, most Unix installations use a fixed IP Address. If you wish to continue using a fixed IP Address, make the following changes to your configuration.

- Set your "Default Gateway" to the IP Address of the Wireless ADSL Modem Router.
- Ensure your DNS (Name server) settings are correct.

To act as a DHCP Client (recommended)

The procedure below may vary according to your version of Linux and X -windows shell.

1. Start your X Windows client.
2. Select *Control Panel - Network*
3. Select the "Interface" entry for your Network card. Normally, this will be called "eth0".
4. Click the *Edit* button, set the "protocol" to "DHCP", and save this data.
5. To apply your changes
 - Use the "Deactivate" and "Activate" buttons, if available.
 - OR, restart your system.

Other Unix Systems

To access the Internet via the Wireless ADSL Modem Router:

- Ensure the "Gateway" field for your network card is set to the IP Address of the Wireless ADSL Modem Router.
- Ensure your DNS (Name Server) settings are correct.

Wireless Station Configuration

This section applies to all Wireless stations wishing to use the Wireless ADSL Modem Router's Access Point, regardless of the operating system which is used on the client.

To use the Wireless Access Point in the Wireless ADSL Modem Router, each Wireless Station must have compatible settings, as follows:

Mode	The mode must be set to <i>Infrastructure</i> (rather than Ad-hoc) Access points only operate in <i>Infrastructure</i> mode.
SSID (ESSID)	This must match the value used on the Wireless ADSL Modem Router. Note! The SSID is case sensitive.
Wireless Security	By default, Wireless security on the Wireless ADSL Modem Router is disabled. <ul style="list-style-type: none">• If Wireless security remains disabled on the Wireless ADSL Modem Router, all stations must have wireless security disabled.• If Wireless security is enabled on the Wireless Router (either WEP or WPA-PSK), each station must use the same settings as the Wireless ADSL Router.

Wireless Configuration on Windows XP

If using Windows XP to configure the Wireless interface on your PC, the configuration procedure is as follows:

1. Open the Network Connections folder. (*Start - Settings - Network Connections*).

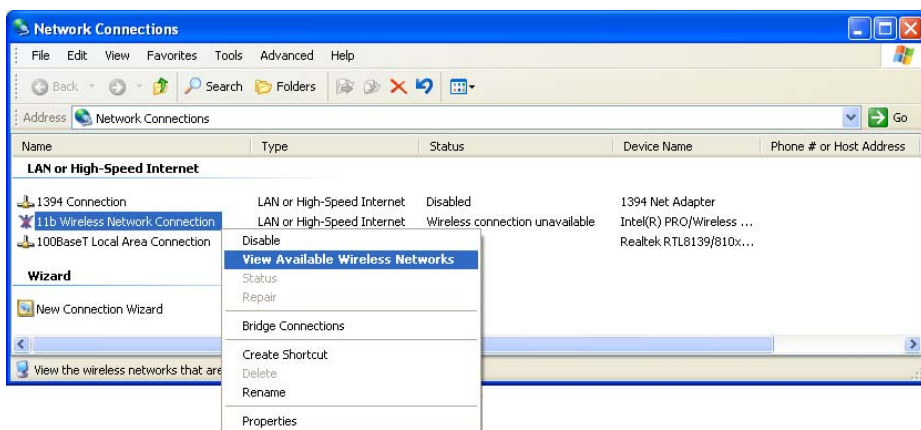

2. Right-click the Wireless Network Connection, check that it is enabled (menu option says *Disable*, rather than *Enable*) and then select *View Available Wireless Networks*.
3. You will then see a list of wireless networks.

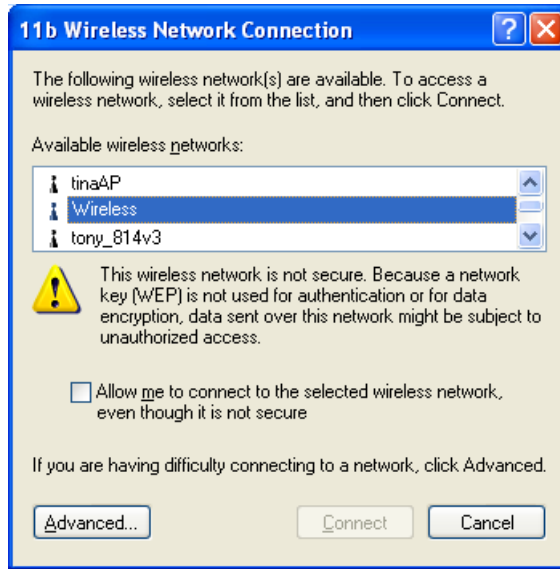

If the "Broadcast SSID" setting on the Wireless ADSL Modem Router has been disabled, its SSID will NOT be listed.

See the following section "If the SSID is not listed" for details of dealing with this situation.

4. The next step depends on whether or not Wireless security has been enabled on the Wireless ADSL Modem Router.

If Wireless Security is Disabled

If Wireless security on the Wireless ADSL Modem Router is disabled, Windows will warn you that the Wireless network is not secure.

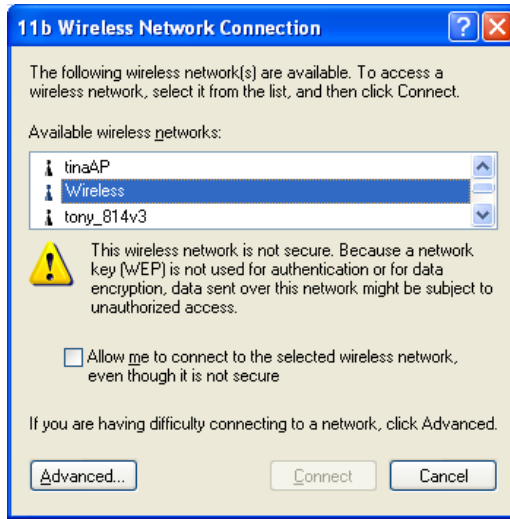

To connect:

- Check the checkbox *Allow me to connect to the selected wireless network, even though it is not secure.*
- The *Connect* button will then be available. Click the *Connect* button, and wait a few seconds for the connection to be established.

If using WEP Data Encryption

If WEP data encryption has been enabled on the Wireless ADSL Modem Router, Windows will detect this, and show a screen like the following.

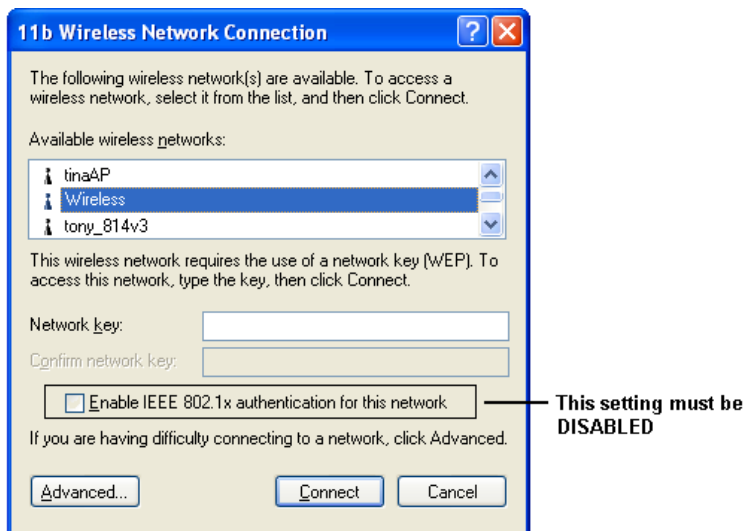

To connect:

- Enter the WEP key, as set on the Wireless ADSL Modem Router, in the *Network Key* field.
- Re-enter the WEP key into the *Confirm Network key* field.

- **Disable** the checkbox *Enable IEEE 802.1x authentication for this network*.
- Click the *Connect* button.

If this fails, click the *Advanced* button, to see a screen like the following:

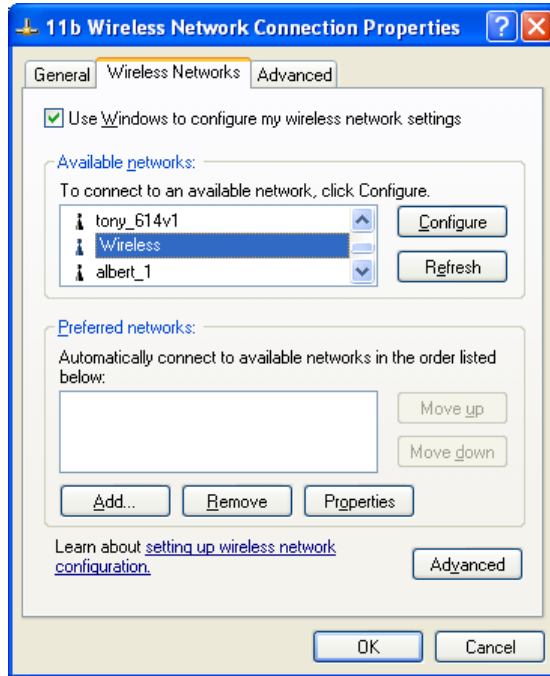

Select the SSID for the Wireless ADSL Modem Router, and click *Configure*, to see a screen like the following:

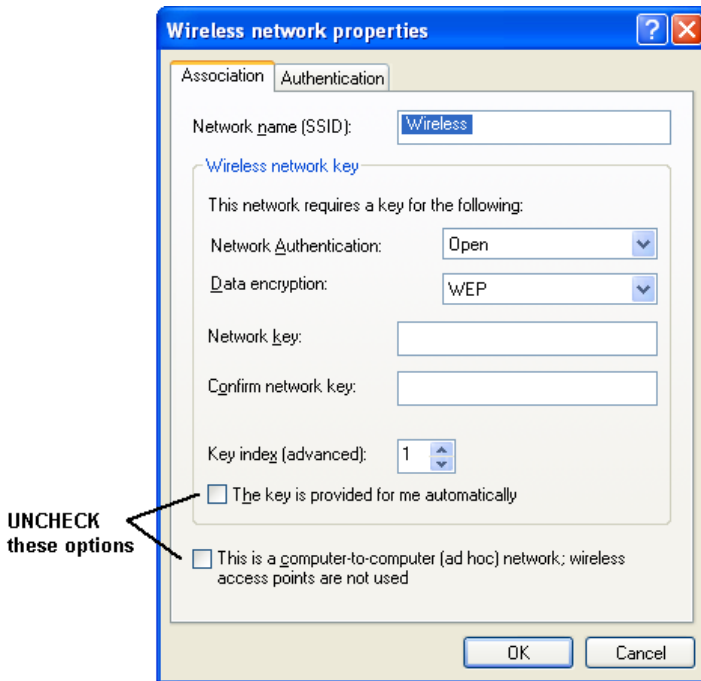

Configure this screen as follows:

- Set *Network Authentication* to match the Wireless ADSL Modem Router. (If the setting on the Wireless ADSL Modem Router is "Auto", then either *Open* or *Shared* can be used.)
- For *Data Encryption*, select **WEP**.
- For the *Network key* and *Confirm network key*, enter the **default key value** used on the Wireless ADSL Modem Router. (Windows will determine if 64bit or 128bit encryption is used.)
- The *Key index* must match the **default key index** on the Wireless ADSL Modem Router. The default value is 1.
- Ensure the options *The key is provided for me automatically* and *This is a computer-to-computer (ad hoc) network* are unchecked.
- Click OK to save and close this dialog.
- This wireless network will now be listed in *Preferred Networks* on the screen below.

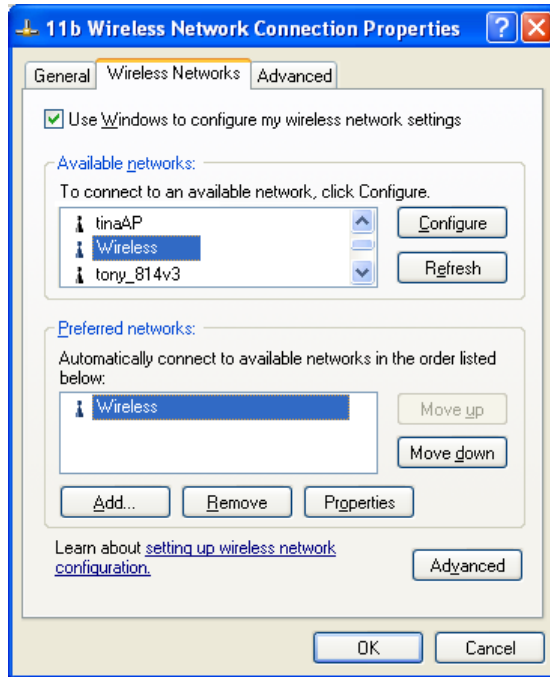

Click OK to establish a connection to the Wireless ADSL Modem Router.

If using WPA-PSK Data Encryption

If WPA-PSK data encryption has been enabled on the Wireless ADSL Modem Router, it does not matter which network is selected on the screen below. Just click the *Advanced* button.

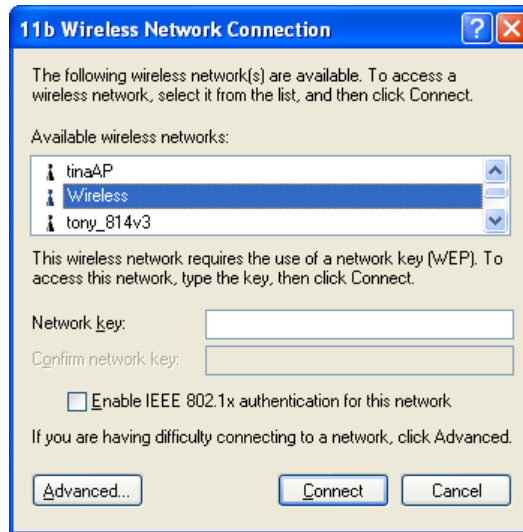

You will then see a screen like the example below.

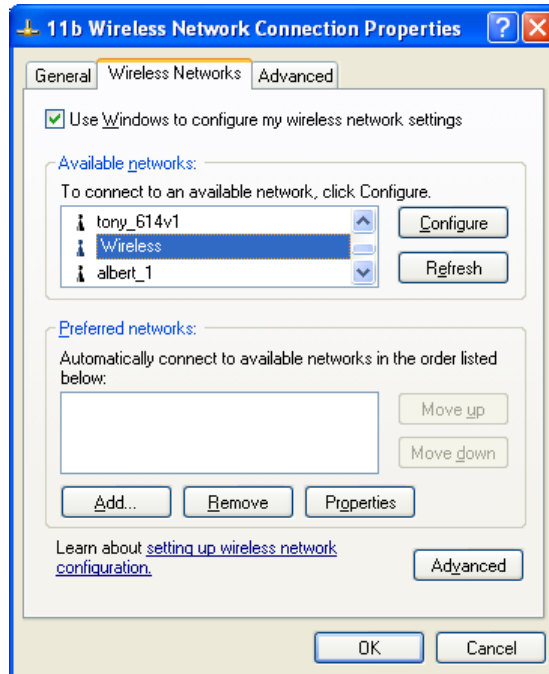

Select the SSID for the Wireless ADSL Modem Router, and click *Configure*, to see a screen like the following:

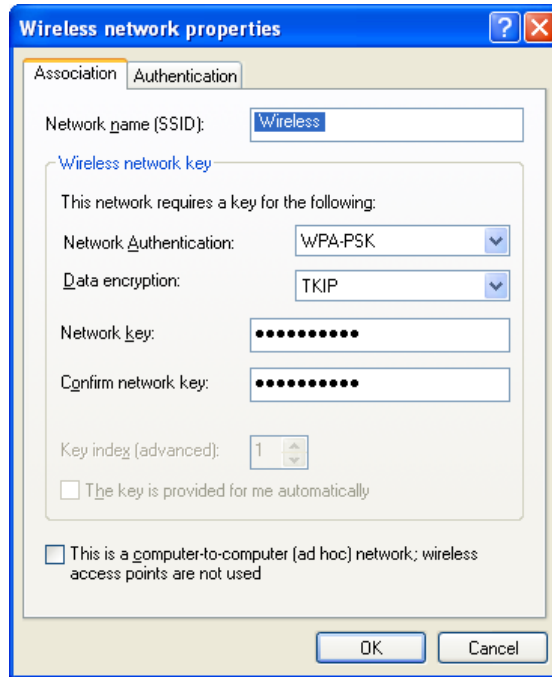

Configure this screen as follows:

- Set *Network Authentication* to **WPA-PSK**.
- For *Data Encryption*, select **TKIP**.
- For the *Network key* and *Confirm network key*, enter the network key (PSK) used on the Wireless ADSL Modem Router.
- Ensure the option *This is a computer-to-computer (ad hoc) network* is unchecked.
- Click OK to save and close this dialog.
- This wireless network will now be listed in *Preferred Networks* on the screen below.

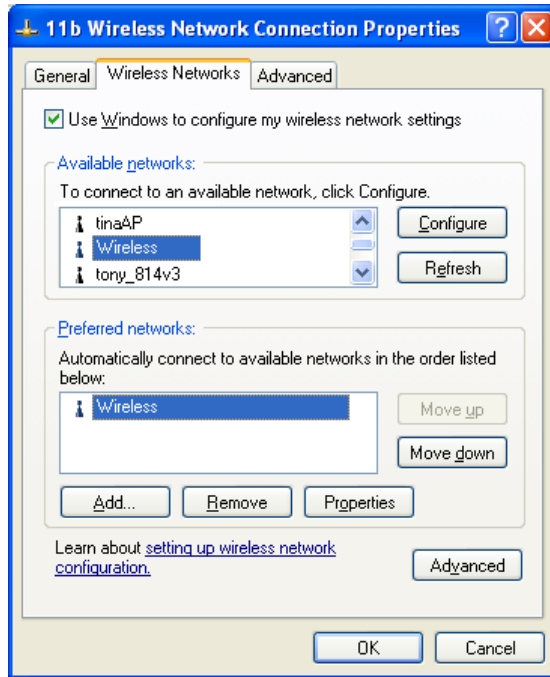

Click OK to establish a connection to the Wireless ADSL Modem Router.

If the SSID is not listed

If the "Broadcast SSID" setting on the Wireless ADSL Modem Router has been disabled, its SSID will NOT be listed on the screen below.

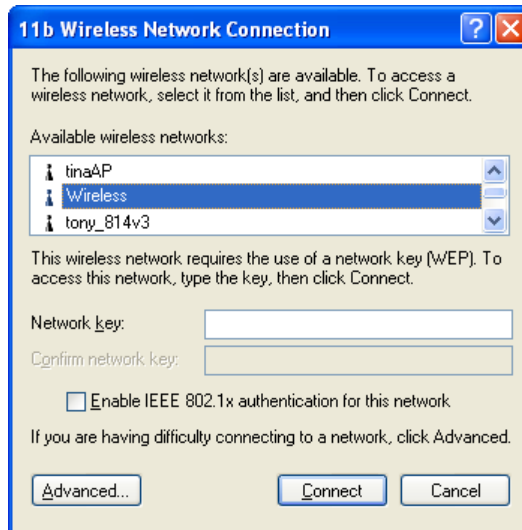

In this situation, you need to obtain the SSID from your network administrator, then follow this procedure:

1. Click the *Advanced* button to see a screen like the example below.

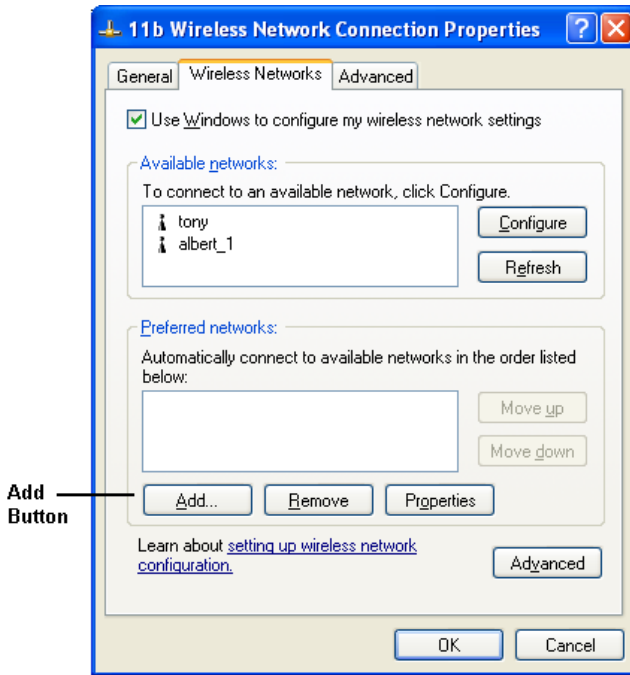

2. Click the *Add* button. You will see a screen like the example below.

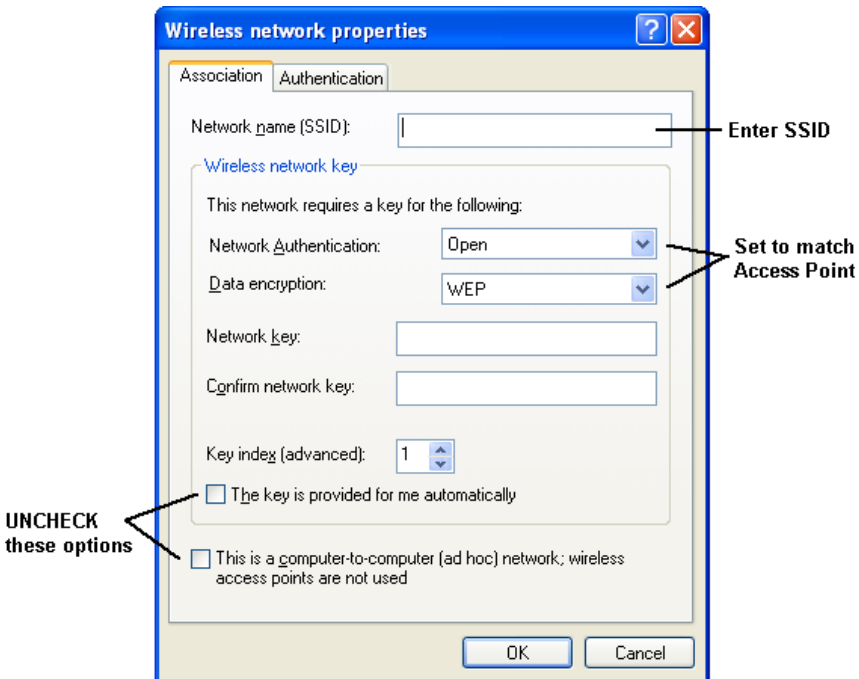

3. Configure this screen as follows:

- Enter the correct SSID, as used on the Wireless ADSL Modem Router. Remember the SSID is case-sensitive, so be sure to match the case, not just the spelling.
- Set *Network Authentication* and *Data Encryption* to match the Wireless ADSL Modem Router.
- If using data encryption (WEP or WPA-PSK), enter the key used on the Wireless ADSL Modem Router. See the preceding sections for details of WEP and WPA-PSK.
- Uncheck the options *The key is provided for me automatically* and *This is a computer-to-computer (ad hoc) network*.
- Click OK to save and exit.

4. This wireless network will then be listed in *Preferred Networks* on the screen below.

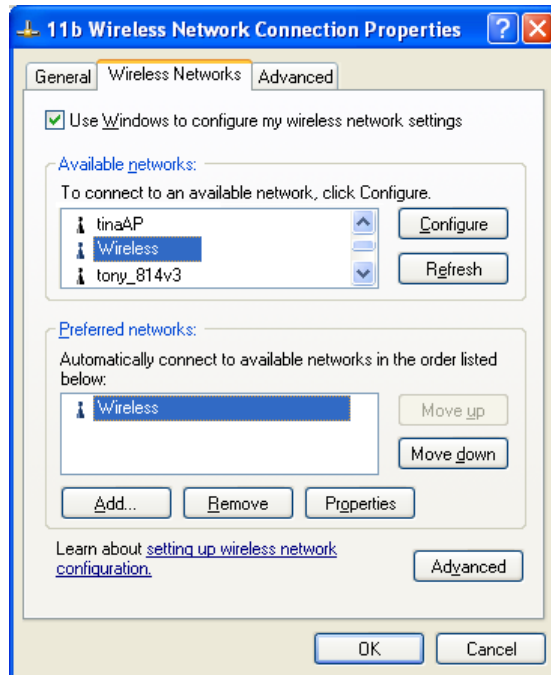

5. Click OK to establish a connection to the Wireless ADSL Modem Router.

Chapter 5

Advanced Features

This Chapter explains when and how to use the Wireless ADSL Modem Router's "Advanced" Features.

Overview

The following advanced features are provided:

- Internet:
- DMZ
- URL filter
- Access Control
- Dynamic DNS
- Options
- Schedule
- Port Trigger
- Port Forward
- Port Range Forward
- QoS

Internet

This screen provides access to the DMZ, Special Applications and URL Filter features.

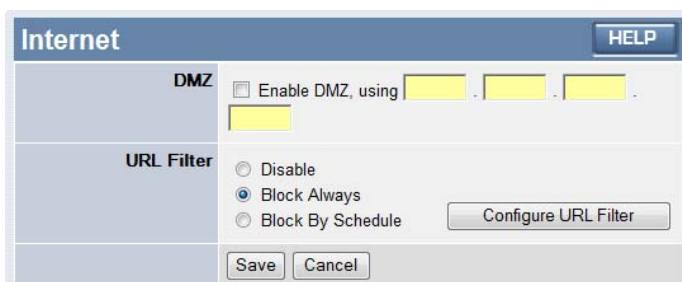

The screenshot shows the 'Internet' configuration window. It has a title bar with 'Internet' and a 'HELP' button. The window is divided into sections. The 'DMZ' section has a checkbox for 'Enable DMZ, using' followed by three yellow input fields for IP addresses. The 'URL Filter' section has three radio buttons: 'Disable', 'Block Always' (which is selected), and 'Block By Schedule'. There is a 'Configure URL Filter' button next to the 'Block By Schedule' option. At the bottom, there are 'Save' and 'Cancel' buttons.

DMZ

This feature, if enabled, allows the DMZ computer on your LAN to be exposed to all users on the Internet.

- This allows almost any application to be used on the "DMZ PC".
- The "DMZ PC" will receive all "Unknown" connections and data.

-
- If the DMZ feature is enabled, you must select the PC to be used as the "DMZ PC".



The "DMZ PC" is effectively outside the Firewall, making it more vulnerable to attacks. For this reason, you should only enable the DMZ feature when required.

URL Filter

If you want to limit access on certain sites on the Internet, you can use this feature. The URL filter will check each Web site access. If the address, or part of the address, is included in the block site list, access will be denied.

On the *Advanced Internet* screen, select the desired setting:

- **Disable** - disable URL filter feature.
- **Block Always** - allow blocking all of the time, independent of the *Schedule* page.
- **Block By Schedule** - block according to the settings on the *Schedule* page.

Click the **Configure URL Filter** button to open the URL Filter screen, allowing you to create or modify the filter strings which determine which sites will be blocked.

A rectangular button with a blue border and the text "Configure URL Filter" inside.

The *URL Filter* screen is displayed when the **Configure URL Filter** button on the *Advanced Internet* screen is clicked. Enter the word or domain name that you would like to be blocked, then click the **Add** button. To delete a word or domain name, select the string then click the **Delete** button. To remove all URL filter on the list, click **Delete All** button.

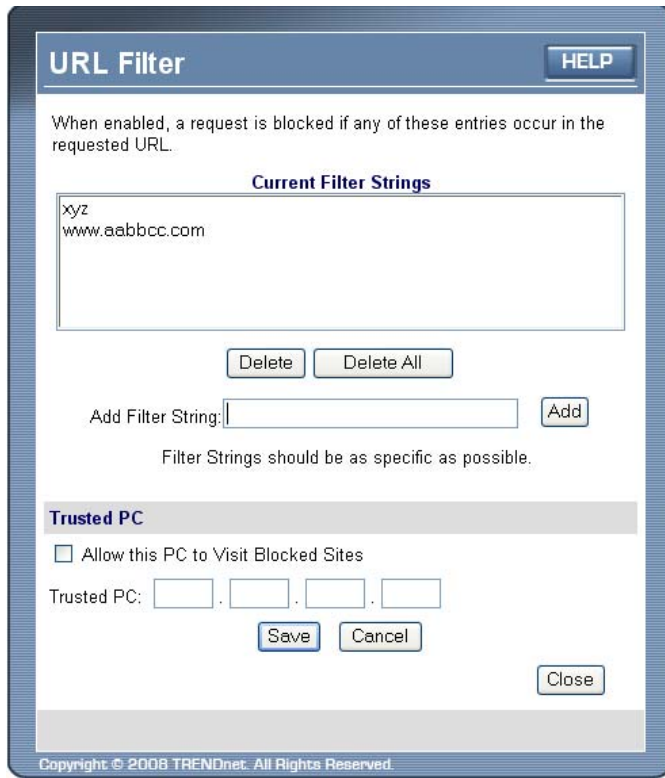

The unauthorized access to the block URL will display the following message.



URL Filter Screen

Current Filter Strings	
Current Filter Strings	<p>The list contains the current list of items to block.</p> <ul style="list-style-type: none"> To add to the list, use the "Add" option below. To delete an entry, select it and click Delete button. To delete all entries, click the Delete All button.
Add Filter String	<p>To add to the current list, type the word or domain name you want to block into the field provided, then click the Add button.</p> <p>Filter strings should be as specific as possible. Otherwise, you may block access to many more sites than intended.</p>

Trusted PC	
Allow this PC to..	Enable this to allow one computer to have unrestricted access to the Internet. For this PC, the URL filter will be ignored. If enabled, you must select the PC to be the trusted PC.
Trusted PC	Enter the PC to be the Trusted PC.

Dynamic DNS (Domain Name Server)

This free service is very useful when combined with the *Virtual Server* feature. It allows Internet users to connect to your Virtual Servers using a URL, rather than an IP Address.

This also solves the problem of having a dynamic IP address. With a dynamic IP address, your IP address may change whenever you connect, which makes it difficult to connect to you.

DDNS Services work as follows:

1. You must register for the service at one of the listed DDNS Service providers.
2. After registration, use the Service provider's normal procedure to obtain your desired Domain name.
3. Enter your DDNS data on the Wireless ADSL Modem Router's DDNS screen, and enable the DDNS feature.
4. The Wireless ADSL Modem Router will then automatically ensure that your current IP Address is recorded at the DDNS service provider's Domain Name Server.
5. From the Internet, users will be able to connect to your Virtual Servers (or DMZ PC) using your Domain name, as shown on this screen.

Dynamic DNS Screen

Select *Advanced* on the main menu, then *Dynamic DNS*, to see a screen like the following:

Dynamic DNS [HELP]

DDNS Service Use a Dynamic DNS Service

Service Provider: DynDNS.org (Dynamic) [Web Site]

DDNS Data

Host Name: []

User Name: []

Password: []

DDNS Status: [Refresh]

[Save] [Cancel]

Dynamic DNS Screen

DDNS Service	
Use a Dynamic DNS Service	Use this to enable or disable the DDNS feature as required.
Service Provider	Select the desired DDNS Service provider.
Web Site	Click this button to open a new window and connect to the Web site of the selected DDNS service provider.
DDNS Data	
Host Name	Enter the domain name allocated to you by the DDNS Service. If you have more than one name, enter the name you wish to use.

User Name	Enter your Username for the DDNS Service. (TZO.com uses your E-mail address.)
Password	Enter your current password for the DDNS Service. (TZO.com calls this a key.)
DDNS Status	<ul style="list-style-type: none">• This message is returned by the DDNS Server.• Normally, this message should be "Update successful"• If the message indicates some problem, you need to connect to the DDNS Service provider and correct this problem.

Options

This screen allows advanced users to enter or change a number of settings. For normal operation, there is no need to use this screen or change any settings.

An example *Options* screen is shown below.

The screenshot shows a window titled "Options" with a "HELP" button in the top right corner. The window is divided into two main sections: "Internet" and "UPnP".

Internet Section:

- There is a checkbox labeled "Respond to Ping on Internet (WAN) Port" which is currently unchecked.
- Below this is a text input field for "MTU Size" with the value "1500" and a note "(Bytes, 600~1500)".

UPnP Section:

- There is a checked checkbox labeled "Enable UPnP".
- Below it is a text input field for "Advertisement Period" with the value "30" and a note "(Minutes, 1~1440)".
- Below that is a text input field for "Advertisement Time to Live" with the value "4" and a note "(Hops, 1~255)".

At the bottom of the window are two buttons: "Save" and "Cancel".

Options Screen

Internet	
Respond to Ping	<ul style="list-style-type: none"> If checked, the Wireless Router will respond to Ping (ICMP) packets received from the Internet. If not checked, Ping (ICMP) packets from the Internet will be ignored. Disabling this option provides a slight increase in security.
MTU Size	Enter a value between 600 and 1500. Note: MTU (Maximum Transmission Unit) size should only be changed if advised to do so by Technical Support.
UPnP	
Enable UPnP	<ul style="list-style-type: none"> UPnP (Universal Plug and Play) allows automatic discovery and configuration of equipment attached to your LAN. UPnP is supported by Windows ME, XP, or later. If Enabled, this device will be visible via UPnP. If Disabled, this device will not be visible via UPnP.
Advertisement Period	Enter the desired value, in minutes. The valid range is from 1 to 1440.
Advertisement Time to Live	Enter the desired value, in hops. The valid range is from 1 to 255.

Schedule

This Schedule can be used for the Firewall Rules and the URL filter.

Schedule
HELP

Schedule Use 24 hour clock. On all day: 00:00 to 24:00
Off all day: All fields left 00

Day	Session 1		Session 2	
	Start	Finish	Start	Finish
Monday	00 : 00	12 : 00	12 : 00	24 : 00
Tuesday	00 : 00	12 : 00	12 : 00	24 : 00
Wednesday	00 : 00	12 : 00	12 : 00	24 : 00
Thursday	00 : 00	12 : 00	12 : 00	24 : 00
Friday	00 : 00	12 : 00	12 : 00	24 : 00
Saturday	00 : 00	12 : 00	12 : 00	24 : 00
Sunday	00 : 00	12 : 00	12 : 00	24 : 00

Local Time Time Zone: (GMT-08:00) Pacific Time(US, Canada), Tijuana ▼

Adjust for Daylight Savings Time

Use this NTP Server

Current Time: 2000-01-01 09:17:22 Weekday :Saturday

Save Cancel

Schedule Screen

Schedule	
Day	Each day of the week can be scheduled independently.
Session 1 Session 2	Two (2) separate sessions or periods can be defined. Session 2 can be left blank if not required.
Start Time	Enter the start using a 24 hr clock.
Finish Time	Enter the finish time using a 24 hr clock.
Local Time	
Time Zone	In order to display your local time correctly, you must select your "Time Zone" from the list.
Adjust for Daylight Savings Time	If your region uses Daylight Savings Time, you must manually check "Adjust for Daylight Savings Time" at the beginning of the adjustment period, and uncheck it at the end of the Daylight Savings period.
Use this NTP Server	If you prefer to use a particular NTP server as the primary NTP server, check the checkbox "Use this NTP Server" and enter the Server's IP address in the fields provided. If this setting is not enabled, the default NTP Servers are used.
Current Time	This displays the current time on the Wireless ADSL Modem Router, at the time the page is loaded.

Port Trigger

If you use Internet applications which use non-standard connections or port numbers, you may find that they do not function correctly because they are blocked by the Wireless ADSL Modem Router's firewall. In this case, you can define the application as a "Port Trigger".

The *Port Trigger* screen can be reached by clicking the *Port Trigger* on the screen.

You can then define your Port Trigger. You will need detailed information about the application; this is normally available from the supplier of the application.

Also, note that the terms "Incoming" and "Outgoing" on this screen refer to traffic from the client (PC) viewpoint

		Outgoing Ports			Incoming Ports		
Enable	Name	Type	Start	Finish	Type	Start	Finish
<input type="checkbox"/>		TCP			TCP		
<input type="checkbox"/>		TCP			TCP		
<input type="checkbox"/>		TCP			TCP		
<input type="checkbox"/>		TCP			TCP		
<input type="checkbox"/>		TCP			TCP		
<input type="checkbox"/>		TCP			TCP		
<input type="checkbox"/>		TCP			TCP		
<input type="checkbox"/>		TCP			TCP		
<input type="checkbox"/>		TCP			TCP		
<input type="checkbox"/>		TCP			TCP		
<input type="checkbox"/>		TCP			TCP		
<input type="checkbox"/>		TCP			TCP		

Save Cancel

Port Trigger Screen

Port Trigger	
Enable	Use this to Enable or Disable this Special Application as required.
Name	Enter a descriptive name to identify this Special Application.
Outgoing Ports	<ul style="list-style-type: none"> • Type - Select the protocol (TCP or UDP) used when you send data to the remote system or service. • Start - Enter the beginning of the range of port numbers used by the application server, for data you send to it. If the application uses a single port number, enter it in both the "Start" and "Finish" fields. • Finish - Enter the end of the range of port numbers used by the application server, for data you send to it. If the application uses a single port number, enter it in both the "Start" and "Finish" fields.

Incoming Ports	<ul style="list-style-type: none">• Type - Select the protocol (TCP or UDP) used when you receive data from the special application or service. (Note: Some applications use different protocols for outgoing and incoming data).• Start - Enter the beginning of the range of port numbers used by the application server, for data you receive. If the application uses a single port number, enter it in both the "Start" and "Finish" fields.• Finish - Enter the end of the range of port numbers used by the application server, for data you receive.
-----------------------	---

Port Forward

This feature allows you to make Servers on your LAN accessible to Internet users. Normally, Internet users would not be able to access a server on your LAN because:

- Your Server does not have a valid external IP Address.
- Attempts to connect to devices on your LAN are blocked by the firewall in this device.

Application	External Port	Internal Port	Protocol	IP Address	Enabled
			TCP	192.168.10.	<input type="checkbox"/>
			TCP	192.168.10.	<input type="checkbox"/>
			TCP	192.168.10.	<input type="checkbox"/>
			TCP	192.168.10.	<input type="checkbox"/>
			TCP	192.168.10.	<input type="checkbox"/>
			TCP	192.168.10.	<input type="checkbox"/>
			TCP	192.168.10.	<input type="checkbox"/>
			TCP	192.168.10.	<input type="checkbox"/>
			TCP	192.168.10.	<input type="checkbox"/>
			TCP	192.168.10.	<input type="checkbox"/>
			TCP	192.168.10.	<input type="checkbox"/>
			TCP	192.168.10.	<input type="checkbox"/>
			TCP	192.168.10.	<input type="checkbox"/>
			TCP	192.168.10.	<input type="checkbox"/>
			TCP	192.168.10.	<input type="checkbox"/>

Save Cancel

Port Forwarding Screen

Port Forwarding	
Application	Enter the desired application type.
External Port	Traffic from the Internet using this port number will be sent to the Server. This is normally the same as the Internal Port Number. If it is different, this device will perform a "mapping" or "translation" function, allowing the server to use a different port to the clients.
Internal Port	Enter the port numbers which the Server software is configured to use.
Protocol	Select the protocol (TCP or UDP) used by the Server.
IP Address	Enter the desired IP address.
Enabled	Use this to Enable or Disable support for this Server, as required.

Port Range Forward

This feature allows you to make Servers on your LAN accessible to Internet users. Normally, Internet users would not be able to access a server on your LAN because:

Application	Start	End	Protocol	IP Address	Enable
<input type="text"/>	<input type="text"/>	<input type="text"/>	TCP	192.168.10. <input type="text"/>	<input type="checkbox"/>
<input type="text"/>	<input type="text"/>	<input type="text"/>	TCP	192.168.10. <input type="text"/>	<input type="checkbox"/>
<input type="text"/>	<input type="text"/>	<input type="text"/>	TCP	192.168.10. <input type="text"/>	<input type="checkbox"/>
<input type="text"/>	<input type="text"/>	<input type="text"/>	TCP	192.168.10. <input type="text"/>	<input type="checkbox"/>
<input type="text"/>	<input type="text"/>	<input type="text"/>	TCP	192.168.10. <input type="text"/>	<input type="checkbox"/>
<input type="text"/>	<input type="text"/>	<input type="text"/>	TCP	192.168.10. <input type="text"/>	<input type="checkbox"/>
<input type="text"/>	<input type="text"/>	<input type="text"/>	TCP	192.168.10. <input type="text"/>	<input type="checkbox"/>
<input type="text"/>	<input type="text"/>	<input type="text"/>	TCP	192.168.10. <input type="text"/>	<input type="checkbox"/>
<input type="text"/>	<input type="text"/>	<input type="text"/>	TCP	192.168.10. <input type="text"/>	<input type="checkbox"/>
<input type="text"/>	<input type="text"/>	<input type="text"/>	TCP	192.168.10. <input type="text"/>	<input type="checkbox"/>

Port Range Forwarding Screen

Port Range Forwarding	
Application	Enter the desired application type.
Start	Enter the beginning of the range of port numbers used by the application server.
End	Enter the end of the range of port numbers used by the application server.
Protocol	Select the protocol (TCP, UDP or Both) used by the Server.
IP Address	Enter the desired IP address.
Enable	Use this to Enable or Disable support for this Server, as required.

QoS

The QoS (Quality of Service) feature allows you specify priorities for different traffic. Lower priority traffic will be slowed down to allow greater throughput or less delay for high priority traffic.

An example *QoS* screen is shown below.

QoS Screen

QoS Setting	
QoS Setting	To disable QoS (Quality of Service), keep the default setting, Disable. To enable QoS (Quality of Service), click Enable and follow these instructions.
Management Type	There are 2 options: <ul style="list-style-type: none"> • Rate Control - The QoS will be managed by the size of the bandwidth. • Priority - The QoS will be managed by the priority.
WAN Setting	
DownStream	Enter the desired value for the DownStream Connection.
UpStream	Enter the desired value for the UpStream Connection.
Get from WAN	Click this button to get the values for DownStream and UpStream from WAN.

Category	<ul style="list-style-type: none"> • Applications: • Add a New Application (Once selected, please complete the following setups.) • Ip/Net: Enter the IP addresses. • Rate: Enter the desired rate value. • Priority: Select the desired option (High, Normal, Low) • Direct: Select Upstream or Downstream as required. • Self-Define • Name. Enter a name for your device. • Port Range: Enter the values for the desired port range. • Protocol: Select the desired option. • Ip/Net: Enter the IP addresses of your device. • Rate: Enter the desired rate value. • Priority: Select the option (High, Normal, Low) from the list. • Direct: Select Upstream or Downstream as required.
-----------------	---

Summary	
Priority	The priority of the application.
Name	The Name of this Application or IP Address.
Information	The general Information of this Application or IP Address.

Chapter 6

6

Advanced Administration

This Chapter explains the settings available via the "Administration" section of the menu.

Overview

Normally, it is not necessary to use these screens, or change any settings. These screens and settings are provided to deal with non-standard situations, or to provide additional options for advanced users.

The available settings and features are:

PC Database	This is the list of PCs shown when you select the "DMZ PC" or a "Virtual Server". This database is maintained automatically, but you can add and delete entries for PCs which use a Fixed (Static) IP Address.
Config File	Backup or restore the configuration file for the Wireless ADSL Modem Router. This file contains all the configuration data.
Logs & E-mail	View or clear all logs, set E-Mailing of log files and alerts.
Diagnostics	Perform a Ping or DNS Lookup.
Remote Admin	Allow settings to be changed from the Internet.
Routing	Only required if your LAN has other Routers or Gateways.
Upgrade Firmware	Upgrade the Firmware (software) installed in your Wireless ADSL Modem Router.

PC Database

The PC Database is used whenever you need to select a PC (e.g. for the "DMZ" PC).

- It eliminates the need to enter IP addresses.
- Also, you do not need to use fixed IP addresses on your LAN.

However, if you do use a fixed IP address on some devices on your LAN, you should enter details of each such device into the PC database, using the PC Database screen.

PC Database Screen

An example *PC Database* screen is shown below.

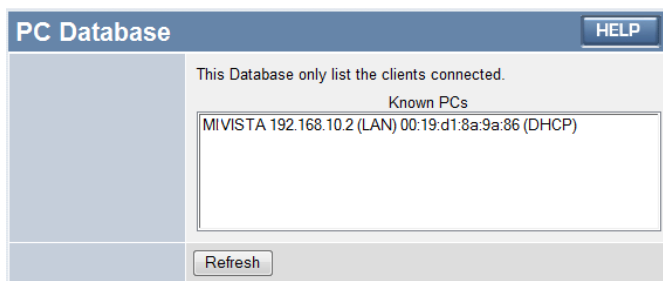

- PCs which are "DHCP Clients" are automatically added to the database, and updated as required.
- The Wireless ADSL Modem Router uses the "Hardware Address" to identify each PC, not the name or IP address. The "Hardware Address" can only change if you change the PC's network card or adapter.

PC Database Screen

Known PCs	This lists all current entries. Data displayed is <i>name (IP Address) type</i> . The "type" indicates whether the PC is connected to the LAN.
Name	If adding a new PC to the list, enter its name here. It is best if this matches the PC's "hostname".
IP Address	Enter the IP Address of the PC. The PC will be sent a "ping" to determine its hardware address. If the PC is not available (not connected, or not powered On) you will not be able to add it.
Buttons	
Refresh	Update the data on screen.

Config File

This feature allows you to download the current settings from the Wireless ADSL Modem Router, and save them to a file on your PC.

You can restore a previously-downloaded configuration file to the Wireless ADSL Modem Router, by uploading it to the Wireless ADSL Modem Router.

This screen also allows you to set the Wireless ADSL Modem Router back to its factory default configuration. Any existing settings will be deleted.

An example *Config File* screen is shown below.

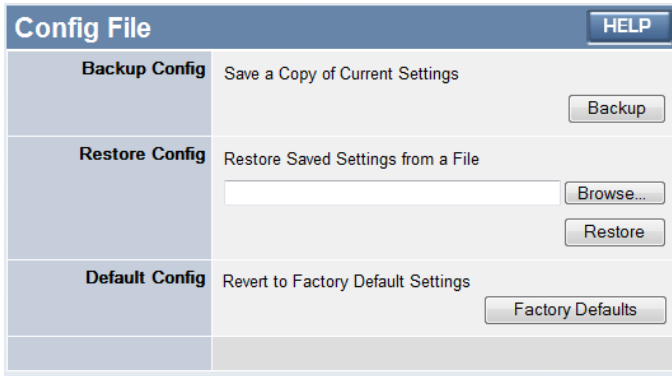

Config File Screen

Backup Config	Use this to download a copy of the current configuration, and store the file on your PC. Click <i>Backup</i> to start the download.
Restore Config	<p>This allows you to restore a previously-saved configuration file back to the Wireless ADSL Modem Router.</p> <p>Click <i>Browse</i> to select the configuration file, then click <i>Restore</i> to upload the configuration file.</p> <p>WARNING!</p> <p>Uploading a configuration file will destroy (overwrite) ALL of the existing settings.</p>
Default Config	<p>Clicking the <i>Factory Defaults</i> button will reset the Wireless ADSL Modem Router to its factory default settings.</p> <p>WARNING!</p> <p>This will delete ALL of the existing settings.</p>

Logs

The Logs record various types of activity on the Wireless ADSL Modem Router. This data is useful for troubleshooting, but enabling all logs will generate a large amount of data and adversely affect performance.

Since only a limited amount of log data can be stored in the Wireless ADSL Modem Router, log data can also be E-mailed to your PC. Use the *E-mail* screen to configure this feature.

Logs HELP

Logs Current time: 2000-01-01 09:38:59

```
[admin login]:client 192.168.10.2 login Sat,
[Router]:Start up Sat, 2000-01-01 08:10:22
[admin logout]:The previous client log Out S
[admin login]:client 192.168.10.2 login Sat,
[admin logout]:The previous client log Out S
[admin login]:client 192.168.10.2 login Sat,
[admin logout]:The previous client log Out S
[admin login]:client 192.168.10.2 login Sat,
[admin logout]:The previous client log Out S
[admin login]:client 192.168.10.2 login Sat,
[admin logout]:The previous client log Out S
[admin login]:client 192.168.10.2 login Sat,
[admin logout]:The previous client log Out S
[admin login]:client 192.168.10.2 login Sat,
```

Refresh Clear Log Send Log

Include in Log

- Attempted access to blocked sites
- Connections to the Web-based interface of this Router
- Router operation (start up, get time etc)
- Known DoS attacks and Port Scans
- Outgoing (Internet) connections
- Access control

Syslog

- Disable
- Broadcast on LAN
- Send to this Syslog Server: . . .

Save Cancel

Logs Screen

Logs	
Current Time	The current time on the Wireless ADSL Modem Router is displayed.
Log Data	Current log data is displayed in this panel.
Buttons	<p>There are three (3) buttons</p> <ul style="list-style-type: none"> • Refresh - Update the log data. • Clear Log - Clear the log, and restart it. This makes new messages easier to read. • Send Log - E-mail the log immediately. This is only functional if the <i>E-mail</i> screen has been configured.

Include in Log	
Include (Checkboxes)	<p>Use these checkboxes to determine which events are included in the log. Checking all options will increase the size of the log, so it is good practice to disable any events which are not really required.</p> <ul style="list-style-type: none"> • Attempted access to blocked sites - If checked, attempted Internet accesses which were blocked are logged. • Connections to the Web-based interface of this Router - If checked, this will log connections TO this Router, rather than through this Router to the Internet. • Router operation - If checked, other Router operations (not covered by the selections above) will be logged. • Known DoS attacks and Port Scans - If checked, Denial of Service attacks, as well as port scans, will be logged.
Syslog	
Disable	Data is not sent to a Syslog Server.
Broadcast on LAN	The Syslog data is broadcast, rather than sent to a specific Syslog server. Use this if your Syslog Server does not have a fixed IP address.
Send to this Syslog Server	If your Syslog server has a fixed IP address, select this option, and enter the IP address of your Syslog server.

E-mail

This screen allows you to E-mail Logs and Alerts. A sample screen is shown below.

E-mail Screen

E-Mail Notification	
Turn E-mail Notification on	Check this box to enable this feature. If enabled, the E-mail address information (below) must be provided.
Send to this E-mail address	Enter the E-mail address the Log is to be sent to.
Outgoing (SMTP) Mail Server	Enter the address or IP address of the SMTP (Simple Mail Transport Protocol) Server you use for outgoing E-mail.
Mail Sender Address	Enter the mail address of the sender. The E-mail will also show this address as the Sender's address.
My SMTP Mail Server requires authentication	To stop spammers, many SMTP mail servers require you to log in to send mail. In this case, enable this checkbox, and enter the login information (User name and Password) in the fields below.
User Name	If you have enabled "My SMTP Mail Server requires authentication" above, enter the User Name required to login to your SMTP Server.
Password	If you have enabled "My SMTP Mail Server requires authentication" above, enter the password required to login to your SMTP Server.

E-mail Alerts

Send E-mail alerts immediately	You can choose to have alerts E-mailed to you, by checking the desired checkboxes. The Broadband ADSL Router can send an immediate alert when it detects a significant security incident such as <ul style="list-style-type: none">• A known hacker attack is directed at your IP address• A computer on the Internet scans your IP address for open ports• Someone on your LAN (Local Area Network) tries to visit a blocked site.
---------------------------------------	---

E-mail Logs

Send Logs	Select the desired option for sending the log by E-mail. <ul style="list-style-type: none">• Never (default) - This feature is disabled; Logs are not sent.• When log is full - The time is not fixed. The log will be sent when the log is full, which will depend on the volume of traffic.• Hourly, Daily, Weekly... - The log is sent on the interval specified.• If Daily is selected, the log is sent at the time specified. Select the time of day you wish the E-mail to be sent.• If Weekly is selected, the log is sent once per week, on the specified day, at the specified time. Select the day and the time of day you wish the E-mail to be sent. <p>Note:</p> If the log is full before the time specified to send it, it will be sent regardless of the day and time specified.
------------------	--

Diagnosics

This screen allows you to perform a "Ping" or a "DNS lookup". These activities can be useful in solving network problems.

An example *Network Diagnostics* screen is shown below.

Network Diagnostics Screen

Ping	
IP Address	Enter the IP address you wish to ping. The IP address can be on your LAN, or on the Internet. Note that if the address is on the Internet, and no connection currently exists, you could get a "Timeout" error. In that case, wait a few seconds and try again.
Ping Button	After entering the IP address, click this button to start the "Ping" procedure. The results will be displayed in the <i>Ping Results</i> pane.
DNS Lookup	
Internet Name	Enter the Domain name or URL for which you want a DNS (Domain Name Server) lookup. Note that if the address is on the Internet, and no connection currently exists, you could get a "Timeout" error. In that case, wait a few seconds and try again.
Lookup Button	After entering the Domain name/URL, click this button to start the "DNS Lookup" procedure.
Routing	
Display	Click this button to display the internal routing table. This information can be used by Technical Support and other staff who understand Routing Tables.

Remote Administration

If enabled, this feature allows you to manage the Wireless ADSL Modem Router via the Internet.

Remote Administration Screen

Remote Administration	
Enable Remote Management	<p>Check to allow administration/management via the Internet. (To connect, see below).</p> <p>If Disabled, this device will ignore Administration connection attempts from the Internet.</p>
Current IP Address	<p>This is the current address you will use when accessing this device from the Internet. To connect, see details and an example below.</p>
Port Number	<p>Enter a port number between 1 and 65535. The default for HTTP (Web) connections is port 80, but using port 80 will prevent the use of a Web "Virtual Server" on your LAN. So using a different port number is recommended. The default value is 8080.</p> <p>The port number must be specified in your Browser when you connect. See the following section for details.</p>
Access Permission	
Allow Remote Access	<p>Select the desired option.</p> <ul style="list-style-type: none"> • Everyone - allow access by everyone on the Internet. • Only This Computer - allow access by only one IP address. Enter the desired IP address. • IP Address Range - allow access from a range of IP addresses on the Internet. Enter a beginning and ending IP address to define the allowed range. <p>For security, you should restrict access to as few external IP addresses as practical.</p>

To connect from a remote PC via the Internet

1. Ensure your Internet connection is established, and start your Web Browser.
2. In the "Address" bar, enter "HTTP://" followed by the Internet IP Address of the Wireless ADSL Modem Router. If the port number is not 80, the port number is also required. (After the IP Address, enter ":" followed by the port number.)

e.g.

`HTTP://123.123.123.123:8080`

This example assumes the WAN IP Address is 123.123.123.123, and the port number is 8080.

3. You will then be prompted for the login name and password for this device.

Routing

Overview

- If you don't have other Routers or Gateways on your LAN, you can ignore the "Routing" page completely.
- If the Wireless ADSL Modem Router is only acting as a Gateway for the local LAN segment, ignore the "Routing" page even if your LAN has other Routers.
- If your LAN has a standard Router (e.g. Cisco) on your LAN, and the Wireless ADSL Modem Router is to act as a Gateway for all LAN segments, enable RIP (Routing Information Protocol) and ignore the Static Routing table.
- If your LAN has other Gateways and Routers, and you wish to control which LAN segments use each Gateway, do NOT enable RIP (Routing Information Protocol). Configure the Static Routing table instead. (You also need to configure the other Routers.)
- If using Windows 2000 Data center Server as a software Router, enable RIP on the Wireless ADSL Modem Router, and ensure the following Windows 2000 settings are correct:
- Open *Routing and Remote Access*
- In the console tree, select *Routing and Remote Access, [server name], IP Routing, RIP*
- In the "Details" pane, right-click the interface you want to configure for RIP version 2, and then click "Properties".
- On the "General" tab, set *Outgoing packet protocol* to "RIP version 2 broadcast", and *Incoming packet protocol* to "RIP version 1 and 2".

Routing Screen

The routing table is accessed by the *Routing* link on the *Administration* menu.

Using this Screen

Generally, you will use either RIP (Routing Information Protocol) OR the Static Routing Table, as explained above, although it is possible to use both methods simultaneously.

Static Routing Table

- If RIP is not used, an entry in the routing table is required for each LAN segment on your Network, other than the segment to which this device is attached.
- The other Routers must also be configured. See *Configuring Other Routers on your LAN* later in this chapter for further details and an example.

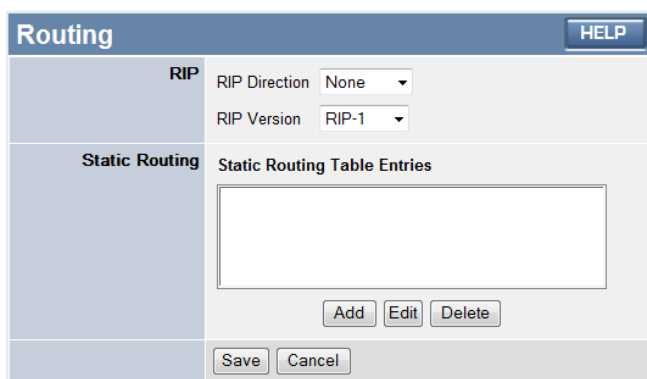

Routing Screen

RIP	
RIP Direction	Select the desired RIP Direction.
RIP Version	Choose the RIP Version for the Server.
Static Routing	
Static Routing Table Entries	<p>This list shows all entries in the Routing Table.</p> <ul style="list-style-type: none"> • This area shows details of the selected item in the list. • Change any the properties as required, then click the "Edit" button to save the changes to the selected entry.
Buttons	
Add	Add a new entry to the Static Routing table, using the data shown in the "Properties" area on screen. The entry selected in the list is ignored, and has no effect.
Edit	Update the current Static Routing Table entry, using the data shown in the table area on screen.
Delete	Delete the current Static Routing Table entry.
Save	Save the RIP setting. This has no effect on the Static Routing Table.

Configuring Other Routers on your LAN

It is essential that all IP packets for devices not on the local LAN be passed to the Wireless ADSL Modem Router, so that they can be forwarded to the external LAN, WAN, or Internet. To achieve this, the local LAN must be configured to use the Wireless ADSL Modem Router as the *Default Route* or *Default Gateway*.

Local Router

The local router is the Router installed on the same LAN segment as the Wireless ADSL Modem Router. This router requires that the *Default Route* is the Wireless ADSL Modem Router itself. Typically, routers have a special entry for the *Default Route*. It should be configured as follows.

Destination IP Address	Normally 0.0.0.0, but check your router documentation.
Network Mask	Normally 0.0.0.0, but check your router documentation.
Gateway IP Address	The IP Address of the Wireless ADSL Modem Router.
Metric	1

Other Routers on the Local LAN

Other routers on the local LAN must use the Wireless ADSL Modem Router's *Local Router* as the *Default Route*. The entries will be the same as the Wireless ADSL Modem Router's local router, with the exception of the *Gateway IP Address*.

- For a router with a direct connection to the Wireless ADSL Modem Router's local Router, the *Gateway IP Address* is the address of the Wireless ADSL Modem Router's local router.
- For routers which must forward packets to another router before reaching the Wireless ADSL Modem Router's local router, the *Gateway IP Address* is the address of the intermediate router.

Static Routing - Example

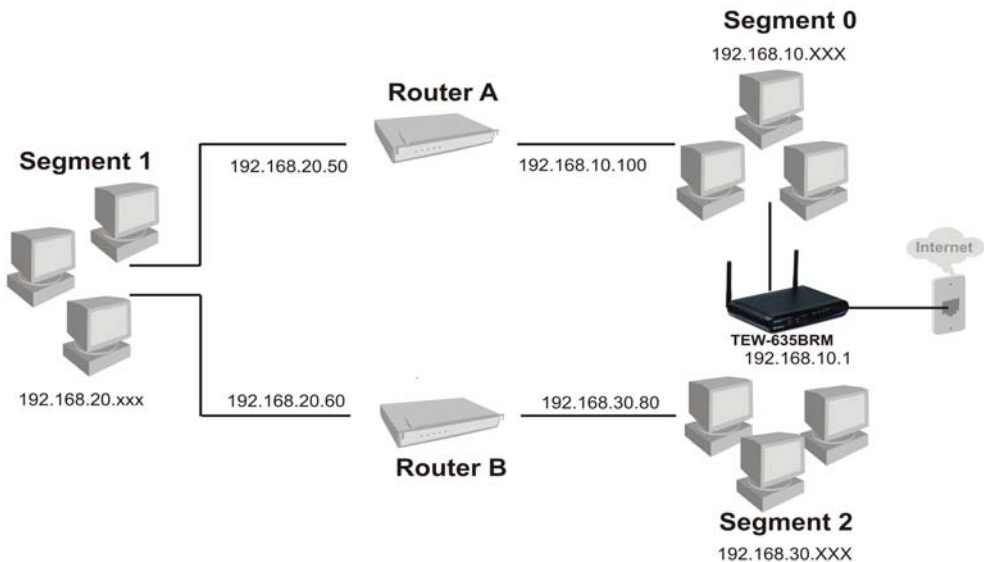

For the Wireless ADSL Modem Router's Routing Table

For the LAN shown above, with 2 routers and 3 LAN segments, the Wireless ADSL Modem Router requires 2 entries as follows.

Entry 1 (Segment 1)	
Destination IP Address	192.168.20.0
Network Mask	255.255.255.0 (Standard Class C)
Gateway IP Address	192.168.10.100 (Wireless ADSL Modem Router's local Router)

Metric	2
Entry 2 (Segment 2)	
Destination IP Address	192.168.30.0
Network Mask	255.255.255.0 (Standard Class C)
Gateway IP Address	192.168.10.100
Metric	3

For Router A's Default Route

Destination IP Address	0.0.0.0
Network Mask	0.0.0.0
Gateway IP Address	192.168.10.1 (Wireless ADSL Modem Router's IP Address)

For Router B's Default Route

Destination IP Address	0.0.0.0
Network Mask	0.0.0.0
Gateway IP Address	192.168.20.50 (Wireless ADSL Modem Router's local router)

Upgrade Firmware

The firmware (software) in the Wireless ADSL Modem Router can be upgraded using your Web Browser.

You must first download the upgrade file, then select *Upgrade Firmware* on the *Administration* menu. You will see a screen like the following.



Upgrade Firmware HELP

Locate and Select the Upgrade File from your Hard Disk:

Browse...

Upload Cancel

To perform the Firmware Upgrade:

1. Click the *Browse* button and navigate to the location of the upgrade file.
2. Select the upgrade file. Its name will appear in the *Upgrade File* field.
3. Click the *Upload* button to commence the firmware upgrade.



The Wireless ADSL Modem Router is unavailable during the upgrade process, and must restart when the upgrade is completed. Any connections to or through the Wireless ADSL Modem Router will be lost.

Chapter 7

7

Modem Mode

This Chapter explains configuration and operation when in Modem Mode (also known as Bridge Mode)

Overview

There are two modes available on the **Mode** screen.

- **Router** - Both the ADSL Modem and the Router features are operational. In this mode, this device can provide shared Internet Access to all your LAN users. Also, by default, it acts a DHCP Server, providing an IP address and related information to all Wireless and LAN users.
- **Modem (Bridge Mode)** - Only the ADSL Modem component is operational. All Router features are disabled. This device is "transparent" - it does not perform any operations or make any changes to the network traffic passing through it. You need to have a DHCP Server on your LAN to provide IP addresses to the Wireless clients using this Access Point.

This Chapter describes operation while in **Modem Mode (Bridge Mode)**

Management Connections

When this device restarts in Modem mode, the IP address does not change, but the DHCP server is disabled. However, your PC will usually retain the IP address provided by the DHCP Server, so the connection will be automatically re-established. You then need to ensure that the IP address of this modem is suitable for your LAN.

- You need to have a DHCP Server on your LAN to provide IP addresses to the Wireless clients using this Access Point.
- This Modem/AP must be a valid device on your LAN, to allow management connections. You must assign a (fixed) IP address which is within the address range used on your LAN, but not within the address range used by your DHCP server.

When you connect in future, just connect normally, using the IP address you assigned.

1. Start your WEB browser.
2. In the *Address* box, enter "HTTP://" and the current IP Address of the Wireless ADSL Modem, as in this example, which uses the Wireless ADSL Modem's default IP Address:
`HTTP://192.168.10.1`
3. When prompted for the User name and Password, enter `admin` for the user name, and `password` for the password. (The password is the same regardless of the mode setting.)

Modem Mode Main Screen

In the **Device Mode** drop down menu, select *Modem(Modem only)* and click “Save”.

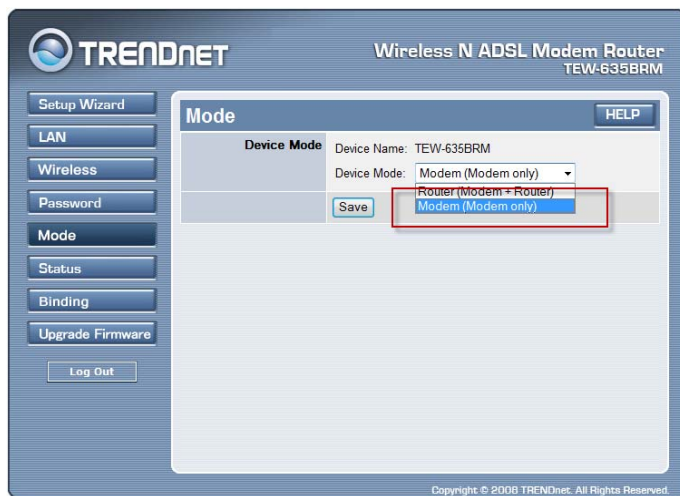

The main screen will look like the example below.



Note:

When choosing Modem Mode, some of the Router options will not be available for Modem mode. The detail information is shown below.

- **LAN** – Allows user to set IP address and submask

LAN - Bridge Mode		HELP
TCP/IP	IP Address:	192 . 168 . 10 . 1
	Subnet Mask:	255 . 255 . 255 . 0
		Save Cancel

- **Wireless** – the wireless feature is same as the Router mode.

Wireless		HELP
Region	Region:	--- Select Region ---
Multi SSID	SSID :	TRENDnet635
	<input checked="" type="checkbox"/> SSID1 (Service Set Identifier)	TRENDnet635
	<input checked="" type="checkbox"/> Broadcast SSID	
	<input type="checkbox"/> Isolation Within SSID	
Security Setting:		SSID1 :Disabled Configure SSID1
Options	802.11 Mode:	11b/g/n(20MHz)
	Channel NO.	11
	Extension Channel.	UP
	<input checked="" type="checkbox"/> WMM support	
Access Point	Allow access by:	<input checked="" type="radio"/> ALL Wireless stations <input type="radio"/> Trusted Wireless stations only Set Stations
WiFi Protect Setup	<input checked="" type="checkbox"/> Enable WPS	
	AP PIN Code:	78995864 Regenerate
	Join Wireless Client	Input Client PIN Code: <input type="text"/> OK
WDS Setup	<input type="checkbox"/> Enable WDS	
	MAC Address List	
	AP 1:	<input type="text"/>
	AP 2:	<input type="text"/>
	AP 3:	<input type="text"/>
	AP 4:	<input type="text"/>
		Save Cancel

- **Password** – the password feature is same as Router mode.

Password		HELP
The password protects the configuration data. Once set (recommended), you will be prompted for the password when you connect.		
Old Password	<input type="text"/>	
New password:	<input type="text"/>	
Verify password:	<input type="text"/>	
		Save Cancel

- **Mode** - this mode feature allows user to changed the mode setting back to Router Mode.

Mode		HELP
Device Name	Device Name: TEW-635BRM	
Device Mode	Device Mode: Modem (Modem only) ▼	
		Save

Mode Function

Device Name	This field displays the current name of this device.
Device Mode	<p>Select the desired device mode for the router:</p> <ul style="list-style-type: none"> • Router - Both the ADSL Modem and the Router features are operational. In this mode, this device can provide shared Internet Access to all your LAN users. Also, by default, it acts a DHCP Server, providing an IP address and related information to all Wireless and LAN users. • Modem - Only the ADSL Modem component is operational. All Router features are disabled. This device is "transparent" - it does not perform any operations or make any changes to the network traffic passing through it. You need to have a DHCP Server on your LAN to provide IP addresses to the Wireless clients using this Access Point. This mode is also called Bridge Mode. <p>After changing the mode, this device will restart, which will take a few seconds. The menu will also change, depending on the mode you are in.</p>

- **Status** - displays current settings and status. See the following section for details.

Status		HELP
ADSL	Modem Status	Connected
	DownStream Connection Speed	384 kbps
	UpStream Connection Speed	384 kbps
		ADSL Details
LAN	IP Address:	192.168.10.1
	Network Mask:	255.255.255.0
	MAC Address	02:00:02:55:07:50
Wireless	SSID1	TRENDnet635
	MAC Address	02:00:02:55:07:50
	SSID2	Guest
	MAC Address	02:00:02:55:07:50
	Region	--
	Channel	11
	Wireless AP	enable
	Broadcast Name	enable
System	Device Name:	TEW-635BRM
	Firmware Version:	1.00.03
		Refresh Screen Attached Devices

Status Function

ADSL	
Modem Status	This indicates the status of the ADSL modem component.
DownStream Connection Speed	Displays the speed for the DownStream Connection.
UpStream Connection Speed	If connected, displays the speed for the Up Stream (upload) ADSL Connection.
ADSL Details	Click this button to open a sub-window and view the details of each VC (Virtual Circuit).
LAN	
IP Address	The IP Address of the Wireless ADSL Modem Router.
Network Mask	The Network Mask (Subnet Mask) for the IP Address above.
MAC Address	This shows the MAC Address for the Wireless ADSL Modem Router, as seen on the LAN interface.
Wireless	
SSID 1/ SSID 2	If using an ESS (Extended Service Set, with multiple access points) this ID is called an ESSID (Extended Service Set Identifier).
Region	The current region, as set on the Wireless screen.
Channel	This shows the Channel currently used, as set on the Wireless screen.
Wireless AP	This indicates whether or not the Wireless Access Point feature is enabled.
Broadcast Name	This indicates whether or not the SSID is Broadcast. This setting is on the Wireless screen.
System	
Device Name	The current name of the Router. This name is also the "hostname" for users with an "@Home" type connection.
Firmware Version	The version of the current firmware installed.
Buttons	
ADSL Details	View the details of each VC (Virtual Circuit).
Attached Devices	This will open a sub-window, showing all LAN and Wireless devices currently on the network.
Refresh Screen	Update the data displayed on screen.

- **Binding** - this function is same as Router mode.

Binding				HELP
LAN Ports	Port 0	VC1	VPI/VC: 0/35	Type: Bridge
	Port 1	VC1	VPI/VC: 0/35	Type: Bridge
	Port 2	VC1	VPI/VC: 0/35	Type: Bridge
	Port 3	VC1	VPI/VC: 0/35	Type: Bridge
WLAN	TRENDnet635	VC1	VPI/VC: 0/35	Type: Bridge
	Guest	VC1	VPI/VC: 0/35	Type: Bridge
Group	<input type="checkbox"/> VC2 <input type="checkbox"/> VC3 <input type="checkbox"/> VC4 <input type="checkbox"/> VC5 <input type="checkbox"/> VC6 <input type="checkbox"/> VC7 <input type="checkbox"/> VC8			
		<input type="button" value="Save"/> <input type="button" value="Cancel"/>		

- **Upgrade Firmware** - this function is same as Router mode.

Upgrade Firmware		HELP
Locate and Select the Upgrade File from your Hard Disk:		
<input type="text"/>	<input type="button" value="Browse..."/>	
<input type="button" value="Upload"/> <input type="button" value="Cancel"/>		

Operation

Operation is automatic and transparent.

- Wireless clients can connect to the Access Point if they have the correct SSID and security, but they must obtain an IP address from the DHCP Server on your LAN.
- The modem will act like any other ADSL modem. No routing will be performed, and no client login will be done. If a client login is required, it must be performed by your Router/Gateway or by software on your PC.

Appendix A

Troubleshooting



This Appendix covers the most likely problems and their solutions.

Overview

This chapter covers some common problems that may be encountered while using the Wireless ADSL Modem Router and some possible solutions to them. If you follow the suggested steps and the Wireless ADSL Modem Router still does not function properly, contact your dealer for further advice.

General Problems

Problem 1: Can't connect to the Wireless ADSL Modem Router to configure it.

Solution 1: Check the following:

- The Wireless ADSL Modem Router is properly installed, LAN connections are OK, and it is powered ON.
- Ensure that your PC and the Wireless ADSL Modem Router are on the same network segment. (If you don't have a router, this must be the case.)
- If your PC is set to "Obtain an IP Address automatically" (DHCP client), restart it.
- If your PC uses a Fixed (Static) IP address, ensure that it is using an IP Address within the range 192.168.10.2 to 192.168.10.254 and thus compatible with the Wireless ADSL Modem Router's default IP Address of 192.168.10.1.

Also, the Network Mask should be set to 255.255.255.0 to match the Wireless ADSL Modem Router.

In Windows, you can check these settings by using *Control Panel-Network* to check the *Properties* for the TCP/IP protocol.

Internet Access

Problem 1: When I enter a URL or IP address I get a time out error.

Solution 1: A number of things could be causing this. Try the following troubleshooting steps.

- Check if other PCs work. If they do, ensure that your PCs IP settings are correct. If using a Fixed (Static) IP Address, check the Network Mask, Default gateway and DNS as well as the IP Address.
- If the PCs are configured correctly, but still not working, check the Wireless ADSL Modem Router. Ensure that it is connected and ON. Connect to it and check its settings. (If you can't connect to it, check the

LAN and power connections.)

- Check the Wireless ADSL Modem Router's status screen to see if it is working correctly.

Problem 2: **Some applications do not run properly when using the Wireless ADSL Modem Router.**

Solution 2: The Wireless ADSL Modem Router processes the data passing through it, so it is not transparent.

For incoming connections, you must use the Virtual Server or Firewall Rules to specify the PC which will receive the incoming traffic.

You can also use the *DMZ* function. This should work with almost every application, but:

- It is a security risk, since the firewall is disabled.
- Only one (1) PC can use this feature.

Wireless Access

Problem 1: **My PC can't locate the Wireless Access Point.**

Solution 1: Check the following.

- Your PC is set to *Infrastructure Mode*. (Access Points are always in *Infrastructure Mode*)
- The SSID on your PC and the Wireless Access Point are the same. Remember that the SSID is case-sensitive. So, for example "Workgroup" does NOT match "workgroup".
- Both your PC and the Wireless ADSL Modem Router must have the same setting for WEP. The default setting for the Wireless ADSL Modem Router is disabled, so your wireless station should also have WEP disabled.
- If WEP is enabled on the Wireless ADSL Modem Router, your PC must have WEP enabled, and the key must match.
- If the Wireless ADSL Modem Router's *Wireless* screen is set to *Allow Trusted PCs only*, then each of your Wireless stations must have been designated as "Trusted", or the Wireless station will be blocked.
- To see if radio interference is causing a problem, see if connection is possible when close to the Wireless ADSL Modem Router. Remember that the connection range can be as little as 100 feet in poor environments.

Problem 2: **Wireless connection speed is very slow.**

Solution 2: The wireless system will connect at the highest possible speed, depending on the distance and the environment. To obtain the highest possible connection speed, you can experiment with the following:

- Wireless ADSL Modem Router location.
Try adjusting the location and orientation of the Wireless ADSL Modem Router.
- Wireless Channel
If interference is the problem, changing to another channel may show a

marked improvement.

- **Radio Interference**

Other devices may be causing interference. You can experiment by switching other devices Off, and see if this helps. Any "noisy" devices should be shielded or relocated.

- **RF Shielding**

Your environment may tend to block transmission between the wireless stations. This will mean high access speed is only possible when close to the Wireless ADSL Modem Router.

Appendix B

About Wireless LANs

This Appendix provides some background information about using Wireless LANs (WLANs).

Modes

Wireless LANs can work in either of two (2) modes:

- Ad-hoc
- Infrastructure

Ad-hoc Mode

Ad-hoc mode does not require an Access Point or a wired (Ethernet) LAN. Wireless Stations (e.g. notebook PCs with wireless cards) communicate directly with each other.

Infrastructure Mode

In Infrastructure Mode, one or more Access Points are used to connect Wireless Stations (e.g. Notebook PCs with wireless cards) to a wired (Ethernet) LAN. The Wireless Stations can then access all LAN resources.



Access Points can only function in "Infrastructure" mode, and can communicate only with Wireless Stations which are set to "Infrastructure" mode.

BSS/ESS

BSS

A group of Wireless Stations and a single Access Point, all using the same ID (SSID), form a Basic Service Set (BSS).

Using the same SSID is essential. Devices with different SSIDs are unable to communicate with each other.

ESS

A group of Wireless Stations, and multiple Access Points, all using the same ID (ESSID), form an Extended Service Set (ESS).

Different Access Points within an ESS can use different Channels. In fact, to reduce interference, it is recommended that adjacent Access Points **SHOULD** use different channels.

As Wireless Stations are physically moved through the area covered by an ESS, they will automatically change to the Access Point which has the least interference or best performance. This capability is called **Roaming**. (Access Points do not have or require Roaming capabilities.)

Channels

The Wireless Channel sets the radio frequency used for communication.

- Access Points use a fixed Channel. You can select the Channel used. This allows you to choose a Channel which provides the least interference and best performance. In the USA and Canada, 11 channels are available. If using multiple Access Points, it is better if adjacent Access Points use different Channels to reduce interference.
- In "Infrastructure" mode, Wireless Stations normally scan all Channels, looking for an Access Point. If more than one Access Point can be used, the one with the strongest signal is used. (This can only happen within an ESS.)
- If using "Ad-hoc" mode (no Access Point), all Wireless stations should be set to use the same Channel. However, most Wireless stations will still scan all Channels to see if there is an existing "Ad-hoc" group they can join.

WEP

WEP (Wired Equivalent Privacy) is a standard for encrypting data before it is transmitted.

This is desirable because it is impossible to prevent snoopers from receiving any data which is transmitted by your Wireless Stations. But if the data is encrypted, then it is meaningless unless the receiver can decrypt it.

If WEP is used, the Wireless Stations and the Access Point must have the same settings for each of the following:

WEP	Off, 64 Bit, 128 Bit
Key	For 64 Bit encryption, the Key value must match. For 128 Bit encryption, the Key value must match
WEP Authentication	Open System or Shared Key.

WPA-PSK

WPA-PSK is another standard for encrypting data before it is transmitted. This is a later standard than WEP (Wired Equivalent Privacy), and provides greater security for your data. Data is encrypted using a 256Bit key which is automatically generated and changed often.

If all your Wireless stations support WPA-PSK, you should use this instead of WEP.

If WPA-PSK is used, the Wireless Stations and the Access Point must have the same settings for each of the following:

WPA PSK (Pre-shared Key)	Enter the same value on every station and the AP. The PSK must be from 8 to 63 characters in length. The 256Bit key used for the actual encryption is derived from this key.
-------------------------------------	--

Encryption	The same encryption method must be used. The most common encryption method is TKIP. Another widely-supported method is AES.
-------------------	---

WPA2-PSK

This is a later version of WPA (WPA-PSK). The major change is the use of AES (Advanced Encryption System) for protecting data. AES is very secure, considered to be unbreakable. The PSK (Pre-shared Key) must be entered on each Wireless station.

If WPA2-PSK is used, the Wireless Stations and the Access Point must have the same settings for each of the following:

WPA2 PSK (Pre-shared Key)	Enter the same value on every station and the AP. The PSK must be from 8 to 63 characters in length. The 256Bit key used for the actual encryption is derived from this key.
Encryption	The same encryption method must be used. The most common encryption method is TKIP. Another widely-supported method is AES.

WPA-802.1x

This version of WPA requires a Radius Server on your LAN to provide the client authentication according to the 802.1x standard. Data transmissions are encrypted using the WPA standard.

If this option is used:

- The Access Point must have a "client login" on the Radius Server.
- Each user must have a "user login" on the Radius Server.
- Each user's wireless client must support 802.1x and provide the login data when required.

All data transmission is encrypted using the WPA standard. Keys are automatically generated, so no key input is required.

Wireless LAN Configuration

To allow Wireless Stations to use the Access Point, the Wireless Stations and the Access Point must use the same settings, as follows:

Mode	On client Wireless Stations, the mode must be set to "Infrastructure". (The Access Point is always in "Infrastructure" mode.)
SSID (ESSID)	Wireless Stations should use the same SSID (ESSID) as the Access Point they wish to connect to. Alternatively, the SSID can be set to "any" or null (blank) to allow connection to any Access Point.
Wireless Security	The Wireless Stations and the Access Point must use the same settings for Wireless security. (None, WEP, WPA-PSK, WPA2-PSK, WPA-802.1x).

Appendix C



Specifications

Multi-Function Wireless ADSL Modem Router

Model	TEW-635BRM 300Mbps Wireless ADSL2/2+ Modem Router
ADSL Standard	ADSL : ANSI T1.413 and multi-mode, ITU G.992.1 (G.dmt) Annex A, ITU G.992.2 G.lite, ITU G.992.3 Annex A ADSL2, ITU G.992.3 Annex A DELT, ITU G.992.3 Annex L READSL2, ITU G.992.5 Annex A ADSL2+, ITU G.994.1 (G.hs) ver.3
Dimensions	175 x 130 x 30mm
Operating Temperature	0° C to 40° C
Storage Temperature	-20° C to 70° C
Network Protocol:	TCP/IP
Network Interface:	4 * 10/100BaseT (RJ45) LAN connection 1 * RJ11 for ADSL line
LEDs	15
Power Adapter	12VDC 1A External

Wireless Interface

Standards	IEEE802.11b, IEEE802.11g, 802.11n Draft
Frequency	2.412 to 2.4835GHz (Industrial Scientific Medical Band)
Channels	1 ~ 14 Channel (Universal Domain Selection)
Modulation	CCK, DQPSK, DBPSK, BPSK, QPSK, 16-QAM, 64-QAM, OFDM
Data Rate	Up to 300Mbps (802.11n Draft)
Security	WEP 64Bit, 128Bit, WPA-PSK, WPA2-PSK, WPA-802.1X, WPS Button Support, MAC address checking
Output Power	802.11b: 17dBm \pm 1.5 (typical) 802.11g: 15dBm \pm 1.5 (typical) 802.11n: 12.5dBm \pm 1.5 (typical)
Receiver Sensitivity	802.11b: -86 \pm 1.5 dBm (typical) 802.11g: -70 \pm 1.5 dBm (typical) 802.11n: -69 \pm 1.5 dBm (typical)

Regulatory Approvals

FCC Statement

This equipment has been tested and found to comply with the limits for a Class B digital device, pursuant to Part 15 of the FCC Rules. These limits are designed to provide reasonable protection against harmful interference in a residential installation.

This equipment generates, uses and can radiate radio frequency energy and, if not installed and used in accordance with the instructions, may cause harmful interference to radio communications. However, there is no guarantee that interference will not occur in a particular installation. If this equipment does cause harmful interference to radio or television reception, which can be determined by turning the equipment off and on, the user is encouraged to try to correct the interference by one of the following measures:

- Reorient or relocate the receiving antenna.
- Increase the separation between the equipment and receiver.
- Connect the equipment into an outlet on a circuit different from that to which the receiver is connected.
- Consult the dealer or an experienced radio/TV technician for help.

To assure continued compliance, any changes or modifications not expressly approved by the party responsible for compliance could void the user's authority to operate this equipment. (Example - use only shielded interface cables when connecting to computer or peripheral devices).

FCC Radiation Exposure Statement

This equipment complies with FCC RF radiation exposure limits set forth for an uncontrolled environment. This equipment should be installed and operated with a minimum distance of 20 centimeters between the radiator and your body.

This device complies with Part 15 of the FCC Rules. Operation is subject to the following two conditions:

- (1) This device may not cause harmful interference, and
- (2) This device must accept any interference received, including interference that may cause undesired operation.

This transmitter must not be co-located or operating in conjunction with any other antenna or transmitter.

CE Approval

CE Standards

This product complies with the 99/5/EEC directives, including the following safety and EMC standards:

- EN300328-2
- EN301489-1/-17
- EN60950

Limited Warranty

TRENDnet warrants its products against defects in material and workmanship, under normal use and service, for the following lengths of time from the date of purchase.

TEW-635BRM – 3 Years Limited Warranty

If a product does not operate as warranted above during the applicable warranty period, TRENDnet shall, at its option and expense, repair the defective product or part, deliver to customer an equivalent product or part to replace the defective item, or refund to customer the purchase price paid for the defective product. All products that are replaced will become the property of TRENDnet. Replacement products may be new or reconditioned.

TRENDnet shall not be responsible for any software, firmware, information, or memory data of customer contained in, stored on, or integrated with any products returned to TRENDnet pursuant to any warranty.

There are no user serviceable parts inside the product. Do not remove or attempt to service the product by any unauthorized service center. This warranty is voided if (i) the product has been modified or repaired by any unauthorized service center, (ii) the product was subject to accident, abuse, or improper use (iii) the product was subject to conditions more severe than those specified in the manual.

Warranty service may be obtained by contacting TRENDnet office within the applicable warranty period for a Return Material Authorization (RMA) number, accompanied by a copy of the dated proof of the purchase. Products returned to TRENDnet must be pre-authorized by TRENDnet with RMA number marked on the outside of the package, and sent prepaid, insured and packaged appropriately for safe shipment.

WARRANTIES EXCLUSIVE: IF THE TRENDNET PRODUCT DOES NOT OPERATE AS WARRANTED ABOVE, THE CUSTOMER'S SOLE REMEDY SHALL BE, AT TRENDNET'S OPTION, REPAIR OR REPLACEMENT. THE FOREGOING WARRANTIES AND REMEDIES ARE EXCLUSIVE AND ARE IN LIEU OF ALL OTHER WARRANTIES, EXPRESSED OR IMPLIED, EITHER IN FACT OR BY OPERATION OF LAW, STATUTORY OR OTHERWISE, INCLUDING WARRANTIES OF MERCHANTABILITY AND FITNESS FOR A PARTICULAR PURPOSE. TRENDNET NEITHER ASSUMES NOR AUTHORIZES ANY OTHER PERSON TO ASSUME FOR IT ANY OTHER LIABILITY IN CONNECTION WITH THE SALE, INSTALLATION MAINTENANCE OR USE OF TRENDNET'S PRODUCTS.

TRENDNET SHALL NOT BE LIABLE UNDER THIS WARRANTY IF ITS TESTING AND EXAMINATION DISCLOSE THAT THE ALLEGED DEFECT IN THE PRODUCT DOES NOT EXIST OR WAS CAUSED BY CUSTOMER'S OR ANY THIRD PERSON'S MISUSE, NEGLIGENCE, IMPROPER INSTALLATION OR TESTING, UNAUTHORIZED ATTEMPTS TO REPAIR OR MODIFY, OR ANY OTHER CAUSE BEYOND THE RANGE OF THE INTENDED USE, OR BY ACCIDENT, FIRE, LIGHTNING, OR OTHER HAZARD.

LIMITATION OF LIABILITY: TO THE FULL EXTENT ALLOWED BY LAW TRENDNET ALSO EXCLUDES FOR ITSELF AND ITS SUPPLIERS ANY LIABILITY, WHETHER BASED IN CONTRACT OR TORT (INCLUDING NEGLIGENCE), FOR INCIDENTAL, CONSEQUENTIAL, INDIRECT, SPECIAL, OR PUNITIVE DAMAGES OF ANY KIND, OR FOR LOSS OF REVENUE OR PROFITS, LOSS OF BUSINESS, LOSS OF INFORMATION OR DATE, OR OTHER FINANCIAL LOSS ARISING OUT OF OR IN CONNECTION WITH THE SALE, INSTALLATION, MAINTENANCE, USE, PERFORMANCE, FAILURE, OR INTERRUPTION OF THE POSSIBILITY OF SUCH DAMAGES, AND LIMITS ITS LIABILITY TO REPAIR, REPLACEMENT, OR REFUND OF THE PURCHASE PRICE PAID, AT TRENDNET'S OPTION. THIS DISCLAIMER OF LIABILITY FOR DAMAGES WILL NOT BE AFFECTED IF ANY REMEDY PROVIDED HEREIN SHALL FAIL OF ITS ESSENTIAL PURPOSE.

Governing Law: This Limited Warranty shall be governed by the laws of the state of California.

AC/DC Power Adapter, Cable, Cooling Fan, and Power Supply carry 1 year warranty.



TRENDnet®

Product Warranty Registration

Please take a moment to register your product online.
Go to TRENDnet's website at <http://www.trendnet.com/register>

TRENDnet®

20675 Manhattan Place
Torrance, CA 90501
USA