

User's Guide

**TRENDNET**<sup>®</sup>



**Micro N150 Wireless USB Adapter**

**TEW-648UBM**

## Contents

- Product Overview ..... 1**
  - Package Contents.....1
  - Features.....1
- Installing your Wireless Adapter ..... 2**
  - Windows® OS Installation .....2
  - Mac® OS Installation .....6
- Connect to your wireless network using WPS ..... 11**
  - Windows® OS.....11
    - WPS connection using the built in utility (Virtual Push Button) .....11
  - Mac® OS .....12
    - WPS connection using the built in utility (Virtual Push Button) .....12
- Technical Specifications ..... 14**
- Troubleshooting ..... 15**
- Appendix ..... 16**

## Product Overview



**TEW-648UBM**

## Package Contents

The package includes:

- TEW-648UBM Micro N150 Wireless USB Adapter
- CD-ROM (Drivers and User's Guide)
- Quick Installation Guide

If any package contents are missing or damaged, please contact the retail store, online retailer, or reseller/distributor that the item was purchased.

## Features

TRENDnet's Micro N150 Wireless USB Adapter, model TEW-648UBM, connects a laptop or desktop computer to a high-speed WiFi N network. Seamlessly stream video, download files, and play games with this ultra-compact wireless n adapter. WiFi Multimedia Quality of Service prioritizes important video, audio, and gaming traffic.

## Easy Setup

Get up and running in minutes with the intuitive guided setup

## N150 WiFi

Connect your laptop or computer to high-speed WiFi N150 to download files, play games, stream video, and more.

## Wireless Encryption

Supports up to WPA2 encryption

## Ultra-Compact Design

Micro design length is just over a quarter inch (7mm)

## Operating Systems

Compatible with Windows® and Mac® operating systems

## Installing your Wireless Adapter

This section describes how to install the software driver for the wireless adapter.

### Windows® OS Installation

Supported operating systems: Windows® 10, 8.1, 8, 7, Vista, XP

For any updates, please check the TRENDnet website [www.trendnet.com](http://www.trendnet.com).

1. Insert the included CD-ROM into your computer's CD-ROM drive.

**Note:** If you do not have the included CD-ROM, you can download the drivers from <http://www.trendnet.com/support/>.



2. At the CD Autorun Prompt window, click *Run Autorun.exe*.

**Note:** If the Autorun prompt does not appear automatically, open the CD contents and double-click *Autorun.exe*.

At the CD-ROM main menu, click **Install Drivers**.



Note: During the installation, you might see these warning message, please select continue anyway to install the software.

(Windows 10)

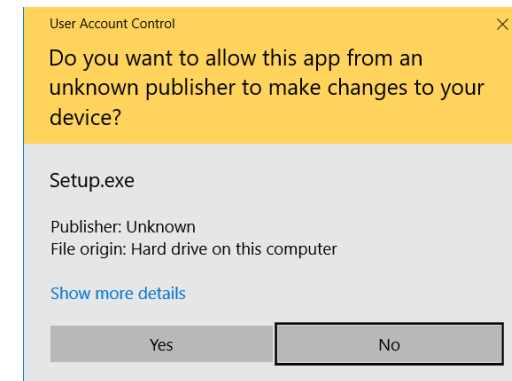

3. Select a language preference from the options provided.

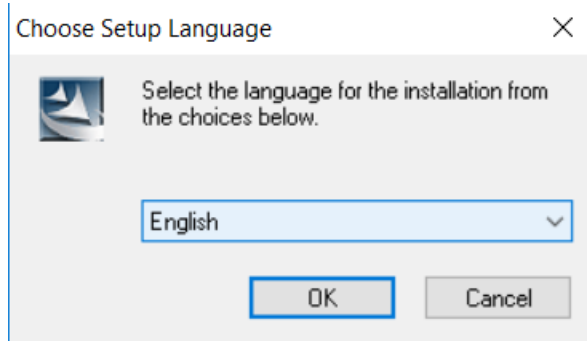

4. Follow the InstallShield Wizard Instructions.



5. You will be prompted to accept the end user license agreement. Select **I accept the terms of the license agreement** and click **Next**.

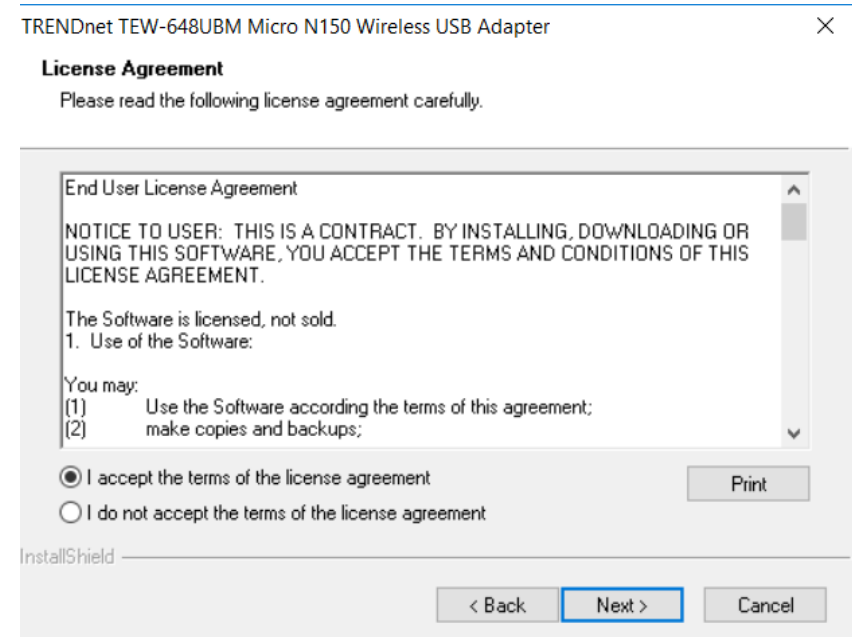

6. Wait for the driver installation to complete. This may take a few minutes.

**Note:** If you do not receive a security prompt, continue to the next step. If prompted, click **Install this driver software anyway**.



- Click Finish to restart the computer.

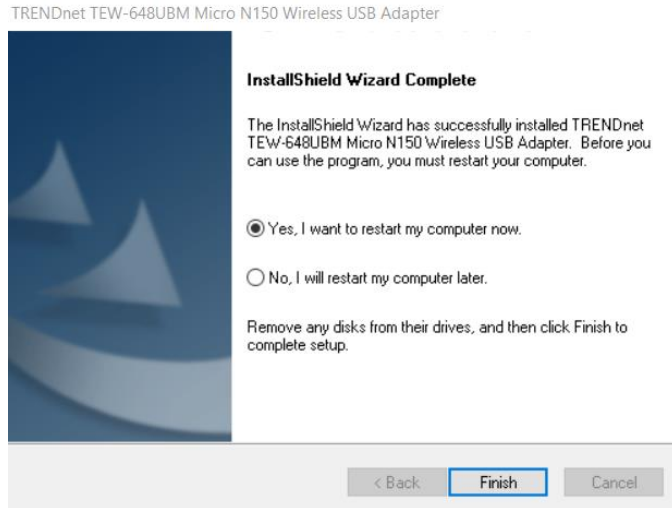

- After the computer is rebooted, plug the Wireless N USB Adapter into an available USB slot on your computer.

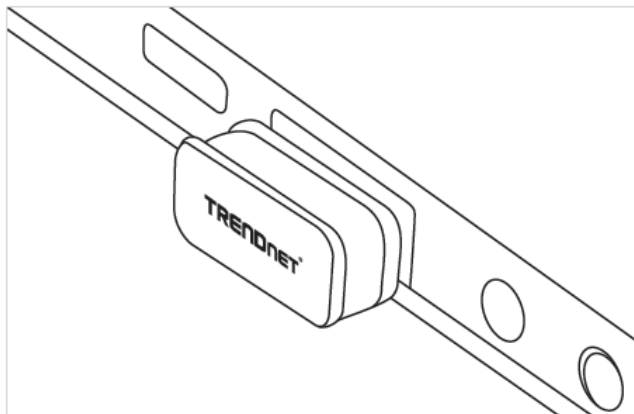

**Link/Activity LED**

Blinking On	:	A steady blinking LED means that the network adapter has been successfully installed.
Fast Blinking	:	When the LED is blinking fast, the network adapter is transmitting or receiving data.
Off	:	When the LED is off, the network adapter has not been correctly installed.

- Click on the wireless icon in the taskbar located in the bottom right corner.



10. Click on the wireless network you would like to connect and click **Connect**.

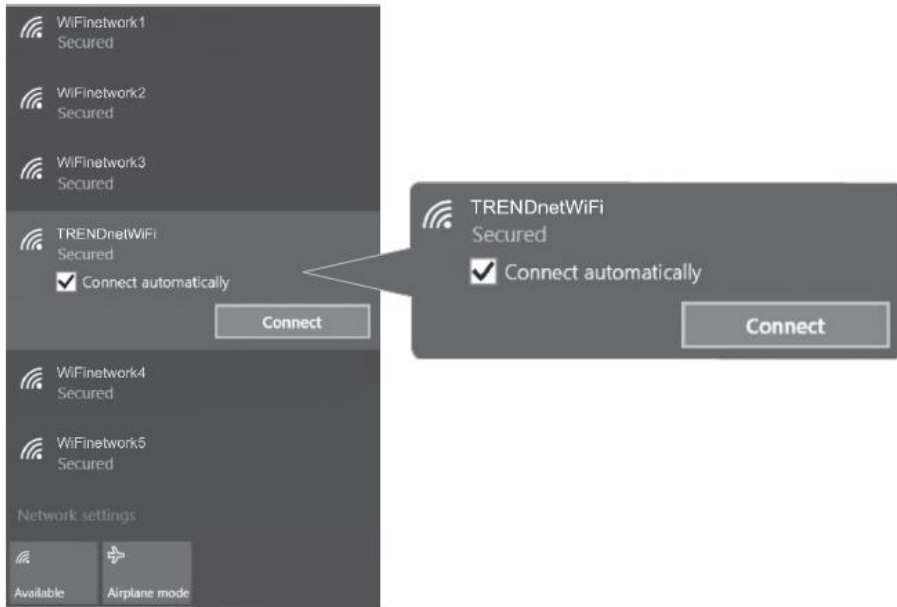

11. Enter the WiFi Key (password) and click **Next**.

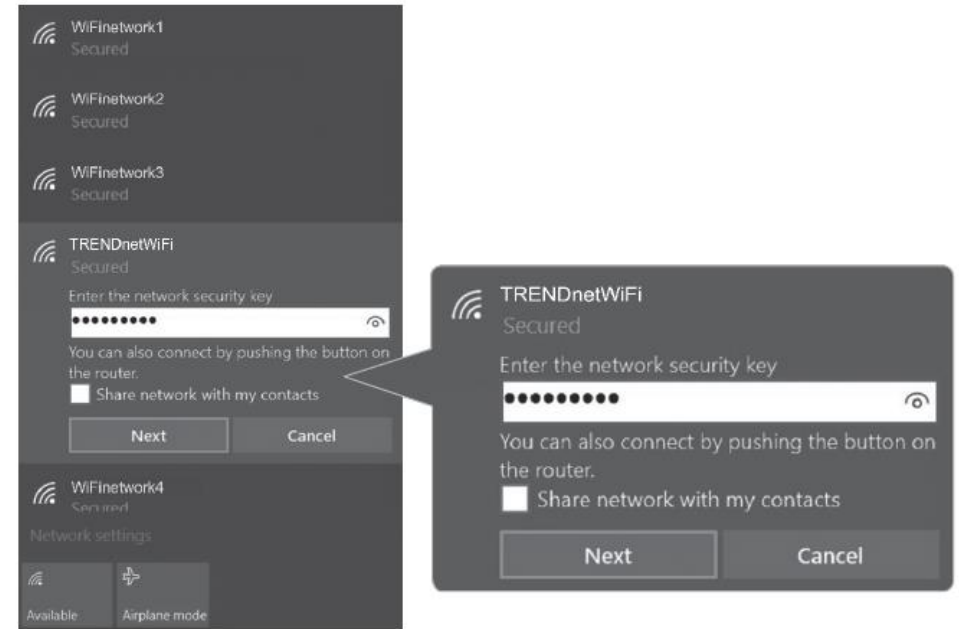

12. The status will display "Connected" to indicate a successful connection.

**Note:** If the connected message does not display, double check your WiFi key (password) and re-enter it.

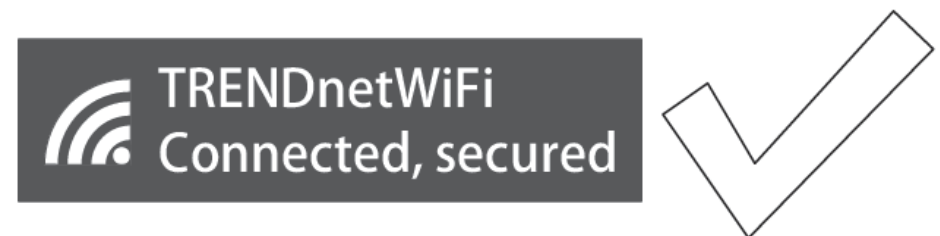

## Mac® OS Installation

Supported operating systems: Mac® OS 10.7-10.12

For any updates, please check the TRENDnet website [www.trendnet.com](http://www.trendnet.com).

1. Insert the included CD-ROM into your computer's CD-ROM drive.

**Note:** If you do not have the included CD-ROM, you can download the utility and drivers from <http://www.trendnet.com/support/>



2. Open the folder named "Mac" on the included Utility and Driver CD ROM.

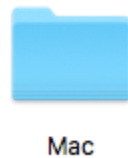

3. Open the folder according to the Mac® OS version you are running. For Mac® OS 10.7-10.12, the folder will be named "Mac OS 10.7-10.12".



Mac OS 10.6-10.11

4. Double click the **Installer.pkg** file to start the installation.



Installer.pkg



Uninstall.pkg



5. At the Introduction window, click **Continue**.

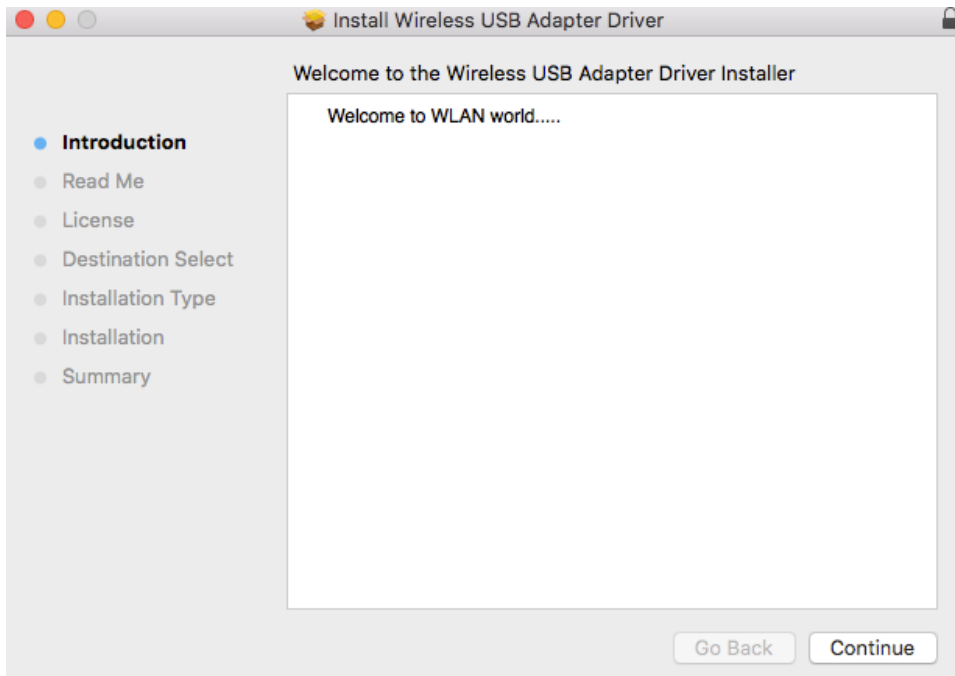

6. At the Read Me window, click **Continue**.

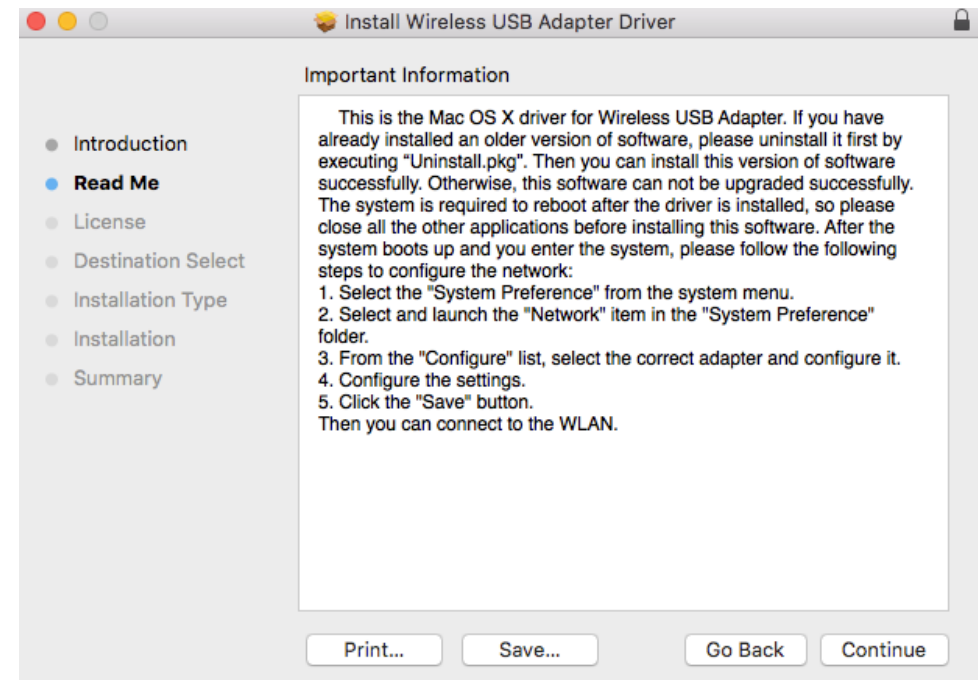

7. At the License Agreement window, click **Continue**.

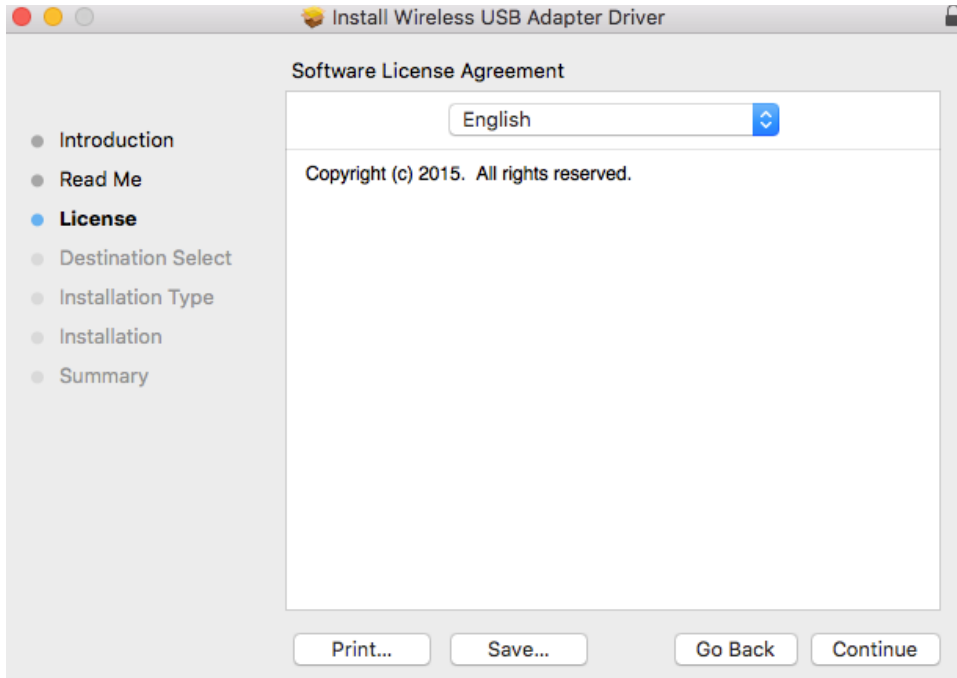

8. When prompted, click **Agree**.

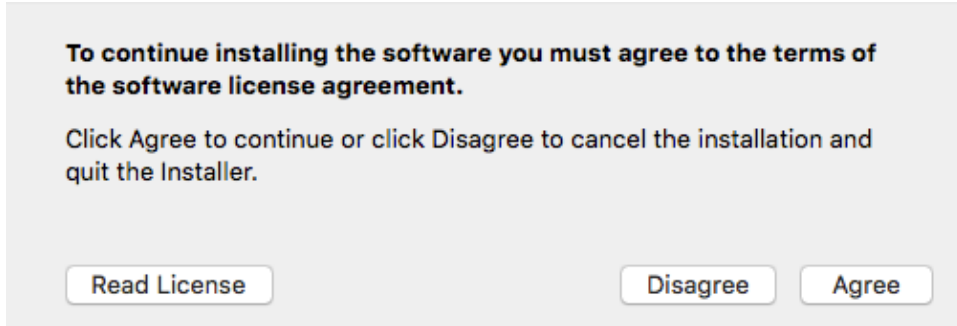

9. At the Install window, click **Install**.

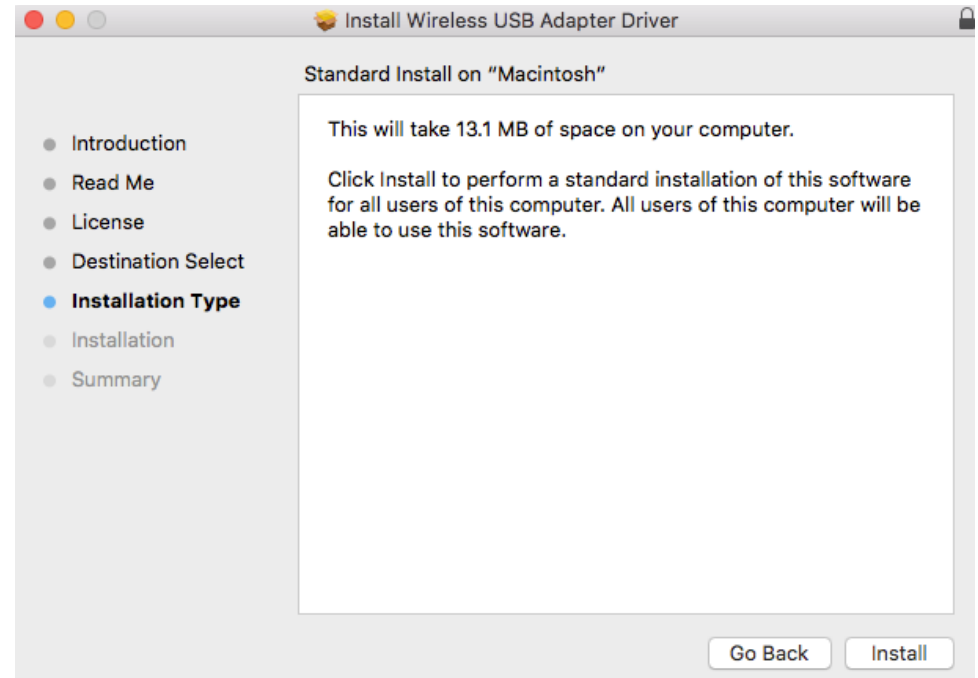

10. When prompted, enter your Mac® user account password to authorize the install, click **Install Software**.

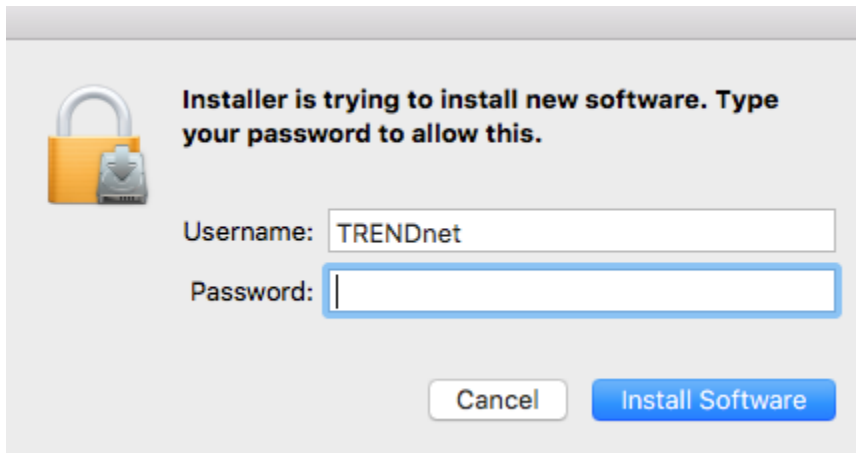

11. When prompted, click **Continue Installation**.

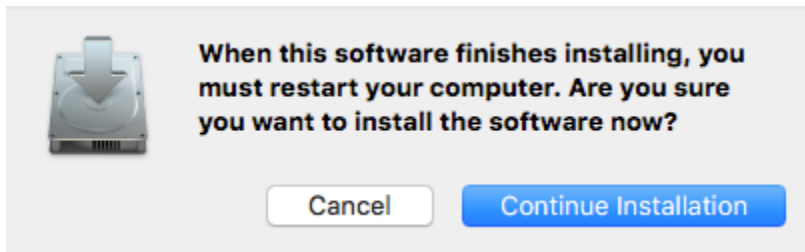

12. Once the installation is complete, you will be prompted to restart the computer. Click **Restart** to restart your computer.

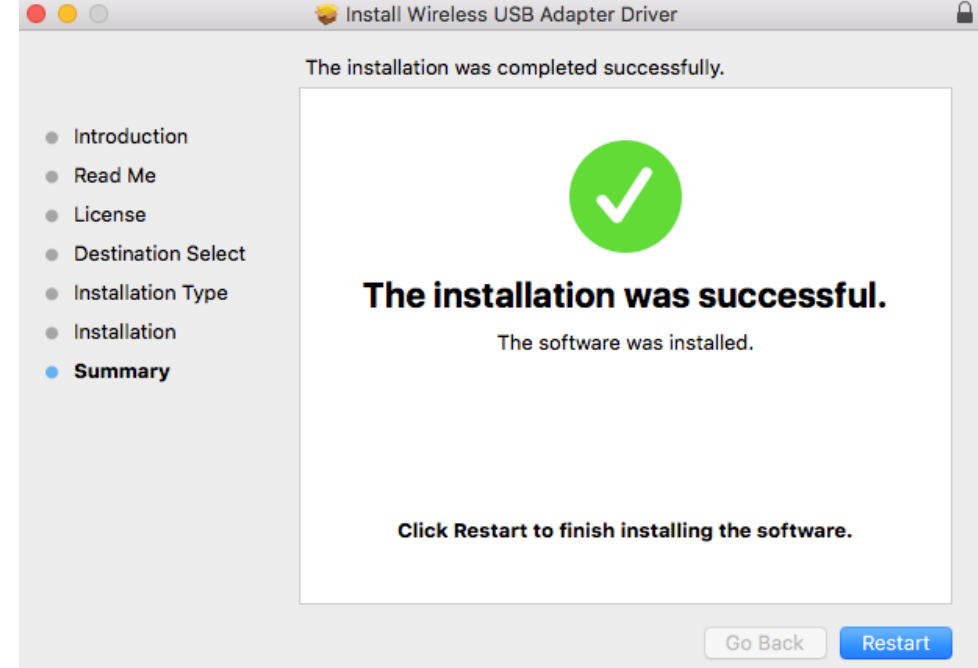

13. After the computer is rebooted, plug the Wireless N USB Adapter into an available USB slot on your computer.

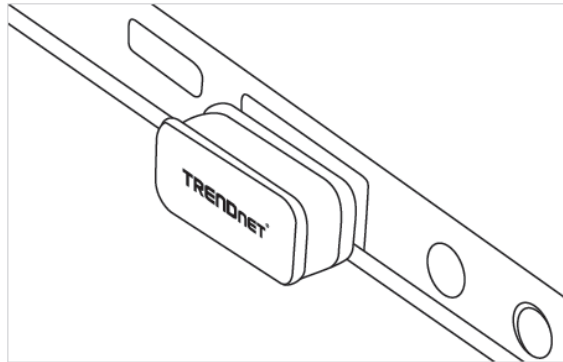

15. After the driver is successfully installed and wireless adapter is connected, a wireless adapter icon will appear in the top menu bar. Click on the icon in the top menu bar.



16. A list of available wireless network will appear. Click on the wireless network you would like to connect.

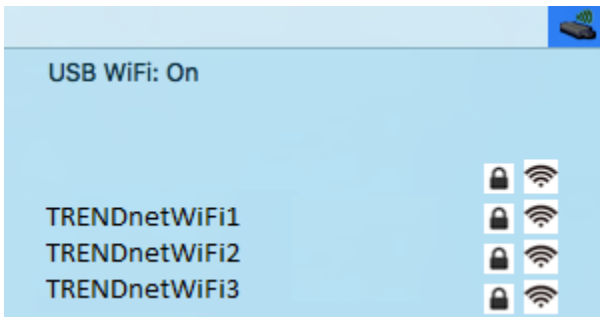

17. Enter the WiFi Key (password) and click **Join**.

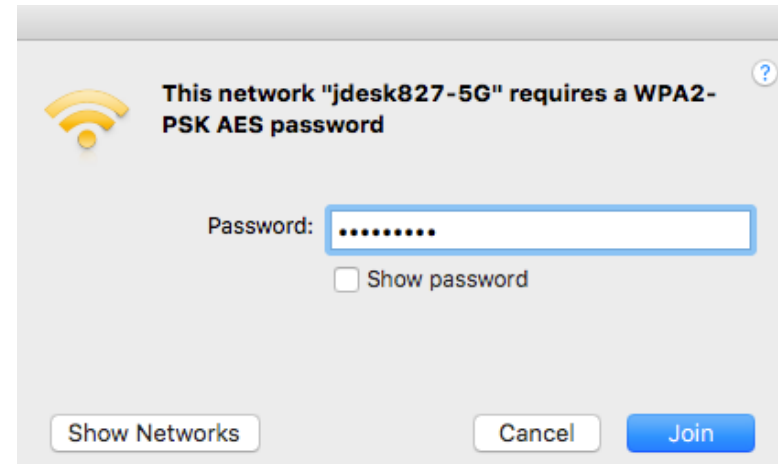

18. The wireless adapter icon will change to green WiFi bars to indicate a successful connection.

**Note:** If the connected message does not display, double check your WiFi key (password) and re-enter it.



## Connect to your wireless network using WPS

WPS (Wi-Fi Protected Setup) is a feature that makes it easy to connect devices to your wireless network. If your wireless router/access point supports WPS, you can use this feature to easily connect wireless devices to your network.

**Note:** You can typically find out if you if your wireless router/access point supports WPS just by looking at the physical device. There should be a WPS push button located on the exterior casing of the device, if not, your device may not support WPS or you may need to reference your device documentation as to how WPS can be initiated on the device. If your device does not have an identifiable WPS push button on the exterior location, we would recommend using the standard connection method on the previous page.

### Windows® OS

#### WPS connection using the built in utility (Virtual Push Button)

1. Click the WiFi icon in the system tray to scan for available wireless networks.



2. Click the network you would like to connect. Leave this window open.

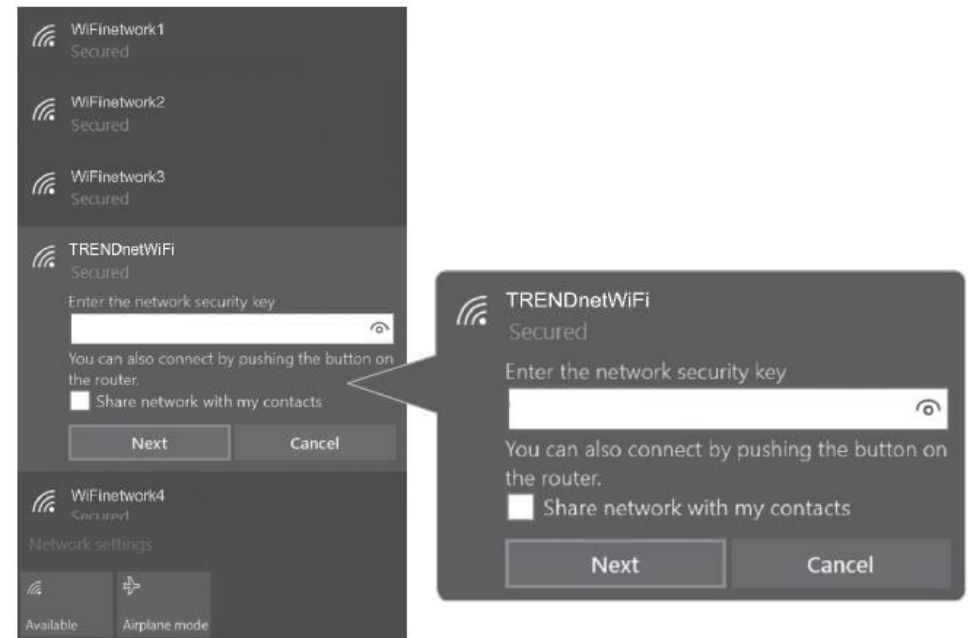

3. On your wireless router/access point, push the WPS button.

**Note:** Typically, the WPS button hold time is 3-5 sec., then release. For TRENDnet routers/access points, the WPS hardware push button hold time is 3 seconds. If you are using another brand device, you may need to refer to your device documentation for WPS operation.



4. The status will display "Connected" to indicate a successful connection.

**Note:** If the connected message does not display, double check your WiFi key (password) and re-enter it.

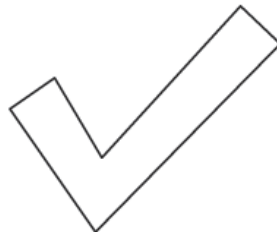

**Note:** If the WPS process fails, you will not receive a message "Connected". You may need to attempt the WPS process again. Please refer to your wireless router/access point documentation regarding the operation of WPS.

## Mac® OS

### WPS connection using the built in utility (Virtual Push Button)

1 On your wireless router/access point, push the WPS button.

**Note:** Typically, the WPS button hold time is 3-5 sec., then release. For TRENDnet routers/access points, the WPS hardware push button hold time is 3 seconds. If you are using another brand device, you may need to refer to your device documentation for WPS operation.



2. Click on the wireless adapter icon in the top menu bar.



3. Scroll to the bottom of the available wireless networks list and click the arrow at the bottom.



4. After the additional menu opens, click on **WPS**.

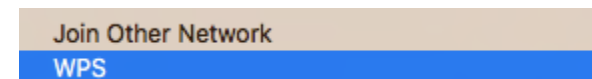

5. In the WPS window, click **PBC** to activate WPS.

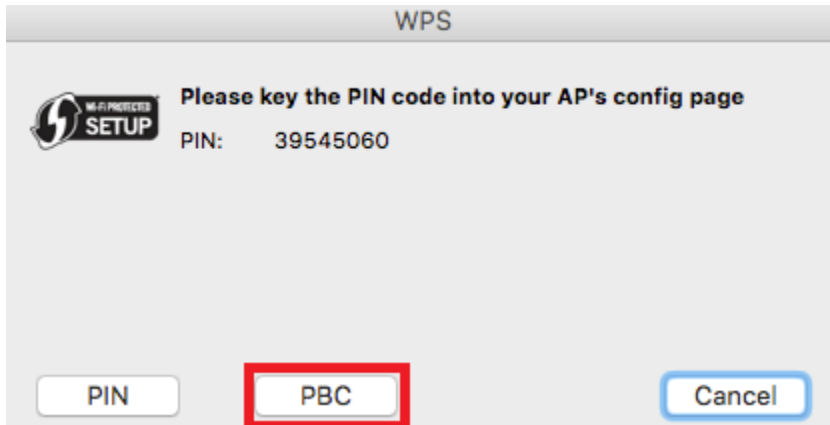

6. A series of status messages will appear. Wait for the WPS process to complete.

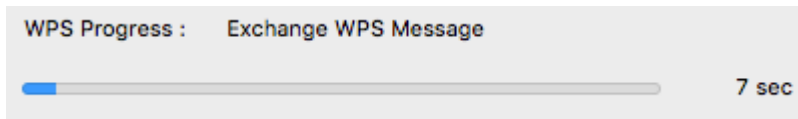

7. A status message will appear to indicate a successful connection.

**Note:** If the WPS process fails, you will receive not receive a message "Connected". You may need to attempt the WPS process again. Please refer to your wireless router/access point documentation regarding the operation of WPS.

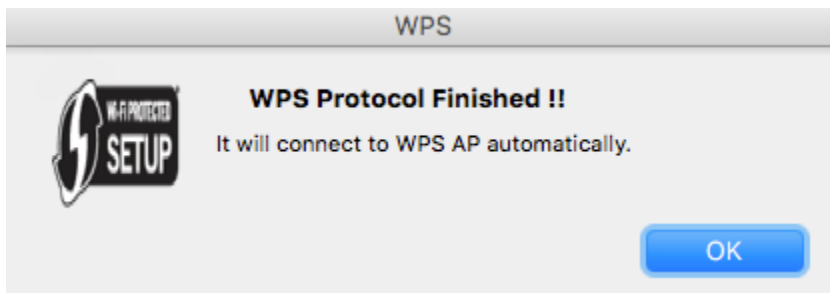

## Technical Specifications

### Interface

- USB 2.0

### Standards

- IEEE 802.11b
- IEEE 802.11g
- IEEE 802.11n

### Power Consumption

- Receive: 90mA (max.)
- Transmit: 250mA (max.)

### Supported OS

- Windows® 10 (32/64-bit), 8.1 (32/64-bit), 8 (32/64-bit), 7 (32/64-bit)
- Mac OS® 10.7-10.12

### Antenna

- Built-in on board antenna

### Frequency

- 2.4 ~ 2.48GHz

### Modulation

- OFDM, DSSS

### Data Rate

- 802.11b: up to 11Mbps
- 802.11g: up to 54Mbps
- 802.11n: up to 150Mbps

### Output Power

- 802.11b: 17 ± 1.5dBm
- 802.11g: 15 ± 1.5dBm
- 802.11n: 14 ± 1.5dBm

### Receiving Sensitivity

- 802.11b: -81 ± 2dBm at 11Mbps
- 802.11g: -71 ± 2dBm at 54Mbps
- 802.11n: -65 ± 2dBm at 150Mbps

### Encryption

- 64/128-bit WEP, WPA/WPA2-RADIUS, WPA-PSK/WPA2-PSK

### Channels

- 1~11 (FCC), 1~13 (ETSI)

### Temperature

- Operating: 0° ~ 40 °C (32° - 104 °F)
- Storage: -20° ~ 60 °C (-4° - 140 °F)

### Humidity

- Operating: 10 ~ 90% non-condensing
- Storage: Max 95% non-condensing

### Dimensions

- 17.5 x 15 x 7.3 mm (0.7 x 0.6 x 0.29 in.)

### Weight

- 1.98 g (.07 oz.)

### Certifications

- CE
- FCC

### Warranty

- 3 year limited



## Troubleshooting

**Q: I inserted the Utility & Driver CD-ROM into my computer's CD-ROM Drive and the installation menu does not appear automatically. What should I do?**

**Answer:**

1. For Windows® 10/8.1/8/7, if the installation menu does not appear automatically, click on the Windows Icon on the bottom left hand corner of the screen,, click the "Search programs and files" box, and type D:\Autorun.exe, where "D" in "D:\Autorun.exe" is the letter assigned to your CD-ROM Drive, and then press the ENTER key on your keyboard
2. For Windows® Vista, if the installation menu does not appear automatically, click **Start**, click the **Start Search** box, and type **D:\Autorun.exe** where "D" in "D:\autorun.exe" is the letter assigned to your CD-ROM Drive, and then press the ENTER key on your keyboard.
3. For Windows® XP, if the installation menu does not appear automatically, click **Start**, click **Run**, and type **D:\Autorun** where "D" in "D:\Autorun.exe" is the letter assigned to your CD-ROM Drive, and then press the ENTER key on your keyboard.

**Q: I completed all the steps in the quick installation guide, but my Wireless USB Adapter is not connecting to my access point. What should I do?**

**Answer:**

1. Verify that the SSID (Network Name) matches your wireless router or access point's SSID
2. Please check with your network administrator for security key in order to access a secured wireless access point or router. Please refer to the User's Guide for more information regarding wireless network security.
3. Check your TCP/IP properties to ensure that Obtain an IP address automatically is selected.
4. Double-click the Wireless Configuration Utility icon, click Available Networks and then click Refresh to check and see if there are any available wireless networks listed.

**Q: Windows is unable to recognize my hardware. What should I do?**

**Answer:**

1. Make sure your computer meets the minimum requirements as specified in Section 1 of this quick installation guide.
2. You must complete the installation of the Wireless Configuration Utility (as described in Section 2) before connecting the Wireless USB Adapter to your computer.
3. Connect the Wireless USB Adapter to a different USB port on your computer.

## Appendix

### How to choose the type of security for your wireless network

Setting up wireless security is very important. Leaving your wireless network open and unsecure could expose your entire network and personal files to outsiders. TRENDnet recommends reading through this entire section and setting up wireless security on your new router.

There are a few different wireless security types supported in wireless networking each having its own characteristics which may be more suitable for your wireless network taking into consideration compatibility, performance, as well as the security strength along with using older wireless networking hardware (also called legacy hardware).

It is strongly recommended to enable wireless security to prevent unwanted users from accessing your network and network resources (personal documents, media, etc.).

In general, it is recommended that you choose the security type with the highest strength and performance supported by the wireless computers and devices in your network. Please review the security types to determine which one you should use for your network.

#### Wireless Encryption Types

- **WEP:** Legacy encryption method supported by older 802.11a/b/g hardware. This is the oldest and least secure type of wireless encryption. It is generally not recommended to use this encryption standard, however if you have old 802.11 b, 802.11g or 802.11a wireless adapters or computers with old embedded wireless cards(wireless clients), you may have to set your router to WEP to allow the old adapters to connect to the router. **Note:** *This encryption standard will limit connection speeds to 54Mbps.*

- **WPA:** This encryption is significantly more robust than the WEP technology. Much of the older 802.11a or 802.11g hardware has been upgraded (with firmware/driver upgrades) to support this encryption standard. Total wireless speeds under this encryption type however are limited to 54Mbps.
- **WPA-Auto:** This setting provides the router with the ability to detect wireless devices using either WPA or WPA2 encryption. Your wireless network will automatically change the encryption setting based on the first wireless device connected. For example, if the first wireless client that connects to your wireless network uses WPA encryption your wireless network will use WPA encryption. Only when all wireless clients disconnect to the network and a wireless client with WPA2 encryption connects your wireless network will then change to WPA2 encryption. **NOTE:** WPA2 encryption supports 802.11n speeds and WPA encryption will limit your connection speeds to 54Mbps
- **WPA2:** This is the most secure wireless encryption available today, similar to WPA encryption but more robust. This encryption standard also supports the highest connection speeds. TRENDnet recommends setting your router to this encryption standard. If you find that one of your wireless network devices does not support WPA2 encryption, then set your router to either WPA or WPA-Auto encryption.

**Note:** *Check the specifications of your wireless network adapters and wireless appliances to verify the highest level of encryption supported.*

**Open or Shared \ WEP** – Enter the WEP key for your wireless network. Wireless network has WEP security enabled, open or shared. Please note that the Key Index 1-4 must also match the same index configured on the wireless router/access point.

WEP Key Format	HEX	ASCII
Character set	0-9 & A-F, a-f only	Alphanumeric (a,b,C,?, *, /,1,2, etc.)
64-bit key length	10 characters	5 characters
128-bit key length	26 characters	13 characters

**WPA/WPA2-PSK/TKIP or AES** – Wireless network has WPA/WPA2-PSK security enabled, TKIP or AES. **Note:** 8-63 alphanumeric characters (a,b,C,?, \*, /,1,2, etc.)

Below is brief comparison chart of the wireless security types and the recommended configuration depending on which type you choose for your wireless network.

Security Standard	WEP	WPA	WPA2
<b>Compatible Wireless Standards</b>	IEEE 802.11a/b/g (802.11n devices will operate at 802.11g to connect using this standard)	IEEE 802.11a/b/g (802.11n/ac devices will operate at 802.11g to connect using this standard)	IEEE 802.11a/b/g/n/ac
<b>Highest Performance Under This Setting</b>	<b>Up to 54Mbps</b>	<b>Up to 54Mbps</b>	<b>Up to 150Mbps 11n*</b>
<b>Encryption Strength</b>	Low	Medium	High
<b>Additional Options</b>	Open System or Shared Key, HEX or ASCII, Different key sizes	TKIP or AES, Preshared Key or RADIUS	TKIP or AES, Preshared Key or RADIUS
<b>Recommended Configuration</b>	Open System ASCII 13 characters	TKIP Preshared Key 8-63 characters	AES Preshared Key 8-63 characters

**How to find your IP address?**

**Note:** Please note that although the following procedures provided to follow for your operating system on configuring your network settings can be used as general guidelines, however, it is strongly recommended that you consult your computer or operating system manufacturer directly for assistance on the proper procedure for configuring network settings.

Command Prompt Method

**Windows® XP/Vista/7/8/8.1/10**

1. On your keyboard, press **Windows Logo+R** keys simultaneously to bring up the Run dialog box.
2. In the dialog box, type **cmd** to bring up the command prompt.
3. In the command prompt, type **ipconfig /all** to display your IP address settings.

**Note:** If you are experiencing difficulties, please contact your computer or operating system manufacturer for assistance.

**How to configure your network settings to obtain an IP address automatically or use DHCP?**

**Note:** Please note that although the following procedures provided to follow for your operating system on configuring your network settings can be used as general guidelines, however, it is strongly recommended that you consult your computer or operating system manufacturer directly for assistance on the proper procedure for configuring network settings.

**Windows® 10/8.1/8/7**

- a. Go into the **Control Panel**, click **Network and Sharing Center**.
- b. Click **Change Adapter Settings**, right-click the **Local Area Connection** icon.
- c. Then click **Properties** and click **Internet Protocol Version 4 (TCP/IPv4)**.
- d. Then click **Obtain an IP address automatically** and click **OK**.

**Windows® Vista**

- a. Go into the **Control Panel**, click **Network and Internet**.
- b. Click **Manage Network Connections**, right-click the **Local Area Connection** icon and click **Properties**.
- c. Click **Internet Protocol Version (TCP/IPv4)** and then click **Properties**.

- d. Then click **Obtain an IP address automatically** and click **OK**.

#### **Windows® XP**



- a. Go into the **Control Panel**, double-click the **Network Connections** icon
- b. Right-click the **Local Area Connection** icon and click **Properties**.
- c. Click **Internet Protocol (TCP/IP)** and click **Properties**.
- d. Then click **Obtain an IP address automatically** and click **OK**.

*Note: If you are experiencing difficulties, please contact your computer or operating system manufacturer for assistance.*

#### **How to connect to a wireless network using the built-in Windows utility?**

*Note: Please note that although the following procedures provided to follow for your operating system on configuring your network settings can be used as general guidelines, however, it is strongly recommended that you consult your computer or operating system manufacturer directly for assistance on the proper procedure for connecting to a wireless network using the built-in utility.*

#### **Windows® 10/8.1/8/7**

1. Open Connect to a Network by clicking the network icon ( or ) in the notification area.
2. In the list of available wireless networks, click the wireless network you would like to connect to, then click **Connect**.
4. You may be prompted to enter a security key in order to connect to the network.
5. Enter in the security key corresponding to the wireless network, and click **OK**.

#### **Windows® Vista**

1. Open Connect to a Network by clicking the **Start Button**.  and then click **Connect To**.
2. In the **Show** list, click **Wireless**.
3. In the list of available wireless networks, click the wireless network you would like to connect to, then click **Connect**.
4. You may be prompted to enter a security key in order to connect to the network.
5. Enter in the security key corresponding to the wireless network, and click **OK**.

#### **Windows XP**

1. Right-click the network icon in the notification area, then click **View Available Wireless Networks**.
2. In **Connect to a Network**, under **Available Networks**, click the wireless network you would like to connect to.
3. You may be prompted to enter a security key in order to connect to the network.
4. Enter in the security key corresponding to the wireless network, and click **Connect**.

### Federal Communication Commission Interference Statement

This equipment has been tested and found to comply with the limits for a Class B digital device, pursuant to Part 15 of the FCC Rules. These limits are designed to provide reasonable protection against harmful interference in a residential installation. This equipment generates, uses and can radiate radio frequency energy and, if not installed and used in accordance with the instructions, may cause harmful interference to radio communications. However, there is no guarantee that interference will not occur in a particular installation. If this equipment does cause harmful interference to radio or television reception, which can be determined by turning the equipment off and on, the user is encouraged to try to correct the interference by one of the following measures:

- Reorient or relocate the receiving antenna.
- Increase the separation between the equipment and receiver.
- Connect the equipment into an outlet on a circuit different from that to which the receiver is connected.
- Consult the dealer or an experienced radio/TV technician for help.

FCC Caution: Any changes or modifications not expressly approved by the party responsible for compliance could void the user's authority to operate this equipment.

This device complies with Part 15 of the FCC Rules. Operation is subject to the following two conditions: (1) This device may not cause harmful interference, and (2) this device must accept any interference received, including interference that may cause undesired operation.



#### IMPORTANT NOTE:

##### Radiation Exposure Statement:

This equipment complies with FCC radiation exposure limits set forth for an uncontrolled environment. End user must follow the specific operating instructions for satisfying RF exposure compliance. This equipment should be installed and operated with minimum distance 0.5cm between the radiator & your body.

This transmitter must not be co-located or operating in conjunction with any other antenna or transmitter.

Country Code selection feature to be disabled for products marketed to the US/CANADA

### RoHS

This product is RoHS compliant.



### Europe – EU Declaration of Conformity

TRENDnet hereby declare that the product is in compliance with the essential requirements and other relevant provisions under our sole responsibility.

#### Safety

EN 60950-1:2006+A11:2009+A1:2010+A12:2011+A2:2013

#### EMC

EN 301489-1 V2.2.0 (2017-03)

EN 301489-17 V3.2.0 (2017-03)

#### Radio Spectrum & Health

EN 300 328 V2.1.1 (2016-11)

EN 62311:2008

#### Directives:

EMC Directive 2014/30/EU

REACH Regulation (EC) No. 1907/2006

Ecodesign Directive 2009/125/EU

RoHS Directive 2011/65/EU

Radio Equipment Directive (RED) 2014/53/EU

Low Voltage Directive 2014/35/EU

WEEE Directive 2012/19/EU



#### CE Mark Warning

This is a Class A product. In a domestic environment, this product may cause radio interference, in which case the user may be required to take adequate measures.

## Limited Warranty

TRENDnet warrants only to the original purchaser of this product from a TRENDnet authorized reseller or distributor that this product will be free from defects in material and workmanship under normal use and service. This limited warranty is non-transferable and does not apply to any purchaser who bought the product from a reseller or distributor not authorized by TRENDnet, including but not limited to purchases from Internet auction sites.

## Limited Warranty

TRENDnet warrants its products against defects in material and workmanship, under normal use and service. Specific warranty periods are listed on each of the respective product pages on the TRENDnet website.

- AC/DC Power Adapter, Cooling Fan, and Power Supply carry a one-year warranty.

## Limited Lifetime Warranty

TRENDnet offers a limited lifetime warranty for all of its metal-enclosed network switches that have been purchased in the United States/Canada on or after 1/1/2015.

- Cooling fan and internal power supply carry a one-year warranty

To obtain an RMA, the ORIGINAL PURCHASER must show Proof of Purchase and return the unit to the address provided. The customer is responsible for any shipping-related costs that may occur. Replacement goods will be shipped back to the customer at TRENDnet's expense.

Upon receiving the RMA unit, TRENDnet may repair the unit using refurbished parts. In the event that the RMA unit needs to be replaced, TRENDnet may replace it with a refurbished product of the same or comparable model.

In the event that, after evaluation, TRENDnet cannot replace the defective product or there is no comparable model available, we will refund the depreciated value of the product.

If a product does not operate as warranted during the applicable warranty period, TRENDnet shall reserve the right, at its expense, to repair or replace the defective product or part and deliver an equivalent product or part to the customer. The repair/replacement unit's warranty continues from the original date of purchase. All products that are replaced become the property of TRENDnet. Replacement products may be new or reconditioned. TRENDnet does not issue refunds or credit. Please contact the point-of-purchase for their return policies.

TRENDnet shall not be responsible for any software, firmware, information, or memory data of customer contained in, stored on, or integrated with any products returned to TRENDnet pursuant to any warranty.

There are no user serviceable parts inside the product. Do not remove or attempt to service the product by any unauthorized service center. This warranty is voided if (i) the product has been modified or repaired by any unauthorized service center, (ii) the product was subject to accident, abuse, or improper use, or (iii) the product was subject to conditions more severe than those specified in the manual.

Warranty service may be obtained by contacting TRENDnet within the applicable warranty period and providing a copy of the dated proof of the purchase. Upon proper submission of required documentation, a Return Material Authorization (RMA) number will be issued. An RMA number is required in order to initiate warranty service support for all TRENDnet products. Products that are sent to TRENDnet for RMA service must have the RMA number marked on the outside of return packages and sent to TRENDnet prepaid, insured and packaged appropriately for safe shipment. International customers

shipping from outside of the USA and Canada are responsible for any return shipping and/or customs charges, including but not limited to, duty, tax, and other fees.

**Refurbished product:** Refurbished products carry a 90-day warranty after date of purchase. Please retain the dated sales receipt with purchase price clearly visible as evidence of the original purchaser's date of purchase. Replacement products may be refurbished or contain refurbished materials. If TRENDnet, by its sole determination, is unable to replace the defective product, we will offer a refund for the depreciated value of the product.

**WARRANTIES EXCLUSIVE:** IF THE TRENDNET PRODUCT DOES NOT OPERATE AS WARRANTED ABOVE, THE CUSTOMER'S SOLE REMEDY SHALL BE, AT TRENDNET'S OPTION, REPAIR OR REPLACE. THE FOREGOING WARRANTIES AND REMEDIES ARE EXCLUSIVE AND ARE IN LIEU OF ALL OTHER WARRANTIES, EXPRESSED OR IMPLIED, EITHER IN FACT OR BY OPERATION OF LAW, STATUTORY OR OTHERWISE, INCLUDING WARRANTIES OF MERCHANTABILITY AND FITNESS FOR A PARTICULAR PURPOSE. TRENDNET NEITHER ASSUMES NOR AUTHORIZES ANY OTHER PERSON TO ASSUME FOR IT ANY OTHER LIABILITY IN CONNECTION WITH THE SALE, INSTALLATION, MAINTENANCE, OR USE OF TRENDNET'S PRODUCTS.

TRENDNET SHALL NOT BE LIABLE UNDER THIS WARRANTY IF ITS TESTING AND EXAMINATION DISCLOSE THAT THE ALLEGED DEFECT IN THE PRODUCT DOES NOT EXIST OR WAS CAUSED BY CUSTOMER'S OR ANY THIRD PERSON'S MISUSE, NEGLIGENCE, IMPROPER INSTALLATION OR TESTING, UNAUTHORIZED ATTEMPTS TO REPAIR OR MODIFY, OR ANY OTHER CAUSE BEYOND THE RANGE OF THE INTENDED USE, OR BY ACCIDENT, FIRE, LIGHTNING, OR OTHER HAZARD.

LIMITATION OF LIABILITY: TO THE FULL EXTENT ALLOWED BY LAW, TRENDNET ALSO EXCLUDES FOR ITSELF AND ITS SUPPLIERS ANY LIABILITY, WHETHER BASED IN CONTRACT OR TORT (INCLUDING NEGLIGENCE), FOR INCIDENTAL, CONSEQUENTIAL, INDIRECT, SPECIAL, OR PUNITIVE DAMAGES OF ANY KIND, OR FOR LOSS OF REVENUE OR PROFITS, LOSS OF BUSINESS, LOSS OF INFORMATION OR DATA, OR OTHER FINANCIAL LOSS ARISING OUT OF OR IN CONNECTION WITH THE SALE, INSTALLATION, MAINTENANCE, USE, PERFORMANCE, FAILURE, OR INTERRUPTION OF THE POSSIBILITY OF SUCH DAMAGES, AND LIMITS ITS LIABILITY TO REPAIR, REPLACEMENT, OR REFUND OF THE PURCHASE PRICE PAID, AT TRENDNET'S OPTION. THIS DISCLAIMER OF LIABILITY FOR DAMAGES WILL NOT BE AFFECTED IF ANY REMEDY PROVIDED HEREIN SHALL FAIL OF ITS ESSENTIAL PURPOSE.

**Governing Law:** This Limited Warranty shall be governed by the laws of the state of California.

Some TRENDnet products include software code written by third party developers. These codes are subject to the GNU General Public License ("GPL") or GNU Lesser General Public License ("LGPL").

Visit <http://www.trendnet.com/gpl> or the support section on <http://www.trendnet.com> and search for the desired TRENDnet product to access to the GPL Code or LGPL Code. These codes are distributed WITHOUT WARRANTY and are subject to the copyrights of the developers. TRENDnet does not provide technical support for these codes. Please visit <http://www.gnu.org/licenses/gpl.txt> or <http://www.gnu.org/licenses/lgpl.txt> for specific terms of each license.

2017/06/24



## Product Warranty Registration

Please take a moment to register your product online.  
Go to TRENDnet's website at <http://www.trendnet.com/register>

TRENDnet  
20675 Manhattan Place  
Torrance, CA 90501. USA