



TCL多媒体科技控股有限公司

PRODUCTION FORM

版本号: R0

物料编号: 72-MT25NA-X001B

内容: OPERATION MANUAL (说明书)

型号: LE50FHDE5510C

时间: 2013.5.13

备注: 此物料如是环保物料, 则在BOM中体现。

牌子名称(BRAND NAME): TCL

B.O.M.编号: H3-50E55D2-USAAWAA

往(TO): 采购部 塑胶厂 IQC PMC部 QA部 PE部

种类(TYPE OF JOB.): 丝印 Silk Screen Printing 水墨印刷 Wash Printing 四色印刷 Four-Colour Printing 喷油 Spraying Paint 塑胶颜色 Plastic Colour 其它 Others

- 内容: i) 稿件比例(SCALE) : 1:1
- ii) 尺寸(SIZE) : A5
- iii) 颜色(COLOUR) : PRINT IN BLACK ON WHITE BACKGROUND.
- iv) **请见附页** 白底黑字。

TCL提供 客户提供
TCL CUSTOMER

生效ODF和时间 ODF & DATE: 试产机 磁盘: 1 样稿: -

制作人 PREPARED BY: _____

平面/审核 CHECKED BY: _____

项目工程师 CHECKED BY: _____

QA/技术支持部审核 AUDITED BY: _____

TCL

The Creative Life

User's Guide

For use with models: LE50FHDE5510C
/ LE55FHDE5510C

Need assistance?





*visit our website at www.tclusa.com
or call 1-877-300-8837*



COLOR YOUR WORLD

Figures and illustrations in this User's Guide are provided for reference only and may differ from actual product appearance. Product design and specifications may be changed without notice.

Important Information

 CAUTION RISK OF ELECTRIC SHOCK. DO NOT OPEN.		 This symbol indicates that this product incorporates double insulation between hazardous main voltage and user accessible parts. When servicing, use only identical replacement parts.
Caution: To reduce the risk of electric shock, do not remove cover (or back). No user serviceable parts inside. Refer servicing to qualified service personnel.		
 This symbol indicates "dangerous voltage" inside the product that presents a risk of electric shock or personal injury.	 This symbol indicates important instructions accompanying the product.	

WARNING

To reduce the risk of fire or electric shock, do not expose this product to rain or moisture. This product should not be exposed to dripping or splashing. No objects filled with liquids, such as vases, should be placed on the component.

WARNING

The TV is unstable if it is not properly attached to the base or mounted to the wall. Please follow the base or wall mounting instructions provided in the User's Guide to ensure your safety.

WARNING The batteries shall not be exposed to excessive heat such as sunshine, fire or the like.

Refer to the identification/rating label located on the back panel of your product for its proper operating voltage. FCC regulations state that unauthorized changes or modifications to this equipment may void the user's authority to operate it.

Cable TV Installer: This reminder is provided to call your attention to Article 820-40 of the National Electrical Code (Section 54 of the Canadian Electrical Code, Part 1) which provides guidelines for proper grounding and, in particular, specifies that the cable ground should be connected to the grounding system of the building as close to the point of cable entry as practical.

Important: This television is a table model and is designed to sit on a firm, flat surface. Don't place the TV on soft carpeting or similar surface because the ventilation slots on the bottom of the unit will be blocked, resulting in reduced lifetime from overheating. To assure adequate ventilation for this product, maintain a spacing of 4 inches from the top and side of the TV receiver and 2 inches from the rear of the TV receiver and other surfaces. Also, make sure the stand or base you use is of adequate size and strength to prevent the TV from being accidentally tipped over, pushed off, or pulled off. This could cause personal injury and/or damage to the TV. Refer to the Important Safety Instructions on the next page.

The Power button (followed by the power symbol) on this TV and your remote control puts the TV into a very low-power standby mode but will not completely turn the power off. In order to completely shut the power off, you will need to disconnect the power cord from the outlet. The mains plug/appliance coupler is used as disconnect device, the disconnect device shall remain readily operable. Therefore, you should ensure that the TV is installed in a manner that allows you to disconnect the power cord when desired.

Product Registration

Please register your TCL purchase on-line at www.tclusa.com. It will make it easier to contact you should it ever be necessary. Registration is not required for warranty coverage.

Product Information

Keep your sales receipt to obtain warranty parts and service and for proof of purchase. Attach it here and record the serial and model numbers in case you need them. These numbers are located on the product.

Model No. _____ **Serial No.** _____
Purchase Date _____ **Dealer/Address/Phone** _____

Important Safety Instructions

1. Read and follow all instructions.
2. Keep these instructions.
3. Heed all warnings.
4. Do not block any ventilation openings. Install in accordance with the manufacturer's instructions.
5. Do not install near any heat sources such as radiators, heat registers, stoves, or other apparatus (including amplifiers) that produce heat.
6. Protect the power cord from being walked on or pinched particularly at plugs, receptacles, and the point where it exits from the component.
7. Do not use this component near water.
8. Only use the attachments/accessories specified by the manufacturer.
9. Clean only with dry cloth.
10. Use only with the cart, stand, tripod, bracket, or table specified by the manufacturer, or sold with the component. When the TV is placed on a cart, use caution when moving the cart to avoid injury from tip-over.
11. Warning: To avoid any injury caused by lean of the product, please always ensure the whole product was place within the table surface in horizontal.
12. Unplug this component during lightning storms or when unused for long periods of time.
13. Refer all servicing to qualified service personnel. Service is required when the component is damaged in any way, such as power supply cord or plug damage, liquid spilled on or objects falling onto the component, rain or moisture exposure, abnormal operation, or if the component has been dropped.
14. If an outside antenna or cable system is connected to the product, be sure the antenna or cable system is grounded so as to provide some protection against voltage surges and built-up static charges. Section 810 of the National Electrical Code, ANSI/NFPA No. 70-1984 (Section 54 of Canadian Electrical Code, Part 1) provides information with respect to proper grounding of the mast and supporting structure, grounding of the lead-in wire to an antenna-discharge unit, size of grounding conductors, location of antenna-discharge unit, connection to grounding electrodes, and requirements for the grounding electrode. See following example:

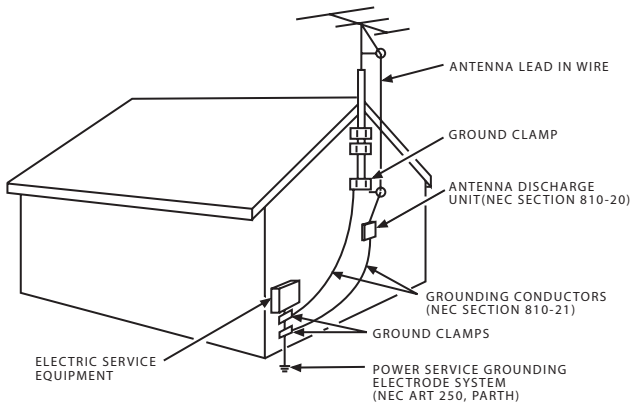

Table of Contents

Important Information	1	Speaker	15
Important Safety Instructions	2	SPDIF Type	15
Chapter 1 - Connections and Setup		Auto volume control	15
Before Initial Setup	4	MTS	15
Check Supplied Parts	4	Default Audio Language	15
Attaching Your TV to the Table Stand	5	Current Audio Language	16
Mounting Your TV to the Wall	5	TV Menu	16
Buttons on TV	6	Signal Type	16
Explanation of Jacks on TV	6	Channel Scan	16
Choose Your Connections	7	Channel Skip	16
Nework Connection	9	Time Menu	17
Connecting to a wired network	9	Time Zone	17
Network Setup	9	Daylight Saving Time	17
Internet Connections	9	Time	17
Wired Network Setup	9	Sleep timer	17
Wireless Network Setup	10	Connection Menu	17
Information	10	Netflix	17
IP setting	10	YouTube	17
Connection Test	10	Share & See	17
Remote Control Functions	11	Settings	17
Obtain the Signal	12	Media Menu	18
Switching On	12	Photo	18
Switching Off	12	Music	18
Initial Set-up	13	Video	18
		Parental Menu	19
Chapter 2 - Menu Operation		Change V-Chip Password	19
Menu Display	14	Channel Block	19
Using Menu System	15	Program Block	19
Picture Menu	15	Input Block	20
Picture Mode	15	Button Block	20
Back Light	15	Clean all	20
Dynamic Backlight	15	Setup Menu	20
Brightness	15	OSD Language	20
Contrast	15	Screen Mode	20
Tint	15	Closed Caption	20
Color	15	System Information	21
Sharpness	15	Software Upgrade	21
Color Temperature	15	Reset Default	21
Advanced Settings	15	Chapter 3 - Other Information	
Sound Menu	15	Frequently Asked Questions (FAQs)	22
Sound Mode	15	Troubleshooting	23
Balance	15	Care and Cleaning	25
Sound Surround	15	Television Specifications	26
		Limited Warranty	27

Before Initial Setup

Protect Against Power Surges

- Connect all components before you plug any power cords into the wall outlet or power strip.
- NEVER plug your TV into an outlet that is controlled by a wall switch.
- Turn off the TV before you connect or disconnect any cables.
- Make sure all antennas and cables are properly grounded. Refer to the Important Safety Instructions.

Safety Information

- Protect components from overheating.
- Don't block ventilation holes on any of the components. Arrange the components so that air can circulate freely.
- Don't stack components.
- If you place the component in a stand, make sure you allow adequate ventilation.
- If you connect an audio receiver or amplifier, place it on the top shelf so the heated air from it won't harm other components.

Avoid Audio Interference

- Position cables properly; insert each cable firmly into the designated jack.
- If you place components above the TV, route all cables down one side of the back of the TV instead of straight down the middle.
- If your antenna uses 300-ohm twin lead cables, do not coil the cables.
- Keep twin lead cables away from audio/video cables.

Avoid Direct Light

Don't place the TV where sunlight or room lighting is directed toward the screen. Use soft or indirect lighting.

Check Supplied Parts

Check that the following parts were packed with your product.

- 1 Remote Control and 2 AAA Batteries;
- Audio/Video adapter cable;
- Audio adapter cable;
- Component Video (YPbPr) adapter cable;
- Wireless USB Adapter ;
- USB extension cable
- User's Guide;
- Quick Start Guide;
- Parts List for Table Stand (see page 5)

Replacing your remote

If you need to replace your remote, visit www.tclusa.com. A shipping and handling fee, and the appropriate sales tax, will be charged upon ordering. Have your Visa or MasterCard ready.

Connections and Setup

Attaching Your TV to the Table Stand

Your TV comes without the table stand attached so that you can choose to mount your TV either to its table stand or to a wall (wall mount sold separately). If you want to mount your TV to the wall, don't attach the table stand. Follow the Mounting Your TV to the Wall instructions.

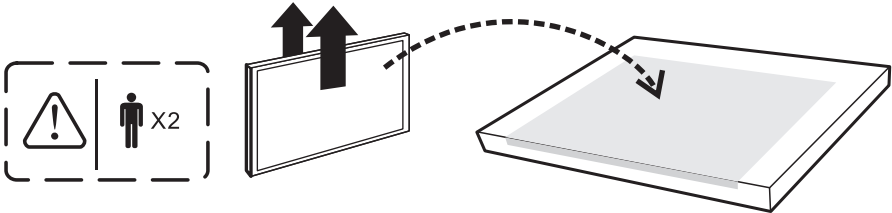

First, remove the TV bag and place it on a large, flat surface such as a table or countertop. Remove the TV from the carton and place it face down on the TV bag. Be sure that the TV is face down to avoid scratching the screen. Then follow the steps below:

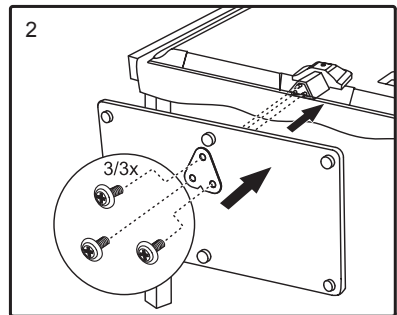
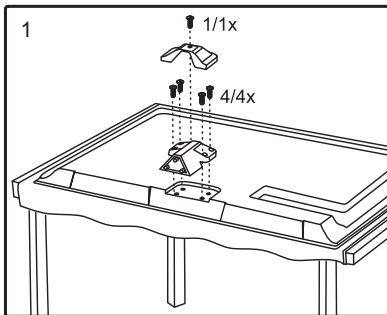

Mounting Your TV to the Wall

To mount your TV to the wall, purchase a VESA wall mount.

Model LE50FHDE5510C	Purchase a VESA 400 x 200, M6 screw
Model LE55FHDE5510C	Purchase a VESA 400 x 400, M6 screw

The VESA number is the horizontal and vertical measurement of the mounting holes. For example, 200x100 refers to the fact that the mounting measurements are 200mm horizontally and 100mm vertically.

Notes: Follow the directions included with the wall mount to mount the TV to the wall.

Caution: Your wall mount must be able to bear a minimum of five times the TV's net weight to avoid causing damage.

Buttons on TV

If you cannot locate your remote, you can use the TV panel buttons on your TV to operate many TV features.

CH+/- Selects channels stored in the channel list or acts as the up/down arrow (▲/▼) through the menu items.

VOL+/- Increases/decreases the volume or acts as the right/left arrow(◀/▶) through the menu items.

 **(MENU button)** Brings up the TV's main menu.

 **(INPUT button)** Selects the signal source.

 **(POWER button)** Turns the TV on or to standby mode.



Explanation of Jacks on TV

This section describes the jacks on the side/back panel of your TV. There are several ways to connect components.

Ethernet Lets you connect an Ethernet cable to access the Internet.

AUDIO OUT Adapter (you must connect an audio adapter cable with two color jacks to this adapter jack first, red and white jacks for R AUDIO and L AUDIO connection) Use an RCA audio cable to connect your TV to a compatible audio receiver.

VGA (PC IN) Connect your computer or other component with a VGA output to this jack using a 15-pin,D-sub cable.

DVI/PC AUDIO IN (used for DVI/PC only) Provides audio connection when using HDMI/DVI INPUT 1 jack for DVI or when using VGA (PC IN).

AV 2 IN adapter Lets you connect a component that has composite video jacks, such as a VCR or DVD player. (Note that you must connect an Audio/Video adapter cable with three color jacks to this adapter jack first, Yellow jack for VIDEO connection, red and white jacks for R AUDIO and L AUDIO connection. For mono audio sources, be sure to use the L AUDIO INPUT.)

ANTENNA/CABLE/SAT IN Lets you connect a coaxial cable to receive the signal from your antenna, cable, or cable box, satellite receiver.

CMPT AUDIO IN adapter Provides left and right audio connection when using the CMPT VIDEO input. (Note that you must connect an Audio adapter cable with two color jacks to this adapter jack first, red and white jacks for R AUDIO and L AUDIO connection. For mono audio sources, be sure to use the L AUDIO INPUT.)

CMPT IN (Y Pb Pr) adapter Lets you connect a component that has component video jacks, such as a DVD player. (Note that you must connect a Component Video adapter cable with three color jacks to this adapter jack first: Green jack for Y, Blue jack for Pb and Red jack for Pr)

• **Y Pb Pr (Component Video)** Provides good picture quality because the video is separated into three signals. Use three video-grade or component video cables for the connection.

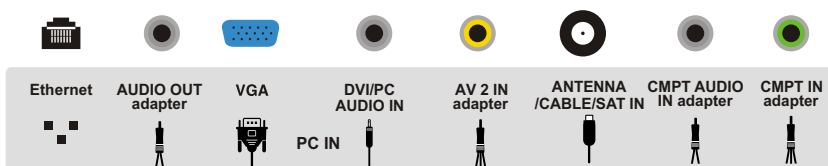

Connections and Setup

USB1

Allows you to connect a compatible mass storage device or connect to the Internet using the Wireless USB Adapter delivered with your TV.

USB2

Allows you to connect a compatible mass storage device.

SPDIF(optical) - DIGITAL AUDIO OUT

Use a digital optical cable to connect your TV to a compatible audio receiver.

(HEADPHONE)

Allow you to connect headphones to listen to the sound coming from the TV.

AV 1 IN adapter

Lets you connect a component that has composite video jacks, such as a VCR or DVD player. (Note that you must connect an Audio/Video adapter cable with three color jacks to this adapter jack first, Yellow jack for VIDEO connection, red and white jacks for R AUDIO and L AUDIO connection. For mono audio sources, be sure to use the L AUDIO INPUT.)

HDMI 2 IN / HDMI 3 IN / HDMI 4 IN

Lets you connect a component, such as a digital cable box, with an HDMI output for the best picture quality.

HDMI 1/DVI IN

(High-Definition Multimedia Interface/Digital Visual Interface) Provides an uncompressed digital connection that carries both video and audio data by way of an integrated mini-plug cable. Since HDMI technology is based on Digital Visual Interface (DVI), the jack on the back of your TV is also compatible with DVI components.

Note: If using a DVI component, remember to connect the audio cable because the DVI cable carries only the picture signal, not the sound.

Choose Your Connections

There are several ways to connect components, such as DVD players and set-top boxes, to your TV.

Note: Not all the cables are supplied with this unit. Please purchase the necessary cables. A high-speed HDMI cable is recommended for better compatibility.

Input	Signal Compatibility
Antenna/Cable	480i, 480p, 720p, 1080i (NTSC, ATSC, and QAM formats)
Composite Video	480i
Component Video	480i, 480p, 720p/60Hz, 1080i/60Hz, 1080p/60Hz
HDMI	480i, 480p, 720p/60Hz, 1080i/60Hz, 1080p/60Hz
PC	VGA SVGA XGA

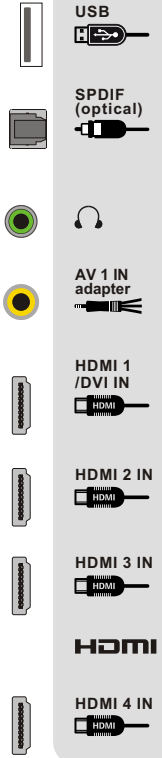

Connections and Setup

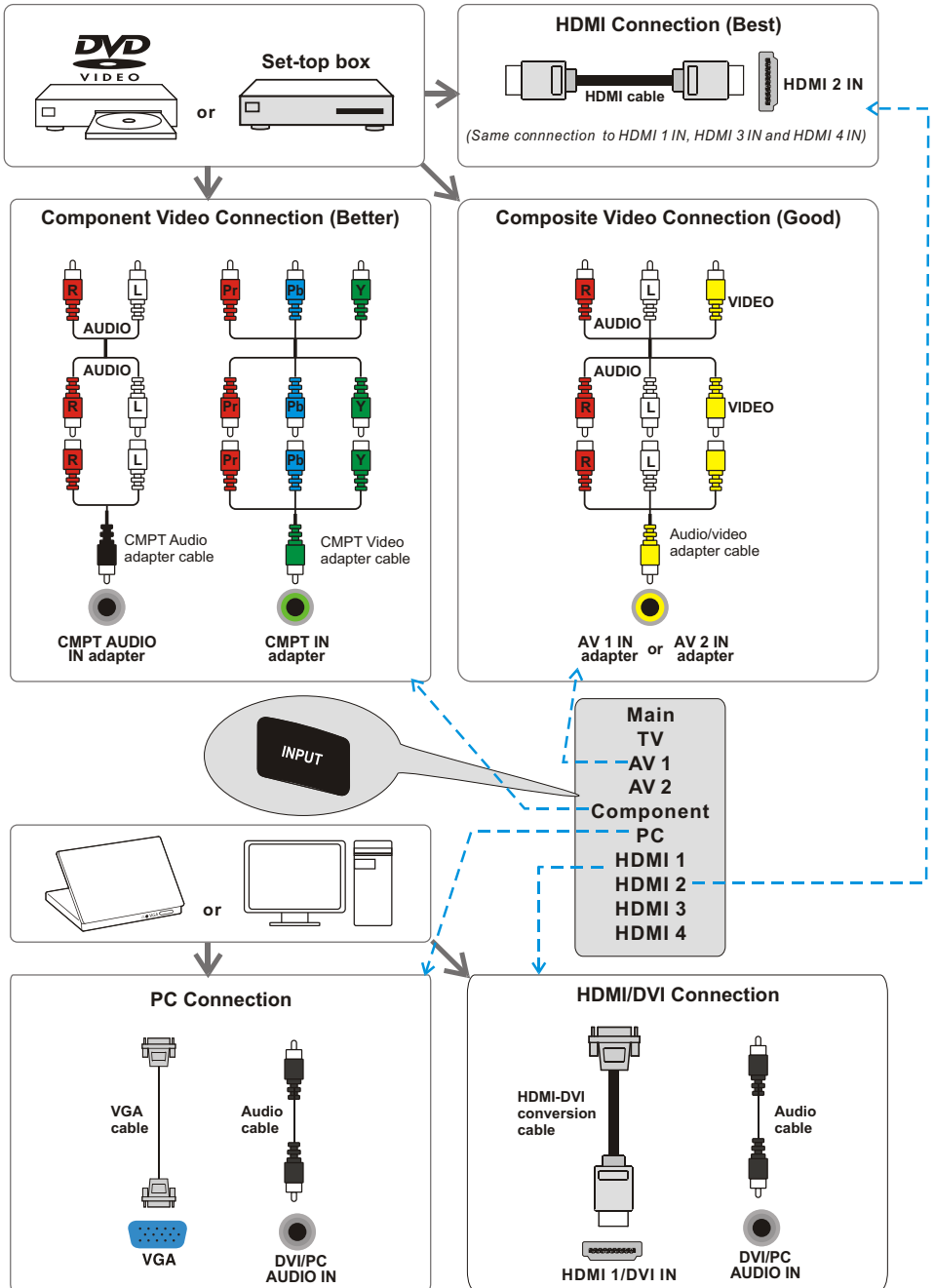

Connections and Setup

Network Connection

To access the Internet from this TV, you must separately subscribe to high speed broadband Internet service with your Internet Service Provider.

Your TV is internet-ready, and can be connected to your home network in two ways:

- Wired, using the RJ45 (Ethernet) connector on the back panel.
- Wirelessly, using the Wireless USB Adapter delivered with your TV and your home wireless network.

Note: following are just the usual ways to connect your TV to the wired or wireless network. The connection method may be different and you can make the connection depending on your actual network configuration. Please refer to your Internet Service Provider.

Connecting to a wired network

To connect to a wired network:

1. Ensure you have:
 - An ethernet cable long enough to reach your TV
 - A router or modem with an available Ethernet port
 - A high-speed internet connection
 - An **Ethernet port** on the back of the TV
2. Connect your ethernet cable to the router and to the **Ethernet port** on the back of the TV.
3. Use the **Network Setup** to configure the TV.

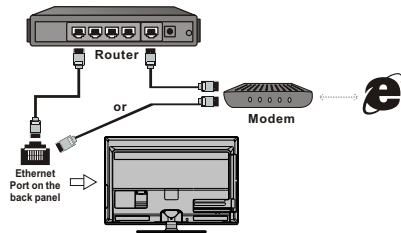

Network Setup

After you connect your home network to the TV, follow the steps below to configure your TV to be connected to the network.

Press **MENU** to display the main menu, select **Connection > Settings > Configuration**, press **OK/▶** to display its options:

Internet Connections This option allows you to turn Internet connection on or off. You must set in On mode to configure the following network settings.

Wired Network Setup

Select **Connection > Settings > Configuration > Interface**, press **◀/▶** to select **Ethernet** to connect to a wired network.

Connections and Setup

Wireless Network Setup

1. Select **Connection > Settings > Configuration > Interface**, press **◀/▶** to select **Wireless** to connect to a WiFi wireless network.

2. Select **Connection > Settings > Configuration > Wireless Setting**, press **OK/▶** to enter.

3. **Connection Methods**: you can setup the wireless network connection three ways.

- **Scan**

- Select **Wireless setting > Scan**, then press **OK/▶**, the TV will scan all available wireless networks within range. The networks found by the TV will be displayed.
- Select an available access point, then press **OK/▶** to connect the TV to it.

Notes:

- *If you select a secure wireless network, you will have to enter the corresponding password to access it.*
- *This TV will remember the password even if you switch on TV after power off.*

- **Manual**

Select **Wireless setting > Manual**, then press **OK/▶**, you will be prompted to enter the correct SSID of an available wireless router to setup the connection.

- **Auto**

If your wireless networks supports **WPS** (Wi-Fi Protected Setup), you can connect to the network via **PIN** (Personal Identification Number) or **PBC** (Push Button Configuration). WPS will automatically configure the SSID and WPA key in either mode.

Select **Wireless setting > Auto**, then press **OK/▶** to enter.

- **PIN**: select **PIN**, then press **OK/▶** to enter. Generate a random PIN code and make sure this code is installed to the AP (for the procedures, refer to your router manual), then press **OK/▶** again to setup the connection.
- **PBC**: If your router has a PBC push button, select **PBC**, then press **OK/▶** to enter. Press PBC push button on your router within 2 minutes after you press **OK/▶** again. Your TV will automatically acquire all the network setting values it needs and connect to your network.

Information

Select **Connection > Settings > Configuration > Information**, press **OK/▶** to display the information on current connection, such as Interface, Address type, IP address, etc..

IP setting







Select **Connection > Settings > Configuration > IP Setting**, then press **OK/▶** to enter the **IP setting** menu.

- Set **Address type** to **Auto**, it will acquire and enter the needed IP address automatically.
- You can follow below steps to enter your IP address manually if needed.
 - Set **Address type** to **Manual**, then press **▼** to go to the first entry field.
 - Enter the **IP address**, **Subnet mask**, **Default gateway**, **Primary DNS** and **Secondary DNS** values. Use the digit buttons on your remote control to enter numbers and the arrow buttons to move from one entry field to another.
- After setting, select **Connection > Configuration > Connection Test** to check the Internet connectivity again.

Connection Test

Select **Connection > Settings > Configuration > Connection Test**, then press **OK/▶** to check the Internet connectivity. If it doesn't work, follow above steps to ensure the connectivity or refer to your Internet Service Provider.

Remote Control Functions

-  (On/Off button) Turns the TV on or standby.
- 3D** Goes to 3D mode.
- 0-9** (Alphanumeric buttons) Enters a channel number, then press **OK** (or let the entry timeout). Enters a letter, a digit or a symbol in some functions.
 - (dot) To enter a digital channel with a sub-channel, enter the main channel; then, press the dot (**.**), the sub-channel, and then the **OK** button.
- INPUT** Opens the **Input** list; then press **INPUT** repeatedly to select the video input, or press (**▲/▼**) to highlight options, and press **OK** to select the desired option.
- VOL+/-** Increases or decreases the TV volume.
- CH+/-** Selects channels.
-  (**Mute**) Turns the volume on and off.
-  (**Connection**) Enters the Connection menu.
-  (**Yahoo**) Yahoo connected TV.
-  Goes to NETFLIX main page.
-  Goes to You Tube main page.
- MENU** Brings up the main menu or press to return to the previous menu; to access or exit virtual keyboard.
- ▲/▼◀▶** (arrows) Highlights different items in the TV menu and adjusts the menu controls.
- ZOOM+/-** Selects the desired screen format.
- OK** Displays Channel List menu. When the TV is in the menu system, press to confirm your selection.
- BACK** Returns you to the previously viewed channel.
- CANCEL** Exits the menu.
- INFO** If no menus are currently active, press the INFO button to display the Channel Banner.
- USB** Goes to the Media menu.
- TV** Goes to the TV mode.
- SLEEP** set the TV to turn off after a given amount of time.
- GUIDE** Toggles the Electronic Programme Guide between on and off. Only available for digital channels.
- FAV** Sets the favorite channel: select a channel first, then press FAV to open the menu, press **OK** to set this channel as your favourite. Set another favourite channel, press **▼** to move to the next line, and repeat the above step. Next time press FAV to display the favourite channel list, press **▲/▼** to select a favourite channel, and press **OK** to watch. **Note:** press **OK** once again will delete this channel from the favourite channel list.
- CH LIST** Displays the channel list menu.
- PIC** Selects picture mode.
- SOUND** Selects sound mode.
- CC** Enters the CC menu.
- Red/Green/Yellow/Blue Buttons** Reserved for future application.
 - ◀ (Previous) Goes to the previous chapter.
 - (Stop) Stops viewing.
 - ▶ (Play/Pause) Starts, pauses or resumes viewing
 - ▶ (Next) Goes to the next chapter.
 - ◀◀ Searches backward.
 - ▶▶ Searches forward.



Obtain the Signal

The first step in connecting your TV is obtaining the signal. The back panel of your TV allows you to receive analog and/or digital channels by using the **ANTENNA/CABLE/SAT IN**.

Connect the outside aerial or cable network to the **ANTENNA/CABLE/SAT IN** on the back of the TV set to receive off-air channels or cable channels.

- If you have a set-top box, you may need to call your cable company or satellite service provider. They may commend special cables to allow you to view digital channels.
- The aerial socket (75 OHM - VHF / UHF / cable) can be used for connecting an external aerial or other equipment fitted with a modulator (video recorder, satellite receiver, etc.). We recommend that you do not connect other equipment (video recorder, satellite receiver, etc.) to your TV set to begin with, so as not to complicate the set-up procedure with the additional steps involved. Connect them when you have finished setting up the channels.
- Visit www.antennaweb.org for help in deciding what type of antenna to use in order to receive the local digital channels available to you. Enter your location, and the program will list local analog and digital stations available using your antenna.

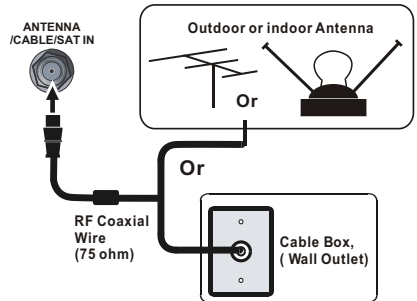

Switching On

Follow the instructions on this page on how to switch on your TV set and use the remote control before going on to following pages describing how to use the channel scan procedure.

1. Insert two AAA batteries in the remote control.

Precautions on using batteries:

- Only use the battery types specified.
 - Make sure you use the correct polarity.
 - Do not mix new and used batteries.
 - Do not use rechargeable batteries.
 - Do not expose batteries to excessive heat such as sunshine, fire or the like, throw them in a fire, recharge them or try to open them, as this could cause them to leak or explode.
 - Remove the batteries from the remote control if you are not using it for a long period of time.
2. Connect the power cable to a mains socket. (If the power cable is not connected to the television, please first connect the power cable to the television.) Your TV set should only be connected to an AC supply. It must not be connected to a DC supply. If the plug is detached from the cable, do not, under any circumstances, connect it to a mains socket, as there is a risk of electric shock.
 3. When powered on, if the TV set is in standby mode, press  on the remote control or on the TV set to turn on the TV.

Switching Off

To put the TV set into standby mode, press  on the remote control or on the TV, the TV set remains powered up, but with low energy consumption.

To switch off the TV set, unplug the mains socket from the mains outlet.

Initial Setup

Initial setup involves selecting all the settings required to be able to search for and store all the channels you can receive. Make sure that the television is switched on and follow all the steps in turn specified hereafter.

The first time you switch the set on, the Initial setup wizard opens, which guides you through the initial setup process. Press **OK** to start your initial setup.

1. Press **▲/▼** to select your language, then press **OK/▶** to enter the next screen.
2. A menu screen asks you to set the TV Location.
 - Choosing "**Home**" for the TV Location assigns the optimal picture settings for most home environments.
 - Choosing "**Retail**," which is not Energy Star compliant, sets the unit up with predefined settings for retail displays. In this setting, the power consumption may exceed the requirements of the Energy Star® qualification.

Use **▲/▼** to select the desired location setting (**Home/Retail**); then press **OK/▶** to continue to the next screen.

3. Use **▲/▼** to select the current local time zone. Press **OK/▶** to continue to the next screen.

4. On the **Tuner** screen, select either **Antenna** or **Cable**. Press **OK/▶** to continue to the next screen.

Note: If you are using a satellite or cable set-top box, you do not have to complete the Channel Scan.

5. The **Channel Scan** screen is now displayed. The default choice is to scan. Press **OK/▶** to begin the channel scan for available channels to be stored in the TV's memory.

Note: If you do not want to scan for channels at this time, press the **CANCEL** button to stop the scanning process.

6. The screen will change to show the progress of the scanning process.
7. When the scanning is finished, the unit has completed the Initial Setup.
8. Press **CANCEL** to exit the Wizard and begin watching TV.

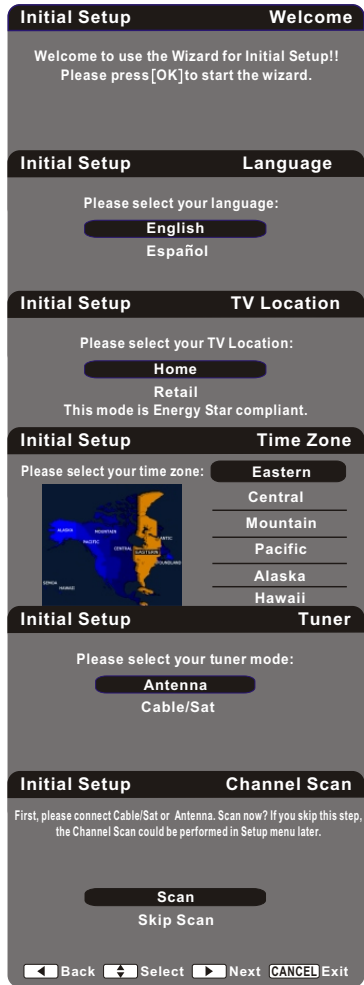

Menu Display

Following are just the illustration of the menu display. For some options such as **Advanced Settings** in the **Picture** menu, **Audio Language** in the **Sound** menu may be displayed in the next screen.

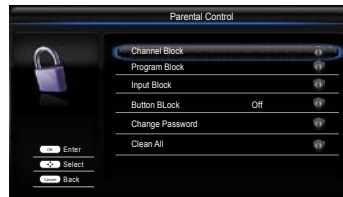
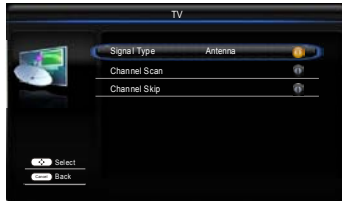
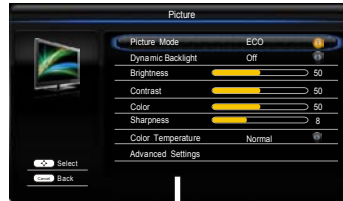

Using Menu System

This section explores the menus of your TV. Each menu is outlined and detailed to help you get the most from your TV. To access the menu system:

1. Press **MENU** to display the main menu.
2. Press **▲/▼/◀/▶** to select the desired item, then press **OK** to open the corresponding submenu.
3. In submenus, use **▲/▼** to select menu options, use **◀/▶** to set functions or change values. Press **OK** to activate a setting. Use **OK/▶** to open the corresponding submenu.
4. Press **MENU** to return to the previous menu or press **Cancel** repeatedly to close the menu.

Picture Menu

The menus for adjusting the picture are used to obtain the best picture settings according to your preference, the type of program you are watching and the ambient lighting.

Display the main menu by pressing **MENU** and select **Picture**, then press **OK** to confirm. The **Picture** options are as below:

Note: *some options may be not available for certain signal sources.*

Picture Mode: displays a list that lets you select one of the preset picture settings: **Natural**, **Sports**, **Personal** or **ECO**, **Vibrant**, **Cinematic**. Choose the setting that is best for your viewing environment.

Note: *ECO is the default setting, if you select some other options, the power consumption may change.*

Dynamic Backlight: this option automatically adjusts the brightness of the backlight according to the content of the incoming signal. **Dynamic Backlight** optimizes the picture quality and decreases power consumption.

Note: *When Light Sensor or Dynamic Backlight is set to Off, the power consumption may exceed the requirements of the Energy Star® qualification.*

Brightness: adjusts the brightness of the picture.

Contrast: adjusts the difference between light and dark areas of the picture.

Color: adjusts the richness of colour.

Sharpness: adjusts the crispness of the edges in the picture.

Color Temperature: Adjusts the color temperature of the picture. Use **◀/▶** to scroll through the color settings: **Cool** for a more blue palette of picture colors; **Standard**; and **Warm** for a more red palette of picture colors.

Advanced Settings: press **OK/▶** to display its submenu.

DNR(Dyanmic Noise reduction) – diminishes picture artifacts caused by the digitizing of image motion content that may be present in the picture. Press **◀/▶** to choose between these options: **Off/Low/Medium/High/Auto**.

MPEG NR (Noise Reduction): this feature allows you to reduce visible interference caused by MPEG compression.

DI Film Mode: Optimizes the picture for watching film. Select **Auto** or **Off**.

Blue Stretch: selects **On** or **Off**.

Note: *some options may appear in the next screen of Picture menu, you can press ▲/▼ to switch.*

Sound Menu

The **Sound** Menu lets you adjust audio output. Display the main menu by pressing **MENU** and select **Sound**, then press **OK** to confirm. The **Sound** menu appears with the following options:

Sound Mode: selects a sound mode from the list depending on the programme you *are watching*.

Balance: adjusts the amount of audio sent to the left and right speakers.

Sound Surround: selects for the simulated surround sound feature to be **On** or **Off**.

Speaker: selects to turn the internal speakers **On** or **Off**.

SPDIF Type : this option controls the type of audio stream sent to the Digital Audio Output (**SPDIF**) jack. Available options are **Dolby Digital**, **PCM**, or **Off**.

Auto volume control: select **On** mode to reduce the annoying blasts in volume during commercial breaks and also amplifies softer sounds in program material. Eliminates the need to constantly adjust the volume.

MTS: this option controls the manner in which the sound comes through your speakers. Options available vary according to the input selected.

Mono (available for regular TV viewing only): this option plays the sound in mono only. Use this setting when receiving broadcasts with weak stereo signals.

Stereo: this option splits the incoming stereo audio signal into left and right channels. Most TV programs and recorded materials have stereo audio.

Second Audio Program (SAP): this option plays the program's audio in a second language, if available. SAP audio is broadcast in mono only. SAP is also used to broadcast a program's audio with descriptions of the video for the visually impaired.

Default Audio Language: choose the language you prefer for dialog on digital channels. If the preferred language is not broadcasted with the program, then the TV plays the default audio for the program (usually **Eng-**

lish in the US). There are 2 available default languages (**English, Spanish**).

Note: The **Default Audio Language** option is only available for digital channels.

Current Audio Language: press ◀/▶ to choose from the list of languages available for the program you're watching. The language chosen becomes your preferred language for all digital channels until you turn the TV off. If the language chosen is not being broadcasted with a program, the TV plays the default language for the program (usually **English** in the US).

Note: The **Current Audio Language** option is only available for digital channels.

TV Menu

When you first used your TV you will have setup your TV for DTV / TV channels using the Initial Setup screens. If you did not do this or if your setup has changed, you can do this from the TV menu.

Signal Type: chooses the type of signal (**Cable/Sat or Antenna**) depending upon which equipment you have connected to the **ANT/CABLE/SAT IN**.

Channel Scan: selects this item and press **OK/▶** to start channel scan automatically. (**Note:** If you wish to stop the search, press the **Cancel** button.)

When you perform a Channel Scan, your TV searches for channels with signals and stores the channel information in the Channel List. Then, as you watch TV and press **CH+** or **CH-**, your TV goes to the next or previous channel in the Channel List and skips the channels that do not have signals.

If the TV signal source changes – for example, if you change from an outdoor antenna to cable TV – you will need to rescan for channels.

Channel Skip: After the TV has stored all of the available channels in memory you will find that some channels will be too weak to watch comfortably or they may be channels you do not want to see, you can hide these channels in the channel list.

Time Menu

Time Zone

You can set the correct Time Zone for your area.

To choose a time zone:

1. Select **Time > Time Zone**, then press **OK/▶** to open **Time Zone** screen
2. Press **◀/▶** to select the time zone for your area.
3. Press **MENU** to go back to the previous screen, or press **CANCEL** repeatedly to close the menu.

Daylight Saving selects **Auto** to set the daylight saving time for your area automatically.

Time: press **OK/▶** to open **Time** submenu

Auto synchronization: use **◀/▶** to select **On** or **Off**. If **On** selected, the TV will get the time automatically from DTV signals, and the Time item cannot be adjusted. If you select **Off**, you should set date and time at **Date** and **Time** item. Highlight **Date** or **Time**, use **◀/▶** to select input space, enter the current date or time by using the number buttons.

*Note: if **Off** selected, the time set in **Time** option will not be memorized when turning on the TV next time, and the TV's time will start from the default.*

Power on timer: use **◀/▶** to select **Once**, **On** or **Off**. If you select **Once** or **On**, you should set a time period after which the TV automatically switches to on at **Timer** below this item. Highlight **Timer**, use **◀/▶** to select input space, enter the on time using the number buttons.

Power on channel: press **OK/▶** to display its submenu. Highlight **Select mode**, use **◀/▶** to select **Last status**, the power on channel will be the last channel you watched before powered off. Or you can select **User select**, then press **▲/▼** to select the channel you want to watch when the TV is turned on automatically next time, and press **OK** to confirm.

Power off timer: use **◀/▶** to select **Once**, **On** or **Off**. If you select **Once** or **On**, you should set a time period after which the TV automatically switches to off at **Timer** below this item. Highlight **Timer**, use **◀/▶** to select input space, enter the off time using the digit keys.

Sleep timer: sets a period of time after which the TV set goes into standby mode. Use **◀/▶** to set the period (240 minutes maximum). To disable this function, select **Off**.

Connection Menu

Access to the Internet is required to use the features in this section. Please refer to the "**Network Connection**" part of the "**Connections and Setup**" section of this manual.

Note: More Internet applications will be upgraded later.

Kindly check with sales representative for more details and upgrading schedule.

Netflix

Netflix is available in certain countries. Unlimited membership required. More information at www.netflix.com. With a Netflix unlimited membership, instantly watch TV episodes & movies streamed over the Internet from Netflix right to your TV.

Select **Connections > Netflix**, and press **OK** to enter, then follow the options and hints appear on the screen to operate.

YouTube

YouTube is a place to discover and watch videos.

Select **Connections > YouTube**, and press **OK** to enter and follow the menu guide to operate.

Share & See

With **Share & See**, you can enjoy recorded video, picture, music and/or text files saved on your PC.

Adding media from your PC for sharing

Install a DLNA media server in your PC. One example is Microsoft Windows Media Player 11. Allow your TV to share the designated files on your PC.

1. Open Microsoft Windows Media Player 11.
 - Select **Library > Media sharing**.
 - Check the checkbox **Share my media to**.
 - Select the icon of the TV set connected to your PC.
 - Select **Allow** to allow the TV set to access your PC, and select **OK** to enable your allowing.
- Note: you can push **Settings** button to customize your desired settings.*
2. - Select **Library > Add to Library**.
 - Select your personal folders or folders of other users that you can access for sharing.
 - Select **Add** and press **OK** to enable your adding.

Share & See application

1. Select **Conenctions > Share & See**, then press **OK** to display its options.
2. Select **Photo** or **Music**. The same operation as **Photo**, **Music** or **Video** in **Media Menu**.

Settings

Configuration: this option helps to connect your TV to internet. For details please see "**Network Connection**" & "**Network Setup**".

Application:

Netflix: allows you logout the old user and log in new user of **Netflix**.

ESN: allows you get the local user ID automatically.

Media Menu

This connection allows you to insert a USB flash drive directly or connect a compatible mass storage device with USB, such as a digital camera, a multi-format card reader, or an MP3 player. If you have a USB drive, plug it into the drive directly. If you have a device with a USB port, connect one end of the USB cable to the USB port and the other end to the USB jack on the side of the TV. The USB feature on your TV allows you to play audio files (format supported: MP3) and video files (format supported: AVI, MPG, MPEG2) or display pictures (format supported: JPEG).

To access and adjust the options of the USB device, press **MENU** to display the main menu, then select **Media**, and press **OK** to enter the **Media** screen. Or you can press the **Media** button on the remote control to enter the **Media** screen directly.

Photo

To browse photos if available.

1. Select **Media > Photo (icon)**, then press **OK** to enter the main file content browser.
2. In the main file content browser, use **▲/▼/◀/▶** to select a photo or subfolder.
3. If there are photos in a certain subfolder, select the subfolder and press **OK** to enter.
4. Use **▲/▼/◀/▶** to select a photo or subfolder in either main or sub file content browser. Press **MENU** to display the menu. With the menu, you can do the operations like **Sort, Media Type, Thumbnail Size, or Recursive**.
5. Select a photo, press **OK** to watch, and a slide show begins from the selected photo. Press **MENU** to display the control menu. The menu options include **Pause/Play, Repeat, shuffle, Rotate, Zoom** and **Show Info**.
6. Press the related buttons on the remote control to perform the available functions shown on the function bar at the bottom of the TV screen.
7. Press Cancel to exit and go back to the previous menu.

Music

To playback music if available.

1. Select **Media > Music (icon)**, then press **OK** to enter the main file content browser.
2. In the main file content browser, use **▲/▼/◀/▶** to select a song or subfolder.
3. If there are songs in a certain subfolder, select the subfolder and press **OK** to enter.

4. Use **▲/▼/◀/▶** to select a song or subfolder in either main or sub file content browser. Press **MENU** to display the menu. With the menu, you can do the operations like **Sort, Media Type, Thumbnail Size, or Recursive**.
5. Select a song, press **OK** to play, and an automatic playback begins from the selected song. Press **MENU** to display the control menu. The menu options include **Pause/Play, Repeat, Show Info, Hide Spectrum, Lyric Options** and **Audio only**.
6. Press the related buttons on the remote control to perform the available functions shown on the function bar at the bottom of the TV screen.
7. Press Cancel to exit and go back to the previous menu.

Video

To watch video if available.

1. Select **Media > Video (icon)**, then press **OK** to enter the main file content browser.
2. In the main file content browser, use **▲/▼/◀/▶** to select a video or subfolder.
3. If there are videos in a certain subfolder, select the subfolder and press **OK** to enter.
4. Use **▲/▼/◀/▶** to select a video or subfolder in either main or sub file content browser. Press **MENU** to display the menu. With the menu, you can do the operations like **Sort, Media Type, Thumbnail Size, or Recursive**.
5. Select a video, press **OK** to play, and an automatic playback begins from the selected video. Press **MENU** to display the control menu. The menu options include **Pause/Play, Repeat, Show Info, Picture Mode, Screen Mode**.
6. Press the related buttons on the remote control to perform the available functions shown on the function bar at the bottom of the TV screen.
7. Press Cancel to exit and go back to the previous menu.

Parental Menu

The choices in the US V-Chip and Canada V-Chip menus involve software inside your TV, referred to as V-Chip, which allows you to block TV programs and movies. TV programs can be blocked by age-based ratings, such as TV-MA. If available, TV programs can also be blocked by content, such as adult language (L). Movies can only be blocked by age-based ratings. Once you block programs, you can unblock them by entering a password. By default, the software inside your TV is turned off or unlocked.

V-Chip reads the program's age-based rating (TV-MA, TV-14, etc.) and content themes (Violence (V), Adult Language (L), etc.). If you have blocked the rating and/or content themes that the program contains, you receive a message that the channel is currently blocked. Change the channel or to enter your password and temporarily deactivate the parental controls.

Broadcasters are not required to provide content themes, so programs received with no content themes are blocked only if you block their age-based rating. You can also block programs that have been given an Exempt rating, and programs that are considered unrated.

Change V-Chip Password

The first time you enter the **Parental Control** menu, you must enter the default code (1234) in order to adjust other parental control settings. You can set a personal V-Chip Password first, follow these steps:

1. Select **Parental Control > Change Password**, press **OK/▶** to enter the **Change Password** screen.
2. Use the number buttons to enter the four-digit number for your password.
3. Re-enter the same code to confirm the password.

Note: *the password must be entered before the TV will continue with Parental settings next time. The super password is 5351. If you forget your password, enter it to override any existing password.*

Channel Block

To block a specific channel, follow these steps:

1. Select **Parental Control > Channel Block**, press **OK/▶** to enter the next screen with channel list on.
2. Press **▲/▼** to select the channel you wish to block.
3. Press **OK** to place a checkmark in the box to block that channel. When you tune to that channel, you will need to enter a password to view the channel programming.

Program Block

Press **OK/▶** to display its submenus:

Rating Enable

Select **Parental Control > Program Block > Rating Enable**, then press **◀/▶** to turn this option on or off. You must remember to set **Rating Enable to On** mode to have the following V-Chip rating limits to take effect.

U.S. TV Ratings

You can automatically block all program ratings above a specified age-based rating level.

1. Select **Parental Control > Program Block > U.S. TV Ratings**, press **OK/▶** to enter the **U.S. TV Ratings** screen.

In the Block TV Rating panel you can customize the program blocking of the following TV ratings:

- TV-Y** All children
- TV-Y7** Children 7 years and older
- TV-G** General audience
- TV-PG** Parental guidance suggested
- TV-14** Parents strongly cautioned
- TV-MA** Mature audience only

You can also customize the TV ratings for the following content:

- A** Sexual dialog
- D** Sexual explicit dialog
- L** Adult language
- S** Sexual situations
- V** Violence
- FV** Fantasy violence

2. Press **▲/▼/◀/▶** to navigate through the TV rating options. Press **OK** to block (locked) or allow (unlocked).

U.S. Movie Ratings

You can automatically block all program ratings above a specified age-based rating level.

1. Select **Parental Control > Program Block > U.S. Movie Ratings**, press **OK/▶** to enter the **U.S. Movie Ratings** screen.

In the Block Movie Rating panel you can customize the program blocking of the following Movie ratings:

- G** General audience
- PG** Parental guidance suggested
- PG-13** Unsuitable for children under 13
- R** Restricted, under 17 requires accompanying parent or adult guardian
- NC-17** No one under 17 admitted
- X** Mature audience only

2. Press ▲/▼ to navigate through the Movie rating options. Press the OK button to block (locked) or allow (unlocked).

Canadian English/French Ratings

If you receive Canadian programs, you can block Canadian English and French V-Chip by ratings only. When you block a particular rating, you automatically block the higher-rated programs as well. To block Canadian English and French program ratings, follow these steps:

1. Select **Parental Control > Program Block > Canadian English Ratings** or **Canadian French Ratings**, press **OK/▶** to enter the next screen.

Canadian English Ratings:

- C** Children
- C8+** Children 8 and older
- G** General audience
- PG** Parental guidance
- 14+** Viewer 14 and over
- 18+** Adult

Canadian French Ratings:

- G** General audience
- 8 ans+** Viewer 8 and older
- 13 ans+** Viewer 13 and older
- 16 ans+** Viewer 16 and older
- 18 ans+** Adult

2. Press ▲/▼ to navigate through the rating options. Press **OK** to block (locked) or allow (unlocked)

Open V-Chip

allows you to select the downloadable rating level. In the event that a new rating system is provided by the broadcaster, the new rating options would appear within this menu.

Blocking Unrated/Exempt Programs

The **Unrated/Exempt Ratings** option lets you decide if programs that the V-Chip recognizes as unrated can be viewed. Unrated TV programs may include news, sports, political, religious, local and weather programs, emergency bulletins, public announcements, and programs without ratings.

Select this option, then press ◀/▶ to toggle between **On(View)** and **Off (Block)**.

Reset Downloadable Data

Select this option, a confirmation box opens, then press ◀/▶ to select, then press **OK** to reset the downloadable rating data, if present.

Input Block

1. Select **Parental Control > Input Block**, press **OK/▶** to display the Input source list screen.
2. Press ▲/▼ select the video input you want to lock. then press **OK** to to confirm your selection. A locked / unlocked icon appears next to the selected input. When you tune to that input, you will need to enter a password to view the channel.

Button Block

This option allows you to block (disable) or unblock (enable) the TV panel buttons. The remote control still tunes to any channel. If you are using this to keep children from changing channels, be sure to remove access to any remote that is capable of operating the TV while you have the TV panel button blocked. To block the TV panel buttons, select **Parental Control > Button Block**, and press ◀/▶ to choose the On option.

Clean All

This option allows you to unlock all locked channels. Press **OK** to enter, use ◀/▶ to select **OK**, press **OK** to confirm.

Setup Menu

The **Setup** menu allows you to configure the TV with your preferences.

Display the main menu by pressing **MENU** and select **Setup**, then press **OK** to display its options:

OSD Language

Press ◀/▶ to select the preferred language (English or Espanol) for all menus.

Screen Mode

This option allows you to cycles through the available screen formats.

Closed Caption

Many programs are encoded with closed captioning information, which allows you to display the audio portion of a program as text on the TV screen

Note: *Closed caption settings are not available for HDMI, CMPT or PC INPUTS. These settings must be set in the connected component's menu. Closed captioning is not available on all channels at all times. Only specific programs are encoded with closed captioning information.*

The Closed Caption options are:

CC Setting: this option allows you to choose the way closed captioning information appears on the screen.

Off - No captioning information displayed.

On - Chooses this option if you want captioning information to be shown whenever available.

On When Muted - This option allows the closed captioning to display (when available) whenever the TV's sound is muted. The captioning information is not displayed when the sound is not muted.

Analog Closed Caption: this option lets you select the captioning mode used for displaying caption information, when available. If you are unsure of the differences among the modes, you may prefer to leave the closed captioned mode set to CC1, which displays complete text of the program in the primary language in your area.

Digital CC Type: if available, this allows you to select a closed caption service mode (1-6) for digital channels.

Digital CC Style: press **OK/▶** to display its options:

Caption Style - Selects either **As Broadcaster** or **Custom** options. If you choose **Custom** options, the setting changes according to the following options you choose.

Digital CC Size - Sets the size of the digital closed caption text.

Digital CCFont - Selects a character design for the digital closed caption text. A font is a complete assortment of letters, numbers, punctuation marks, etc. in a given design. You can choose from a variety of fonts.

Digital CC Color - Sets the color of the digital closed caption text.

Digital CC Opacity - Sets the appearance of the digital closed caption text.

Digital CC Background Color - lets you set the color of the area behind the digital closed caption text.

Digital CC Background Opacity - lets you set the appearance of the area behind the digital closed caption text.

Window Color - lets you set the edge color.

Window Opacity - lets you set the edge type.

System Information

This option allows you to see the system information including Panel ID, SW Version, Service Model No..

Software Upgrade

This option allows you to upgrade software through web-site or USB if available.

Esticker

This option allows you to see the estickers, you should choose **Home** or **Shop**, and press **Menu** on the remote control two times, then the estickers will be viewable after two minutes.

Reset Default

This option resets all settings (except parental control settings) to the factory defaults. When you select this option, a confirmation box opens (**Note: If some channels are blocked, you must enter the V-chip password, then you can follow the operation below**).

1. Press **◀/▶** to select **OK** or **Cancel**.
2. Press **OK** to confirm your selection.

Frequently Asked Questions (FAQs)

What's the quickest way to view High Definition (HD) video?

Connect an off-air antenna to the ANT/CABLE/SAT IN to view free local digital channels. You may need to purchase an antenna.

Visit www.antennaweb.org for assistance in deciding what type of antenna to use to receive the local digital channels available to you. By entering your location, this mapping program tells you which local analog and digital stations are available using a certain antenna.

Are there other ways to view High Definition (HD) video?

Besides using an off-air antenna as mentioned above, you can also use a set-top box to receive digital video. Contact your cable company or satellite provider to purchase digital programming and have them connect the box to ensure you are viewing channels the best way.

How do I tell an analog channel from a digital channel?

Press the INFO button to display the Channel Banner. Look at the bottom right corner of the screen. The dot (•) is displayed for a digital channel. If there is no dot, it is an analog channel.

Why are there bars on my screen and can I get rid of them?

Most digital video is sent in a 16/9 format which fills your screen, but is sometimes sent in 4/3 which does not fill your screen. It depends on how the station or device connected to your TV is formatting the video. If there are bars on the screen, press the ZOOM +/- button to try a different format that may eliminate the bars. Some bars can't be removed because of the way the format is sent by the broadcaster. The format changes as you press the ZOOM +/- button and the format type is displayed at the bottom of the screen.

Why does channel search find a lot of channels, but when I try to tune to them, there's nothing there?

Some channels enabled by the cable company don't carry programming, such as video ondemand. When channels are unavailable, your TV screen is blank or appears like snow. You probably want to remove these channels from your Channel List. Remove these in the Channel Skip Menu.

Why does the first channel search take a long time?

If you have both analog and digital channels, the TV is looking for all available channels in the Channel List. If you do have digital channels, the TV is also searching for scrambled channels, non-scrambled channels, and each sub-channel of that digital channel.

Is Netflix free?

No, you must create a Netflix user account and subscribe to Netflix service.

I am having difficulty accessing Netflix or other subscription based services.

Please contact the service provider directly to resolve content related issues.

I forget my secure access code.

Please refer to the user manual for your router.

Troubleshooting

Most problems you encounter with your TV can be corrected by consulting the following troubleshooting list.

TV Problems

The TV won't turn on.

- Make sure the TV is plugged in.
- Check the wall receptacle (or extension cord) to make sure it is "live" by plugging in another device.
- The TV panel controls may be locked (disabled). Use the remote control to unlock the TV panel controls.
- Select the Button Block feature on the Parental Control menu and press **OK** to uncheck the box.

There is no picture and no sound but the TV is on.

- You may be tuned to an input with no component connected to it. If you're trying to view a connected component, press **INPUT** until the picture from that component appears.
- The Signal Type option may be set incorrectly.
- The channel may be blank. Try changing channels.
- If you're watching your VCR and it's connected with coaxial cable to the **ANT/CABLE/SAT IN** jack, tune the TV to channel 3 or 4 (whichever channel is selected on the 3/4 switch on the back of your VCR). Also make sure the TV/VCR button on the VCR is in the correct mode (press the TV/VCR button on your VCR).

The sound is fine, but the picture is poor quality.

- If you're getting a black and white picture from a component you've connected to your TV, you might have your video cables connected to the wrong jacks. A yellow video cable connects to the yellow VIDEO INPUT jack on the side or back of your TV; three video cables or bundled component video cables (red, blue, and green) connect to the corresponding COMPONENT INPUT jacks on the back of your TV.
- Check the antenna connections. Make sure all of the cables are firmly connected to the jacks.

There is no sound, but the picture is fine.

- The sound might be muted. Try pressing the volume up button to restore sound.
- If using DVI or Y, PB, PR, remember to also connect the device's left and right audio output jacks to the TV's L and R AUDIO INPUT jacks.
- The sound settings may not be set correctly.
- If your audio source has only one jack or is a (mono) audio source, make sure you have plugged the connection into the L AUDIO INPUT jack on the TV.

The screen is blank.

- Check your connections. If you used yellow, red, and white cables to connect, make sure they're connected to the red, white, and yellow AUDIO/VIDEO INPUT jacks on the side or back of the TV.
- If you're trying to watch something that's playing on a component connected to the TV (like a DVD), press **INPUT** until you get to the correct video input channel.
- Make sure the component connected to the TV is turned on.
- Try another channel.

The buttons on the TV panel don't work.

- The TV panel controls may be locked (disabled). Use the remote control to unlock the TV panel controls by selecting the Button Block feature in the Parental Control Menu and press ◀▶ to uncheck the box.
- Unplug the TV for 10 minutes and then plug it back in. Turn the TV on and try again.

The TV turns off unexpectedly.

- The electronic protection circuit may have been activated because of a power surge. Wait 30 seconds, and then turn the TV on again. If this happens frequently, the voltage in your house may be abnormally high or low.
- Unplug. Wait 10 minutes. Plug in again.

You can't select a certain channel.

- The channel may be blocked or not approved in the **Parental Control** Menu.
- If using a VCR, check to make sure the **TV/VCR** button on the VCR is in the correct mode (press the **TV/VCR** button on your VCR).
- Press the **TV** button and then try to change channels.

The stereo reception is noisy.

- It may be a weak station. Use the Sound Menu and Analog TV Sound to choose mono.

A black box appears on the screen.

- Closed captioning might be on. Check Closed Caption in the Setup menu.

You are having problems with the HDMI Connection.

- Make sure the HDMI or DVI component is turned on and the cables are firmly connected. If problems still occur, turn off your component and reconnect it. Reset the power by unplugging the power cord and plugging it back in.
- If you are tuned to the **HDMI 1**, or other **HDMI** INPUT and you're receiving Unusable Signal message screen, press the **INFO** button on the remote. If Acquiring Channel appears in the **Channel Banner**, the HDMI or DVI device isn't responding. Contact the manufacturer of the HDMI or DVI device for further assistance.
- If you tune to the **HDMI 1**, or other **HDMI** INPUT and you see snow, the video goes in and out, or the video takes a long time to appear, your HDMI or DVI component is having trouble sending video information to the TV. Reconnect your device. Reset the power by unplugging the power cord and plugging it back in. If problems persist, try connecting the Y Pb Pr jacks if they are available or contact the manufacturer of the HDMI or DVI component for further assistance.
- If you have black bars on each side of your picture, the component you connected might have a switch or a menu option allowing you to change the picture quality output that will fix this. Choose either 720p or 1080i.

You cannot access the Internet even though an ethernet cable and/or Wireless USB Adapter is connected.

- Check another device to the modem. Does it work properly?
- Confirm your network settings on the TV.

My Internet connection is fast, but my access to the Internet is slow.

- Your real access speed is determined by many factors. Activity such as file sharing, multiple users, gaming and other video streaming all use bandwidth.
- Your ISP could be delivering speeds slower than usual or speeds insufficient to properly operate the online service you are trying to access. Please contact your ISP.

The remote control doesn't work.

- Something might be between the remote and the remote light sensor on the front of the TV. Make sure there is a clear path.
- The remote may not be aimed directly at the TV.
- The batteries in the remote may be weak, dead, or installed incorrectly. Put new batteries in the remote.

The Universal Remote control doesn't work.

This TV utilizes new remote control signals and may not be compatible with your existing universal remote (e.g. satellite box remotes, cable box remotes, and generic universal remotes, etc.). Over time, newer universal remotes will become available that should pick up the new TV codes.

You are experiencing problems with V-Chip/Parental Controls.

If the rating limits don't work, you must lock the settings. Go to the Main Menu (press MENU on your remote), select **Parental > Program Block > Rating Enable**, Rating Enable is highlighted. Press ◀/▶ to select On to have the rating limits take effect.

What else can I do?

If you've been through the Troubleshooting section and nothing has fixed your problem, try rebooting your TV. Note that after a reboot, you may need to run your TV through the setup process again. To do a reboot, unplug the power cord from the wall outlet or power strip. Keep your TV unplugged for about 5 minutes. Then plug in the TV and turn it on. See if the problem is fixed. If the problem remains, then please visit www.tclusa.com for updated FAQs or contact TCL Customer Support at the support number provided in your Warranty under "How To Get Service."

Care and Cleaning

Caution: Turn OFF your TV before cleaning.

You can clean the TV as required, using a soft lint-free cloth. Be sure to occasionally dust the ventilation slots in the cabinet to help assure adequate ventilation.

IMPORTANT: Never use strong cleaning agents, such as ammonia-based cleaners, or abrasive powder. These types of cleaners will damage the TV. The TV's screen may be cleaned with a soft, lint-free cloth as well. Take care not to scratch or mar the screen. If necessary, you may use a cloth dampened with warm water. While cleaning, do not spray liquid directly on the screen, or allow liquid to run down the screen and inside the TV. Also, never place drinks or vases with water on top of the TV. This could increase the risk of fire, shock hazard or damage to the TV.

Television Specifications

Broadcasting system	US System NTSC-M ATSC standard (8VSB), QAM
Receiving Channels	VHF2-13 UHF14-69 CATV 14-36 (A)-(W) 37-59 (AA)-(WW) 60-85 (AAA)-(ZZZ) 86-94 (86)-(94)95-99 (A-5)-(A-1) 100-135 (100)-(135) 01 (4A)
Tuner type	Frequency synthesized
Screen refresh rate	60Hz

TTE Technology, Inc. (“TTE”) Limited Warranty

All LCD/LED Models

EXCEPT TO THE EXTENT PROHIBITED BY APPLICABLE LAW, THIS WARRANTY DOES NOT COVER, AND AS DESCRIBED BELOW TTE EXPRESSLY DISCLAIMS, ALL ACTUAL AND IMPLIED WARRANTIES WITH RESPECT TO ANY PRODUCT USED FOR INSTITUTIONAL OR OTHER COMMERCIAL PURPOSES (INCLUDING BUT NOT LIMITED TO RENTAL PURPOSES).

What your warranty covers: Defects in materials or workmanship to the original owner of this TCL product when purchased from an Authorized Dealer of TCL brand products and packaged with this warranty statement.

New LCD/LED Televisions

For how long after your purchase:

- Two (2) years from date of purchase for parts.
- Two (2) years from date of purchase for labor.

What we will do:

- At TTE’s discretion, pay an Authorized TCL Service Center for both labor charges and parts to repair your television, or replace your television with a new or refurbished/remanufactured unit. See “How to get service”.

How to get service:

- Call **1-877-300-8837**. Please have your unit’s date of purchase, place of purchase and model/serial number ready. The model/serial number information can be found on the back of your unit.
- A representative will troubleshoot your problem over the phone. If it is determined that your unit requires service, the service location will be at the sole discretion of TTE based upon the TTE Limited Warranty statement.

- At the sole discretion of TTE, television screen sizes 32” and smaller will either be repaired at an Authorized TCL Service Center or directly exchanged for a new or refurbished/remanufactured unit. At the sole discretion of TTE, television screen sizes 33” through 55” will either be repaired at an Authorized TCL Service Center or repaired in-home.

If repaired at an Authorized TCL Service Center, TTE is not responsible for transportation costs to the Authorized TCL Service Center. However, TTE will pay for return shipping. TTE will provide instructions for packaging and shipping the unit. Proof of purchase in the form of a bill of sale or receipted invoice from an Authorized Dealer which is evidence that the product is within the warranty period must be presented to obtain warranty service.

What your warranty does not cover:

- Customer instruction. (Your Owner’s Manual describes how to install, adjust, and operate your unit. Any additional information should be obtained from your Authorized Dealer.)
- Installation and related adjustments.
- Damage resulting from non-approved installation methods.
- Signal reception problems not caused by your unit.
- Damage from misuse or neglect.
- Batteries.
- A television that has been modified or incorporated into other products or is used for institutional or other commercial purposes (including but not limited to rental purposes).
- A unit purchased or serviced outside the USA.
- A unit sold as is or with all faults
- Acts of nature, such as but not limited to lightning damage.
- Special, incidental or consequential damages.

TTE Technology, Inc. (“TTE”) Limited Warranty

Product Registration:

Please register your TCL purchase on-line at www.tclusa.com. It will make it easier to contact you should it ever be necessary. Registration is not required for warranty coverage.

Limitation of Warranty:

- THE WARRANTY STATED ABOVE IS THE ONLY WARRANTY APPLICABLE TO THIS PRODUCT. NO VERBAL OR WRITTEN INFORMATION GIVEN BY TTE TECHNOLOGY, INC., ITS AGENTS OR EMPLOYEES SHALL CREATE A WARRANTY OR IN ANY WAY INCREASE OR MODIFY THE SCOPE OF THIS WARRANTY.
- REPAIR OR REPLACEMENT AS PROVIDED UNDER THIS WARRANTY IS THE EXCLUSIVE REMEDY OF THE CONSUMER. TTE TECHNOLOGY, INC. SHALL NOT BE LIABLE FOR SPECIAL, INCIDENTAL OR CONSEQUENTIAL DAMAGES RESULTING FROM THE USE OF THIS PRODUCT OR ARISING OUT OF ANY BREACH OF ANY EXPRESS OR IMPLIED WARRANTY ON THIS PRODUCT. THIS DISCLAIMER OF WARRANTIES AND LIMITED WARRANTY ARE GOVERNED BY THE LAWS OF THE STATE OF CALIFORNIA. EXCEPT TO THE EXTENT PROHIBITED BY APPLICABLE LAW, ANY IMPLIED WARRANTY OF MERCHANTABILITY OR FITNESS FOR A PARTICULAR PURPOSE ON THIS PRODUCT IS LIMITED TO THE APPLICABLE WARRANTY AND WARRANTY PERIOD SET FORTH ABOVE.

How State Law relates to this warranty:

- Some states do not allow the exclusion nor limitation of incidental or consequential damages, or limitations on how long an implied warranty lasts, so the above limitations or exclusions may not apply to you.
- This warranty gives you specific legal rights, and you also may have other rights that vary from state to state.

If you purchased your unit outside the United States or seek warranty coverage outside the United States: This warranty does not apply. Contact your dealer for warranty information.

Service calls which do not involve defective materials or workmanship are not covered by this warranty. Costs of such service calls are the sole responsibility of the purchaser.



This product incorporates HDMI technology. HDMI, the HDMI logo, and High-Definition Multimedia Interface are trademarks or registered trademarks of HDMI Licensing LLC.



ENERGY STAR is a set of power-saving guidelines issued by the U.S. Environmental Protection Agency (EPA).



ENERGY STAR is a joint program of the U.S. Environmental Protection Agency and the U.S. Department of Energy helping us all save money and protect the environment through energy efficient products and practices.



Manufactured under license from Dolby Laboratories.

“Dolby” and the double-D symbol are registered trademarks of Dolby Laboratories.

This product contains technology subject to certain intellectual property rights of Microsoft technology outside of this product is prohibited without the appropriate license(s) from Microsoft.

Content owners use Microsoft PlayReady™ content access technology to protect their intellectual property, including copyrighted content. This device uses PlayReady technology to access PlayReady protected content and/or WMDRM-protected content. If the device fails to properly enforce restrictions on content usage, content owners may require Microsoft to revoke the device's ability to consume PlayReady-protected content. Revocation should not affect unprotected content or content protected by other content access technologies. Content owners may require you to upgrade PlayReady to access their content. If you decline an upgrade, you will not be able to access that require the upgrade.

FCC Information

This equipment has been tested and found to comply with the limits for a Class B digital device, pursuant to Part 15 of the FCC Rules. These limits are designed to provide reasonable protection against harmful interference in a residential installation. This equipment generates, uses, and can radiate radio frequency energy and, if not installed and used in accordance with the instructions, may cause harmful interference to radio communications. However, there is no guarantee that interference will not occur in a particular installation. If this equipment does cause harmful interference to radio or television reception, which can be determined by turning the equipment off and on, the user is encouraged to try to correct the interference by one or more of the following measures:

- Reorient or relocate the receiving antenna.
- Increase the separation between the equipment and receiver.
- Connect the equipment into an outlet on a circuit different from that to which the receiver is connected.
- Consult the dealer or an experienced radio/TV technician for help.

This Class B digital apparatus complies with Canadian ICES-003.

Please do not send any products to the California address listed in this manual or on the carton. This will only add delays in service for your product.



TTE Technology, Inc.

TCL and associated marks are trademarks of TCL S.A. used under license to TTE Corporation.

Part No.: 72-MT25NA-X001B