

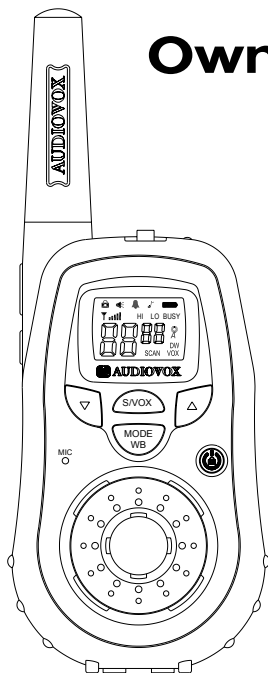

**General Mobile Radio Service (GMRS)
Model: GMRS1202**

Owner's Manual



Customer Service
1-800-290-6650

128-7032B
1 of 28



THIS PAGE LEFT BLANK INTENTIONALLY





CAUTION

SAFETY INFORMATION

Your wireless hand-held portable transceiver contains a low power transmitter. When the PTT button is pushed (or the VOX mode is enabled) it sends out radio frequency (RF) signals. The device is authorized to operate at a duty factor not to exceed 50%. In August 1996, the Federal Communications Commissions (FCC) adopted RF exposure guidelines with safety levels for hand-held wireless devices.

Important: To maintain compliance with the FCC' s RF exposure guidelines hold the transmitter at least 1 inch (2.5 centimeters) from your face and speak in a normal voice, with the antenna pointed up and away. If you wear the handset on your body while using the headset accessory, use only the Audiovox supplied carry clip for this product and ensure that the antenna is at least 1 inch (2.5 centimeters) from your body when transmitting. Use only the supplied antenna. **Do not use your transceiver with a damaged antenna.** Unauthorized antennas, modifications, or attachments could damage the transmitter and may violate FCC regulations.

Performance:

Your transceiver will only achieve its maximum operating range when communicating with other transceivers across open and flat areas or between elevated points. Normally occurring environmental factors such as buildings, trees, terrain and weather, or interference from other radio or electrical equipment, may have adverse effects on the transceiver's effective range. These are not indicative of a fault condition.

Avoid placing the GMRS1202 radio transceiver for prolonged periods of time in direct sunlight or temperatures below -4°F (-20°C) or above 140°F (60°C).

Place the rubber cover on jacks when not in use.

WARNINGS:

Battery Care

Never attempt to charge alkaline or dry cell batteries, as batteries may burst causing personal injury and damage to the product. If rechargeable batteries are used, such as Nickel Metal Hydride (NiMH), use only Audiovox-approved rechargeable batteries. Use of the optional Audiovox charger with other brands of batteries is not recommended, as battery charging times will vary with different brands. Refer to the Manufacturer's instructions for charging other brands of batteries.

Battery Disposal

In general, if handled improperly, batteries pose a risk of fire or burns. Do not disassemble, crush, puncture, short external contacts, or dispose of the batteries in fire or water. Dispose of the batteries in an environmentally safe manner and recycle whenever possible.

FCC WARNING

Replacement or substitution of transistors, diodes or other parts of a unique nature, with parts other than those recommended by the manufacturer, may cause a violation of the technical regulations of Part 15 of FCC Rules.

GMRS LICENSE:

USE OF THIS RADIO WITHIN THE UNITED STATES REQUIRES AN FCC GMRS LICENSE. AN INDIVIDUAL 18 YEARS OF AGE OR OLDER, WHO IS NOT A REPRESENTATIVE OF A FOREIGN GOVERNMENT, IS ELIGIBLE TO APPLY FOR A GMRS SYSTEM LICENSE. YOU WILL NEED TWO FORMS FROM THE FCC: FCC FORM 159, AND FCC FORM 605 (MAIN FORM AND SCHEDULE F). YOU CAN FIND THE FORMS ONLINE AT: [HTTP://WWW.FCC.GOV/FORMPAGE.HTML](http://www.fcc.gov/formpage.html), OR CALL 1-800-418-3676.

Model GMRS1202 (FCC License Required)

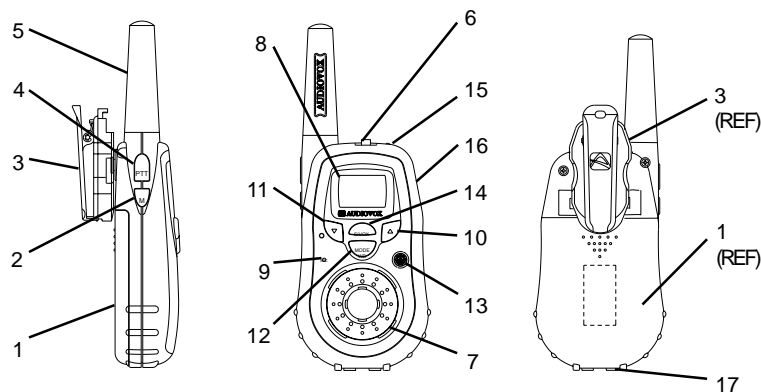

- | | |
|---|---------------------------------|
| 1. Battery Door | 9. Built-in Microphone |
| 2. Monitor/Backlight Button | 10. Up Channel/Volume Button |
| 3. Detachable Carry Clip | 11. Down Channel/Volume Button |
| 4. Push-To-Talk (PTT) Button | 12. MODE/Weather Button |
| 5. Antenna | 13. Power On/Off Keylock Button |
| 6. External Speaker(SPK)/Microphone (MIC)/Charge (CHG) Jack | 14. SCAN/VOX Button |
| 7. Built-in Speaker | 15. White Flashlight LED |
| 8. Liquid Crystal Display (LCD) | 16. Flashlight Enable Button |
| | 17. Battery Charging Contacts |

Model GMRS1202 DISPLAY

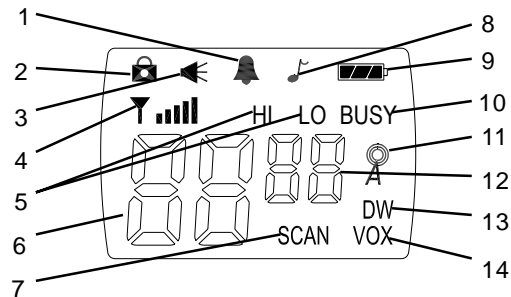

- 1. Beep Tone Indicator:** Icon appears when beep button confirmation tone is selected; icon disappears when tone is off.
- 2. Key Lock Indicator:** Icon appears when the keypad is locked. This function disables keys such as channel up/down, SCAN and MODE.
- 3. Monitor Indicator:** Icon appears when the Monitor (**M**) button is pressed and the channel monitor function is activated.
- 4. Signal Strength Indicator:** Icon appears when a signal is being transmitted. The icon consists of five bars to indicate transmit signal power level.
- 5. HI/LO Indicators:** Power level indicator appears when the transmit power is set to desired output power on the GMRS channels.
- 6. Large Segment Display:** Indicates the channel number in use.
- 7. Scan Indicator:** This function allows the user to scan a channel (and tone code, if present) every .5 second to search for a valid signal.
- 8. Roger Beep Tone On/Off Indicator:** This icon appears when the Roger Beep tone is on, and disappears when tone is not in use.
- 9. Battery Level Indicator:** Icon indicates the battery charge level.
- 10. Signal Receive Indicator: BUSY** icon appears when a signal is being received.
- 11. Weather Mode Indicator:** Icon will be on steady when in the weather band mode. When in the GMRS/FRS mode, the icon will blink when the alert is active

12. Small Segment Display: Displays the CTCSS tone option for each main channel from **01-38**.

13. Dual Watch Mode Indicator: Indicator appears when dual watch mode is active.

14. Voice Activated Transmission (VOX) Indicator: This function allows hands free conversation. The indicator appears when the VOX mode is activated.

Equipment and Accessories Supplied

- | | |
|----------------------------------|-----------|
| 1. Radio (2) | GMRS1202 |
| 2. Owner's Manual | 128-7032A |
| 3. Earbud with Remote PTT Button | GMRSBHST8 |

Optional Equipment and Accessories

- | | |
|----------------------------------|----------|
| 1. Desktop Charger | GMRS9DS |
| 2. AC Wall Adapter | GMRS9AC |
| 3. Rechargeable (NiMH) Batteries | GMRS9BAT |

Powering the transceiver:

Your GMRS1202 radio transceiver operates on five AAA Alkaline batteries. Alkaline batteries will provide slightly better performance than rechargeable batteries (purchased separately). Only Audiovox approved rechargeable batteries should be recharged in the radio transceiver using the optional charging accessories. This will ensure optimum performance for the GMRS1202. Battery charging time is typically 16 - 20 hours. Use of the optional Audiovox charging equipment with other brands of rechargeable batteries is not recommended as battery charging times will vary. Refer to the manufacturer's instructions for charging other brands of batteries.

Batteries

There are three methods of powering the GMRS1202:

1. Alkaline Batteries.

WARNING: Do not attempt to recharge Alkaline batteries.

2. Audiovox Rechargeable Ni-MH Batteries - (Rechargeable NiMH batteries and Charging Adapter **NOT** included). Use only Audiovox approved rechargeable batteries and charging equipment

(purchased separately) when charging batteries internal to the unit.

NOTE: To extend battery life, avoid overcharging the batteries

3. Various Brands of Rechargeable Batteries - Use of the optional Audiovox charger with other brands of rechargeable batteries is not recommended, as battery charging times will vary with different brands of batteries. Refer to the manufacturer's instructions for charging other brands of batteries.

Installing the batteries:

Battery installation is made more convenient when the carry clip is removed. To do this, release the spring latch securing the clip to radio and slide the clip downward and away from the radio body. Next, press down with the thumb at the embossed arrow, slide the battery cover down and lift off the battery cover. Insert five AAA batteries (alternate positive ends (+) toward the right side of the transceiver (starting top-to-bottom)).

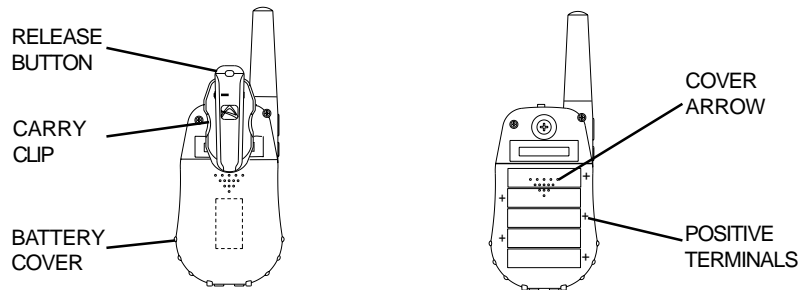

1. Using thumb, press down on battery cover at arrow and slide cover down to open.
2. Slide the cover down and then lift cover at bottom to open. Remove cover.
3. Insert five AAA batteries (positive (+) end toward right side beginning at top and alternating positive terminals as shown).

The following guidelines will improve performance and provide longer operating times for the GMRS1202:

1. Do not mix old and new batteries.
2. The use of alkaline-type batteries is recommended to provide the longest operating time.
3. Do not mix alkaline, standard (carbon-zinc) or rechargeable batteries.
4. If the unit is not to be used for an extended period of time, remove the batteries. Old or leaking batteries can cause damage to the unit and will void the warranty.

GMRS1202 OPERATIONAL MODES

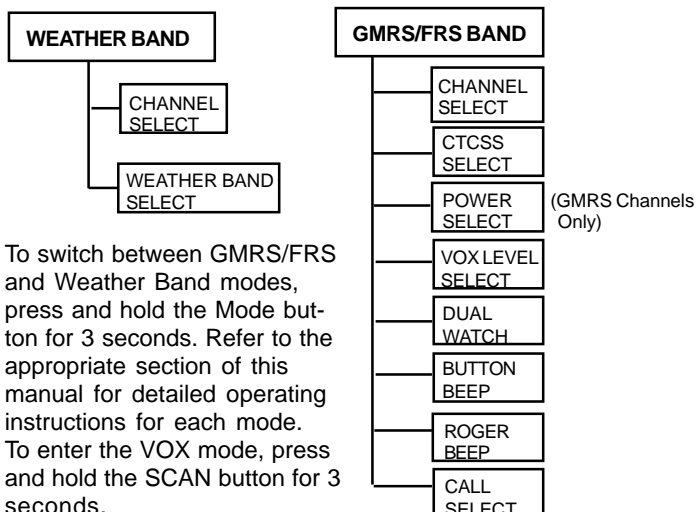

- NOTE: 1.** To switch between GMRS/FRS and Weather Band modes, press and hold the Mode button for 3 seconds. Refer to the appropriate section of this manual for detailed operating instructions for each mode.
- 2.** To enter the VOX mode, press and hold the SCAN button for 3 seconds.

Controls:

LED Flashlight Button (16)



Press this button on the right side of the Transceiver to light the white LED (15) on top of the unit, thereby activating the built-in flashlight function.

Power On/Off/Keylock (13) Button



To turn unit on, press the power on/off button () momentarily (less than 1 second). A confirming melody will play to indicate the unit has turned on. A momentary press of the ON/OFF button again will turn the unit off. When the unit is on and the button is pressed for more than 1

second, the keylock icon () will appear to confirm the functions MODE, SCAN and channel up/down buttons have been disabled.

Adjusting the Volume (10, 11)

With the unit powered on, press the Up Channel/Volume button () to increase volume and the Down Channel/Volume button () to decrease volume. The display will indicate the current volume level between 1 and 7 by the small number in the icon ().

Monitor/Display Backlight Button (2)

This button is used to check activity on the current frequency before transmitting. Check activity by pressing the Monitor (M) Button longer than 2 seconds; the  icon will appear on the display and you will hear static if frequency is clear. ***Do not transmit if you hear conversation.*** Hold down the Monitor Button again longer than 2 seconds and the  icon will disappear from the display.

The monitor function will temporarily bypass the squelch setting and play all signals on a given channel. This feature is useful when communicating with other parties at extreme range.

By pressing the monitor button momentarily, the LCD backlight is turned on accompanied by a beep tone (if enabled); the LCD backlight will turn off automatically in about 5 seconds, or when the monitor button is pressed momentarily once again.

Push To Talk (PTT) Button (4)

Pressing and holding this button will allow you to speak to any transceiver that is set to the same channel and privacy code setting as yours. Hold the transceiver approximately 1 to 2 inches from your face as you speak into the built in microphone (9). After you have finished speaking, release the PTT Button to allow reception of incoming signals. It is not possible to transmit and receive at the same time. The Transmit Signal Level indicator () will display the relative strength of the transmitted signal. When receiving an incoming signal, the **BUSY** icon will appear in the upper right quadrant of the display. The PTT button can also be used as a two-way call ringer. Pressing the button twice quickly will call another party on the same channel.

Up Channel/Volume Button (10)

In the standby mode, pressing this button will increase the listening volume. When in function edit mode this button will be used to adjust the unit's settings.

Down Channel/Volume Button (11)

In the standby mode, pressing this button will decrease the listening volume. When in function edit mode this button will be used to adjust the unit's settings.

Mode Button (12)

This button is used to select the various feature settings in the GMRS/FRS or Weather band modes. Holding the MODE button longer than 2 seconds will toggle between the GMRS/FRS and Weather band modes.

External Microphone (MIC)/Speaker (SPK)/(CHG) Jack (6)

This jack accepts the supplied Audiovox Earbud/microphone connector, or the optional Charging Adapter connector. For additional optional equipment and accessories for the GMRS1202 visit the Audiovox web site at www.audiovox.com.



Scan/VOX Button (14)

Press this Button momentarily to enable or disable the scan mode. Press and hold the button for more than 2 seconds to enable or disable the VOX

mode; the VOX icon will appear in the bottom right corner of the display when enabled.

Operating Modes and Features

GMRS Operation:

- From GMRS/FRS standby mode, press and hold the () button for 2 seconds to turn on power.
- Press the MODE button so the Channel number flashes.
- Select the desired channel with the Up (10) and Down (11) Buttons. When receiving a call, the **BUSY** icon appears to indicate the incoming signal.
- Press and hold the PTT button (4) to transmit, then speak into the microphone clearly and slowly. The Transmit Signal Level indicator () will display the relative strength of the transmitted signal.
- Release PTT Button (4) to receive.
- Communication can only be accomplished when the channel and CTCSS tone frequency of at least two parties are the same.
- The CTCSS small segment display will appear next to the main frequency channel on the display if the CTCSS tone frequency function is enabled.

Channel Selection

In order to communicate with other GMRS units, both transmitting and receiving party must be on the same frequency. The GMRS1202 has 22 channels (frequencies) indicated by the large digits on the LCD display panel. Channels 1 through 7 are the shared GMRS/FRS channels. Channels 8-14 are FRS only channels, while channels 15-22 are assigned GMRS only channels. If an FRS only channel (8-14) has been selected, the **HI** or **LO** indicator will not be displayed on the LCD panel; otherwise, for channels 1-7 (GMRS/FRS) and 15-22 (GMRS only), the **HI** or **LO** indicator will be displayed. Communication with Audiovox FRS and compatible units is possible on the shared and FRS only channels.

Before transmitting on the selected channel, press the Monitor (M) Button (2) to check the activity on that channel. If there is activity on the selected channel, change to another channel that is clear.

To change the channel:

- From GMRS/FRS standby mode, press the MODE button (12) once or until the channel number flashes.
- Press the Up Button (10) briefly to move to the next higher main channel number.
- Press the Down Button (11) briefly to move to the next lower main channel number.
- Press the PTT button momentarily to confirm selection.

CTCSS Mode (Sub-Channel) Selection

The Coded Tone Controlled Squelch System (CTCSS) provides 38 Sub-Frequencies. This feature allows you to utilize the coded squelch tones (01–38) within a main channel, and enables you to communicate with another party on the same main channel using the same subcode. (This filters out unwanted transmissions without the same coded squelch tone). There are 38 CTCSS Sub-channels for each main channel. A different subcode may be selected for each of the 22 channels.

To change the CTCSS Sub-channel:

- From GMRS/FRS standby mode, press the MODE Button twice; a flashing **oF** or sub-channel number is displayed. If **oF** is displayed, press the Up or Down button to enable the CTCSS mode.
- Then press the Up or Down button to select the desired sub-channel for use (**01-38**).
- Press the PTT button momentarily to confirm selection.

The CTCSS mode can be turned off by selecting the **oF** icon as the setting.

NOTE: To communicate with other GMRS/FRS units, they must be switched to the same channel and CTCSS subcode. To communicate with other GMRS/FRS units that do not have subcodes, switch your unit to the same channel with the subcode set to **oF**.

The CTCSS subcodes do not prevent others from hearing your transmission. This will only allow you to ignore all traffic on a given channel not using the same subcode.

Transmit Power Selection Mode

This feature permits selection of the transmitting power level to high or low. When operating on FRS only channels (8-15), no power selection is possible or is displayed. Using low power, the unit will have a lower transmit range, but battery life will be increased.

To access the transmitter power selection function:

- From GMRS/FRS standby mode (shared channels 1-7 or GMRS only channel (15-22) selected), press the MODE Button three times until the power **HI** or **Lo** indication appears with a flashing **Po** indication on the display.
- Press the Up or Down button to toggle between the High and Low selections.
- Press the PTT button momentarily to confirm selection.

VOX Sensitivity Level Selection

This selection enables you to set the sensitivity level to compensate for ambient noise in your immediate area. A VOX sensitivity of 3 is the most sensitive, and should be used in a relatively quiet surrounding. A VOX sensitivity of 1 is the least sensitive and should be used in a noisy surrounding.

To set the VOX sensitivity level:

- Press the MODE button 4 times (3 times for FRS) until the **Vo** icon appears on the display accompanied by the flashing **VOX** icon and the numeral **1**, **2** or **3**.
- Press the Up or Down button to select the **1-3** VOX level sensitivity.
- Press the PTT button momentarily to confirm the VOX selection.
- The **VOX** icon will disappear from the display unless VOX mode is enabled.

Dual Watch Mode

This feature allows you to monitor two channels at the same time. While in dual watch mode, the unit will continuously monitor both the primary and

dual watch channel. Received signals will be played for 5 seconds, then the unit will resume scanning the two channels. Pressing the PTT button during a received transmission will set the unit to transmit on the same channel. Pressing the PTT button when no signal is received will set the unit to transmit on the primary channel.

To set the Dual Watch Mode:

- From GMRS/FRS standby mode, press the MODE button 5 times (4 times for FRS); **DW** appears flashing on the display. If the dual watch mode is off, the **oF** icon will also appear flashing.
- To enable the dual watch mode, press the Up or Down button; the dual watch channel number will flash and start to increase or decrease as the Up or Down button is pressed.
- To select a subcode for the dual watch channel, press the MODE button while the selected dual watch channel is flashing. Then use the Up and Down buttons to select the desired CTCSS subcode
- Press the PTT button momentarily to confirm selection of the dual watch channel. The display will now alternate between the primary channel and the dual watch channel just selected.

NOTE: Pressing the PTT button during dual watch mode will transmit on the primary channel and suspend dual watch operation for 20 seconds. Dual watch mode will then resume.

- Momentarily press the SCAN button to exit the dual watch mode.

Key Tone

This feature allows the transceiver to sound a confirmation tone whenever the following keys are pressed: Monitor (M) Button, Up/Down Buttons, MODE Button or SCAN Button.

To turn the key tones on or off:

- From GMRS/FRS standby mode, press the MODE Button 6 times (5 times for FRS) until the Bell (🔔) icon flashes, and **on** or **oF** appears on the display.
- Press the Up or Down Button to toggle the key tone feature On or Off.



- Press the PTT button momentarily to confirm selection.

When the key tone feature is on, the Bell icon appears steady on the display, and the beep tones sound in response to button activation.

Roger Beep Tone

The Roger Beep is a tone which is automatically transmitted whenever the PTT button is released. This tone alerts the receiving party that the transmission has been terminated intentionally.

To enable and disable the Roger Beep tone:

- From GMRS/FRS standby mode, press the MODE Button 7 times (6 times for FRS) until the flashing Roger Beep icon () and **on** or **oF** appears on the display.
- Press the Up or Down button to select the tone on or off as desired.
- When enabled, the tone icon () appears steady on the display.
- Press the PTT button momentarily to confirm selection.

Call Ringer Selection Mode

The transceiver provides 3 user-selectable call ringer melodies to alert you to an incoming call.

To select your favorite call ringer melody:

- From GMRS/FRS standby mode, press the MODE Button 8 times (7 times for FRS). **CA** will appear on the display, together with a flashing number between **01** and **03**, and an appropriate call ring.
- Press the Up or Down Button to preview and hear the 3 available call melodies.
- Press the PTT button momentarily to confirm selection.

Channel Scan Operation

This feature allows you to monitor all channels automatically for valid signals. While scanning, you can transmit and receive. When a signal is received, the scan is interrupted and will return to scan mode 5 seconds after reception is terminated.

NOTE: While the scan function is active, the MODE button will be inoperative. The scan mode will reduce the overall battery life since the battery save function is overridden.



To enable the channel scan mode:

- From GMRS/FRS standby mode, momentarily press the SCAN Button; **(SCAN)** will appear on the LCD display.
- The radio will display each channel (1-22) in ascending order as the scan mode operates to find an active main channel.
- If the unit doesn't find any signals and you want to transmit, press the PTT button to return to home channel operation. The transceiver will automatically resume scanning approximately 5 seconds after the communication is completed.
- If there is no activity and you want to leave the scan mode, press the SCAN button momentarily and the unit will return to normal operation; the **SCAN** icon will disappear from the LCD display.

Auto Key Lock Selection Mode

This feature prevents accidental channel change to the preferred settings of the unit. The Auto Key Lock function temporarily disables the MODE, Up/Down and SCAN Buttons.

To access the Auto Key Lock selection menu:

- From GMRS/FRS standby mode, press and hold the Power Button for more than 1 second to enable the Auto Key lock function; the unit will beep once and the lock () icon appears on the display.
- The Power, PTT, and Monitor Buttons are not effected.
- To unlock the Auto Key function, press and hold the Power button for more than 1 second; the unit beeps once and the lock icon () disappears from the display.

NOTE: If the unit is turned off while Key Lock is on, the Key Lock mode will still be in effect when the unit is again turned on.

VOX Enable Operation

This option enables you to have hands-free conversation. Your voice or nearby sound is detected and the radio transmits without the need to press the PTT button.

To enable VOX operation:

- From GMRS/FRS standby mode, press the SCAN button for 3 seconds or until the **VOX** icon appears steady on the display.
- Press the PTT button momentarily to confirm VOX enable mode.
- To disable the VOX mode, press the SCAN button for 3 seconds or until the VOX icon disappears from the display.

Weather Band Operation

Channel Selection

This feature provides access to 10 channels within the weather band (7 NOAA channels and 3 Canadian marine channels). To select a weather channel, the unit must be in the weather channel mode. Press and hold the MODE button for at least 3 seconds; the weather alert icon () will appear, together with a channel number in the band. Momentarily press the MODE button (12) once; the channel number flashes.

To change the channel:

- Press the Up Button (10) briefly to move to the next higher main channel number.
- Press the Down Button (11) briefly to move to the next lower main channel number.

NOTE: When the weather band operation mode is entered the transceiver will bypass the squelch setting and open the channel.

Weather Alert Mode

The weather alert mode notifies the user of unusual weather situations when the radio is operating in the GMRS/FRS mode.

To access the weather alert function:

- From Weather Band standby mode, press the MODE button once to access the weather channels as instructed above, and use the Up or Down Button to select the desired channel.

- Momentarily press the MODE button again to access the weather alert function; the weather icon (☁) and **AL on** or **oF** appear flashing on the display.
- Use the Up or Down buttons to enable (**on**)/disable (**oF**) the alert function. The weather icon will stop blinking on the display in the GMRS mode when the alert is disabled.
- Press the PTT Button to confirm your selection.
- Press and hold the MODE button for at least 2 seconds to exit the weather function.

NOTE: When the unit is the GMRS/FRS or Weather Band mode, if a weather alert signal is received, the unit will generate a warning tone.

Battery Alert

When the battery icon is empty () and flashing on the display, recharge unit or install fresh batteries.

NOTES FOR GOOD COMMUNICATION

1. The GMRS1202 22 channels are shared on a 'take turns' basis. This means other groups may be talking on any of the channels. A common code of ethics/courtesy is to switch to another vacant channel and not to attempt to talk over someone who is already using the channel you first selected.
2. The GMRS1202 has been designed to maximize performance and improve transmission range in the field. To avoid interference, it is recommended that you do not use the units closer than 5 feet apart.
3. For best transmission results, always keep your mouth about 2-3 inches from the microphone (9) and speak slowly in a normal voice.
4. To increase battery life, avoid features such as Scan and Dual Watch. These features will reduce operating time considerably.

Warning

- Do not operate the transceiver unless you are licensed to do so.
- Remove the batteries from the transceiver if it is not expected to be used for long periods. This will eliminate the possibility of chemicals leaking from the batteries and corroding the transceiver.
- Avoid exposing the transceiver to water or extremes of temperature.
- Do not use this device in or near a mining facility, which uses remotely triggered explosives or in areas labeled "Blasting Area". Premature or accidental detonation may result.
- Do not attempt to modify or in any way increase the output of this transceiver. Its output is designed to meet the legal limits set by the FCC.
- Do not use this device or change its batteries in potentially explosive atmospheres as sparks in such areas could result in an explosion.
- Turn your transceiver off wherever posted notices restrict the use of radios or cellular telephones. Facilities such as hospitals may use equipment that is sensitive to RF energy.
- Turn your transceiver off on board aircraft when requested to do so.
- Do not place your radio in front of a vehicle's air-bag. If the air-bag deploys, it could propel the transceiver like a projectile causing bodily injury.

Troubleshooting

Problem	Possible cause	Correction
No transmission while pressing the PTT Button	Weak batteries	Charge or replace batteries
	Incorrect battery polarity	Install the batteries following the directions in paragraph Installing the Batteries.
Weak or no signal received	Weak batteries	Charge or replace batteries
	Channel and privacy code not set the same as target transceiver	Adjust the transceiver's settings to match those settings of the target transceiver
	Volume level too low PTT Button inadvertently pressed	Increase volume level Release PTT Button
	Excessive radio interference on a particular channel Obstruction of radio signal	Change to a different channel Avoid operating in or near large buildings or vehicles
Unit beeps, but will not function when turned on	Batteries extremely discharged	Charge or replace batteries
Reception of unwanted signals	CTCSS privacy mode not on	Turn on the CTCSS privacy mode and set code number to match the setting of the target transceiver.
	Interference from electronic devices such as computers or TVs	Turn the devices off or move farther away from them.

Technical Specifications:

General

Frequency Range:	
Channels 1-7 (Shared with FRS Radios)	Refer to frequency chart on next page
Channels 8-14 (FRS only)	Refer to frequency chart on next page
Channels 15-22 (GMRS only)	Refer to frequency chart on next page
Channel Spacing	12.5 kHz
Privacy Codes	38 for each main channel
Weather Band (7 Channels)	162.4000 - 162.5500MHz
Canadian Maritime (3 Channels)	161.6500, 161.7750, 163.2750MHz
Dimensions (W x H x D) (Without Antenna)	2.40 in x 4.02 in x 1.14 in 61.0 mm x 102 mm x 29 mm

Power Supply

Power Source	Alkaline Batteries, AAA (5), 7.5 VDC Ni-MH rechargeable, AAA (5), 6.0 VDC, 750 mAh
Operating Time: (Transmit: Receive: Standby (5:5:90 Ratio) (Based on alkaline batteries)	30 Hours Low Power 9.5 Hours High Power

Receiver

Useable Sensitivity	>-119 dBm
Maximum Audio Output Power	> 0.3 Watt maximum (8 Ohm)
Modulation Distortion	< 5% (1 kHz 70%)

Transmitter

RF Output Power	3.5 Watts maximum (High Power) 0.4 Watt maximum (Low Power)
Maximum Deviation	< +/- 2.5 kHz
Modulation Distortion	< 5% (1 kHz 70%)

22

128-7032B
22 of 28

This transceiver complies with FCC regulations for use in the United States of America. Use in other countries may be prohibited or restricted by local regulation. Please check with the local regulating agency before using this device outside the United States of America.

Main Channel Frequencies:

CHANNEL/TYPE	FREQ (MHz)	CHANNEL/TYPE	FREQ (MHz)
1 GMRS/FRS	462.5625	12 FRS	467.6625
2 GMRS/FRS	462.5875	13 FRS	467.6875
3 GMRS/FRS	462.6125	14 FRS	467.7125
4 GMRS/FRS	462.6375	15 GMRS	462.5500
5 GMRS/FRS	462.6625	16 GMRS	462.5750
6 GMRS/FRS	462.6875	17 GMRS	462.6000
7 GMRS/FRS	462.7125	18 GMRS	462.6250
8 FRS	467.5625	19 GMRS	462.6500
9 FRS	467.5875	20 GMRS	462.6750
10 FRS	467.6125	21 GMRS	462.7000
11 FRS	467.6375	22 GMRS	462.7250

NOTE: Channels 1 through 7 are shared with FRS radios.
 Channels 8 through 14 are FRS only.
 Channels 15 through 22 are GMRS only.

CHANNELCROSS REFERENCE FOR 14 AND 15 CHANNEL GMRS/FRS RADIO TO 22 CHANNEL GMRS/FRS RADIO

CHANNELCROSS REFERENCE FOR 15 CHANNEL GMRS/FRS RADIO TO 22 CHANNEL GMRS/FRS RADIO

15 CHANNEL GMRS	22 CHANNEL FRS/GMRS
1	1
2	2
3	3
4	4
5	5
6	6
7	7
CHANNELS NOT AVAILABLE	8
	9
	10
	11
	12
	13
	14
11	15
8	16
12	17
9	18
13	19
10	20
14	21
15	22

CHANNEL CROSS REFERENCE FOR 14 CHANNEL FRS RADIO TO 22 CHANNEL GMRS/FRS RADIO

14 CHANNEL FRS	22 CHANNEL FRS/GMRS
1	1
2	2
3	3
4	4
5	5
6	6
7	7
8	8
9	9
10	10
11	11
12	12
13	13
14	14
CHANNELS NOT AVAILABLE	15
	16
	17
	18
	19
	20
	21
	22

NOTE

WHEN USING RADIOS PRODUCED BY OTHER MANUFACTURERS, COMPARE CHANNEL FREQUENCIES FOR COMPATIBILITY.

Continuous Tone Coded Squelch System Tone Frequencies (in Hz)

CTCSS	Freq. Hz	CTCSS	Freq. Hz
1	67.0	20	131.8
2	71.9	21	136.5
3	74.4	22	141.3
4	77.0	23	146.2
5	79.7	24	151.4
6	82.5	25	156.7
7	85.4	26	162.2
8	88.5	27	167.9
9	91.5	28	173.8
10	94.8	29	179.9
11	97.4	30	186.2
12	100.0	31	192.8
13	103.5	32	203.5
14	107.2	33	210.7
15	110.9	34	218.1
16	114.8	35	225.7
17	118.8	36	233.6
18	123.0	37	241.8
19	127.3	38	250.3

* oF = No Tone

Weather Channel Frequencies:

Channel	Freq. MHz	Channel	Freq. MHz
1	162.550	6	162.500
2	162.400	7	162.525
3	162.475	8*	161.650
4	162.425	9*	161.775
5	162.450	10*	163.275

*Canadian Marine

90 DAY LIMITED WARRANTY

Applies to Audiovox Family Radio and General Mobile Service Products.

AUDIOVOX CORPORATION (the Company) warrants to the original retail purchaser of this product that should this product or any part thereof, under normal use and conditions, be proven defective in material or workmanship within 90 days from the date of original purchase, such defect(s) will be repaired or replaced with new or reconditioned product (at the Company's option) without charge for parts and repair labor.

To obtain repair or replacement within the terms of this Warranty, the product is to be delivered with proof of warranty coverage (e.g. dated bill of sale), specification of defect(s), transportation prepaid, to the warranty center at the address shown below.

The Company disclaims liability for communications range of this product.

This Warranty does not apply to any product or part thereof which, in the opinion of the Company, has suffered or been damaged through alteration, improper installation, mishandling, misuse, neglect, accident, or by removal or defacement of the factory serial number/bar code label(s). THE EXTENT OF THE COMPANY'S LIABILITY UNDER THIS WARRANTY IS LIMITED TO THE REPAIR OR REPLACEMENT PROVIDED ABOVE AND, IN NO EVENT, SHALL THE COMPANY'S LIABILITY EXCEED THE PURCHASE PRICE PAID BY PURCHASER FOR THE PRODUCT.

This Warranty is in lieu of all other express warranties or liabilities. ANY IMPLIED WARRANTIES, INCLUDING ANY IMPLIED WARRANTY OF MERCHANTABILITY, SHALL BE LIMITED TO THE DURATION OF THIS WRITTEN WARRANTY. ANY ACTION FOR BREACH OF ANY WARRANTY HEREUNDER INCLUDING ANY IMPLIED WARRANTY OF MERCHANTABILITY MUST BE BROUGHT WITHIN A PERIOD OF 30 MONTHS FROM DATE OF ORIGINAL PURCHASE. IN NO CASE SHALL THE COMPANY BE LIABLE FOR ANY CONSEQUENTIAL OR INCIDENTAL DAMAGES FOR BREACH OF THIS OR ANY OTHER WARRANTY, EXPRESS OR IMPLIED, WHATSOEVER. No person or representative is authorized to assume for the Company any liability other than expressed herein in connection with the sale of this product.

Some states do not allow limitations on how long an implied warranty lasts or the exclusion or limitation of incidental or consequential damage so the above limitations or exclusions may not apply to you. This Warranty gives you specific legal rights and you may also have other rights which vary from state to state.

AUDIOVOX CORPORATION, 150 MARCUS BLVD., HAUPPAUGE, NEW YORK 11788
1-800-290-6650

128-5385A

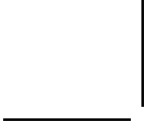

THIS PAGE LEFT BLANK INTENTIONALLY





© 2004 Audiovox Electronics Corp., Hauppauge, NY 11788

Printed in China

128-7032A

128-7032B
28 of 28

[RF EXPOSURE STATEMENT : PDHGMRS1202 / TTI TECH CO., LTD.]

- CAUTION! -

IMPORTANT SAFETY INFORMATION

Your wireless hand-held portable transceiver contains a radio frequency transmitter. When the PTT button is pushed, the transmitter sends out RF signals. The device is authorized to operate at a transmit duty factor not exceeding 50% using Ni-Mh / alkaline "AAA" size batteries to comply with Federal Communications Commissions (FCC) RF exposure safety level guidelines for hand-held wireless devices.

For body-worn operation, this device has been tested for SAR (Specific Absorption Rate) and meets the FCC RF exposure guidelines when used with the accessories supplied or designated for this device by the manufacturer. Use of other accessories may not ensure compliance with FCC RF exposure guidelines. Use the manufacturer-supplied antenna only. Unauthorized antennas, modifications, or attachments could damage the transmitter and may violate FCC regulations. To maintain compliance with the FCC's RF exposure guidelines, hold the transceiver at least 1 inch (2.5 centimeters) from your face and speak in a normal voice, with the antenna pointed up and away.

GMRS License :

Use of GRMS radios within the United States requires a FCC GMRS license. An individual of 18 years of age or older, who is not a representative of a foreign government is eligible to apply for a GMRS system license. You will need two forms from the FCC - FCC FORM 159 and FCC Form 605 Main Form and Schedule F.

You can find the forms online at <http://www.fcc.gov/formpage.html> or call 1-800-418-3676.