

单页尺寸：14x12.5cm

TO CUSTOMERS

Thank you very much for using our two way radio. This radio of modern design is reasonable structure with stable functions. It is designed to meet different customers' need for high quality with easy operation and perfect capability. We believe you are pleased with its nice shape and excellent performance.

This manual is suitable for using the model of TH-350.

Welcome to use **TYT** two-way radio

<http://www.tyt888.com>

Main Functions

Tri-band, tri display, tri standby

128 channels

VFO/CNANNEL/MR 3 modes

DTMF encoding

1750 tone

Scrambler

5K/6.25K/10K/12.5K/
20K/25K step selectable

Battery saving

Busy channel lock

Keypad beep

Voltage display

Backlight control

Keypad lock

Opening setting

Channel name edit and display mode

offset setting

Boot display options

Roger

Scan mode

Busy channel lock

VOX

Wide/narrow bandwidth

CTCSS/DCS

50 groups CTCSS、104 groups

DCS and non-stand CTCSS/DCS

High/low power

Low battery alert

0-9 Squelch selecatble

TOT

Reverse frequency

Emergency alert

Monitor



CONTENTS

USING TIPS	02
UNPACKING AND CHECKING EQUIPMENT	03
CHARGING BATTERY PACK	05
Charging Precaution	05
Charging Operation	06
Indicator light of charger will show charging condition	06
INSTALLATION OF ACCESSORIES	07
Installation of Battery Pack	07
Antenna Installation	08
Installing Belt Clip	09
Installing External Micro/Speaker	10
Getting Familiar	11
Side key definition	13
Icons and description	15
Shortcut keys	16
Menu setting	17
Menu Function Description and Settings	19
1. SQL	19

2. POWER	19
3. VOX	19
4. Wide / Narrow band setting	20
5. Battery saving	20
6. Step frequency setting STEP	20
7. TOT	20
8. BEEP	21
9. ABR backlight switch	21
10. Reverse frequency REV	21
11. Talk around T / A	22
12. Tri-band stand by TDR	22
13. Transmit channel selection TX-F	22
14. RX CTCSS/DCS setting R-CDC (support non-standard CTCSS/DCS)	22
15. TX CDCSS/DCS setting T-CDC (support non-standard CTCSS/DCS)	23
16. DTMF settings	24
17. Scan mode settings SMODE	25
18. scan delete settings SCAN-ADD	26
19. PTTID (PTTID switch) settings	26
20. MDF / A (Band A display mode)	26
21. MDF / B (Band B display mode)	26
22. MDF / C (Band C display mode)	27

23. Keypad lock mode LOCK M	27
24. Boot display options OPNSET	27
25. Busy channel lock BCL	28
26. Shift direction selection setting S-D.....	28
27. offset setting DIFFR	28
28. End of emission ROGER	28
29. Scrambler function SCRM	29
30. Compandor COMP	29
Specific Instructions	31
TECHNICAL PARAMETERS	32
Guarantee	

USING TIPS

UNPACKING AND CHECKING EQUIPMENT

<http://www.tyt888.com>

USING TIPS

Please read the following brief instructions, non-compliance with these rules may cause danger or violate the law.

- Obey the local government regulation before using this radio, improper use may violate the law and be punished.
- Turn off the radio before entering flammable or explosive areas.
- Do not charge or change the battery in flammable or explosive areas.
- Turn off the radio before getting close to the blasting zone or detonator areas.
- Do not use radio whose antenna is damaged, touching of damaged antenna will cause heat injury.
- Do not attempt to open the radio; the maintenance work should be done by technical expert only.
- To avoid troubles caused by electromagnetic interference or electromagnetic compatibility, please turn off the radio in places where have the banner "Do not use wireless equipment", such as hospital and other healthcare places.
- In the car with an airbag, do not put the radio within the scope of the airbag deployment.
- Do not store the radio under the direct sunshine or in hot areas.
- When you transmit with the radio, do keep away from its antenna for 5cm at least.
- If the radio appears smelly or smoke, please shut off its power immediately and contact with your local dealer.
- Do not transmit too long, for the radio may heat and hurt the user.

UNPACKING AND CHECKING EQUIPMENT

Welcome to use **TYT** TH-350 transceiver. Please check if any damage to the package when you receive it. Carefully unpack the transceiver. We recommend that you check the items listed in the following table. If any items are missing or damaged during shipment, please contact with your local dealer immediately.

Supplied Items:



TH-350 Body(1)



Antenna (1)



Li-ion battery (1)



Power Adapter (1)



Charger (1)

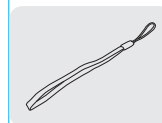

Handstrap (1)



Belt Clip (1)



Verification (1)



User's Manual (1)

Note: The antenna frequency range please refers to the annular label at the bottom of antenna.

CHARGING BATTERY PACK INSTALLATION OF ACCESSORIES GETTING FAMILIAR

<http://www.tyt888.com>

CHARGING BATTERY PACK

Charging Precaution

The supplied battery pack of TH-350 is a high-performance Li-ion battery with 7.4V standard voltage, 1600mAh high capacity in a very compact package. Under normal use, the battery pack may be used for approximately 500 charge cycles and more, after which operating time maybe expected to decrease. If you have an old battery pack which is displaying capacity which has become diminished, you should replace the pack with a new one.

Please use **TYT** designated battery; other batteries can cause explosion and hurt people.

Notice: ■ Please do not short-circuit the battery terminals or expose of in fire. Do not disassemble the battery unauthorized.

- Charge the battery between temperature 0°C and 45°C. The battery can not be normally charged beyond this temperature range.
- Please turn off the transceiver when you charge it. Transmitting with the transceiver in charge will affect its normal charge.
- Do not unplug the Power Adapter or battery when it is charged.
- If the battery pack lasts shortly even it is full of power, it shows that the battery is depleted, please change the battery pack.
- Please do not charge when the battery or the radio is wet. Please dry it with a cloth before charging to avoid any danger.

Warning: When the conductive metals such as jewelry, key or decorative chains touch the

battery terminals, all the batteries are likely to cause damage to the items or personal injury. These conductive metals may form a short circuit and generates much heat. Do deal with any battery carefully, especially when put it into pocket, wallet or other metallic containers.

Charging Operation

After installing the battery pack, if the battery icon shows \square , it means that the battery pack is out of power, Please charge it.

Indicator light of charger will show charging condition

Indicator Display	Status
Red	Charging
Green	Completed

Battery Tips:

- The battery is not fully charged in factory, please charge before using it.
- Charge and discharge the battery for two or three times, the battery capacity will reach the best condition. When the battery capacity is low, please charge or change the battery.
- The battery lasts shortly even if it is fully charged, the battery is depleted, please contact your local dealer to buy a new authentic TYT battery.

INSTALLATION OF ACCESSORIES

Installation of Battery Pack

- 1) Fit the supplied battery pack into the batter pack trough, then slide it toward the head to insert it completely—in direction of arrowhead ①.
- 2) Push the battery pack lock to release the battery pack and slide it toward the bottom to remove it out—in direction of arrowhead ②.

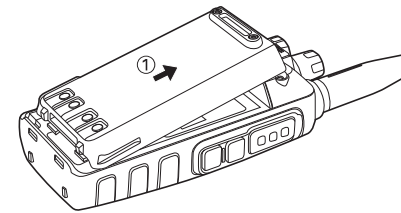

Picture 1

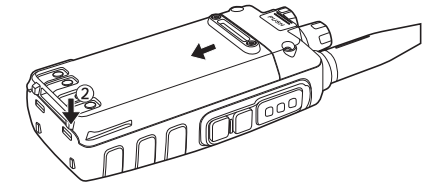

Picture 2

Antenna Installation

The supplied antenna provides good results over VHF and UHF range of the transceiver you need.

To install the supplied antenna, hold the bottom end of the antenna, then screw it onto the connector on the transceiver until it is snug. Do not over-tighten by use of extreme force.

Picture 3

To uninstall the antenna, hold the bottom end of it and turn it counterclockwise to remove it.

Picture 4

- Notes:
- Never transmit without having an antenna connected.
 - When installing the supplied antenna, never hold the upper part of the antenna while screwing it onto the connector on the transceiver. Or you may snap the antenna.

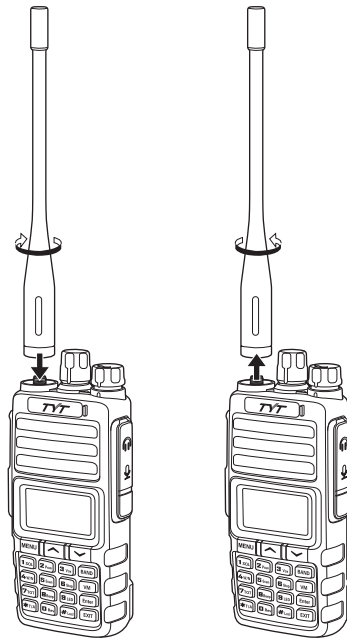

Picture 3

Picture 4

Installing Belt Clip

Align the two holds of belt clip and the two holes of the radios, fix them with the supplied M2.5x5 screws. Loosen the screw set to remove belt clip.

Picture 5, Picture 6

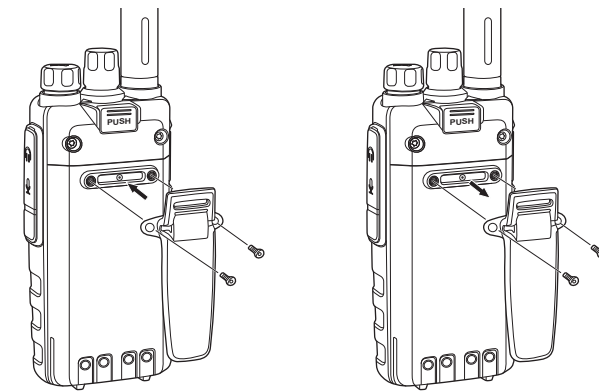

Picture 5

Picture 6

Installing External Micro/Speaker

Open the cover of the Mic/speaker jack and insert the microphone/speaker plugs into the jack. Picture 7

- Note:**
- Using the external headset or Mic/speaker will affect the water-tightness performance of radio.
 - If the external headset is not workable, please use the headset case.

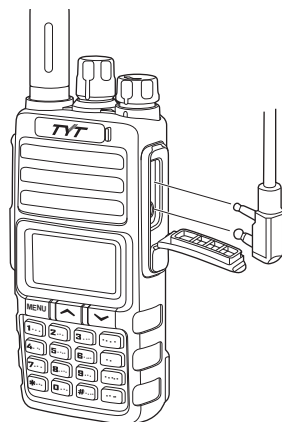

Picture 7

Getting Familiar

ANTENNA
Connect the supplied antenna here.

SPEAKER
The internal speaker is located here.

VOLUME DIAL
This control toggle the transceiver's power on/off and adjust the audio volume level.

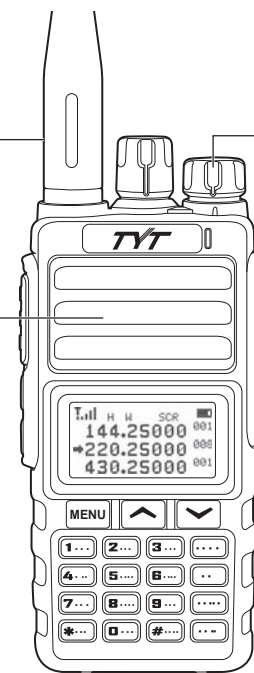

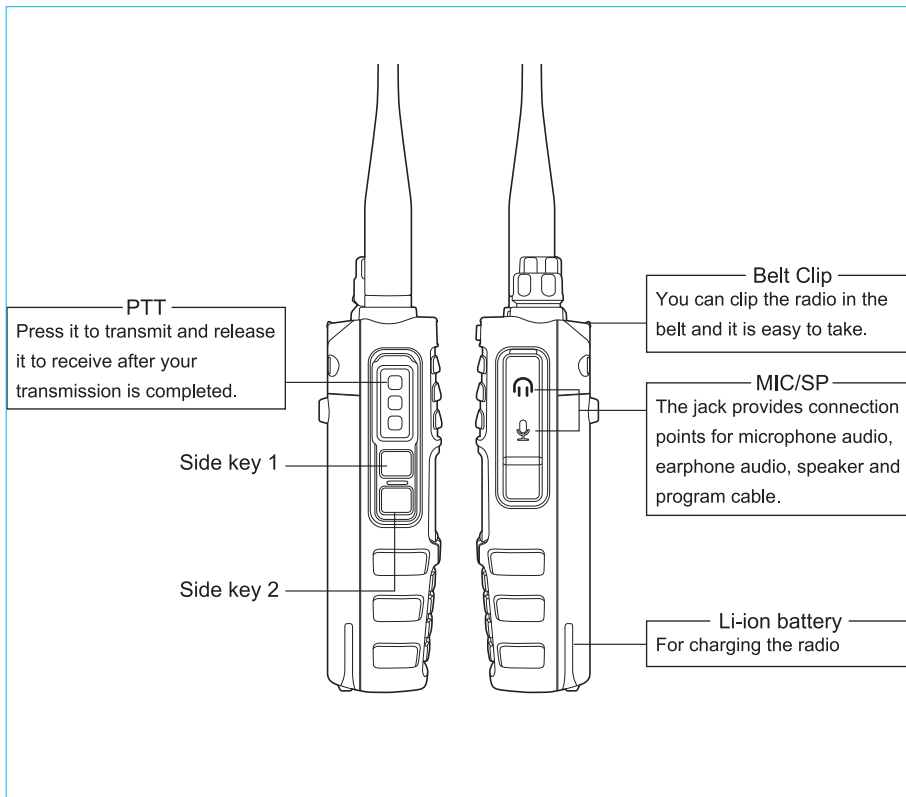

Side key definition

Side key 1 and side key 2 can be defined as the following:

- 1) No
- 2) Monitor
- 3) Scan On/Off
- 4) Scrambler
- 5) Emergency alarm

★ side key 1 and the side key 2 can also be divided into a long press and a short press due to the different trigger time, and the above 5 functions can also be realized through software definition.

★ The trigger mentioned below can be a long press or a short press and is set by the user.

Icons and description



Shortcut keys

Menu setting

Menu Function Description and Settings

<http://www.tyt888.com>

Icons and description

No	Icons	Description of functions	Operation
1		Keypad lock	MENU+#
2	H/L	High/low power	Menu 2
3	BP	Beep	Menu 8
4	R	Reverse transmit and receive frequency	Menu 10
5	+ -	Repeater shift direction	Menu 26
6	CT	CTCSS	Menu 14(RX)、 Menu 15(TX)
7	DT	DCS	Menu 14(RX)、 Menu 15(TX)
8	R	Reverse frequency	Menu 11
9	VOX	VOX	Menu 3
10		Battery indicator	
11	SCR	Scrambler	Menu 29
12		Narrow bandwidth	Menu 4
13	W	Wide bandwidth	Menu 4

Shortcut keys

1. [**MENU**]+[**1 SQL**] enter SQL level 0ff/1-9 selection;
2. [**MENU**]+[**2 Pow**] enter high / low power selection;
3. [**MENU**]+[**3 VOX**] enter VOX function selection;
4. [**MENU**]+[**4 W/N**] enter wide/ narrow band selection;
5. [**MENU**]+[**5 Scan**] enter scan switch selection;
6. [**MENU**]+[**6 Step**] enter frequency step selection;
7. [**MENU**]+[**7 TOT**] enter TOT function;
8. [**MENU**]+[**8 Beep**] enter BEEP tone switch;
9. [**MENU**]+[**9 LED**] enter backlight setting;
10. [**MENU**]+[**0 Rev**] enter scrambler function setting;
12. [**MENU**]+[**# Lock**] keypad lock switch.

Menu setting

Menu Item	Display and Description	Setting Content
1	SQL(Squelch Level)	Off/1-9
2	POWER(High/Low power)	HIGH/LOW
3	VOX(VOX level)	OFF/1-9
4	W/M(Wide/Narrow bandwidth)	WIDE/NARROW
5	SAVE(Battery saving)	ON/OFF
6	STEP(VFO step)	5, 6.25, 10, 12.5, 20, 25
7	TOT(Transmitter Time-out Timer)	OFF-(1M-7M)
8	BEEP(Keypad beep)	ON/OFF
9	ABR(Automatic backlight)	ON/OFF
10	REV(Reverse transmit and receive frequency)	ON/OFF
11	T/A(Talk around)	ON/OFF
12	TDR(Tri standby)	ON/OFF
13	TX-F(TX channel choose)	AUTO(same with RX arrows) /F1/F2/F3
14	R-CDC(RX CTCSS/DCS setting)	OFF,50 groups CTCSS,104 groups DCS; switch by V/M key(support non-standard)
15	T-CDC(TX CTCSS/DCS setting)	OFF,50 groups CTCSS,104 groups DCS; switch by V/M key(support non-standard)

Menu Item	Display and Description	Setting Content
16	DTMFST(DTMF tone switch)	ON/OFF
17	S.MODE(Scan mode)	TO/CO/SE
18	SC-ADD(Scan delete switch)	ON/OFF
19	PTTID(PTT ID switch)	ON/OFF
20	MDF/A(Band A display mode)	FREQ/NAME/CHANNE
21	MDF/B(Band B display mode)	FREQ/NAME/CHANNE
22	MDF/C(Band C band display mode)	FREQ/NAME/CHANNE
23	LOCK M(Lock mode)	MANUAL/AUTO
24	OPNSET(Boot setting)	OFF/DC/NSG/PIC
25	BCL(Busy channel lock)	ON/OFF
26	S-D(shift direction)	0/+/-
27	DIFFR(offset)	Manually input
28	ROGER(End tone of emission)	ON/OFF
29	SCRM(Scrambler)	ON/OFF
30	COMP(voice compandor)	ON/OFF

Menu Function Description and Settings

1. SQL

After pressing [**MENU**] key, rotate the channel knob to select the menu [**1 SQL**] .

1. Press [**Enter**] to enter SQL settings.
2. Rotate the channel knob to select 0ff/1-9.
3. Press [**MENU**] to confirm.
4. Press [**EXIT**] to exit to the main menu.

2. POWER

After pressing [**MENU**] , rotate the channel knob to select menu [**2 Power**] .

1. Press [**Enter**] to enter the TXP setting.
2. Rotate the channel knob to select HIGH/LOW.
3. Press [**MENU**] to confirm.
4. Press [**EXIT**] to exit to the main menu.



3. VOX

After pressing [**MENU**] , rotate the channel knob to select the menu [**3 VOX**] .

1. Press [**Enter**] to enter VOX settings.
2. Rotate the channel knob to select OFF/1-9.
3. Press [**MENU**] to confirm.
4. Press [**EXIT**] to exit to the main menu.



4. Wide / Narrow band setting

After pressing [] key, rotate the channel knob to select the menu [] .

1. Press [] to enter W/N settings.
2. Rotate the channel knob to select WIDE/NARROW.
3. Press [] to confirm.
4. Press [] to exit to the main menu.



5. Battery saving

After pressing [] key, rotate the channel knob to select the menu [] .

1. Press [] to enter SAVE settings.
2. Rotate the channel knob to select ON/OFF.
3. Press [] to confirm.
4. Press [] to exit to the main menu.

6. Step frequency setting STEP

After pressing [] , rotate the channel knob to select menu [] .

1. Press [] to enter STEP settings.
2. Rotate the channel knob to select step: 5, 6.25, 10, 12.5, 20, 25.
3. Press [] to confirm.
4. Press [] to exit to the main menu.

7. TOT

After pressing [] , rotate the channel knob to select menu [] .

1. Press [] to enter TOT setting.



2. Rotate the channel knob to select OFF/1-7.

3. Press [] to confirm.

4. Press [] to exit to the main menu.



8. BEEP

After pressing [] key, rotate the channel knob to select the menu [] .

1. Press [] to enter BEEP setting.
2. Rotate the channel knob to select ON/OFF.
3. Press [] to confirm.
4. Press [] to exit to the main menu.



9. ABR backlight switch

After pressing [] key, rotate the channel knob to select the menu [] .

1. Press [] to enter ABR settings.
2. Rotate the channel knob to select ON/OFF.
3. Press [] to confirm.
4. Press [] to exit to the main menu.

10. Reverse frequency REV

After pressing [] , rotate the channel knob to select the menu [] .

1. Press [] to enter the REV setting.
2. Rotate the channel knob to select ON/OFF.
3. Press [] to confirm.
4. Press [] to exit to the main menu.

11. Talk around T / A

After pressing [**...**], rotate the channel knob to select the menu [**1... 1...**].

1. Press [**...**] to enter the T/A setting.
2. Rotate the channel knob to select ON/OFF.
3. Press [**...**] to confirm.
4. Press [**...**] to exit to the main menu.

12. Tri-band stand by TDR

After pressing [**...**], rotate the channel knob to select the menu [**1... 2...**].

1. Press [**...**] to enter TDR setting.
2. Rotate the channel knob to select ON/OFF.
3. Press [**...**] to confirm.
4. Press [**...**] to exit to the main menu.

13. Transmit channel selection TX-F

After pressing [**...**] key, rotate the channel knob to select the menu [**1... 3...**].

1. Press [**...**] to enter TX-F settings.
2. Rotate the channel knob to select Auto/F1/F2/F3.
3. Press [**...**] to confirm.
4. Press [**...**] to exit to the main menu.

14. RX CTCSS/DCS setting R-CDC (support non-standard CTCSS/DCS)

After pressing [**...**], rotate the channel knob to select menu [**1... 4...**].

1. Press [**...**] to enter R-CDC settings.

2. Press [**...**] key to select the group: (OFF /67HZ / D023N / D023I).

3. Rotate the channel knob to select the desired CTCSS/DCS.

4. Press [**...**] to confirm.

5. Press the [**...**] button to exit to the main menu.

15. TX CDCSS/DCS setting T-CDC (support non-standard CTCSS/DCS)

After pressing [**...**], rotate the channel knob to select menu [**1... 5...**].

1. Press [**...**] to enter T-CDC settings.

2. Press [**...**] key to select the group: (OFF / 67HZ / D023N / D023I).

3. Rotate the channel knob to select the desired CTCSS/DCS.

4. Press [**...**] to confirm.

5. Press the [**...**] button to exit to the main menu.

CTCSS TONE FREQUENCY (Hz)

67.0	69.3	71.9	74.4	77.0	79.7
8.25	85.4	88.5	91.5	94.8	97.4
100.0	103.5	107.2	110.9	114.8	118.8
123.0	127.3	131.8	136.5	141.3	146.2
151.4	156.7	159.8	162.2	165.5	167.9
171.3	173.8	177.3	179.9	183.5	186.2
189.9	192.8	196.6	199.5	203.5	206.5
210.7	218.1	225.7	229.1	233.6	241.8
250.3	254.1	-	-	-	-

DCS CODE						
023	074	172	265	371	503	662
025	114	174	266	411	506	664
026	115	205	271	412	516	703
031	116	212	274	413	523	712
032	122	223	306	423	526	723
036	125	225	311	431	532	731
043	131	226	315	432	546	732
047	132	243	325	445	565	734
050	134	244	331	446	606	743
051	143	245	332	452	612	754
053	145	246	343	454	624	-
054	152	251	346	455	627	-
065	155	252	351	462	631	-
071	156	255	356	464	632	-
072	162	261	364	465	645	-
073	165	263	365	466	654	-

16. DTMF settings

After pressing [], rotate the channel knob to select the menu [].

1. Press [] to enter DTMFST settings.
2. Rotate the channel knob to select ON/OFF.

3. Press [] to confirm.
4. Press [] to exit to the main menu.

Note:

- 1) You can send the corresponding DTMF code by pressing the button during the transmission.
- 2) You can set in software, and turn on Menu 19 PTT ID to send DTMF code.

PTT ID:

PTT ID Code:

17. Scan mode settings SMODE

After pressing [], rotate the channel knob to select the menu [].

1. Press [] to enter SCAND setting.
2. Rotate the channel knob to select TO\CO\SE.
3. Press [] to confirm.
4. Press [] to exit to the main menu.

Three options for the scan mode are available under VFO mode:

TO: In this mode, the scanner will halt on a signal it encounters, and will hold there for some time. If you do not take action to disable the scanner within the time period, the scanner will resume even if the stations are still active.

CO: In this mode, the scanner will halt on a signal it encounters, and will hold there if the stations are still active. And after the carrier has dropped, the scanner will resume.

SE: In this mode, the scanner will halt on a signal it encounter, it will not restart automatically; you must manually re-initiate scanning if you wish to resume.

18. scan delete settings SCAN-ADD

After pressing [**MENU**], rotate the channel knob to select menu [**1 SQL 8 Stop**] .

1. Press [**Enter**] to enter SCAN-ADD settings.
2. Rotate the channel knob to select ON/OFF.
3. Press [**MENU**] to confirm.
4. Press [**EXIT**] to exit to the main menu.

19. PTTID (PTTID switch) settings

After pressing [**MENU**], rotate the channel knob to select the menu [**1 SQL 8 LED**] .

1. Press [**Enter**] to enter the PTTID setting.
2. Rotate the channel knob to select ON/OFF.
3. Press [**MENU**] to confirm.
4. Press [**EXIT**] to exit to the main menu.

20. MDF / A (Band A display mode)

After pressing [**MENU**], rotate the channel knob to select the menu [**2 Row 1 Rev**] .

1. Press [**Enter**] to enter MDF/A setting.
2. Rotate the channel knob to select FREQ/NAME/CHANNE.
3. Press [**MENU**] to confirm.
4. Press [**EXIT**] to exit to the main menu.

21. MDF / B (Band B display mode)

After pressing [**MENU**], rotate the channel knob to select the menu [**2 Row 1 SQL**] .

1. Press [**Enter**] to enter MDF/B setting.

2. Rotate the channel knob to select FREQ/NAME/CHANNE.

3. Press [**MENU**] to confirm.
4. Press [**EXIT**] to exit to the main menu.

22. MDF / C (Band C display mode)

After pressing [**MENU**], rotate the channel knob to select the menu [**2 Row 2 Row**] .

1. Press [**Enter**] to enter MDF/C setting.
2. Rotate the channel knob to select FREQ/NAME/CHANNE.
3. Press [**MENU**] to confirm.
4. Press [**EXIT**] to exit to the main menu.

23. Keypad lock mode LOCK M

After pressing [**MENU**] key, rotate the channel knob to select the menu [**2 Row 3 Vox**] .

1. Press [**Enter**] to enter LOCK M setting.
2. Rotate the channel knob to select MANUAL/AUTO.
3. Press [**MENU**] to confirm.
4. Press [**EXIT**] to exit to the main menu.



24. Boot display options OPNSET

After pressing [**MENU**], rotate the channel knob to select the menu [**2 Row 4 W/N**] .

1. Press [**Enter**] to enter the PTTID setting.
2. Rotate the channel knob to select OFF/DC/NSG/PIC.
3. Press [**MENU**] to confirm.
4. Press [**EXIT**] to exit to the main menu.



25. Busy channel lock BCL

After pressing [] key, rotate the channel knob to select the menu [].



1. Press [] to enter BCL setting.
2. Rotate the channel knob to select ON/OFF.
3. Press [] to confirm.
4. Press [] to exit to the main menu.



26. Shift direction selection setting S-D

After pressing [], rotate the channel knob to select menu [].



1. Press [] to enter S-D settings.
2. Rotate the channel knob to select o/+/-.
3. Press [] to confirm.
4. Press [] to exit to the main menu.

27. offset setting DIFFR

After pressing [], rotate the channel knob to select menu [].

1. Press [] to enter DIFFR settings.
2. Manually input offset.
3. Press [] to confirm.
4. Press [] to exit to the main menu.

28. End of emission ROGER

After pressing [] key, rotate the channel knob to select the menu [].

1. Press [] to enter the ROGER setting.

29. Scrambler function SCRM

After pressing [] key, rotate the channel knob to select the menu [].

1. Press [] to enter SCRM setting.

2. Rotate the channel knob to select ON/OFF.

3. Press [] to confirm.

4. Press [] to exit to the main menu.

29. Scrambler function SCRM

After pressing [] key, rotate the channel knob to select the menu [].

1. Press [] to enter the SCRM setting.

2. Rotate the channel knob to select ON/OFF.

3. Press [] to confirm.

4. Press [] to exit to the main menu.

30. Compandor COMP

After pressing [] key, rotate the channel knob to select the menu [].

1. Press [] to enter COMP settings.

2. Rotate the channel knob to select ON/OFF.

3. Press [] to confirm.

4. Press [] to exit to the main menu.

Specific Instructions
TECHNICAL PARAMETERS
Guarantee

<http://www.tyt888.com>

Specific Instructions

1. Side key definition

Open the programming software, select the side key function under the optional features, then select the function you want to implement from the drop-down menu of each option, and finally insert programming cable to write.

Side Key1 (Long)	Off
Side Key1 (Short)	Monitor
Side Key2 (Long)	Scan
Side Key2 (Short)	Scrambler

2. 1750Hz tone emission

PTT+side key 1, then you can emit 1750Hz tone.

3. Channel Storage and Deleting

In the VFO mode, long press Menu, the digits on the top right of the frequency blinks, rotate knob or up and down key to choose the numbers you want to store and then press Enter to confirm.

In the CH or MR mode, long press Menu, the digits on the top right of the frequency blinks, rotate knob or up and down key to choose the channels you want to delete and then press Enter to confirm.

4. Reset

Press PTT and Menu to power on, radio will show RESET VFO, rotate knob or up and down key to choose VFO or ALL.

VFO: to reset the settings in the VFO model. ALL: to reset the settings in the all models.

TECHNICAL PARAMETERS

General

Frequency	Rx:136-174MHz, 220-260MHz & 400-480MHz
Channel	128
Operating Voltage	7.4V DC
Operating Temperature	-10°C ~ +50°C
Frequency Stability	±2.5ppm
Dimension(Hxwx d)	116x53x36mm
Weight	106g(battery and antenna included)
Antenna Impedence	50Ω
Mode of operation	Simplex or semi-duplex

Transmitter

Frequency	Tx:144-148MHz, 222-225MHz & 420-450MHz
Power	5W
Modulation Type	FM
Spurious Power	• -15dB
Modulation Noise	< -40dB
Modulation Distortion	< 5%
Frequency Stability	5ppm
Max Fr. Deviation	• ±5KHz
Current	• 1600mA
Audio response(300-3400Hz)	+6.5 ~ -14dB
Adjacent Ch Power	• -65dB

Receiver

Frequency	Rx:136-174MHz, 220-260MHz & 400-480MHz
Sensitivity	• -0.2μV
Occupied Bandwidth	• 16KHz
Selectivity	• -65dB
Intermediation	• -55dB
Audio power	> 500mW
Audio distortion	• -10%
Frequency Stability	5ppm
Current	standby: 60mA working: 250Ma
Audio response(300-3400Hz)	+7 ~ -12.5dB

Note: Specification will be revised without notice due to technical improvement. Thank you.

Guarantee

Model Number: _____

Serial Number: _____

Purchasing Date: _____

Dealer: _____ Telephone: _____

User's Name: _____ Telephone: _____

Address: _____ Post Code: _____

Remarks:

- 1 This guarantee card to be kept by the user, no replenishment if lost.
- 2 This guarantee card to be filled & chopped by the dealer, or it is invalid.
- 3 Don't alter the guarantee card, please confirm the serial number on the guarantee card is same as that on the machine.
- 4 One-year guarantee, charger, battery, ear-phone, antenna and cable are not under guarantee.
- 5 The user can get repairing service from the following ways:
 - Go to the shop where you buy the machine.
 - Our local repairing agents.
 - Send back to our company.

Please cut along with this line



NOTE: This equipment has been tested and found to comply with the limits for a Class B digital device, pursuant to part 15 of the FCC Rules. These limits are designed to provide reasonable protection against harmful interference in a residential installation. This equipment generates uses and can radiate radio frequency energy and, if not installed and used in accordance with the instructions, may cause harmful interference to radio communications. However, there is no guarantee that interference will not occur in a particular installation. If this equipment does cause harmful interference to radio or television reception, which can be determined by turning the equipment off and on, the user is encouraged to try to correct the interference by one or more of the following measures:

- Reorient or relocate the receiving antenna.
- Increase the separation between the equipment and receiver.
- Connect the equipment into an outlet on a circuit different from that to which the receiver is connected.
- Consult the dealer or an experienced radio/TV technician for help

Changes or modifications not expressly approved by the party responsible for compliance could void the user's authority to operate the equipment. This device complies with Part 15 of the FCC Rules. Operation is subject to the following two conditions:

- (1) this device may not cause harmful interference, and
- (2) this device must accept any interference received, including interference that may cause undesired operation.