

# **Library Security Pedestal 2**

## **User's Guide**

Revision 4.2

July 2008

---

# Publishing Information

---

## Disclaimer and Limitation of Liability

All information herein is either public information or is the property of and owned solely by TAGSYS who shall have and keep the sole right to file patent applications or any other kind of intellectual property protection in connection with such information.

Nothing herein shall be construed as implying or granting to you any rights, by license, grant or otherwise, under any intellectual and/or industrial property rights of or concerning any of TAGSYS' information.

This document can be used for informational, non-commercial, internal and personal use only provided that:

- The copyright notice below, the confidentiality and proprietary legend and this full warning notice appear in all copies.
- This document shall not be posted on any network computer or broadcast in any media and no modification of any part of this document shall be made.

Use for any other purpose is expressly prohibited and may result in severe civil and criminal liabilities.

The information contained in this document is provided "AS IS" without any warranty of any kind. Unless otherwise expressly agreed in writing, TAGSYS makes no warranty as to the value or accuracy of information contained herein. The document could include technical inaccuracies or typographical errors. Changes are periodically added to the information herein. Furthermore, TAGSYS reserves the right to make any change or improvement in the specifications data, information, and the like described herein, at any time.

Therefore TAGSYS assumes no liability and is not responsible for customer applications or product or software that include TAGSYS products.

TAGSYS HEREBY DISCLAIMS ALL WARRANTIES AND CONDITIONS WITH REGARD TO THE INFORMATION CONTAINED HEREIN, INCLUDING ALL IMPLIED WARRANTIES OF MERCHANTABILITY, FITNESS FOR A PARTICULAR PURPOSE, TITLE AND NON-INFRINGEMENT. IN NO EVENT SHALL TAGSYS BE LIABLE, WHETHER IN CONTRACT, TORT OR OTHERWISE, FOR ANY INDIRECT, SPECIAL OR CONSEQUENTIAL DAMAGES OR ANY DAMAGES WHATSOEVER INCLUDING BUT NOT LIMITED TO DAMAGES RESULTING FROM LOSS OF USE, DATA, PROFITS, REVENUES, OR CUSTOMERS, ARISING OUT OF OR IN CONNECTION WITH THE USE OR PERFORMANCE OF INFORMATION CONTAINED IN THIS DOCUMENT.

TAGSYS does not and shall not warrant that this product/system/equipment will be resistant to all possible attacks, and shall not incur, and disclaims, any liability in this respect. Even if each product is compliant with current security standards in force on the date of their design, security mechanisms' resistance necessarily evolves according to the state-of-the-art in security and notably under the emergence of new attacks. Under no circumstances shall TAGSYS be held liable for any third party actions, and in particular in case of any successful attack against systems or equipment incorporating TAGSYS products.

TAGSYS disclaims any liability with respect to security for direct, indirect, incidental or consequential damages that result from any use of its products. It is further stressed that independent testing and verification by the person using the product is particularly encouraged, especially in any application in which defective, incorrect, or insecure functioning could result in damage to persons or property, denial of service, or loss of privacy.

© 2000-2008 TAGSYS. All rights reserved.

TRADEMARKS. TAGSYS is a registered trademark of TAGSYS S.A, all rights reserved. ARI0, FOLIO and other TAGSYS products referenced in these pages are either trademarks or registered trademarks of TAGSYS S.A. Other products and company names mentioned in these pages may be the trademarks of their respective owners.

Microsoft, Visual C++, Windows, and Windows NT are either registered trademarks or trademarks of Microsoft Corporation in the U.S.A. and/or other countries.

I-Code is a registered trademark of NXP.

Tag-It is a registered trademark of Texas Instruments.

Printed in France.

TAGSYS – 180 Chemin de St Lambert, 13821 LA PENNE SUR HUVEAUNE, France.

Tel: +33 (0) 4.91.27.57.00 / fax: +33 (0) 4.91.27.57.01

Document Reference: [11492D2](#)

# Read This First

Welcome to the TAGSYS L-SP2 Electronic Article Surveillance (EAS) system. This user's guide is designed to help you get up and running quickly using this high-quality Radio Frequency Identification (RFID) Anti-Theft system. It describes all you need to know about how to install and use the TAGSYS EAS/AFI system and its associated applications.

It provides a step-by-step guide for the following procedures:



- Installation of the L-SP2 EAS/AFI anti-theft system
- Configuring the system for use in your library
- Personalizing your product with your own preference settings

After you become familiar with the basic functions of the product, you can use the rest of this handbook as a reference for less common tasks, for maintaining your system, and also as a source of information if you have problems operating the system.

This End User's Guide is designed for all CIT (Certified Integrators by TAGSYS) and for TAGSYS Expert Network customers implementing a low-cost and high-performance RFID solution.

This document does not assume any previous knowledge of Radio Frequency Identification (RFID) technology.

## Conventions

Symbol	Meaning
	<p><b>CAUTION:</b> A note that advises users that a specific action could result in loss of data or damage the hardware.</p> <p><b>WARNING:</b> A note that advises users that a specific action may result in physical harm.</p>
	<p>A note that provides additional information that helps the user perform a task or obtain the best performance from the product.</p>

## If you need assistance

Please contact your nearest TAGSYS sales representative or the TAGSYS Welcome Desk at:

Telephone: +33 (0) 4 91 27 57 00  
Fax: +33 (0) 4 91 27 57 01  
E-Mail: [info@tagsysrfid.com](mailto:info@tagsysrfid.com)  
Website: <http://www.tagsysrfid.com>

## Contact for Comments

We welcome your feedback to help us provide high quality documentation.

For technical comments, please contact our welcome desk:

Telephone: +33 (0) 4 91 27 57 00  
Fax: +33 (0) 4 91 27 57 01  
E-Mail: [info@tagsysrfid.com](mailto:info@tagsysrfid.com)

Please remember to quote the Document Reference number [11492D2](#), your job title and your company.

## Quality Issues

TAGSYS implements stringent quality controls at all stages of its manufacturing process. However, should you find a defect with this product, please notify your TAGSYS Quality Service representative using the dedicated Product Return Form.

Telephone: +33 (0) 4 91 27 57 36  
Fax: +33 (0) 4 91 27 57 02

# Table of Contents

<b>PUBLISHING INFORMATION</b>	<b>2</b>
<b>DISCLAIMER AND LIMITATION OF LIABILITY</b>	<b>2</b>
<b>READ THIS FIRST</b>	<b>3</b>
CONVENTIONS	3
IF YOU NEED ASSISTANCE	4
CONTACT FOR COMMENTS	4
QUALITY ISSUES	4
<b>LIST OF FIGURES</b>	<b>8</b>
<b>LIST OF TABLES</b>	<b>9</b>
<b>1 FOR YOUR SAFETY</b>	<b>10</b>
1.1 GENERAL USE	10
1.2 CARE AND MAINTENANCE	10
1.3 IMPORTANT SAFETY INFORMATION	11
1.3.1 OPERATING ENVIRONMENT	11
<b>2 CERTIFICATION</b>	<b>12</b>
2.1 OCCUPATIONAL HEALTH	12
2.1.1 PUBLIC EXPOSURE	12
2.1.2 EMPLOYEES EXPOSURE	12
2.2 SAFETY NOTICES	12
2.3 REGULATORY NOTICES	12
2.3.1 IN EUROPE (CE AND RTTE DIRECTIVES)	13
2.3.2 IN USA (FCC DIRECTIVE)	14
<b>3 SYSTEM OVERVIEW</b>	<b>16</b>
3.1 FEATURES	16
3.2 BRIEF L-SP2 DESCRIPTION	17
<b>4 INSTALLATION</b>	<b>18</b>
4.1 RECOMMENDATIONS BEFORE INSTALLATION	18
4.1.1 WIRE FEED SHEATHS	18
4.1.2 ELECTRICAL SAFETY RULES	19
4.1.3 NETWORK CABLE INSTALLATION	19
4.2 L-SP2 EAS SYSTEM COMPONENTS	20
4.3 L-SP2 PEDESTAL	20
4.3.1 TOOLS REQUIRED	20

4.3.2	PLACEMENT OF PEDESTALS	21
4.3.3	INSTALLING THE PEDESTAL	22
<b>5</b>	<b>CONFIGURATION</b>	<b>26</b>
<b>5.1</b>	<b>CHIP CONFIGURATION</b>	<b>26</b>
5.1.1	SCANNING DURATION	26
5.1.2	EAS MODE VERSUS AFI MODE	26
<b>5.2</b>	<b>UNDERSTANDING THE L-SP2 SYNCHRONIZATION PROCESS</b>	<b>26</b>
5.2.1	STANDARD SYNCHRONIZATION MODE	26
5.2.2	SPECIAL SYNCHRONIZATION MODE	27
5.2.3	WIRELESS SYNCHRONIZATION	28
5.2.4	SYNCHRONIZATION BY WIRE	29
<b>5.3</b>	<b>CONFIGURATION OF THE ETHERNET INTERFACE</b>	<b>29</b>
<b>5.4</b>	<b>CONFIGURATION OF THE L-SP2</b>	<b>31</b>
5.4.1	INSTALLING THE CONFIGURATION SOFTWARE	31
5.4.2	BASIC CONFIGURATION	34
5.4.3	ADVANCED CONFIGURATION	38
<b>5.5</b>	<b>PEOPLE COUNTER MANAGEMENT</b>	<b>42</b>
5.5.1	RESETTING THE LOCAL PEOPLE COUNTER	42
5.5.2	RESETTING THE REMOTE PEOPLE COUNTER	42
<b>6</b>	<b>ANTENNA TUNING</b>	<b>43</b>
<b>6.1</b>	<b>REQUIRED MATERIALS</b>	<b>43</b>
6.1.1	TAGSYS ANTENNA TUNING KIT (NOT INCLUDED)	43
6.1.2	OSCILLOSCOPE	43
6.1.3	PROBES	44
<b>6.2</b>	<b>VERIFYING ANTENNA PERFORMANCES</b>	<b>44</b>
<b>6.3</b>	<b>ADJUSTING THE ANTENNA IMPEDANCE</b>	<b>44</b>
6.3.1	USING THE ANTENNA TUNING KIT	44
6.3.2	USING AN IMPEDANCE ANALYZER	47
<b>6.4</b>	<b>ADJUSTING THE ANTENNA ISOLATION</b>	<b>48</b>
6.4.1	USING THE ANTENNA TUNING KIT	48
6.4.2	USING AN IMPEDANCE ANALYZER	50
<b>7</b>	<b>OPERATION</b>	<b>52</b>
<b>7.1</b>	<b>THEORY OF OPERATION</b>	<b>52</b>
<b>7.2</b>	<b>STARTING THE SYSTEM</b>	<b>52</b>
<b>7.3</b>	<b>NORMAL OPERATION</b>	<b>52</b>
<b>7.4</b>	<b>SHUTDOWN</b>	<b>52</b>
<b>8</b>	<b>MAINTENANCE</b>	<b>53</b>
<b>8.1</b>	<b>SERVICING THE PEDESTALS</b>	<b>53</b>
<b>8.2</b>	<b>SERVICING THE ELECTRONICS UNIT</b>	<b>53</b>
<b>8.3</b>	<b>UPGRADING THE DSP FIRMWARE</b>	<b>54</b>
<b>8.4</b>	<b>SPARE PARTS</b>	<b>54</b>
<b>9</b>	<b>TROUBLESHOOTING</b>	<b>55</b>

---

<b>9.1 SOURCES OF INTERFERENCE</b>	<b>55</b>
<b><u>10 TECHNICAL SPECIFICATIONS</u></b>	<b><u>56</u></b>
10.1 MECHANICAL DATA	56
10.2 ELECTRICAL DATA	56
10.3 RF OUTPUT POWER (50Ω TERMINATED)	56
10.4 I/O PORT	56
<b><u>11 PERFORMANCE TEST</u></b>	<b><u>58</u></b>
11.1 TEST CONDITIONS	58
11.2 TEST PROCEDURE	58
<b><u>12 WARRANTY CONDITIONS</u></b>	<b><u>60</u></b>
12.1 WARRANTY EXCLUSIONS	60
12.2 GENERAL PROVISIONS	61
12.3 HOW TO RETURN DEFECTIVE PRODUCTS	61

# List of Figures

Figure 1: FCC power and uplink settings ..... 15

Figure 2: Electric Connections..... 18

Figure 3: Safety Electrical Installation ..... 19

Figure 4: Ferrite clamp mounted on Ethernet cable ..... 20

Figure 5: Clearance around Pedestal..... 21

Figure 6: Photoelectric sensor..... 22

Figure 7: Top view of correct L-SP2 installation..... 22

Figure 8: Side view of correct L-SP2 installation..... 23

Figure 9: Pedestal Mountings..... 23

Figure 10: L-SP2 Bottom (4 screws) ..... 24

Figure 11: Chronogram Sample (1 Master/ 4 Slaves)..... 27

Figure 12: Configuration sample ..... 28

Figure 13: I/O port support..... 29

Figure 14: Wire disposition ..... 29

Figure 15: Configuration Connector ..... 30

Figure 16: Main Configuration Window, not connected to the L-SP2 ..... 34

Figure 17: Main Configuration Window, connected to the L-SP2..... 35

Figure 18: Multi-gate Configuration with 2 different Ids..... 36

Figure 19: Database ..... 37

Figure 20: Advanced Configuration window..... 38

Figure 21: Master/Slave synchronization antenna configuration..... 39

Figure 22: Front View ..... 41

Figure 23: Alarm Potentiometer..... 41

Figure 24: People Counter and Sensor..... 42

Figure 25: Antenna Tuning (Impedance)..... 45

Figure 26: Antenna Connection..... 45

Figure 27: Trimmer Capacitor..... 46

Figure 28: Adjusting Trimmer Capacitors ..... 46

Figure 29: Impedance Values using the Tuning Kit..... 46

Figure 30: Antenna Tuning (Impedance) using an Impedance Analyzer ..... 47

Figure 31: Impedance Values using an Impedance Analyzer ..... 47

Figure 32: Antenna Tuning Isolation..... 48

Figure 33: Antenna Adjustment Screw..... 49

Figure 34: Antenna Tuning (Isolation) with Impedance Analyzer..... 50

Figure 35: Isolation Values using an Impedance Analyzer ..... 50

Figure 36: Mechanical Dimensions of Pedestal Base ..... 57

Figure 37: Mechanical Dimensions of Pedestal Base ..... 57

Figure 38: Tag Orientation..... 58

Figure 39: Example..... 58

Figure 40: Test Chart..... 59



---

# List of Tables

---

Table 1: L-SP2 EAS System Components .....	20
Table 2: Scanning Duration .....	26
Table 3: Contents of Antenna Tuning Kit.....	43
Table 4: Oscilloscope Settings .....	45
Table 5: Oscilloscope Settings .....	48
Table 6: Troubleshooting Table .....	55

# 1 For Your Safety

---

## 1.1 General Use

The L-SP2 is designed to be rugged and reliable and to provide years of trouble-free service. Please observe the following general tips:

- Take care not to scratch the device. Keep the device clean. When working with the device, use only TAGSYS-approved accessories.
- This device is not waterproof and should not be exposed to rain or moisture. Under extreme conditions, water may enter the circuitry.
- Protect the device from extreme temperatures. For example, do not place the device in a windowed area where the sun may cause extreme temperatures, and keep it away from heaters and other heat sources.
- Do not store or use the device in any location that is extremely dusty, damp, or wet.
- Use a soft, damp cloth to clean the device. If the surface of the device becomes soiled, clean it with a soft cloth moistened with a diluted window-cleaning solution.

## 1.2 Care and Maintenance

This device is a product of superior design and should be handled with care. The suggestions below will further increase the lifetime of this device.

- Keep the device and all parts and accessories out of the reach of small children.
- Keep the device dry. Precipitation, humidity and liquids contain minerals that will corrode electronic circuits.
- Do not use or store the device in dusty, dirty areas. Its moving parts can be damaged.
- Do not store in hot areas. High temperatures can shorten the life of electronic devices, damage batteries and warp or melt certain plastics.
- Do not store in cold areas. When the device warms up (to its normal temperature), moisture can form inside the device, which may damage electronic circuit boards.
- Do not attempt to open the device. Non-professional handling of the device may damage it.
- Handle the device with care. Shocks may break internal circuit boards.
- Do not clean the device with harsh chemicals, cleaning solvents or strong detergents. Gently wipe the device with a soft cloth slightly dampened in a mild soap-and-water solution.
- Do not paint the device. Paint may clog the device's moving parts and prevent proper operation. Paint with metallic contents may limit device performances.
- If the device or any accessory are not working properly, take it to your nearest qualified TAGSYS representative.

## **1.3 Important Safety Information**

### **1.3.1 Operating Environment**

When connecting the device or any accessory to another device, read its user's guide for detailed safety instructions. Do not connect incompatible products.

As with all RF equipment, users are advised that the equipment should only be used in its normal operating position.

---

# 2 Certification

---

## 2.1 Occupational Health

TAGSYS L-SP2 EAS System has been designed and tested to be in conformity with the European Standard EN 50364 “Limitation of human exposure to electromagnetic fields from devices used in Electronic Article Surveillance (EAS), Radio Frequency Identification (RFID) and similar applications” in conjunction with the European Standard EN 50357 describing how to evaluate the exposure level.

### 2.1.1 Public Exposure

The EAS systems are only designed for public transitory use.



Librarian should set up measurements of monitoring at the doors to avoid prolonged stay between them.

---

### 2.1.2 Employees Exposure

The operators are located apart from the principal detection zone and as a matter of fact, not subject to exposure.

(Please see section [4.3.2 “Placement of Pedestals”](#))



For servicing operations it is recommended to deactivate the EAS system.

---

## 2.2 Safety Notices

The L-SP2 has been tested to be in conformity with the EN standard 60950-1: “Information Technology Equipment Safety”

It is the responsibility of the CIT (Certified Integrators by TAGSYS) to install the L-SP2 as described in TAGSYS Product Manuals or TAGSYS Documentation.

Modification of any TAGSYS Library System is prohibited without the written consent of TAGSYS. Unauthorized modifications may void the conformity of the equipment to safety specifications and will void the TAGSYS warranty.

## 2.3 Regulatory Notices

An RFID system typically composed of an RF emission device such as the L-SP2 connected to an antenna is subject to national regulations that may differ by country.

One important item to consider is the maximum permissible magnetic field intensity at a distance of 10 meters from the antenna that must not exceed 42 dBµA/m in Europe and 38 dBµA/m in US.

The L-SP2 meets these limits.

### 2.3.1 In Europe (CE and RTTE Directives)

The L-SP2 complies (CE Declaration of Conformity granted) with the European EMC directive.

The L-SP2 complies with the requirements of the Telecommunication Terminal Equipment Act (FTEG) and the RTTE Directive 1995/5/EC.

It is the responsibility of the TAGSYS Reseller to install the L-SP2 as described in this User's Guide or TAGSYS Documentation.

Any modification of the L-SP2 is prohibited without the written consent of TAGSYS. Unauthorized modifications may void the conformity of the equipment to CE and RTTE Directives and will void the TAGSYS warranty.



It is the responsibility of the CIT (Certified Integrators by TAGSYS) to install the L-SP2 as described in this Reference Guide or in TAGSYS Documentation.  
If a L-SP2 is further integrated in a different product, it is the responsibility of the manufacturer of this complementary product to obtain the required approvals for this product.

---

## 2.3.2 In USA (FCC Directive)

### L-SP2

*WARNING TO USERS IN THE UNITED STATES*  
FEDERAL COMMUNICATIONS COMMISSION (FCC) RADIO  
INTERFERENCE STATEMENT 47 CFR Section 15.105(b)

This equipment has been tested and found to comply with the limits for a Class B digital device, pursuant to Part 15 of the FCC Rules. These limits are designed to provide reasonable protection against harmful interference in a residential installation. This equipment generates, uses and can radiate radio frequency energy and if not installed and used in accordance with the instructions may cause harmful interference to radio communications. However, there is no guarantee that interference will not occur in a particular installation. If this equipment does cause harmful interference to radio or television reception, which can be determined by turning the equipment off and on, the user is encouraged to try to correct the interference by one or more of the following measures:

- Reorient or relocate the receiving antenna.
- Increase the separation between the equipment and receiver.
- Connect the equipment into an outlet on a circuit different to that to which the receiver is connected.
- Consult the dealer or an experienced radio/TV technician for help.

#### **NO UNAUTHORIZED MODIFICATIONS**

47 CFR Section 15.21

**CAUTION:** This equipment may not be modified, altered, or changed in any way without signed written permission from TAGSYS SA. Unauthorized modification may void the equipment authorization from the FCC and will void the TAGSYS warranty.

#### **ANTENNA REQUIREMENT**

47 CFR Section 15.203

**CAUTION:** This equipment must be professionally installed. The installer shall be responsible for ensuring that the proper antenna is employed so that the limits in this part are not exceeded. Non-professional installation or installation of the equipment with an improper antenna may void the equipment authorization from the FCC and will void the TAGSYS warranty.

The L-SP2 has been designed to comply with Part 15 of the FCC Rules.

Operation is subject to the following two conditions: (1) The system devices may not cause harmful interference, and (2) The library system devices must accept any interference received, including interference that may cause undesired operation.

Figure 1: FCC power and uplink settings

Advanced Configuration...

**TAGSYS RFID™**  
e-connecting goods

Synchro

Mode : Wireless

Antenna : Top

Detection level : 200

Power

Output power : 4.0 W

Antenna Sequence

Top->Center->Bottom->Center (Normal)

Report interval

Report every 10 rounds

AFI Detection Options

Sensitivity : High Value : 9E

Alarm

Normal

ISO15693 Uplink

1 of 256

OK Cancel



**CAUTION:** In any case, for operational configuration this value should not exceed 4W to be in compliant with FCC. Please see [Figure 1: FCC power and uplink settings](#).



**CAUTION:** ISO15693 uplink data rate you should not exceed 1.65kb/s in order to comply with FCC standard certification. Please see [Figure 1: FCC power and uplink settings](#).

## 3 System Overview

---

### 3.1 Features

Being a standalone solution, TAGSYS security pedestal do not need to be linked to the library database, and can still operate when the Integrated Library System (ILS) is down or under maintenance. The security pedestal does not require additional equipment to operate.

The L-SP2 pedestal feature:

- Multi-protocol features which makes it compatible with C220, C320, ISO15693 chips
- EAS mode supported for the C370 (NXP SLI), C370-L (NXP SLI-L) chips
- AFI mode supported, with configurable AFI value
- Single item Read-Memory supported in EAS mode for C320, C370 (NXP SLI), C370-L (NXP SLI-L)
- Standard Multiple items Read-Memory supported in AFI mode using the optional command Read Mutiple Blocks as described by the ISO15693-3
- Enhanced Multiple items Read-Memory supported in AFI mode for C370 (NXP SLI), C370-L (NXP SLI-L), Tag-it™HFI (Texas Instruments) chips
- Read-Memory: up to 256-bits
- One block system electronic embedded into the pedestal
- Mechanical compatibility with Smarto L122 EAS system
- A remotely accessible people counter based on a photoelectric sensor coupled to a reflector
- An Ethernet ready version is also available

This is a low-cost security system as it only requires a single RFID tag for both anti-theft and identification purposes.



## 3.2 Brief L-SP2 Description



The components of the L-SP2 EAS system are contained within the L-SP2 pedestal. At least two pedestals are required for each EAS gate. A set of pedestals is known as a gate and may consist of several pedestals. Please see section 4 "[Installation](#)" for more information.

The L-SP2 is built in a one frame:

- A L-SP2 Electronics unit is used to control each pedestal. This electronics unit generates the RF signal transmitted by the antennas and picks up the reply from the RFID tag. If an activated RFID tag is detected, the electronics unit will activate the alarm of the LED/buzzer board on the pedestal.
- These antennas are sensitive receivers used to detect the theft bit status of the RFID tag as it passes through the EAS gate.
- A warning visual and audible device (LED/Buzzer board)
- A remotely accessible people counter equipped with a photoelectric sensor

To operate, the L-SP2 will only need a power supply cable.



In standard configuration the Ethernet interface is not provided. If the Ethernet version is chosen then provide a second sheath for the Ethernet cable.

# 4 Installation

## 4.1 Recommendations before Installation

### 4.1.1 Wire Feed Sheaths

Within the framework installation you need a power supply cable sheath and an Ethernet cable sheath for the Ethernet network with Ethernet version. These sheathed cables will be located at the bottom center of the pedestal as shown in [Figure 9](#).

The L-SP2 is delivered with a power supply cable of 1-meter length located underneath of the pedestal at the bottom center.



The L-SP2 Ethernet version is provided with a 1meter Ethernet cable.

Figure 2 below shows an example of installation and connection of the L-SP2.

**Figure 2: Electric Connections**

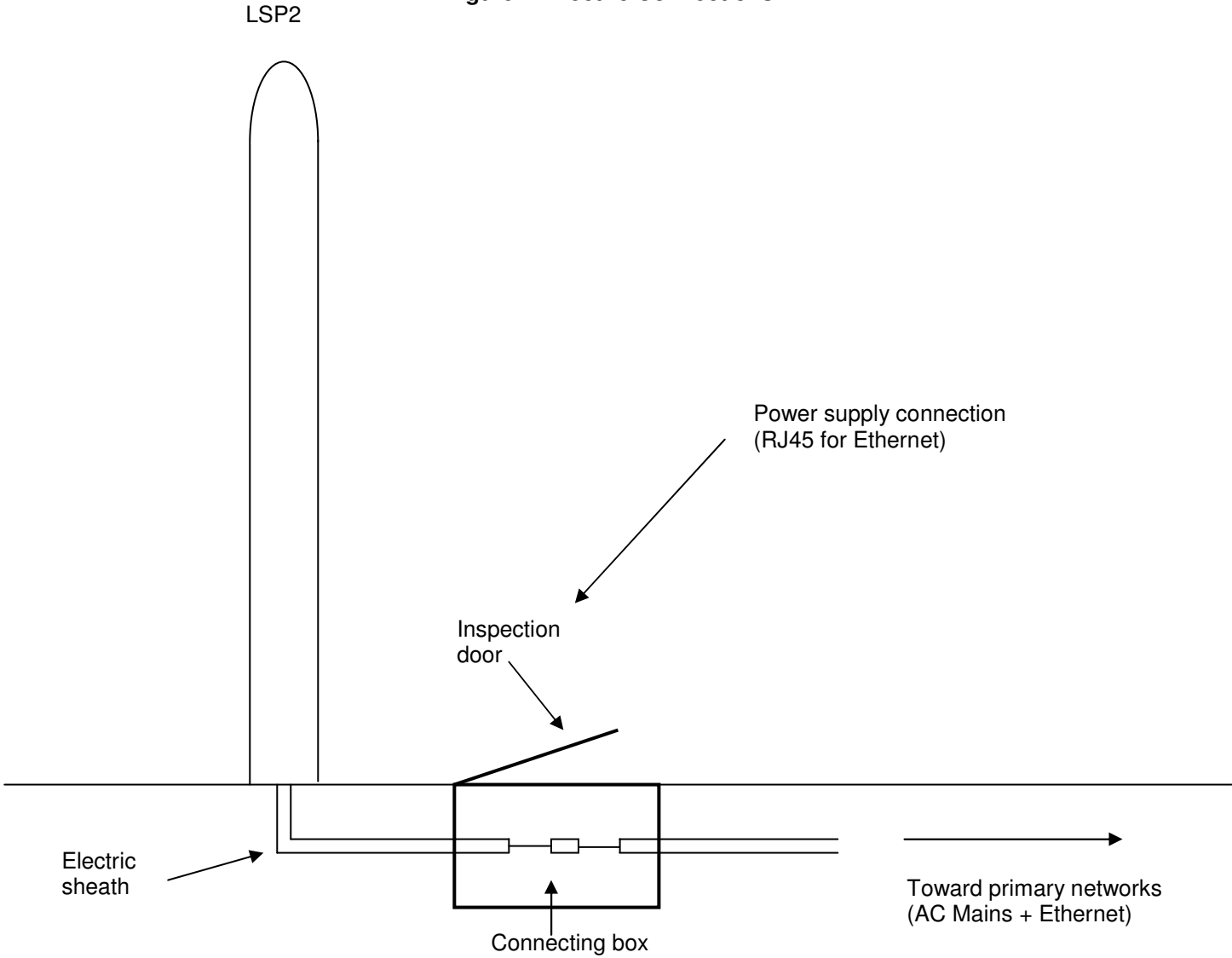

## 4.1.2 Electrical Safety Rules

The mains powers the L-SP2 so it is necessary to provide a differential protection and a shutting-off device. [Figure 3](#) below shows how to connect the L-SP2 pedestals to the mains.

**Figure 3: Safety Electrical Installation**

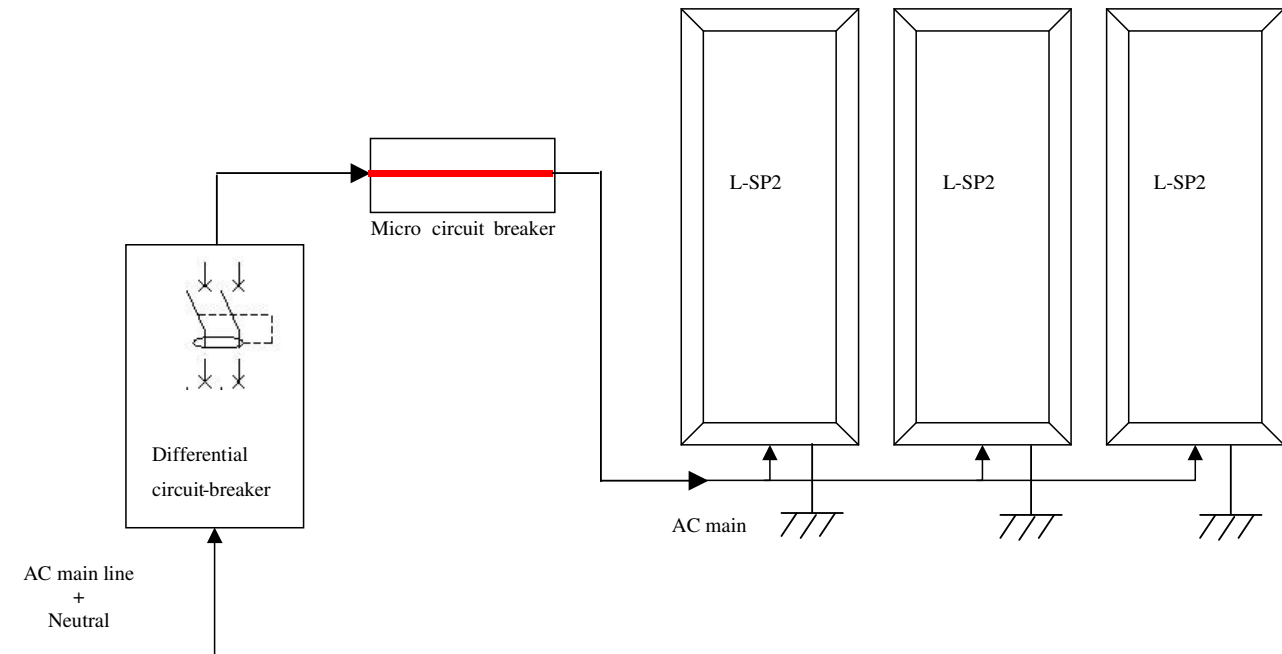

The electrical installation must be carried on by qualified personnel only. Micro circuit breaker and differential circuit-breaker ratings depend on country regulations in force.

The power supply cable provided is of PVC type, H05VVF 0.75 mm<sup>2</sup> multi-stranded (14 AWG) and complies with FEC60950 standard.

## 4.1.3 Network cable installation

The LSP2 Ethernet version is provided with an Ethernet cable mounted with a ferrite for LAN cables. If the cable is to be changed, you will have to add a ferrite to this cable.

References:

- Ethernet cable: Unshielded Ethernet cable, UTP-Cat5
- Ferrite for LAN cable: Würth Elektronik (Manufacturer ref: 742 7111)

This ferrite will have to be installed as follow (Figure 4):

- Inside the electronic casing
- Near the Moxa board
- 20mm maximum distance from the RJ45 connector.

**Figure 4: Ferrite clamp mounted on Ethernet cable**

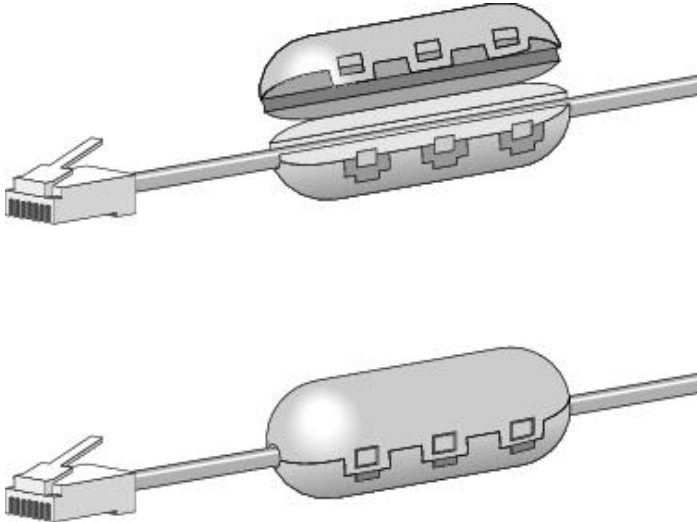

## 4.2 L-SP2 EAS System Components

The components included in the L-SP2 EAS System package are listed in [Table 1](#)

**Table 1: L-SP2 EAS System Components**

Quantity	Description
1	L-SP2 Pedestal
8	40 mm Philips-head, countersunk screws with a diameter of 6 mm
8	8 mm plastic cement plugs
1	L-SP2 EAS System CD-ROM
1	RS 232 cable (system configuration)

## 4.3 L-SP2 Pedestal



**CAUTION:** This equipment is intended for indoor use only under the conditions described in this document. Should it be used outside these conditions cannot be guaranteed, and is not recommended. Please read section 1 “[Publishing Information](#)” before installation or use.

### 4.3.1 Tools Required

The following tools are required during installation:

- Tape measure
- Square
- Drill with 4 mm, 8-mm and 19-mm bits
- Philips-head screwdriver
- Level

### 4.3.2 Placement of Pedestals

Pedestals must be mounted between 800 and 915 mm apart (edge to edge) for maximum reliable performance. There should be at least one pair of pedestals at each entrance/exit point of the library. There should be a pedestal at each edge of the entrance, and a clear space of at least 500 mm around the edge of the pedestals to ensure that the antennas will not be detuned. This clear space must not contain any metallic objects, but may contain some substrates such as non-metallic/non-conductive building materials such as wood, glass, chipboards and plasterboards.



**CAUTION:** In case several pedestal row to be installed it is recommended every L-SP2 gate being positioned in the same direction (the people counter of each looking toward the same direction)

Be cautious to properly align the pedestal in order to centre the photoelectric beam sensor on the reflector of the next pedestal.



**CAUTION:** Each L-SP2 should be installed within following tolerances:  
Horizontal angular alignment tolerance with reference to pedestals alignment:  $0^\circ \pm 2^\circ$   
Vertical angular tolerance with reference to ground surface :  $90^\circ \pm 1^\circ$

**Figure 5: Clearance around Pedestal**

- A:** Indicates the distance (6 ft. 6in.) to a permanent librarian position.
- B:** Indicates the distance (8 ft.) from other RFID stations.
- C:** Indicates the recommended distance (36 in. face panel to face panel) between pedestals.
- D:** Indicates the minimum distance (31½ in.) between a pedestal and large metal object.
- E:** Indicates the minimum distance (20 in.) between a pedestal and small metal object.
- F:** Indicates the minimum distance (30 ft.) between Master pedestals (specific synchronization ID, see section 5.2 “Understanding the L-SP2 Synchronization Process”).

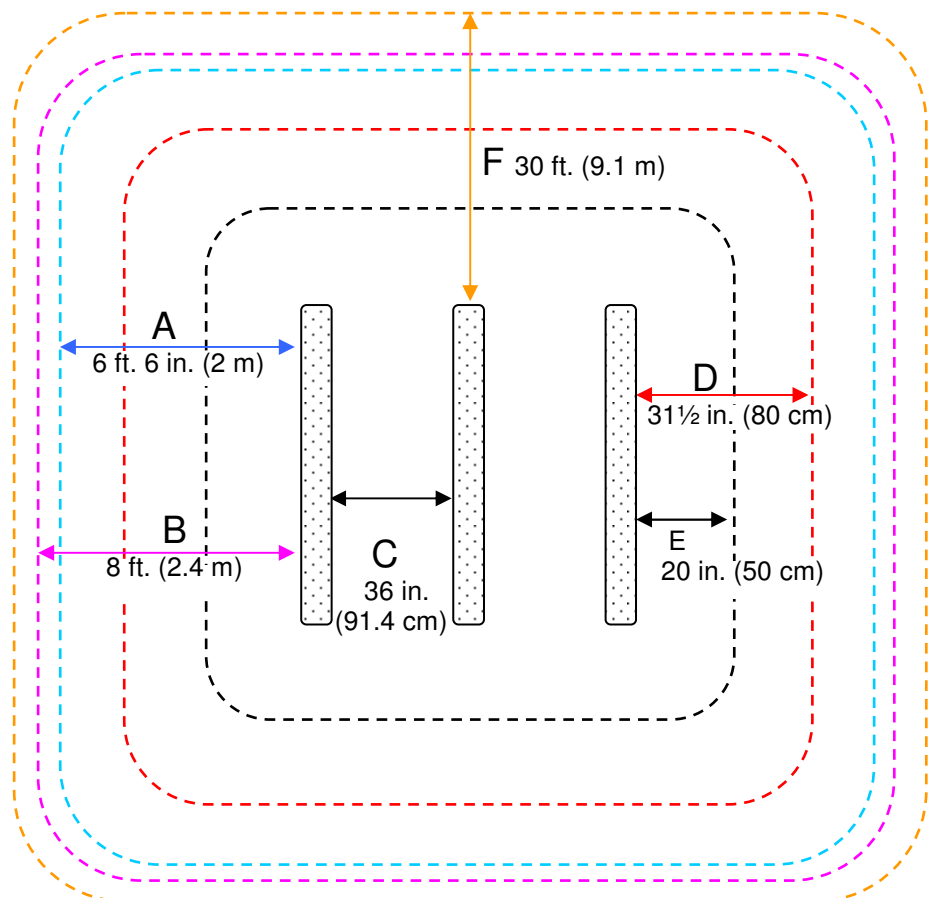

### 4.3.3 Installing the Pedestal

Once the L-SP2 will be powered, the photoelectric sensor will emit a red light beam. To precisely align the sensor and the reflector, an orange LED is present on the back of the photoelectric sensor. When the orange LED is continuously on, the sensor and the reflector are perfectly aligned.

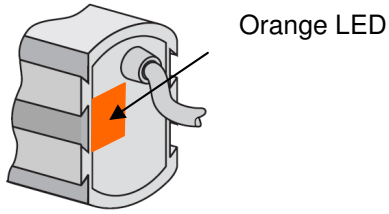

**Figure 6: Photoelectric sensor**

On the contrary the orange LED is blinking, and then you have to adjust the photoelectric sensor, so that the red light beam is centered with the opposite reflector. This operation is achieved using a white paper to clearly see where the red light beam is pointed at. When perfectly centered, the orange LED will continuously be ON.

Special attention must be taken for the 2 pedestals positioning:

- They must be positioned face to face
- They must be parallel
- They must be aligned
- The orange LED must be continuously ON when powered

Then the 2 pedestals can be secured to the ground.

A good positioning will ensure the red LED beam to be reflected by the reflector as shown below.

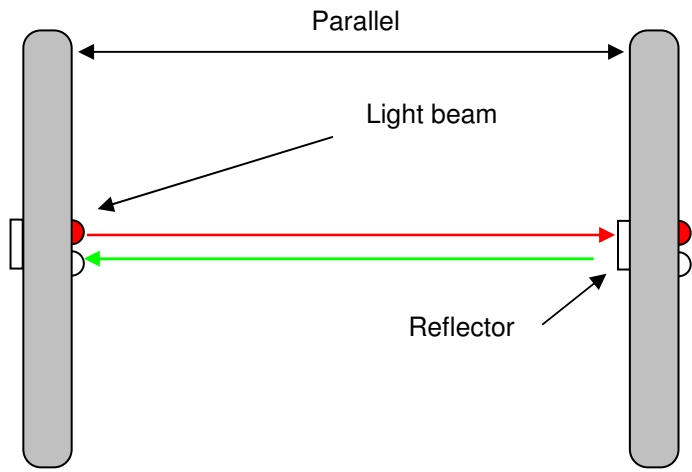

**Figure 7: Top view of correct L-SP2 installation**

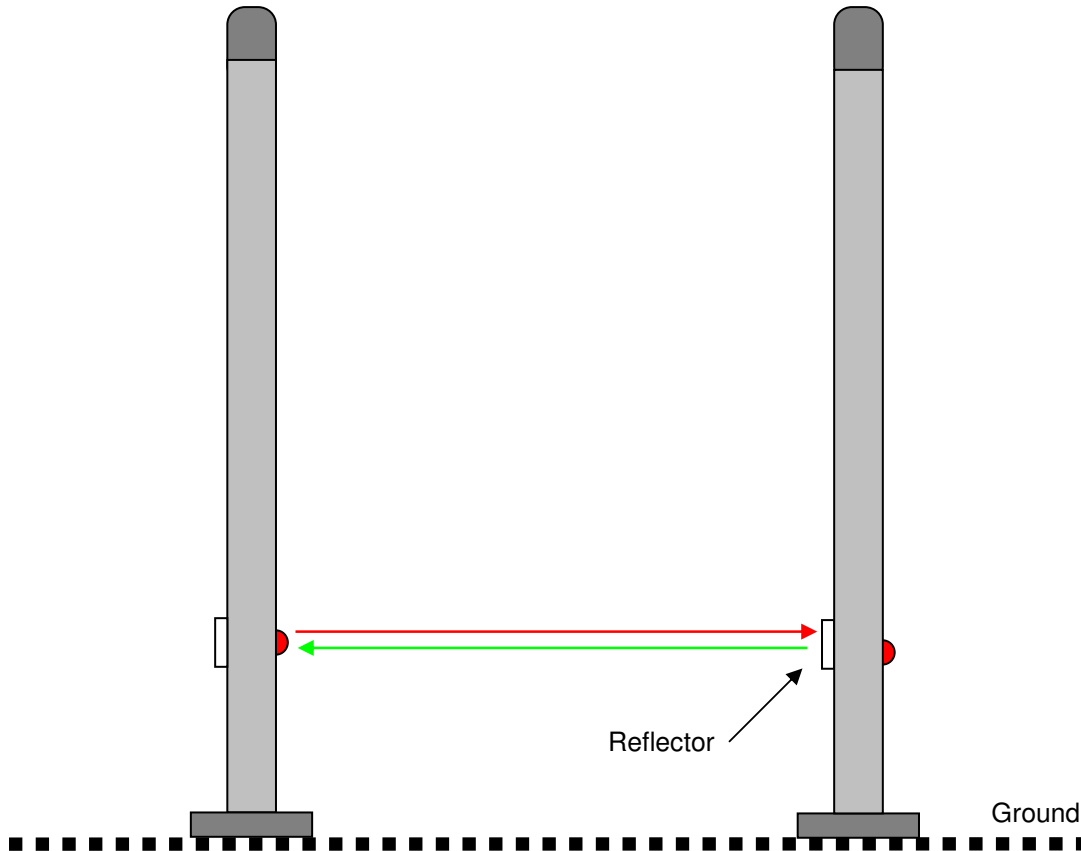
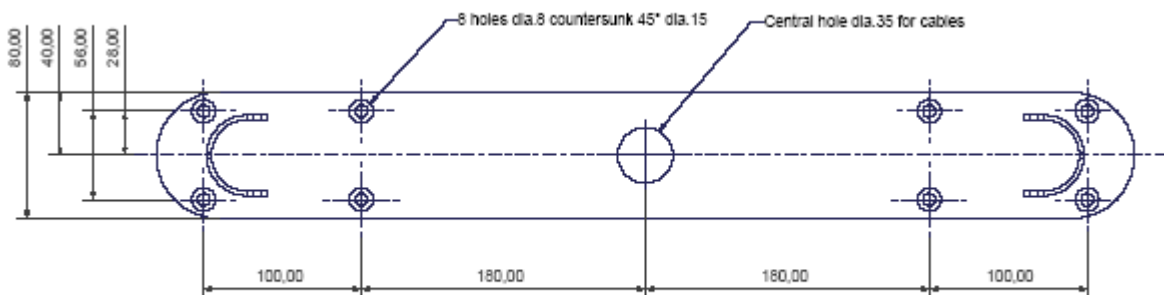

**Figure 8: Side view of correct L-SP2 installation**

The L-SP2 pedestal is mechanically compatible with the Smarto L122 Pedestal.

After having defined the location of the pedestals, refer to the mechanical drawing of the pedestal-mounting diagram (Figure 9). The pedestal is fastened to the floor using screws that are strong enough to support the weight of an average adult falling against the pedestal.

**Figure 9: Pedestal Mountings**



All dimensions in mm.

1. Identify and mark the location of the holes to be drilled for mounting the pedestal to the ground. The use of a tape measure and a square is recommended.
2. Drill the cable access and mounting holes according to the type of ground surface:
  - a. Wood floor: Drill eight holes with a diameter of 4 mm for the mounting screws and one hole with a diameter of 19 mm for the cable access.

- b. Cement floor: Drill eight holes with a diameter of 8 mm for the cement floor plugs and one hole with a diameter of 19 mm for the cable access. It may be necessary to provide a groove for the power supply cable connected to the L-SP2 Electronics Unit. Insert the concrete floor plugs into the mounting holes.



**CAUTION:** Always use a protective sleeve for main power cable, which match to the non-inflammability standard. Main power cable must be a 3 wire (line, neutral and earth), multi stranded copper wire, 0.5 mm<sup>2</sup>/ 3A)

3. Remove the pedestal from the box.
4. Remove the plastic cover from the both sides after removing the 4 fixing screws.

**Figure 10: L-SP2 Bottom (4 screws)**



5. Engage the power supply cable in the electric sheath and if available the Ethernet cable in the other sheath (please refer to section 4.1.1 “Wire Feed Sheaths”).
6. Place the pedestal base over the mounting holes. Insert and fasten the screws in the mounting holes according to the type of ground surface:
  - Wood floor: Insert the screws directly into the mounting holes and tighten the screws in place.
  - Concrete floor: Insert the screws into the concrete floor plugs and tighten the screws in place.



When tightening the screws in place, first tighten the screws in place  $\frac{3}{4}$  of the way. Once all screws are in place, then tighten each screw progressively, one after each other to ensure that the floor bracket is solidly fixed into place and completely vertically aligned. The use of a level may be required.

7. Connect the cables in the connection box as show in [Figure 2](#) with respect to the following rules:

‘Phase’ wire is brown  
‘Neutral’ wire is bleu  
‘Ground’ wire is yellow/green





AC mains 110/220V. Be sure that there is no power supply current before carrying on the connection operation. To do so, the micro circuit-breaker must be opened. (Figure 3)

---

8. Once all the L-SP2 pedestal have been installed, close the micro circuit-breaker (Figure 3) to power up the system before starting configuration operations. Please see section 5 “Configuration”.
9. After the configuration has been carried on, replace the two plastic covers and tighten the 4 fixing screws.

# 5 Configuration

All configuration operations of L-SP2 systems are carried on with the L-SP2 Configuration Utility Software.

## 5.1 Chip Configuration

### 5.1.1 Scanning Duration

For optimal performance the scanning duration (Tscan) should not exceed 250ms. Tscan is the period to scan all the pedestal of a group. Depending on your chip configuration and the number of pedestal installed you can determine the scanning duration of your installation.

**Table 2: Scanning Duration**

	No Read Memory	Read Memory
<b>Synchronization duration</b>	6ms	6ms / pedestal
<b>C220 / C320</b>	25ms / pedestal	80ms / pedestal
<b>C370 / C370-L EAS</b>	35ms / pedestal	100ms / pedestal
<b>C370 / C370-L / Tag-It / Generic ISO15693 AFI</b>	80ms / pedestal	65ms / pedestal

Example 1: with a 3 pedestals system using the C220 + C370-EAS without Read-Memory  
The scanning duration will be:  $T_{scan} = 6ms + (25ms+35ms) \times 3 = 186ms$

Example 2: with a 3 pedestals system using the 370-AFI + Read-Memory.  
The scanning duration will be:  $T_{scan} = (6ms+65ms) \times 3 = 213ms$

### 5.1.2 EAS Mode versus AFI Mode

EAS mode is only supported by the C370 or C370-L (NXP chip). AFI mode is supported by every ISO15693 chip, whatever the manufacturer (NXP, Texas Instrument, ST ...).

In non-Read memory mode, EAS mode is faster than AFI mode, therefore it helps keeping a low scanning duration in case of a high number of pedestals.

In Read memory mode, AFI mode will give better results. AFI mode will allow specific addressing of items which are stolen. Therefore the LSP2 will be able to read the memory of multiple stolen items.

This is not possible in EAS mode; the read memory can not be addressed using the EAS status of the item. Therefore, the LSP2 will only read the memory of one item. In the case of one stolen item among multiple checked-out items, the LSP2 would retrieve the memory of one of them, whatever its EAS status.

## 5.2 Understanding the L-SP2 Synchronization Process

### 5.2.1 Standard Synchronization Mode

To manage a group of pedestal, a synchronization burst is sent by the master gate to all the slaves' gate. This is called the synchronization process.

- Only one gate is defined to be the master who emits a synchronization burst to the slaves in close proximity.
- The other gates, configured as slave, synchronize themselves on the master's burst, and if they have a matching ID, scan the configured chip.



Default configuration of the L-SP2 is set to Master.

**Figure 11: Chronogram Sample (1 Master/ 4 Slaves)**

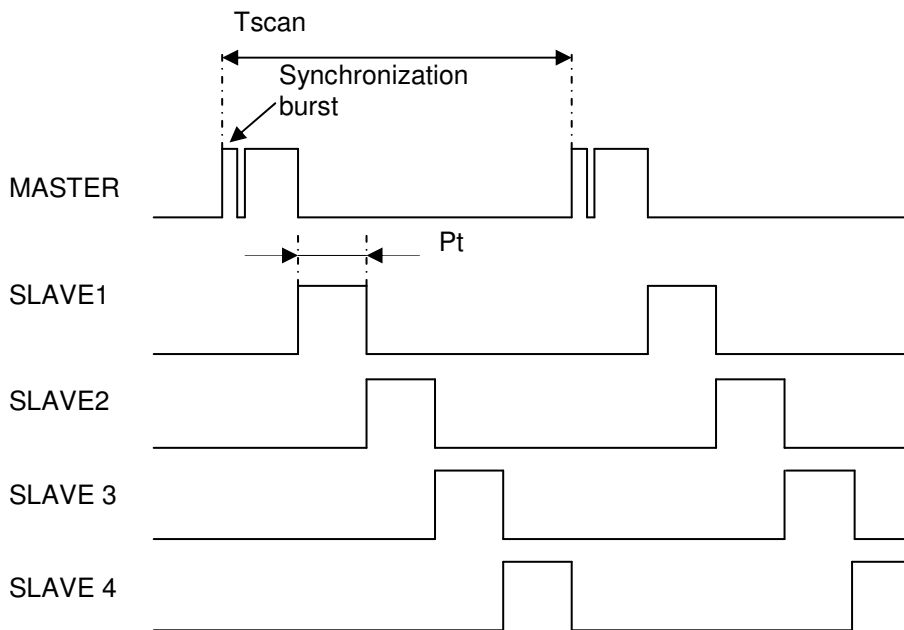

- Synchronization burst: start burst to synchronize the gates (Period of  $T_{scan}$  ms)
- Processing time ( $P_t$ ): depends on the number of chip types to be detected. The faster is when only one chip type is selected (see Table 2: Scanning Duration).
- The  $T_{scan}$  period is optimized according to the number of slaves and number of chips to detect.

## 5.2.2 Special Synchronization Mode



Only used in ISO15693 (C370/C370-L/Tag-It) AFI mode with Read-Memory activated.

This mode has an identical Master/Slave configuration as described in the Standard Synchronization mode.

Synchronization process:

- 1- The master scans the configured chip, then send the synchronization burst to Slave1
- 2- Slave1 scan the configured chip, then send the synchronization burst to Slave2

- 3- Slave2 scan the configured chip, and then send the synchronization burst back to the master.

This process is repeated in an infinite loop mode.

In case of the master does not receive back the synchronization burst from the last slave after a defined period, it will automatically restart the synchronization process.



In this particular mode we recommend to install a maximum of 3 pedestals in order to avoid deteriorating the Tscan duration described in section 5.1 "Chip Configuration".

### 5.2.3 Wireless Synchronization

The L-SP2 is provided with a wireless synchronization system, however slaves too far from the Master pedestal cannot be reached and the air synchronization signal is not transmitted to the slaves pedestal, in this case synchronization by wire is mandatory.



In Standard Synchronization mode, section 5.2.1, if more than 5 pedestals are to be installed or distance between pedestals exceeds the recommendation of section 4.3.2 "Placement of Pedestals", wire synchronization is mandatory.

When more than two pedestals are installed, it is recommended to install the Master in the middle of the slave's line for a better propagation and detection of the air synchronization burst.

Figure 12 below shows an example of optimal configuration.

**Figure 12: Configuration sample**

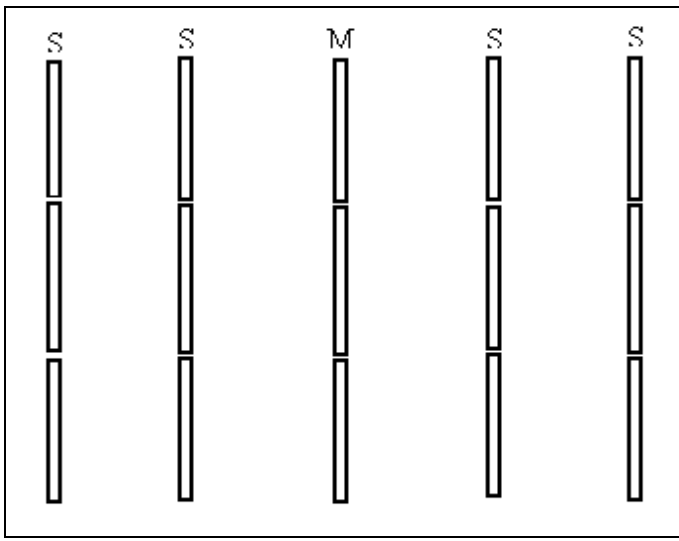

## 5.2.4 Synchronization by Wire

In this case the L-SP2 configuration settings are not to be changed. There will always be one L-SP2 Master and others pedestals set as Slaves. Each pedestal is connected to the other using a twisted pair cable.

### Wire connection:

1. Unscrew the 4 screws to open the plastic panel
2. Unscrew the 9 screws to open the metallic cover

**Figure 13: I/O port support**



I/O port support

3. Use a thin sharp screwdriver to insert the wire terminal inside the I/O port 4 hole (please see below [Figure 14](#)).

**Figure 14: Wire disposition**

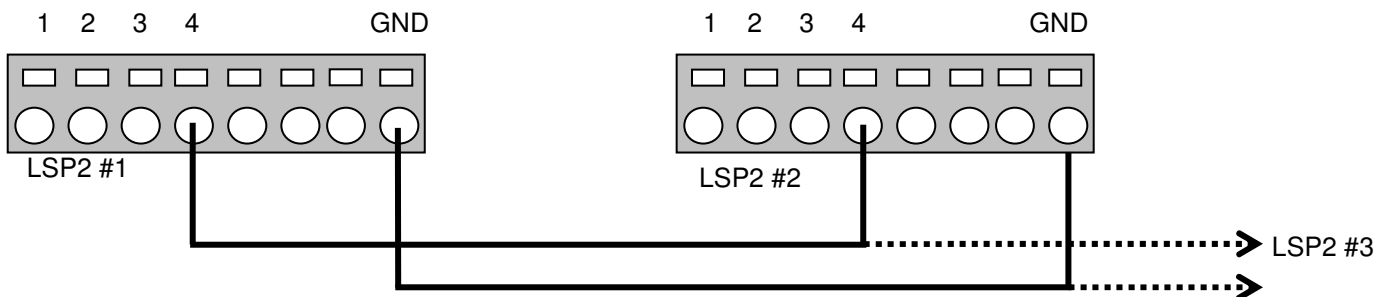

4. Repeat this sequence for each L-SP2 pedestal to connect each I/O port 4 together
5. Power up the whole system (every pedestals must be powered up) and check that the synchronization process works properly
6. Replace the panels

## 5.3 Configuration of the Ethernet Interface



Don't forget to power up your installation before carrying on the following steps

For the Ethernet version, the first step is to allocate a unique IP address to each L-SP2. This operation will allow identifying each L-SP2 on site before configuring them on the Ethernet network.



By default the IP address is 169.254.0.100 (port 4001) (IPv4 Automatic Private IP Addressing). Ask your network administrator to obtain a static IP address for each of the pedestals connected to your local network.

Setting of L-SP2 IP addresses can be done in console mode using the HyperTerminal software via the RS232 link on DB9 connector as shown in [Figure 15](#).

Communication parameters are the followings:

- Baud rate: 19200
- Data bits: 8
- Parity: none
- Stop bit: 1

**Figure 15: Configuration Connector**

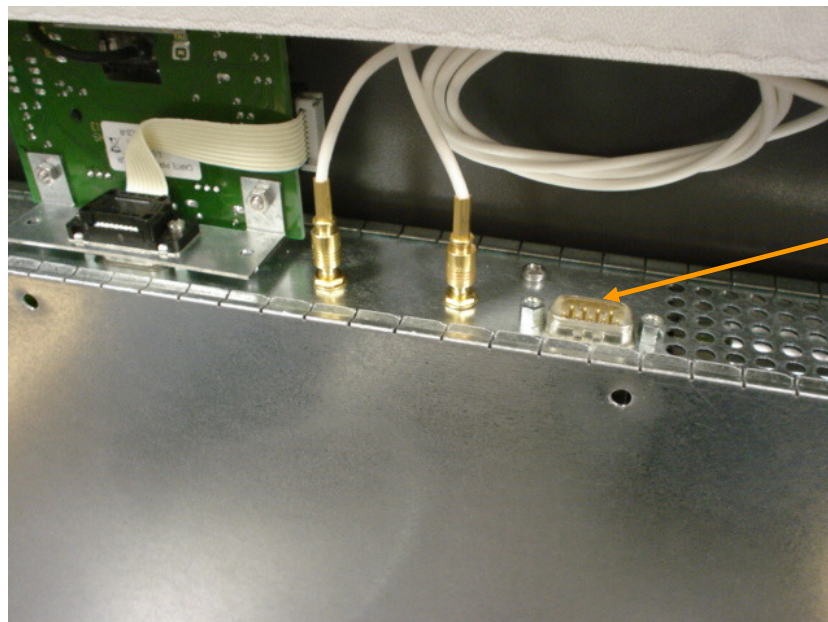

1. Once the communication parameters have been set, type any key to switch from Data mode to Console mode.
2. Type 2 to select “Network settings” and then press Enter.
3. Type 1 to select “IP address” and then press Enter.
4. Use Backspace key to erase the current IP address, type the new IP address then press Enter.
5. Return to Main menu, and select “Save/Restart” to memorise the configuration.

For more information regarding the IP addresses setting please see **Moxa NE-4100 Series User’s Manual** available on <http://www.moxa.com>.

Once all the IP addresses have been allocated, the L-SP2 plastic covers can be replaced.

The L-SP2 configuration will be carried on using a host computer connected to the local Ethernet network.



You can localize the each gate thanks to their IP address. Their on site location must be known to configure and set them as Slaves or Master.

---

## 5.4 Configuration of the L-SP2

“L-SP2 Configuration” is the software tool used to communicate and configure the L-SP2 pedestal. This software handles communication either using the serial port or Ethernet port.



Before you configure the whole L-SP2, you need to have a clear vision of which systems will be the Masters or the Slaves. (Refer to section 5.2 “Understanding the L-SP2 Synchronization Process”)

---



**CAUTION:** In a configuration case with several pedestals, as pedestal is default Master configured, they will mutually perturb when powered on. So the first step will be to set the Slaves pedestals chosen as Slave.

---

Depending on the L-SP2 version, the configuration of the whole L-SP2 installed on site is carried on according to the following methods:

- If the Ethernet version is selected on site; the whole L-SP2 configuration can be carried on from a host computer connected to the local area network. Each L-SP2 is addressed thanks to its own IP.



When the Ethernet version is installed, the L-SP2 configuration can only be carried on via the Ethernet connection. The DB9 configuration connector as show [Figure 15](#) is only used to set the Ethernet interface and cannot be used to configure the L-SP2.

---

- If the standard version is selected on site; the whole L-SP2 configuration will be carried on after connecting each pedestal with the RS232 interface as shown in [Figure 15](#), the Master/Slave statute depending on neighboring systems.

### 5.4.1 Installing the Configuration Software

The L-SP2 Configuration Utility is on the CD-Rom provided with the L-SP2.

Launching the Installer from the CD-Rom will display the following window:

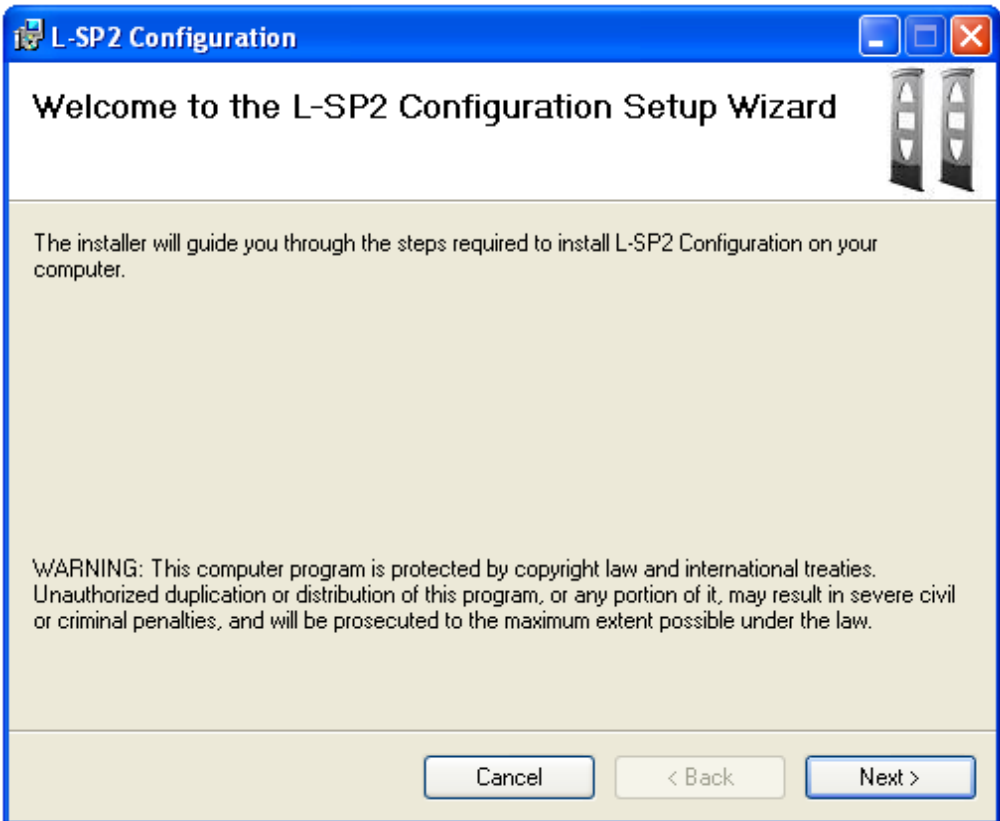

Follow the installer steps:

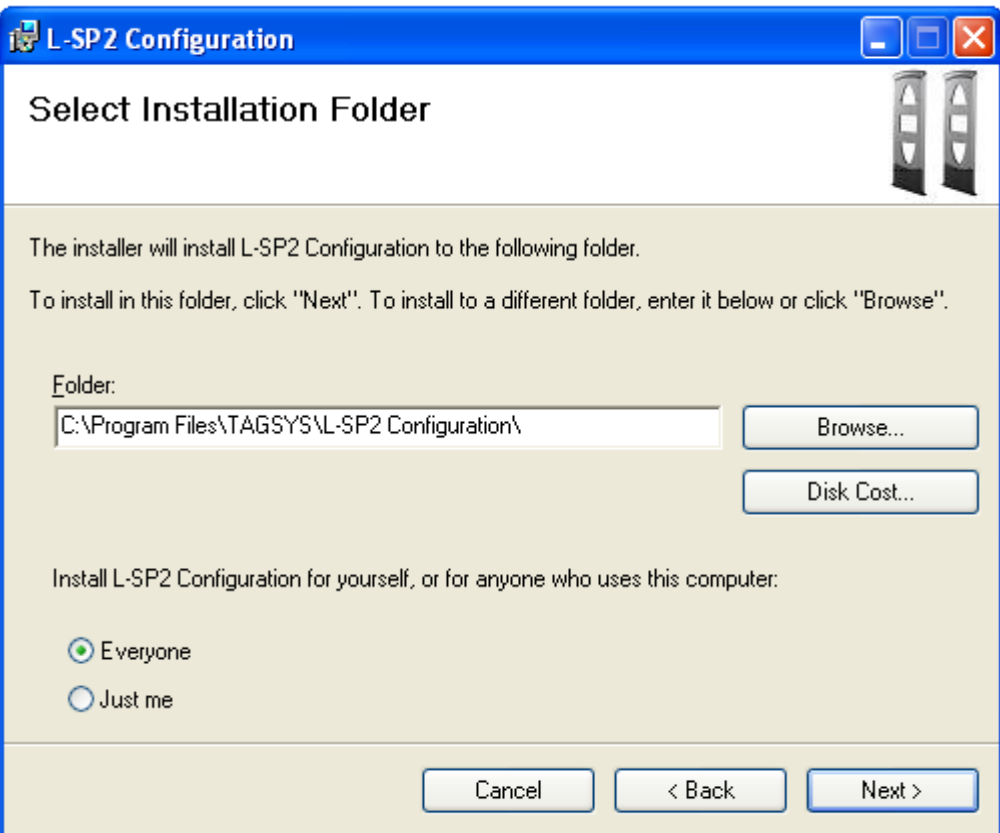



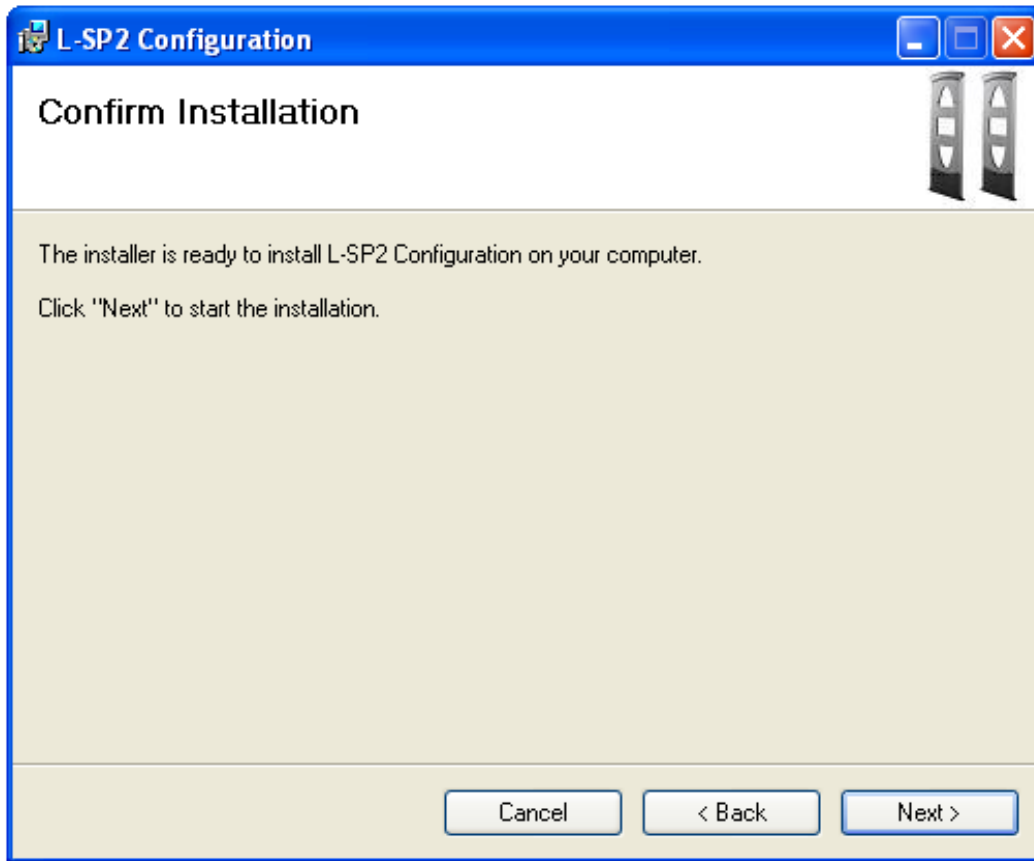

After the L-SP2 Configuration Software is installed, a shortcut to the application will be added to the desktop and to the Start Menu.

**5.4.2 Basic Configuration**

Double-click on the application shortcut to start the application.  
By default, the application searches for a serial L-SP2 connected to the COM Port 1.  
If no L-SP2 is detected on this COM Port, the following window is displayed:

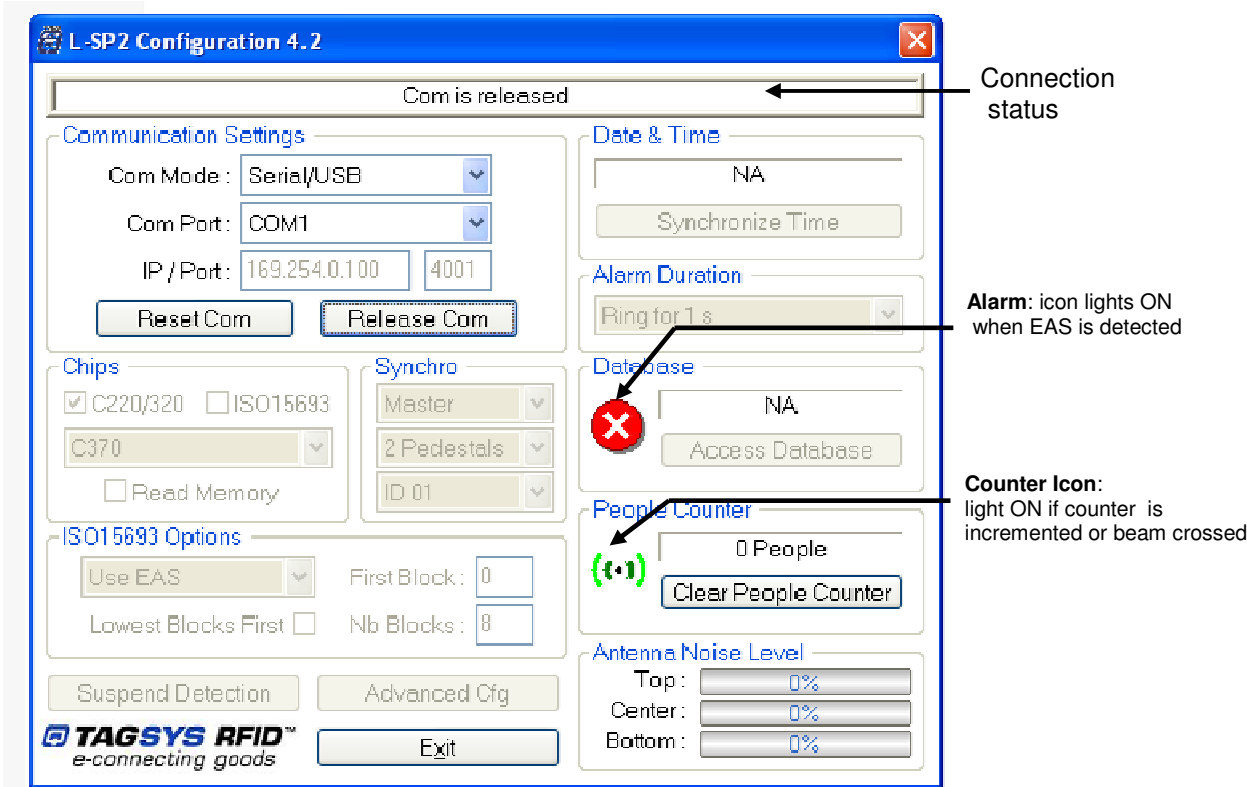
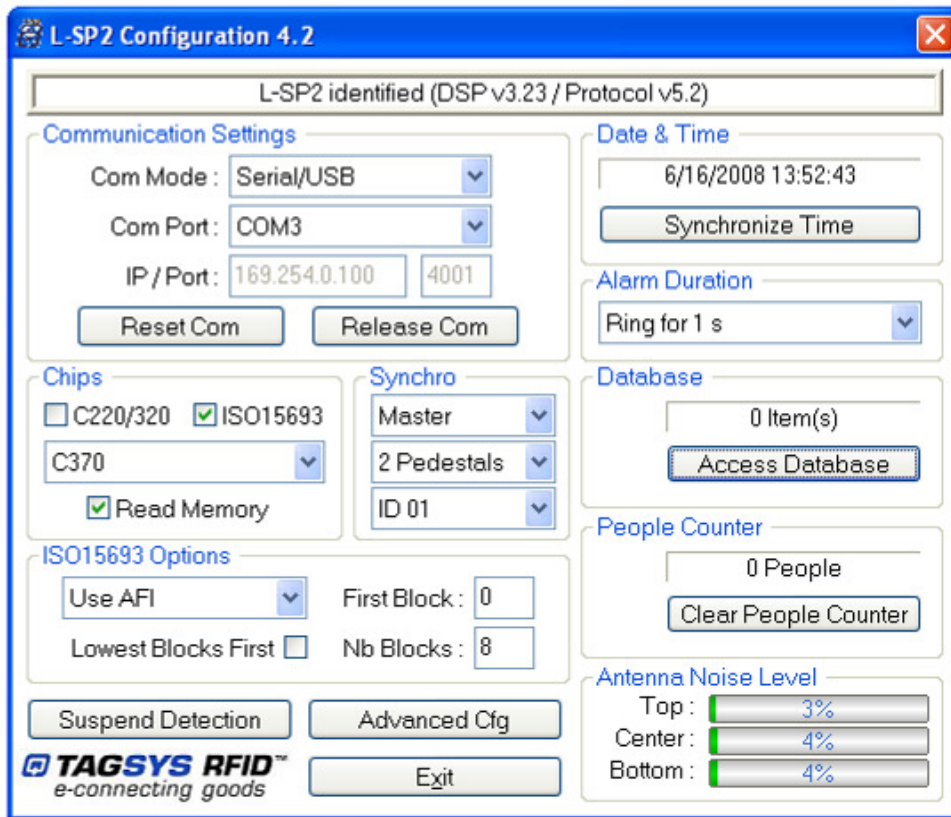

**Figure 16: Main Configuration Window, not connected to the L-SP2**

Select the COM Mode for your L-SP2 between Serial and Ethernet.

- If Serial then select the Com Port (1 to 8 available)
- If Ethernet then enter its address and TCP port

Click “Reset Com” to establish communication to the L-SP2. If settings are correct the following window is displayed:



**Figure 17: Main Configuration Window, connected to the L-SP2**



Once the communication is set and the system identified, the software displays the current configuration recorded in the L-SP2.

### **Reset Com**

Reset the communication to the pedestal regarding Com Mode, Com Port and IP/Port settings.

### **Release Com**

Release the communication to the pedestal. (Get back to Figure 16 )

### **Chips**

Select the chips to be detected

### **Read Memory**

When selected, the L-SP2 will try to read memory of items passing through the gate. 1 block = 32 bits, maximum 8 blocks.

### **Use AFI / Use EAS (ISO15693 only)**

Selected which mode you want to use to detect an ISO15693 item.

### **First Block (ISO15693 only)**

First memory block to be read (in the range from 0 to 7).

### **Nb Blocks (ISO15693 only)**

Number of blocks to be read (in the range from 1 to 8).

**Lowest Block First (ISO15693 only)**

Activate this option if you want the lowest memory block to be presented first in the database

**Synchro**

- Select whether the pedestal is to be configured as the **Master** or as the **Slave** (1, to ...8)
- Pedestal Number: set the total number of pedestals (master + slaves) in close proximity and sharing the same ID.
- Select **ID** (same ID for Master and slaves for one system installation)



Only one Master can be selected with several slaves.

This parameter is the identifier of the Master and when a pedestal is configured as a Slave it is the Master's ID that the slave will answer to. For a Master/Slave system it is mandatory that all the pedestals use the same ID.

In the library configuration example below we have:

- system A with ID = 1 (M1 Master, S1, S2, S3 Slaves)
- system B with ID = 2 (M2 Master, S1, S2 Slaves)

The Masters are disposed as far as possible from each other not to perturb themselves. (Please refer to section 4.3.2 "Placement of Pedestals").

Two different IDs to be sure that each slave will be synchronized with the master from its own system.

**Figure 18: Multi-gate Configuration with 2 different Ids**

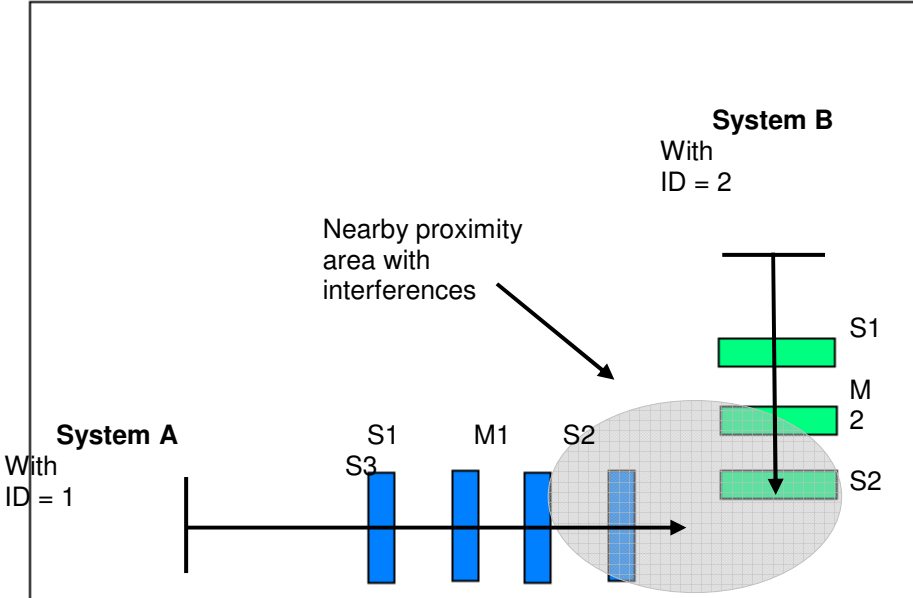

**Alarm**

Select alarm time (using a time step of 0.5 s. From 0.5 to 5 s)

**Resume Detection**

Click the button to stop EAS/AFI detection. Another click resumes EAS/AFI detection.

Once you have set the basic configuration check that all the slaves are well synchronized. To do so, L-SP2 electronics unit green LEDs should flicker cyclically. If not, proceed to the advanced configuration stage.

**Database**

Each time an item (with EAS/AFI activated) passes through the gates an entry is added to a local database in L-SP2 memory. This entry holds the following information:

- The date and time to which the theft was committed.
- The chip type (C220/C320, C370, C370-L, ISO15693).
- If selected, the memory data.

The database section shows the number of entries stored in L-SP2 memory in real-time.

**Access Database**

To access the database, click “Access Database”: Database is downloaded and the following window is displayed:

**Figure 19: Database**

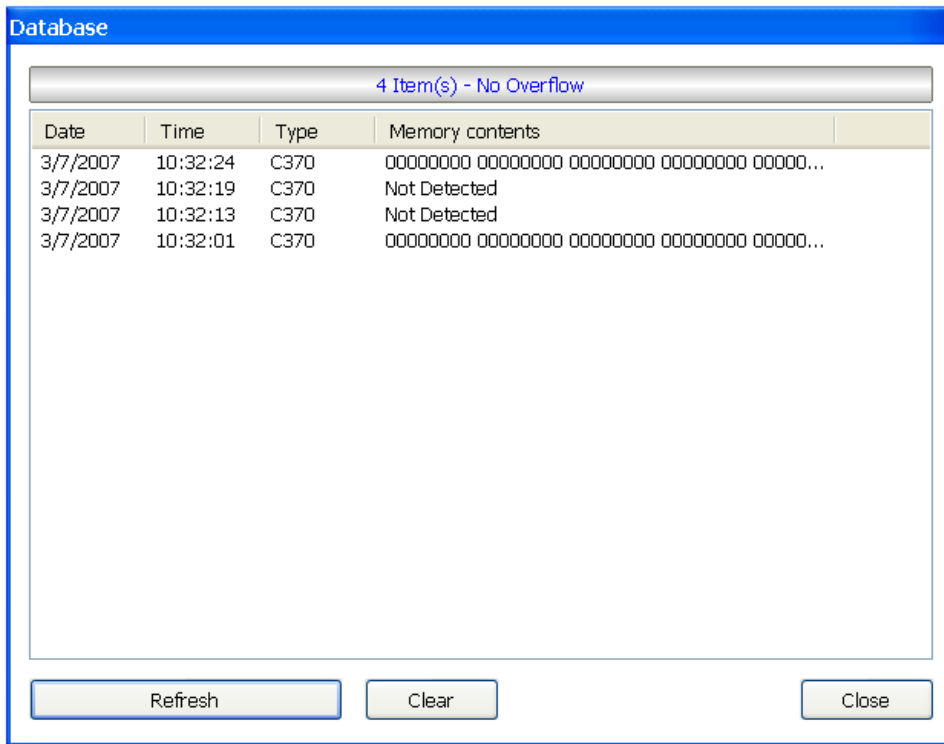

**CAUTION:** When this window is open EAS/AFI detection is automatically suspended. It is resumed when the window is closed.

Click:

- “Refresh” to re-download Database.
- “Clear” to ERASE L-SP2 Database.
- “Close” to close the window.

You can access the database from your own application using MedioSTX.dll and Java SDM. Please refer to the **Medio STX Windows DLL Programming Guide**.

**Date & Time**

The top of this section continuously displays date and time of the pedestal.  
Click “Synchronize Time” to synchronize the pedestal to the PC clock.



Be advised that **this time will be used as a date stamp** when a theft is committed.

**Antenna Noise Level**

These bar graphs provide a feedback regarding the ambient noise level measured by each antenna. It is only provided as debug purpose and should no be seen as a measure of performance. Moreover, this information is only provided in conjunction with the ISO15693 chip and is not supported if only the C220/C320 is activated.

**5.4.3 Advanced Configuration**

Press Advanced Cfg (Configuration) button to set advanced parameters.  
The following window is displayed:

**Figure 20: Advanced Configuration window**

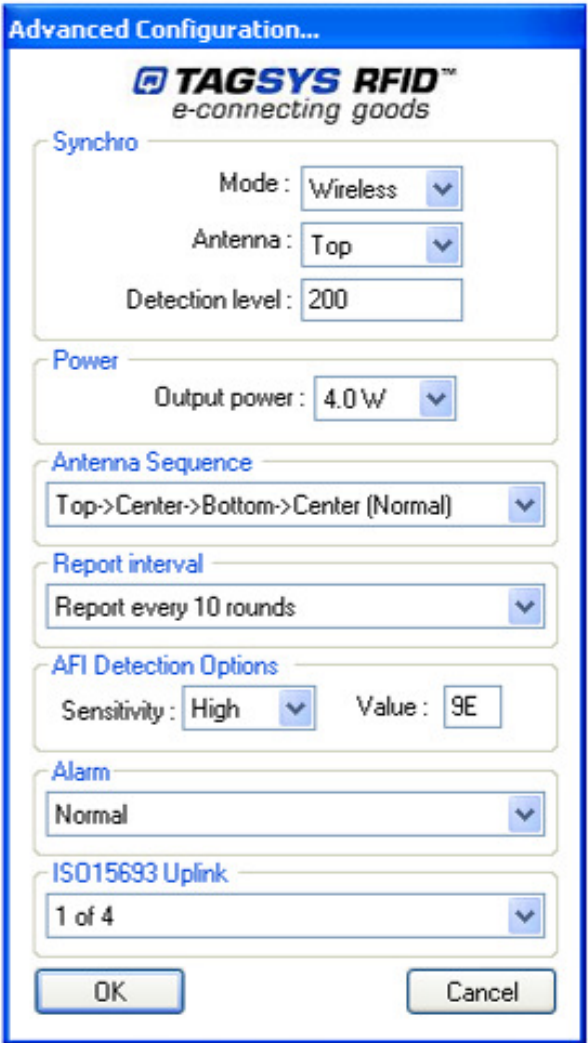

When using Hardwire synchronization, as described in 5.2.4, there is no parameter to be defined.

When using Wireless synchronization, as described in 5.2.3, you have to carefully setup each pedestal to ensure a proper synchronization.

**Synchronization parameters in wireless mode**

These parameter sets are defined as follow:

- If set as master, the antenna is transmitting the synchronization burst
- If set as slave, the antenna is receiving the synchronization burst
- The detection level for receiving the synchronization burst.

According to the number of gates installed in close proximity the following rules will apply:

- If the slave pedestal is directly facing the master then the slave antenna receiving the synchronization pattern must not face the master-transmitting antenna.
- If the slave pedestal is not directly facing the master then the slave antenna receiving the synchronization pattern must face the master-transmitting antenna.

**Figure 21: Master/Slave synchronization antenna configuration**

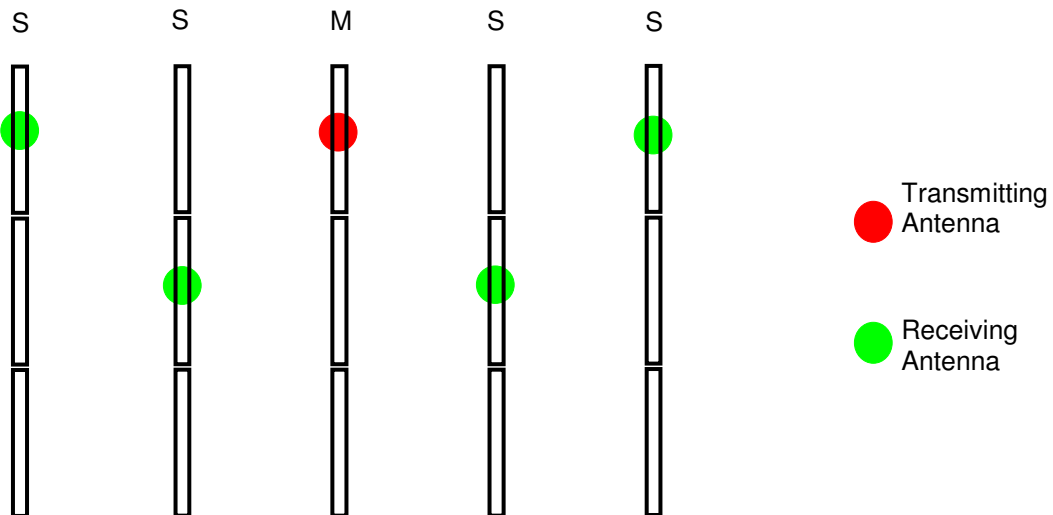

**Detection level**

If previous recommendations do not ensure the synchronization of all slaves then it is possible to adjust the sensitivity of the non-synchronized slaves. You just have to adjust the detection level until you get the required synchronization (LEDs flicking cyclically). Range detection level can be configured between 50 up to 2000. Increasing the detection level value will reduce the sensitivity to environmental noise.

**Power**

This parameter allows adjusting the power level of each pedestal. However you should not exceed 4W in order to comply with FCC and CE standard certification. It is possible to increase the power but only to carry on tests.



**CAUTION:** In any case, for operational configuration this value should not exceed 4W to be in compliant with FCC and CE rules.

The power can be lowered to avoid disturbing nearby RFID system (in such case check system performance)

---



**CAUTION:** The L-SP2 pedestal has been tested to be compliant with FCC and CE rules (with P = 4 W)

---

### **Antenna Sequence**

It allows choosing antenna used by the EAS detector

Select (Top>Center>Bottom> Center) for standard operation or specifically an antenna for diagnosis operations (Top, Center or Bottom)

### **Report Interval**

If the same item passes through the gate several times, it will be reported only once every n rounds (n is the number selected from the report interval section). A round duration corresponds to Tscan, see 5.1, "[Chip Configuration](#)".

### **AFI detection sensitivity**

Turn it down in case too many false trigger occurs

### **AFI value**

1 byte, enter the value in hexadecimal that matches your tag's AFI

### **Alarm**

- Normal: pedestal will report any detected item whether or not the memory is successfully read
- Alarm on successful memory reading (Diagnosis): pedestal will only report detected items with memory successfully read.

### **ISO15693 Uplink**

Select Data coding mode: 1 out of 4 (26,48kbit/s), or 1 out of 256 (1,65kbits/s)

This parameter allows adjusting the transmitted data rate of each pedestal. However you should not exceed 1.65kbits/s in order to comply with FCC standard certification. It is possible to increase the transmitted data rate but only to carry on tests.



### Alarm Buzzer Volume Adjustment

The alarm buzzer is located at the top of the pedestal.

To access to the buzzer potentiometer, unscrew the two screws on each side and remove the top cover as shown in the following figures.

**Figure 22: Front View**

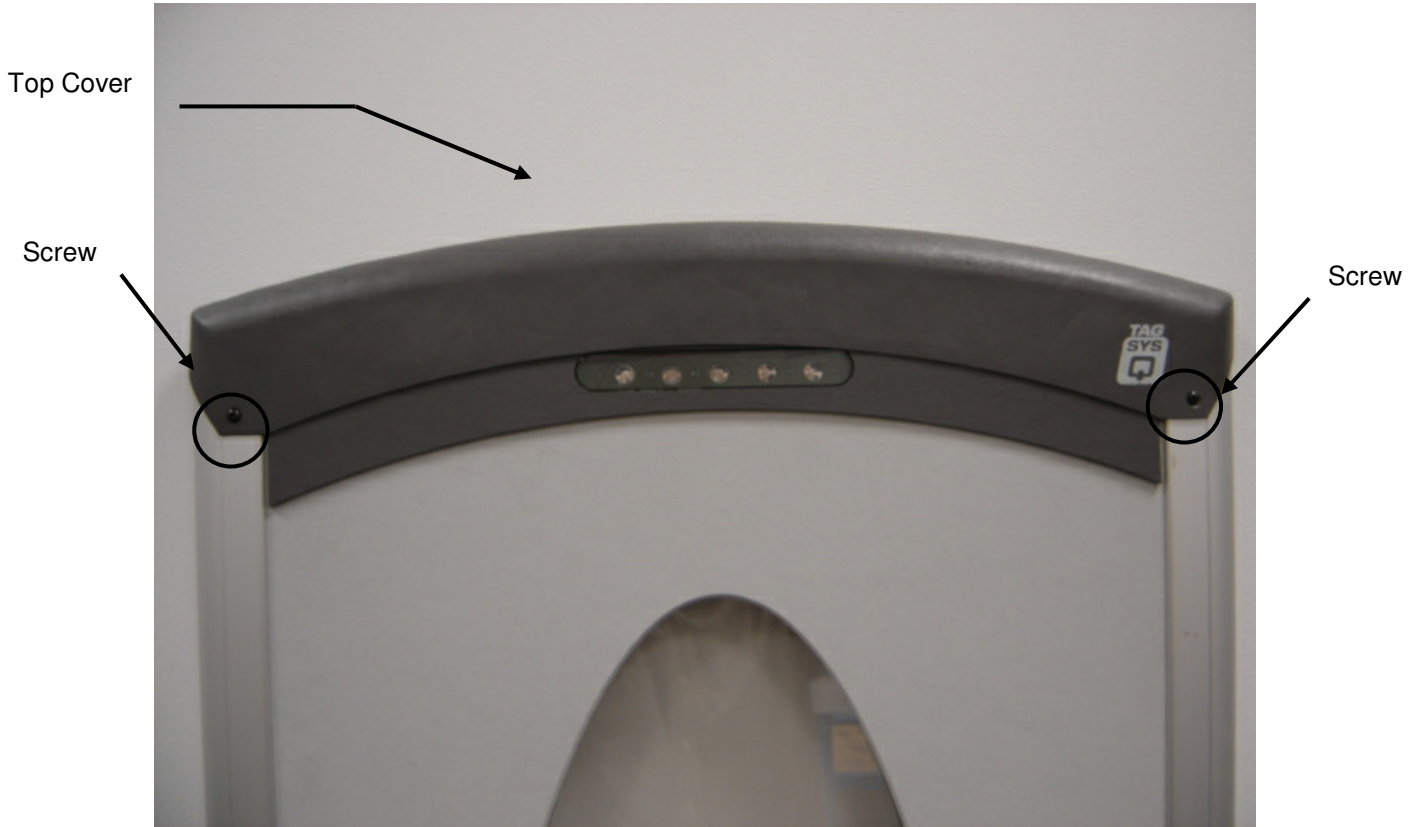

**Figure 23: Alarm Potentiometer**

Turn it clock wise  
to decrease  
volume

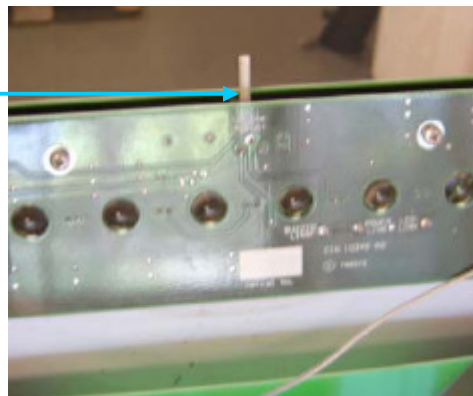

## 5.5 People Counter Management

The people counter information reported using the Ethernet connection is battery backed-up. It is not the case for the LCD display. If powered off, the information displayed on the LCD display will be reset to zero.

### 5.5.1 Resetting the Local People Counter

To reset the LCD display use a pointed element (for example: a paper clip). Insert it in the hole under the display window and press (not too strong) until you get zero displayed. This will not reset the battery backed-up counter.

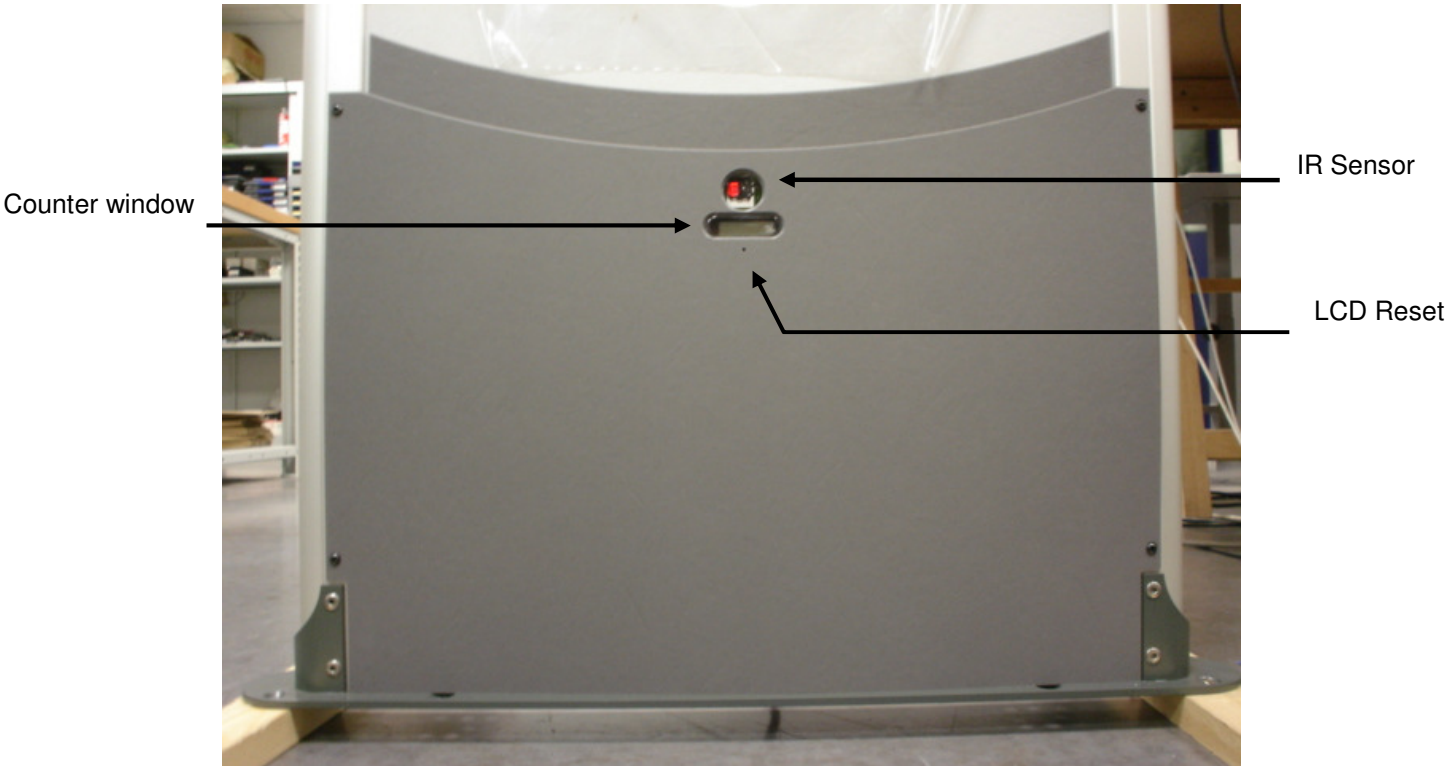

Figure 24: People Counter and Sensor

### 5.5.2 Resetting the Remote People Counter

Connect to the L-SP2 using “L-SP2 Configuration” and click “Reset people counter”. This will only reset the battery backed-up counter, not the LCD display.

# 6 Antenna Tuning

The successful operation of the L-SP2 depends largely on:

- The antenna being tuned to the correct resonance frequency (impedance),
- Antenna isolation being adjusted to its optimal value.

During on-site tuning, antennas are decoupled to ensure that the minimum amount of energy is delivered from one antenna to another.

Note that antennas are tuned before shipping and should not require any further adjustments on site.



It is recommended that an approved TAGSYS technical representative inspect the pedestal unit at least once per year.

After the L-SP2 is completely installed, verify the antenna tuning of each pedestal to ensure that the tuning process is necessary.



The antennas should be tuned only if necessary. To determine if the tuning procedure is required, follow the steps listed in section 6.2 “Verifying Antenna Performances”.

The tuning of the antennas should be verified whenever a pedestal is installed or moved.

The tuning procedure requires some knowledge of the use of equipment such as an oscilloscope, and should therefore be carried out by a suitably qualified technician.

## 6.1 Required Materials

### 6.1.1 TAGSYS Antenna Tuning Kit (not included)

**Table 3: Contents of Antenna Tuning Kit**

Quantity	Description
1	Antenna Tuning Device generating a 0.5 Watt, 13.56 MHz sine wave waveform
2	25-cm RG58 shielded cable with BNC connectors
1	Universal power supply 100-240 VAC to 12DC with European Pins
2	Card-size Field Strength Detector
1	Precision screwdriver to calibrate the Tuning Device
1	BNC 50-Ohm Termination
1	BNC Gender Changer
2	BNC to SMB type changer for EAS Pedestal
1	Antenna Tuning Device User's Guide

### 6.1.2 Oscilloscope

An oscilloscope (not supplied with the TAGSYS Antenna Tuning Kit) is necessary. It should meet the following minimum requirements:

- 100 MHz analog bandwidth (-3 dB)
- 5mV/division vertical resolution
- 10ns/div horizontal time base resolution

The measurements are taken on the sine wave and repetitive carrier signal, so when using a digital scope, the sampling rate should be at least twice the maximum analog bandwidth.

### 6.1.3 Probes

At least one standard probe (not supplied with the TAGSYS Antenna Tuning Kit) will be required for measuring a trigger signal for the normal tests. Three probes may be required for the extended troubleshooting section.

## 6.2 Verifying Antenna Performances

The first step before starting the antenna tuning procedure is to verify the performance of the pedestal antennas in order to ensure that the antennas need tuning.

Antenna performances are verified by ensuring that the L-SP2 EAS pedestals are capable of detecting a TAGSYS RFID tag with an active EAS anti-theft bit.

1. Ensure that the L-SP2 is correctly installed and switched on.
2. Holding the TAGSYS RFID tag test card in your hand slowly move it from the top to the bottom of the pedestal (which should take approximately ten seconds) with the TAGSYS RFID tag approximately 450 mm (1,5 feet) from the pedestal. Verify that the LED/buzzer board signals the detection of the TAGSYS RFID tag at the top and bottom of each antenna (four positions, as two of them overlap).
3. Holding the TAGSYS RFID tag test card so that the TAGSYS RFID tag is horizontal (one of the less optimum orientations), slowly move it from the top to the bottom of the pedestal with the TAGSYS RFID tag approximately 450 mm (1,5 feet) from the pedestal. Verify that the LED/buzzer board signals the detection of the TAGSYS RFID tag at the top and bottom of each antenna (four positions, as two of them overlap).

If the L-SP2 pedestals detect the TAGSYS RFID tag at Steps 2 and 3, no tuning is required.

If results are questionable, antenna tuning and insulation must be checked.

## 6.3 Adjusting the Antenna Impedance

The impedance of the antennas can be tuned using the TAGSYS Antenna Tuning Kit or an Impedance Analyzer. Before starting the Antenna Tuning Procedure, make sure that the antennas require tuning (see section 6.2 "Verifying Antenna Performances"). If the antennas do not require tuning, do not tune the antennas.

### 6.3.1 Using the Antenna Tuning Kit

To access to the antennas remove the top cover of the L-SP2 pedestals (See section 4.3.3 "Installing the Pedestal") and slide out the side panels from the L-SP2 pedestals chassis then set up the components and connections as shown in Figure 25 and Figure 26.

**Figure 25: Antenna Tuning (Impedance)**

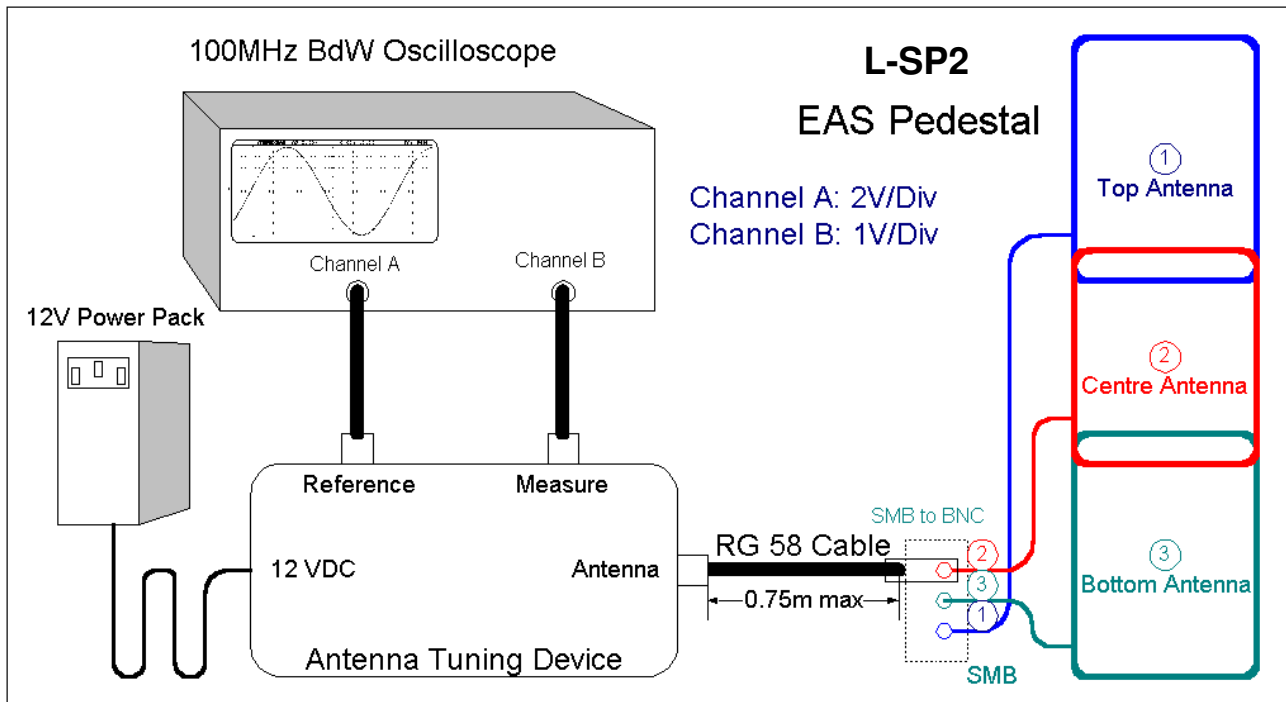

**Figure 26: Antenna Connection**

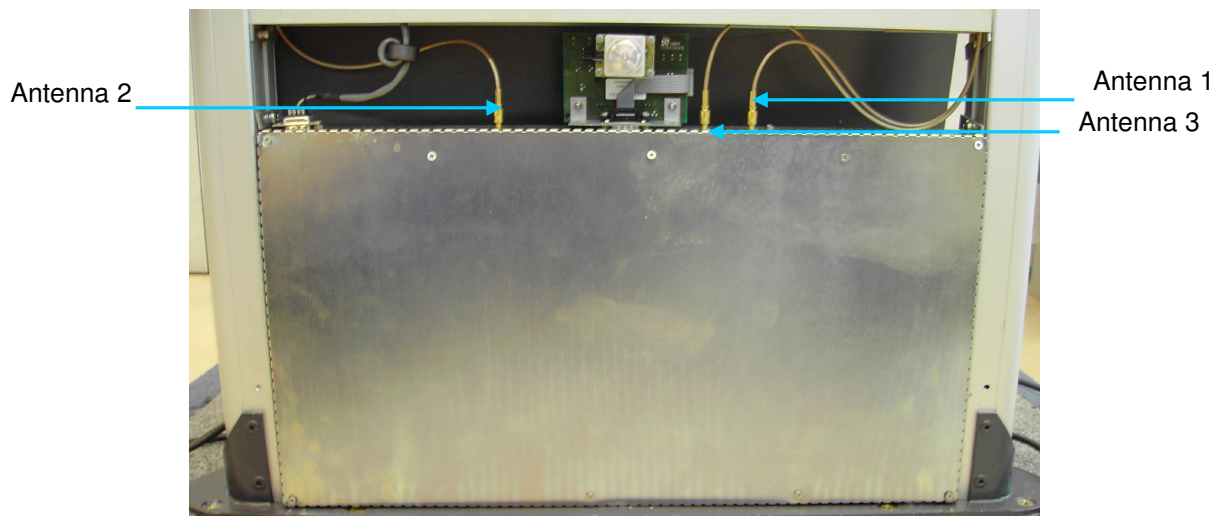

**Table 4: Oscilloscope Settings**

Parameter	Value
“Measure” Channel Sensitivity	1 V/Div.
“Reference” Channel Sensitivity	2 V/Div.
Time Base	20 ns/Div.

The antennas should be tuned in the following order: top, center and then bottom.

For the best impedance, adjust the trimmer capacitors (Figure 27) until the two curves on the oscilloscope are exactly superimposed. For optimal performances, the two trimmer capacitors should be set to approximately the same angle. Please see Figure 28 .

**Figure 27: Trimmer Capacitor**

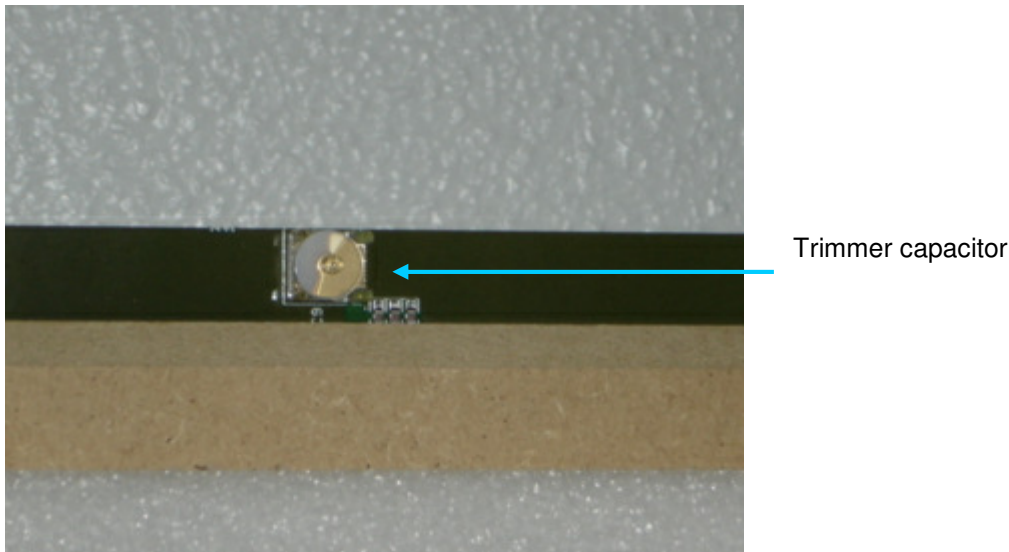

**Figure 28: Adjusting Trimmer Capacitors**

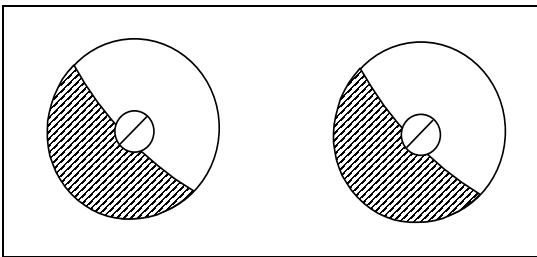

The individual impedance for each antenna should be tuned to be as close as possible to:

$$Z_0 = 50 \pm 5 + 0j \pm 5 \Omega \text{ at } 13.560 \text{ MHz}$$

**Figure 29: Impedance Values using the Tuning Kit**

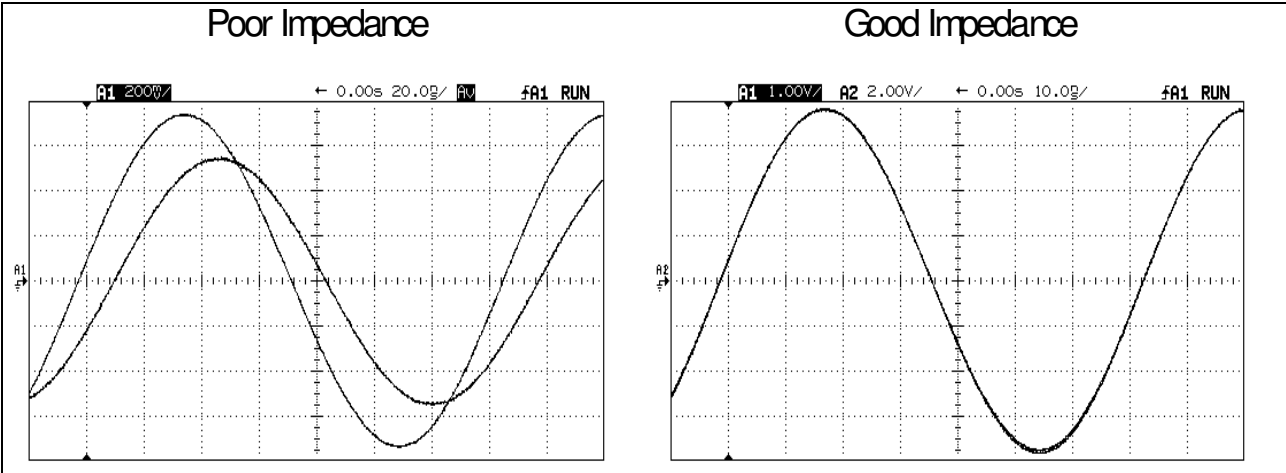

Continue the tuning process by checking the antenna isolation (see section 6.4 “Adjusting the antenna Isolation”).

### 6.3.2 Using an Impedance Analyzer

If an impedance analyzer is available, connect each antenna in turn directly to the impedance analyzer and tune the antennas in the following order: top, center and then bottom.

**Figure 30: Antenna Tuning (Impedance) using an Impedance Analyzer**

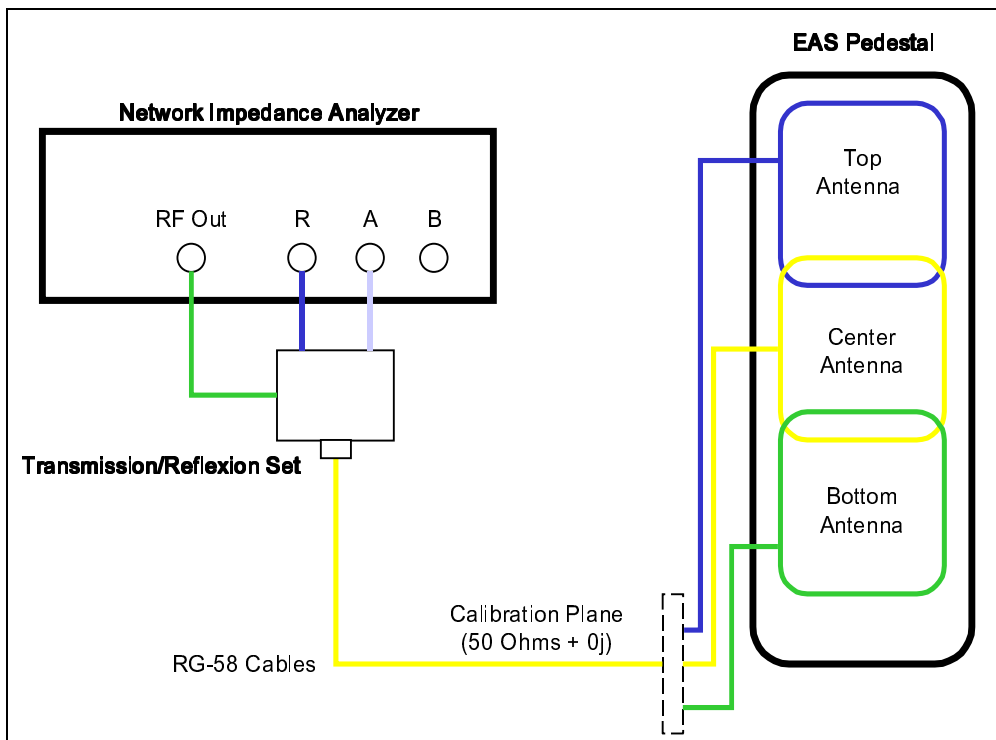

Adjust the trimmer capacitor (Figure 28) of each antenna for best impedance until the impedance reaches  $50 \pm 5 + 0j \pm 5 \Omega$  at 13.560 MHz.

Continue the tuning process by checking the antenna isolation (see section 10.4 “Adjusting the Antenna Isolation”).

**Figure 31: Impedance Values using an Impedance Analyzer**

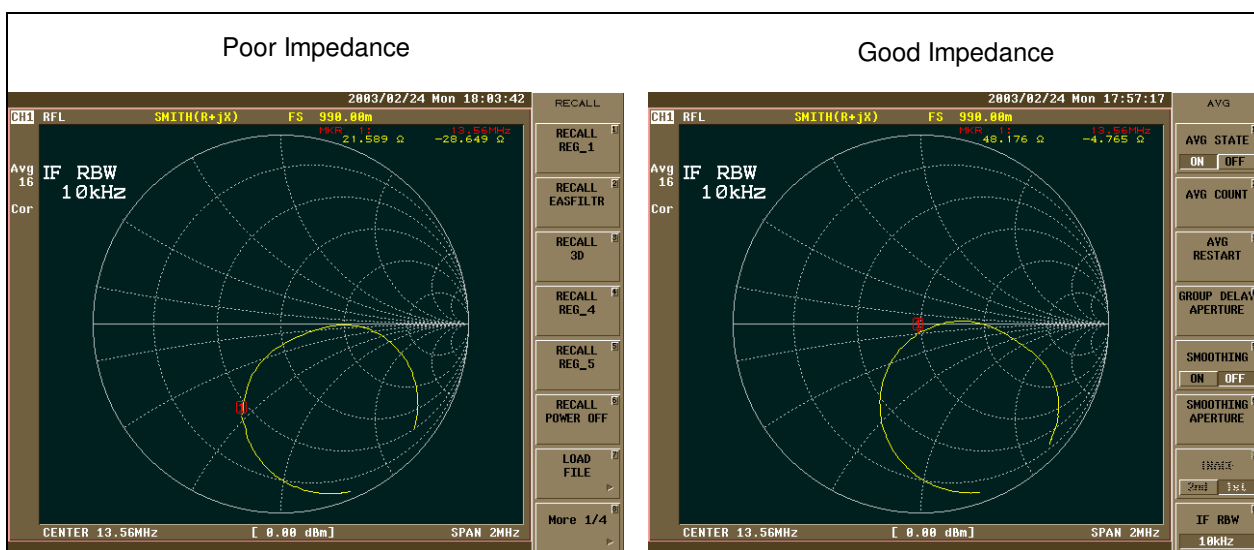

### 6.4 Adjusting the Antenna Isolation

Once each antenna is tuned for optimal impedance (see section 6.3 “Adjusting the Antenna Impedance”), it is necessary to verify the isolation of each antenna.

Correct antenna isolation is not greater than -19-20 dB or 600-mVpp residual peak-to-peak voltages collected on either the top or bottom antenna when the center antenna is powered by the tuning kit sine wave carrier generator. Poor isolation is approximately -10 dB or 2 Vpp residual peak-to-peak voltages.

Optimum isolation is obtained by sliding carefully the top or bottom antenna towards the fixed and center antenna. When a minimum value is reached, the antenna position can be secured using the 4 screws.

The voltage is measured using an oscilloscope of at least 100-MHz analog bandwidth, 10-ns time resolution and a 50-Ohm cable terminated at the oscilloscope input.

#### 6.4.1 Using the Antenna Tuning Kit

To access to the antennas remove the top cover of the L-SP2 pedestals (See section 4.3.3 “Installing the Pedestal”) and slide out the side panels from the L-SP2 pedestals chassis then set up the components and connections as shown in Figure 32.

**Table 5: Oscilloscope Settings**

Parameter	Value
Channel A	100 mV/Div.
Time Base	20 ns/Div.

**Figure 32: Antenna Tuning Isolation**

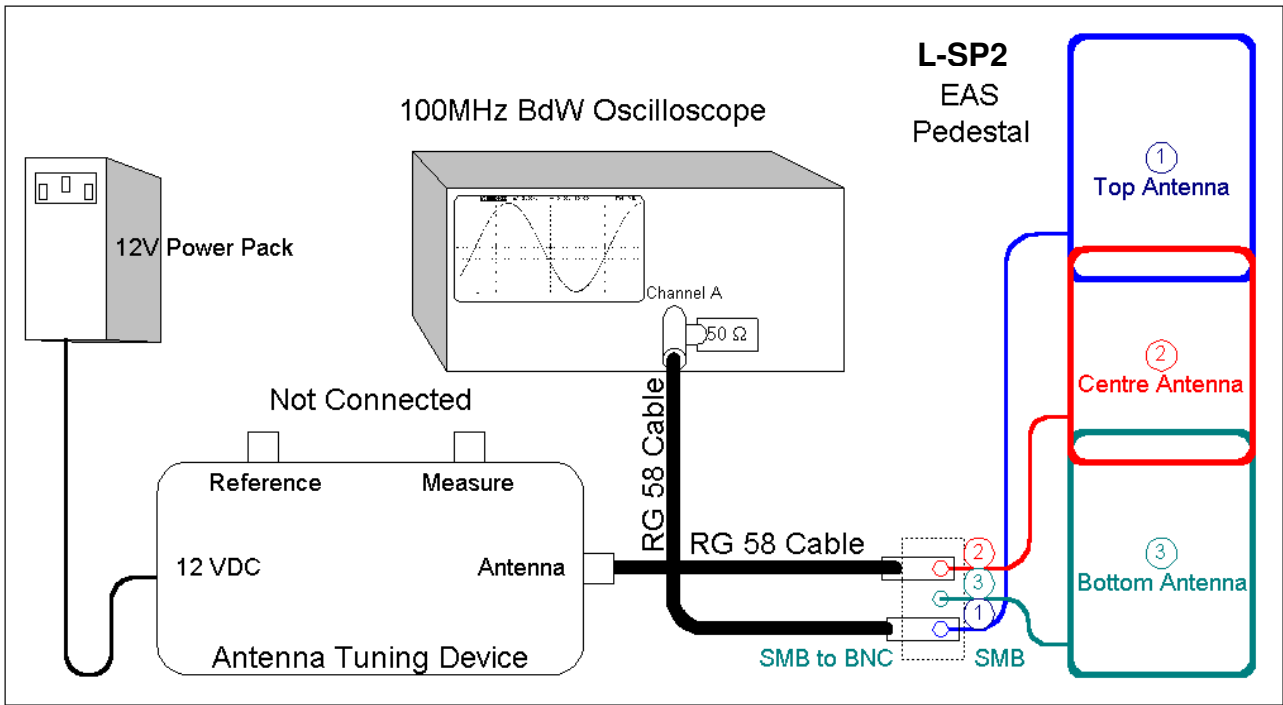



**Figure 33: Antenna Adjustment Screw**

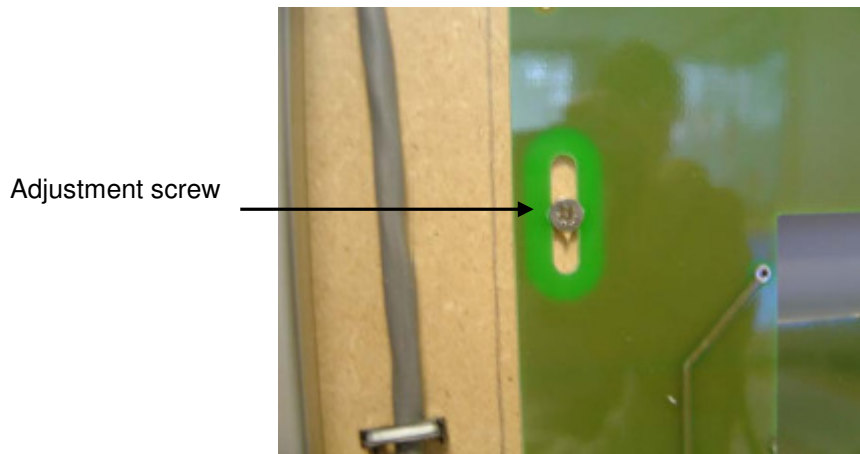

The center antenna always remains fixed in position and connected to the antenna-tuning device. The other two antennas should be slightly loosened so they can be moved with relative ease but do not move on their own (Figure 33)

The isolation should be checked as follows:

1. Adjust the position of the bottom antenna with respect to the center antenna.
2. Adjust the vertical position of the bottom antenna so that a minimum is seen on the oscilloscope.
3. Repeat with the top antenna.



The central antenna remains fixed in position and the top and bottom antennas are moved, one at a time, to adjust the isolation.

While the top antenna is connected to the oscilloscope the bottom antenna should remain connected to the antenna connection board, and visa versa.

**6.4.2 Using an Impedance Analyzer**

If an Impedance Analyzer is available, perform the same procedure as described for the Antenna Tuning Kit.

**Figure 34: Antenna Tuning (Isolation) with Impedance Analyzer**

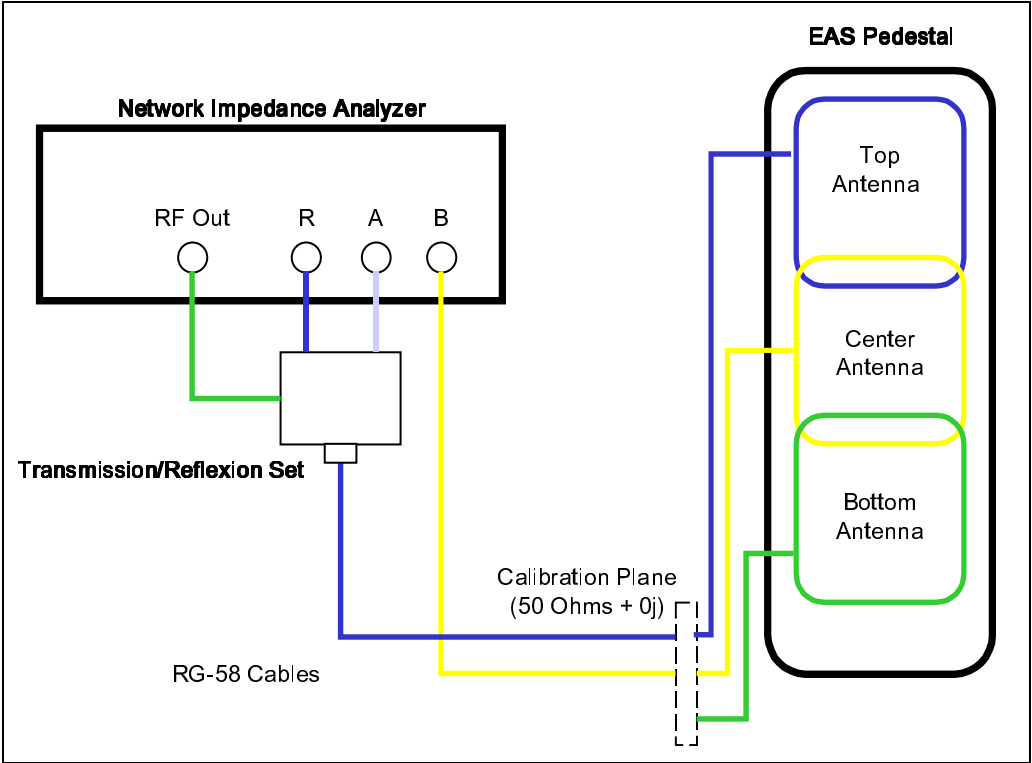

**Figure 35: Isolation Values using an Impedance Analyzer**

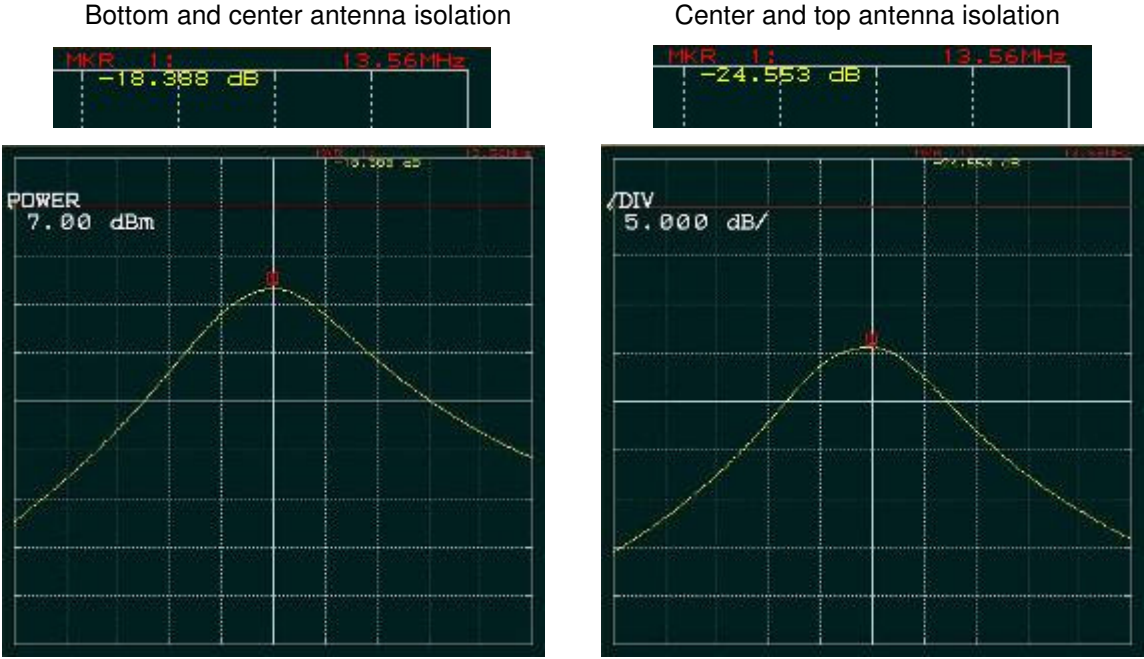

The effect of the metallic body on the isolation is worse with the bottom antenna

Note that the isolation adjustment process often requires repeating the procedure several times between the top and center antennas and between the center and bottom antennas. This means that it is normally more difficult to achieve good results of isolation between the center and bottom antennas. Therefore, it is important to check and minimize the isolation between the center and bottom antennas before moving to the top and center antennas. Typically, an isolation value equal to or less than 600 mVpp should be obtained between the center and bottom antennas and also between the top and center antennas.

Once the antennas have been correctly tuned for optimal impedance and isolation, it is best to verify their synchronization with the mains power supply and the trigger threshold levels.

# 7 Operation

---

## 7.1 Theory of Operation

The RF motherboard in the electronics unit produces radio frequency (RF) electromagnetic signals that are transmitted via the antennas in each pedestal. Each antenna transmits for a short period, receives for a short period, and is inactive for the remainder of the time.

When a TAGSYS RFID tag enters the electromagnetic field between two pedestals, some of the RF energy (AC) is converted to DC energy and used to power the TAGSYS RFID tag's microchip. The remainder is used to carry the TAGSYS RFID tag's EAS signal code back to the electronics unit via the antennas.

## 7.2 Starting the System

There is no ON/OFF switch. The system operates when power is applied.

## 7.3 Normal Operation

No operating procedures are required. The system continues to operate as long as power is supplied.

## 7.4 Shutdown

Once the system is set up and running, we recommend that all pedestals remain turned on at all times.

# 8 Maintenance

## 8.1 Servicing the Pedestals

No regular servicing or maintenance is required, except for keeping the covers clean, and occasionally checking the integrity of the cover seals.

It is recommended that the pedestal unit be inspected at least once per year by an approved TAGSYS technical representative.

Refer to section 1.2 “Care and Maintenance” for general maintenance information.

## 8.2 Servicing the Electronics Unit

- Fuse characteristics:

- On AC mains: Schurter FST, 5X20mm, Time-Lag T, H, 250VAC, 500mA
- On DC supply: Schurter SPT, 5X20mm, Time-Lag T, H, 300VDC, 2A

-How to change them:

1. Fuses are inside the electronic housing located at the bottom of the L-SP2 pedestal.
2. Unscrew the 9 screws from the cover located opposed side of the counter.
3. Unscrew the head fuse and replace the fuse inside the system fuse (please see figure below)



**WARNING:** AC mains 110/220V. Be sure that there is no power supply current before carrying on the connection operation. To do so, the micro circuit-breaker must be opened. (Figure 3)

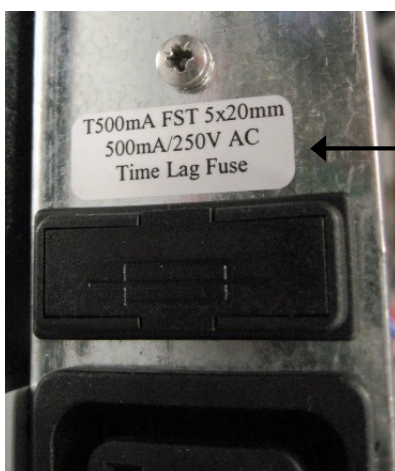

AC Main Fuse

DC Supply Fuse



## 8.3 Upgrading the DSP Firmware

DSP Firmware upgrade is carried on via the L200 Explorer software using either the RS232 cable or the Ethernet interface.

Please see **L200 Explorer user's guide** for more details about upgrade process.



**CAUTION:** While upgrading the DSP Firmware, the serial cable or the Ethernet interface **MUST NOT** be disconnected or the L-SP2 pedestal will not be functional anymore. In the case this would occur, the Firmware will **HAVE TO BE** programmed with the L200 Explorer software using the parallel port located in the electronic housing.

---

## 8.4 Spare Parts

A complete list of spare parts is available upon request.

# 9 Troubleshooting

The following table lists the most common problems and describes their solutions.

**Table 6: Troubleshooting Table**

Fault	Possible Causes	Solution
No power	Differential or micro circuit breakers	Check the differential and micro circuit breaker status
	System fuse	Replace fuse.
	Cabling fault. Power cable fault	Check cabling and connections. Replace any suspected faulty cables.
Alarms missed (TAGSYS RFID tags with theft bit ON not triggering alarms).	Tuning fault.	Check antenna tuning.
False alarms (TAGSYS RFID tags with theft bit OFF trigger alarms).	Tuning fault.	Check antenna tuning.
	Nearby devices are interfering with the pedestals. (Refer also to section 9.1)	Switch off all or some of the suspicious nearby devices and check if the EAS detection performance changes. (If it does, check for a power problem with the pedestal.)



**CAUTION:** These distances are subject to site variables. Distance may be smaller under some conditions. Metal frames on furniture and fixture items may interfere with the EAS system if they are too close. This is because energy from the antenna can couple into the metallic frame and be transmitted to TAGSYS RFID tags and antennas several meters away.

## 9.1 Sources of Interference

The following devices may cause interference with EAS systems if they are close to the pedestals:

- TAGSYS RFID tag readers and programming devices
- computer monitors or screens (cathode ray tubes)
- radio transmitters
- short-wave radios
- high power music systems with D-class amplifiers
- some industrial vacuum cleaners
- high-frequency fluorescent lights (if very close to pedestals)
- neon or halogen lights such as advertising signs
- equipment using switch mode power supplies
- data or power cables within 400 mm
- illuminated exit signs generating noise between 80 and 100 kHz
- digital phone lines (wideband noise) within 200 mm

# 10 Technical Specifications

## 10.1 Mechanical Data

Parameter	Value
Weight	Pedestal: 34 kg (75 lb)
Pedestal dimensions (H x W x D)	Approx. 1777 mm x 640 mm x 80 mm (70 x 25.2 x 3.15 in) assembled
Connection for pedestal	Supply power cable and Ethernet cable if available

## 10.2 Electrical Data

Parameter	Value
Power supply	100/240 Volts AC, 0.5 A, 50/60 Hz
Power consumption	30 W
Conformity	FCC Part 15, CE, EN 60950-1, EN 50364
Microchip compatibility	TAGSYS C220, C320, C370 (NXP SLI), C370-L (NXP SLI-L), Tag-it™HFI (Texas Instruments)
Operating temperature	0 to 50 °C (32 to 122 °F)
Storage temperature	-20 to 60 °C (-4 to 140 °F)
Fuse on AC mains	Schurter FST, 5X20mm, Time-Lag T, H, 250VAC, 500mA
Fuse on DC supply	Schurter SPT, 5X20mm, Time-Lag T, H, 300VDC, 2A

## 10.3 RF Output Power (50Ω Terminated)

Measurement values are instantaneous as the Power Burst is of very low duty cycle (0.015). Power on for approximately 400 μs every 60 ms at 50 Hz.

Parameter	P (W)	P (dBm)	V (V <sub>RMS</sub> )	V (V <sub>PP</sub> )
Minimum Burst Power	3.6	36.6	13.4	38
Maximum Burst Power	4	36.0	14.1	40.0

## 10.4 I/O port

The 4 I/O ports available are used as follows:

- 1: OUTPUT, used to trigger the alarm + LEDs
- 2: OUTPUT, used to reset the People counter
- 3: INPUT, used by the people counter to increment the patron count
- 4: INPUT/OUTPUT, used for the wired synchronization



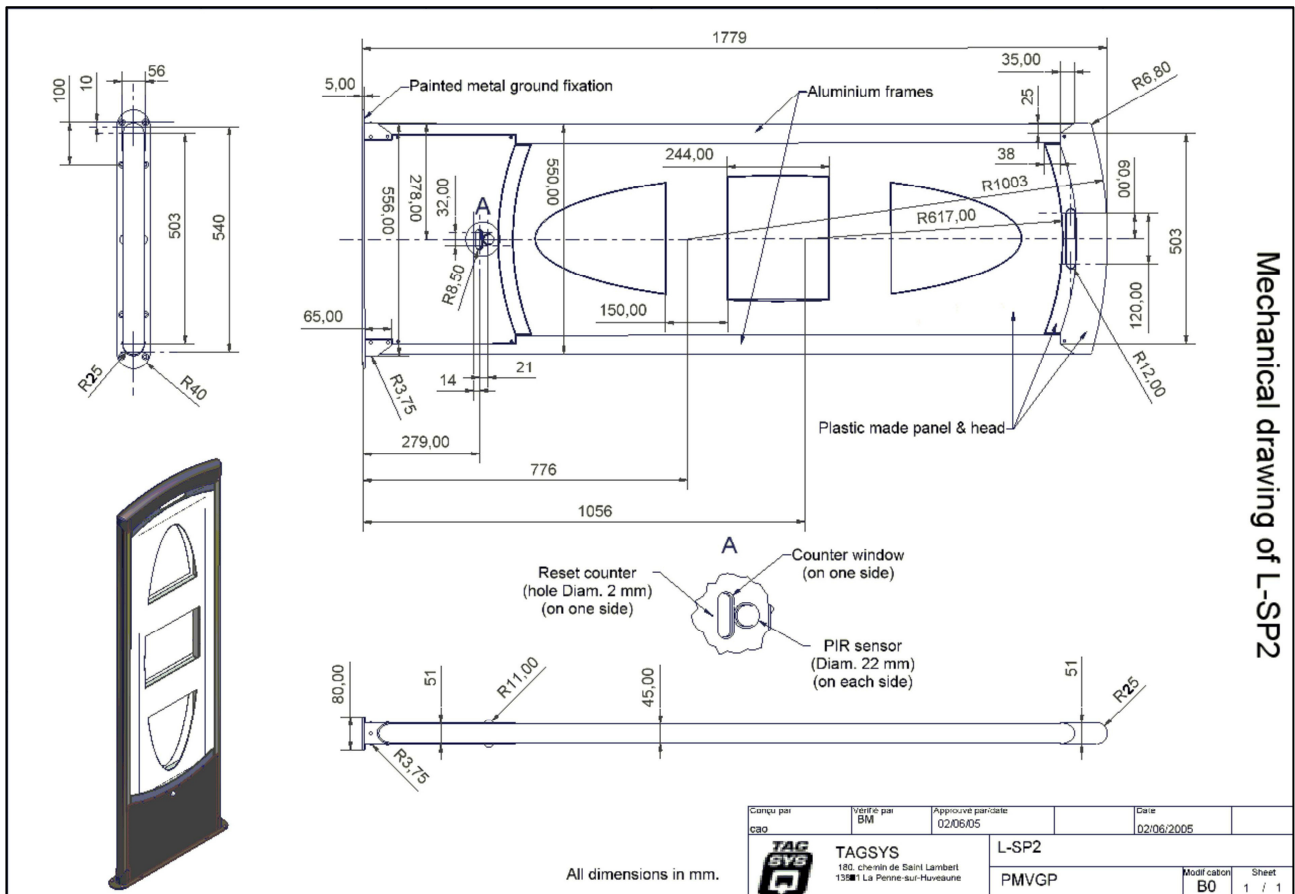

Figure 36: Mechanical Dimensions of Pedestal Base

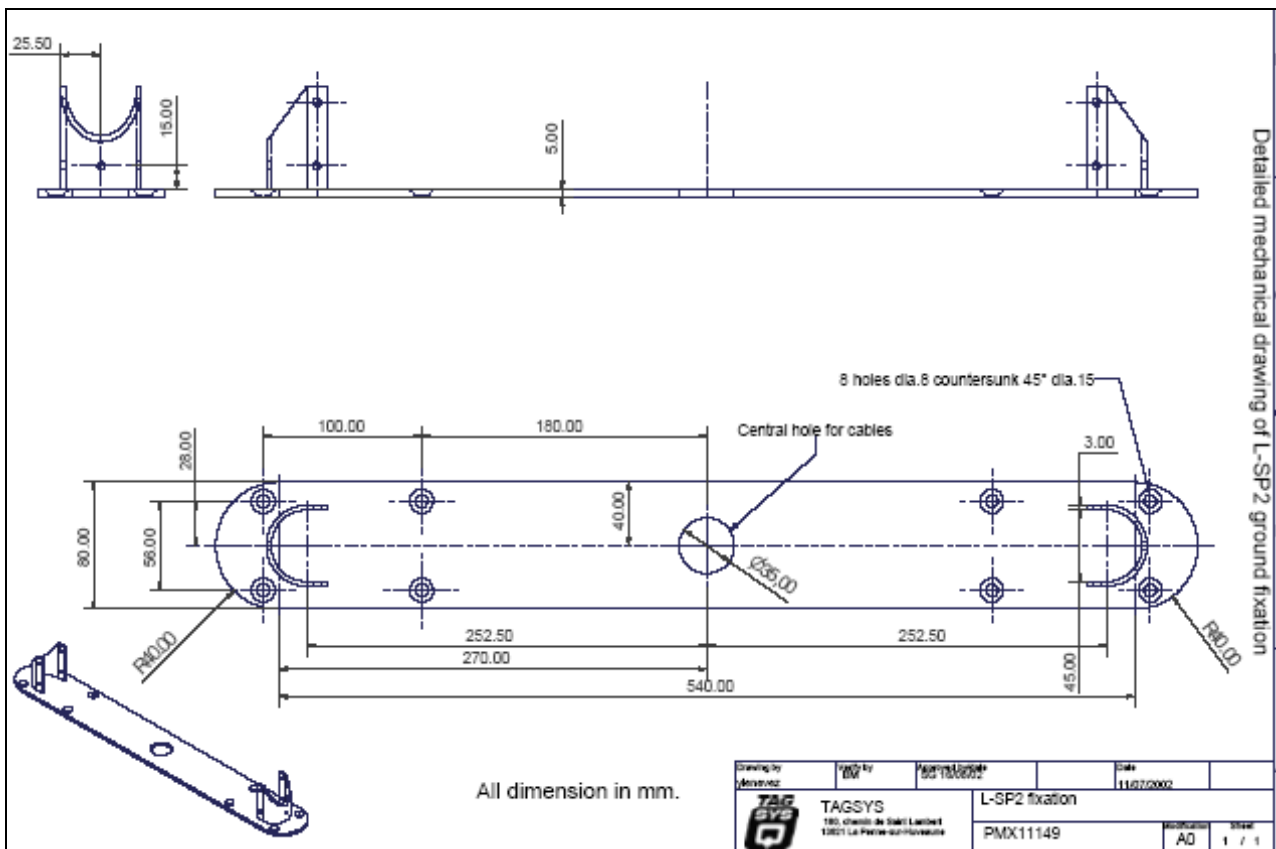

Figure 37: Mechanical Dimensions of Pedestal Base

# 11 Performance Test

## 11.1 Test Conditions

- Distance between each pedestal not greater than the maximum recommended distance of 915 mm (3 ft.).
- All tags used must have the theft bit set. Use of reference tag (Antenna Tuning Kit Test Card) is strongly recommended for repeatable results.
- Testing to be carried out at walking pace (maximum of 1 meter/second).
- Metal, conductive materials, human hands or body must not shield tags.
- All books must have tags inserted according to the 4 positions; 20-mm offset grid recommendation.
- Minimum thickness of books should be 16 mm
- Each EAS system shall be installed, commissioned, tuned and operated according to TAGSYS instructions.

## 11.2 Test Procedure

1. Divide the gate into 15 test zones as shown. **Tip:** Use masking tape to temporarily mark the floor and pedestals.
2. Using the locked reference tag(s), walk through the gate positioning the tag in the center of each zone.  
(Start at test zone 1 and sequentially test each zone in turn)
3. If either or both pedestals sound an alarm, indicate the zone box with a check mark. If neither sounds an alarm, indicate with a cross.
4. Repeat the test with the tag in three orientations for each zone. (Vertical, Horizontal & Facing positions)
5. Mark the random tests with a check mark or cross inside a triangle in the appropriate test zone.

**Figure 38: Tag Orientation**

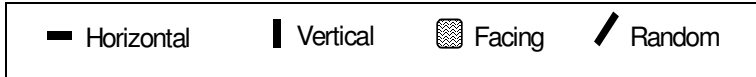

**Figure 39: Example**

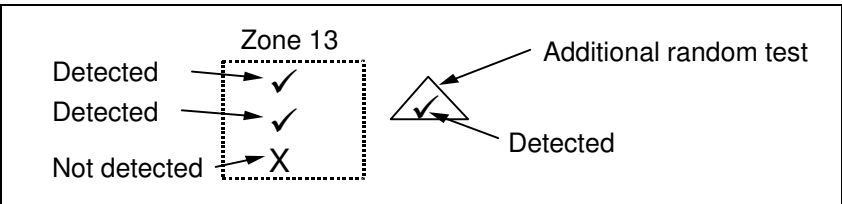

L-SP2 EAS Performance Test



Library / Facility installed: \_\_\_\_\_

Location of Pedestals: \_\_\_\_\_

Specific installation notes: \_\_\_\_\_

**Figure 40: Test Chart**

Pedestal A  
S/N: \_\_\_\_\_  
Software Version: \_\_\_\_\_

Pedestal B  
S/N: \_\_\_\_\_  
Software Version: \_\_\_\_\_

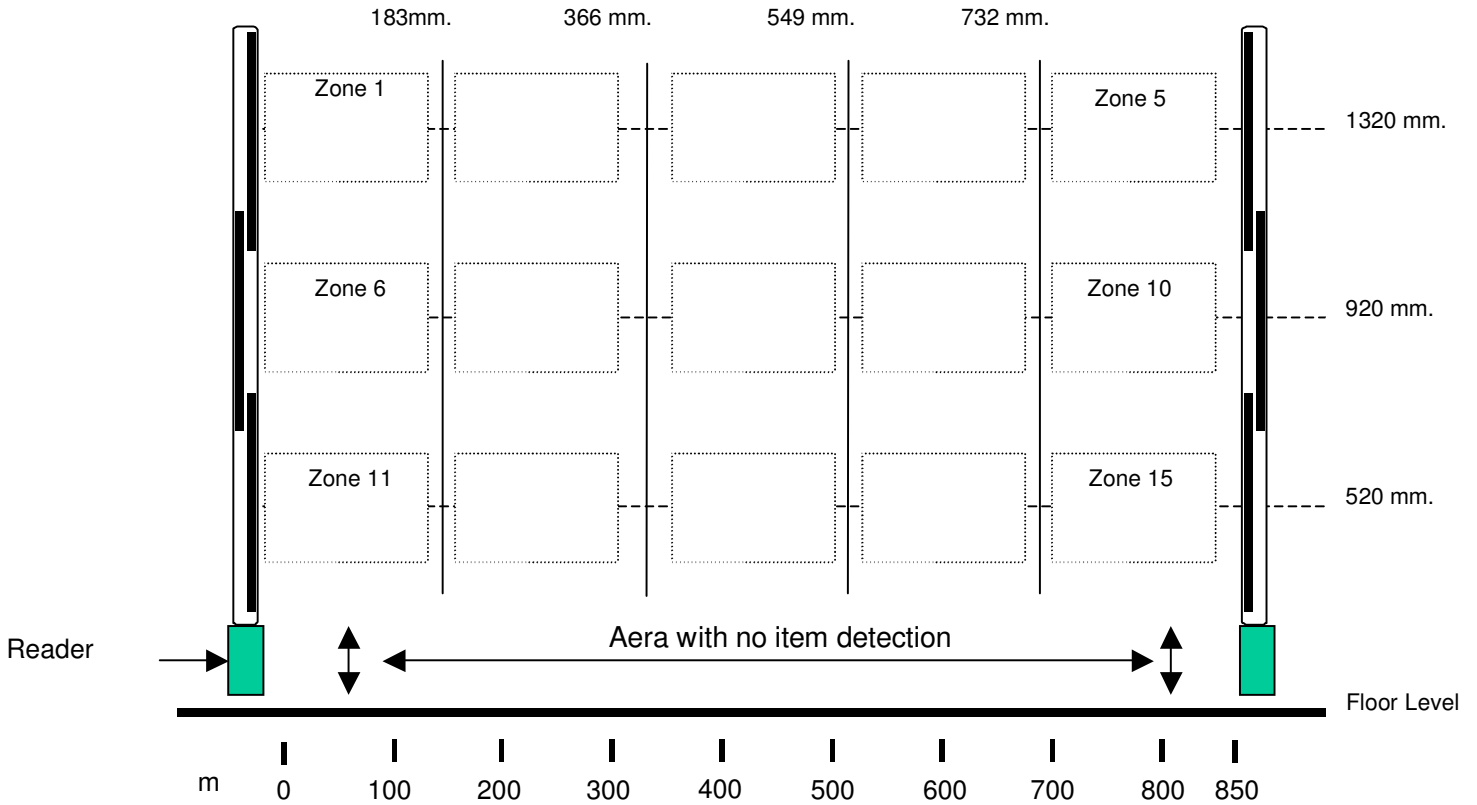

Number of Tags used: \_\_\_\_\_ Alarm lights working OK (Y/N) \_\_\_\_\_

Serial number(s) of reference Tag(s): \_\_\_\_\_ Buzzers functioning OK (Y/N) \_\_\_\_\_

\_\_\_\_\_ Test Result \_\_\_\_\_ %

Test comments: \_\_\_\_\_

Tested By: Name: \_\_\_\_\_ Company: \_\_\_\_\_

Signature: \_\_\_\_\_ Date \_\_\_\_\_

# 12 Warranty Conditions

---

TAGSYS warrants that its L-SP2 shall comply with the functional specifications set forth herein for a period of one year from the date of delivery to the Buyer.

This warranty is valid for the original Buyer of the Product and is not assignable or transferable to any other party.

TAGSYS cannot be responsible in any way for, and disclaims any liability in connection with the operation or performance of:

- Any product in which the Product is incorporated;
- Any equipment not supplied by TAGSYS which is attached to or used in connection with the Product; or,
- The Product with any equipment.

This warranty only applies to the Product and excludes all other equipment.

Optimal operation and performance of the Product are obtained by using TAGSYS' readers, by applying TAGSYS installation guidelines and by having your installation reviewed by a CIT (Certified Integrator by TAGSYS) technical consultant.

The TAGSYS warranty does not cover the installation, maintenance or service of the Product and is strictly limited to the replacement of Products considered as defective by TAGSYS and returned according to the return procedure defined below; in such case, TAGSYS will, at TAGSYS' option, either replace every defective Product by one new Product or refund the purchase price paid by Buyer to TAGSYS for the defective Product.

## 12.1 Warranty Exclusions

The following conditions are not covered under the warranty:

- Defects or damages resulting from storage of the Product under conditions that do not comply with TAGSYS specifications or normal usage.
- Defects or damages resulting from use of the Product in abnormal conditions (abnormal conditions being defined as any conditions exceeding the ones stated in the product specifications).
- Defects or damages from misuse, accident or neglect.
- Defects from improper testing, operation, maintenance or installation.
- Defects from alteration, modification except modifications or adjustments specifically described in this Product reference guide, adjustment or repair, or any attempt to do any of the foregoing, by anyone other than TAGSYS.
- Any action on the product that prevents TAGSYS to perform an inspection and test of the Product in case of a warranty claim.
- Tampering with or abuse of the Product.
- Any use or incorporation by the Buyer or a third party of TAGSYS' Product into life saving or life support devices or systems, or any related products; TAGSYS expressly excludes any liability for such use.

## 12.2 General Provisions

This warranty sets forth the full extent of TAGSYS responsibility regarding the Product.

In any event, TAGSYS warranty is strictly limited to (at TAGSYS' sole option) the replacement or refund of the Products purchase price to TAGSYS, of Products considered as defective by TAGSYS.

The remedy provided above is in lieu and to the exclusion of all other remedies, obligations or liabilities on the part of TAGSYS for damages, whether in contract, tort or otherwise, and including but not limited to, damages for any defects in the Products or for any injury, damage, or loss resulting from such defects or from any work done in connection therewith or for consequential loss, whether based upon lost goodwill, lost resale profits, impairment of other goods or arising from claims by third parties or otherwise.

TAGSYS disclaims any explicit warranty not provided herein and any implied warranty, guaranty or representation as to performance, quality and absence of hidden defects, and any remedy for breach of contract, which but for this provision, might arise by implication, operation of law, custom of trade or course of dealing, including implied warranties of merchantability and fitness for a particular purpose.

## 12.3 How to Return Defective Products

The Buyer shall notify TAGSYS of the defects within 15 working days after the defects are discovered.

Defective Products must be returned to TAGSYS after assignment by a TAGSYS Quality Department representative of an RMA (Return Material Authorization) number. No Products shall be returned without their proof of purchase and without the acceptance number relating to the return procedure.

All Products must be returned in their original packaging.

All Products shall be returned with a report from the Buyer stating the complete details of the alleged defect.

Call +33 4 91 27 57 36 for return authorization and shipping address.

If returned Products prove to be non-defective, a charge will be applied to cover TAGSYS' analysis cost and shipping costs.

If the warranty does not apply for returned Products (due to age, or application of a warranty exclusion clause), a quote for replacement will be issued, and no replacement will be granted until a valid purchase order is received. If no purchase order is received within 30 days after the date of TAGSYS quote, TAGSYS will return the products and charge the analysis cost and shipping costs.

All replaced Products shall become the property of TAGSYS.

The Product Return Form is included on the following page. This form should accompany any product you need to return to TAGSYS for analysis in the event of a problem.

**TAGSYS RFID™** e-connecting goods **Product Return Form**

Customer Profile:  
 Company: .....  
 Address: ..... Contact Name: .....  
 ..... Contact e-mail: .....  
 ..... Contact Phone: .....  
 City & State: ..... Contact Fax: .....  
 Zip Code: .....  
 Country: .....

Order identification:	Invoice	Number:
Product Name: .....	.....	
Order Number (OEF):	Return	Quantity:
	.....	

Parcel Pick up:  
 Length: ..... Height: .....  
 Width: Weight: .....  
 Address to collect the parcel:  
 .....  
 .....  
 .....  
 Contact: ..... Phone: .....

Reason for return:  
 .....  
 .....

**To inform TAGSYS of this return, please email it to**  
[RMA@tagsysrfid.com](mailto:RMA@tagsysrfid.com)  
**Address to ship the product with this document attached:**  
 TAGSYS  
 QUALITY DEPARTMENT  
 180, chemin de Saint Lambert  
 13821 La Penne sur Huveaune France

To inform TAGSYS of this return, please also fax it to your Customer Service Representative  
 +33 4 91 27 57 01

**Return Procedure**  
 The product returned will go through stringent quality controls.  
 A final analysis report will be sent to you as soon as possible.  
 Please contact your Quality Service representative for further details at  
 +33 4 91 27 57 36