



TM8000
MOBILES

TM8250/TM8254/TM8255 USER'S GUIDE



TAIT: THE RIGHT FIT

www.taitworld.com



Directive 1999/5/EC Declaration of Conformity

da Dansk

Undertegnede Tait Electronics Limited erklærer herved, at følgende udstyr TMAA4C, TMAB1C, TMAH5C & TMAC0C overholder de væsentlige krav og øvrige relevante krav i direktiv 1999/5/EF.

Se endvidere: <http://eudocs.taitworld.com/>

de Deutsch

Hiermit erklart Tait Electronics Limited die Übereinstimmung der Geräte TMAA4C, TMAB1C, TMAH5C & TMAC0C mit den grundlegenden Anforderungen und den anderen relevanten Festlegungen der Richtlinie 1999/5/EG.

Siehe auch: <http://eudocs.taitworld.com/>

el Ελληνικός

Με την παρουσία Tait Electronics Limited δηλώνει ότι TMAA4C, TMAB1C, TMAH5C & TMAC0C συμμορφώνεται προς τις ουσιαστικές απαιτήσεις και τις λοιπές σχετικές διατάξεις της οδηγίας 1999/5/EK. βλέπε και: <http://eudocs.taitworld.com/>

en English

Tait Electronics Limited declares that this TMAA4C, TMAB1C, TMAH5C & TMAC0C complies with the essential requirements and other relevant provisions of Directive 1999/5/EC.

See also: <http://eudocs.taitworld.com/>

es Español

Por medio de la presente Tait Electronics Limited declara que el TMAA4C, TMAB1C, TMAH5C & TMAC0C cumple con los requisitos esenciales y cualesquiera otras disposiciones aplicables o exigibles de la Directiva 1999/5/CE. Vea también:

<http://eudocs.taitworld.com/>

fi Suomi

Tait Electronics Limited vakuuttaa täten että TMAA4C, TMAB1C, TMAH5C & TMAC0C

tyyppinen laite on direktiivin 1999/5/EY oleellisten vaatimusten ja sitä koskevien direktiivin muiden ehtojen mukainen.

Katso: <http://eudocs.taitworld.com/>

fr Français

Par la présente, Tait Electronics Limited déclare que les appareils TMAA4C, TMAB1C, TMAH5C & TMAC0C sont conformes aux exigences essentielles et aux autres dispositions pertinentes de la directive 1999/5/CE.

Voir aussi: <http://eudocs.taitworld.com/>

it Italiano

Con la presente Tait Electronics Limited dichiara che questo TMAA4C, TMAB1C, TMAH5C & TMAC0C è conforme ai requisiti essenziali ed alle altre disposizioni pertinenti stabilite dalla direttiva 1999/5/CE.

Vedi anche: <http://eudocs.taitworld.com/>

nl Nederlands

Hierbij verklaart Tait Electronics Limited dat het toestel TMAA4C, TMAB1C, TMAH5C & TMAC0C in overeenstemming is met de essentiële eisen en de andere relevante bepalingen van richtlijn 1999/5/EG.

Zie ook: <http://eudocs.taitworld.com/>

pt Português

Tait Electronics Limited declara que este TMAA4C, TMAB1C, TMAH5C & TMAC0C está conforme com os requisitos essenciais e outras provisões da Directiva 1999/5/CE.

Veja também: <http://eudocs.taitworld.com/>

sv Svensk

Härmed intygar Tait Electronics Limited att denna TMAA4C, TMAB1C, TMAH5C & TMAC0C står i överensstämmelse med de väsentliga egenskapskrav och övriga relevanta bestämmelser som framgår av direktiv 1999/5/EG.

Se även: <http://eudocs.taitworld.com/>

Copyright and trademarks

All information contained in this document is the property of Tait Electronics Limited. All rights reserved. This document may not, in whole or in part, be copied, photocopied, reproduced, translated, stored, or reduced to any electronic medium or machine-readable form, without prior written permission from Tait Electronics Limited.

The word TAIT and the TAIT logo are trademarks of Tait Electronics Limited.

All trade names referenced are the service mark, trademark or registered trademark of the respective manufacturers.

Disclaimer

There are no warranties extended or granted by this document. Tait Electronics Limited accepts no responsibility for damage arising from use of the information contained in the document or of the equipment and software it describes. It is the responsibility of the user to ensure that use of such information, equipment and software complies with the laws, rules and regulations of the applicable jurisdictions.

Enquiries and comments

If you have any enquiries regarding this document, or any comments, suggestions and notifications of errors, please contact Technical Support.

Updates of manual and equipment

In the interests of improving the performance, reliability or servicing of the equipment, Tait Electronics Limited reserves the right to update the equipment or this document or both without prior notice.

Intellectual property rights

This product may be protected by one or more patents of Tait Electronics Limited together with their international equivalents, pending patent applications and registered trade marks: NZ508806, NZ508807, NZ509242, NZ509640, NZ509959, NZ510496, NZ511155, NZ511421, NZ516280/NZ519742, NZ520650/NZ537902, NZ521450, NZ522236, NZ524369, NZ524378, NZ524509, NZ524537, NZ524630, NZ530819, NZ534475, NZ534692, NZ535471, NZ537434, NZ546295, NZ547713, AU2003281447, AU2004216984, AU2005207405, AU2005267972, CA2554213, CA2574670, EU1,532,866, EU1,599,792, EU05704655.9, GB23865476, GB2386010, GB2413249, GB2413445, US11/232716, US10/597339, US10/520827, US5,745,840, US10/547653, US10/546696, US10/546,697, US10/520827, US10/547964, US10/523952, US11/572700.

Environmental responsibilities

Tait Electronics Limited is an environmentally responsible company which supports waste minimization, material recovery and restrictions in the use of hazardous materials.



The European Union's Waste Electrical and Electronic Equipment (WEEE) Directive requires that this product be disposed of separately from the general waste stream when its service life is over. For more information about how to dispose of your unwanted Tait product, visit the Tait Electronics WEEE website at www.taitworld.com/weee. Please be environmentally responsible and dispose through the original supplier, or contact Tait Electronics Limited.

Tait Electronics Limited also complies with the Restriction of the Use of Certain Hazardous Substances in Electrical and Electronic Equipment (RoHS) Directive in both the European Union and China.

In China, we comply with the Measures for Administration of the Pollution Control of Electronic Information Products. We will comply with environmental requirements in other markets as they are introduced.

About this guide

This user's guide provides information about the TM8250 and TM8255 mobile radios, version 5.0x and higher. If you need further assistance or your radio does not operate as you expect, contact your radio provider.



Website: For information about how to install your TM8200 radio, go to www.taitworld.com/technical.

For your safety

Before using your radio, please read the following important safety and compliance information.

Safety warnings used in this guide

Within this guide, the following conventions are used to alert you to important safety information:



Warning: There is a potential risk of death or serious injury.



Caution: There is the risk of minor or moderate injury to people.

Caution: "Caution" is used without the safety alert symbol when there is a risk of equipment damage or malfunction.

Radio frequency exposure information

For your own safety and to ensure you comply with the Federal Communication Commission's (FCC) radio frequency (RF) exposure guidelines, please read the following information before using this radio.

Using this radio

You should use this radio only for work-related purposes (it is not authorized for any other use) and if you are fully aware of, and can exercise control over, your exposure to RF energy. To prevent exceeding FCC RF exposure limits, you must control the amount and duration of RF that you and other people are exposed to.

It is also important that you:

- Do not remove the RF exposure label from the radio.
- Ensure this RF exposure information accompanies the radio when it is transferred to other users.
- Do not use the radio if you do not adhere to the guidelines on controlling your exposure to RF.

Controlling your exposure to RF energy

This radio emits RF energy or radio waves primarily when calls are made. RF is a form of electromagnetic energy (as is sunlight), and there are recommended levels of maximum RF exposure.

To control your exposure to RF and comply with the maximum exposure limits for occupational/controlled environments, follow these guidelines:

- Do not talk (transmit) on the radio more than the rated transmit duty cycle. This is important because the radio radiates more energy when it is transmitting than when it is receiving.
- While you are transmitting (talking or sending data) on the radio, you must ensure that there is always a distance of 0.9m (35 inches) between people and the antenna. This is the minimum safe distance.
- Use the radio only with Tait-approved antennas and attachments, and make only authorized modifications to the antenna otherwise you could damage the radio and violate FCC regulations.



Website: For more information on what RF energy is and how to control your exposure to it, go to www.fcc.gov/oet/rfsafety/rf-faqs.html.

Compliance with RF energy exposure standards

This two-way radio complies with these RF energy exposure standards and guidelines:

- United States Federal Communications Commission, Code of Federal Regulations; 47 CFR 1.1307, 1.1310 and 2.1091
- American National Standards Institute (ANSI) / Institute of Electrical and Electronic Engineers (IEEE) C95. 1-1992
- Institute of Electrical and Electronic Engineers (IEEE) C95.1-1999 Edition.

This radio complies with the IEEE (FCC) and ICNIRP exposure limits for occupational/controlled RF exposure environments at operating duty factors of up to 50 % talk to 50 % listen.

Radio frequency emissions limits in the USA

Part 15 of the FCC Rules imposes RF emission limits on electronic equipment to prevent interference to reception of broadcast services.

This device complies with Part 15 of the FCC Rules.

Operation is subject to the condition that this device does not cause harmful interference.

Note: Changes or modifications to this device that are not expressly approved by Tait Electronics Limited may make its use illegal.

Unapproved modifications or changes to radio

The radio is designed to satisfy the applicable compliance regulations. Do not make modifications or changes to the radio that are not expressly approved by Tait Electronics Limited. Failure to do so could invalidate compliance requirements and void the user's authority to operate the radio.

Health, safety and electromagnetic compatibility in Europe

In the European Union, radio and telecommunications equipment is regulated by Directive 1999/5/EC, also known as the Radio and Telecommunications Terminal Equipment (R&TTE) directive. The requirements of this directive include protection of health and safety of users, as well as electromagnetic compatibility.

Intended use

This product is an FM radio transceiver. It is intended for radiocommunication in the Private Mobile Radio (PMR) or Public Access Mobile Radio (PAMR) services, to be used in all member states of the European Union (EU) and states within the European Economic Area (EEA).

Restrictions

This product can be programmed to transmit on frequencies that are not harmonised throughout the EU/EEA, and will require a licence to operate in each member state.

This product can be programmed for frequencies or emissions that may make its use illegal. Where applicable, a license must be obtained before this product is used. All license requirements must be observed. Limitations may apply to transmitter power, operating frequency, channel spacing, and emission.

Declaration of conformity

Brief Declarations of Conformity appear on [page 3](#).



Website: To download the formal declaration of conformity, go to <http://eudocs.taitworld.com>.

A signed and dated paper copy of the declaration of conformity can be obtained from Tait Europe Limited.

Electromagnetic compatibility in European vehicles

In the European Community, radio equipment fitted to automotive vehicles is regulated by Directive 72/245/EEC, as amended by 95/54/EC. The requirements of this directive cover the electromagnetic compatibility of electrical or electronic equipment fitted to automotive vehicles.

Note: To meet the requirements of Directive 72/245/EEC (as amended by 95/54/EC) installation of this product in a vehicle must be performed according to the instructions provided, and any guidelines of the vehicle manufacturer.

EN 60950 requirements (25 watt radios)

This radio complies with the European Union standard EN 60950 when operated up to the rated 33% duty cycle of two minutes transmit and four minutes receive, and with ambient temperatures of 30°C or lower.



Caution: Operation outside these limits may cause the external temperature of the radio to rise higher than this standard permits.

Interference with electronic devices

Some electronic devices may be prone to malfunction due to the lack of protection from RF energy that is present when your radio is transmitting.

Examples of electronic devices that may be affected by RF energy are:

- vehicular electronic systems such as fuel injection, anti-skid brakes, and cruise control
- medical devices such as hearing aids and pacemakers
- medical equipment in hospitals or health care facilities.

Consult the manufacturer (or its representative) of the equipment to determine whether these electronic circuits will perform normally when the radio is transmitting.

Frequency band reserved for distress beacons

Frequency band 406 to 406.1 MHz is reserved for use by distress beacons. Transmissions should not be made within this frequency band.

Safe radio operation



Warning: Observe the following safe operating practices:

- Switch the radio off at petrol filling stations or near flammable liquids or gases.
- Switch the radio off in the vicinity of explosive devices and blasting zones.
- Using a handheld microphone or a radio while driving a vehicle may violate the laws and legislation that apply in your country or state. Please check the regulations in your area.

High radio surface temperatures

The bottom surface of the radio and the heatsink fins can become hot during prolonged operation. Do not touch these parts of the radio.

Radio protection when charging the vehicle battery

Always remove the fuses from the radio power cable before charging the vehicle battery, connecting a second battery or using power from another vehicle (e.g. when jump-starting the vehicle).

GPS operation

Tait Electronics Limited is not responsible for the operation or failure of operation of GPS satellites or the availability of GPS satellite signals.

Acknowledgement:

The radio uses an implementation of UTM conversion sourced (with permission) from Geoscience Australia (GA).

Your radio's settings

Use the following table to list your radio's programmed settings.

Function key settings

	Conventional	Trunked
F1	_____	_____
F2	_____	_____
F3	_____	_____
F4	_____	_____
F5	_____	_____
F6	_____	_____

quick access
menus:



Frequently used channels and groups

ID/Number	Description	ID/Number	Description
_____	_____	_____	_____
_____	_____	_____	_____
_____	_____	_____	_____
_____	_____	_____	_____
_____	_____	_____	_____
_____	_____	_____	_____
_____	_____	_____	_____
_____	_____	_____	_____
_____	_____	_____	_____
_____	_____	_____	_____
_____	_____	_____	_____



Navigating your radio's menus

Some of the menus shown below may not be available for your radio.

Menu maps

Conventional mode

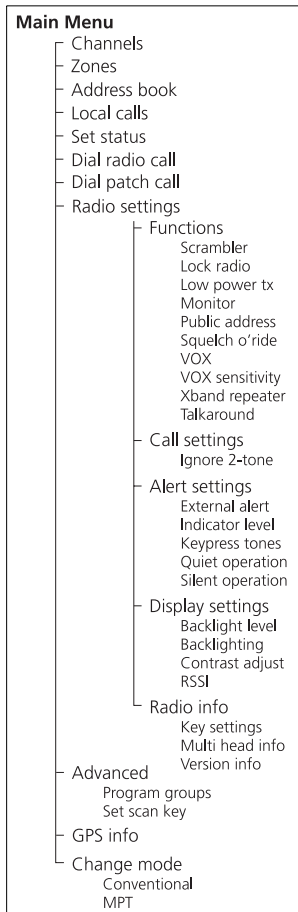

Trunked mode

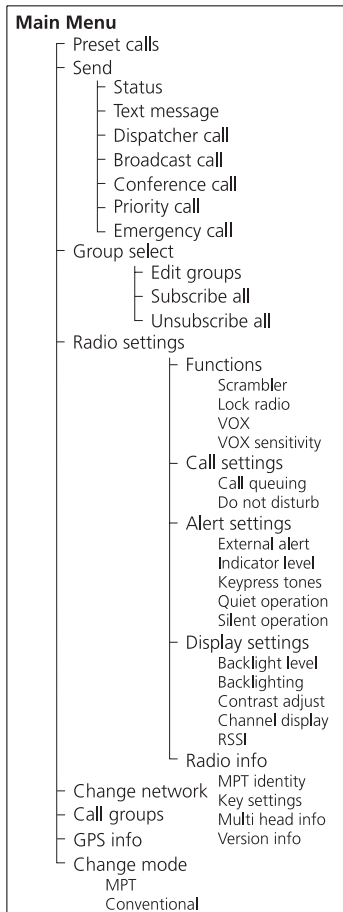

Contents

About this guide	6
For your safety	7
Safety warnings used in this guide	7
Radio frequency exposure information	7
Controlling your exposure to RF energy	8
Compliance with RF energy exposure standards	9
Radio frequency emissions limits in the USA	9
Unapproved modifications or changes to radio	9
Health, safety and electromagnetic compatibility in Europe	10
Electromagnetic compatibility in European vehicles	11
EN 60950 requirements (25 watt radios)	11
Interference with electronic devices	11
Frequency band reserved for distress beacons	12
Safe radio operation	12
High radio surface temperatures	12
Radio protection when charging the vehicle battery	12
GPS operation	12
Your radio's settings	13
Getting started	17
About the radio controls	17
About the keypad microphone	19
About the hand-held control head	19
Understanding the radio display	21
Understanding the radio indicators	23
Navigating your radio's menus	25
Viewing your radio's function key settings	27
Sharing a multi-head radio with other users	28
Basic operation	29
Turning the radio on and off	29
Entering your personal identification number	29
Adjusting the speaker volume	30
Turning on control-head backlighting	30
Changing the level of control-head backlighting	31
Changing the contrast of the radio display	32
About GPS information	33
Viewing GPS information	34

Operating in conventional mode	35
Selecting a zone	35
Selecting a channel	37
Selecting a group	39
Checking that a channel is clear	41
Communicating directly with other radios	43
Making a call	45
Making a local call	46
Making a call using your address book	48
Making an emergency call	50
Receiving a call	50
Operating in MPT trunked mode	51
Changing your operating mode	51
Checking that your network is available	53
Changing your network	53
Making a preset call	55
About talkgroups and scan groups	57
Making a talkgroup call	58
Changing group membership	60
Making an emergency call	63
Dialling a PABX number	65
Dialling a PSTN number	65
Receiving a call	66
Re-establishing a call	68
Checking missed calls	69
About status messages	71
About text messages	73
Calls to conventional channels or groups	76
Dialling calls in MPT trunked mode	77
MPT 1343 dialling	77
Nokia ANN fleet calls	79
Accessing common MPT trunking functions	81
Troubleshooting	83
When your radio won't turn on	83
Removing the microphone	83
Reinstalling the microphone	84
Removing the radio from the vehicle	84
Describing the radio's audible tones	85
Tait general software licence agreement	87

Getting started

This section provides a brief description of your radio's controls and indicators and explains how to use the radio's menus.

The following topics are covered in this section:

- [about the radio controls](#)
- [about the keypad microphone](#)
- [about the hand-held control head](#)
- [understanding the radio display](#)
- [understanding the radio indicators](#)
- [navigating your radio's menus](#)
- [viewing your radio's function key settings](#)
- [sharing a multi-head radio with other users](#)

About the radio controls

The radio controls are the PTT key, volume control, on/off key, scroll keys, selection keys and function keys. Some keys may have functions assigned to both short and long key presses:

- a short key press is less than one second, and
- a long key press is more than one second.

The radio controls and their functions are summarized in the following diagram and table.

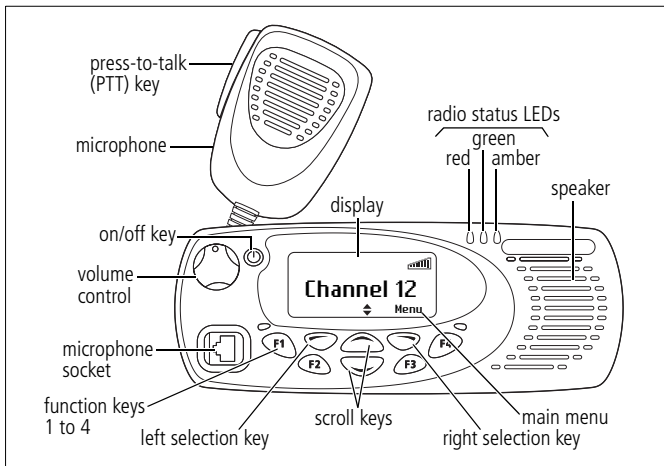

Symbol	Name	Function
	PTT key	Press and hold to transmit and release to listen
	Volume control	Rotate to change the speaker volume
⏻	On/off key	Turn the radio on or off with a long press
⬅️	Left selection key	Action determined by the text above the left selection key, or deletes a dialled character from the display
➡️	Right selection key	Action determined by the text above the right selection key
⬆️ ⬆️	Scroll keys	Scroll up and down through a list of menu options or scroll left and right in messages Select your Quick Access menu
	Function keys	Function keys with programmed options

About the keypad microphone

Your radio may have a keypad microphone installed. The keypad microphone has a PTT key as well as twelve alphanumeric keys, two scroll keys, and left and right selection keys.

The PTT key and the scroll and selection keys work in the same way as those on the control head (see [“About the radio controls” on page 17](#)). The alphanumeric keys are used to enter letters and numbers.

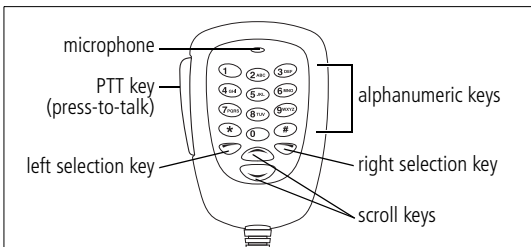

About the hand-held control head

Your radio may have a hand-held control head installed, to enable you to operate the radio at a distance from the radio body. The keys and controls work in the same way as those on the standard control head and keypad microphone, with the exception of the volume up and down keys. The hand-held control head also has two additional function keys.

Note: The hand-held control head may have been configured to turn the radio on with a PTT press.

The hand-held control head keys and their functions are summarized in the following diagram and table.

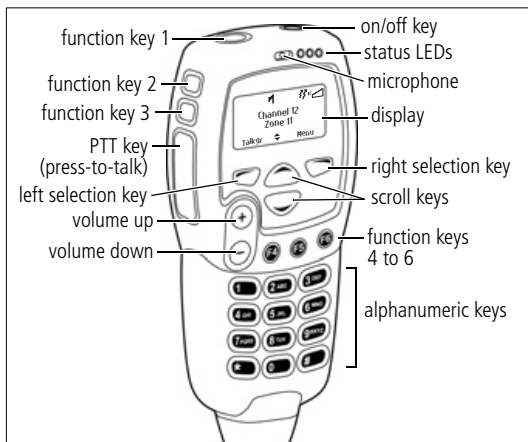

Symbol	Name	Function
	PTT key	Press and hold to transmit and release to listen
+	Volume up	Press to increase the speaker volume
-	Volume down	Press to decrease the speaker volume
⏻	On/off key	Press to turn the radio on or off
⏪	Left selection key	Action determined by the text above the left selection key, or deletes a dialled character from the display
⏩	Right selection key	Action determined by the text above the right selection key
⏴ ⏵	Scroll keys	Scroll up and down through a list of menu options or scroll left and right in messages, or select your Quick Access menu
Tip: If you press and hold the scroll keys, the scroll speed increases.		
	Function keys	Function keys with programmed options
	Alphanumeric keys	Used to enter letters and numbers

Understanding the radio display





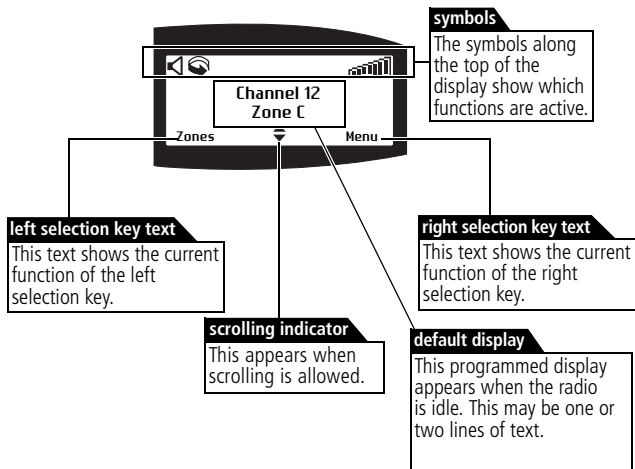







The messages and symbols you see on your radio display depend on the mode in which your radio is operating and the way it is programmed.

The following diagram shows a typical display and explains some of the information that may be available.



Radio display symbols

These are some of the symbols you may see on your radio display:

Symbol	Meaning
	Received signal strength indicator (RSSI): the more bars, the stronger the signal being received by your radio
	Transmit: your radio is transmitting
	Low-power transmit: your radio is transmitting on low power
	Silent operation: your radio's audible tones have been turned off
	External alert: external alert is active
	Call queuing: call queuing is active
	Queued call: there are calls in the call queue
Conventional mode symbols:	
	Scanning: your radio is monitoring a group of channels for activity (this symbol is animated)
	Monitor or squelch override: monitor or squelch override is active
	Repeater talkaround: your radio is operating in repeater talkaround mode
MPT trunked mode symbols:	
	MPT network: your radio has access to an MPT network Flashing: your radio is attempting to access an MPT network
	Go: your radio has established a call and you are now able to speak to the other party

Understanding the radio indicators

The status LED indicators and the radio's audible tones—together with the radio display—all combine to give you information about the state of your radio.

The most common way the indicators work is described in the following sections.

Note: The way these indicators behave may be affected by the way your radio is programmed.

Status LED indicators

LED	Meaning
red (transmit)	Glowing: your radio is transmitting Flashing: your transmit timer is about to expire, or your radio is stunned
green (receive)	Glowing: you are receiving activity (conventional mode) or your radio is actively in a call (MPT trunked mode) Flashing (conventional mode): you have received a call with valid special signalling, or you have activated monitor or squelch override
amber (scanning or network)	Glowing: your radio is scanning a group of channels for activity (conventional mode) or network service is available (MPT trunked mode) Flashing: your radio has detected activity on a channel, and has halted on this channel (conventional mode) flashing fast: there is no network service available (MPT trunked mode)

Audible tones

Note: If quiet or silent mode has been turned on, you will not hear any audible tones.



For a description of other tones you may hear, see [“Describing the radio’s audible tones” on page 85.](#)

Tone type	Meaning
one short beep	Valid key press: the action you have attempted is permitted, or Function activated: a function key has been pressed and that function has been activated
one long, low-pitched beep	Invalid key press: the action you have attempted is not permitted, or Transmission inhibited: you have attempted to transmit but for some reason transmission is not permitted at this time
one short, low-pitched beep	Function deactivated: a function key has been pressed and the corresponding function has been turned off



Navigating your radio's menus

Your radio has a number of menus available, each containing lists or submenus. The menus available will depend on the way your radio is programmed.

Using the Main menu

Whenever **Menu** appears above the right selection key , you are able to open the Main menu by pressing .





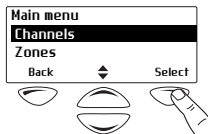

Use the scroll keys  or  to move through the list of menus.

When the menu you want is highlighted, press **Select** to open the menu you have chosen.



Using the scroll key Quick Access menu

Your radio may be programmed so that your scroll keys act as a shortcut to a frequently used menu. To go to this Quick Access menu, press a scroll key  or , and the Quick Access menu appears.

For example, if your Channels menu is your Quick Access menu, press a scroll key  or  to go directly to the Channels menu.

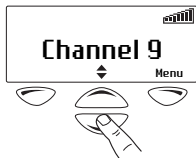

The Channels menu, with a list of your available channels and scan groups, is now displayed.

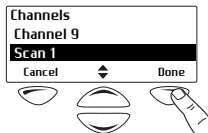

Note: Your scroll keys may be programmed for channel scroll. If this is the case, press the scroll key to immediately begin scrolling through your list of channels.

Using the left selection key Quick Access menu

Your radio may be programmed so that your left selection key acts as a shortcut to another frequently used menu. If this menu has been programmed, the text for left selection key corresponds to the menu.



To use this Quick Access menu, press your left selection key , and the associated menu appears.

Viewing your radio's function key settings

Your radio's four function keys can have programmed functions assigned to each key. Some keys may have a function associated with both a short key press and a long key press.

To check the functions assigned to your radio's function keys, you can use the Main menu.

- 1 Select Menu>Radio settings> Radio info>Key settings.

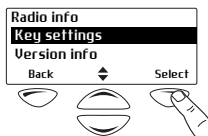

- 2 In the Key Settings menu, scroll through the list of function keys.

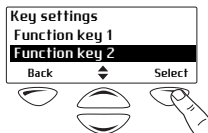

- 3 Press **Select** to view details of the function associated with a particular function key.

The example shown is for a function key programmed to turn control-head backlighting on and off.

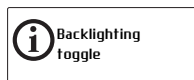

Sharing a multi-head radio with other users

Your radio may be installed with multiple control heads, so you can share the radio with other users. Elements of the user interface (such as display content, internal speaker audio, and LEDs) are duplicated on all control heads. When sharing the radio with other users:

- wait until other users have finished before using the radio. The radio may be in use if the red transmit LED is glowing, there is audio from the speaker, or there is user-related activity (such as scrolling) on the display.
- you can change the display contrast and the volume without impacting on other users.
- features such as backlighting and indicator volume apply to all control heads. Consider other users before changing these features of the user interface.

Listening to outgoing transmissions

Your radio may be programmed so you can hear outgoing transmissions initiated from other control heads. You may need to remove the microphone from the microphone clip to hear these transmissions.

Identifying your control head type

Some actions apply to the primary control head only, such as adjusting the volume of a remote speaker.

To check whether your control head is the primary or secondary head:

- 1 Select Menu>Radio settings>Radio info>Multi head info.
- 2 Press **Select** to view the control head type.

In the example shown, the control head is the primary head.

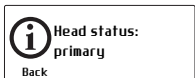
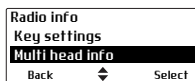

Basic operation

This section describes the basic operation of your radio.

The following topics are covered in this section:

- [turning the radio on and off](#)
- [entering your personal identification number](#)
- [adjusting the speaker volume](#)
- [turning on control-head backlighting](#)
- [changing the level of control-head backlighting](#)
- [changing the contrast of the radio display](#)
- [about GPS information](#)

Turning the radio on and off

Give a long press of the on/off key  to turn the radio either on or off.

When the radio is first turned on, the red, green and amber LEDs flash briefly and the radio gives two short beeps. A brief message may appear in the display.

Note: The hand-held control head may be configured to turn on with a PTT press.

Entering your personal identification number

You may need to enter a personal identification number (PIN) before you can use your radio. If the message **Enter PIN** appears, enter your assigned PIN.

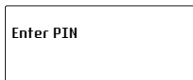

Once you have entered your PIN correctly, the radio sounds two short beeps and normal operation is now possible.

If you do not know your PIN or you receive a wrong PIN message, consult your radio provider or administrator.

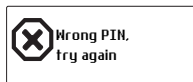

Adjusting the speaker volume

The volume control also changes the volume level of the radio's audible indicators.

Note: Your radio may be programmed with a minimum volume level.

Standard control head

Rotate the volume control clockwise to increase the speaker volume and counterclockwise to decrease the volume.

Hand-held control head

Press ⊕ to increase the speaker volume and ⊖ to decrease the volume.

Turning on control-head backlighting

The radio's display and keypad light up when backlighting is on. This normally only happens when a key is pressed or a call is received. There are two ways you may be able to change the way backlighting operates on your radio:

- turn on backlighting momentarily, using a programmed function key, or
- change backlighting between on and off, using either a programmed function key or the Main menu.

Turning backlighting on momentarily by using a function key

You may be able to use a programmed function key to turn backlighting on momentarily. Backlighting remains on for a few seconds and then turns off.

Alternatively, the function key may be programmed so that:

- a short key press turns backlighting on momentarily, and
- a long key press turns backlighting on, and it remains on until there is a further long key press.

Turning backlighting on and off by using a function key

The function key programmed for Backlighting turns backlighting on and off. When backlighting is turned on, it remains on until the function key is pressed again.

Turning backlighting on and off by using the Main menu

When backlighting is turned on using the menu, it remains on until the setting is changed to off, regardless of radio activity.

- 1 Select Menu>Radio settings> Display settings>Backlighting.

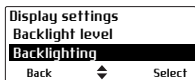

- 2 In the Backlighting menu, choose either **On** or **Off**.

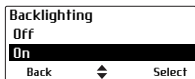

- 3 Press **Select**.

Changing the level of control-head backlighting

The radio's display and keypad light up when backlighting is on. This normally only happens when a key is pressed or a call is received.

You may be able to change the level of control-head backlighting using the Main menu.

- 1 Select Menu>Radio settings> Display settings>Backlight level.

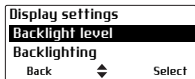

- In the Backlight Level menu, choose either **High**, **Medium** or **Low**.
- Press **Select**.

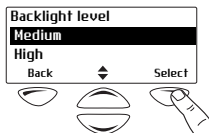



Changing the contrast of the radio display

If the radio's display is too dark or too light, you may be able to adjust the contrast by using the Contrast Adjust menu.

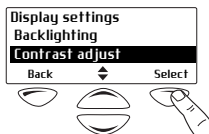
- Select Menu>Radio settings>Display settings>Contrast adjust.



- In the Contrast Adjust menu, use the scroll keys  or  to adjust the display contrast to the desired level.
- Press **Save** to save this setting.

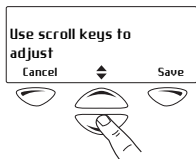

About GPS information

Your radio may be connected to a GPS (global positioning system) receiver, and programmed (see the note below) so you can view GPS information such as latitude and longitude, true course, speed, and coordinated universal time. Your radio may also be programmed to display UTM (universal transverse mercator) information such as the UTM zone, and northing and easting coordinates.

Note: GPS information on the radio display is not a standard feature. Before being programmed, it must be purchased and enabled on the radio via the Software Feature Enabler. Contact Tait Electronics Limited for more information.

About GPS status information

While viewing GPS information, GPS status information appears at the top right of the display.

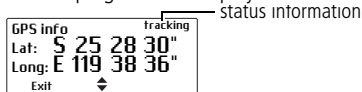

The status information you see on a hand-held control head may differ to that on a standard control head. In the following section, status information for a hand-held control head is shown in brackets [].

The following GPS status information may appear in the display:

- **Tracking [trk]:** the GPS receiver is communicating with a satellite.
- **Lost cnx [no cnx]:** the radio has lost serial communications with the GPS receiver.
- **Stored [no cnx]:** GPS receiver is having trouble connecting to a satellite and the radio is displaying stored information that may not be current.

Viewing GPS information

To view GPS information, you may be able to either:



- use a programmed function key, or
- use the Main menu.

Viewing GPS information by using a programmed function key

- 1 Press the function key programmed for GPS display.

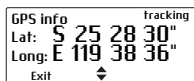
GPS information is now shown in the display.





- 2 Use the scroll keys  or  to view more GPS information.
- 3 Press **Exit** to exit the GPS display.

Viewing GPS information by using the Main menu

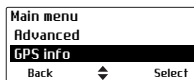
- 1 Select Menu>GPS info.



- 2 Use the scroll keys  or  to view more GPS information.

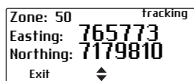

- 3 Press **Exit** to exit the GPS display.

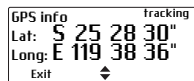

Operating in conventional mode

The following topics are covered in this section:

- selecting a zone
- selecting a channel
- selecting a group
- checking that a channel is clear
- communicating directly with other radios
- making a call
- making a local call
- making a call using your address book
- making an emergency call
- receiving a call

Selecting a zone

A zone is a collection of channels and groups. When you select a zone, only the channels and groups assigned to that zone are available.

To select a zone you may be able to either:

- use the Main menu, or
- use your Quick Access menu.

Selecting a zone by using the Main menu

- 1 Select Menu > Zones.

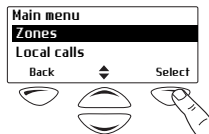

- 2 In the Zones menu, scroll through the list of zones until the one you want appears.

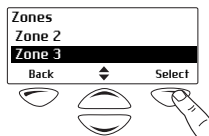

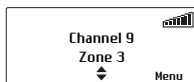

3 Press **Select**.

The zone indication may be programmed to appear either below the channel information or beside the RSSI symbol.



Selecting a zone by using your Quick Access menu

Note: Your scroll keys may be programmed for zone scroll. If this is the case, press the scroll key to immediately begin scrolling through your list of zones.

- 1 Press one of the scroll keys  or  to open the Zones menu.

Alternatively, the left selection key may be programmed as your Quick Access menu. In this case, press the left selection key  to access the Zones menu.

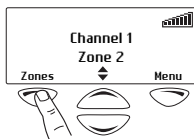

- 2 Scroll through the list of zones until the zone you want appears.
- 3 Press **Select**.

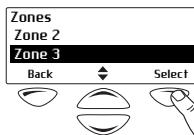

The zone indication may be programmed to appear either below the channel information or beside the RSSI symbol.

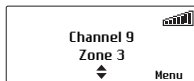

Selecting a channel

To select a channel you may be able to either:

- use a programmed function key,
- use the Main menu, or
- use your quick access menu.

Selecting a channel by using a programmed function key

Press the function key programmed for preset channel.

The programmed channel is now shown in the display.



Selecting a channel by using the Main menu

1 Select Menu > Channels.

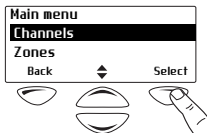

2 In the Channels menu, scroll through the list of channels until the channel you want appears.

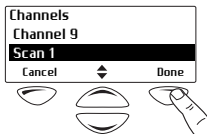



3 Press **Done**.

The programmed channel is now shown in the display.



Selecting a channel by using your Quick Access menu

Note: Your scroll keys may be programmed for channel scroll. If this is the case, press the scroll key to immediately begin scrolling through your list of channels.

- 1 Press one of the scroll keys  or  to open the Channels menu.

Alternatively, the left selection key may be programmed as your Quick Access menu. In this case, press the left selection key  to access the Channels menu.

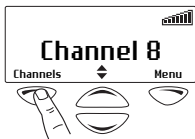

- 2 Scroll through the list of channels until the channel you want appears.
- 3 Press **Done**.

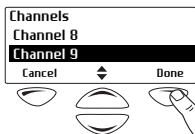

The programmed channel is now shown in the display.



Selecting a group

A group is a collection of channels that are grouped together for either scanning or voting. In the Channels menu, the group is shown as being a single channel item, e.g. "Scan1". To select a group you may be able to either:

- use a programmed function key,
- use the Main menu, or
- use your quick access menu.

Selecting a group by using a programmed function key

Press a function key programmed for group scanning.

The programmed group is now shown in the display, the amber LED glows and the scanning symbol  appears in the display.

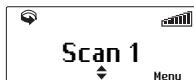

Selecting a group by using the Main menu

- 1 Select Menu>Channels.

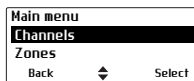

- 2 In the Channels menu, scroll through the list of channels and groups until the group you want appears.

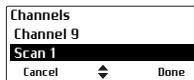

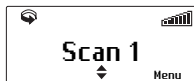

- 3 Press **Done**.

The amber LED glows and the scanning symbol  appears in the display.



Selecting a group by using your Quick Access menu

Note: Your scroll keys may be programmed for channel scroll. If this is the case, press the scroll key to immediately begin scrolling through your list of channels and groups.

- 1 Press one of the scroll keys  or  to open the Channels menu.

Alternatively, the left selection key may be programmed as your Quick Access menu. In this case, press the left selection key  to access the Channels menu.

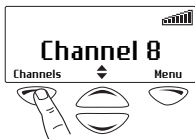

- 2 Scroll through the list of channels and groups until the group you want appears.
- 3 Press **Done**.

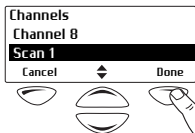

The amber LED glows and the scanning symbol  appears in the display.

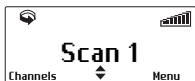

Checking that a channel is clear

You or your user group may be segregated from other user groups by special signalling. If an incoming call carries the special signalling tones specific to you or your user group, your radio's signalling mute opens and you can hear the call. These tones may not be audible.

The monitor function may allow you to override any special signalling on a channel, so that you can check that the channel is clear before you make a call.

Note: Your radio may be programmed to activate monitor whenever the microphone is off the microphone clip.

To activate monitor, you may be able to either:

- remove the microphone from the microphone clip,
- use a programmed function key, or
- use the Main menu.

Activating monitor by using a function key

- 1 Press the monitor function key to activate monitor and hear any traffic on the channel.

While monitor is on, the green LED flashes slowly and the monitor symbol  appears in the display.



- 2 Press the monitor function key again to turn monitor off, or wait for monitor to turn off automatically, after a programmed delay.

When monitor turns off, the green LED stops flashing and the monitor symbol  disappears from the display.



Note: Your radio may be programmed so that monitor turns off automatically after a short time.

Activating monitor by using the Main menu

- 1 Select Menu>Radio settings>Functions>Monitor.

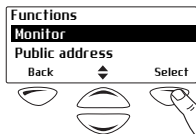

- 2 In the Monitor menu, choose **On**.
- 3 Press **Select**.

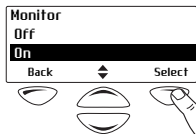

While monitor is on, the green LED flashes slowly and the monitor symbol  appears in the display.



Note: Your radio may be programmed so that monitor turns off automatically after a short time.

Communicating directly with other radios

You can bypass the radio repeater and communicate directly with another radio. This feature is known as repeater talkaround.

You can do this, for example, when you are out of range of the repeater, or if the repeater is busy or stops working.

While repeater talkaround is active, all transmissions are made on the receive frequency of the channel you are on.

To activate repeater talkaround, you may be able to either:

- use a programmed function key, or
- use the Main menu.

Activating repeater talkaround by using a function key

- 1 Change to the required channel.
- 2 Press the programmed function key to turn repeater talkaround on.

The message **Talkaround activated** appears and the repeater talkaround symbol  appears in the display.

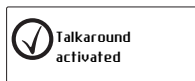

- 3 Proceed with your call.
- 4 To turn repeater talkaround off, either:
 - change the channel, or
 - press the function key again.

Activating repeater talkaround by using the Main menu

- 1 Change to the required channel.
- 2 Select Menu>Radio settings>Functions>Talkaround.
- 3 In the Talkaround menu, choose **On**.
- 4 Press **Select**.

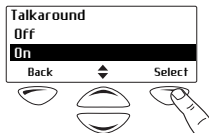

The message **Talkaround activated** appears. The repeater talkaround symbol  appears if you navigate to the default display.

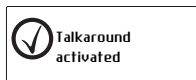

- 5 Proceed with your call.
- 6 To turn repeater talkaround off, either:
 - change the channel, or
 - choose **Off** in the Talkaround menu and press **Select**.

Making a call

- 1 Select the required channel or scan group.
- 2 Check that the channel is clear. If the green LED is glowing, the channel is busy and you may not be able to transmit.
- 3 Once the channel is clear (the green LED is off), lift the microphone off the microphone clip.
- 4 Hold the microphone about 5 cm (2 inches) from your mouth.
- 5 Press and hold the PTT key to transmit.
- 6 Speak clearly into the microphone and release the PTT key when you have finished talking.

While you are transmitting, the red LED glows and the transmit symbol  appears in the display.

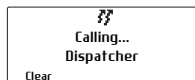

Transmit timer

Your radio may have a transmit timer that limits the amount of time you can transmit continuously.

When the transmit timer is about to expire, the message **Transmit timeout imminent** appears in the display, the red LED flashes and the radio gives three beeps.

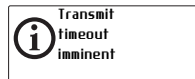

If the transmit timer has timed out, you must release the PTT before you can transmit again.

Making a local call

Each channel on your radio may have one or more local calls programmed. To make a local call you may be able to either:

- use the Main menu, or
- use your Quick Access menu.

Making a local call by using the Main menu

- 1 Select the required channel.
- 2 Select Menu>Local calls.

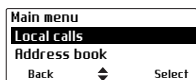

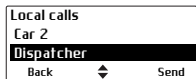

- 3 In the Local Calls menu, scroll through the list of local calls until the call you want appears.
- 4 Press **Send**.

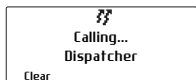

The call details appear in the display, the red LED glows and the transmit symbol  appears in the display.



Making a local call by using your Quick Access menu

- 1 Select the required channel.
- 2 Press one of the scroll keys  or  to open the Local Calls menu.

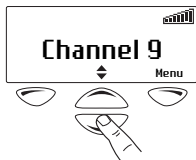

- 3 Scroll through the list of local calls until the call you want appears.
- 4 Press **Send**.

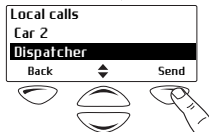

The call details appear in the display, the red LED glows and the transmit symbol  appears in the display.



Making a call using your address book

Your Address Book menu has a programmed list of calls, which can be made from any channel or zone. Address-book calls may also be used to send status information, such as "at lunch" or "on site".

To make a call using your address book, you may be able to either:

- use a programmed function key,
- use the Main menu, or
- use your Quick Access menu.

Making an address-book call by using a function key

Press the function key programmed for Address Book Call.

The call details appear in the display, the red LED glows and the transmit symbol  appears in the display.

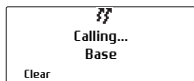

Making an address-book call by using the Main menu

- 1 Select Menu>Address book.

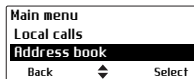

- 2 In the Address Book menu, scroll through the list of calls until the call you want appears.

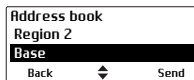

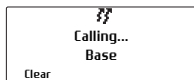

3 Press **Send**.

The call details appear in the display, the red LED glows and the transmit symbol  appears in the display.



Making an address-book call by using your Quick Access menu

- 1** Press one of the scroll keys  or  to open the Address Book menu.

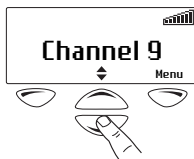

- 2** Scroll through the list of calls until the call you want appears.

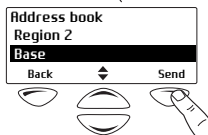

3 Press **Send**.

The call details appear in the display, the red LED glows and the transmit symbol  appears in the display.

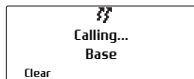

Making an emergency call

You may be able to activate emergency mode by using a programmed function key.

Note: The emergency function key may be programmed for either a short key press or long key press.

- 1 Press the function key programmed for Emergency Mode and an emergency call is sent to your dispatcher, or some other predetermined location.

While emergency mode is active, your radio may cycle between receive and transmit, so that your dispatcher can hear any activity near the radio. Alternatively, your radio may appear to turn off but will actually remain in emergency mode.

- 2 **Reset the radio to normal operation at any time by turning the radio off and then on.**

Note: Emergency mode may be programmed to end after a fixed period of time. In this case, there is no need to turn the radio off and then on in order to return the radio to normal operation.

Receiving a call

When there is valid activity on your radio's currently selected channel or group, the radio then unmutes and you can hear the call.

If the incoming call contains special signalling that matches the signalling programmed for your radio, the green LED flashes and your radio may give a ringing tone.

Operating in MPT trunked mode

Note: Your radio must have trunking functionality programmed before it can operate in MPT trunked mode.

The following topics are covered in this section:

- [changing your operating mode](#)
- [checking that your network is available](#)
- [changing your network](#)
- [making a preset call](#)
- [about talkgroups and scan groups](#)
- [making an emergency call](#)
- [dialling a PABX number](#)
- [dialling a PSTN number](#)
- [receiving a call](#)
- [re-establishing a call](#)
- [checking missed calls](#)
- [about status messages](#)
- [about text messages](#)
- [calls to conventional channels or groups](#)

Changing your operating mode

The way your radio performs basic functions, such as sending and receiving calls, depends on the operating mode of your network. The two operating modes that may be available on your radio are conventional mode (see [“Operating in conventional mode” on page 35](#)), and MPT trunked mode.

To change your radio’s operating mode, you may be able to either:

- use a programmed function key, or
- use the Main menu.

Using a function key to change operating mode

Press the function key programmed to change modes and the radio shows the programmed default display for either conventional or MPT trunked mode.

Using the Main menu to change operating mode

- 1 Select Menu > Change mode.

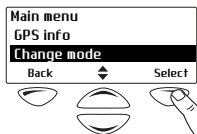

- 2 In the Change Mode menu, select either **Conventional** or **MPT**.

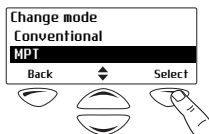

- 3 Press **Select**.
- 4 Press **Yes** when you are prompted to confirm your selection.

Your radio restarts, and shows the programmed default display for either conventional or MPT trunked mode.

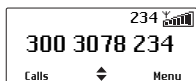

Checking that your network is available

Check that the amber LED is glowing and the network symbol  appears in the display. The amber LED glows and the network symbol is shown whenever your radio has access to the MPT trunked network.

If the amber LED and the network symbol are flashing, your radio is attempting to access the MPT trunked network. If these indicators remain flashing, your radio may be out of the network coverage area.

Changing your network

Your radio may be programmed to operate on different trunking networks. You may wish to change networks because you are out of the network coverage area, or you need to have access to another trunking network.

To change your radio's operating network, you may be able to either:

- use the Main menu, or
- dial the new network using the alphanumeric keys.

Using the Main menu to change networks

- 1 Select Menu>Change network.

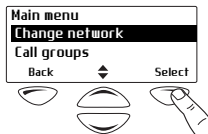

- 2 In the Change Network menu, scroll through the list of networks until the network you want appears.

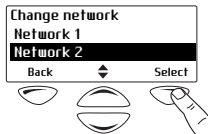

- 3 Press **Select**.

The radio will restart, and display a power-up message followed by the name of the new network.

- 4 Check that the amber LED is glowing and the network symbol  appears in the display. If the amber LED and network symbol keep flashing, you may be out of the coverage area of this network.

Dialling a new network

Note: This feature is only available for radios with alphanumeric keys.

- 1 Dial ***700#** to display the name of the current trunked network.
- 2 Dial ***70n#** to change to a new network, where **n** is the number of the new network.

The radio will restart, and display a power-up message followed by the name of the new network.

- 3 Check that the amber LED is glowing and the network symbol  appears in the display. If the amber LED and network symbol keep flashing, you may be out of the coverage area of this network.

Making a preset call

The preset calls programmed for your radio may be to other radios, to PABX extensions or to PSTN numbers. To make a preset call from your radio, you may be able to either:

- use a programmed function key,
- use the Main menu,
- use your Quick Access menu, or
- dial the preset call using the alphanumeric keys.

Using a function key to make a preset call

Press the function key programmed to make the preset call you want.

The call details appear in the display. While the call is being setup, you can cancel the call by pressing **Clear**.

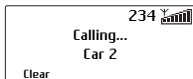

Using the Main menu to make a preset call

- 1 Select Menu>Preset calls.

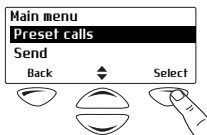

- 2 In the Preset Calls menu, scroll through the list of calls until the call you want appears.

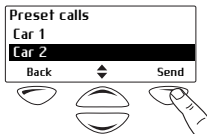

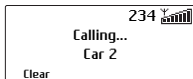

- 3 Press **Send**.

The call details appear in the display. While the call is being setup, you can cancel the call by pressing **Clear**.



Using your Quick Access menu to make a preset call

- 1 Press the left selection key  or one of the scroll keys  or  to enter the Preset Calls menu.
- 2 Scroll through the list of names until the you want appears.

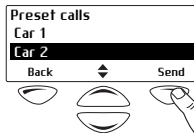

- 3 Press **Send**.

The call details appear in the display. While the call is being setup, you can cancel the call by pressing **Clear**.

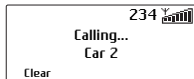

Dialling a preset call

Note: This feature is only available for radios with alphanumeric keys.

The preset calls programmed for your radio can be dialled if you know the number associated with the preset call.

To dial a preset call:

- 1 Dial **p**, where **p** is the number of the preset call.

If your preset call number is the same as a call to another radio, then you need to dial a leading **0**. For example, dial **23#** to call radio 23 and dial **023#** for preset call number 23.

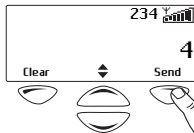

- 2 Press **Send** or the **#** or PTT key.

The call details appear in the display. While the call is being setup, you can cancel the call by pressing **Clear**.

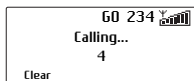

About talkgroups and scan groups

A trunked radio system may consist of a many fleets of radios, each with a number of talkgroups and scan groups.

A talkgroup consists of radio users either within the same fleet, or across multiple fleets. A scan group is a group of talkgroups.

When your radio belongs to a talkgroup or scan group, it is said to be "subscribed", and you receive all calls directed to that group of users.

The diagram below shows a typical trunked radio system with fleets, talkgroups and a scan group.

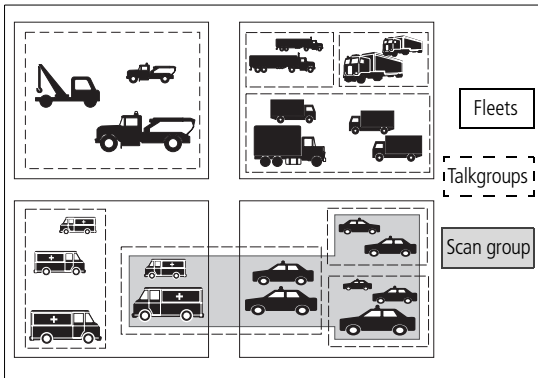

Making a talkgroup call

To make a talkgroup call, you may be able to either:

- use the Main menu, or
- dial the talkgroup call using the alphanumeric keys.

Using the Main menu to make a talkgroup call

- 1 Select Menu>Call groups.

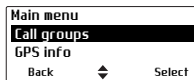

- 2 In the Call Groups menu, scroll through the list of talkgroups until the talkgroup you want appears.

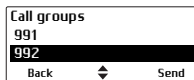

Note: Scan groups do not appear in this list, as it is not possible to call a scan group.

- 3 Press **Send** to call the talkgroup.

The call details appear in the display. While the call is being setup, you can press **Clear** to cancel the call.

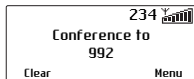

Dialling a talkgroup call

Note: This feature is only available for radios with alphanumeric keys.

The way you dial talkgroup calls depends on the dialling scheme your network uses. See [“Dialling calls in MPT trunked mode” on page 77](#) for more information on different ways to dial talkgroup calls.

- 1 Dial **g**, where **g** is the number associated with the talkgroup.
- 2 Press **Send** or the **#** or PTT key.

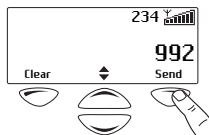

The call details appear in the display. While the call is being setup, you can press **Clear** to cancel the call.

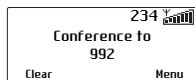

Changing group membership

There are two methods of changing your membership of talkgroups or scan groups. You may be able to either:

- use your Quick Access menu to join a single talkgroup or scan group, or
- use the Main menu to change your membership of multiple groups.

Selecting a new group using your Quick Access menu

You may be able to use your Quick Access menu to select a new talkgroup or scan group. Selecting a new group means that the previously selected group is automatically deselected.

To select a talkgroup or scan group:

- 1 Press the left selection key  to enter the Groups menu.

The currently selected talkgroup or scan group has + beside it.

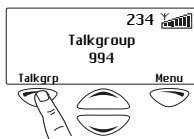

- 2 Scroll through the list of groups, until the talkgroup or scan group you want to select appears.

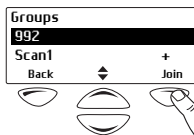

- 3 Press **Join** or wait for three seconds.

The previous group is deselected and the new talkgroup ID may appear in the display.

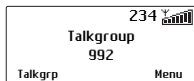

To make a call to the talkgroup shown, you may be able to briefly press the PTT key.

Note: It is not possible to make a call to a scan group, but you can call any of its constituent groups.

Changing group membership using the Main menu

Your radio may be programmed with permanent or user-selectable talkgroups and scan groups. If any talkgroup or scan group is user-selectable, you can choose to unsubscribe from that group or subscribe to it.

To change your group membership:

- 1 Select Menu > Group select > Edit groups.

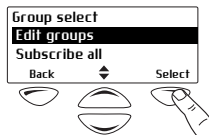

- 2 In the Groups menu, scroll through the list of groups. In the Groups list, the group membership status of a group is shown in the following way:

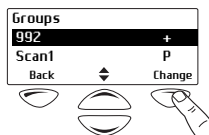

- a + symbol shows that you are currently a member of the group. Note that if you are a member of a scan group, all the members of the scan group also have a + beside them.
 - a P symbol shows that this is a permanent group whose membership cannot be changed.
 - If there is no symbol beside the group, then the radio is currently unsubscribed from this group.
- 3 Press **Change** and the + beside the group is either added or removed.
 - 4 When you have made the required changes in the Groups list, press **Back** to exit the Groups menu.

The new group ID may appear in the display, or if more than one group has been selected, the display shows **Multi**.

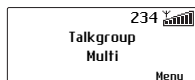

Subscribing or unsubscribing to all groups

To either subscribe or unsubscribe to all user-selectable talkgroups and scan groups:

- 1 Select Menu>Group select>Subscribe all.

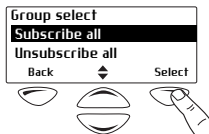

The message **Subscribed to all groups** briefly appears in the display, and your display may now show that you are subscribed to all programmed groups.

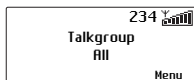

- 2 Select Menu>Group select>Unsubscribe all.

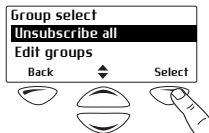

- 3 Press **OK** when you are prompted to confirm your selection.

The message **Unsubscribed from all groups** briefly appears in the display, and your display may now show that you are not subscribed to any groups.

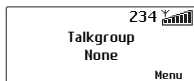
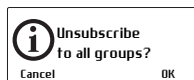

Making an emergency call

In an emergency you may be able to summon help by sending an emergency call.

On most networks, an emergency call takes precedence over other call types, and existing calls are cleared down so that the emergency call can proceed.

To make an emergency call from your radio, you may be able to either:

- make a preset emergency call,
- dial the emergency call using the alphanumeric keys.

After making the call, your radio may be programmed to enter emergency mode. While emergency mode is active, your radio may cycle between receive and transmit, so that your dispatcher or the called party can hear any activity near your radio.

To activate emergency mode, you may be able to:

- use a function key programmed for emergency mode, or
- use a hidden switch.

Making a preset emergency call

To make a preset emergency call from your radio, you may be able to either use a programmed function key, use the main menu, or use your quick access menu.

- 1 Select your preset emergency call.
See "[Making a preset call](#)" on page 55.

- 2 Press **Send**.

An emergency call is now sent to the emergency location that has been programmed for your radio.

Dialling an emergency call

Note: This feature is only available for radios with alphanumeric keys.

- 1 Dial ***9**.
- 2 Press **Send** or the  or PTT key.

An emergency call is now sent to the emergency location that has been programmed for your radio.

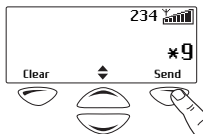

Note: If you wish to send an emergency call to another radio, you may be able to dial ***9*n** then press the  or PTT key. In this case, **n** is the radio unit number you wish to send the emergency call to and may be a two- or three-digit number.

Activating emergency mode

You can activate emergency mode using a function key programmed for emergency mode. Alternatively, you may be able to activate emergency mode using a hidden switch or panic button.

Note: The emergency function key may be programmed for either a short key press or long key press.

Once emergency mode is activated, your radio makes an emergency call to your dispatcher or some other predetermined location. The radio then enters emergency mode. While emergency mode is active, your radio may cycle between receive and transmit, so that your dispatcher can hear any activity near the radio.

Cancelling emergency mode

Reset the radio to normal operation at any time by turning the radio off and then on.

Emergency mode may be programmed to end after a fixed period of time. In this case, there is no need to turn the radio off and then on in order to return the radio to normal operation.

Dialling a PABX number

Note: This feature is only available for radios with alphanumeric keys.

- 1 Dial **n**, where **n** is the PABX extension you wish to call.
- 2 Press **Send** or the **#** or PTT key.

The call details appear in the display. While the call is being setup, you can cancel the call by pressing **Clear**.

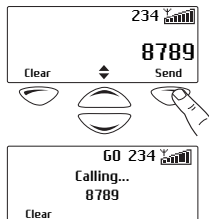

Dialling a PSTN number

Note: This feature is only available for radios with alphanumeric keys.

- 1 Dial **0n**, where **n** is the PSTN number you wish to call.

Note: The numbers you dial before the 0 depend on the way your network operates.

- 2 Press **Send** or the **#** or PTT key.

The call details appear in the display. While the call is being setup, you can cancel the call by pressing **Clear**.

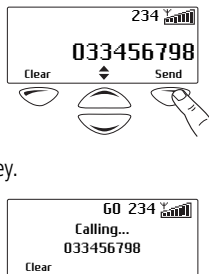

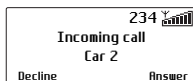

Receiving a call

When you receive a call, your radio displays the caller's identity and responds in one of two ways, depending on the way it was programmed and the way your network operates.



- On-air call setup: The radio gives a ring and automatically accepts the call. The  symbol appears in the display.
- Full off-air call setup (FOACSU): When a call is received, the radio rings like a telephone.

To accept the call, press **Answer**. The radio gives a beep and the  symbol appears in the display. You may also be able to accept the call if you briefly press the PTT key or lift the microphone or hand-held control head off the clip.

Once the  symbol appears, you can proceed with the call, as follows:

- 1 Hold the microphone about 5 cm (2 inches) from your mouth.
- 2 Press and hold the PTT key to transmit.
- 3 Speak clearly into the microphone and release the PTT key when you have finished talking.

While you are transmitting, the red LED glows and the transmit symbol  appears in the display.

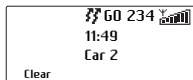

- 4 End the call by placing your microphone back onto its hook or by pressing **Clear**. The network may also end the call if neither you nor the other party transmits for a predetermined time or if your call time limit is exceeded.

Transmit timer

Your radio may have a transmit timer that limits the amount of time you can transmit continuously.

When the transmit timer is about to expire, the message **Transmit**

timeout imminent appears in the display, the red LED flashes and the radio gives three beeps.

If the transmit timer times out, the call clears down.

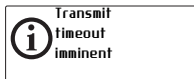

Call time limit

In MPT trunked mode, the length of your call may be limited by the network or by your radio. Your radio may be programmed to display the time remaining for your call.

When your call time is about to expire, the message **Call timeout** appears in the display, the red LED

flashes and the radio gives a repeated beep.

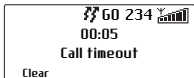

Re-establishing a call

The last number recall, unanswered call and callback functions allow you to re-establish calls using the PTT key.

Last number recall

When an outgoing call has ended, the message **Last call to** and the called unit's identity may appear on the display.

To make a call to that person again, briefly press the PTT key.

Unanswered call

When an incoming call is missed, the message **Missed call** and the caller's identity may appear in the display.

To return the call, briefly press the PTT key.

Callback

When an incoming call has been ended, the message **Last call from** and the caller's identity may appear in the display.

To make a call to that person, briefly press the PTT key.



Checking missed calls

If you have missed an incoming call, it may be stored in the call queue, so that you can return the call later. Information about the last missed call is shown in the display and the queued call symbol  appears.

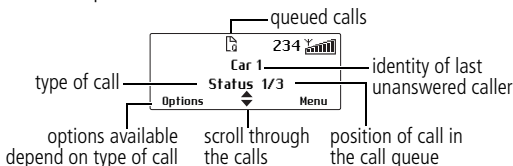
In the example below, the last call received was a status message from Car 1. This call is the first of three calls stored in the call queue.



Accessing the call queue

- 1 Use the scroll keys  or  to move through the calls in the call queue until the call you want appears.
- 2 Press **Options** to open the call options menu.

The options available for the call depend on the type of call it is. If the call is a voice call, select **Call**

to return the call or **Delete** to delete the call.

If the call is a status message or a text message, then select **View** to read the message.

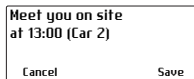
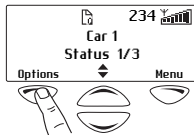

Changing your call queuing setting

Your radio may be programmed so that you are able to change call queuing to “unanswered”. Unanswered call queuing means that all status and text messages are immediately queued. Incoming voice calls are only queued if they are unanswered. An unanswered call is one that is ended by the radio making the call before the radio receiving the call has responded in any way.

If your radio has alphanumeric keys, you may be able to change your call queuing setting using the keypad.

To activate call queuing:

- select Menu>Radio settings>Call settings>Call queuing and choose **On**, or
- dial ***48** then press the (#) or PTT key.

The message **Call queuing activated** appears.

To change call queuing to unanswered call queuing:

- select Menu>Radio settings>Call settings>Call queuing and choose **Off**, or
- dial **#48** then press the (#) or PTT key.

The message **Call queuing deactivated** appears.

About status messages

A status message is sent to another party to indicate your current activity or location, such as "en route" or "at lunch". If the radio receiving your message has been programmed with the same status messages, it will decode and display your message. If you receive a status message, the message is automatically queued, since a response is not expected.

Selecting a status message

- 1 Select Main>Send>Status.

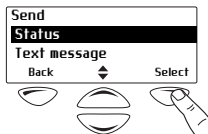

- 2 In the Status menu, scroll through the list of status messages until the message you want appears.

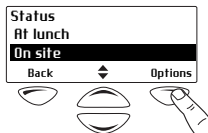

Sending a status message

- 1 When you have chosen a message, press **Options** and the Send To menu opens.

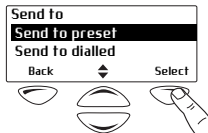

- 2 In the Send To menu, scroll through the list of options until the choice you want appears.

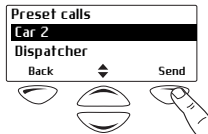

Note: If your radio has alphanumeric keys, you can choose the option **Send to dialled**, then dial the number of the party you wish to call.

3 Press **Send**.

The call details appear in the display. While the call is being setup, you can cancel the call by pressing **Clear**.

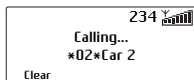

Dialling a status message

Note: This feature is only available for radios with alphanumeric keys.

The status messages programmed for your radio can be dialled if you know the number associated with the status message.

To dial a status message:

- 1 Dial ***0s*n**, where **s** is the number of the status message and **n** is the radio unit number you wish to send the message to.

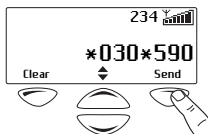

- 2 Alternatively, dial ***0s*p**, where **p** is the number of a preset call. See ["Dialling a preset call"](#) on page 56 for more information.
- 3 Press **Send** or the **#** or PTT key.

The call details appear in the display. While the call is being setup, you can cancel the call by pressing **Clear**.

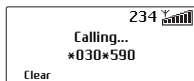

About text messages



Your radio may be programmed so that you can send text messages. There are three options for creating text messages:

- selecting a preset text message,
- editing a preset text message, or
- creating a new text message.











Note: To either edit or enter a text message, your radio must have alphanumeric keys.

Using the alphanumeric keys to enter text

When the alphanumeric keys are used to enter a text message, they have special functions.

- Use  key to toggle between upper and lower case characters.
- Use  to delete a character from the display.

Repeated presses of these keys will give you the characters shown in the following table.

Key	Characters	Key	Characters
	. , ? ! 1		P Q R S 7
	A B C 2		T U V 8
	D E F 3		W X Y Z 9
	G H I 4		space 0
	J K L 5		*
	M N O 6		

Selecting a preset text message

- 1 Select Menu>Send>Text message>Preset message.

In the Preset Message menu, a short label representing each message is displayed.

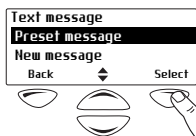

- 2 Scroll through the list of preset message labels until the one you want appears.

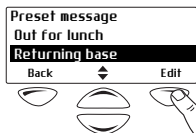

- 3 Select **Edit**, and the complete text message you have chosen is now displayed.

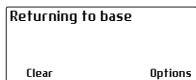

Editing a preset text message

- 1 Select Menu>Send>Text message>Preset message.

In the Preset Message menu, a short label representing each message is displayed.

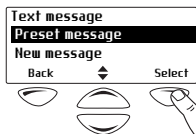

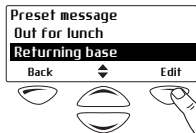

- 2 Scroll through the list of preset message labels until the one you want appears.

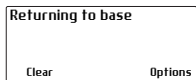

- 3 Press **Edit**, and the complete text message you have chosen is now displayed.



- 4 Use the scroll keys  or  to move through the characters.

Use the alphanumeric keys to add characters and the **Clear** key to delete them. The message can be up to 100 characters long.

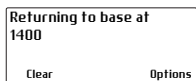

Creating a new text message

- 1 Select Menu>Send>Text message>New message.
The last text message you sent may be displayed.

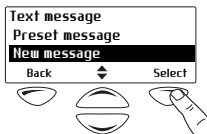

- 2 In the New Message menu, modify the last text message you sent, or enter the new text message using the alphanumeric keys. The message can be up to 100 characters long.

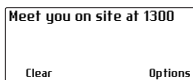

Sending a text message

- 1 When you have chosen or entered a message, press **Options** and the Send To menu opens.
- 2 In the Send To menu, scroll through the list of options until the choice you want appears.

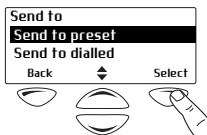

If your radio has alphanumeric keys, you can choose the option **Send to dialled**, then dial the number of the party you wish to call.

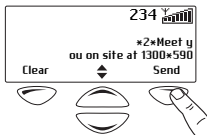

- 3 Press **Send**.

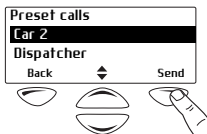

The call details appear in the display. While the call is being setup, you can cancel the call by pressing **Clear**.

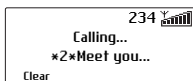

Calls to conventional channels or groups

You may be able to dial conventional channels or groups, using **101** to **110**. The channels or groups called using these numbers are programmed for your radio.

To call a conventional channel or group:

- 1 Dial the number for the channel or group you wish to call.
- 2 Press **Send** or the  or PTT key.

Your radio switches to the conventional channel programmed for that number.

Dialling calls in MPT trunked mode

If your radio has alphanumeric keys, you can make dialled calls from your radio. The numbers you dial and dialling features available depend on the way your radio is programmed and the way your network operates. Contact your radio provider for further assistance.

The following topics are covered in this section:

- [MPT 1343 dialling](#)
- [Nokia ANN fleet calls](#)
- [accessing common MPT trunking functions](#)

MPT 1343 dialling

If your MPT trunked network uses the MPT 1343 dialling scheme, your radio's unique number on the network consists of:

- a three-digit prefix,
- a four-digit fleet number, and
- a two- or three-digit radio unit number.

You may also be part of a group, with a two- or three-digit group number.

Finding your radio's MPT number

To find your radio's full MPT number:

- 1 Dial ***700**.
- 2 Press the  or PTT key.

The name associated with your network and your radio's full MPT number appears.

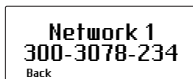

The number is in the form:

Prefix 300	Fleet 3078	Radio unit number 234
---------------	---------------	--------------------------

MPT 1343 dialled calls

The following table summarizes the way you dial calls to other radios and groups of radios and gives an example of each type of call.

Note: In the following examples, the final # may be replaced by a short press of the PTT key.

Call to	Dialling code and example			
Radio 23 in the same fleet as you	Radio unit number 23		#	
Radio 234 in the same fleet as you	Radio unit number 234		#	
Radio 23 in fleet 3078 with the same prefix as you	Fleet 3078	Radio unit number 23	#	
Radio 234 in fleet 3078 with the same prefix as you	Fleet 3078	Radio unit number 234	#	
Radio 234 in fleet 3078 with a different prefix to you (300)	Prefix 300	Fleet 3078	Radio unit number 234	#
Group 92 in the same fleet as you	Group 92		#	
Group 923 in the same fleet as you	Group 923		#	

Nokia ANN fleet calls

If your MPT trunked network uses Nokia ANN dialling, the numbers you dial depend on your fleet size. Fleets are defined as either large, small or mini. Your radio's unique number on the network consists of:

- a lead number **7, 8 or 9**, depending on the fleet size,
- a zero-, one-, two- or three-digit prefix,
- a one- or two-digit fleet number, and
- a two- or three-digit radio unit number.

Note: See your radio provider or network administrator for Nokia ANN call details.

Finding your radio's MPT number

To find your radio's full MPT number:

- 1 Dial ***700**.
- 2 Press the **#** or PTT key.

The name associated with your network and your radio's full MPT number appears.



The number is in the form:

Lead 7	Prefix 34	Fleet 2	Radio unit number 209
-----------	--------------	------------	--------------------------

Nokia ANN dialled calls

The following table summarizes the way you dial calls to other radios and gives an example of each type of call.

Note: In the following dialled numbers, the # terminator is not necessary if you press the **PTT** key instead.

Call to	Dialling code and example				
Radio 23 in the same fleet as you	Radio unit number 23		#		
Group 923 in the same fleet as you	Group 923	#			
Large fleet:					
Call to radio 234 in fleet 1 with the same prefix as you	Lead 7	Fleet 1	Radio unit number 234	#	
Call to radio 235 in fleet 2 with a different prefix to you (32)	Lead 7	Prefix 32	Fleet 2	Radio unit number 235	#
Small fleet:					
Call to radio 23 in fleet 51 with the same prefix as you	Lead 7	Fleet 51	Radio unit number 23	#	
Call to radio 23 in fleet 52 with a different prefix to you (126)	Lead 7	Prefix 126	Fleet 52	Radio unit number 23	#
Mini fleet:					
Call to radio 23 in fleet 80 with the same prefix as you	Lead 7, 8 or 9	Fleet 80	Radio unit number 23	#	
Call to radio 23 in fleet 81 with a different prefix to you (3)	Lead 7, 8 or 9	Prefix 3	Fleet 81	Radio unit number 23	#

Accessing common MPT trunking functions

The following tables explain how you can access special MPT trunking functions using the * and # keys. The availability of these functions is dependant on the way your radio is programmed and the way your network operates.

Note: In the following examples, the final # may be replaced by a short press of the PTT key.

*... # functions

Dialling code	Functions	Example
#	Accept an incoming FOACSU call	
*#	Clear call or displayed item, or decline an incoming FOACSU call	
*0#	Request base dispatcher to call you back	
#0#	Cancel request	
*0*n#	Request another dispatcher to call you back	*0*234#
#0*n#	Cancel request	#0*234#
*0s*n#	Status call (s = status 1 to 30) to radio n	*015*23#
*0s#	Status call to dispatcher	*015#
*1*g#	Conference call to group g	*1*92#
*11*g#	Broadcast call to group g	*11*92#
*31*n#	Non-prescribed data call	*31*23#
*41*n#	Divert own calls to radio n	*41*23#
#41#	Cancel divert	
*41*0n#	Divert own calls to PSTN n	*41*03456798#
#41#	Cancel divert	
*44*n*m#	Divert 3rd party calls n to m	*44*23*21#
#44*n#	Cancel divert of 3rd party calls	#44*23#

*... # functions

Dialling code	Functions	Example
*48#	Queue incoming calls	
#48#	Cancel queue	
*49#	Do not disturb	
#49#	Cancel do not disturb	
*491#	Do not disturb - voice calls only	
#491#	Cancel do not disturb, voice calls only	
*492#	Do not disturb - data calls only	
#492#	Cancel do not disturb, data calls only	
*50*n#	Select channel n (site-select diagnostic function, enabled during programming)	
#50#	Resume normal channel hunting (site-select diagnostic function, enabled during programming)	
*700#	Display your MPT number and current network	
*70n#	Change to network n (1 to 4)	*702#
*8*n#	Priority call to radio n	*8*23#
*8*1*g#	Priority conference call to group g	*8*1*923#
*9*n#	Emergency call to radio n	*9*23#
*9*1*g#	Emergency conference call to group g	*9*1*92#
**n#	Abbreviated dialled codes (1-49)	**3#

Troubleshooting

The following topics are covered in this section:

- [when your radio won't turn on](#)
- [removing the microphone](#)
- [reinstalling the microphone](#)
- [removing the radio from the vehicle](#)
- [describing the radio's audible tones](#)

When your radio won't turn on

If the red, green and amber LEDs on the control head do not light up when the radio is turned on, it is likely that no power is reaching the radio. Check the following:

- Is the power connector firmly plugged into the rear of the radio?
- Are the in-line fuses in good condition?
- Is the power cable securely connected to the vehicle battery or power supply?

If all appears to be in order, then contact your radio provider for further assistance.

Removing the microphone

- 1 Using your thumb or forefinger, lift up one of the corners of the microphone grommet. Firmly (but gently) pull that corner until the seal comes away from the cavity.
- 2 Repeat to expose another corner.
- 3 Pull the exposed corners back and slide the grommet up the microphone cable to reveal the microphone plug.
- 4 Remove the plug from the microphone socket.

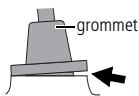

Reinstalling the microphone

Caution: The microphone grommet must be installed whenever the microphone is plugged into the microphone socket.

- 1 Plug the microphone into the microphone socket.
- 2 Slide the microphone grommet along the microphone cord and push two adjacent corners of the grommet into the microphone socket cavity.
- 3 Squeeze the grommet and push the remaining corners into position.
- 4 Check that the grommet is seated correctly in the cavity.

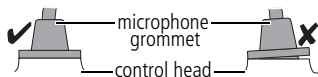

Removing the radio from the vehicle

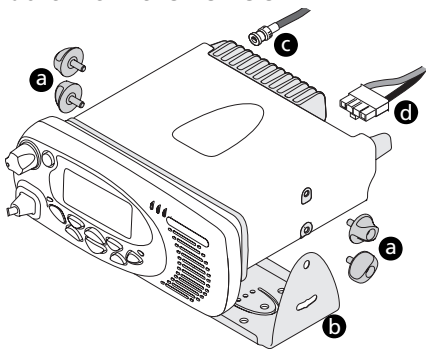

- 1 Switch off the radio.
- 2 Unscrew the four thumb screws **a** that secure the radio to the U-bracket **b**.
- 3 Carefully lift the radio clear of the U-bracket.
- 4 Disconnect the antenna **c** and power cable **d** from the rear of the radio.

Describing the radio's audible tones

The following table summarizes the radio's audible tones.

Action and tone	Meaning
two short beeps	Radio turned on: the radio is powered on and ready to use
one short beep after the power-up beeps	Radio locked: you need to enter your personal identity number (PIN) before you can use the radio
one long, low-pitched beep	Radio PIN entry unsuccessful: you need to re-enter your PIN
two short beeps	Radio PIN entry successful: the radio is now ready to use
one short beep	Function activated: a function key has been pressed and that function has been initiated
one short, low-pitched beep	Function deactivated: a function key has been pressed and the corresponding function has been turned off
one long, low-pitched beep	Invalid key press: the action you have attempted is not permitted, or Transmission inhibited: you have attempted to transmit but for some reason transmission is not permitted at this time
one short, high-pitched beep	Radio is stunned: the radio has been made inoperable by your service provider
two short beeps	Radio is revived: the radio has been made operable by your service provider
three beeps	Transmit timeout imminent: in 10 seconds your transmit timer will expire and your current transmission will be terminated
one high-pitched beep	Call timeout imminent: your call time is about to expire (MPT trunked mode only)
two low-pitched beeps	Radio's temperature is high: the radio's temperature is in the high-temperature range, but the radio will continue to operate

Action and tone	Meaning
two high-pitched beeps	Radio's temperature is very high: the radio's temperature is in the very high temperature range and all transmissions will now be at low power; if the radio's temperature rises outside this range, transmissions will be inhibited
continuous low-pitched tone	Radio system error: a system error has occurred and the radio may be inoperable
two long low-high pitched tone pairs	Synthesizer is out-of-lock: the radio's synthesizer is out-of-lock on the current channel and you cannot operate on that channel

Tait general software licence agreement

This legal document is an Agreement between you (the "Licensee") and Tait Electronics Limited ("Tait"). By using any of the Software or Firmware items prior-installed in the related Tait product, included on CD or downloaded from the Tait website, (hereinafter referred to as "the Software or Firmware") you agree to be bound by the terms of this Agreement. If you do not agree to the terms of this Agreement, do not install and use any of the Software or Firmware. If you install and use any of the Software or Firmware that will be deemed to be acceptance of the terms of this licence agreement. The terms of this Agreement shall apply subject only to any express written terms of agreement to the contrary between Tait and the Licensee.

Licence

TAIT GRANTS TO YOU AS LICENSEE THE NON-EXCLUSIVE RIGHT TO USE THE SOFTWARE OR FIRMWARE ON A SINGLE MACHINE PROVIDED YOU MAY ONLY:

- 1 COPY THE SOFTWARE OR FIRMWARE INTO ANY MACHINE READABLE OR PRINTED FORM FOR BACKUP PURPOSES IN SUPPORT OF YOUR USE OF THE PROGRAM ON THE SINGLE MACHINE (CERTAIN PROGRAMS, HOWEVER, MAY INCLUDE MECHANISMS TO LIMIT OR INHIBIT COPYING, THEY ARE MARKED "COPY PROTECTED"), PROVIDED THE COPYRIGHT NOTICE MUST BE REPRODUCED AND INCLUDED ON ANY SUCH COPY OF THE SOFTWARE OR FIRMWARE;
AND / OR
- 2 MERGE IT INTO ANOTHER PROGRAM FOR YOUR USE ON THE SINGLE MACHINE (ANY PORTION OF ANY SOFTWARE OR FIRMWARE MERGED INTO ANOTHER PROGRAM WILL CONTINUE TO BE SUBJECT TO THE TERMS AND CONDITIONS OF THIS AGREEMENT).

THE LICENSEE MAY NOT DUPLICATE, MODIFY, REVERSE COMPILER OR REVERSE ASSEMBLE ANY SOFTWARE OR FIRMWARE IN WHOLE OR PART.

Important Notice

THE SOFTWARE OR FIRMWARE MAY CONTAIN OPEN SOURCE SOFTWARE COMPONENTS ("OPEN SOURCE

COMPONENTS"). OPEN SOURCE COMPONENTS ARE EXCLUDED FROM THE TERMS OF THIS AGREEMENT EXCEPT AS EXPRESSLY STATED IN THIS AGREEMENT AND ARE COVERED BY THE TERMS OF THEIR RESPECTIVE LICENCES WHICH MAY EXCLUDE OR LIMIT ANY WARRANTY FROM OR LIABILITY OF THE DEVELOPERS AND/OR COPYRIGHT HOLDERS OF THE OPEN SOURCE COMPONENT FOR THE PERFORMANCE OF THOSE OPEN SOURCE COMPONENTS. YOU AGREE TO BE BOUND BY THE TERMS AND CONDITIONS OF EACH SUCH LICENCE. FOR MORE INFORMATION SEE: <http://support.taitworld.com/go/opensource>

Title to Software

THIS AGREEMENT DOES NOT CONSTITUTE A CONTRACT OF SALE IN RELATION TO THE SOFTWARE OR FIRMWARE SUPPLIED TO THE LICENSEE. NOTWITHSTANDING THE LICENSEE MAY OWN THE MAGNETIC OR OTHER PHYSICAL MEDIA ON WHICH THE SOFTWARE OR FIRMWARE WAS ORIGINALLY SUPPLIED, OR HAS SUBSEQUENTLY BEEN RECORDED OR FIXED, IT IS A FUNDAMENTAL TERM OF THIS AGREEMENT THAT AT ALL TIMES TITLE AND OWNERSHIP OF THE SOFTWARE OR FIRMWARE, WHETHER ON THE ORIGINAL MEDIA OR OTHERWISE, SHALL REMAIN VESTED IN TAIT OR THIRD PARTIES WHO HAVE GRANTED LICENCES TO TAIT.

Term and Termination

THIS LICENCE SHALL BE EFFECTIVE UNTIL TERMINATED IN ACCORDANCE WITH THE PROVISIONS OF THIS AGREEMENT. THE LICENSEE MAY TERMINATE THIS LICENCE AT ANY TIME BY DESTROYING ALL COPIES OF THE SOFTWARE OR FIRMWARE AND ASSOCIATED WRITTEN MATERIALS. THIS LICENCE WILL BE TERMINATED AUTOMATICALLY AND WITHOUT NOTICE FROM TAIT IN THE EVENT THAT THE LICENSEE FAILS TO COMPLY WITH ANY TERM OR CONDITION OF THIS AGREEMENT. THE LICENSEE AGREES TO DESTROY ALL COPIES OF THE SOFTWARE OR FIRMWARE AND ASSOCIATED WRITTEN MATERIALS IN THE EVENT OF SUCH TERMINATION.

Limited Warranty

THE SOFTWARE OR FIRMWARE (INCLUDING OPEN SOURCE COMPONENTS) IS SUPPLIED BY TAIT AND ACCEPTED BY THE LICENSEE "AS IS" WITHOUT

WARRANTY OF ANY KIND EITHER EXPRESSED OR IMPLIED, INCLUDING BUT NOT BEING LIMITED TO ANY IMPLIED WARRANTIES AS TO MERCHANTABILITY OR FITNESS FOR ANY PARTICULAR PURPOSE. THE LICENSEE ACKNOWLEDGES THAT THE SOFTWARE OR FIRMWARE (INCLUDING OPEN SOURCE COMPONENTS) IS USED BY IT IN BUSINESS AND ACCORDINGLY TO THE MAXIMUM EXTENT PERMITTED BY LAW NO TERMS OR WARRANTIES WHICH ARE IMPLIED BY LEGISLATION SHALL APPLY TO THIS AGREEMENT. TAIT DOES NOT WARRANT THAT THE FUNCTIONS CONTAINED IN THE SOFTWARE OR FIRMWARE (INCLUDING OPEN SOURCE COMPONENTS) WILL MEET THE LICENSEE'S REQUIREMENTS OR THAT THE OPERATION OF THE SOFTWARE OR FIRMWARE (INCLUDING OPEN SOURCE COMPONENTS) WILL BE UNINTERRUPTED OR ERROR FREE.

Exclusion of Liability

IN NO CIRCUMSTANCES SHALL TAIT BE UNDER ANY LIABILITY TO THE LICENSEE, OR ANY OTHER PERSON WHATSOEVER, WHETHER IN TORT (INCLUDING NEGLIGENCE), CONTRACT (EXCEPT AS EXPRESSLY PROVIDED IN THIS AGREEMENT), EQUITY, UNDER ANY STATUTE, OR OTHERWISE AT LAW FOR ANY LOSSES OR DAMAGES WHETHER GENERAL, SPECIAL, EXEMPLARY, PUNITIVE, DIRECT, INDIRECT OR CONSEQUENTIAL ARISING OUT OF OR IN CONNECTION WITH ANY USE OR INABILITY OF USING THE SOFTWARE OR FIRMWARE (INCLUDING OPEN SOURCE COMPONENTS).

THE LICENSEE'S SOLE REMEDY AGAINST TAIT WILL BE LIMITED TO BREACH OF CONTRACT AND TAIT'S SOLE AND TOTAL LIABILITY FOR ANY SUCH CLAIM SHALL BE LIMITED AT THE OPTION OF TAIT TO THE REPAIR OR REPLACEMENT OF THE SOFTWARE OR FIRMWARE OR THE REFUND OF THE PURCHASE PRICE OF THE SOFTWARE OR FIRMWARE.

General

THE LICENSEE CONFIRMS THAT IT SHALL COMPLY WITH THE PROVISIONS OF LAW IN RELATION TO THE SOFTWARE OR FIRMWARE.

Law and Jurisdiction

THIS AGREEMENT SHALL BE SUBJECT TO AND CONSTRUED IN ACCORDANCE WITH NEW ZEALAND LAW AND DISPUTES BETWEEN THE PARTIES CONCERNING THE PROVISIONS HEREOF SHALL BE DETERMINED BY THE NEW ZEALAND COURTS OF LAW. PROVIDED HOWEVER TAIT MAY AT ITS ELECTION BRING PROCEEDINGS FOR BREACH OF THE TERMS HEREOF OR

FOR THE ENFORCEMENT OF ANY JUDGEMENT IN RELATION TO A BREACH OF THE TERMS HEREOF IN ANY JURISDICTION TAIT CONSIDERS FIT FOR THE PURPOSE OF ENSURING COMPLIANCE WITH THE TERMS HEREOF OR OBTAINING RELIEF FOR BREACH OF THE TERMS HEREOF.

No Dealings

THE LICENSEE MAY NOT SUBLICENSE, ASSIGN OR TRANSFER THE LICENCE OR THE PROGRAM EXCEPT AS EXPRESSLY PROVIDED IN THIS AGREEMENT. ANY ATTEMPT OTHERWISE TO SUBLICENSE, ASSIGN OR TRANSFER ANY OF THE RIGHTS, DUTIES OR OBLIGATIONS HEREUNDER IS VOID.

No Other Terms

THE LICENSEE ACKNOWLEDGES THAT IT HAS READ THIS AGREEMENT, UNDERSTANDS IT AND AGREES TO BE BOUND BY ITS TERMS AND CONDITIONS. THE LICENSEE FURTHER AGREES THAT SUBJECT ONLY TO ANY EXPRESS WRITTEN TERMS OF AGREEMENT TO THE CONTRARY BETWEEN TAIT AND THE LICENSEE THIS IS THE COMPLETE AND EXCLUSIVE STATEMENT OF THE AGREEMENT BETWEEN IT AND TAIT IN RELATION TO THE SOFTWARE OR FIRMWARE WHICH SUPERSEDES ANY PROPOSAL OR PRIOR AGREEMENT, ORAL OR WRITTEN AND ANY OTHER COMMUNICATIONS BETWEEN THE LICENSEE AND TAIT RELATING TO THE SOFTWARE OR FIRMWARE.

www.taitworld.com

03/2008
MMA-00003-07

