

**EXHIBIT 4**  
**INSTRUCTION MANUAL (DRAFT)**

MAXIMUM HEAT!

TYCO®

OWNER'S MANUAL  
PLEASE READ THOROUGHLY BEFORE OPERATING YOUR VEHICLE



WILD STING

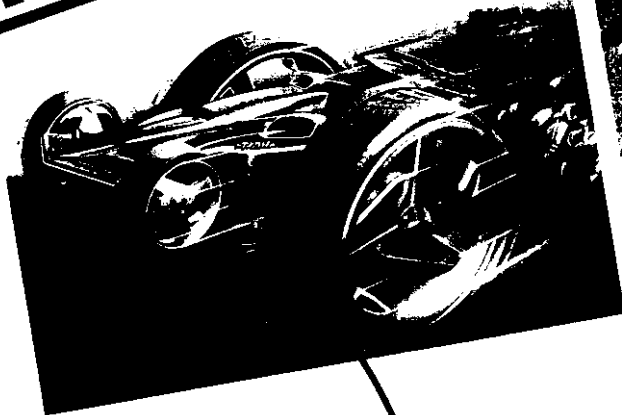

TYCO RC SERVICE CENTER

WE CARE!

If you have questions or difficulty operating this vehicle,  
**DO NOT RETURN IT TO THE STORE!**  
Call Toll-Free 1-888-557-TYCO (1-888-557-8926)  
for technical help, or **RAPID** parts and service assistance.

33394-1920  
MODEL NO. 33395 (Blue/Orange - 27 MHz)  
MODEL NO. 33396 (Orange/Yellow - 49 MHz)

FEATURES

- 9 functions
- Available in 2 frequencies (27 MHz and 49 MHz)
- 1/14 scale
- Range up to 65 feet

CONTENTS

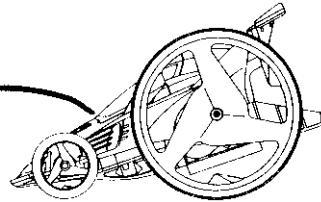

(1) TMH™ Power Psycho™ Vehicle

(1) Transmitter

Will be replaced "Wild Sting" pins.

TOP VIEW

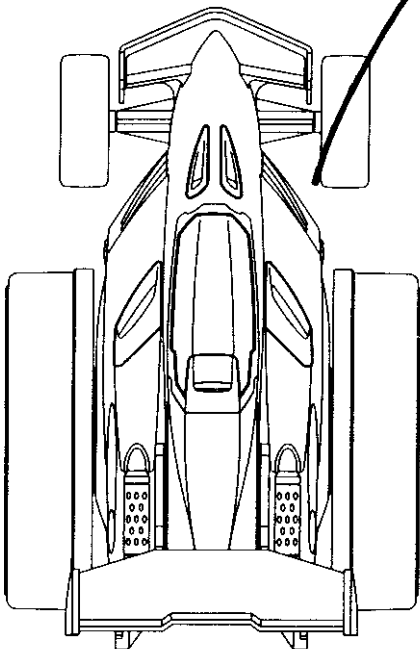

BOTTOM VIEW

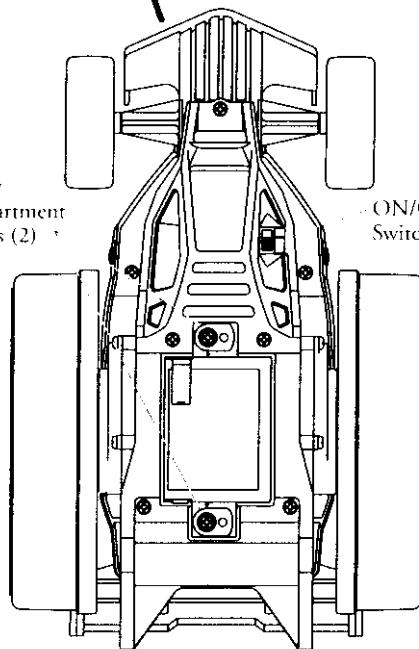

TRANSMITTER

NOTE: Your transmitter is equipped with a special automatic "ON" battery-saving feature. Just turn your vehicle "ON." Then push either transmitter stick and you will be able to run and control your vehicle.

Left Stick Controls Left Gyro Wheel  
Whip Antenna  
Right Stick Controls Right Gyro Wheel

Automatic "ON" Power Indicator Light

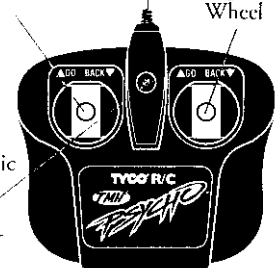

Refer to label on transmitter and vehicle for frequency. Do not race vehicles with the same frequency.

MATTEL WHEELS™

**BATTERY CHARGING/CARE***(BATTERIES AND CHARGER WILL INCLUDE IT)*

Your vehicle will not operate without the TYCO® R/C TMH™ FlexPak™ Battery Pack and 4 Hour Quick Charger, Stock No. 33005. The TMH™ FlexPak™ battery pack is designed for use exclusively in TYCO® R/C TMH™ power vehicles. It will not work in any 6.0V or 9.6V NiCd battery-powered vehicles.



TMH™ FlexPak™ Battery Pack and Charger (Stock No. 33005)



Additional TMH™ FlexPak™ Battery Pack (Stock No. 33003)

Have additional Battery Packs charged ahead of time for longer non-stop racing action. Uses the Stock No. 33005 TMH™ Quick Charger.

Your TMH FlexPak battery pack features a unique design (Patent Pending) which allows it to be configured in different ways for use in different R/C vehicles. This feature allows maximum vehicle performance and design flexibility. To configure your FlexPak battery pack for use in Psycho™, please refer to Step 2, "Battery Installation."

1. Plug the battery charger into standard 110/120 volt outlet.
2. Hold the battery pack fully open, with the metal contacts at the top, as shown. The labels marked "1" and "2" in the upper left-hand corner (and the words "Rechargeable Battery Pack" in #11) should be facing you. Now slide the battery pack securely into the charger.
3. To disconnect, push the red button on the side of the charger. Hold the red button down while you slide out the battery pack.
4. New battery packs must be charged for 5 1/2 hours the first two times charged. After that, subsequent charges will require only 4 hours.
5. After charging for 4 hours, the battery pack will feel warm. This is normal for fully charged batteries.
6. Charging the battery pack for more than 4 hours will not give you longer running time.
7. Unlike alkaline batteries, which lose power gradually, your TMH FlexPak battery will run for its normal running time, depending on your particular vehicle, and then lose most of its power at once. It is now time to recharge the battery pack.
8. Unlike NiCd (Nickel-Cadmium) rechargeable batteries, your TMH FlexPak battery pack may be recharged at any time, irrespective of the level of charge remaining in the battery: you do not have to wait until the battery pack is fully discharged to recharge it.
9. After use, the battery pack will be hot! Wait at least 20 minutes until the battery pack cools down before recharging. Recharging a hot battery pack will greatly reduce the number of times your battery pack can be recharged.

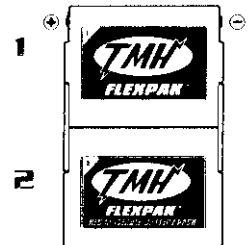
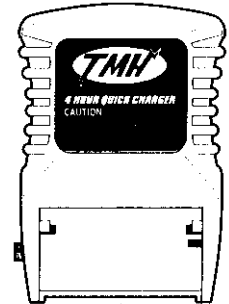
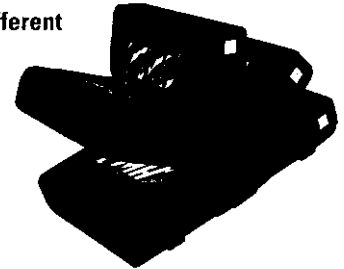
**BATTERY PACK CARE**

Because of its unique design, other battery chargers will be unable to charge your TMH FlexPak battery pack. To charge your battery pack, use only the TYCO R/C TMH FlexPak battery charger.

**CAUTIONS**

- DO NOT RECHARGE BATTERY PACK IF IT'S HOT. ALLOW IT TO COOL BEFORE RECHARGING.
- DO NOT CHARGE A BATTERY PACK THAT SHOWS LEAKAGE OR CORROSION.
- DO NOT DISASSEMBLE THE BATTERY PACK. THE BATTERY PACK IS A SEALED NiMH (NICKEL-METAL HYDRIDE) BATTERY.
- DO NOT DISPOSE OF THE BATTERY PACK IN FIRE.
- EXERCISE CAUTION IN HANDLING A HOT BATTERY PACK.
- IF BATTERY PACK AND/OR CHARGER ARE WET, THOROUGHLY DRY BEFORE CHARGING.

**SPECIAL NOTES TO ADULTS:**

- The battery charger is age-graded for ages 8 and over; the battery charger should not be operated in the presence of children under 8 years of age without adult supervision. Adult supervision is recommended.
- Regularly examine for damage to the plug, enclosure and other parts. In the event of any damage, the toy must not be used with the transformer until the damage has been repaired.
- This toy is not intended for children under 3 years old. The transformer is not a toy.

Unlike NiCd (Nickel-Cadmium) rechargeable batteries, your TMH FlexPak battery pack requires no special procedures or precautions for disposal. However, as with all products, you should dispose of your battery pack in an environmentally responsible and considerate manner.



# STEP 2

25min.

**Estimated run time for this vehicle: 25 minutes**

## TRANSMITTER

- 5. Install one 9-volt alkaline battery with polarity (+/-) as shown inside battery compartment.
- 6. The 9-volt transmitter battery will last much longer than the run time of the TMH FlexPak rechargeable battery pack.

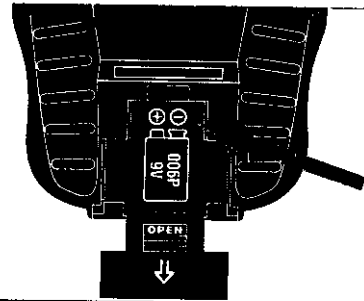

# STEP 3

## SPECIAL PSYCHO CONTROLS & DRIVING MODES

**NOTE:** When driving with the TMH FlexPak battery side up, you'll have to push both sticks down to drive forward.

**FORWARD**

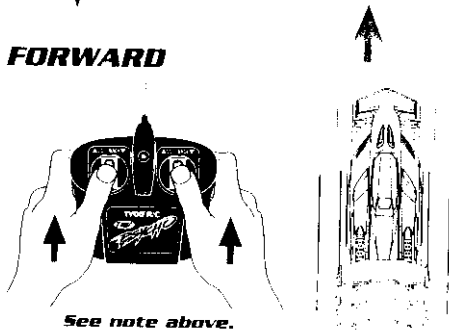

**REVERSE**

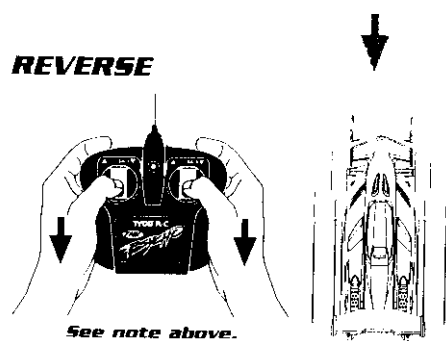

**LEFT TURN**

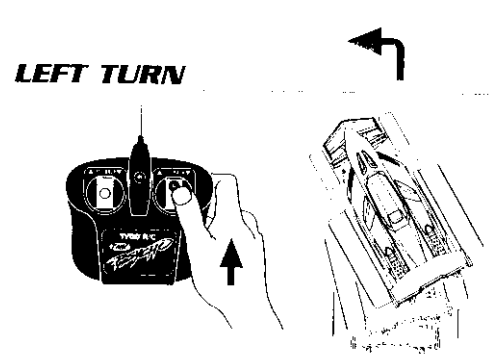

**RIGHT TURN**

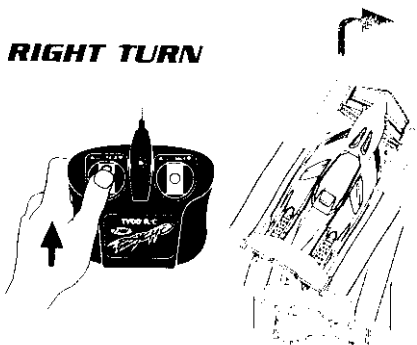

**TURBO 360° SPIN LEFT**

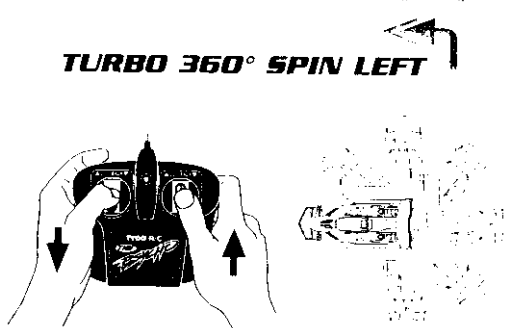

**TURBO 360° SPIN RIGHT**

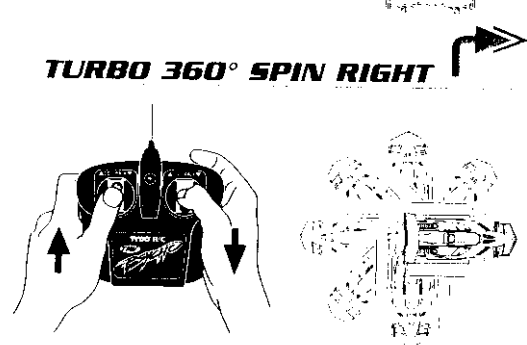

# STEP 4

## OPERATING YOUR VEHICLE

### Start-Up Instructions

This section is only a quick reference guide. Please read this entire manual thoroughly before operating your vehicle.

1. Give your TMH FlexPak battery pack a full 4-hour charge and then install in vehicle.
2. Turn vehicle switch "ON." Press either joystick and you will be able to run and control your vehicle.
3. After approximately 25 minutes of running, your vehicle will lose most of its power at once. The TMH FlexPak battery pack is near total power loss and needs to be recharged.
4. Turn vehicle switch "OFF."

### Tips & Hints

1. The radio circuitry in your vehicle and transmitter is sensitive. Do not store vehicle or transmitter near heat or in direct sunlight. After each use, remove any water or moisture from vehicle using a clean dry cloth. Avoid operating in snow.
2. Turn vehicle switch to the "OFF" position and remove battery pack when not in use.
3. When your vehicle runs erratically, the problem is usually the result of interference caused by high tension wires, CB radios, or other R/C vehicles running nearby on the same frequency as yours. You may have to choose an alternative place to race.

### Safety Precautions

Adults, this toy is recommended for children 5 years of age and older. To ensure that the child's play is both safe and fun, please review the operating instructions and these general safety rules with the child.

### Caution

- DO NOT pick up vehicle while in motion.
- Keep fingers, hair and loose clothing away from the tires and the wheel hubs while the vehicle is switched "ON."
- If this toy is being operated in the presence of children under 5 years of age, adult supervision is recommended.
- To avoid accidental operation, remove battery pack when not in use.

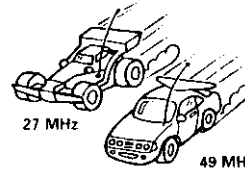

1. Radio interference is caused by the presence of another radio controlled vehicle operating on the same frequency as your vehicle. Obviously, multiple vehicles should NOT BE OPERATED ON THE SAME FREQUENCY at the same time. Only race 27 MHz vehicles against 49 MHz vehicles.

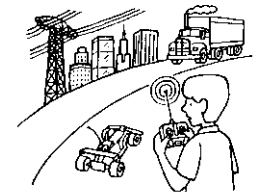

2. Radio interference can be caused by the operation of your vehicle near HIGH VOLTAGE ELECTRICAL WIRES, LARGE STEEL REINFORCED CONCRETE BUILDINGS and PASSING TRUCKS WITH CB RADIOS. Avoid these if possible.

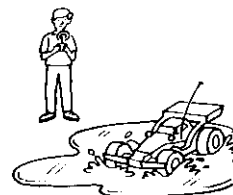

3. DO NOT operate your vehicle over wet surfaces. Water can damage the electronic assemblies.

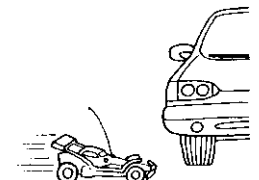

4. DO NOT operate your vehicle on streets! They are for real cars.

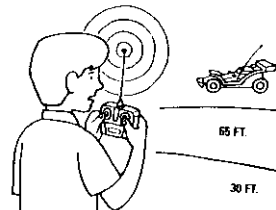

5. For best results, hold antenna up, not pointed down toward R/C vehicle. If you drive your vehicle TOO FAR AWAY FROM THE TRANSMITTER, your signal strength will become weak and vehicle will not function properly. The maximum range for the vehicle should be between 30 to 65 feet, when operating outdoors.

## TROUBLESHOOTING

## PROBLEM? - SOLUTIONS

SYMPTOM	PROBABLE CAUSE	CORRECTION
Vehicle runs slowly or will not run.	<ul style="list-style-type: none"> <li>Loose battery connection or vehicle switch not ON.</li> <li>Weak or uncharged rechargeable battery.</li> <li>Weak 9-volt transmitter battery.</li> </ul>	<ul style="list-style-type: none"> <li>Check battery connector and vehicle switch.</li> <li>Charge battery or replace.</li> <li>Replace with fresh 9-volt alkaline battery.</li> </ul>
Power indicator light on transmitter does not light when either joystick is activated.	<ul style="list-style-type: none"> <li>Transmitter battery weak or not connected.</li> </ul>	<ul style="list-style-type: none"> <li>Check connections and replace battery if required.</li> </ul>
Erratic operation or only short range possible.	<ul style="list-style-type: none"> <li>Radio interference likely.</li> </ul>	<ul style="list-style-type: none"> <li>Change location (see point 3 - Tips &amp; Hints).</li> </ul>
Short battery life.	<ul style="list-style-type: none"> <li>Battery not fully charged.</li> </ul>	<ul style="list-style-type: none"> <li>Recharge TMH FlexPak battery pack. For maximum running time, make sure you give your battery pack a full 4 hour charge. About 25 minutes of life is typical with this type of radio control vehicle.</li> </ul>
Vehicle doesn't work after going through water or snow.	<ul style="list-style-type: none"> <li>Water in the electronics area.</li> </ul>	<ul style="list-style-type: none"> <li>Vehicle will take several hours to dry. Allow to dry overnight before trying again.</li> <li>Avoid driving in water and snow.</li> </ul>

## CONSUMER INFORMATION

**PRODUCT:** PSYCHO™ Radio Control Vehicle  
**WARRANTY:** 90-Day Limited Warranty. Details inside. Valid only in U.S.A.  
**AGE GRADE:** For ages 5 and over  
**ASSEMBLY REQUIRED:** No.  
**BATTERIES REQUIRED:** 1 9-Volt, 1 TMH™ FlexPak™ Rechargeable Battery Pack.  
**CONTENTS:** PSYCHO™ Radio Control Vehicle, Transmitter.

MATTY MATTEL™ 1015

**YOU CAN TELL IT'S MATTTEL!** CALL us toll-free or write with comments or questions about our toys or service: Monday - Friday 9:00 a.m. - 7:00 p.m. EST, 6:00 a.m. - 4:00 p.m. PST. Outside U.S.A., see telephone directory for Mattel listing Consumer Affairs Department 636 Girard Avenue East Aurora, NY 14052 USA

**1 (888) 557-TYCO**

**CE** CONFORMS TO THE SAFETY REQUIREMENTS OF ASTM F963.

**We are dedicated to quality products.**

© 1997 Mattel, Inc., Mt. Laurel, NJ 08054 U.S.A. PRINTED IN CHINA. All Rights Reserved. ® and ™ designate U.S. trademarks of Mattel, Inc.

Retain this address for future reference: Mattel U.K. Ltd., Meridian West Leicester LE3 2WT  
 Mattel Australia Pty Ltd., Port Melbourne, Victoria 3207 - Consumer Advisory Service.  
 1800 800 812 (valid only in Australia). Mattel East Asia Limited, 930 Ocean Centre, Harbour City, HK, China  
 In Britain 49 MHz is not available. 27 MHz can be raced against 40 MHz vehicles.

### COMPLIANCE WITH FCC REGULATIONS

THIS DEVICE COMPLIES WITH PART 15 FCC RULES. OPERATION OF THIS DEVICE IS SUBJECT TO THE FOLLOWING TWO CONDITIONS:

1. THIS DEVICE MAY NOT CAUSE HARMFUL INTERFERENCE.
2. THIS DEVICE MUST ACCEPT ANY HARMFUL INTERFERENCE THAT MAY CAUSE UNDESIRE OPERATION.

This device generates and uses radio frequency energy and if not used properly may cause interference to radio and television reception. It has been tested and found to comply with the limits set by the FCC which are designed to provide reasonable protection against such interference.

**CAUTION:** FCC Regulations state that changes or modifications to this product not expressly approved by the party responsible for compliance could void the user's authority to operate the equipment.