

Taiyo Edge™  
R/C



Photo will be changed

**CAUTION:** Unless  
any battery or electronic device is  
disposed of properly, it can  
be a health hazard.  
92875-0920

Freestyle BMX

**EVGO-R/C**  
**CONSUMER AFFAIRS**  
**WE CARE!**

If you have questions about this vehicle,  
**DO NOT RETURN IT TO THE STORE!**  
Call Toll Free 1-800-527-4200 (4-4200) for expert  
technical help and RARE parts and service assistance.  
[www.evgo.com](http://www.evgo.com)

Keep these instructions for future reference; they contain important information.

**GET STARTED:**

Your vehicle has an amazing Gyro Stabilizer that makes it easy to drive – and lets it perform amazing stunts! The stabilizer safely spins up to full speed, you'll be able to hear it – and if you twist the vehicle from side to side you'll really feel it working!

**1. GET SET!**

Energize the gyro stabilizer! Hold the vehicle off the ground and push the left control stick all the way forward. Once the stabilizer spins up to full speed, you'll be able to hear it – and if you twist the vehicle from side to side you'll really feel it working!

Be sure to hold the vehicle by the driver figure, keeping your fingers clear of the wheels.

**2. LAUNCH IT!**

Now gently hand-launch your vehicle. Set it on the ground and give it a gentle push while pushing the left stick forward. Now you're ready for the coolest stunt driving!



Photo will be changed

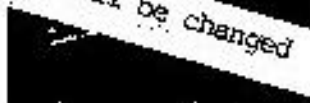
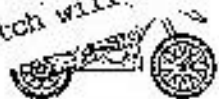

Photo will be changed

**1. CONTENTS:** The rider is removable

**VEHICLE**

Sketch will be changed



Freestyle BMX Vehicle

**TRANSMITTER**

NOTE: Your transmitter is equipped with a special automatic ON battery-saving feature. Just turn your vehicle ON. Then push either transmitter stick and you will be able to run and control your vehicle.

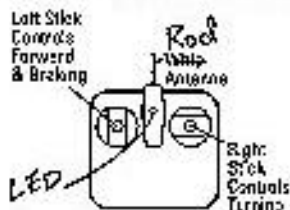

(1) Transmitter

**FEATURES:**

- Full function
- Available in 2 frequencies: 27 MHz and 49 MHz  
(refer to labels on transmitter & vehicle for frequency)
- Range up to 30' (9m)

TOP VIEW

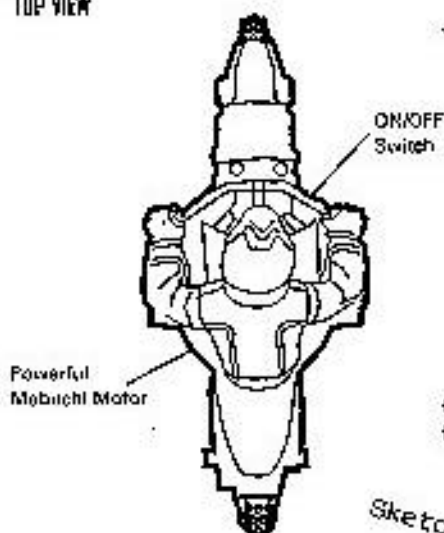

BOTTOM VIEW

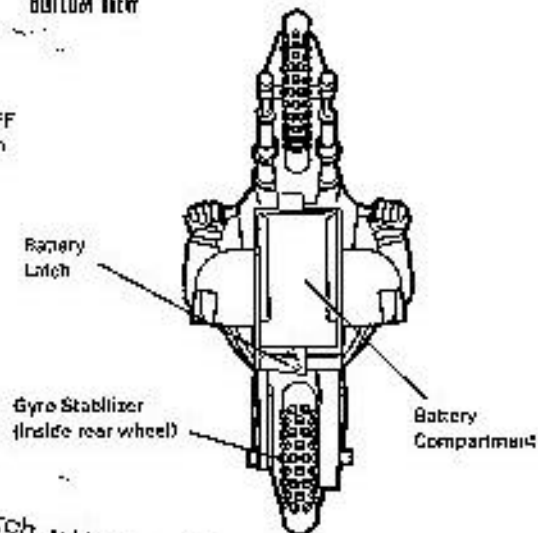

*Sketch will be changed*

Refer to label on transmitter and vehicle for frequency. Do not use vehicles with the same frequency.

**III. QUICK START:**

*⚠* Please read this Owner's Manual thoroughly.

1. Start with a fresh set of batteries.
2. Turn vehicle switch ON. Press transmitter controls to run and control your vehicle.
3. When you're done driving, turn vehicle switch OFF. Remove all batteries for storage.

**III. OPERATING YOUR VEHICLE**

**FORWARD**

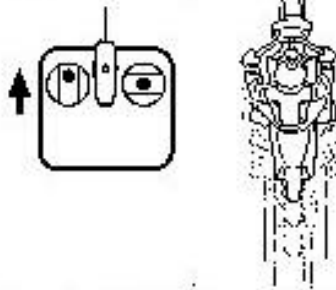

**BRACING**

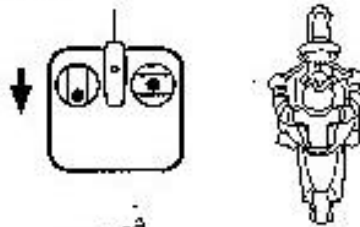

**LEFT TURN**

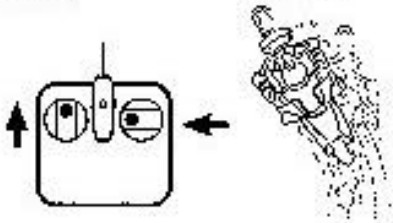

**RIGHT TURN**

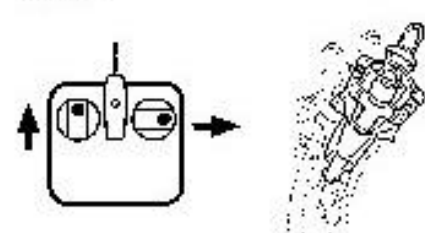

*Sketch will be changed*

**IV. QUICK TIPS**

- ❶ When your vehicle starts to lose power, it may lose functions or performance. It's time for fresh batteries. Your vehicle's running time may change depending on your driving style.
- ❷ Radio interference can make your vehicle run badly. Interference can be caused by other R/C vehi-

cles running on the same frequency; electrical wires; large buildings; or CB radios. Try to stay away from these!

- ❸ Point your transmitter antenna up - not down toward your vehicle. If your vehicle gets too far away, it won't work properly. Your maximum range should be about 50/9m.

- ❹ Don't drive your vehicle in sand or through water or snow. If your vehicle does get wet, wipe with a towel and allow to dry completely overnight.

- ❺ Don't store your vehicle near heat or in direct sunlight. Always turn switch OFF and remove all batteries for storage.



## V. DRIVING TIPS

1. You can also start with your vehicle resting on its side skid plate: push the left stick forward and steer with the right stick (into and then out of the turn). Your vehicle will get up and go! But remember: if you start this way, it'll take the sta-

bilizer a little while to come up to full speed. And you'll get different results on different driving surfaces.

2. Your vehicle will run really well on hard packed dirt, asphalt and other similar surfaces.

3. When you want to stop, it's best to turn into a skid while braking, instead of hitting the brakes suddenly while going straight.

## VI. COOL STUNTS!

### 1. DIRT-DIGGIN' DONUTS!

Push the left stick forward to drive straight. Now use the right stick to steer hard (either right or left) into a leaning turn. Now let go of the sticks; your vehicle will glide to a stop on its side skid plate. Quickly, while the Gyro Stabilizer is still spinning, push the left stick all the way forward, and use the right stick to steer "into" the donut. As your vehicle picks up speed, use the right stick to steer "out" of the donut and bring the vehicle upright.

 This stunt works best on pavement or hard packed dirt.

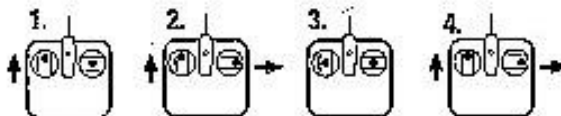

### 2. SIZZLIN' SOMERSAULTS!

For amazing somersault stunts, try driving your vehicle downhill, aiming at a small ramp or bump. When you drive over it, your vehicle may flip into a fearsome forward somersault!

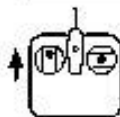

### 3. JAMMIN' JUMPS!

Push the left stick all the way forward to accelerate. Drive your vehicle off a ramp or curb and watch it catch some "big air." For the smoothest jumps, keep the stick pushed forward during the jump. Depending on speed and ramp angle, your vehicle may land on both wheels - or in a full wheelie!

 You can change the position of your vehicle in mid-air by using the left control stick. Push the stick forward to keep the nose up. Pull back to point the nose down.

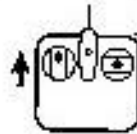

### 4. WILD WHEELIES!

Drive your vehicle into a jump. Pull the left stick back once you're airborne; your vehicle will tumble and flip in mid-air. Push the left stick all the way forward as soon as you land. Depending on speed and ramp angle, your vehicle may land on both wheels - or in a full wheelie! Either way, the Gyro Stabilizer will keep it going for more cool stunt action!

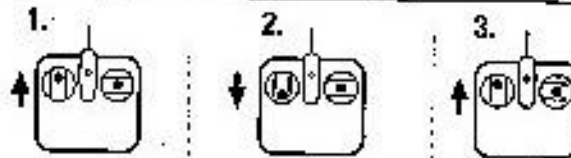

### 5. STOP & START!

Push the left stick all the way forward to accelerate. Now use the right stick to steer into a skid (either right or left), while reducing speed. When your vehicle's side skid just touches the pavement, quickly jam the left stick forward again and steer out of the turn. Your vehicle will right itself and keep driving to the next exciting stunt!

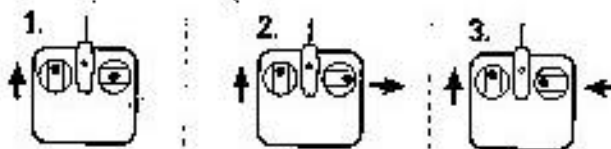

VII: BATTERY INSTALLATION: VEHICLE

- 1 Turn your vehicle over. Rotate the battery latch to release the battery holder.

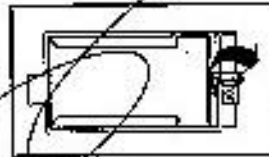

- 2 Slide the battery holder toward the latch.

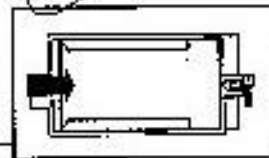

- 3 Lift the battery holder out of the vehicle.

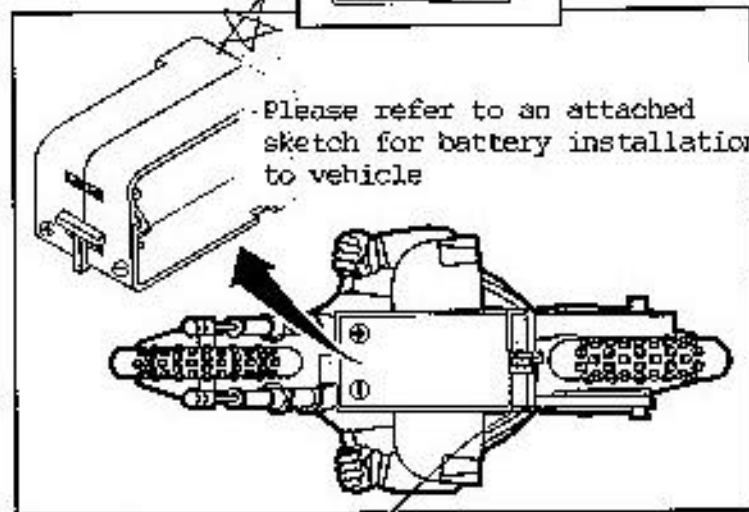

Please refer to an attached sketch for battery installation to vehicle

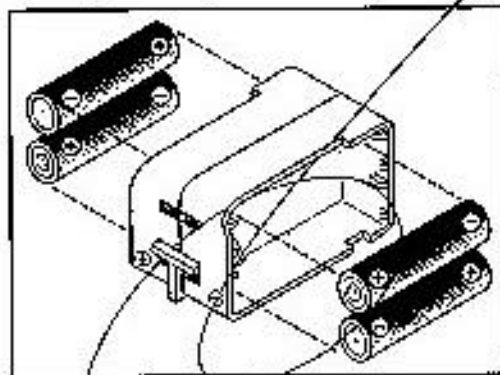

- 4 Insert 4 AA alkaline batteries into the battery holder, with polarity (+/-) as shown on the battery holder.

- 5 Replace the battery holder in the vehicle and rotate the latch until it clicks shut, locking the battery holder in place.

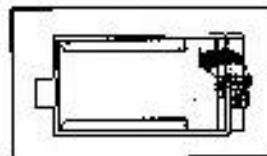

## BATTERY INSTALLATION: TRANSMITTER

1. Slide battery door open.
2. Install one 9-volt (6LR61) battery with polarity (+/-) as shown inside battery compartment.
3. Replace battery door.

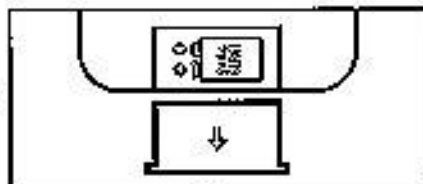

## VIII. SAFETY INFORMATION

### Note to Adults

- Adults, this toy is recommended for children 5 years of age and older. To ensure that the child's play is both safe and fun, please review the operating instructions and these general safety rules with your child.

### Safety Tips

- **DO NOT** pick up vehicle while in motion.
- Keep fingers, hair and loose clothing away from tires and wheels while the vehicle is switched ON.
- Adult supervision is recommended when this vehicle is being operated.

- To avoid accidental operation, remove all batteries when not in use.

**CAUTION:** Do not operate vehicle through water or snow. Electronic components can overheat or be damaged as a result of contact with water.

### IMPORTANT BATTERY INFORMATION

- ✓ Insure that battery polarity is correct.
- ✓ Use only batteries of the type recommended (or equivalent).
- ✓ Do not mix old and new batteries.
- ✓ Do not mix alkaline, standard (carbon-zinc), or

rechargeable (nickel-cadmium) batteries.

- ✓ Remove used-up batteries immediately. Remove batteries if vehicle will not be used for a long period.
- ✓ For best performance use alkaline batteries (where disposable batteries are called for). Battery life may vary depending on battery brand.
- ✓ Do not recharge non-rechargeable batteries.
- ✓ Do not short-circuit terminals.
- ✓ Remove rechargeable batteries before recharging. Recharge batteries only under adult supervision.
- ✓ Dispose of batteries safely.

## TROUBLESHOOTING: PROBLEM - SOLUTIONS

Symptom	Probable Cause	Correction
Vehicle runs slowly or will not run.	<ul style="list-style-type: none"> <li>• Loose battery connection or vehicle switch not ON.</li> <li>• Weak vehicle or transmitter batteries.</li> </ul>	<ul style="list-style-type: none"> <li>• Check battery connector and vehicle switch.</li> <li>• Replace with fresh alkaline batteries.</li> </ul>
Erratic operation or only short range possible.	<ul style="list-style-type: none"> <li>• Radio interference likely.</li> </ul>	<ul style="list-style-type: none"> <li>• Change location (see point 2 - Quick Tips).</li> </ul>
Vehicle doesn't work after going through water or snow.	<ul style="list-style-type: none"> <li>• Water in the electronics area.</li> </ul>	<ul style="list-style-type: none"> <li>• Vehicle will take several hours to dry. Allow to dry thoroughly overnight before trying again.</li> <li>• Operate your vehicle in a dry area. Avoid driving in water and snow.</li> </ul>

© 2000 Mattel, Inc., Mt. Laurel, NJ 08054 U.S.A. PRINTED IN CHINA. All Rights Reserved. ® and ™ designate U.S. trademarks of Mattel, Inc.

Retain this address for future reference: Mattel U.K., Ltd., Varwall Business Park, Maidenhead SL6 4UB Mattel Australia Pty. Ltd., Richmond, Victoria 3121 - Consumer Advisory Service: 1800 300 312 (valid only in Australia). Mattel East Asia Limited, 930 Ocean Centre, Harbour City, HK, China.

**COMPLIANCE WITH FCC REGULATIONS**

**THIS DEVICE COMPLIES WITH PART 15 OF FCC RULES. OPERATION OF THIS DEVICE IS SUBJECT TO THE FOLLOWING TWO CONDITIONS:**

(1) THIS DEVICE MAY NOT CAUSE HARMFUL INTERFERENCE.

(2) THIS DEVICE MUST ACCEPT ANY HARMFUL INTERFERENCE THAT MAY CAUSE UNDESIRABLE OPERATION.

This device generates and uses radio frequency energy and if not used properly may cause interference to radio and television reception. It has been tested and found to comply with the limits set by the FCC, which are designed to provide reasonable protection against such interference.



**CAUTION:** Changes or modifications not expressly approved by the manufacturer responsible for compliance could void the user's authority to operate the equipment.